



Erasmus

Fachgeschäft für Industriebedarf

SCHRAUBEN

Ausgabe 2019/20

Walzmühle 11 - 52349 Düren
Postfach 102352 - 52323 Düren
Telefon 02421/9433-0
Telefax 02421/9433-50
E-Mail info@alexander-erasmus.de
Internet www.alexander-erasmus.de

- Werkzeuge
- Maschinen
- Antriebstechnik
- Befestigungstechnik
- Betriebseinrichtungen
- **SKF** Vertragshändler

■ So funktioniert's

VE Verpackungseinheit: K = Kleinpackung S = Standardpackung

Stück Menge pro Verpackungseinheit

€/100 Preis in Euro pro 100 Stück
bei Abnahme voller Verpackungseinheiten

Abmessungen	VE	Stück	€/100/Obf.
1 ISO	2	04017.353	
3 4017	4	8.8 flZn/TL480h	



Sechskantschrauben mit Gewinde bis Kopf

5 TL = Schmierstoff im Topcoat mit $\mu = 0,09 - 0,14$, Korrosionsbeständigkeit NSS: 480h RR, Chrom(VI)-frei

6 **Achtung! Gegenüber galv. verzinkt geänderte Anziehdrehmomente.**

Maße → TI-15 Anziehdrehmomente → TI-245
 Werkstoffeigensch. → TI-232 Normumstellung → TI-6
 Korrosionsschutz → TI-230

8 Rostfrei → S. 534
 Messing → S. 636

9 ISO 4017 → ersetzt DIN 933

10 **RoHS** ✓ **REACH SVHC free**

- 1 Angabe DIN, ISO, EN oder Artikel
- 2 Gruppen-Codenummer
- 3 Norm/Artikel
- 4 Material, Festigkeitsklasse, Form, Oberflächenbeschichtung
- 5 Artikelbezeichnung und ergänzende Beschreibung
- 6 Warnhinweis
- 7 Verweise zu Technischen Informationen
- 8 Verweis auf verfügbare andere Werkstoffe
- 9 Hinweis auf Normumstellung
- 10 Hinweise und Zulassungen

Hinweise und Zulassungen

- RoHS** ✓ Produkt konform mit der RoHS-Richtlinie (Stand: Oktober 2019).
- REACH SVHC free** Produkt enthält keine SVHC nach der REACH-Verordnung (Stand: Oktober 2019).
- HF** Halogenfrei Produkt enthält kein Halogen.
- DGRL** Zulassung Produkt kann in Druckgeräten nach harmonisierten europäischen Normen eingesetzt werden.
- CE** **CE-Kennzeichen** - Produkt entspricht einer harmonisierten europäischen Norm.
- ETA** **CE** **CE-Kennzeichnung** - Produkt hat eine CE-Kennzeichnung auf Grundlage einer ETA.
- Bauaufsichtliche Zulassung** - Produkt hat eine bauaufsichtliche Zulassung.
- Übereinstimmungszertifikat** - Bauprodukt in Übereinstimmung mit Muster-Verwaltungsvorschrift Technische Baubestimmung.

Erläuterungen zu Material und Oberflächen

Material/Oberfläche	
11H - 45H	Härteklassen
4.6 - 12.9	Festigkeitsklassen Schrauben
5 - 12/04,05	Festigkeitsklassen Muttern
A1-A5	nichtrostende Stähle
Al./Al.-Leg.	Aluminium-/Legierung
brün	brüniert, phosphatiert
Cu	Kupfer
CuNiSi	Kupfer-Leg.
CuSn 8	Bronze
DiSP	Dickschichtpassivierung
flZn(nc)	Zinklamellenbeschichtung (Chrom(VI)-frei)
Fst	Federstahl
gal Cr	galvanisch verchromt
gal Cu	galvanisch verkupfert
gal CuZn	galvanisch vermessingt
gal Ni	galvanisch vernickelt
gal Zn	galvanisch verzinkt
gal ZnNi	galvanisch Zink-Nickel
GTN	Temperguss
meh Zn	mechanisch verzinkt
Ms	Messing
QT	vergütet
St	Stahl
tZn	feuerverzinkt

Zulassungen im Bereich Befestigungstechnik

- FM** Zulassung **Factory Mutual** - Der amerikanische Schadenversicherer FM Global erteilt Zulassungen, die weltweit im Bereich der Sprinkleranlagen anerkannt werden.
- VdS** Zulassung **Verband der Schadenversicherer** - VdS Schadenverhütung, Köln, testet nach strengen Richtlinien und zertifiziert Produkte für die Sprinklerindustrie.
- BZS** Schockzulassung **Schockzulassung** - für schocksichere Befestigung in Zivilschutzräumen.
- Z** Zugzonentauglich **Zugzonentauglich** - Dübel ist für den Einsatz in gerissenem (Zugzone) und ungerissenem (Druckzone) Beton.



TÜV Nord - Der TÜV ist Zertifizierungsstelle für technische Arbeitsmittel.



Lloyd's Register Type Approval - Die von Lloyd's Register abgenommenen Produkte wurden auf Zug, Schub, Abscheren, Vibration und Schockbelastungen geprüft und zugelassen.



Dynamisch beanspruchter Dübel - Dübel ist geeignet und zugelassen für die Verankerung von „nicht vorwiegend ruhenden“ (d. h. dynamischen) Lasten.

Produkt erfüllt die entsprechenden Brandschutzanforderungen

F90 Feuerwiderstandsklasse	R90 Feuerwiderstandsklasse	F120 Feuerwiderstandsklasse	R120 Feuerwiderstandsklasse	Brandschutz UL94 HB	Brandschutz UL94 V2
--------------------------------------	--------------------------------------	---------------------------------------	---------------------------------------	-------------------------------	-------------------------------

Übersicht

Kataloggruppen

- Der Katalog ist in Teil 1, 2 und 3 nach aufsteigenden DIN-, ISO- und EN-Normnummern geordnet und daran anschließend nach Artikelnummern.
- Befestigungstechnik in Teil 4 ist nach Sachgruppen gegliedert.

TEIL 1 – GRÜNE SEITEN

SEITE 63-452



Verbindungselemente aus Stahl mit und ohne Oberfläche nach DIN, ISO und EN – nicht genormte

- Stahl galvanisch verzinkt, feuerverzinkt
- Stahl mechanisch verzinkt
- Stahl zinklamellenbeschichtet
- Stahl vernickelt, verchromt
- Stahl vermessingt, brüniert
- SPAX-Schrauben
- Sortimente und Montagekoffer

TEIL 2 – BLAUE SEITEN

SEITE 453-610



Verbindungselemente aus nichtrostenden Stählen nach DIN, ISO und EN – nicht genormte

- Schrauben/Gewindestücke
- Muttern
- Scheiben
- Zubehör

TEIL 3 – GELBE SEITEN

SEITE 611-648



Verbindungselemente aus Nichteisenwerkstoffen nach DIN, ISO und EN – nicht genormte

- Messing, Messing mit Oberfläche
- Kupfer, Bronze
- Aluminium, Aluminium mit Oberfläche
- Titan
- Kunststoff

TEIL 4 – ORANGE SEITEN

SEITE 649-702



- Kabelbinder und Zubehör
- LINDAPTER-Verbindungs- und Klemmsystem
- Dübel und Anker
- Kurvenstücke und Passscheiben für Schrägzuganker
- MULTI-MONTI-Mauerschrauben/-Schraubanker
- Schraub-Technik – Bits, Steckschlüssel
- Blindniet-Technik

TECHNISCHE INFORMATIONEN TI – ROTE SEITEN

SEITE 1-263



- Normenumstellung
- Produktinformationen
- Maße für Verbindungselemente
- Träger-Verbindungs- und Klemm-Systeme
- Dübel und Anker
- Gewinde
- Blindniet-Technik
- Mechanische Eigenschaften
- Toleranzen
- Prüfung und Annahme
- Korrosionsschutz
- Sichern von Schraubverbindungen
- Montage von Schraubenverbindungen
- Richtlinien und Gesetze

Inhalte

auf einen Blick

INHALTSVERZEICHNISSE

Bildregister Verbindungselemente

■ DIN/ISO/EN genormte Artikel	5-30
■ Nicht genormte Schrauben	31-36
■ Nicht genormte Muttern und Gewindeeinsätze	36-38
■ Nicht genormte Zubehörteile	38-40

Bildregister Befestigungstechnik

■ Kabelbinder	40-41
■ LINDAPTER	41-43
■ FISCHER	43-47
■ UPAT	47
■ Sonstige Befestigungselemente	48
■ Schraub-Technik	48
■ Blindniet-Technik	48-51

A-Z	52-57
-----	-------

Artikelnummern	58-62
----------------	-------

TEIL 1 – GRÜNE SEITEN	63-452
-----------------------	--------

Verbindungselemente mit und ohne Oberfläche

TEIL 2 – BLAUE SEITEN	453-610
-----------------------	---------

Verbindungselemente aus nichtrostenden Stählen

TEIL 3 – GELBE SEITEN	611-648
-----------------------	---------

Verbindungselemente aus Nichteisenwerkstoffen

TEIL 4 – ORANGE SEITEN	649-702
------------------------	---------

Befestigungstechnik

TI – ROTE SEITEN

TI Technische Informationen	TI 1-263
-----------------------------	----------

DIN/ISO/EN

Genormte Artikel/
Standardized Products

DIN 1
(ISO 2339**)

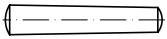

Kegelstifte
Taper pins

DIN 7
(ISO 2338**)

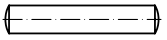

Zylinderstifte
Parallel pins

DIN 84
(ISO 1207**)

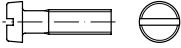

Zylinderschrauben mit Schlitz
Slotted cheese head screws

DIN 85
(ISO 1580**)

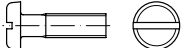

Flachkopfschrauben mit Schlitz
Slotted pan head screws

~DIN 93



Scheiben mit Lappen (Sicherungsbleche)
Tap washers with a long tap

DIN 94
(ISO 1234*)



Splinte
Split pins

DIN 94



Artikel 82094
Splinte-Sortimente/-Montagekoffer
Split pins assortment

DIN 95

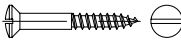

Linsensenkholzschrauben mit Schlitz
Slotted raised countersunk head wood screws

DIN 96

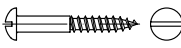

Halbrundholzschrauben mit Schlitz
Slotted round head wood screws

DIN 97

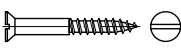

Senkholzschrauben mit Schlitz
Slotted countersunk head wood screws



SPAX- und Spanplattenschrauben
SPAX and chipboard screws

DIN 98



Ballengriffe, drehbar
Rotatable ball handles

DIN 99

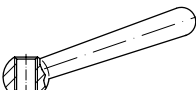

Kegelgriffe
Tapered handles

DIN 125
(ISO 7089**)
(ISO 7090**)



Flache Scheiben, Produktklasse A
Plain washers, product grade A

DIN 125
125/127



Artikel 82125/Artikel 82127
Scheiben-Sortimente/-Montagekoffer
Scheiben-/Federring-Sortimente
Washers assortment
Washers/spring lock washers assortment

DIN 126
(ISO 7091*)



Flache Scheiben, Produktklasse C
Plain washers, product grade C

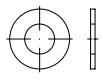

Artikel 88100
Flache Scheiben („Artikel 1“)
Plain washers ("type 1")

~DIN 127



Federringe
Spring lock washers

Stahl/ Stahl mit Überzug	Nicht- rostende Stähle	Ms Cu Al Ti Kunststoff	Befesti- gungs- technik	Maße TI
63	453			117
64	453			116
65	455	611		37
67	457	612		37
68	458			88
69	459	613		122
69				
70	459	613		50
70	460	615		51
70	460	615		51
447	607			52
70				
70	460			125
70	461	616		84
71 74				
72 427				84
427				84
73	462	617		88

* DIN/ISO identisch = austauschbar





** DIN/ISO/EN weitgehend austauschbar

*** DIN/ISO-Umstellung → Rote Seiten „Technische Informationen“

Stahl/ Stahl mit Überzug	Nicht- rostende Stähle	Ms Cu Al Ti Kunststoff	Befesti- gungs- technik	Maße TI
--------------------------------	------------------------------	------------------------------	-------------------------------	------------

DIN/ISO/EN









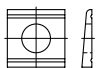
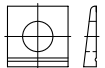
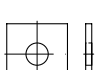

Genormte Artikel/
Standardized Products

DIN/ISO/EN	Genormte Artikel/ Standardized Products	Stahl/ Stahl mit Überzug	Nicht- rostende Stähle	Ms Cu Al Ti Kunststoff	Befesti- gungs- technik	Maße TI
	Artikel 88123-88129 TECKENTRUP-Sperrkantscheiben für Sechskant- schrauben und Zylinderschrauben mit Innensechskant TECKENTRUP lock washers for hexagon head screws and hexagon socket head cap screws	430	599			105
	Artikel 88130/88131 Sperrkantringe Lock rings	431	600			107
	Artikel 88119 LOCKTIX-Scheiben LOCKTIX washers	432				104
~DIN 128	Federringe (Hochspann-Federringe) Spring lock washers	75	463			89
~DIN 137	Federscheiben Spring washers	76	463			89
DIN 186	Hammerschrauben mit Vierkant T-head bolts with square neck	77				29
DIN 258	Kegelstifte mit Gewindezapfen Taper pins with external thread	77				117
DIN 261	Hammerschrauben T-head bolts	77				29
DIN 315	Flügelmuttern, kantige/runde Flügelform Wing nuts, rounded or edged wings	77	464	617		72
	Artikel 88215 Flügelmuttern, kleine "amerikanische" Ausführung Wing nuts, small "American" type	78	464			79
DIN 316	Flügelschrauben, runde/kantige Flügelform Wing screws, rounded or edged wings	78	464	618		29
DIN 319	Kugelknöpfe Ball knobs			618		125
DIN 404	Kreuzlochschrauben mit Schlitz Slotted capstan screws	78	465			29
DIN 417 (ISO 7435*)	Gewindestifte mit Schlitz und Zapfen Slotted grub screws with full dog point	79				19
DIN 427 (ISO 2342*)	Schaftschrauben mit Schlitz und Kegelkuppe Slotted headless screws with chamfered end	79	465			19
DIN 431	Rohrmuttern Pipe nuts	80	465	618		60

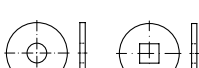
* DIN/ISO identisch = austauschbar	** DIN/ISO/EN weitgehend austauschbar	*** DIN/ISO-Umstellung → Rote Seiten „Technische Informationen“	Stahl/ Stahl mit Überzug	Nicht- rostende Stähle	Ms Cu Al Ti Kunststoff	Befesti- gungs- technik	Maße TI
------------------------------------	---------------------------------------	---	--------------------------------	------------------------------	------------------------------	-------------------------------	------------

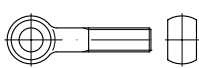
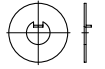
DIN/ISO/EN

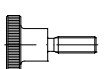
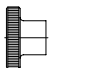
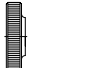
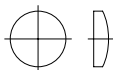
Genormte Artikel/
Standardized Products

DIN/ISO/EN		Genormte Artikel/ Standardized Products	Stahl/ Stahl mit Überzug	Nicht- rostende Stähle	Ms Cu Al Ti Kunststoff	Befesti- gungs- technik	Maße TI
~DIN 432		Scheiben mit Außennase Washers with external tap	80	465			90
DIN 433 (ISO 7092**)		Flache Scheiben für Zylinderschrauben Washers for cheese head screws	80	466	618		84
DIN 434		Scheiben, vierkant, für U-Träger (8 % Neigung) Square taper washers for U beams (taper 8%)	81	466			86
DIN 435		Scheiben, vierkant, für Doppel-T-Träger (14 % Neigung) Square taper washers for double-T beams (taper 14%)	81	466			86
DIN 436		Scheiben, vierkant Square washers	82	467			86
DIN 439 (ISO 4035/ 8675***)		Sechskantmuttern, niedrig Hexagon thin nuts	82	467	619		61
DIN 440 (ISO 7094**)		Scheiben für Holzkonstruktionen Washers for wood constructions	84	467			84
DIN 443		Verschlussdeckel Sealing push-in caps	85				112
DIN 444		Augenschrauben Eye bolts	85	468	619		30
DIN 462		Scheiben mit Innennase Internal tab washers	87				90
~DIN 463		Scheiben mit 2 Lappen Washers with 2 taps	87	469	619		91
DIN 464		Rändelschrauben Knurled thumb screws	87	469	619		30
DIN 466		Rändelmuttern, hohe Form Knurled nuts, high type	88	469	620		72
DIN 467		Rändelmuttern, niedrige Form Knurled nuts, low type	88	469	620		72
DIN 470		Verschlusscheiben Sealing discs	89				112
DIN 471		Sicherungsringe für Wellen, Regelausführung/schwere Ausführung Retaining rings for shafts, normal/heavy type	89	469			91

* DIN/ISO identisch = austauschbar	** DIN/ISO/EN weitgehend austauschbar	*** DIN/ISO-Umstellung → Rote Seiten „Technische Informationen“	Stahl/ Stahl mit Überzug	Nicht- rostende Stähle	Ms Cu Al Ti Kunststoff	Befesti- gungs- technik	Maße TI
------------------------------------	---------------------------------------	---	--------------------------------	------------------------------	------------------------------	-------------------------------	------------

DIN/ISO/EN

Genormte Artikel/
Standardized Products







DIN 471		Artikel 82471 Sicherungsring-Sortimente/-Montagekoffer Assortment of retaining rings for shafts
DIN 472		Sicherungsringe für Bohrungen Retaining rings for bores
DIN 478		Vierkantschrauben mit Bund Square head bolts with collar
DIN 479		Vierkantschrauben mit Kernansatz Square head bolts with dog point
DIN 480		Vierkantschrauben mit Bund und Ansatzkuppe Square head bolts with collar, short dog point and rounded end
DIN 508		T-Nutensteine T-slot nuts
DIN 525		Anschweißenden Studs for welding
DIN 529		Steinschrauben Masonry bolts (anchor bolts)
DIN 546		Schlitzmuttern Slotted round nuts
DIN 551 (ISO 4766*)		Gewindestifte mit Schlitz und Kegelkuppe Slotted grub screws with flat point
DIN 553 (ISO 7434*)		Gewindestifte mit Schlitz und Spitze Slotted grub screws with cone point
DIN 555 (ISO 4034***)		Sechskantmuttern Hexagon nuts
~DIN 555		Sechskantmuttern mit BSW-Gewinde Hexagon nuts with BSW thread
DIN 557		Vierkantmuttern Square nuts
DIN 561		Sechskantschrauben mit Zapfen Hexagon head set screws with dog point
DIN 562		Vierkantmuttern, niedrige Form Square thin nuts
DIN 564		Sechskantschrauben mit Ansatzspitze Hexagon head set screws with short dog point and flat cone end
DIN 571		Sechskant-Holzschrauben Hexagon head wood screws

Stahl/ Stahl mit Überzug	Nicht- rostende Stähle	Ms Cu Al Ti Kunststoff	Befesti- gungs- technik	Maße TI
90				
90	470			95
91				30
91				30
92				31
92				70
92				31
92				31
92	470	620		72
93	470	620		19
94	471	621		19
		621		62 (~ISO 4032)
94				
95	471			83
95				16
97	471			83
97				16
98	471			51

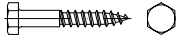
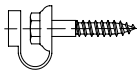
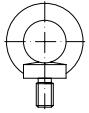
* DIN/ISO identisch = austauschbar	** DIN/ISO/EN weitgehend austauschbar	*** DIN/ISO-Umstellung → Rote Seiten „Technische Informationen“	Stahl/ Stahl mit Überzug	Nicht- rostende Stähle	Ms Cu Al Ti Kunststoff	Befesti- gungs- technik	Maße TI
------------------------------------	---------------------------------------	---	--------------------------------	------------------------------	------------------------------	-------------------------------	------------

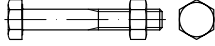
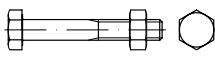
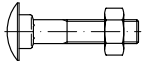
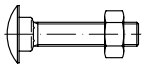
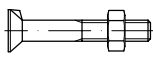
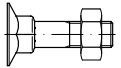
DIN/ISO/EN

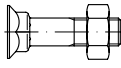
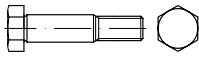
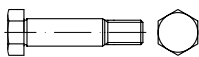
Genormte Artikel/
Standardized Products

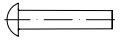
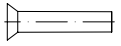
DIN/ISO/EN	Genormte Artikel/ Standardized Products	Stahl/ Stahl mit Überzug	Nicht- rostende Stähle	Ms Cu Al Ti Kunststoff	Befesti- gungs- technik	Maße TI
	 <p>Artikel 89571 Sechskantholzschrauben mit CE nach EN 14592 Hexagon wood screws with CE</p>	450				51
	 <p>Artikel 88005 Kunststoff-Regenhütchen für Sechskant-Holzschrauben für Wellplatten Plastic sealings/caps for hexagon head, wood screws for corrugated roof panels</p>			645		51
DIN 580	 <p>Ringschrauben Lifting eye bolts</p>	99	472			32, 142
DIN 582	 <p>Ringmutter Lifting eye nuts</p>	99	473			77, 143
DIN 601 (ISO 4016***)	 <p>Sechskantschrauben Hexagon head bolts</p>	100				15
	 <p>Baubolzen mit Sechskantmutter mit CE nach EN 14592 Bolts with hexagon nuts with CE</p>	450				15
DIN 603	 <p>Flachrundschrauben mit Vierkantansatz Cup head square neck bolts</p>	103	473	621		32
DIN 603	 <p>Flachrundschrauben mit Vierkantansatz, Gewinde bis Vierkant Cup head square neck bolts, thread up to square neck</p>	105				32
DIN 604	 <p>Senkschrauben mit Nase Flat countersunk nib bolts</p>	106				32
DIN 605	 <p>Senkschrauben mit hohem Vierkantansatz Flat countersunk square neck bolts with long square</p>	106				33
DIN 607	 <p>Halbrundschrauben mit Nase Cup head nib bolts</p>	106				33
DIN 608	 <p>Senkschrauben mit niedrigem Vierkantansatz Flat countersunk square neck bolts with short square</p>	106				33
DIN 609	 <p>Sechskant-Passschrauben mit langem Gewindezapfen Hexagon fit bolts with long thread</p>	107				16
~DIN 610	 <p>Sechskant-Passschrauben mit kurzem Gewindezapfen Hexagon fit bolts with short thread</p>	108				17
DIN 653	 <p>Rändelschrauben, niedrige Form Knurled thumb screws, low type</p>	108	474			33
DIN 660 (ISO 1051*)	 <p>Halbrundniete Round head rivets</p>	109	474	621		134
DIN 661 (ISO 1051*)	 <p>Senkniete Countersunk head rivets</p>	109	475	622		134

* DIN/ISO identisch = austauschbar	** DIN/ISO/EN weitgehend austauschbar	*** DIN/ISO-Umstellung → Rote Seiten „Technische Informationen“	Stahl/ Stahl mit Überzug	Nicht- rostende Stähle	Ms Cu Al Ti Kunststoff	Befesti- gungs- technik	Maße TI
------------------------------------	---------------------------------------	---	--------------------------------	------------------------------	------------------------------	-------------------------------	------------

DIN/ISO/EN

Genormte Artikel/
Standardized Products

DIN 662
(ISO 1051*) 

Linsenniete (Blechniete)
Mushroom head rivets (sheet metal rivets)

DIN 674
(ISO 1051*) 

Flachrundniete
Flat round head rivets

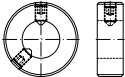
~DIN 703 

Stellringe, schwere Reihe
Adjusting rings, heavy range

DIN 705 

Stellringe, leichte Reihe
Adjusting rings, light range

~DIN 741 

Drahtseilklemmen mit U-förmigem Klemmbügel
U-bolt wire rope grips

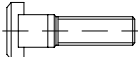
DIN 787 

T-Nutenschrauben
T-slot screws

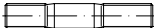
DIN 835 

Stiftschrauben, Einschraubende $\approx 2 d$
Studs, metal end $\approx 2 d$

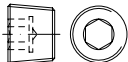
DIN 906 

Verschlusschrauben mit Innensechskant,
kegeliges Gewinde
Hexagon socket pipe plugs with taper thread

DIN 908 

Verschlusschrauben mit Bund und
Innensechskant, zylindrisches Gewinde
Hexagon socket screw plugs with cylindrical thread

DIN 909 

Verschlusschrauben mit Außensechskant,
kegeliges Gewinde
Hexagon head pipe plugs with taper thread

DIN 910 

Verschlusschrauben mit Bund und
Außensechskant, zylindrisches Gewinde
Hexagon head screw plugs with cylindrical thread

DIN 911
(→ ISO 2936) 

Winkelschraubendreher (Stiftschlüssel)
für Innensechskant-Antrieb
Hexagon socket screw keys (socket wrenches)

DIN 912
(ISO 4762*) 

Zylinderschrauben mit Innensechskant
Hexagon socket head cap screws

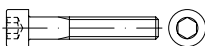

Artikel 83912/ASME B18.3
Zylinderschrauben mit UNC-Gewinde,
mit Innensechskant
Hexagon socket head cap screws with UNC thread

~DIN 912
(ISO 12474*) 

Zylinderschrauben mit Innensechskant
mit Gewinde bis Kopf, mit Feingewinde
Hexagon socket head cap screws
with thread up to head, with fine pitch thread

~DIN 912 ISR
(ISO 14579) 

Zylinderschrauben mit Innensechsrund
Hexalobular socket head cap screws

Stahl/ Stahl mit Überzug	Nicht- rostende Stähle	Ms Cu Al Ti Kunststoff	Befesti- gungs- technik	Maße TI
110		623		134
110				135
110				111
110	475			111
111	475			133
111				34
112	476			18
112	476	624		22
113	476	624		22
113				23
114	476	624		23
233				
115	477			12
415				13
115	477			12
121				12

* DIN/ISO identisch = austauschbar









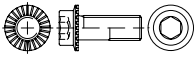

** DIN/ISO/EN weitgehend austauschbar

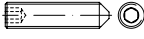
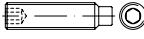
*** DIN/ISO-Umstellung → Rote Seiten „Technische Informationen“

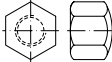
Stahl/ Stahl mit Überzug	Nicht- rostende Stähle	Ms Cu Al Ti Kunststoff	Befesti- gungs- technik	Maße TI
--------------------------------	------------------------------	------------------------------	-------------------------------	------------

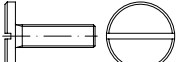
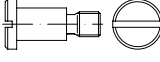
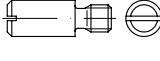
DIN/ISO/EN

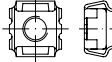

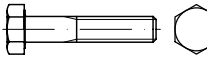
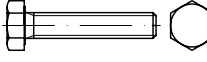
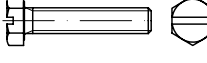
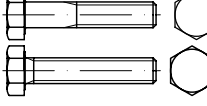





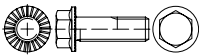
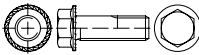

Genormte Artikel/
Standardized Products

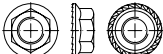
DIN/ISO/EN	Genormte Artikel/ Standardized Products	Stahl/ Stahl mit Überzug	Nicht- rostende Stähle	Ms Cu Al Ti Kunststoff	Befesti- gungs- technik	Maße TI
	 <p>Artikel 88912 RIPP-Schrauben mit Innensechskant Hexagon socket cap screws with flange, lock ribs under the flange</p>	438				28
DIN 913 (ISO 4026*)	 <p>Gewindestifte m. Innensechskant u. Kegelkuppe Hexagon socket set screws with flat point</p>	134	481			20
DIN 914 (ISO 4027*)	 <p>Gewindestifte mit Innensechskant und Spitze Hexagon socket set screws with cone point</p>	137	482			20
DIN 915 (ISO 4028*)	 <p>Gewindestifte mit Innensechskant und Zapfen Hexagon socket set screws with full dog point</p>	138	483			20
DIN 916 (ISO 4029*)	 <p>Gewindestifte m. Innensechskant u. Ringschneide Hexagon socket set screws with cup point</p>	139	484			21
DIN 917	 <p>Sechskant-Hutmuttern, niedrige Form Hexagon cap nuts, low type</p>	141	485	624		62
DIN 920	 <p>Flachkopfschrauben mit Schlitz, kleiner Kopf Slotted small cheese head screws</p>	141				37
DIN 921	 <p>Flachkopfschrauben mit Schlitz, großer Kopf Slotted large cheese head screws</p>	142	485			38
DIN 923	 <p>Flachkopfschrauben mit Schlitz und Ansatz Slotted cheese head shoulder screws</p>	142	485			38
DIN 927	 <p>Zapfenschrauben mit Schlitz Slotted shoulder screws</p>	143				38
DIN 928	 <p>Vierkant-Anschweißmuttern Square weld nuts</p>	143				71
	 <p>Artikel 88109 Käfigmuttern Square caged nuts</p>	428				78
DIN 929	 <p>Sechskant-Anschweißmuttern Hexagon weld nuts</p>	143	486			71
DIN 931 (ISO 4014***)	 <p>Sechskantschrauben mit Schaft Hexagon head bolts</p>	143	486	625		15
DIN 933 (ISO 4017***)	 <p>Sechskantschrauben mit Gewinde bis Kopf Hexagon head screws</p>	156	490	625		15
DIN 933	 <p>Sechskantschrauben mit Schlitz Slotted hexagon head screws</p>	164				15
	 <p>Artikel 83931, 83933/ASME B18.2.1 Sechskantschrauben mit Schaft/Vollgewinde, mit UNC-/UNF-Gewinde Hex cap screws with shank/full thread,with UNC/UNF thread</p>	410				16

* DIN/ISO identisch = austauschbar	** DIN/ISO/EN weitgehend austauschbar	*** DIN/ISO-Umstellung → Rote Seiten „Technische Informationen“	Stahl/ Stahl mit Überzug	Nicht- rostende Stähle	Ms Cu Al Ti Kunststoff	Befesti- gungs- technik	Maße TI
------------------------------------	---------------------------------------	---	--------------------------------	------------------------------	------------------------------	-------------------------------	------------

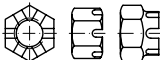
DIN/ISO/EN

Genormte Artikel/
Standardized Products

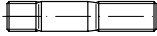
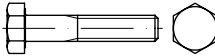
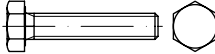
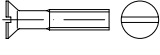
DIN/ISO/EN	Genormte Artikel/ Standardized Products	Stahl/ Stahl mit Überzug	Nicht- rostende Stähle	Ms Cu Al Ti Kunststoff	Befesti- gungs- technik	Maße TI
	 <p>Artikel 88913 RIPP-Schrauben Hexagon head screws with flange and lock ribs</p>	438				28
	 <p>Artikel 88933 Sperrzahn-Schrauben Hexagon head locking screws with flange</p>	441				28
	 <p>Artikel 88914 RIPP-Muttern Hexagon nuts with flange and lock ribs</p>	440				70
	 <p>Artikel 88934 Sperrzahn-Muttern, oberflächengehärtet Hexagon locking nuts</p>	442				70
DIN 934 (ISO 4032/4033*** 8673/8674***)	 <p>Sechskantmuttern Hexagon nuts</p>	168	495	626		62
~DIN 934	 <p>Sechskantmuttern mit BSW-Gewinde Hexagon nuts with BSW thread</p>	169				
	 <p>Artikel 83934/ASME B18.2.2 Sechskantmuttern mit UNC-/UNF-Gewinde Hex nuts with UNC/UNF thread</p>	414	592			61
DIN 934	 <p>Artikel 82934, 82935 Mutter-Sortimente/-Montagekoffer Hexagon nut assortment</p>	170 170				
DIN 935	 <p>Kronenmuttern Hexagon slotted and castle nuts</p>	173	497			67
DIN 936 (ISO 4035/ 8675***)	 <p>Flache Sechskantmuttern Hexagon thin nuts</p>	174	497	627		63
	 <p>Artikel 83936/ASME B18.2.2 Niedrige Sechskantmuttern mit UNC-/UNF- Gewinde Hex jam nuts with UNC/UNF thread</p>	415				61
DIN 937 (→ DIN 979)	 <p>Kronenmuttern, niedrige Form Hexagon thin slotted and castle nuts</p>	176				67
DIN 938	 <p>Stiftschrauben, Einschraubende ≈ 1 d Studs, metal end ≈ 1 d</p>	177 177	498			18
DIN 939	 <p>Stiftschrauben, Einschraubende ≈ 1,25 d Studs, metal end ≈ 1,25 d</p>	179 179	499			18
DIN 960 (ISO 8765***)	 <p>Sechskantschrauben mit Schaft, mit metr. Feingewinde Hexagon head bolts with shank, with metric fine pitch thread</p>	182				15
DIN 961 (ISO 8676***)	 <p>Sechskantschrauben mit Gewinde bis Kopf, mit metrischem Feingewinde Hexagon head screws with metric fine pitch thread</p>	184				15
DIN 963 (ISO 2009**)	 <p>Senkschrauben mit Schlitz Slotted countersunk head screws</p>	187	500	627		27

* DIN/ISO identisch = austauschbar	** DIN/ISO/EN weitgehend austauschbar	*** DIN/ISO-Umstellung → Rote Seiten „Technische Informationen“	Stahl/ Stahl mit Überzug	Nicht- rostende Stähle	Ms Cu Al Ti Kunststoff	Befesti- gungs- technik	Maße TI
------------------------------------	---------------------------------------	---	--------------------------------	------------------------------	------------------------------	-------------------------------	------------

DIN/ISO/EN

Genormte Artikel/
Standardized Products

DIN 964
(ISO 2010**)



Linsensenkschrauben mit Schlitz
Slotted raised countersunk head screws

DIN 965
(ISO 7046**)

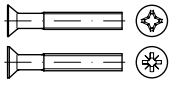

Senkschrauben mit Kreuzschlitz
Countersunk head screws with cross recess

~DIN 965
„ISR“



Senkschrauben mit Innensechsrund
Countersunk head screws with hexalobular socket

DIN 966
(ISO 7047**)

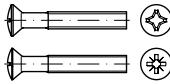

Linsensenkschrauben mit Kreuzschlitz
Raised countersunk head screws with cross recess

~DIN 975
DIN 976-1

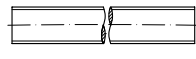

Gewindestangen
Threaded rods

1000 mm
2000 mm

~DIN 975

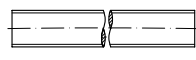

Gewindestangen mit BSW-Gewinde
Threaded rods, BSW thread

~DIN 975



Gewindestangen mit Trapezgewinde
Threaded rods with trapezoidal thread

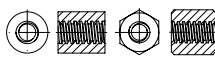

Artikel 88089, 88090
Muttern mit Trapezgewinde, rund/6-kant
Nuts with trapezoidal thread, round, hexagon

DIN 976-1

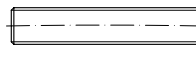

Gewindebolzen
Stud bolts

DIN 979

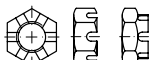

Niedrige Kronenmuttern
Hexagon thin slotted and castle nuts

DIN 980
(DIN 6925***)
(ISO 7042/
7719/10513)

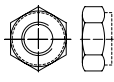

Sechskantmuttern mit Klemmteil,
Ganzmetallmutter
Prevailing torque type hexagon nuts, all-metal

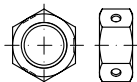

Artikel 84032
BILOC-Muttern/Sechskantmuttern mit Klemmteil
BILOC nuts/prevailing torque type hexagon nuts

~DIN 980



Artikel 88105
THERMAG-Muttern, Ganzmetallmuttern mit
Klemmteil
THERMAG nuts, prevailing torque type hexagon nuts

DIN 981

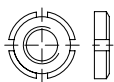

Nutmuttern
Locknuts for rolling bearings

DIN 982
(DIN 6924***)
(ISO 7040/
10512***)

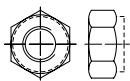

Sechskantmuttern mit Klemmteil, hohe Form,
mit nichtmetallischem Einsatz (Kunststoffring)
Prevailing torque type hexagon nuts
with non-metallic insert (plastic), high type

DIN 983



Sicherungsringe mit Lappen, (Haltringe für
Wellen)
Retaining rings with lugs for shafts, (retainer rings)

Stahl/ Stahl mit Überzug	Nicht- rostende Stähle	Ms Cu Al Ti Kunststoff	Befesti- gungs- technik	Maße TI
189	502	628		39
190	503			39
191	505			39
192	506			39
192 193	507 507	630		
194				
197	508			
417	592			77
197	508			
198				68
198	510			9
200	510			62
199				70
200				73
200	511			9
201				98

* DIN/ISO identisch = austauschbar	** DIN/ISO/EN weitgehend austauschbar	*** DIN/ISO-Umstellung → Rote Seiten „Technische Informationen“	Stahl/ Stahl mit Überzug	Nicht- rostende Stähle	Ms Cu Al Ti Kunststoff	Befesti- gungs- technik	Maße TI
------------------------------------	---------------------------------------	---	--------------------------------	------------------------------	------------------------------	-------------------------------	------------

DIN/ISO/EN

Genormte Artikel/
Standardized Products

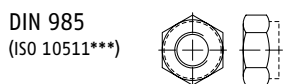

Sechskantmuttern mit Klemmteil, niedrige Form, mit nichtmetallischem Einsatz (Kunststoffring)
Prevailing torque type hexagon nuts with non-metallic insert (plastic), low type

Stahl/ Stahl mit Überzug	Nicht- rostende Stähle	Ms Cu Al Ti Kunststoff	Befesti- gungs- technik	Maße TI
201	512	630		9
201				
203	512			68
203	513			
204	513			
205	513			85
205	513	630		37
208	516	632		122
208	516			85
209				85
210				122
210	517			118
211	517			119
211	517			119
212				119
212				118
213	518	632		120
213				120

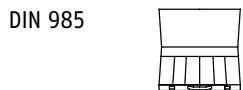

Artikel 82985
Klemmteilmutter-Sortimente/-Montagekoffer
Assortment of prevailing torque type hexagon nuts



Sechskant-Hutmuttern mit Klemmteil
Prevailing torque type hexagon domed cap nuts with non-metallic insert



Passscheiben/Stützscheiben
Shim rings/supporting rings



Holzverbinder, Dorne einseitig oder zweiseitig, Blech/Temperguss
Timber connectors, spikes one sided or two sided, metal sheet/malleable cast iron

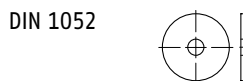

Scheiben für Holzverbinder
Washers for timber connectors



Zylinderschrauben mit Schlitz
Slotted cheese head screws



Splinte
Split pins



Flache Scheiben für Bolzen, Produktklasse A
Washers for clevis pins, product grade A

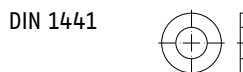

Flache Scheiben für Bolzen, Produktklasse C
Washers for clevis pins, product grade C

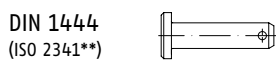

Bolzen mit Kopf
Clevis pins with head

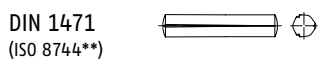

Kegelkerbstifte
Grooved pins, full length taper grooved

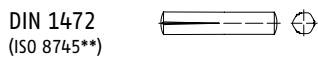

Passkerbstifte
Grooved pins, half length taper grooved

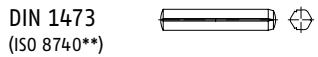

Zylinderkerbstifte
Grooved pins, full length parallel grooved



Steckkerbstifte
Grooved pins, half length reverse grooved



Knebelkerbstifte
Grooved pins, third length centre grooved

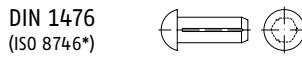

Halbrundkerbnägel
Grooved pins with round head



Senkkerbnägel
Grooved pins with countersunk head

* DIN/ISO identisch = austauschbar	** DIN/ISO/EN weitgehend austauschbar	*** DIN/ISO-Umstellung → Rote Seiten „Technische Informationen“	Stahl/ Stahl mit Überzug	Nicht- rostende Stähle	Ms Cu Al Ti Kunststoff	Befesti- gungs- technik	Maße TI
------------------------------------	---------------------------------------	---	--------------------------------	------------------------------	------------------------------	-------------------------------	------------

DIN/ISO/EN

Genormte Artikel/
Standardized Products

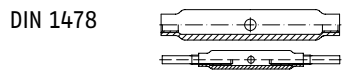

DIN 1478

Spannschlösser aus Stahlrohr
SP = Spannschloßmutter
SP-AE = mit 2 Anschweißenden
Turnbuckles made from tubes
SP = turnbuckles
SP-AE = with 2 welding studs



DIN 1478

Spannschlösser aus Stahlrohr
mit Zulassung als Bauprodukt (ÜZ)
Turnbuckles made from tubes
with approval as construction product

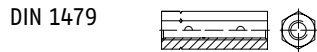

DIN 1479

Sechskant-Spannschloßmuttern
Hexagon turnbuckles

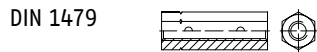

DIN 1479

Sechskant-Spannschloßmuttern
mit Zulassung als Bauprodukt (ÜZ)
Hexagon turnbuckles with approval as construction product

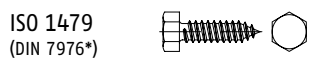

ISO 1479
(DIN 7976*)

Sechskant-Blechschauben
Hexagon head tapping screws

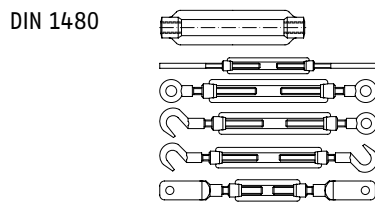

DIN 1480

Spannschlösser, geschmiedet
SP = Spannschloßmuttern ohne Anschlusssteile
SP-AE = mit 2 Anschweißenden
SP-RR = mit 2 Ringösen
SP-RH = mit Ringöse und Haken
SP-HH = mit 2 Haken
SP-BS = mit 2 Blattschrauben
Turnbuckles, forged

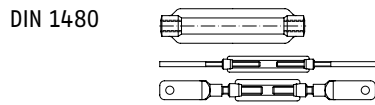

DIN 1480

Spannschlösser, geschmiedet,
mit Zulassung als Bauprodukt
SP = ohne Anschlusssteile (ÜZ)
SP-AE = mit 2 Anschweißenden (ÜZ)
SP-BS-S = mit 2 Blattschrauben (CE EN 1090)
Turnbuckles, forged, with approval as construction product



DIN 1481
(ISO 8752**)

Spannstifte, schwer
Spring type straight pins, heavy duty

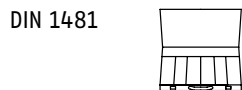

DIN 1481

Artikel 82481
Spannhülsen-Sortimente/-Montagekoffer
Spring type straight pins assortment



DIN 1498

Einspannbuchsen für Lagerungen
Tension bushes for internal application



ISO 1580
(DIN 85**)

Flachkopfschrauben mit Schlitz
Slotted pan head screws

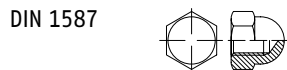

DIN 1587

Sechskant-Hutmuttern, hohe Form
Hexagon domed cap nuts, high type

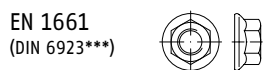

EN 1661
(DIN 6923***)

Sechskantmuttern mit Flansch
Hexagon nuts with flange

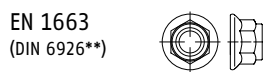

EN 1663
(DIN 6926**)





Sechskantmuttern mit Klemmteil
und Flansch, nichtmetallischer Einsatz
Prevailing torque type hexagon nuts with flange
and non-metallic insert

Stahl/ Stahl mit Überzug	Nicht- rostende Stähle	Ms Cu Al Ti Kunststoff	Befesti- gungs- technik	Maße TI
214				81
214				81
214				81
214				81
214	518			46
215	518			82
215 216 217				82
217	519			121
220				
220				120
220	520	633		37
221	521	633		63
222	521			64
223				69

* DIN/ISO identisch = austauschbar	** DIN/ISO/EN weitgehend austauschbar	*** DIN/ISO-Umstellung → Rote Seiten „Technische Informationen“	Stahl/ Stahl mit Überzug	Nicht- rostende Stähle	Ms Cu Al Ti Kunststoff	Befesti- gungs- technik	Maße TI
------------------------------------	---------------------------------------	---	--------------------------------	------------------------------	------------------------------	-------------------------------	------------

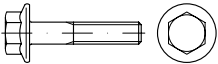
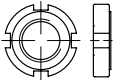
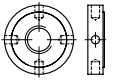
DIN/ISO/EN

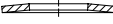
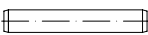
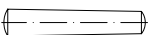
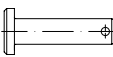
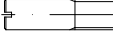
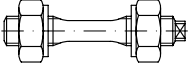
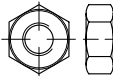
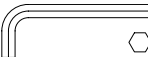
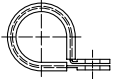
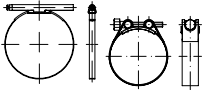
Genormte Artikel/
Standardized Products







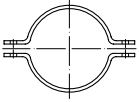

EN 1664 (DIN 6927**)		Sechskantmuttern mit Klemmteil und Flansch, Ganzmetallmuttern Prevailing torque type hexagon nuts with flange, all-metal
EN 1665 (DIN 6921***)		Sechskantschrauben mit Flansch Hexagon bolts with flange
DIN 1804		Nutmuttern Slotted round nuts for hook spanner
DIN 1816		Kreuzlochmuttern Round nuts with set pin holes inside
ISO 2009 (DIN 963**)		Senkschrauben mit Schlitz Slotted countersunk flat head screws
ISO 2010 (DIN 964**)		Linsensenkschrauben mit Schlitz Slotted raised countersunk head screws
DIN 2093 (EN 16983*)		Tellerfedern Disc springs
ISO 2338 (DIN 7**)		Zylinderstifte Parallel pins
ISO 2339 (DIN 1**)		Kegelstifte Taper pins
ISO 2341 (DIN 1444*)		Bolzen mit Kopf Clevis pins with head
ISO 2342 (DIN 427*)		Gewindestifte mit Schlitz und Schaft Slotted headless screws with shank
DIN 2510		Schraubenbolzen mit Dehnschaft und Muttern mit Prüfbescheinigung EN 10204/3.2/3.1 Bolts with waisted shank and nuts, with certificate EN 10204/3.2/3.1
DIN 2510		Sechskantmuttern für Schraubenbolzen, mit Prüfbescheinigung EN 10204/3.1 Hexagon nuts for bolts with waisted shank, with certificate EN 10204/3.1
ISO 2936 (DIN 911***)		Winkelschraubendreher (Stiftschlüssel) für Innensechskant-Antrieb Hexagon socket screw keys (socket wrenches)
DIN 3016		Halterungsschellen mit Gummiprofil Fastening clamps with rubber profile
DIN 3017		Schlauchschellen Form A = mit Schneckenantrieb Form C = mit Rundbolzen Hose clamps Type A = with worm gear drive Type C = with hinge bolts
DIN 3404		Flachschmiernippel Lubricating nipples, button head

Stahl/ Stahl mit Überzug	Nicht- rostende Stähle	Ms Cu Al Ti Kunststoff	Befesti- gungs- technik	Maße Ti
223				69
223	521			17
224	522			74
225				75
225	522	634		27
227	524	635		39
227	525			141
229	525			116
230	527			117
231				122
232	527			19
232				18
233				61
233				
233				130
234	528			131
234		636		25

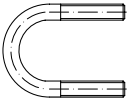
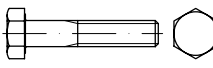
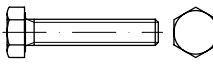
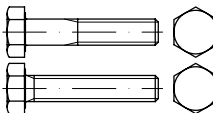
* DIN/ISO identisch = austauschbar	** DIN/ISO/EN weitgehend austauschbar	*** DIN/ISO-Umstellung → Rote Seiten „Technische Informationen“	Stahl/ Stahl mit Überzug	Nicht- rostende Stähle	Ms Cu Al Ti Kunststoff	Befesti- gungs- technik	Maße Ti
------------------------------------	---------------------------------------	---	--------------------------------	------------------------------	------------------------------	-------------------------------	------------

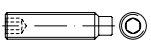
DIN/ISO/EN

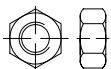
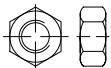
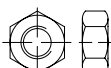
Genormte Artikel/
Standardized Products

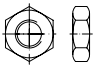
DIN/ISO/EN	Genormte Artikel/ Standardized Products	Stahl/ Stahl mit Überzug	Nicht- rostende Stähle	Ms Cu Al Ti Kunststoff	Befesti- gungs- technik	Maße TI
DIN 3405	 Trichterschmiernippel Lubricating nipples, cupped type	235				25
DIN 3567	 Rohrschellen Pipe clamps	235	528			132
DIN 3568	 Klemmplatten Clamping plates for pipe fixings	235				132
DIN 3570	 Rundstahlbügel (Rohrbügel) Stirrup bolts	235	528			130
ISO 4014 (DIN 931*/***)	 Sechskantschrauben mit Schaft Hexagon head bolts	239 236 238	529 530	636		15
ISO 4017 (DIN 933*/***)	 Sechskantschrauben mit Gewinde bis Kopf Hexagon head screws	257 254 256	534 536	636		15
	 Artikel 83931, 83933/ASME B18.2.1 Sechskantschrauben mit Schaft/Vollgewinde, mit UNC-/UNF-Gewinde Hex cap screws with shank/full thread, with UNC/UNF thread	410				16
ISO 4026 (DIN 913*)	 Gewindestifte m. Innensechskant u. Kegelpuppe Hexagon socket set screws with flat point	272	540			20
ISO 4027 (DIN 914*)	 Gewindestifte mit Innensechskant und Spitze Hexagon socket set screws with cone point	274	541			20
ISO 4028 (DIN 915*)	 Gewindestifte mit Innensechskant und Zapfen Hexagon socket set screws with full dog point	275	542			20
ISO 4029 (DIN 916*)	 Gewindestifte mit Innensechskant und Ringschneide Hexagon socket set screws with cup point	277	543			21
ISO 4032 (DIN 934***)	 Sechskantmuttern, ISO-Typ 1, Regelgewinde Hexagon nuts, ISO type 1, coarse thread	279 278 279	544 545	637		62
	 Artikel 83934/ASME B18.2.2 Sechskantmuttern mit UNC-/UNF-Gewinde Hex nuts with UNC/UNF thread	414	592			61
ISO 4033 (DIN 934***)	 Sechskantmuttern, ISO-Typ 2, Regelgewinde, Festigkeitsklasse 12 Hexagon nuts, ISO type 2, coarse thread, property class 12	284				63
ISO 4035 (DIN 439/ 936***)	 Sechskantmuttern, niedrige Form (mit Fase) Hexagon thin nuts, chamfered	284	546	638		63
	 Artikel 83936/ASME B18.2.2 Niedrige Sechskantmuttern mit UNC-/UNF- Gewinde Hex jam nuts with UNC/UNF thread	415				61

* DIN/ISO identisch = austauschbar	** DIN/ISO/EN weitgehend austauschbar	*** DIN/ISO-Umstellung → Rote Seiten „Technische Informationen“	Stahl/ Stahl mit Überzug	Nicht- rostende Stähle	Ms Cu Al Ti Kunststoff	Befesti- gungs- technik	Maße TI
------------------------------------	---------------------------------------	---	--------------------------------	------------------------------	------------------------------	-------------------------------	------------

DIN/ISO/EN

Genormte Artikel/
Standardized Products

~DIN 4109

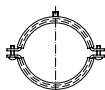

Rohrschellen mit schalldämmender Einlage
Screwed tubular clamps with noise protection inlay

ISO 4762
(DIN 912*)

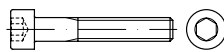

Zylinderschrauben mit Innensechskant
Hexagon socket head cap screws

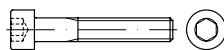

Artikel 83912/ASME B18.3
Zylinderschrauben mit UNC-Gewinde,
mit Innensechskant
Hexagon socket head cap screws with UNC thread

ISO 4766
(DIN 551*)

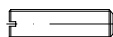

Gewindestifte mit Schlitz und Kegelkuppe
Slotted grub screws with flat point

DIN 5299

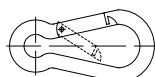

Karabinerhaken Form C
Snap hooks, type C

DIN 5406
MB/MBL

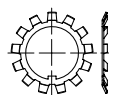

Sicherungsbleche für Nutmuttern DIN 981
Lockwashers/safety plates for locknuts acc. to DIN 981

DIN 5586

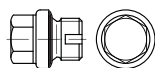

Verschlusschrauben m. Bund u. Entlüftung,
mit aufgeschmolzener Dichtung (Form B),
DIN 910-2, Form A
Hexagon head screw plugs with collar, vent
and melted sealing (type B), DIN 910-2, type A

DIN 6304

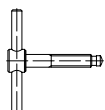

Knebelschrauben mit festem Knebel
Tommy screws with fixed clamping bolt

DIN 6305

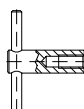

Knebelmuttern mit festem Knebel
Tommy nuts with fixed clamping bolt

DIN 6306

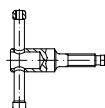

Knebelschrauben mit losem Knebel
Tommy screws with movable clamping bolt

DIN 6307

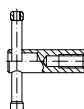

Knebelmuttern mit losem Knebel
Tommy nuts with movable clamping bolt

DIN 6311



Druckstücke
für Gewindestifte m. Druckzapfen DIN 6332
Thrust pads for grub screws with thrust point acc. to DIN 6332

DIN 6319

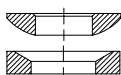

Kugelscheiben C, Kegelpfannen D, G
Spherical washers, type C, conical seats, type D and G

DIN 6325
(ISO 8734*)

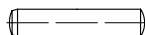

Zylinderstifte
Parallel pins

Stahl/ Stahl mit Überzug	Nicht- rostende Stähle	Ms Cu Al Ti Kunststoff	Befesti- gungs- technik	Maße TI
286				132
286	547			12
415				13
305	551	638		19
306				133
306				98
306				24
306				127
307				127
307				128
307				128
307				128
307				112
308				116

* DIN/ISO identisch = austauschbar







** DIN/ISO/EN weitgehend austauschbar

*** DIN/ISO-Umstellung → Rote Seiten „Technische Informationen“

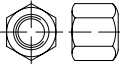
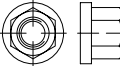
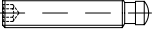
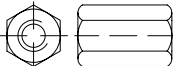
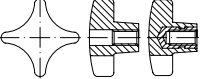
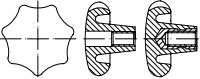
Stahl/ Stahl mit Überzug	Nicht- rostende Stähle	Ms Cu Al Ti Kunststoff	Befesti- gungs- technik	Maße TI
--------------------------------	------------------------------	------------------------------	-------------------------------	------------

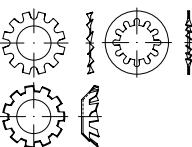
DIN/ISO/EN

Genormte Artikel/
Standardized Products

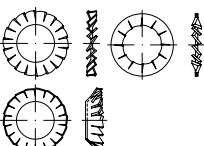







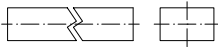
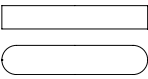

DIN 6330		Sechskantmuttern, 1,5 d hoch Form B = einseitig kugelige Auflagefläche Hexagon nuts with a height of 1,5 d Type B = one spherical bearing face
DIN 6331		Sechskantmuttern mit Bund 1,5 d hoch Hexagon nuts with collar, with a height of 1,5 d
DIN 6332		Gewindestifte mit Druckzapfen Grub screws with thrust point
~DIN 6334		Sechskantmuttern, 3 d hoch Hexagon nuts with a height of 3 d
DIN 6335		Kreuzgriffe Palm grips
DIN 6336		Sterngriffe Star grips
DIN 6340		Scheiben, gehärtet Washers for clamping devices, hardened
DIN 6796		Spannscheiben Conical spring washers
~DIN 6797		Zahnscheiben Form A = außenverzahnt Form I = innenverzahnt Form V = versenkt Toothed lock washers Type A = external teeth Type I = internal teeth Type V = countersunk
		Artikel 88123–88126 TECKENTRUP-Sperrkantscheiben für Sechskantschrauben und Zylinderschrauben mit Innensechskant TECKENTRUP lock washers for hexagon head screws and hexagon socket cap screws
		Artikel 88129 TECKENTRUP-Sperrkantscheiben mit Kontaktzähnen TECKENTRUP lock washers with contact serrations
		Artikel 88119 LOCKTIX-Scheiben LOCKTIX washers
~DIN 6798		Fächerscheiben Form A = außenverzahnt Form I = innenverzahnt Form V = versenkt Serrated lock washers Type A = external teeth Type I = internal teeth Type V = countersunk

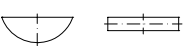
Stahl/ Stahl mit Überzug	Nicht- rostende Stähle	Ms Cu Al Ti Kunststoff	Befesti- gungs- technik	Maße TI
309	552			64
309	552			64
310				129
310	552			64
310		639		126
310		639		126
311				84
311	552			
311	553			99
430	599			105
431	600			106
432				104
313	553	639		99

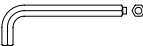
* DIN/ISO identisch = austauschbar	** DIN/ISO/EN weitgehend austauschbar	*** DIN/ISO-Umstellung → Rote Seiten „Technische Informationen“	Stahl/ Stahl mit Überzug	Nicht- rostende Stähle	Ms Cu Al Ti Kunststoff	Befesti- gungs- technik	Maße TI
------------------------------------	---------------------------------------	---	--------------------------------	------------------------------	------------------------------	-------------------------------	------------

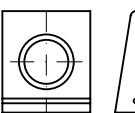
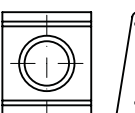
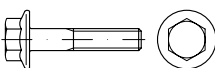
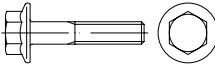
DIN/ISO/EN

Genormte Artikel/
Standardized Products

DIN 6799		Sicherungsscheiben für Wellen Retaining rings for shafts
DIN 6880		Keilstahl Key steel
DIN 6885		Passfedern Parallel keys
DIN 6887		Nasenkeile Taper keys with gib head
DIN 6888		Scheibenfedern Woodruff keys
DIN 6899		Kauschen Thimbles for fibre ropes
DIN 6911		Winkelschraubendreher (Stiftschlüssel) mit Zapfen für Innensechskantschrauben DIN 6912 Hexagon socket screw keys (pin wrenches) with pilot for hexagon socket cap screws acc. to DIN 6912
DIN 6912		Zylinderschrauben mit Innensechskant und Zapfenführung Hexagon socket head cap screws with low head and centre
DIN 6917		Scheiben, vierkant, für HV-Verbindungen an Doppel-T-Trägern (14 % Neigung) Square taper washers for friction grip bolts on double-T-beams in steel constructions (taper 14%)
DIN 6918		Scheiben, vierkant, für HV-Verbindungen an U-Trägern (8 % Neigung) Square taper washers for friction grip bolts on U-beams in steel constructions (taper 8%)
DIN 6921 (EN 1665***)		Sechskantschrauben mit Flansch Hexagon flange bolts
		Artikel 10105 Sechskantschrauben mit Flansch nach MBN 10105 Hexagon flange bolts acc. to MBN 10105
DIN 6923 (EN 1661***)		Sechskantmuttern mit Flansch Hexagon flange nuts
		Artikel 13023 Sechskantmuttern mit Flansch nach MBN 13023 Hexagon flange nuts acc. to MBN 13023
		Artikel 13024 Leichtbaumuttern mit Flansch Lightweight construction nuts

Stahl/ Stahl mit Überzug	Nicht- rostende Stähle	Ms Cu Al Ti Kunststoff	Befesti- gungs- technik	Maße TI
314	554			100
314				137
315	554			138
316				138
316				138
316				133
317				
317	555			12
319				86
320				86
320	557			17
388				17
322	558			64
396				69
396				65

* DIN/ISO identisch = austauschbar	** DIN/ISO/EN weitgehend austauschbar	*** DIN/ISO-Umstellung → Rote Seiten „Technische Informationen“	Stahl/ Stahl mit Überzug	Nicht- rostende Stähle	Ms Cu Al Ti Kunststoff	Befesti- gungs- technik	Maße TI
------------------------------------	---------------------------------------	---	--------------------------------	------------------------------	------------------------------	-------------------------------	------------

DIN/ISO/EN

Genormte Artikel/
Standardized Products

~DIN 6923

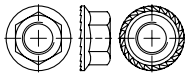

Sechskantmuttern mit Flansch
und Sperrverzahnung
Hexagon locking nuts with flange

DIN 6924
(ISO 7040**/
10512)

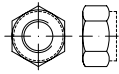

Sechskantmuttern mit Klemmteil,
nichtmetallischer Einsatz (Kunststoffring)
Prevailing torque type hexagon nuts
with non-metallic insert (plastic)

DIN 6925
(ISO 7042**/
10513)

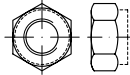

Sechskantmuttern mit Klemmteil,
Ganzmetallmuttern
Prevailing torque type hexagon nuts, all-metal

DIN 6926
(EN 1663***)



Sechskantmuttern mit Klemmteil
und Flansch, nichtmetallischer Einsatz
Prevailing torque type hexagon nuts with flange
and non-metallic insert

DIN 6927
(EN 1664***)



Sechskantmuttern mit Klemmteil
und Flansch, Ganzmetallmuttern
Prevailing torque type hexagon nuts with flange,
all-metal

ISO 7040
(DIN 6924**/
DIN 982***)

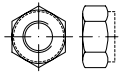

Sechskantmuttern mit Klemmteil,
nichtmetallischer Einsatz (Kunststoffring)
Prevailing torque type hexagon nuts
with non-metallic insert (plastic)

ISO 7042
(DIN 6925**/
DIN 980***)

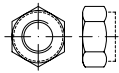

Sechskantmuttern mit Klemmteil,
Ganzmetallmuttern
Prevailing torque type hexagon nuts, all-metal

ISO 7045
(DIN 7985**)

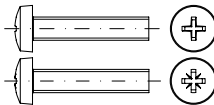

Linsenschrauben mit Kreuzschlitz
Cheese head screws with cross recess

ISO 7046
(DIN 965***)

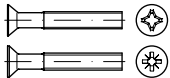

Senkschrauben mit Kreuzschlitz
Countersunk head screws with cross recess

ISO 7047
(DIN 966***)

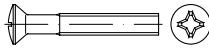

Linsensenkschrauben mit Kreuzschlitz
Raised countersunk head screws with cross recess

ISO 7049
(DIN 7981**)

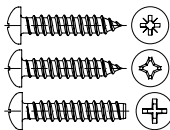

Linsenkopf-Blechschauben mit Kreuzschlitz
Pan head tapping screws with cross recess

ISO 7050
(DIN 7982***)



Senk-Blechschauben, Senk $\alpha = 90^\circ$
mit Kreuzschlitz
Countersunk head tapping screws
with cross recess, countersunk $\alpha = 90^\circ$

ISO 7051
(DIN 7983***)



Linsensenk-Blechschauben, Senk $\alpha = 90^\circ$
mit Kreuzschlitz
Raised csk. head tapping screws
with cross recess, countersunk $\alpha = 90^\circ$

ISO 7089
(DIN 125**)

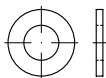







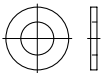
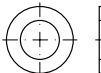

Flache Scheiben, normale Reihe, PKI. A
Plain washers, normal series, without chamfer,
product grade A

Stahl/ Stahl mit Überzug	Nicht- rostende Stähle	Ms Cu Al Ti Kunststoff	Befesti- gungs- technik	Maße TI
322	557			64
323	558			9
323				9
324				69
324				69
324	559			9
325	560			9
326	560			40
328	562			39
329	564			39
330	565			46
332	567			47
333	567			47
333	567			84

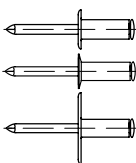
* DIN/ISO identisch = austauschbar	** DIN/ISO/EN weitgehend austauschbar	*** DIN/ISO-Umstellung → Rote Seiten „Technische Informationen“	Stahl/ Stahl mit Überzug	Nicht- rostende Stähle	Ms Cu Al Ti Kunststoff	Befesti- gungs- technik	Maße TI
------------------------------------	---------------------------------------	---	--------------------------------	------------------------------	------------------------------	-------------------------------	------------

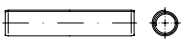
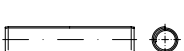
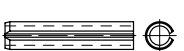
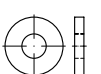
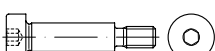
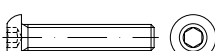
DIN/ISO/EN

Genormte Artikel/
Standardized Products

ISO 7090 (DIN 125**)		Flache Scheiben, normale Reihe, PKI. A Plain washers, normal series, with chamfer, product grade A
ISO 7091 (DIN 126*)		Flache Scheiben, normale Reihe, PKI. C Plain washers, normal series, product grade C
ISO 7092 (DIN 433**)		Flache Scheiben, kleine Reihe, PKI. A Plain washers, small series, product grade A
ISO 7093 (DIN 9021**)		Flache Scheiben, große Reihe, PKI. A Plain washers, large series, product grade A
ISO 7094 (DIN 440**)		Flache Scheiben, extra große Reihe, PKI. C Plain washers, extra large series, product grade C
DIN 7337 (ISO 15973-16585)		Blindniete → Artikel 88401-88488 Blind rivets
DIN 7338		Niete für Brems- und Kupplungsbeläge Rivets for brake linings and clutch linings
DIN 7343 (ISO 8750*/8751)		Spiral-Spannstifte, Regelausführung Spring-type straight pins, coiled, standard duty
DIN 7344 (ISO 8748**)		Spiral-Spannstifte, schwere Ausführung Spring-type straight pins, coiled, heavy duty
DIN 7346 (ISO 13337**)		Spannstifte, leichte Ausführung Spring-type straight pins, slotted, light duty
DIN 7349		Scheiben für Schrauben mit schweren Spannhülsen Washers for screws with heavy spring-type straight pins
ISO 7379		Pass-Schulterschrauben mit Innensechskant Hexagon socket head shoulder screws
ISO 7380-1		Flachkopfschrauben mit Innensechskant Hexagon socket button head screws
ISO 7380-2		Flachkopfschrauben mit Innensechskant, mit angepresster Scheibe Hexagon socket button head screws with flange
~ISO 7380-1 ISR (~DIN 34805-1)		Flachkopfschrauben mit Innensechsrund Hexalobular socket button head screws
~ISO 7380-2 ISR (~DIN 34805-2)		Flachkopfschrauben mit Innensechsrund, mit angepresster Scheibe Hexalobular socket button head screws with flange
ISO 7434 (DIN 553*)		Gewindestifte mit Schlitz und Spitze Slotted grub screws with cone point

Stahl/ Stahl mit Überzug	Nicht- rostende Stähle	Ms Cu Al Ti Kunststoff	Befesti- gungs- technik	Maße TI
335	568	640		84
337				84
338	569	641		84
338	569	641		85
338	570			84
			689	206
		641		135
339	570			121
339				121
340				122
341	571			85
342	571			13
342	571			14
344	572			14
343	572			14
344	573			14
345	573	641		19

* DIN/ISO identisch = austauschbar	** DIN/ISO/EN weitgehend austauschbar	*** DIN/ISO-Umstellung → Rote Seiten „Technische Informationen“	Stahl/ Stahl mit Überzug	Nicht- rostende Stähle	Ms Cu Al Ti Kunststoff	Befesti- gungs- technik	Maße TI
------------------------------------	---------------------------------------	---	--------------------------------	------------------------------	------------------------------	-------------------------------	------------

DIN/ISO/EN

Genormte Artikel/
Standardized Products

ISO 7435
(DIN 417*)

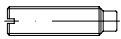

Gewindestifte mit Schlitz und Zapfen
Slotted grub screws with full dog point

DIN 7500

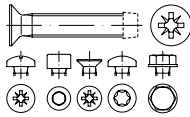

Gewindefurchende Schrauben für metrisches ISO-Gewinde
Form C = Flachkopfschrauben
~Form D = Sechskantschrauben mit Bund
Form E = Zylinderschrauben mit Innensechskant
Form M = Senkschrauben
Form CE-ISR/PE = Flachkopfschrauben mit Innensechsrund
Thread rolling screws for ISO metric thread
Type C = pan head
~Type D = hexagon head with collar
Type E = cylinder head with hexagon socket
Type M = countersunk head
Type CE-ISR/PE = pan head, hexalobular socket

DIN 7504
(ISO 15480-15483)

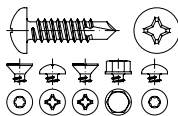

Bohrschrauben = Blechschrauben mit Bohrspitze
Form K = Sechskantschrauben mit Bund
Form N = Flachkopfschrauben
Form P = Senkschrauben
Drilling screws with tapping screw thread
Type K = hexagon head with collar
Type N = pan head
type P = countersunk head

DIN 7513



Gewinde-Schneidschrauben
Form A = mit Sechskantkopf
Form B = mit Zylinderkopf und Schlitz
Thread cutting screws
Type A = hexagon head
Type B = slotted cheese head

DIN 7516

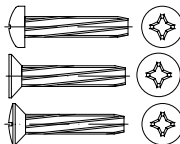

Gewinde-Schneidschrauben mit Kreuzschlitz
Form A = mit Linsenkopf
Form D = mit Senkkopf
Form E = mit Linsensenkkopf
Thread cutting screws with cross recess
Type A = pan head
Type D = countersunk head
Type E = raised countersunk head

~DIN 7516

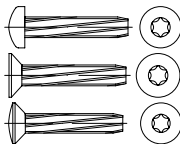

Gewinde-Schneidschrauben mit Innensechsrund (ISR)
Form AE = mit Linsenkopf
Form DE = mit Senkkopf
Form EE = mit Linsensenkkopf
Thread cutting screws with hexalobular socket
Type AE = pan head
Type DE = countersunk head
Type EE = raised countersunk head

DIN 7603



Dichtringe
Sealing rings

DIN 7604

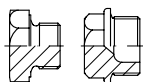

Verschlusschrauben mit Bund und Außensechskant
Hexagon head screw plugs with collar

DIN 7643

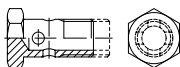

Hohlschrauben
Hollow screws for ring type banjos

Stahl/ Stahl mit Überzug	Nicht- rostende Stähle	Ms Cu Al Ti Kunststoff	Befesti- gungs- technik	Maße TI
345				19
346				41
347				42
349				44
350				45
351				45
		642		87
351	573			24
352				34

* DIN/ISO identisch = austauschbar







** DIN/ISO/EN weitgehend austauschbar

*** DIN/ISO-Umstellung → Rote Seiten „Technische Informationen“

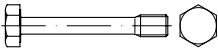
Stahl/ Stahl mit Überzug	Nicht- rostende Stähle	Ms Cu Al Ti Kunststoff	Befesti- gungs- technik	Maße TI
--------------------------------	------------------------------	------------------------------	-------------------------------	------------

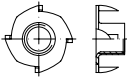
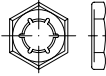
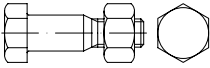
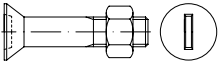
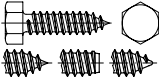
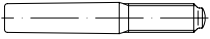
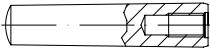
DIN/ISO/EN

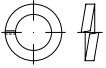
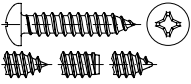
Genormte Artikel/
Standardized Products

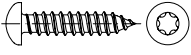
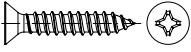
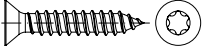





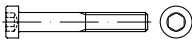
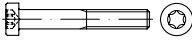
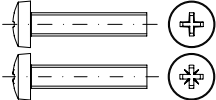

~DIN 7964		Schrauben mit dünnem Schaft Form D1 = Sechskantkopf nach ISO 4014 Hexagon head screws with waisted shank Type D1 = hexagon head acc. To ISO 4014
DIN 7965		Einschraubmuttern (Schraubdübel, „RAMPA-Muffen“) Screwed inserts "RAMPA"
		Artikel 88108 Einschlagmuttern Tee nuts with prong
~DIN 7967		Sicherungsmuttern (Palmmuttern) Self locking counter nuts
DIN 7968		Sechskant-Passschrauben für Stahlkonstruktionen mit CE nach EN 15048 Hexagon fit bolts for steel structures with CE acc. to EN 15048
DIN 7969		Senkschrauben mit Schlitz für Stahlkonstruktionen mit CE nach EN 15048 Slotted countersunk head bolts for steel structures with CE acc. to EN 15048
DIN 7976 (ISO 1479**)		Sechskant-Blechschauben Form C = Spitze, Form F = Zapfen Hexagon head tapping screws Type C = cone end, type F = flat end
DIN 7977 (ISO 8737*)		Kegelstifte mit Gewindezapfen Taper pins with external thread, constant threaded part
DIN 7978 (ISO 8736*)		Kegelstifte mit Innengewinde Taper pins with internal thread
DIN 7979 (ISO 8733/ 8735***)		Zylinderstifte mit Innengewinde Parallel pins with internal thread
~DIN 7980		Federringe für Zylinderschrauben Spring lock washer for cheese head screws
DIN 7981 (ISO 7049**)		Linsen-Blechschauben mit Kreuzschlitz Form C = Spitze, Form F = Zapfen Pan head tapping screws with cross recess Type C = cone end, type F = flat end
		Artikel 88981 Kappenkopf-Blechschauben Cap-head tapping screws
~DIN 7981 ISR (ISO 14585)		Linsen-Blechschauben mit Innensechsrund Pan head tapping screws with hexalobular socket
DIN 7982 (ISO 7050***)		Senk-Blechschauben mit Kreuzschlitz Countersunk head tapping screws with cross recess
~DIN 7982 ISR (ISO 14586)		Senk-Blechschauben mit Innensechsrund Countersunk head tapping screws with hexalobular socket

Stahl/ Stahl mit Überzug	Nicht- rostende Stähle	Ms Cu Al Ti Kunststoff	Befesti- gungs- technik	Maße TI
	574			17
352		642		79
428				78
352	574			68
352				57
354				57
354	574			46
355				117
355				118
356				116
357	575			100
357 331	575			46
360	577			
359 406	590			46
360 332	577			47
360 405	591			47

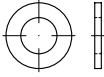
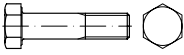
* DIN/ISO identisch = austauschbar	** DIN/ISO/EN weitgehend austauschbar	*** DIN/ISO-Umstellung → Rote Seiten „Technische Informationen“	Stahl/ Stahl mit Überzug	Nicht- rostende Stähle	Ms Cu Al Ti Kunststoff	Befesti- gungs- technik	Maße TI
------------------------------------	---------------------------------------	---	--------------------------------	------------------------------	------------------------------	-------------------------------	------------

DIN/ISO/EN

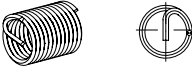
Genormte Artikel/
Standardized Products

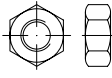
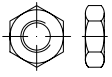
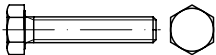







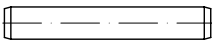

DIN 7983 (ISO 7051***)		Linsensenk-Blechschauben mit Kreuzschlitz Raised countersunk head tapping screws with cross recess
DIN 7984		Zylinderschrauben mit Innensechskant, mit niedrigem Kopf Hexagon socket head cap screws with low head
~DIN 7984 ISR (ISO 14580)		Zylinderschrauben mit Innensechsrund, mit niedrigem Kopf Hexalobular socket head cap screws with low head
DIN 7985 (ISO 7045**)		Linsenschrauben mit Kreuzschlitz Pan head screws with cross recess
~DIN 7985 ISR (ISO 14583**)		Linsenschrauben mit Innensechsrund Pan head screws with hexalobular socket
DIN 7989		Scheiben für Stahlkonstruktionen Washers for steel structures
DIN 7990		Sechskantschrauben für Stahlkonstruktionen mit CE nach EN 15048 Hexagon head bolts for steel structures with CE acc. to EN 15048
DIN 7991 (→ ISO 10642)		Senkschrauben mit Innensechskant Hexagon socket countersunk head screws
~DIN 7991 ISR (ISO 14581) (→ ISO 10642 ISR)		Senkschrauben mit Innensechsrund Hexalobular socket countersunk head screws
DIN 7993 (DIN 9925/ 9926***)		Runddraht-Sprengringe für Wellen und Bohrungen Snap rings for shafts and bores
DIN 8140		Artikel 88330-88346 Gewindeeinsätze aus Draht, Regelgewinde, Feingewinde, selbstsichernd Wire thread inserts, coarse thread, fine pitch thread, with locking
		Artikel 88342 Sortimente Gewindeeinsätze Assortment thread inserts
ISO 8673 (DIN 934***)		Sechskantmuttern, ISO-Typ 1, metrisches Feingewinde Hexagon nuts, ISO type 1, metric fine pitch thread
ISO 8675 (DIN 439***)		Sechskantmuttern, niedrige Form (mit Fasen), metrisches Feingewinde Hexagon thin nuts with chamfers, metric fine pitch thread
ISO 8676 (DIN 961*/***)		Sechskantschrauben mit Gewinde bis Kopf, metrisches Feingewinde Hexagon head screws with thread up to head, metric fine pitch thread

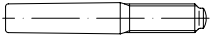
Stahl/ Stahl mit Überzug	Nicht- rostende Stähle	Ms Cu Al Ti Kunststoff	Befesti- gungs- technik	Maße TI
362	578			47
362	578			13
364				13
364	579			40
366	581			40
367	582			84
367				57
389	587			14
392				
369				101
	603			150
	605			
369	582	642		62
371	582	643		63
372				15

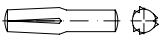
* DIN/ISO identisch = austauschbar	** DIN/ISO/EN weitgehend austauschbar	*** DIN/ISO-Umstellung → Rote Seiten „Technische Informationen“	Stahl/ Stahl mit Überzug	Nicht- rostende Stähle	Ms Cu Al Ti Kunststoff	Befesti- gungs- technik	Maße TI
------------------------------------	---------------------------------------	---	--------------------------------	------------------------------	------------------------------	-------------------------------	------------

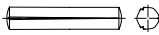
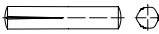
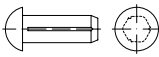
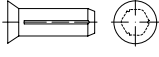
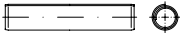
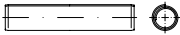
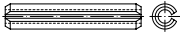
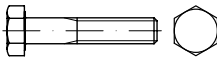
DIN/ISO/EN

Genormte Artikel/
Standardized Products

ISO 8734 (DIN 6325*)		Zylinderstifte Parallel pins
ISO 8735 (→ DIN 7979***)		Zylinderstifte mit Innengewinde Parallel pins with internal thread
ISO 8736 (DIN 7978*)		Kegelstifte mit Innengewinde Taper pins with internal thread
ISO 8737 (DIN 7977*)		Kegelstifte mit Gewindezapfen Taper pins with external thread, constant threaded part
ISO 8738 (DIN 1440*)		Flache Scheiben für Bolzen Washers for clevis pins
ISO 8740 (DIN 1473**)		Zylinderkerbstifte mit Fase Grooved pins, full length parallel grooved
ISO 8741 (DIN 1474**)		Steckkerbstifte Grooved pins, half length reverse grooved
ISO 8742 (DIN 1475**)		Knebelkerbstifte mit kurzen Kerben Grooved pins, third length centre grooved
ISO 8744 (DIN 1471**)		Kegelkerbstifte Grooved pins, full length taper grooved
ISO 8745 (DIN 1472**)		Passkerbstifte Grooved pins, half length taper grooved
ISO 8746 (DIN 1476*)		Halbrundkerbnägel Grooved pins with round head
ISO 8747 (DIN 1477*)		Senkkerbnägel Grooved pins with countersunk head
ISO 8748 (DIN 7344**)		Spiral-Spannstifte, schwere Ausführung Spring-type straight pins, coiled, heavy duty
ISO 8750 (DIN 7343**)		Spiral-Spannstifte, Regelausführung Spring-type straight pins, coiled, standard duty
ISO 8752 (DIN 1481**)		Spannstifte (-hülsen), geschlitz, schwere Ausführung Spring-type straight pins, heavy duty
ISO 8765 (DIN 960*/****)		Sechskantschrauben mit Schaft, metrisches Feingewinde Hexagon head bolts with shank, metric fine pitch thread
DIN 9021 (ISO 7093**)		Flache Scheiben, Außendurchmesser ca. 3 d Plain washers, outside diameter ≈ 3 x d
DIN 9925 (DIN 7993 A****)		Runddraht-Sprengringe für Wellen Snap rings for shafts
DIN 9926 (DIN 7993 B****)		Runddraht-Sprengringe für Bohrungen Snap rings for bores

Stahl/ Stahl mit Überzug	Nicht- rostende Stähle	Ms Cu Al Ti Kunststoff	Befesti- gungs- technik	Maße TI
374				116
356				116
376				118
376				117
376	583			85
377	583			119
378				119
378				118
378	583			118
379	584			119
380	584	643		120
380				120
380				121
381	584			121
381	585			121
384				15
387	586	643		85
388				101
388				101

* DIN/ISO identisch = austauschbar	** DIN/ISO/EN weitgehend austauschbar	*** DIN/ISO-Umstellung → Rote Seiten „Technische Informationen“	Stahl/ Stahl mit Überzug	Nicht- rostende Stähle	Ms Cu Al Ti Kunststoff	Befesti- gungs- technik	Maße TI
------------------------------------	---------------------------------------	---	--------------------------------	------------------------------	------------------------------	-------------------------------	------------

DIN/ISO/EN

Genormte Artikel/
Standardized Products

ISO 10511
(DIN 985***)

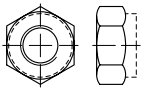

Sechskantmuttern mit Klemmteil,
mit nichtmetallischem Einsatz, niedrige Form
Prevailing torque type hexagon nuts with non-metallic insert

ISO 10512
(DIN 982***)

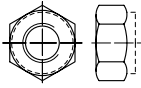

Sechskantmuttern mit Klemmteil,
mit nichtmetallischem Einsatz,
hohe Form, mit metrischem Feingewinde
Prevailing torque type hexagon nuts
with non-metallic insert, high type,
with metric fine pitch thread

ISO 10513
(DIN 980***)

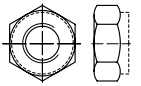

Sechskantmuttern mit Klemmteil,
mit metrischem Feingewinde,
Ganzmetallmuttern
Prevailing torque type hexagon nuts
with metric fine pitch thread, all-metal

ISO 10642
(DIN 7991**)

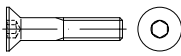

Senkschrauben mit Innensechskant
Hexagon socket countersunk head screws

~ISO 10642
ISR

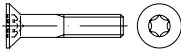

Senkschrauben mit Innensechsrund
Hexalobular socket countersunk head screws

DIN 11023

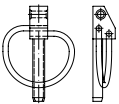

Klappstecker
Linch pins

~DIN 11023

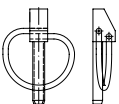

Klappstecker ohne drittes Loch
Linch pins without third hole



Artikel 88023
Rohrklappstecker
Linch pins for tubes

DIN 11024

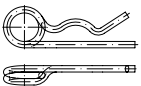

Federstecker
Spring cotters for a bolt

~DIN 11024



Federstecker, einfache Windung
Spring cotters for a bolt, single type

ISO 12474
(DIN 912*)



Zylinderschrauben mit Innensechskant,
mit metrischem Feingewinde
Hexagon socket head cap screws with metric fine pitch thread

ISO 13337
(DIN 7346**)



Spannstifte (-hülsen), geschlitzt,
leichte Ausführung
Spring-type straight pins, slotted, light duty

EN 14399
-4/-6
(DIN 6914-
6916)

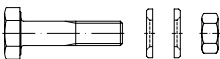

Hochfeste planmäßig vorgespannte
Schraubenverbindungen für den Stahlbau
Assemblies of hexagon bolts, nuts and washers
for high-strength structural bolting, system HV



Artikel 88916
Sicherungsmuffen für HV-Schrauben
Safety sockets
for high-strength structural bolting assemblies

Stahl/ Stahl mit Überzug	Nicht- rostende Stähle	Ms Cu Al Ti Kunststoff	Befesti- gungs- technik	Maße TI
388	586	643		9
389				9
389				9
389	587			14
392				
394				123
394				123
394				123
395	589			123
395	589			123
395				12
396				122
397				58
402				59

* DIN/ISO identisch = austauschbar

** DIN/ISO/EN
weitgehend austauschbar

*** DIN/ISO-Umstellung → Rote Seiten
„Technische Informationen“

Stahl/ Stahl mit Überzug	Nicht- rostende Stähle	Ms Cu Al Ti Kunststoff	Befesti- gungs- technik	Maße TI
--------------------------------	------------------------------	------------------------------	-------------------------------	------------

DIN/ISO/EN

Genormte Artikel/ Standardized Products

EN 14399-8 (DIN 7999)		Sechskant-Passschrauben für HV-Verbindungen (HVP-Schrauben) Hexagon fit bolts with large head for high-strength structural bolting, system HV
ISO 14579 (DIN 912 ISR*)		Zylinderschrauben mit Innensechsrund Hexalobular socket head cap screws
ISO 14580 (→ DIN 7984 ISR*)		Zylinderschrauben mit Innensechsrund, mit niedrigem Kopf Hexalobular socket head cap screws with low head
ISO 14581		Senkschrauben mit Innensechsrund Hexalobular socket countersunk head screws
ISO 14583 (DIN 7985 ISR)		Linsenschrauben mit Innensechsrund Cheese head screws with hexalobular socket
ISO 14585 (DIN 7981 ISR)		Linsen-Blechschraben mit Innensechsrund Pan head tapping screws with hexalobular socket
ISO 14586 (DIN 7982 ISR)		Senk-Blechschraben mit $\sphericalangle = 90^\circ$, mit Innensechsrund Countersunk head tapping screws with $\sphericalangle = 90^\circ$, with hexalobular socket
DIN 15058		Achshalter (für Hebezeuge) Axle holders (for lifting appliances)
DIN 15237		Tellerschrauben („Gurt-“, „Becherschrauben“) Seating screws with cupped washer, for attachment of components to belts
ISO 15480 (DIN 7504*)		Sechskant-Bohrschrauben mit Bund, mit Blechschrabengewinde Hexagon washers head drilling screws with tapping screw thread
ISO 15481 (DIN 7504*)		Flachkopf-Bohrschrauben mit Blechschrabengewinde Pan head drilling screws with tapping screw thread
ISO 15482 (DIN 7504***)		Senk-Bohrschrauben mit Blechschrabengewinde, Senk $\sphericalangle = 90^\circ$ Countersunk head drilling screws with tapping screw thread, countersunk $\sphericalangle = 90^\circ$
ISO 15975- 16858 (DIN 7337)		Blindniete → Artikel 88401-88488 Blind rivets
EN 16983 (DIN 2093*)		Tellerfedern Disc springs
DIN 22424		Dreikantschrauben Triangle head bolts
DIN 28129		Bügelmuttern Clamp nuts (lifting nuts)
DIN 34805-1 (~ISO 7380-1 ISR)		Flachkopfschrauben mit Innensechsrund Hexalobular socket button head screws

Stahl/ Stahl mit Überzug	Nicht- rostende Stähle	Ms Cu Al Ti Kunststoff	Befesti- gungs- technik	Maße TI
402				58
402				12
364				13
403	589			15
403	590			40
404	590			46
405	591			47
407				137
407				35
406				42
406				42
406				42
			689	205
407	591			141
408				35
408				129
343	572			14

* DIN/ISO identisch = austauschbar	** DIN/ISO/EN weitgehend austauschbar	*** DIN/ISO-Umstellung → Rote Seiten „Technische Informationen“	Stahl/ Stahl mit Überzug	Nicht- rostende Stähle	Ms Cu Al Ti Kunststoff	Befesti- gungs- technik	Maße TI
------------------------------------	---------------------------------------	---	--------------------------------	------------------------------	------------------------------	-------------------------------	------------

DIN/ISO/EN

Genormte Artikel/
Standardized Products

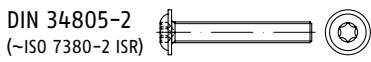

DIN 34805-2
(~ISO 7380-2 ISR) Flachkopfschrauben mit Innensechsrund,
mit angepresster Scheibe
Hexalobular socket button head screws with flange

Verbindungselemente aus Kunststoff
Plastic Fasteners

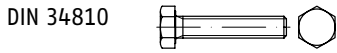

DIN 34810 Sechskantschrauben aus Kunststoff → DIN 933
Hexagon head plastic screws → DIN 933

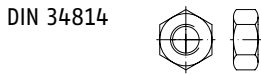

DIN 34814 Sechskantmuttern aus Kunststoff → DIN 555
Hexagon plastic nuts → DIN 555

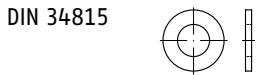

DIN 34815 Scheiben aus Kunststoff, normale Reihe → DIN 125
Plastic washers, normal series → DIN 125



DIN 34816 Scheiben aus Kunststoff, große Reihe → DIN 9021
Plastic washers, large series → DIN 9021

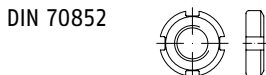

DIN 70852 Nutmuttern
Locknuts for hook spanners

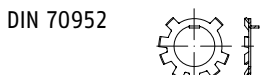

DIN 70952 Sicherungsbleche für Nutmuttern
Lockwashers/safety plates for locknuts

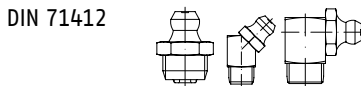

DIN 71412 Schmiernippel
Lubricating nipples



DIN 71752 Gabelköpfe
Fork joints

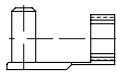

Artikel 88752
ES-/Federklappbolzen
Spring flap bolts ("ES bolts")

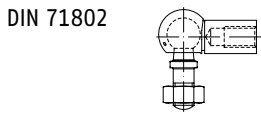

DIN 71802 Winkelgelenke
Angle joints (ball joints)

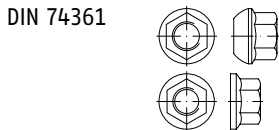

DIN 74361 Kugelbundmuttern A,
Flachbundmuttern B
Nuts with spherical collar (type A),
Flat collar nuts (type B)

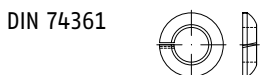

DIN 74361 Federringe C (Limesringe)
Spherical springwashers (type C)

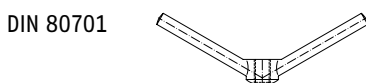

DIN 80701 Knebelmuttern
Butterfly nuts

Stahl/ Stahl mit Überzug	Nicht- rostende Stähle	Ms Cu Al Ti Kunststoff	Befesti- gungs- technik	Maße TI
344	573			14
		625		15
		621		62 (~ISO 4032)
		617		84
		643		
408				76
409				102
409	592			25
409				124
410				124
410				
410 410				
410				102
		644		129

* DIN/ISO identisch = austauschbar	** DIN/ISO/EN weitgehend austauschbar	*** DIN/ISO-Umstellung → Rote Seiten „Technische Informationen“	Stahl/ Stahl mit Überzug	Nicht- rostende Stähle	Ms Cu Al Ti Kunststoff	Befesti- gungs- technik	Maße TI
------------------------------------	---------------------------------------	---	--------------------------------	------------------------------	------------------------------	-------------------------------	------------

DIN/ISO/EN

Genormte Artikel/
Standardized Products

DIN 80704

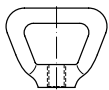

Korbmuttern
Bow nuts

DIN 82101

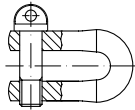

Schäkel, geschmiedet
D-shackles, forged

MBN 10105

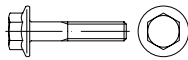

Sechskantschrauben mit Flansch
nach MBN 10105
Hexagon head bolts with flange acc. to MBN 10105

MBN 13023

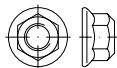

Sechskantmuttern mit Flansch
nach MBN 13023
Prevailing torque type hexagon nuts
with flange acc. to MBN 13023

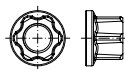

Artikel 13024
Leichtbaumuttern mit Flansch
Lightweight construction nuts

Verbindungselemente nach ASME/ANSI Normen
Fasteners acc. to ASME/ANSI standards

ASME
B18.2.1

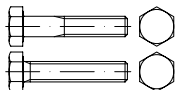

Sechskantschrauben mit Schaft/Vollgewinde,
mit UNC-/UNF-Gewinde
Hex cap screws with shank/full thread, with UNC/UNF thread

ASME
B18.2.2

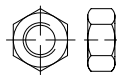

Sechskantmuttern mit UNC-/UNF-Gewinde
Hex nuts with UNC/UNF thread

ASME
B18.2.2

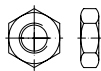

Niedrige Sechskantmuttern mit UNC-/UNF-
Gewinde
Hex jam nuts with UNC/UNF thread

ANSI
B18.22.1

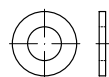

Flache Scheiben
für Schraubverbindungen mit UNC-/UNF-Gewinde
N = narrow (kleine Ausführung)
W = wide (große Ausführung)
Plain washers
N = narrow, W = wide

ASME
B18.3









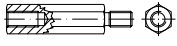

Zylinderschrauben mit UNC-Gewinde,
mit Innensechskant
Hexagon socket head cap screws with UNC thread

Stahl/ Stahl mit Überzug	Nicht- rostende Stähle	Ms Cu Al Ti Kunststoff	Befesti- gungs- technik	Maße TI
	592	644		129
410				134
388				17
396				69
396				65
410				16
414	592			61
415				61
415				85
415				13

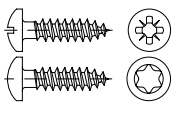
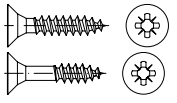
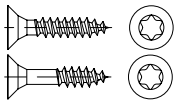
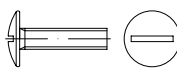
* DIN/ISO identisch = austauschbar	** DIN/ISO/EN weitgehend austauschbar	*** DIN/ISO-Umstellung → Rote Seiten „Technische Informationen“	Stahl/ Stahl mit Überzug	Nicht- rostende Stähle	Ms Cu Al Ti Kunststoff	Befesti- gungs- technik	Maße TI
------------------------------------	---------------------------------------	---	--------------------------------	------------------------------	------------------------------	-------------------------------	------------

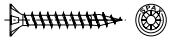

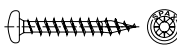
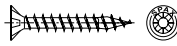







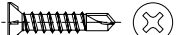
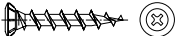
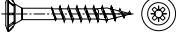
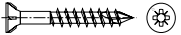

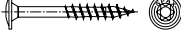
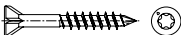
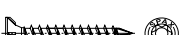

Artikel-Nr.

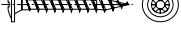
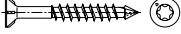
**Nicht genormte Schrauben/
Non Standardized Screws and Bolts**

Artikel-Nr.			Stahl/ Stahl mit Überzug	Nicht- rostende Stähle	Ms Cu Al Ti Kunststoff	Befesti- gungs- technik	Maße TI
88086		Abstands-/Distanz-Bolzen, Sechskant (Distanzhalter, Verbindungsstücke) Spacers with thread and with hexagon	416				35
88095		Spanplattenschrauben mit Linsensenkkopf und Pozidriv-Kreuzschlitz Z Chipboard screws with raised countersunk head and Pozidriv cross recess Z			645		
89096		Spanplattenschrauben mit Halbrundkopf, mit CE - Pozidriv-Kreuzschlitz Z - Innensechsrund-Antrieb Chipboard screws with pan head, with CE - Pozidriv cross recess Z - Hexalobular socket	447	607			52
89097		Spanplattenschrauben mit Senkkopf, mit Pozidriv-Kreuzschlitz Z, mit CE Chipboard screws with countersunk head, with Pozidriv cross recess Z, with CE	448	607			52
89098		Spanplattenschrauben mit Senkkopf, mit Innensechsrund-Antrieb, mit CE Chipboard screws with countersunk head, with hexalobular socket, with CE	449	608			52
88107		Flachrundschraben mit Schlitz (Bordwandschrauben) Slotted mushroom head screws	428	596			41
							
88099		Spanplattenschrauben/-SPAX-Schrauben, Senkkopf, mit Pozidriv-Kreuzschlitz Z und Innenloch SPAX chipboard screws with countersunk head, with Pozidriv cross recess Z and center hole	424				
88091		SPAX-Schrauben/ Holzbauschrauben bis 12 x 600, Senkkopf, mit Innenstern-Antrieb SPAX chipboard screws with countersunk head, with hexalobular socket	417	593			
88092		SPAX-Schrauben mit Pozidriv-Kreuzschlitz Z, Innenstern-Antrieb, mit Linsensenkkopf SPAX chipboard screws with raised countersunk head, with Pozidriv cross recess Z, hexalobular socket	420	593			
88093		SPAX-Schrauben mit Pozidriv-Kreuzschlitz Z, Innenstern-Antrieb, mit Halbrundkopf SPAX chipboard screws with pan head, with Pozidriv cross recess Z, hexalobular socket	421	593			
88094		SPAX-Schrauben mit Pozidriv-Kreuzschlitz Z, mit Senkkopf SPAX chipboard screws with countersunk head, with Pozidriv cross recess Z	421				
88094		„Scharnierband-Schrauben“, Spanplattenschrauben/-SPAX-Schrauben, mit kleinem Senkkopf, mit Pozidriv-Kreuzschlitz Z SPAX chipboard screws with small countersunk head, with Pozidriv cross recess Z	421				
			Stahl/ Stahl mit Überzug	Nicht- rostende Stähle	Ms Cu Al Ti Kunststoff	Befesti- gungs- technik	Maße TI

Artikel-Nr.

Nicht genormte Schrauben/ Non Standardized Screws and Bolts

88187		SPAX Fensterbauschrauben FEX Typ A = Fensterbohrschrauben
88188		Typ KS = Beschlagschrauben
88189		Typ H = Holzfensterschrauben SPAX window air screws FEX
88190		SPAX Glasleistenschrauben SPAX glass strip screws
88191		SPAX Pfostenschrauben SPAX post screws
88192		SPAX Schrauben mit Fixiergewinde für Terrassen-Dielen SPAX screws with fixing thread for terraces planks
88193		SPAX Schrauben mit Tellerkopf SPAX screws with flange head
88195		SPAX Schrauben mit Fräskopf für Massivholzfußböden SPAX screws with milling head for solid timber floors
88196		SPAX Schrauben mit Vollgewinde und MULTI-Senkopf SPAX screws fully threaded and MULTI countersunk head
88197		SPAX Rückwandschrauben SPAX screws with flange head for back boards
88198		SPAX Schrauben MDF-Materialien SPAX screws for MDF boards
89015		SPAX Verlegeschrauben mit Fixiergewinde SPAX flooring screws with fixing thread
89010		SPAX Rahmenanker RA mit Innenstern-Antrieb
89011		Seko = mit Senkkopf Zyko = mit Zylinderkopf SPAX frame anchors RA
89014		SPAX Schrauben für Holz, Glas und Fassaden SPAX screws for wood, glass and frames
89018		SPAX Fassadenschrauben mit Linsenkopf SPAX facade screws with raised countersunk head
89019		SPAX Fassadenschrauben mit Linsenkopf und Fixiergewinde SPAX facade screws with raised countersunk head and fixing thread
88001		Zierkappen mit Stift Caps with pin
89012		Zierkappen für SPAX Rahmenanker RA Caps for SPAX frame anchors RA
89013		SPAX Zierkappen mit Stift SPAX caps with pin
89021		SPAX Schrauben-Sortiment SPAX screws assortment

Stahl/ Stahl mit Überzug	Nicht- rostende Stähle	Ms Cu Al Ti Kunststoff	Befesti- gungs- technik	Maße TI
426				
	594			
	594			
	594			
424	594			
425				
420				
425				
425				
427				
426				
426				
	595			
	595			
424				
426				
424				
420				
Stahl/ Stahl mit Überzug	Nicht- rostende Stähle	Ms Cu Al Ti Kunststoff	Befesti- gungs- technik	Maße TI

Artikel-Nr.

**Nicht genormte Schrauben/
Non Standardized Screws and Bolts**

88654 
88663

SPAX Bit-Sortimente
SPAX bit assortments

89017 

SPAX Einschraubhülsen für
SPAX Gewindestangen ohne Kopf
SPAX assembly tools for SPAX threaded rods without head

**Verbindungselemente
für den tragenden Holzbau
Fasteners for timber construction**

89091 

Holzbauschrauben mit Senkkopf,
mit Innensechsrund-Antrieb, mit CE
Wood building screws with countersunk head,
with hexalobular socket, with CE

89184 

Senkscheiben für Holzbauschrauben mit CE
Countersunk washers for Wood building screws with CE

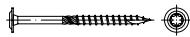

Holzbauschrauben mit Tellerkopf,
mit Innensechsrund-Antrieb, mit CE
Wood building screws with flange head,
with hexalobular socket, with CE

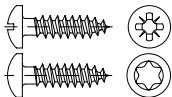
89096 

Spanplattenschrauben mit Halbrundkopf, mit CE
- Kreuzschlitz
- Innensechsrund-Antrieb
Chipboard screws with pan head
- Pozidriv cross recess Z
- Hexalobular socket

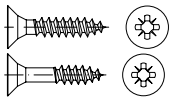
89097 

Spanplattenschrauben mit Senkkopf,
Pozidriv-Kreuzschlitz Z, mit CE
Chipboard screws with countersunk head,
with Pozidriv cross recess Z, with CE

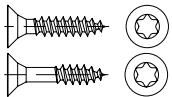
89098 

Spanplattenschrauben mit Senkkopf,
mit Innensechsrund-Antrieb, mit CE
Chipboard screws with countersunk head,
with hexalobular socket, with CE

89571 

Sechskantholzschrauben mit CE
Hexagon wood screws with CE

89601 

Baubolzen mit Sechskantmutter mit CE
Bolts with hexagon nut, with CE

**Schrauben für Gipsplattensysteme
mit CE nach EN 14566
Screws for plasterboard systems
with CE according to EN 14566**

89150 

Schnellbauschrauben mit Phillips-Kreuzschlitz H,
mit Trompetenkopf und Grobgewinde, mit CE
Drywall screws with Phillips cross recess H,
with flat bugle head and coarse thread, with CE

89151 

Schnellbauschrauben mit Phillips-Kreuzschlitz H,
mit Trompetenkopf und Feingewinde, mit CE
Drywall screws with Phillips cross recess H,
with flat bugle head and fine pitch thread, with CE

89152 









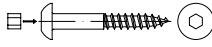
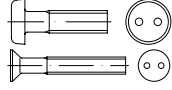

Schnellbauschrauben mit Phillips-Kreuzschlitz H,
mit Trompetenkopf und Bohrspitze, mit CE
Drywall screws with Phillips cross recess H,
with flat bugle head and drilling point, with CE

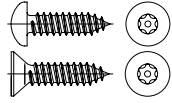
Stahl/ Stahl mit Überzug	Nicht- rostende Stähle	Ms Cu Al Ti Kunststoff	Befesti- gungs- technik	Maße TI
			688	
			688	
446				52
447				115
447				53
447	607			52
448	607			52
449	608			52
450				51
450				15
450				53
451				53
451				53
451				53
Stahl/ Stahl mit Überzug	Nicht- rostende Stähle	Ms Cu Al Ti Kunststoff	Befesti- gungs- technik	Maße TI

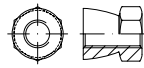
Artikel-Nr.

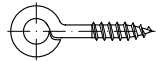
Nicht genormte Schrauben/ Non Standardized Screws and Bolts

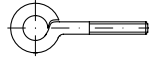
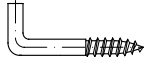
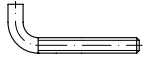
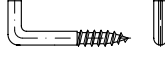
Befestigungselement mit diebstahl- /vandalismus- hemmenden Antrieben Fasteners with Theft Resistant Drives

Artikel-Nr.	Befestigungselement mit diebstahl- /vandalismus- hemmenden Antrieben Fasteners with Theft Resistant Drives	Stahl/ Stahl mit Überzug	Nicht- rostende Stähle	Ms Cu Al Ti Kunststoff	Befesti- gungs- technik	Maße TI
88110	 Holzschrauben mit Innensechskant und Vernietungsstift Wood screws thread with hexagon socket and rivet pin	429				
88111 88112	 Senkkopf-/Panheadschrauben mit Zweiloch-Antrieb, metrisches Gewinde Pan head/countersunk head screws with snake eyes drive, metric thread		596			27
88113	 Flachrundschrauben mit Innensechskant und Innenzapfen, metrisches Gewinde Button head screws with hexagon socket and pin, metric thread		597			27
88114 88115	 Linsenkopf-Schrauben, Senkkopf-Schrauben mit Innensechsrund-Antrieb mit Zapfen („Pin-ISR“), Blechschrauben-Gewinde Pan head/countersunk head screws with hexalobular socket and pin, tapping screw thread		597			48
88116 88117	 Flachrundkopf-Schrauben, Senkkopf-Schrauben mit Innensechsrund-Antrieb, mit Zapfen („Pin-ISR“), metrisches Gewinde Button head/countersunk head screws with hexalobular socket and pin, metric thread		598			26
88118	 Abreiß-Muttern für Einwegmontage Theft resistant nuts/pull-off nuts for one-way assembly		598			
	 Spezial-Bits → Schraubtechnik Artikel 88665-88667 Special bits				688	
88133	 Ringschraubösen mit Holzschrauben-Gewinde Screw eyes with wood screw thread	434				54
88135	 S-Haken S-hooks	434				137
88136	 Gewindeösen mit metrischem Gewinde Screw eyes with metric thread	434	601			36
88137	 Gerade Schraubhaken mit Holzschrauben-Gewinde Square bend screw hooks with wood screw thread	435				54
88138	 Gerade Schraubhaken mit metrischem Gewinde Straight screw hooks with metric thread	435				36
88139	 Schlitzschraubhaken mit Holzschrauben-Gewinde Square bend slotted screw hooks with wood screw thread	435				55
88140	 Gebogene Schraubhaken mit Holzschrauben-Gewinde Cup hooks with wood screw thread	435				55





Artikel-Nr.

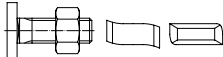

Nicht genormte Schrauben/
Non Standardized Screws and Bolts

Artikel-Nr.	Bild	Bezeichnung	Stahl/ Stahl mit Überzug	Nicht- rostende Stähle	Ms Cu Al Ti Kunststoff	Befesti- gungs- technik	Maße TI
88141		Gebogene Schraubhaken mit Holzschrauben-Gewinde, weiß lackiert Cup hooks with wood screw thread, white painted	435				55
88142		Gebogene Schraubhaken mit metrischem Gewinde Cup hooks with metric thread	435				36
88143		Winkelschraubhaken mit Holzschrauben-Gewinde, mit Innensechsrund-Antrieb Right angle screw hooks with wood screw thread, with hexalobular socket	436				55
88144		Starke Deckenhaken, gewundene Form, mit Holzschrauben-Gewinde Heavy duty screw eyes, spiral type, with wood screw thread	436				56
88145		Starke Deckenhaken, gewundene Form, mit metrischem Gewinde Heavy duty screw eyes, spiral type, with metric thread	436				37
88149		Stockschrauben Hanger bolts	436	601			
88176 88276		Fassadenschrauben mit Dichtscheibe Tapping screws for facing with assembled sealing washer		602			50
88200 88202 88203 88204		Gewindefurchende Schrauben für Kunststoffe mit Linsenkopf, mit Innensechsrund Pan head screws with screw thread for plastic (thermoplastics), with hexalobular socket	436				48 - 49
88296		SPENGLER-Schrauben Linsenkopf-Holzschrauben mit Innensechsrund, mit aufgesteckter Scheibe und Dichtscheibe SPENGLER screws, raised countersunk head, wood screws with hexalobular socket, including rosettes and sealing washer		603			
88312		Zylinder-Blechschraben mit Innensechskant Cylindrical head tapping screws with hexagon socket		574			50
88902- 88908		MULTI-MONTI MMSplus Schraubanker, Stockanker, Mauerschrauben MULTI-MONTI MMSplus screw-in-anchors, wall screws				687	202 - 203
88912		RIPP-Schrauben mit Innensechskant Hexagon socket head cap screws with flange and lock ribs	438				28
88913		RIPP-Sechskantschrauben Hexagon head screws with flange and lock ribs	438				28
88933		Sperrzahn-Schrauben Hexagon head locking screws with flange	441				28

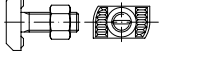
Artikel-Nr.

Nicht genormte Schrauben/ Non Standardized Screws and Bolts

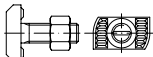
88928  Hammerkopf-/HALFEN-Schrauben HS
 88938  T-head bolts/HALFEN bolts HS
 88940 
 88950 
 88972 

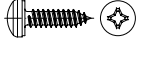
88941  Hammerkopf-/HALFEN-Schrauben HZS
 88943  T-head bolts HZS
 88944 

88981  Kappenkopf Blechschrauben
 Cap-head tapping screws

Nicht genormte Muttern und Gewindeeinsätze/ Non Standardized Nuts and Inserts

84032  BILOC-Muttern/Sechskantmuttern mit Klemmteil
 BILOC nuts/prevaling torque type hexagon nuts

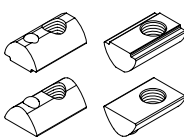
87010  Muttern für T-Nuten, Profil 5 mm
 - mit Führungssteg
 - ohne Führungssteg
 T-Slot nuts, profile 5 mm
 - with raised center
 - without raised center

87011  Muttern für T-Nuten, Profil 6 mm,
 mit außenliegendem Führungssteg
 T-Slot nuts, profile 6 mm,
 with peripheral guiding ridge

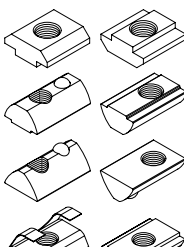
87012  Muttern für T-Nuten, Profil 8 mm
 - mit Führungssteg
 - mit Führungssteg und Kugel
 - ohne Führungssteg, mit Kugel
 - ohne Potentialausgleich, mit Feder
 T-Slot nuts, profile 8 mm
 - with raised center
 - with raised center and ball
 - without raised center, with ball
 - without equipotential bonding, with spring

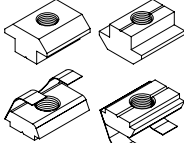
87013  Muttern für T-Nuten, Profil 10 mm
 - mit Führungssteg
 - ohne Potentialausgleich, mit Feder
 T-Slot nuts, profile 10 mm
 - with raised center
 - without equipotential bonding, with spring

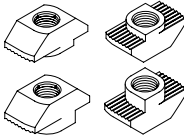

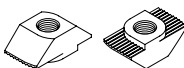



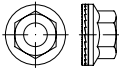
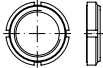
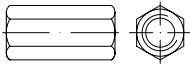

87014  Hammerkopfmutter für Profil 8 mm
 - niedrige Form
 - hohe Form
 Hammer head nuts for profile 8 mm
 - low center
 - high center

87015  Hammerkopfmutter für Profil 10 mm,
 niedrige Form
 Hammer head nuts for profile 10 mm, low center

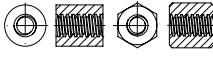
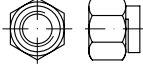
Stahl/ Stahl mit Überzug	Nicht- rostende Stähle	Ms Cu Al Ti Kunststoff	Befesti- gungs- technik	Maße TI
442	606			
443	606			
360	577			
200	510			62
445				154
445				154
445				155
446				155
446				155
446				155
Stahl/ Stahl mit Überzug	Nicht- rostende Stähle	Ms Cu Al Ti Kunststoff	Befesti- gungs- technik	Maße TI

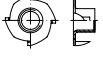
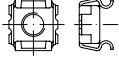
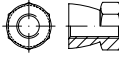
Artikel-Nr.

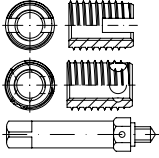
**Nicht genormte Muttern und Gewindeeinsätze/
Non Standardized Nuts and Inserts**

88034		HEICO-LOCK Keilsicherungsmuttern HLM HEICO-LOCK wedge lock nuts HLM
88081		Nutmutter mit Klemmteil GUK Locknuts with non-metallic insert GUK
88087		Verbindungs-muffen, Sechskant Hexagon couplings
88088		Verbindungs-muffen, rund Round couplings
88089 88090		Trapezgewinde-Muttern rund, sechskantig Round and hexagon nuts with trapezoidal thread
88105		THERMAG-Muttern, Ganzmetallmutter mit Klemmteil THERMAG nuts, all-metal nuts with prevailing torque type hexagon nuts
88106		Setzmutter Rivet nuts
88108		Einschlagmutter Tee nuts with prong
88109		Käfigmutter Square caged nuts
88118		Diebstahl-/vandalismus-hemmende Mutter, Abreiß-Mutter für Einwegmontage Theft resistant nuts/pull-off nuts for one-way assembly
88153		RUV-Mutter RUV captivity nuts
88215		Flügelmutter, kleine „amerikanische“ Form Wing nuts, small "American" type
88302 88305 88307		ENSAT-Gewindeeinsätze, kurz, lang, Setzwerkzeuge für ENSAT-Gewindeeinsätze ENSAT threaded inserts, short, long, setting tools for ENSAT threaded inserts
88330 88331- 88346		AMECOIL-Gewindeeinsätze, Regelgewinde, Feingewinde, selbstsichernd, Setzwerkzeuge für AMECOIL-Gewindeeinsätze AMECOIL wire thread inserts, coarse thread, fine pitch thread, self locking, setting tools
88342 88344		Sortimentskästen mit AMECOIL-Gewindeeinsätzen AMECOIL assortment boxes with threaded inserts

Stahl/ Stahl mit Überzug	Nicht- rostende Stähle	Ms Cu Al Ti Kunststoff	Befesti- gungs- technik	Maße TI
434				69
416				76
417	592			66
417	592			77
417	592			77
199				70
428	596			78
428				78
428				78
	598			
	602			
78	464			79
437	603			152
	603			151
	605			

Stahl/ Stahl mit Überzug	Nicht- rostende Stähle	Ms Cu Al Ti Kunststoff	Befesti- gungs- technik	Maße TI
--------------------------------	------------------------------	------------------------------	-------------------------------	------------

Artikel-Nr.

Nicht genormte Muttern und Gewindeeinsätze/ Non Standardized Nuts and Inserts



88914 RIPP-Muttern
Hexagon locking nuts with lock ribs



88934 Sperrzahn-Muttern, oberflächengehärtet
Hexagon locking nuts, surface hardened

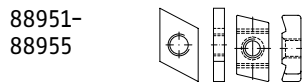

88951-88955 Gewindeplatten/Gleitmuttern für (Halben-) Profile
T-head thread plates/slide nuts for (Halfen-) profiles



88964 Hülsenmuttern mit Innengewinde
Sleeve nuts with internal thread

Nicht genormte Zubehörteile/ Non Standardized Accessories



88001 Zierkappen für SPAX-/Spanplatten-
schrauben, Senkkopf mit Innenloch
Caps with pin for chipboard screws
for SPAX screws with inner hole



88002 Zierkappen für Senkkopfschrauben
mit Pozidriv-Kreuzschlitz Z
Caps with pin for chipboard screws with Pozidriv cross recess Z

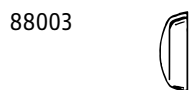

88003 Zierkappen für Kappenschrauben
Artikel 88981 Ø 3,9
Decorative caps for cap screws article 88981 Ø 3,9



88004 Zierkappen für Senkkopfschrauben
mit Phillips-Kreuzschlitz H
Caps with pin for chipboard screws for Philips cross recess H



88005 Kombi-Dichtungen (Regenhütchen) für
Sechskant-Holzschrauben 7 mm Ø,
für Welldachplatten
Plastic sealings and caps for hexagon wood screws,
7 mm Ø for corrugated roof panels

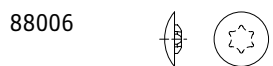

88006 Zierkappen für Senkkopfschrauben
mit Innensechsrund/Innenstern
Caps for countersunk head screws
with hexalobular/star socket

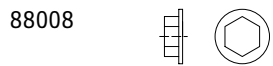

88008 Abdeck-Kappen für Fassadenschrauben
Caps for tapping screws for facing



88023 Rohrklappstecker
Linch pins for tubes











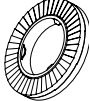

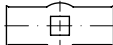
88032 HEICO-LOCK Scheiben-Paare
HLS = normale Auflagefläche
HLB = mit größerer Auflagefläche
HLK = für HV-Schraubverbindungen
HEICO-LOCK washers pairs

Stahl/ Stahl mit Überzug	Nicht- rostende Stähle	Ms Cu Al Ti Kunststoff	Befesti- gungs- technik	Maße TI
440				70
442				70
444				79
	607	647		79
		424		
		427		
		360		
		361		
		645		
		420		
	602			
394				123
433	600			103
Stahl/ Stahl mit Überzug	Nicht- rostende Stähle	Ms Cu Al Ti Kunststoff	Befesti- gungs- technik	Maße TI

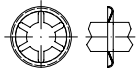
Artikel-Nr.

**Nicht genormte Zubehörteile/
Non Standardized Accessories**

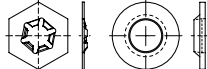





Artikel-Nr.	Zeichnung	Bezeichnung
88033		HEICO-LOCK Ringsicherungsscheiben HLRS = normale Auflagefläche HLRB = mit größerer Auflagefläche HEICO-LOCK ring lock washers
88035		HEICO-LOCK Kombischeiben HKS = normale Auflagefläche HKB = mit größerer Auflagefläche HEICO-LOCK combi-washers
88100		Flache Scheiben „Artikel 1“ Washers "Article 1"
88101		„Cupal“- Scheiben Plain washers/"Cupal" washers
88102		Fugenscheiben zur Verwendung mit Schrauben nach DIN 603 Joint washers to use with cup head square neck bolts according to DIN 603
88104		Kotflügelscheiben Washers with large outside diameter
88119		LOCKTIX-Scheiben LOCKTIX washers
88120 88121		SCHNORR-Sperrzahnscheiben, beidseitig verzahnt, S, VS SCHNORR safety washers with serrations on both sides, S, VS
88122		Achsen-Klemmringe Axle locking rings
88123 88124 88125 88126		TECKENTRUP-Sperrkantscheiben für Sechskantschrauben und Zylinderschrauben mit Innensechskant TECKENTRUP lock washers for hexagon head screws and hexagon socket head cap screws
88129		TECKENTRUP-Sperrkantscheiben mit Kontaktzähnen TECKENTRUP lock washers with contact serrations
88130 88131		Sperrkantringe Lock rings
88132		NORD-LOCK Scheiben-Paare Standard = normale Auflagefläche SP = mit größerer Auflagefläche SC = für HV-Verbindungen X-series = Keilsicherungsfederscheiben® NORD-LOCK washers pairs
88151 88152		RUV-Scheiben RUV captivity washers

Stahl/ Stahl mit Überzug	Nicht- rostende Stähle	Ms Cu Al Ti Kunststoff	Befesti- gungs- technik	Maße Ti
433				103
434	601			104
427				84
		645		
427				113
428	596			85
432				104
429	598			104
430				114
430	599			105
431	600			106
431	600			107
432	600			107
	602	645		

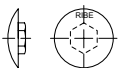
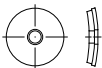

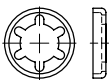
Stahl/ Stahl mit Überzug	Nicht- rostende Stähle	Ms Cu Al Ti Kunststoff	Befesti- gungs- technik	Maße Ti
--------------------------------	------------------------------	------------------------------	-------------------------------	------------

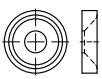
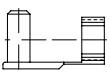
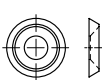
Artikel-Nr.

Nicht genormte Zubehörteile/ Non Standardized Accessories

88251		Käppi für Innensechskantschrauben Caps for hexagon socket head screws
88277		Dichtscheiben (gewölbte Metallscheiben mit aufvulkanisierter Dichtscheibe) Sealing washers (convex metal washers with vulcanised sealing)
88494 88495		DUBO Profil-Scheiben DUBO profile washers
88496		DUBO Zahntellerringe DUBO lock washers
88497		KORREX Schutzkappen KORREX protection caps
88498		KORREX Isolierhülsen KORREX insulating tubes
88499		KORREX Rosetten KORREX rosettes
88752		ES-/Federklappbolzen für Gabelköpfe nach DIN 71752 Spring flap bolts ("ES bolts") for yokes according to DIN 71752
88965 88966		Rosettenscheiben Rosettes/finishing washers
89184		Senkscheiben für Holzbauschrauben mit CE Countersunk washers for Wood building screws with CE

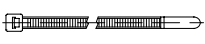
Kabelbinder/ Cable ties





82500 82505 82510 82515		Kabelbinder, innenverzahnt T-Serie = Standard Cable ties, inside serrations, T series = standard
82520		Kabelbinder, innenverzahnt LK-Serie = erhöhte Abbindekraft Cable ties, internal serrations, LK series = higher tensile strength
82516		Kabelbinder, außenverzahnt Robusto-Serie = mit flacher Kopfgeometrie Cable ties, outside serrations Robusto series = with flat head

Stahl/ Stahl mit Überzug	Nicht- rostende Stähle	Ms Cu Al Ti Kunststoff	Befesti- gungs- technik	Maße TI
		645		
	603	646		
		646		109 110
		646		110
		646		
		646		114
		647		114
410				124
		647		115
447				115
			649	144
			649	145
			649	145

Stahl/ Stahl mit Überzug	Nicht- rostende Stähle	Ms Cu Al Ti Kunststoff	Befesti- gungs- technik	Maße TI
--------------------------------	------------------------------	------------------------------	-------------------------------	------------

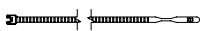
Artikel-Nr.

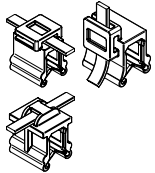
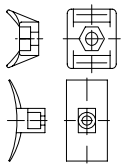
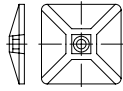
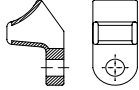
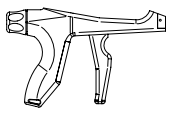
**Kabelbinder/
Cable ties**

82517		Kabelbinder, innenverzahnt Q-tie = mit offenem Bindekopf und Vorverriegelung Cable ties, inside serrations Q-tie = with open head and pre-locking functionality
82518		Kabelbinder mit Befestigungselement Coupler = zur Parallelführung 2-piece fixing ties, Coupler = for parallel separation
82521 82522 82523		Kantenbefestigungsbinder EdgeClip-Family Fixing ties for edges - EdgeClip-Family
82543 82546		Befestigungssockel für Kabelbinder, schraubbar Cable tie mounts, screwable
82540 82550 82553 82554		Befestigungssockel für Kabelbinder, selbstklebend Cable tie mounts, self adhesive
82560		Befestigungsösen für Kabelbinder Cable tie mounts
82535		Manuelle Abbindewerkzeuge für Kabelbinder Manual application tools for cable ties
82580		Kabelbündelschläuche Cable conduits
82565		Sortimentsboxen mit Befestigungsteilen für Kabelbinder Assortment boxes with cable tie mounts





**Verbindungs- und Klemmsysteme/
Fastener and Fixing Systems**

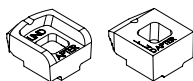

**LINDAPTER Klemmen
LINDAPTER clamps**

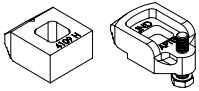
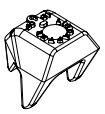
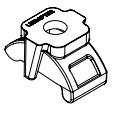
82001 82002 82040		Typ A, B Typ AF-K
-------------------------	---	----------------------

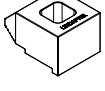
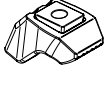
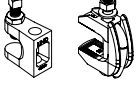
Stahl/ Stahl mit Überzug	Nicht- rostende Stähle	Ms Cu Al Ti Kunststoff	Befesti- gungs- technik	Maße TI
			650	145
			650	146
			650	146
			651	148
			651	148
			652	149
			651	
			652	
			652- 655	158
Stahl/ Stahl mit Überzug	Nicht- rostende Stähle	Ms Cu Al Ti Kunststoff	Befesti- gungs- technik	Maße TI

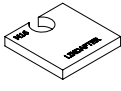
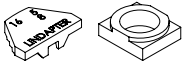
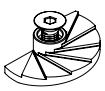
Artikel-Nr.	Verbindungs- und Klemmsysteme/ Fastener and Fixing Systems	Stahl/ Stahl mit Überzug	Nicht- rostende Stähle	Ms Cu Al Ti Kunststoff	Befesti- gungs- technik	Maße TI			
82003 82007	 Typ BS, D2, (D3)				659	158			
82045	 Typ CF				656	159			
82010	 Typ LR				657	158			
82046	 Typ LS				658	159			
82048	 Typ BR				658	159			
82049	 Typ AAF				656	156			
82008 82009 82022 82025 82058	 Typ FL-D, FL-M, FL-S, F9, LC, F3				661	159			
LINDAPTER Zubehörteile LINDAPTER accessories									
82011 82012- 82016 82042- 82044	 Typ CW, P, Typ AF-CW, AF-P				654	158			
82047	 Typ LS-P2				658	159			
82021 82041	 Typ W Typ AFW	655	158						
LINDAPTER Bodenbefestigungen LINDAPTER floor fixings									
82019	 LINDAPTER-FLOOR-FAST Typ FF Bodenplatten-Befestigungen LINDAPTER-FLOOR-FAST-FF for floor plate fixings	661	159						
		Stahl/ Stahl mit Überzug	Nicht- rostende Stähle	Ms Cu Al Ti Kunststoff	Befesti- gungs- technik	Maße TI			

Artikel-Nr.

Verbindungs- und Klemmsysteme/
Fastener and Fixing Systems

Stahl/ Stahl mit Überzug	Nicht- rostende Stähle	Ms Cu Al Ti Kunststoff	Befesti- gungs- technik	Maße TI
--------------------------------	------------------------------	------------------------------	-------------------------------	------------

LINDAPTER Hohlprofilbefestigungen
LINDAPTER cavity fixings

82024



LINDAPTER-KIPP-DÜBEL Typ TC
mit Innengewinde,
für Hohlraumbefestigungen
LINDAPTER toggle clamps TC
with internal thread, for decking fixing

660

159

82031

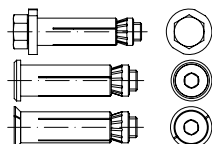

LINDAPTER-HOLLO-BOLT
Blindmontagebefestigungen für Stahlhohlprofile
Typ HB = mit Sechskantschraube
Typ HBCSK = mit Senkkopf
Typ HBFF = FlushFit
LINDAPTER HOLLO-BOLT
for fixing onto hollow steel sections

659

159

82051

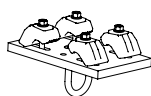

LINDAPTER-Hebeöse ALP
LINDAPTER lifting eye ALP

656

156

Sonstige Klemmsysteme
Other Fixing Systems

82400

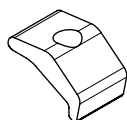

MTH-Klemmplatten Nova Grip
MTH-clamping plates Nova Grip

661

Dübel und Anker/
Plugs and Anchors



Allgemeine Befestigungen
General Fixings

88690

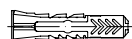

FISCHER Dübel DUOPOWER
FISCHER plugs

678

187

88500



FISCHER Dübel S
FISCHER plugs

678

189

88506

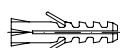

FISCHER Dübel MS
FISCHER plugs

679

190

88507



FISCHER Gasbeton-Dübel GB
FISCHER twist lock anchors

679

191

88510



FISCHER Dübel M
FISCHER plugs

679

190

88520



FISCHER Universaldübel UX, UX-R
FISCHER universal plugs

677

188

88521

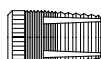

FISCHER Messingdübel PA 4
FISCHER anchors

679

191

88545

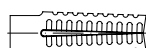

FISCHER Metallspreizdübel FMD
FISCHER steel expansion plugs

678

189

88554



FISCHER Spreizdübel SX
FISCHER expansion plugs

678

188







Stahl/ Stahl mit Überzug	Nicht- rostende Stähle	Ms Cu Al Ti Kunststoff	Befesti- gungs- technik	Maße TI
--------------------------------	------------------------------	------------------------------	-------------------------------	------------

Artikel-Nr.

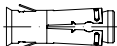
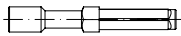
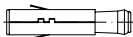
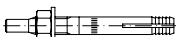
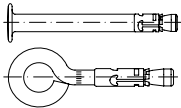
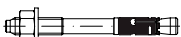
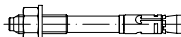
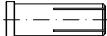
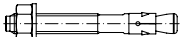
Dübel und Anker/ Plugs and Anchors

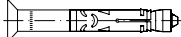
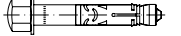
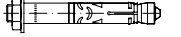

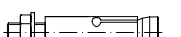
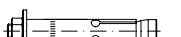
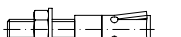
Schwerlast-Befestigungen-Stahlanker High Performance Steel Anchors







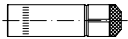
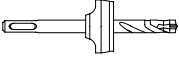
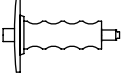
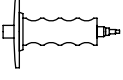

88513		FISCHER Hohldeckenanker FHY FISCHER hollow ceiling anchors
88688		FISCHER Porenbetonanker FPX-I FISCHER aircrete anchors
88530 88683		FISCHER Schwerlast-Dübel SL FISCHER Schwerlast-Anker TA-M FISCHER heavy duty anchors
88531		FISCHER Mauerschrauben MR FISCHER wall screws
88546 88548 88547 88549		FISCHER Nagel-Anker FNA, FNAM, FNA OE, FNA-H FISCHER nail anchors
88561		FISCHER Ankerbolzen FAZ II FISCHER anchor bolts
88694		FISCHER Ankerbolzen FBZ FISCHER anchor bolts
88567 88568		FISCHER Einschlaganker EA und Setzwerkzeuge EAWH FISCHER hammer anchors and setting tools
88582		FISCHER Bolzen FB-N FISCHER bolt anchors
88593		FISCHER Hochleistungsanker FH II-S FISCHER high performance anchors
88594		FISCHER Hochleistungsanker FH II-SK FISCHER high performance anchors
88590		FISCHER Hochleistungsanker FH II-H FISCHER high performance anchors
88592		FISCHER Hochleistungsanker FH II-B FISCHER high performance anchors
88689		FISCHER Hochleistungsanker FH II-I mit Innengewinde FISCHER high performance anchors
88715		FISCHER Bolzenanker EXA FISCHER bolt anchors
88583		FISCHER ZYKON-Bolzenanker FZA FISCHER ZYKON bolt anchors
88584		FISCHER ZYKON-Durchsteckanker FZA-D FISCHER ZYKON through anchors
88589		FISCHER ZYKON-Steigeisen-Befestigung FZA ST FISCHER ZYKON anchor for fixing step irons
88585		FISCHER ZYKON-Innengewindeanker FZA-I FISCHER ZYKON internally threaded anchor

Stahl/ Stahl mit Überzug	Nicht- rostende Stähle	Ms Cu Al Ti Kunststoff	Befesti- gungs- technik	Maße TI
			674	180
			674	181
			674	179
			674	180
			672	176- 178
			666	170
			668	171
			671	176
			672	178
			668	171
			669	172
			669	172
			669	173
			669	173
			673	181
			669	174
			670	174
			670	174
			670	175

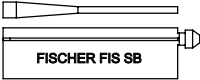
Stahl/ Stahl mit Überzug	Nicht- rostende Stähle	Ms Cu Al Ti Kunststoff	Befesti- gungs- technik	Maße TI
--------------------------------	------------------------------	------------------------------	-------------------------------	------------

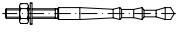
Artikel-Nr.



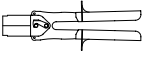
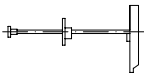
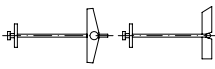
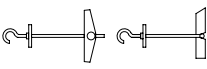
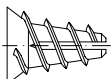



Dübel und Anker/
Plugs and Anchors

88597		FISCHER ZYKON-Einschlaganker FZEA II FISCHER ZYKON hammer set anchors
88587		FISCHER Bohrer FZUB FISCHER drill bits
88588		FISCHER Einschlaggerät FZE plus FISCHER setting tools
88595		FISCHER-Einschlaggerät FZED plus FISCHER setting tools
		Schwerlast-Befestigungen-Chemie Chemical Fixings
88579 88687		FISCHER Mörtelkapseln FHB II, RSB FISCHER resin capsules
88578 88522 88686 88527		FISCHER Injektionsmörtel FIS HB, FIS V, FIS EM, FIS SB FISCHER injection mortar
88525 88579 88685 88524 88684		FISCHER Zubehör für chemische Befestigungen Statikmischer, Ausbläser, Bürste, Auspresspistole, Verlängerungsschlauch FISCHER accessories for chemical fixings
88579 88534 88523 88529		FISCHER Anker FHB II-A, FHB-A dyn, RGM, FIS-A, FIS-E FISCHER anchors
88562 88526		FISCHER Ankerhülsen FIS H K, FIS H N, FIS H L FISCHER anchor sleeves
		Hohlraum-Befestigungen Cavity Fixings
88512		FISCHER Hohlraum-Metalldübel HM FISCHER cavity metal fixings
88511		FISCHER Profizange HM-Z 1 für Hohlraumdübel HM-S FISCHER professional tools
88509		FISCHER Kippdübel K FISCHER toggle fixings
88518		FISCHER Kippdübel KD FISCHER toggles
88519		FISCHER Kippdübel KDH FISCHER toggles
88598		FISCHER Gipskartonplattendübel GK/GK-M FISCHER plasterboard fixings

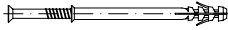
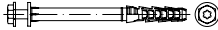
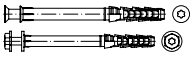
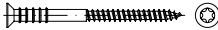
Stahl/ Stahl mit Überzug	Nicht- rostende Stähle	Ms Cu Al Ti Kunststoff	Befesti- gungs- technik	Maße TI
			670	175
			671	
			671	
			671	
			662	164
			662- 663	166
			663- 664	
			664- 666	164
				166
				167
				168
			666	168
				169
			679	192
			679	
			679	192
			679	193
			680	193
			680	194

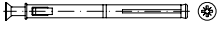
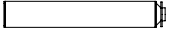
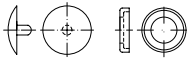
Artikel-Nr.

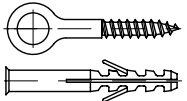
Dübel und Anker/ Plugs and Anchors

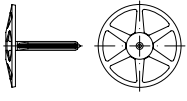
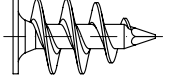
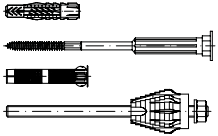
Artikel-Nr.	Dübel und Anker/ Plugs and Anchors	Stahl/ Stahl mit Überzug	Nicht- rostende Stähle	Ms Cu Al Ti Kunststoff	Befesti- gungs- technik	Maße TI
	 Langschaftdübel, Fassadendübel, Abstands-Befestigungen Long Shaft Anchors, Frame Fixings, Adjustment Fixings					
88503	 FISCHER Nageldübel N FISCHER nail plugs				676	185
88542	 FISCHER-Rahmendübel SRX-T, SRX-FUS FISCHER frame fixings				674	182
88551	 FISCHER Langschaftdübel SXRL-FUS, SXRL-T FISCHER frame fixings				675	183
88515	 FISCHER Justierschrauben JUSS FISCHER adjustment screws				677	186
88516	 FISCHER Fensterrahmendübel F-S FISCHER frame fixings				677	185
88563 88564	 FISCHER Langschaftdübel FUR-T/-TS/-SS FISCHER frame fixings				676	184
88680	 FISCHER Metallrahmen-Dübel F-M FISCHER metal frame fixings				677	186
88565	 FISCHER Montageschaum PU 500 FISCHER rapid installation foam				681	
88528 88556 88681 88682	 FISCHER Zierkappen/Abdeckkappen ADT, ADF, ADM, ASM für FISCHER-Rahmendübel FISCHER caps for FISCHER frame fixings				676 677	
	 Gerüst-Befestigungen Scaffold Fixings					
88536	 FISCHER Gerüstverankerungen S 14 ROE, GS 12 FISCHER scaffold fixings				680	196
	 Dämmstoff-Befestigungen Insulation Supports					
88514 88580	 FISCHER Dämmstoff-Befestigungen DHK, DT FISCHER insulation supports				681	197
88696	 FISCHER Dämmstoffdübel FID FISCHER insulation fixings				681	197
88695	 FISCHER Abstandsmontagesystem Thermax FISCHER stand-off installation				681	187
		Stahl/ Stahl mit Überzug	Nicht- rostende Stähle	Ms Cu Al Ti Kunststoff	Befesti- gungs- technik	Maße TI

Artikel-Nr.

**Dübel und Anker/
Plugs and Anchors**



**Elektro-Befestigungen
Electrical Fixings**

- 88558 
- 88559 

FISCHER Schellen FC, Sch
FISCHER pipe clips and saddles

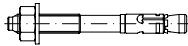

**Anker für schwere Lasten
Anchors - Heavy Duty Fixings**

- 88741 

UPAT Expressanker MAX
UPAT express anchors

- 88764 

UPAT Expressanker IMC
UPAT express anchors

- 88716 

UPAT Einschlaganker USA
UPAT impact anchors

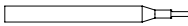
- 88717 

UPAT Setzwerkzeug für USA Einschlaganker
UPAT setting tools for USA hammer set anchors



**Schwerlast-Befestigung Chemie
Chemical Fixings**

- 88722 

UPAT Gewindestange UKA 3-ASTA
UPAT threaded rods

- 88714 

UPAT Innengewindehülse UKA 3-IST
UPAT internal thread bushes

- 88734 

UPAT Gewindestangen UPM-A
UPAT threaded rods

- 88770 



UPAT Innengewindeanker UPM-I
UPAT internal thread anchors

- 88735 





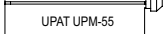



UPAT Siebhülse UPM-SH-K
UPAT mesh bushes

- 88720 

UPAT Mörtelpatronen UKA 3 PLUS
UPAT resin capsules

- 88733 
- 88772 
- 88774 
- 88775 

UPAT Injektionsmörtel
UPM 55, UPM 44, UPM 33, UPM 11
UPAT injection mortar

- 88718 
- 88738 
- 88760 
- 88765 
- 88766 
- 88769 
- 88771 
- 88776 

UPAT Zubehör für Schwerlastbefestigung Chemie
Statikmischer, Reinigungsbürsten, Ausbläser,
Ausdrückpistolen, Setzwerkzeuge
UPAT accessories for chemical fixings

Stahl/ Stahl mit Überzug	Nicht- rostende Stähle	Ms Cu Al Ti Kunststoff	Befesti- gungs- technik	Maße TI
			680	195
			681	198
			682	198
			682	199
			682	
			683	199
			683	200
			683	
			684	200
			684	201
			684	201
			684	
			685	
			686	

Artikel-Nr.

Dübel und Anker/ Plugs and Anchors

Sonstige Befestigungselemente Other Fixing Elements

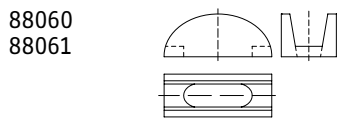

88060
88061

Schrägzug-Spannelemente:
Kurvenstücke mit Passscheiben für
Schrägzug bis 45°
Adjusting washers for cam segments and
cam segments for tension anchors for diagonal pull tensioning

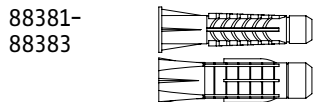

88381-
88383

TOX-Dübel 4 As K, Tri, Trika
TOX hook plugs

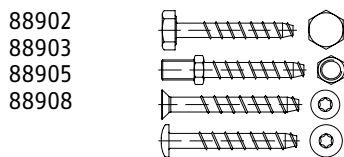

88902
88903
88905
88908

MULTI-MONTI-MMSplus
Schraubanker, Stockanker, Mauerschrauben
MULTI-MONTI-MMSplus screw anchors, wall screws

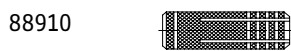

88910

Messing-Spreizdübel
Brass expanding plugs

Schraub-Technik/ Assembly Tools

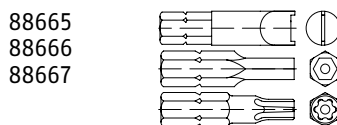

88665
88666
88667

Spezial-Bits für Schrauben mit diebstahl-/
vandalismus-hemmenden Antrieben
Artikel 88111-88115
Bits for theft resistant screws

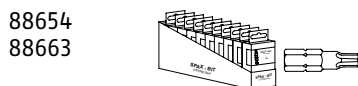

88654
88663

SPAX Innenstern-Schraubklingen
SPAX CUT-CASE
Bits for hexalobular socket screws

Blindniete/ Blind Rivets

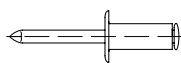

Offene Blindniete mit Sollbruchdorn nach DIN 7337
Form A = Flachkopf
Open-end blind rivets with break pull mandrel
according to DIN 7337
Type A = protruding head

88401

Stahl verzinkt/Stahl verzinkt
Steel zinc plated/steel zinc plated

88402

Al-Leg./Stahl verzinkt
Al alloy/steel zinc plated

88403

Al-Leg./Nichtrostender Stahl A2
Al alloy/stainless steel A2

88404

Nichtrostender Stahl A2/Nichtrostender Stahl A2
Stainless steel A2/stainless steel A2

88405

Nichtrostender Stahl A2/Stahl verzinkt (Stinox)
Stainless steel A2/steel zinc plated (Stinox)

Stahl/ Stahl mit Überzug	Nicht- rostende Stähle	Ms Cu Al Ti Kunststoff	Befesti- gungs- technik	Maße TI
			687	136
			686	
			687	202 - 204
			686	
			688	
			688	
			689	206
			689	206
			690	206
			690	206
			691	206

Stahl/ Stahl mit Überzug	Nicht- rostende Stähle	Ms Cu Al Ti Kunststoff	Befesti- gungs- technik	Maße TI
--------------------------------	------------------------------	------------------------------	-------------------------------	------------

Artikel-Nr.

**Blindniete/
Blind Rivets**

88406

Kupfer/Stahl verzinkt
Copper/steel zinc plated

88407

Kupfer/Bronze
Copper/bronze

88408

Kunststoff/Kunststoff
Plastic/plastic

88410

Al-Leg./Al-Leg.
Al alloy/Al alloy

88415

Nichtrostender Stahl A4/Nichtrostender Stahl A4
Stainless steel A4/stainless steel A4

88493

Monel/A4
Monel/A4

88417

Köpfe lackiert – Al-Leg./Stahl verzinkt
Al alloy/steel zinc plated – head painted

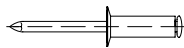

Offene Blindniete mit Sollbruchdorn nach DIN 7337
Form B = Senkkopf
Open-end blind rivets
Type B = countersunk head

88411

Stahl verzinkt/Stahl verzinkt
Steel zinc plated/steel zinc plated

88412

Al-Leg./Stahl verzinkt
Al alloy/steel zinc plated

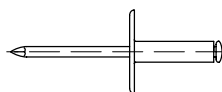

Offene Blindniete mit Sollbruchdorn nach DIN 7337
Form C = großer Flachkopf
Open-end blind rivets
Type C = large protruding head

88409

Al-Leg./Stahl verzinkt
Al alloy/steel zinc plated

88413

Stahl verzinkt/Stahl verzinkt
Steel zinc plated/steel zinc plated

88414

Al-Leg./Al-Leg.
Al alloy/Al alloy

88416

Al-Leg./Nichtrostender Stahl A2
Al alloy/stainless steel A2

88419

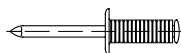

Offene Spezial-Blindniete mit gerilltem Schaft FG
für Sacklochnietung
Open-end blind rivets with grooved rivet body
for blind hole rivetting

88420

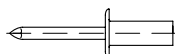

Geschlossene Blindniete
für luft- und wasserdichte Verbindungen,
Al-Leg./Stahl phosphatiert,
Al-Leg./Nichtrostender Stahl A2,
Kupfer/Stahl phosphatiert,
Kupfer/Nichtrostender Stahl A2
Closed-end blind rivets for air- and water-tight rivetting

88421

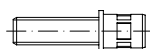

Offene Spezial-Blindniete mit Sollbruchdorn
Form M = Anschlussgewinde
Open-end blind rivets with break pull mandrel,
Type M = with connection thread

Stahl/ Stahl mit Überzug	Nicht- rostende Stähle	Ms Cu Al Ti Kunststoff	Befesti- gungs- technik	Maße TI
			691	206
			691	206
			691	207
			690	206
			690	206
			690	206
			691	206
			692	208
			692	208
			692	207
			692	207
			692	207
			692	207
			693	207
			693	207
			693	207
			693	208
			694	208
			694	209
Stahl/ Stahl mit Überzug	Nicht- rostende Stähle	Ms Cu Al Ti Kunststoff	Befesti- gungs- technik	Maße TI

Artikel-Nr.

Blindniete/ Blind Rivets

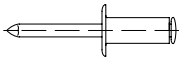
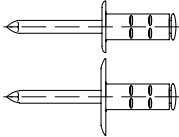
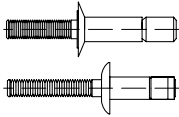
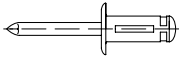
88422		<p>Offene Spezial-Blindniete mit Sollbruchdorn Form SS-A = Spreizschaft, Flachkopf, für Montagen an weichen Baustoffen Open-end blind rivet with break pull mandrel, type SS-A = protruding head, with peel rivet body, for soft building material</p>
88474 88475		<p>Offene Mehrbereichs-Blindniete „PolyGrip“ Form A = Flachkopf, Form C = großer Flachkopf, Stahl verzinkt/Stahl verzinkt, Al-Leg./Stahl verzinkt, Al-Leg./Nichtrostender Stahl A2, Al-Leg./Al-Leg. Open-end blind rivets with multigrip rivet body „PolyGrip“</p>
88476 88477		<p>Offene Spezial-Blindniete mit Sollbruchdorn „MEGA G-LOCK“ = hochfeste Nietmontagen Form F = Flachrundkopf, Form S = Senkkopf Open-end blind rivets with break pull mandrel „MEGA G-LOCK“ = for high strength rivet assembly</p>
88488		<p>Offene Spezial-Blindniete mit Sollbruchdorn „TRIFOLD“ = Pressflaschen-Blindniete für weiche Werkstoffe, Form F = Flachrundkopf Open-end blind rivets with break pull mandrel, „TRIFOLD“ = recessed crown for soft material</p>

Blindniet-Muttern/ Blind Rivet Nuts

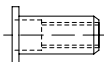
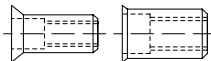
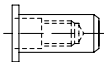
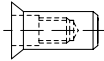
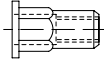
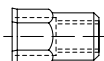
88423		<p>Blindniet-Muttern, rund, offen Form F = Flachkopf Stahl verzinkt, Al-Leg., Nichtrostender Stahl A2 Blind rivet nuts, round, open-end</p>
88424 88418		<p>Blindniet-Muttern, rund, offen Form S = Senkkopf, Form Sk = kleiner Senkkopf Stahl verzinkt, Al-Leg., Nichtrostender Stahl A2 Blind rivet nuts, round, open-end</p>
88480		<p>Blindniet-Muttern, rund, geschlossen, für luft- und wasserdichte Nietungen Form F = Flachkopf Blind rivet nuts, round, closed, for air- and water-tight rivetting, type F = protruding head</p>
88481		<p>Blindniet-Muttern, rund, geschlossen, für luft- und wasserdichte Nietungen Form S = Senkkopf Blind rivet nuts, round, closed-end for air- and water-tight rivetting, type S = countersunk head</p>
88483		<p>Blindniet-Muttern, Sechskant, offen Form F = Flachkopf Blind rivet nuts, hexagon, open-end, type F = protruding head</p>
88484		<p>Blindniet-Muttern, Sechskant, offen Form Sk = kleiner Senkkopf Blind rivet nuts, hexagon, open-end Type Sk = small countersunk head</p>

Stahl/ Stahl mit Überzug	Nicht- rostende Stähle	Ms Cu Al Ti Kunststoff	Befesti- gungs- technik	Maße TI
			694	209
			695	209 210
			696	210
			694	211
			697	213
			697 696	213 212
			698	213
			698	213
			699	214
			699	214

Stahl/ Stahl mit Überzug	Nicht- rostende Stähle	Ms Cu Al Ti Kunststoff	Befesti- gungs- technik	Maße TI
--------------------------------	------------------------------	------------------------------	-------------------------------	------------

Artikel-Nr.

**Blindniet-Muttern/
Blind Rivet Nuts**

88490
88491

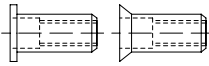

Blindniet-Muttern, rund, offen,
mit Mehrbereichsschaft
Form F = Flachkopf, Form S = Senkkopf
Blind rivet nuts, round, open-end, with multigrip rivet body
Type F = protruding head, type S = countersunk head

**Setzwerkzeuge für Blindniete
und -Muttern**

**Setzwerkzeuge für Blindniete
und Blindniet-Muttern**
Setting Tools for Blind Rivet and Blind Rivet Nuts

88440

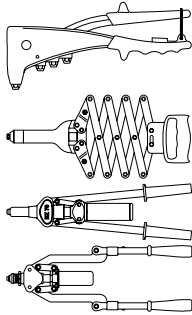

Handzangen
für Blindniete und Blindniet-Muttern
Hand tools for blind rivets and blind rivet nuts

88441

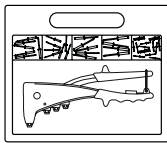

Blindniete Sortiment
mit Handzange und Montagematerial
Blind rivets assortment
with hand tools and fitting material

88443



Batteriebetriebene Setzgeräte für Blindniete
Battery riveter for blind rivets

Stahl/ Stahl mit Überzug	Nicht- rostende Stähle	Ms Cu Al Ti Kunststoff	Befesti- gungs- technik	Maße TI
			699 699	213
			700	
			700	
			701	
Stahl/ Stahl mit Überzug	Nicht- rostende Stähle	Ms Cu Al Ti Kunststoff	Befesti- gungs- technik	Maße TI

Artikel	Genormte Artikel DIN (ISO/EN)	Nicht genormte Artikel Seite	Artikel	Genormte Artikel DIN (ISO/EN)	Nicht genormte Artikel Seite
A			Bundmuttern		
ABC-SPAX-Schrauben		417, 593		6923 (1661), 6926 (1663), 6927 (1664), 6331, 74361	396
ABC-SPAX-Sortimente		420, 688	Bundschraben	478-480, 6921 (1665), 7500, 34805-2 (7380-2)	388
Abdeckkappen für Fischerdübel		676, 677	C		
Abdeckkappen für Innensechskant-/ Innensechsrundschrauben		420, 645	CE-Schrauben für den Holzbau	(EN 14566, EN 14592)	446 - 450, 607
Abdeckkappen für Rahmendübel		676, 677	CE-Schrauben und Muttern für den Stahlbau	7968, 7969, 7990, 1478, 1479, 1480 (4014, 4017 5B), (EN 14399-4/-8 15048)	
Abdeckkappen für Schrauben mit Innenloch		644	Cupal-Scheiben		645
Abdeckkappen für Schrauben mit Kreuzschlitz		644	D		
Abstands-/Distanzbolzen		416	Dämmstoffbefestigungen (FISCHER)		681
Achsenklemmringe		430	Deckenhaken		434 - 436, 679 - 680
Achshalter	15058		Dehnschrauben	2510	
Actros Schrauben/-Muttern		388, 396	Dichtscheiben, Dichtringe	7603	603, 645
Adapter, Klemmelemente	3568	442, 606, 652	Diebstahl-hemmende Schrauben/Muttern		429, 596
Allzweckdübel (TOX)		686	Direktmontage-Schrauben		674, 687
AMECOIL-Gewindeeinsätze u. Zubeh.		603	Distanz-/ Abstandsbolzen		416
Ankerschrauben	529	687	Distanzscheiben	988	
Ankerstangen	975, 976	665, 665, 683, 683	Drahtseilklemmen	741	
Ansatzschrauben	923		Drahtspanner	1478-1480	
Anschweißenden	525		Dreikantschrauben	22424	
Anschweißmuttern	928, 929		Druckstücke	6311	
ASME-Muttern/-Schrauben	ASME B18.2.1, ASME B18.2.2, ASME B18.3		Dübel u. Anker für Gerüste Hohlräume Leichtbaustoffe		680 679 677 - 679, 674 - 677, 686 662 - 674 681 - 686 646 - 646
Augenschrauben	444		Rahmenbefestigung Schwere Lasten		
Ausgleichscheiben	988		DUBO-Sicherungen, -Rosetten		
B			Dünnschaftschrauben	7964	
Ballengriffe	98		E		
Bauschrauben	601	450	Einschlagmuttern		428
Becherschrauben	15237		Einschraubmuttern	7965	603, 697
Bedienteile, Ballengriffe	98, 99, 319, 6304-6311, 6332, 6335, 6336		Einspannbuchsen	1498	
Befestigung für Hohlprofile		659	Elastik-Stoppmuttern	980, 982, 985, 986, 6924, 6925 (7040, 7042, 10511-10513) (EN 1663, 1664)	199, 322, 396, 416, 440, 442
Behälterbauschrauben/-muttern	938, 939, (4014, 4017, 4032)		ENSAT-Gewindeeinsätze		603
Betonerschrauben		674, 687	ES-Federklappbolzen		410
Bits (Schraubklingen), Sortimente		688	F		
Blechniete	662, 7337	689 - 699	Fächerscheiben	6798	
Blechschraben	7504, 7976, 7981, 7982, 7983 (7049, 7051), (14583-14586, 15480-15482)	574, 597	Fassadendübel		674 - 677
Blindniete		689 - 696	Fassadenschrauben		602
Blindniet-Muttern		696 - 699	Federbolzen	931 (4014)	
Blindniet-Setzgeräte		700	Federklappbolzen f. Gabelköpfe		410
Bogen-Klammerschrauben	25193		Federnde Zahnscheiben	6797	429 - 431, 598 - 600
Bohrschrauben	7504 (15480-15482)				
Bolzen	601 (4016), 931 (4014), 976, 1444 (2341)				
Bordwandschrauben		428, 596			
Bremsbelagniete	7338				
Bügelmuttern	28129				
Bullaugenschrauben/-muttern	444, 80704				

Artikel	Genormte Artikel DIN (ISO/EN)	Nicht genormte Artikel Seite	Artikel	Genormte Artikel DIN (ISO/EN)	Nicht genormte Artikel Seite
F					
Federringe	127, 128, 7980, 74361	429 – 431, 598 – 600	Gewindeschrauben	84, 85, 963, 964, 965, 966, 7985 (1207, 1580, 2009, 2010, 7046, 7047, 14583)	428, 596
Federscheiben	137		Gewindestangen/-stücke	975, 976	665, 683
Federstecker	11024		Gewindestifte mit Druckzapfen	6332	
Feingewinde-Muttern	439, 934-937, 980, 985, 1587 (8673, 8675, 10512, 10513)	396, 440	Gewindestifte mit Innensechskant	913, 914, 915, 916 (4026, 4027, 4028, 4029)	
Feingewinde-Schrauben	912, 960, 961, 913-916 (4762, 8676, 8765)	388, 439	Gewindestifte mit Längsschlitz	417, 427, 438, 551, 553, 927 (7435, 2342, 7436, 4766, 7434)	
Feingewinde-Stangen	975		Glasleistenschrauben		425, 595
Fenster-Bohrschrauben		426	Gleitmuttern	508	444 – 445
Fensterrahmen-Dübel, -Verbindungen		677	Gurtschrauben	15237	
FISCHER-Dübel		662 – 681	H		
Flachbundmuttern	74361	396, 442	Hakenkopf-Schrauben/-Muttern		442 – 445, 606 – 607
Flachdichtringe	7603	603, 646	Hakenschrauben		435 – 436
Flache Muttern	439, 562, 936, 937, 979, 80705 (4035, 8675)		Halbhohlniete	7338	
Flache Rändelmutter/-schrauben	467, 653		Halbrund-Holzschrauben	96	421, 447, 594, 607
Flache Scheiben	→Scheiben →ISO-Scheiben		Halbrund-Kerbnägel	1476 (8746)	
Flachkopf-Blechschraben	7981		Halbrund-Niete	660	689 – 696
Flachkopf-Gewindeschrauben	85, 920, 921, 923, 7985, 34805-1/-2 (7380-1/-2, 14583)	428, 436, 596	Halbrund-Schrauben mit Nase	607	
Flachrundniete	674	689 – 696	HALFEN-Schrauben		442, 606
Flachrundschraben mit Vierkantansatz	603		Halteringe	983	
Flach-Schmiernippel	3404		Halterungsschellen	3016, 3017, 3567	
Flanschkopfschrauben	6921, 7500, 34805-2 (ISO 7380-2), (EN 1665)	388, 438 – 441	Hammerkopf-Schrauben/-Muttern	186, 261	
Flanschmuttern	6923 (EN 1663, 1664)	396, 440, 442	Heißdampfbolzen	2510	
Flügelmutter/-schrauben	315, 316	78, 464	Hitzebest. Schrauben/Muttern	931, 933, 934, 2510 (4014, 4017, 4032)	
Fugenscheiben		427	Hochspann-Federringe	128	431, 600
Fugenschrauben	25193		Hohe Muttern	6330, 6331, 6334, 74361	417, 592
G			Hohe Rändelmutter	466	
Gabelköpfe, Gabelgelenke	71752	410	Hohe Rändelschrauben	464	
Gehärtete Scheiben	6319, 6340, 6796-98, 6917-18 (7089, 7090), (EN 14399-6)		Hohlniete	7338	
Gerüsthälter (Dübel, Ringösen)		680	Hohlprofil-Befestigung		659
Gewindeeinsätze AMECOIL		603 – 605	Hohlraumdübel		679 – 680
Gewindeeinsätze ENSAT		437, 603	Hohlschrauben	7643	
Gewindefurchende Schrauben	7500	436	Hohlstifte	1481, 7343, 7344, 7346 (8748, 8750, 8752, 13337)	
Gewindemuffen	6334	417, 592 – 593	Holzbauschrauben	601	417, 593
Gewindeösen		434 – 436	Holzschrauben	95, 96, 97, 571	417 – 427, 446 – 450, 593 – 595, 609 – 609 645
Gewindeplatten		444 – 445	Holzverbinder	1052	
Gewinde-Schneidschrauben	7513, 7516	603	Hülsenmuttern		607, 647
			Hutmutter	917, 986, 1587 (EN 14399-4)	
			HV-Muttern	(EN 14399-8)	
			HV-Passschrauben	(EN 14399-8)	
			HV-Scheiben	6917, 6918 (EN 14399-6)	
			HV-Schrauben	(EN 14399-4)	
			HV-Sicherungsmuffen		402

Artikel	Genormte Artikel DIN (ISO/EN)	Nicht genormte Artikel Artikel Seite	Artikel	Genormte Artikel DIN (ISO/EN)	Nicht genormte Artikel Artikel Seite
I					
INBUS-Schlüssel	911		Klavierbandschrauben	97	424
INBUS-Schrauben	912 (4762)	438	Klebeanker		662 – 666, 683 – 686
Innenausbauschrauben		417, 593	Klemmelemente LINDAPTER		652 – 661
Innenloch-Holzschrauben		424	Klemmplatten/-ringe	3568	652 – 661
Innensechskant-Gewindestifte	913-916 (4026-4029)		Klingen (Bits)		688 – 689
Innensechskant-Schrauben	912, 6912, 7984 (4762, 7380, 10642)	438	Knebelkerbstifte	1475 (8742, 8743)	
Innensechskant-Verschlussschrauben	906, 908		Knebelschrauben/-muttern	6304-6307, 80701	
Innensechsrund-Schrauben	~912, ~965, 7500, 7504, 7516, ~7984, ~7985, 34805 (~7380, ~10642, ~14583)	417, 446, 449, 593, 608	Kombi-Dichtungen		645
Isolierhülsen (KORREX)		646	Konische Stifte	1, 258, 7977, 7978 (2339, 8737, 8736)	
ISO-Scheiben	(7089-7094)		Kontaktscheiben (TECKENTRUP)	6797, 6798	431, 600
ISO-Schrauben/-Muttern	(1207, 1479, 1580, 2009, 2010, 2342, 4014, 4016, 4017, 4026-4029, 4032, 4033, 4035, 4762, 7040-7051, 7379, 7380, 8673, 8675, 8676, 8765, 10511-10513, 10642, 12474, 14579, 14583, 14585, 14586, 15481, 15482)		Kontermuttern	439, 936 (4035, 8675)	
ISO-Stifte	(2338, 2339, 8734-8752, 13337)		Korbmuttern	80704	
			KORREX-Isolierhülsen-Rosetten, - Schutzkappen		646
			Kotflügelscheiben		428, 596
			Kreuzgriffe	6335	
			Kreuzloch-Schrauben/-Muttern	404, 1816	
			Kreuzschlitz-Blechschraben	7981, 7982, 7983 (7049, 7050, 7051)	
			Kreuzschlitz-Gewindeschrauben	965, 966, 7985 (7045-7047)	
			Kreuzschlitz-Holzschrauben		420, 447, 594
			Kronenmuttern	935, 937, 979	
			Kugelmuttern	74361	
			Kugelknöpfe	319	
			Kugelscheiben	6319	
			Kunststoff-Blindniete		691
			Kunststoff-Muttern	555, 1587 (4034)	
			Kunststoff-Scheiben	125, 9021	646
			Kunststoff-Schrauben	84, 85, 933 (4017)	
			Kunststoff-Zierkappen		645, 677
			Kupplungsbelagniete	7338	
			Kurvenstücke f. Schrägzuganker		687
J					
Justierschrauben	479, 561, 564	677	L		
K			Leichtbaustoff-Dübel		680
Kabelbinder u. Zubehör		649 – 652	Limesringe	74361	
Käfigmuttern		428	LINDAPTER-Klemmelemente		652 – 661
Kappen für Schrauben und Dübel		644 – 645, 677	Linksgewinde-Muttern	934, 936 (4032, 4035, 8673, 8675)	
Kappenschrauben		360	Linsen-Blechschraben	7983 (7051)	
Karabinerhaken	5299		Linsenkopf-Gewindeschrauben	85, 7985 (1580, 7045)	
Kauschen	6899		Linsenschrauben mit Innensechskant/Innensechsrund	~7985, ~7981 (7380, ~14583, ~14585)	
Kegelgriffe	99		Linsensenkkopf-Blechschraben	7983 (14585)	
Kegelkerbstifte	1471 (8744)		Linsensenkkopf-Gewindeschrauben	964, 965 (2010, 7046)	
Kegelpfannen	6319		Linsensenkkopf-Holzschrauben	95	420, 594, 645
Kegelschmiernippel	71412		Linsensenkkopf-Niete	662	
Kegelstifte	1, 258, 7977, 7978 (2339, 8737, 8736)		Linsensenkkopf-Schneidschrauben	7513, 7516	
Keilscheiben	434, 435, 6917, 6918		Lukenmuttern	28129, 80701, 80704	
Keilstahl	6880		Lukenschrauben	444	
Kerbnägel	1476, 1477 (8746, 8747)				
Kerbstifte	1471-1475 (8740-8745)				
Kippdübel		660, 679 – 680			
Klammerscheiben		427			
Klammerschrauben	25193	652 – 661			
Klappsplinte, Klappstecker	11023	394			

Artikel	Genormte Artikel DIN (ISO/EN)	Nicht genormte Artikel Artikel Seite	Artikel	Genormte Artikel DIN (ISO/EN)	Nicht genormte Artikel Artikel Seite
M					
Madenschrauben	551, 553, 913-916		Plastik-Muttern	555, 1587 (4034)	
Maschinenschrauben	601 (4016)		Plastik-Scheiben	125, 9021	645, 646
Mauerschrauben	529	674, 687	Plastik-Schrauben	84, 85, 933 (4017)	
Montage-Koffer-Sortimente	→ Sortimente		Plombier-Schrauben	404	
Montage-Schaum		681	Profil-Schrauben/-Muttern		442 - 445, 607
Muffen, rund/sechskant		417, 592	R		
MULTI-MONTI-Mauerschrauben		687	Radmuttern	6330, 6331, 74361	
Muttern für T-Nuten		445 - 446	Rahmendübel		674 - 677
Muttern, diverse Formen	315, 431, 439, 466, 467, 508, 546, 555, 557, 562, 582, 917, 928, 929, 934, 935, 936, 937, 979, 980, 982, 985, 986, 1478, 1479, 1587, 1804, 1816, 2510, 6330, 6331, 6334, 6923-6925, 7967, 28129, 70852,74361, 80701,80704, 80705 ASME B18.2.2 → ISO-Muttern → EN-Muttern	199, 396, 416, 417, 428, 440, 442, 444, 445, 592, 593, 596, 607, 647, 697 - 699	RAMPA-Muffen	7965	
N			Rändelmuttern	466, 467	
Nageldübel		672	Rändelschrauben	464, 653	
Nasenkeile	6887		Reaktions-Anker		662 - 666, 683 - 685
Niete	660, 661, 662, 674, 7337, 7338	689 - 699	Regenhütchen		645
Nietscheiben	9021		RIBE-Käppi		645
Nippel	71412		Ringmuttern, Ringschrauben	582, 580	
NORD-LOCK-Scheiben		432, 600	Ringschraubösen		434 - 436, 601, 680
Nutenschrauben	787		RIPP-Schrauben/-Muttern		438 - 440
Nutensteine	508		Rohr-Bügel	3570	
Nutmutter	981, 1804, 70852		Rohrklappstecker		394
Nutmutter-Sicherungen	5406, 70952		Rohrmuttern	431	
Ö			Rohrniete	7338	
Ösenschrauben		434 - 436, 601, 680	Rohrschellen	3567, 4109	
P			Rosetten KORREX		647
Palmmutter	7967		Rosettenscheiben		647
Parker-Schrauben	→ Blech- schrauben		Rundmuttern	546	417, 593
Passfedern	6885		Rundstahlbügel	3570	
Passkerbstifte	1472 (8745)		RUV-Scheiben		602, 645
Passscheiben f. Kurvenstücke	988	687	S		
Passschrauben	609, 610, 7968 (EN 14399-8)		Schaftschrauben mit Schlitz- und Kegelkuppe	427	
Pass-Schulterschrauben	(7379)		Schäkel	82101	
Pflugschrauben	604, 605, 608, 11014		Scharnierbandschrauben	97	424
Pfostenschrauben		595	Scheiben für Holzverbinder	440, 1052	
			Scheiben, rund	125, 126, 432, 433, 440, 988, 1052, 1440, 1441, 6319, 6340, 7349, 7989, 9021 (7089-7094), (EN 14399-6), (ANSI B18.22.1	427, 428, 596, 645
			Scheiben, vierkant und konisch	434-436, 6917-6918	
			Scheibenfedern	6888	
			Schellen, Schlauchschellen	3016, 3017, 3567	
			Schellkopfschrauben	607	
			Schlaganker		671, 682
			Schlauch-Schellen	3016, 3017	
			Schlitzmuttern	546, 7965	
			Schlitzschrauben	84, 85, 920, 921, 923, 933, 963, 964, 7500, 7969 (1207, 1580, 2009, 2010)	428, 596
			Schlossschrauben	603	
			Schlüsselschrauben	571	450

Artikel	Genormte Artikel DIN (ISO/EN)	Nicht genormte Artikel Seite	Artikel	Genormte Artikel DIN (ISO/EN)	Nicht genormte Artikel Seite
S					
Schmiernippel	3404, 3405, 71412		Senkkopf-Holzschrauben	97	417 - 427, 446 - 449, 593 - 595, 607 - 609
Schneidschrauben	7513, 7516		Senkkopf-Niete	661, 7337	692
Schnellbauschrauben		450, 451	Senkkopf-Schneidschrauben	7513, 7516	
Schnellmontage-Elemente		428, 430, 596	Senklochscheiben		647
SCHNORR-Sperrzahnscheiben		429, 598	Senkschrauben m. Innensechsrund	~965, ~7982 (-10642, 14581)	417, 446, 449, 593, 608
Schrauben f. Kunststoffe		436, 437	Senkschrauben mit Innensechskant	(10642)	
Schraubenbolzen	2510		Senkschrauben mit Kreuzschlitz	965, 7982, 7500 (7046, 7050)	421, 448, 594, 607
Schraubensicherungs-Elemente	93, 94, 127, 128, 137, 432, 462, 463, 6796, 6797, 6798, 7980, 11024	432 - 434, 598 - 601, 602, 645	Senkschrauben mit Längsschlitz	963, 7513, 7969 (2009)	
Schraubhaken, Schraubösen		434 - 436, 601	Senkschrauben mit Nase(n)	604, 11014	
Schraubklingen, Sortimente		688	Senkschrauben mit Vierkant	605, 608	
Schraubösen		434, 680	Setzmuttern		428, 596
Schulter-Passschrauben	(7379)		Setzwerkzeuge für Ankerstangen		671, 682, 686
Schutzkappen		644, 645	Setzwerkzeuge für Gewindeeinsätze		437, 604, 605
Schweißmuttern	928, 929		S-Haken		434
Schwerlastdübel		662 - 674, 681 - 685	Sicherungsbleche	93, 432, 462, 463, 5406, 70952	
Schwerspannstifte	1481, 7343, 7344 (8748, 8750, 8752)		Sicherungsmuffen für HV-Schrauben		402
Sechskant-Blechschraben	7504, 7976 (1479)		Sicherungsmuttern	980, 982, 985, 986, 6924, 6925, 7967 (ISO 7040, 7042, 10511-10513), (EN 1663, 1664)	396, 416, 440, 442, 602
Sechskant-Gewindemuffen	6334	417, 592	Sicherungsringe/-scheiben	471, 472, 983, 6799	429 - 434, 598 - 601, 602, 645
Sechskant-Holzschrauben	571	450	Sortimente/Montagekoffer		69, 71, 74, 90, 170, 199, 201, 220, 420, 605, 652, 688
Sechskant-Hutmuttern	917, 986, 1587		Spannscheiben	6796	430, 599
Sechskant-Muttern	431, 439, 555, 917, 929, 934, 935, 936, 937, 980, 982, 985, 1587, 2510, 6330, 6331, 6334, 6923, 6925, 74361, 80705, (→ ISO-Muttern) (→ EN-Muttern) ASME B.18.2.2	396, 417, 428, 442, 592, 602	Spannschlösser	1478-1480	
Sechskant-Passschrauben	609, 610, 7968 (EN 14399-8)		Spannschlossmuttern	1478-1480	
Sechskant-Schneidschrauben	7513		Spannstifte (-hülsen)	1481, 7343, 7344, 7346 (8848, 8850, 8752, 13337)	
Sechskant-Schrauben	561, 564, 571, 601, 931, 933, 960, 961, 6921, 7500, 7990, 7964 (→ ISO-Schrauben) (EN 14399-4) ASME B 18.2.1	388, 438 - 441, 450	Spanplatten-/SPAX-Schrauben		417 - 427, 447 - 449, 593 - 596, 607 - 609
Sechskant-Schweißmuttern	929		Sperrkant-Scheiben (TECKENTRUP)		430, 431, 599, 600
Sechskant-Stiftschlüssel	911, 6911		Sperrzahn-Muttern		322, 442
Sechskant-Verschlusschrauben	909, 910, 5586, 7604		Sperrzahn-Scheiben (SCHNORR)		429, 598
Selbstbohrende Schrauben	7504, 18182		Sperrzahn-Schrauben		441
Selbstschneidende Schrauben	7513, 7516	436, 437	Spiral-Spannstifte	7343, 7344 (8748, 8750)	
Selbstsichernde Muttern	980, 982, 985, 986 (7040, 7042, 10511-10513)	416, 440, 442	Splinte	94, 11023, 11024 (1234)	
Senkkerbnägel	1477 (8747)		Spreizdübel, Messing		686
Senkkopf-Blechschraben	7982 (14586)		Sprengringe	7993, 9925, 9926	
			Stahlbauscheiben	6917, 6918, 7989 (EN 14399-6)	
			Stahlbauschrauben	7968, 7969, 7990 (4014, 4017 SB), (EN 14399-4/-8)	
			Stahlschrauben	931, 933, 960, 961 (4014, 4017, 8676, 8765), (EN 14399-4)	
			Steckkerbstifte	1474 (8741)	

Artikel	Genormte Artikel DIN (ISO/EN)	Nicht genormte Artikel Seite	Artikel	Genormte Artikel DIN (ISO/EN)	Nicht genormte Artikel Seite
S			S		
Steckschlüssel	911, 6911	688	Unverlierbare Schrauben/Muttern (RUV)	7964	602, 645
Stehbolzen	835, 938, 939, 976		UPAT-Dübel		681 – 686
Steinschrauben	529	687	V		
Stellringe	703, 705		Verbindungsmuffen	6334	417, 592
Stellschrauben	479, 480, 561, 564, 933, 961 (4017, 8676)		Verbundanker		662 – 666, 683 – 685
Sterngriffe	6336		Verschussdeckel	443	
Stifte, konisch	1, 258, 7977, 7978		Verschussscheiben	470	
Stifte, zylindrisch	7, 6325, 7979 (2338, 8734)		Verschussschrauben	906, 908, 909, 910, 5586, 7604	
Stiftschlüssel	911, 6911		Vierkantmuttern	508, 557, 562, 928	
Stiftschrauben	835, 938, 939		Vierkantscheiben	434, 435, 436, 6917, 6918	
Stockschrauben		436, 601	Vierkantschrauben	478, 479, 480, 787	
Stopfen (Verschlussstopfen)	906, 908, 909, 910, 5586, 7604		Vierkant-Schweissmuttern	928	
Stopfmuttern	980, 982, 985, 986, 6924, 6925 (ISO 7040, 7042, 10511-10513), (EN 1663, 1664)	416, 440, 442	Vierlochmuttern	1816	
Stützscheiben	988		W		
T			W		
Technische Informationen	→ rote Seiten		Warmfeste Muttern	934, 2510 (4032)	
TECKENTRUP-Sperrkantscheiben		430, 431, 599, 600	Warmfeste Schrauben	2510 (4014, 4017)	
Tellerfedern	2093 (EN 16983)		Wellenringe	471, 703, 705, 983	
Tellerschrauben	15237		Wellensicherungen	471, 983, 6799	
TENSILOCK-Schrauben/-Muttern		441, 442	Wellplatten-Schrauben/-Hütchen	571	645, 450
Terrassenschrauben		594, 609	Wellscheiben	137	
THERMAG-Muttern		199	Whitworthgewinde-Muttern/-Schrauben	555, 934, 975	
Titan-Muttern	934 (4032)		Winkelgelenke	71802	
T-Nutenschrauben	787		Winkelschraubendreher	911, 6911	
T-Nutensteine	508		Winkelschraubhaken		435, 436
TORX-Schrauben	~912, ~965, ~7504, ~7516, ~7981, ~7982, ~7984, ~7985, 34805-1/-2 (~7380, ~10642, 14579, 14581, 14583, 14585, 14586)		Z		
TOX-Dübel		686	Zahnscheiben	6797, 6798	429, 598
Transportösen	580, 582		Zapfenbrecher für AMECOIL		604
Trapezgewindeenden	975		Zapfenschrauben	480, 561, 564, 927	
Trapezgewindemuttern		417, 593	Zapfenstifte	417, 915 (4028)	
Treibschrauben	7976, 7981, 7982, 7983 (1479, 7049, 7050, 7051)	574	Zierkappen		644, 645
Trichter-Schmiernippel	3405		Zollgewinde-Muttern	555, 934, ASTM B18.2.2	
Trockenbauschrauben		450, 451	Zollgewinde-Schrauben	ASTM B18.2.1, ASTM B18.3	
U			Zündkerzen-Gewindeeinsätze		603
UNC-Schrauben, -Muttern	ASTM B18.2.1, ASTM B18.2.2, ASTM B18.3	415	Zylindkerbstifte	1473 (8740)	
Unterlegscheiben	(→ Scheiben)		Zylinderkopf-Blechschraben	7981	574
			Zylinderkopf-Schneidschrauben	7513, 7516	
			Zylinderschrauben Innensechskant	912, 6912, 7984 (4762, 12474), ASME B 18.3	438, 574
			Zylinderschrauben Innensechsrund	~912, ~7984 (14579)	
			Zylinderschrauben mit Längsschlitz	84, 7513 (1207)	
			Zylinderstifte	7, 6325, 7979 (2338, 8734)	

Nr.	Artikel	Seite	Nr.	Artikel	Seite
10105	Sechskantschrauben mit Flansch nach MBN 10105	388	82546	Kabelbinder-Befestigung LKC/SB	651
13023	Sechskantmutter mit Flansch und Klemmteil n. MBN 13023	396	82550	Kabelbinder-Befestigung MB - CA	651
13024	Leichtbaumuttern mit Flansch	396	82553	Kabelbinder-Befestigung MB - A	651
82001	LINDAPTER-Klemmelemente Typ A	652	82554	Befestigungssockel SolidTack-Serie	652
82002	LINDAPTER-Klemmelemente Typ B	653	82560	Kabelbinder-Befestigung LCL 8	652
82003	LINDAPTER-Klemmelemente Typ BS	659	82565	Kabelbinder-Befestigung Sortimentskasten	652
82007	LINDAPTER-Klemmelemente Typ D 2	657	82580	Kabelbündelschlauch Helawrap	652
82008	LINDAPTER-Klemmelemente Typ FL-D	661	82934	Sortimentskästen Muttern mit Regelgewinde	170
82009	LINDAPTER-Trägerklemmen Typ F 9	659	82935	Sortimentskästen Muttern mit Regelgewinde/Feingewinde	170
82010	LINDAPTER-Klemmelemente LR	657	82985	Sortimentskästen Muttern mit Klemmteil	201
82011	LINDAPTER-Ausgleichscheiben CW	654	83125	Scheiben nach ANSI B 18.22.1	415
82012	LINDAPTER-Ausgleichscheiben P1 kurz	654	83912	Zylinderschrauben mit Innensechskant nach ASME B 18.3	415
82013	LINDAPTER-Ausgleichscheiben P2 kurz	655	83931	Sechskantschrauben mit Schaft nach ASME B 18.2.1	410
82015	LINDAPTER-Ausgleichscheiben P1 lang	657	83933	Sechskantschrauben mit Gewinde bis Kopf nach ASME B 18.2.1	412
82016	LINDAPTER-Ausgleichscheiben P2 lang	657	83934	Sechskantmutter nach ASME B 18.2.2	414, 592
82019	LINDAPTER-Floor-Fast FF	661	83936	Niedrige Sechskantmutter nach ASME B 18.2.2	415
82021	LINDAPTER-Platten W	655	84032	Sechskantmutter mit Klemmteil - Biloc	200, 510
82022	LINDAPTER-Flanschklemmen F3	661	87010	Mutter für T-Nuten für Profil 5	445
82024	LINDAPTER-Kipp-Anker TC	660	87011	Mutter für T-Nuten für Profil 6	445
82025	LINDAPTER-Klemmen LC	661	87012	Mutter für T-Nuten für Profil 8	445
82031	LINDAPTER-Hollo-Bolt HB	659	87013	Mutter für T-Nuten für Profil 10	446
82033	LINDAPTER-Montagemutter für HOLLO-BOLT FlushFit	660	87014	Hammermutter für Profil 8	446
82040	LINDAPTER-Klemmelemente Typ AF	655	87015	Hammermutter für Profil 10	446
82041	LINDAPTER-Rezessfüllplatten Typ AF-W	656	88001	Zierkappen mit Stift für Kreuzschlitz	424, 644
82042	LINDAPTER-Ausgleichscheiben AF-W	656	88002	Zierkappen für Kreuzschlitzprofil Z	427, 609, 644
82043	LINDAPTER-Ausgleichscheiben AF-P1	656	88003	Abdeckkappen für Kappenschrauben	360, 577, 644
82044	LINDAPTER-Ausgleichscheiben AF-P2	656	88004	Zierkappen für Kreuzschlitzprofil H	361, 578, 645
82045	LINDAPTER-Klemmen CF	656	88005	Kombi-Dichtungen für DIN 571	645
82046	LINDAPTER-Klemmen LS	658	88006	Zierkappen für Innensechsrund-Antrieb	420, 449, 645
82047	LINDAPTER-Ausgleichscheiben LS-P2	658	88008	Abdeckkappen für Fassadenschrauben	602, 645
82048	LINDAPTER-Klemmen BR	658	88023	Rohrklapstecker	394
82049	LINDAPTER-Klemmen AAF	656	88032	Heico-Lock-Scheiben	433, 600
82051	LINDAPTER-Hebeösen ALP	656	88033	HEICO-LOCK Ringsicherungsscheiben	433
82058	LINDAPTER-Trägerklemmen FL-M	661	88034	HEICO-LOCK Keilsicherungsmutter	434
82094	Sortimentskästen Splinte	69	88035	HEICO-LOCK Kombi-Scheiben	434, 601
82125	Sortimentskästen Scheiben	71	88060	Kurvenstücke für Schrägzuganker	687
82127	Sortimentskästen Scheiben/Federringe	74	88061	Paßscheiben für Kurvenstücke	688
82400	MTH-Klemmplatten Nova-Grip	661	88081	Nutmutter GUK	416
82471	Sortimentskästen Sicherungsscheiben	90	88086	Sechskant-Abstandsbolzen/Distanzbolzen	416
82481	Sortimentskästen Spannstifte	220	88087	Verbindungsmuffen, sechskant	417, 592
82500	Kabelbinder T	649	88088	Verbindungsmuffen, rund	417, 592
82505	Kabelbinder T-HS	649	88089	Rundmutter mit Trapezgewinde	417, 592
82510	Kabelbinder T-W	649	88090	Sechskantmutter mit Trapezgewinde	417
82515	Kabelbinder T-HR	649	88091	SPAX-Schrauben, Innensechsrund	417, 593
82516	Flachkopf-Kabelbinder	649	88092	SPAX-Schrauben Liko	420, 593
82517	Kabelbinder innenverzahnt, Q-tie Serie	650	88093	SPAX-Schrauben Ruko	421, 593
82518	Kabelbinder mit Befestigungselement	650	88094	SPAX-Schrauben Seko	421, 594
82520	Kabelbinder LK	649	88095	Spanplattenschrauben, Linsensenkopf	645
82521	Befestigungsbinder EdgeClip-Familie	650	88096	Spanplattenschrauben, Halbrundkopf	595
82522	Befestigungsbinder EdgeClip-Familie	650	88099	SPAX-Schrauben, Senkkopf, mit Innenloch	424
82523	Befestigungsbinder EdgeClip-Familie	650	88100	Scheiben Artikel 1	427
82535	Verarbeitungsgerät für Kabelbinder	651	88101	CUPAL-Scheiben	645
82540	Kabelbinder-Befestigung TY-G 1	651	88102	Fugenscheiben	427
82543	Kabelbinder-Befestigung NY/SB	651	88104	Kotflügelscheiben	428, 596

Nr.	Artikel	Seite	Nr.	Artikel	Seite
88105	THERMAG-Muttern	199	88198	SPAX-M-Schrauben	425
88106	Setzmuttern	428, 596	88200	Gewindenfurchende Schrauben für Kunststoffe - RST	436
88107	Flachrundschrauben/Bordwandschrauben mit Schlitz	428, 596	88202	Gewindenfurchende Schrauben für Kunststoff mit Scheibe - RST	437
88108	Einschlagmuttern	428	88203	Gewindenfurchende Schrauben für Kunststoffe - RSTplus	437
88109	Käfigmuttern	428	88204	Gewindenfurchende Schrauben für Kunststoff mit Scheibe - RST	437
88110	Diebstahlhemmende Holzschrauben	429	88215	Flügelmuttern, kleine Form	78, 464
88111	Diebstahlhemmende metrische Schrauben mit Zweiloch, Flako	596	88251	Käppi für Innensechskantschrauben	645
88112	Diebstahlhemmende metrische Schrauben mit Zweiloch, Seko	596	88276	Fassadenschrauben BZ	602
88113	Diebstahlhemmende metrische Schrauben mit ISK und Pin, Flako	597	88277	Dichtscheiben	603, 646
88114	Diebstahlhemmende Blechschrauben mit PIN-ISR, Liko	597	88296	Spenglerschrauben	603
88115	Diebstahlhemmende Blechschrauben mit PIN-ISR, Seko	597	88301	ENSAT-Eindreh-Werkzeuge, Handmontage	437
88116	Diebstahlhemmende metrische Schrauben mit PIN-ISR, Flako	598	88302	ENSAT-Gewindeeinsätze Typ 302	603
88117	Diebstahlhemmende metrische Schrauben mit PIN-ISR, Seko	598	88305	ENSAT-Eindreh-Werkzeug, Maschinenmontage	437
88118	Diebstahlhemmende Muttern/Abreiß-Muttern	598	88307	ENSAT-Gewindeeinsätze Typ 307	603
88119	LOCKTIX-Scheiben	432	88312	Zylinder-Blechschrauben mit Innensechskant	574
88120	SCHNORR-Sicherungsscheiben S	429, 598	88330	AMECOIL-Gewindeeinsätze, Regelgewinde, Typ SR, DIN 8140	603
88121	SCHNORR-Sicherungsscheiben VS	429, 599	88331	AMECOIL-Gewindeeinsätze, Feingewinde, DIN 8140	603
88122	Achsen-Klemmringe	430	88333	AMECOIL-Einbaugeräte	604
88123	TECKENTRUP-Sperrkantscheiben S	430, 599	88334	AMECOIL-Einbauzubehör	604
88124	TECKENTRUP-Sperrkantscheiben M	430, 599	88335	AMECOIL-Einbauwerkzeug	604
88125	TECKENTRUP-Sperrkantscheiben B	430, 599	88336	AMECOIL-Zapfenbrecher	604
88126	TECKENTRUP-Sperrkantscheiben Z	431	88337	AMECOIL-Ausdrehwerkzeug	605
88129	TECKENTRUP-Sperrkantscheiben K	431, 600	88338	AMECOIL-Gewindeschneider	605
88130	Sperrkantringe VSK	431, 600	88339	AMECOIL-Gewinde-Vorbohrer	605
88131	Sperrkantringe VSK-Z	431	88342	AMECOIL-Sortimente Minikit Typ SR	605
88132	NORD-LOCK-Scheiben	432, 600	88343	AMECOIL Werkstatkasten	605
88133	Schraubösen Typ 1	434	88344	AMECOIL-Sortimente SR	605
88135	S-Haken, Typ 45	434	88346	AMECOIL-Gewindeeinsätze, selbstsichernd, Typ SR, DIN 8140	605
88136	Schraubösen Typ 48	434, 601	88381	TOX-Dübel 4 AS K	686
88137	Gerade Schraubhaken, Typ 4	435	88382	TOX-Dübel Typ Tri	686
88138	Gerade Schraubhaken, Typ 4E	435	88383	TOX-Dübel TypTrika	686
88139	Schlitzschraubhaken Typ 7	435	88401	Blindnieten, FLAKO, Stahl Zn/Stahl Zn, offen	689
88140	Schraubhaken Typ 11	435	88402	Blindnieten, FLAKO, Al.-Leg./Stahl Zn, offen	689
88141	Schraubhaken Typ 11 K	435	88403	Blindnieten, FLAKO, Al.-Leg./A 2, offen	690
88142	Schraubhaken Typ 11 E	435	88404	Blindnieten, FLAKO, A 2/A 2, offen	690
88143	Winkelschraubhaken Typ 10	436	88405	Blindnieten, FLAKO, A 2/Stahl Zn, offen	691
88144	Starke Deckenhaken Typ18	436	88406	Blindnieten, FLAKO, Kupfer/Stahl Zn, offen	691
88145	Starke Deckenhaken Typ18E	436	88407	Blindnieten, FLAKO, Kupfer/Bronze, offen	691
88149	Stockschrauben	436, 601	88408	Blindnieten, FLAKO, Kunststoff, offen	691
88151	RUV-Scheiben, Edelstahl	602	88409	Blindnieten, großer FLAKO, Al.-Leg./Stahl Zn, offen	692
88152	RUV-Scheiben, Kunststoff	645	88410	Blindnieten, FLAKO, Al.-Leg./Al.-Leg., offen	690
88153	RUV-Muttern	602	88411	Blindnieten, SEKO, Stahl Zn/Stahl Zn, offen	692
88176	Fassadenschrauben A	602	88412	Blindnieten, SEKO, Al.-Leg./Stahl Zn, offen	692
88187	SPAX-Fensterbauschrauben FEX-A	426	88413	Blindnieten, großer FLAKO, Stahl Zn/Stahl Zn, offen	693
88188	SPAX-Fensterbauschrauben FEX-KS	426	88414	Blindnieten, großer FLAKO, Al.-Leg./Al.-Leg., offen	693
88189	SPAX-Fensterbauschrauben FEX-H	426	88415	Blindnieten, FLAKO, A 4/A 4, offen	690
88190	SPAX-Glasleistenschrauben	425, 594	88416	Blindnieten, großer FLAKO, Al.-Leg./A 2, offen	693
88191	SPAX-Pfostenschrauben	594	88417	Blindnieten, FLAKO, Al.-Leg./Stahl Zn, offen, lackiert	691
88192	SPAX-Schrauben D	594	88418	Blindniet-Muttern rund, kleiner SEKO	696
88193	SPAX-Schrauben T	424, 594	88419	Blindnieten gerillt, FLAKO, Al.-Leg./Stahl Zn, offen	693
88195	SPAX-Schrauben SF	425	88420	Blindnieten, FLAKO, geschlossen, CAP-F	694
88196	SPAX-Schrauben FB	420	88421	Blindnieten mit Gewindeanschluß, offen	694
88197	SPAX-Schrauben R	425	88422	Blindnieten mit Spreizschaft, FLAKO, offen	694

Nr.	Artikel	Seite	Nr.	Artikel	Seite
88423	Blindniet-Muttern, rund, FLAKO, offen	697	88547	FISCHER-Nagelanker FNA-M	672
88424	Blindniet-Muttern, rund, SEKO, offen	697	88548	FISCHER-Nagelanker FNA-OE	672
88440	WVG-Handnietzangen	700	88549	FISCHER-Nagelanker FNA-H	672
88441	WVG-Sortimente	700	88551	FISCHER-Langschaftdübel SXRL	675
88443	WVG-Akku-Nieter	701	88554	FISCHER-Dübel SX	678
88474	Mehrbereichs-Blindnieten PolyGrip, FLAKO, offen	695	88556	FISCHER-Abdeckkappen ADF	677
88475	Mehrbereichs-Blindnieten PolyGrip, großer FLAKO	695	88558	FISCHER-Schellen FC	680
88476	Blindnieten MEGA-Grip, FLAKO	696	88559	FISCHER-Schellen Sch	680
88477	Blindnieten MEGA-Grip, SEKO	696	88561	FISCHER-Ankerbolzen FAZ	666
88480	Blindniet-Muttern rund, geschlossen, F	698	88562	FISCHER-Injektions-Ankerhülsen	666
88481	Blindniet-Muttern rund, geschlossen, S	698	88563	FISCHER-Rahmendübel FUR-T	676
88483	Blindniet-Muttern sechskant, FLAKO	699	88564	FISCHER-Rahmendübel FUR-SS	676
88484	Blindniet-Muttern sechskant, kleiner SEKO	699	88565	FISCHER-Montage-Schaum FPU 500	681
88488	Blindnieten TRI-FOLD, FLAKO	694	88567	FISCHER-Einschlaganker EA	671
88490	Mehrbereichsblindnietmuttern mit Flachkopf	699	88568	FISCHER-Setzwerkzeug EAW-H	671
88491	Mehrbereichsblindnietmuttern mit Senkkopf	699	88578	FISCHER-Injektions-Kunstharz FIS-HB 345 S	662
88493	Blindnieten, FLAKO, Monel/A 4, offen	690	88579	FISCHER-Highbond-Anker und Zubehör	662
88494	DUBO-Schraubensicherungen für Sechskantschrauben	646	88580	FISCHER-Dämmstoffteller DT	681
88495	DUBO-Schraubensicherungen für Innensechskantschrauben	646	88582	FISCHER-Bolzen FBN	672
88496	DUBO-Zahntellerringe	646	88583	FISCHER-Zykon-Anker FZA	669
88497	KORREX-Schutzkappen für Muttern	646	88584	FISCHER-Zykon-Anker FZA-D	670
88498	KORREX-Isolierhülsen	646	88585	FISCHER-Zykon-Anker FZA-I	670
88499	KORREX-Rosetten	647	88587	FISCHER-Bundbohrer FZUB für Zykon	671
88500	FISCHER-Dübel S	678	88588	FISCHER-Einschlaggerät FZE für Zykon	671
88503	FISCHER-Nageldübel N	676	88589	FISCHER-Zykon-Anker FZA-ST	670
88506	FISCHER-Dübel M-S	679	88590	FISCHER-Dübel FH-H	669
88507	FISCHER-Gasbetondübel GB	679	88592	FISCHER-Dübel FH-B	669
88509	FISCHER-Kippdübel K	679	88593	FISCHER-Dübel FH-S	668
88510	FISCHER-Dübel M	679	88594	FISCHER-Dübel FH-SK	669
88511	FISCHER-Montagezange für HM-S	679	88595	FISCHER-Einschlaggeräte FZED	671
88512	FISCHER-Hohlraum-Metaldübel HM-S	679	88597	FISCHER-Zykon-Einschlaganker	670
88513	FISCHER-Hohldecken-Anker FHY	674	88598	FISCHER-Gipskartonplattendübel GK/GK-M	680
88514	FISCHER-Dämmstoffhalter DHK	681	88654	SPAX-BIT	688
88515	FISCHER-Justierschraube JUSS	677	88663	SPAX-BIT - Sortimente	688
88516	FISCHER-Fensterrahmendübel F-S	677	88665	Schraubklängen/Bits für Zweilochschrauben	688
88518	FISCHER-Kippdübel KD	679	88666	Schraubklängen/Bits für PIN-Innensechskant	688
88519	FISCHER-Kippdübel KDH	680	88667	Schraubklängen/Bits für ZweilochschraubePIN-ISR	689
88520	FISCHER-Universaldübel UX, UX-R	677	88680	FISCHER-Metallrahmen-Dübel	677
88521	FISCHER-Messingdübel PA 4	679	88681	FISCHER-Abdeckkappen ADM	677
88522	FISCHER-Injektions-Kartuschen FIS-V 360 S	663	88682	FISCHER-Abdeckkappen ASM	677
88523	FISCHER-Injektions-Gewindestangen FIS-G	665	88683	FISCHER-Schwerlastanker TA-M	673
88524	FISCHER-Auspresspistolen für FIS	663	88684	FISCHER-FIS-Verlängerungsschlauch	664
88525	FISCHER-Statikmischer für FIS	663	88685	FISCHER-Ausbläser	663
88526	FISCHER-Ankerhülsen für FIS-HN	666	88686	FISCHER-Superbond Mörtel FIS SB	663
88527	FISCHER-Montagemörtel	663	88687	FISCHER-Reaktionspatronen RSB	662
88528	FISCHER-Abdeckkappen ADT	676	88688	FISCHER-Porenbetonanker FPX-I	674
88529	FISCHER-Injektions-Anker FIS-E	666	88689	FISCHER-Hochleistungsanker FH II-I	669
88530	FISCHER-Schwerlastdübel SL-M	674	88690	FISCHER-Dübel DUOPOWER	678
88531	FISCHER-Mauer-Schrauben MR	674	88693	FISCHER-Bolzenanker-Setzgerät FA-ST	668
88534	FISCHER-Gewindestangen RGM	665	88694	FISCHER-Ankerbolzen FBZ	668
88536	FISCHER-Gerüstbefestigung	680	88695	FISCHER Abstandsmontagesystem Thermax	681
88542	FISCHER-Rahmen-Dübel	674	88696	FISCHER-Dämmstoffdübel FID	681
88545	FISCHER-Metallspreizdübel FMD	678	88714	UPAT-Innengewindehülsen UKA 3-IST	683
88546	FISCHER-Nagelanker FNA	672	88715	UPAT-Express-Anker EXA, EXA kurz, EXA-IG	673

Nr.	Artikel	Seite	Nr.	Artikel	Seite
88716	UPAT-Einschlaganker USA	682	88943	Hammerkopf-/Halben-Schrauben Typ HZS 38/23 DYNAGRIP	443, 606
88717	UPAT-Setzwerkzeuge USA-SW	682	88944	Hammerkopf-/Halben-Schrauben Typ HZS 53/34	444, 606
88718	UPAT-Ausbläser zur Bohrlochsäuberung	685	88950	Hakenkopf-Schrauben Typ 50/30	444, 607
88720	UPAT-Verbund-Anker UKA 3-P, Patronen	684	88951	Hammerkopf-Gewindeplatten Typ 28/15	444
88722	UPAT-Ankerstangen ASTA für UKA 3-P	683	88952	Hammerkopf-Gewindeplatten Typ 38/17	444
88733	UPAT-Kartuschen UPM-44	684	88953	Hammerkopf-Gewindeplatten Typ 50/30	445
88734	UPAT-Gewindestangen UPM-A	683	88954	Hakenkopf-Gewindeplatten Typ 40/22	445
88735	UPAT-Siebhülsen UPM-SH	684	88955	Hakenkopf-Gewindeplatten Typ 50/30	445
88738	UPAT-Statikmischer UMP-SM	685	88964	Hülsenmuttern	607, 647
88741	UPAT-Expressanker MAX	681	88965	Rosettenscheiben, offen	647
88752	Federklapp-Bolzen/ES-Bolzen für DIN 71752	410	88966	Rosettenscheiben, geschlossen	647
88760	UPAT-Setzwerkzeuge MW-SDS	686	88972	Hakenkopf-Schrauben Typ 72/48	444
88764	UPAT-Expressanker IMC	682	88981	Kappen-Blechschauben	360, 577
88765	UPAT-Adapter SDS Plus	686	89010	SPAX-Rahmenanker SEKO	426
88766	UPAT-Adapter SDS Max	686	89011	SPAX-Rahmenanker ZYKO	426
88769	UPAT-Reinigungsbürsten BS	685	89012	Kappen für SPAX-Rahmenanker	426
88770	UPAT-Innengewindeanker UPM-I	684	89013	Kappen für SPAX mit Kopfbohrung	424
88771	UPAT-UPM Ausdrückpistole Metall	685	89014	SPAX-Schrauben für Holz, Glas und Fassaden mit Zylinderkopf	426
88772	UPAT-Injektionsmörtel UPM 55	684	89015	SPAX-Verlegeschrauben für OSB- und Spanplatten	427
88774	UPAT-Injektionsmörtel UPM 33	685	89017	SPAX-Einschraubhülse für SPAX-Gewindestangen ohne Kopf	688
88775	UPAT-Injektionsmörtel UPM 11	685	89018	SPAX-Fassadenschrauben mit Linsenkopf	595
88776	UPAT-Adapter SK SW	686	89019	SPAX-Fassadenschrauben mit kleinem Linsenkopf und Fixiergewinde	595
88902	MULTI-MONTI-Schraubanker, MMS-Plus, Sechskant	687	89021	SPAX Sortiment L-BOXX/L-BOXX mini	420
88903	MULTI-MONTI-Stockanker, MMSplus	687	89091	Holzbauschrauben, Senkkopf	446
88905	MULTI-MONTI-Schraubanker, MMSplus, Senkkopf F	687	89092	Holzbauschrauben, Tellerkopf	447
88908	MULTI-MONTI-Schraubanker, MMSplus	687	89096	Spanplattenschrauben, Halbrundkopf	447, 607
88910	Messing-Spreizdübel	686	89097	Spanplattenschrauben, Senkkopf, Kreuzschlitz	448, 607
88912	RIPP-Schrauben mit Innensechskant	438	89098	Spanplattenschrauben, Senkkopf, Innensechsrund	449, 608
88913	RIPP-Schrauben mit Sechskant	438	89150	Schnellbauschrauben mit Trompetenkopf u. Grobgewinde	450
88914	RIPP-Muttern	440	89151	Schnellbauschrauben mit Trompetenkopf u. Feingewinde	451
88916	Sicherungsmuffen für HV-Verbindungen	402	89152	Schnellbauschrauben mit Trompetenkopf u. Bohrspitze	451
88917	EPDM-Dichtungen für Stockschrauben	647	89184	Senkscheiben	447
88928	Hammerkopf-Schrauben Typ 28/15	442, 606	89192	Terrassenschrauben, Senkkopf	609
88933	Sperrzahnschrauben	441	89571	Sechskantholzschrauben	450
88934	Sperrzahnmuttern	442	89601	Baubolzen mit Mutter	450
88938	Hammerkopf-Schrauben Typ 38/17	443, 606			
88940	Hakenkopf-Schrauben Typ 40/22	443, 606			
88941	Halben-Schrauben HZS Typ 41/22	443, 606			

Abmessungen	VE Stück	€/100/Obf.
DIN 00001.002		

1 **Stahl** **Form B**

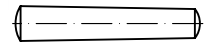

Kegelstifte
Kegel 1 : 50
B = gedreht

Maße → **TI-117** REACH → **TI-262**
Normumstellung → **TI-10**

Rostfrei → **S. 453**

DIN 1 → wird ersetzt durch ISO 2339 (DIN EN 22339)



Form - Ø x Länge (ohne Kuppen)

B 1	x	12	S	200	12,10
B 1	x	18	S	200	13,40
B 1,5	x	10	S	200	11,40
B 1,5	x	12	S	200	12,10
B 1,5	x	16	S	200	13,10
B 1,5	x	20	S	200	13,70
B 2	x	10	S	100	12,40
B 2	x	12	S	100	13,10
B 2	x	14	S	100	13,40
B 2	x	16	S	100	13,80
B 2	x	18	S	100	14,30
B 2	x	20	S	100	14,70
B 2	x	30	S	100	17,70
B 2	x	32	S	100	18,40
B 2	x	36	S	100	19,50
B 2	x	40	S	100	20,60
B 2	x	50	S	100	24,00
B 2,5	x	14	S	100	15,20
B 2,5	x	16	S	100	15,40
B 2,5	x	20	S	100	17,00
B 2,5	x	30	S	100	20,40
B 2,5	x	40	S	100	25,00
B 3	x	10	S	100	14,20
B 3	x	12	S	100	14,60
B 3	x	14	S	100	15,40
B 3	x	16	S	100	16,10
B 3	x	18	S	100	17,00
B 3	x	20	S	100	17,50
B 3	x	24	S	100	19,00
B 3	x	26	S	100	20,70
B 3	x	28	S	100	21,50
B 3	x	30	S	100	22,20
B 3	x	32	S	100	23,30
B 3	x	36	S	100	24,40
B 3	x	40	S	100	26,00
B 3	x	45	S	100	29,00
B 3	x	50	S	100	31,50
B 3	x	60	S	100	39,50
B 4	x	12	S	100	16,70
B 4	x	14	S	100	17,50
B 4	x	16	S	100	18,70
B 4	x	18	S	100	19,40
B 4	x	20	S	100	20,10
B 4	x	22	S	100	21,70
B 4	x	24	S	100	23,20
B 4	x	26	S	100	23,60
B 4	x	28	S	100	24,60
B 4	x	30	S	100	26,50
B 4	x	32	S	100	27,50
B 4	x	36	S	100	29,50
B 4	x	40	S	100	31,50

Abmessungen	VE Stück	€/100/Obf.			
B 4	x	45	S	100	36,00
B 4	x	50	S	100	39,00
B 4	x	55	S	100	43,00
B 4	x	60	S	100	46,00
B 4	x	70	S	100	56,00
B 4	x	80	S	100	59,00
B 4	x	100	S	100	79,00
B 5	x	16	S	100	19,40
B 5	x	18	S	100	20,60
B 5	x	20	S	100	22,00
B 5	x	22	S	100	23,30
B 5	x	24	S	100	24,60
B 5	x	26	S	100	26,50
B 5	x	28	S	100	27,50
B 5	x	30	S	100	29,50
B 5	x	32	S	100	31,50
B 5	x	36	S	100	34,00
B 5	x	40	S	100	38,00
B 5	x	45	S	100	41,00
B 5	x	50	S	100	44,50
B 5	x	55	S	100	48,50
B 5	x	60	S	100	56,00
B 5	x	65	S	50	62,00
B 5	x	70	S	50	66,00
B 5	x	80	S	50	72,00
B 5	x	90	S	50	78,00
B 5	x	100	S	50	86,00
B 6	x	20	S	100	26,50
B 6	x	24	S	100	31,00
B 6	x	26	S	100	33,00
B 6	x	28	S	100	36,00
B 6	x	30	S	100	38,50
B 6	x	32	S	100	41,00
B 6	x	36	S	100	43,00
B 6	x	40	S	100	46,00
B 6	x	45	S	100	49,50
B 6	x	50	S	100	54,00
B 6	x	55	S	50	62,00
B 6	x	60	S	50	68,00
B 6	x	70	S	50	78,00
B 6	x	80	S	50	86,00
B 6	x	90	S	50	97,00
B 6	x	100	S	50	112,00
B 6	x	120	S	50	207,00
B 6,5	x	40	S	100	63,00
B 6,5	x	50	S	100	77,00
B 6,5	x	60	S	50	96,00
B 6,5	x	100	S	50	163,00
B 7	x	60	S	50	147,00
B 7	x	70	S	50	172,00
B 7	x	80	S	50	189,00
B 7	x	100	S	50	275,00
B 8	x	24	S	50	47,50
B 8	x	26	S	50	51,00
B 8	x	28	S	50	54,00
B 8	x	30	S	50	57,00
B 8	x	32	S	50	61,00
B 8	x	36	S	50	65,00
B 8	x	40	S	50	67,00
B 8	x	45	S	50	68,00
B 8	x	50	S	50	84,00
B 8	x	55	S	50	95,00
B 8	x	60	S	50	103,00
B 8	x	70	S	50	118,00
B 8	x	80	S	50	130,00
B 8	x	90	S	50	157,00
B 8	x	100	S	50	184,00
B 8	x	110	S	50	205,00
B 8	x	120	S	50	224,00
B 8	x	130	S	50	295,00
B 8	x	140	S	50	315,00
B 8	x	150	S	50	385,00
B 10	x	28	S	50	84,00
B 10	x	30	S	50	91,00
B 10	x	32	S	50	95,00

Abmessungen	VE Stück	€/100/Obf.			
B 10	x	36	S	50	105,00
B 10	x	40	S	50	111,00
B 10	x	45	S	50	118,00
B 10	x	50	S	50	123,00
B 10	x	55	S	25	151,00
B 10	x	60	S	25	164,00
B 10	x	70	S	25	189,00
B 10	x	80	S	25	210,00
B 10	x	90	S	25	223,00
B 10	x	100	S	25	255,00
B 10	x	110	S	25	275,00
B 10	x	120	S	25	295,00
B 10	x	130	S	25	345,00
B 10	x	140	S	25	365,00
B 10	x	150	S	25	385,00
B 12	x	30	S	25	121,00
B 12	x	36	S	25	132,00
B 12	x	40	S	25	142,00
B 12	x	45	S	25	160,00
B 12	x	50	S	25	165,00
B 12	x	55	S	25	182,00
B 12	x	60	S	25	197,00
B 12	x	70	S	25	230,00
B 12	x	80	S	25	255,00
B 12	x	90	S	25	275,00
B 12	x	100	S	25	325,00
B 12	x	110	S	10	385,00
B 12	x	120	S	10	455,00
B 12	x	130	S	10	540,00
B 12	x	140	S	10	580,00
B 12	x	150	S	10	610,00
B 13	x	50	S	25	355,00
B 13	x	60	S	25	255,00
B 13	x	70	S	25	315,00
B 13	x	80	S	25	345,00
B 13	x	100	S	25	430,00
B 13	x	120	S	10	540,00
B 13	x	130	S	10	660,00
B 13	x	150	S	10	760,00
B 14	x	50	S	25	245,00
B 14	x	80	S	25	370,00
B 14	x	100	S	25	495,00
B 14	x	120	S	10	620,00
B 14	x	140	S	10	770,00
B 16	x	40	S	10	290,00
B 16	x	50	S	10	335,00
B 16	x	60	S	10	380,00
B 16	x	70	S	10	440,00
B 16	x	80	S	10	480,00
B 16	x	90	S	10	530,00
B 16	x	100	S	10	600,00
B 16	x	120	S	10	720,00
B 16	x	140	S	10	890,00
B 16	x	150	S	1	1060,00
B 16	x	165	S	1	1580,00
B 16	x	180	S	1	1690,00
B 16	x	200	S	1	1810,00
B 20	x	50	S	10	940,00
B 20	x	60	S	10	1060,00
B 20	x	70	S	10	1150,00
B 20	x	80	S	10	1210,00
B 20	x	100	S	10	1470,00
B 20	x	120	S	1	1670,00
B 20	x	140	S	1	2050,00
B 20	x	150	S	1	2300,00

Abmessungen VE Stück €/100/Obf.
 DIN 00007.000

7

Stahl

m6

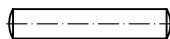

Zylinderstifte, Toleranzfeld m6

Maße → TI-116

REACH → TI-262

Normumstellung → TI-10

Rostfrei → S. 453

DIN 7 → wird ersetzt durch ISO 2338

RoHS



∅ - Tol. x Länge (ohne Kuppen)

1 m6 x 3	S 1000	9,40
1 m6 x 4	S 1000	9,40
1 m6 x 5	S 1000	9,40
1 m6 x 6	S 1000	9,40
1 m6 x 8	S 1000	9,40
1 m6 x 10	S 1000	9,40
1 m6 x 12	S 1000	9,50
1,5 m6 x 4	S 1000	9,40
1,5 m6 x 5	S 1000	9,40
1,5 m6 x 6	S 1000	9,40
1,5 m6 x 8	S 1000	9,50
1,5 m6 x 10	S 1000	9,50
1,5 m6 x 12	S 1000	9,70
1,5 m6 x 14	S 1000	9,70
1,5 m6 x 16	S 1000	10,10
1,5 m6 x 18	S 1000	10,20
1,5 m6 x 20	S 1000	10,50
2 m6 x 4	S 1000	9,10
2 m6 x 5	S 1000	9,50
2 m6 x 6	S 1000	9,70
2 m6 x 8	S 1000	9,70
2 m6 x 10	S 1000	9,70
2 m6 x 12	S 1000	10,10
2 m6 x 14	S 1000	10,10
2 m6 x 16	S 1000	10,20
2 m6 x 18	S 1000	10,50
2 m6 x 20	S 1000	11,10
2 m6 x 24	S 1000	11,70
2 m6 x 28	S 1000	13,10
2 m6 x 30	S 1000	13,40
2,5 m6 x 5	S 1000	9,70
2,5 m6 x 6	S 1000	9,70
2,5 m6 x 8	S 1000	10,10
2,5 m6 x 10	S 1000	10,10
2,5 m6 x 12	S 1000	10,20
2,5 m6 x 14	S 1000	10,50
2,5 m6 x 16	S 1000	10,70
2,5 m6 x 18	S 1000	11,10
2,5 m6 x 20	S 1000	11,30
2,5 m6 x 24	S 1000	11,80
2,5 m6 x 28	S 1000	13,10
2,5 m6 x 30	S 1000	13,50
2,5 m6 x 32	S 1000	13,60
3 m6 x 5	S 1000	6,70
3 m6 x 6	S 1000	6,70
3 m6 x 8	S 1000	6,80
3 m6 x 10	S 1000	7,20
3 m6 x 12	S 1000	7,60
3 m6 x 14	S 1000	7,80
3 m6 x 16	S 1000	7,90
3 m6 x 18	S 1000	10,20
3 m6 x 20	S 1000	10,60

Abmessungen VE Stück €/100/Obf.

3 m6 x 24	S 1000	12,10
3 m6 x 28	S 1000	13,10
3 m6 x 30	S 1000	13,40
3 m6 x 32	S 1000	13,60
3 m6 x 36	S 500	18,40
3 m6 x 40	S 500	20,10
3 m6 x 50	S 500	27,50
4 m6 x 5	S 1000	10,80
4 m6 x 6	S 1000	10,80
4 m6 x 8	S 1000	11,30
4 m6 x 10	S 1000	11,70
4 m6 x 12	S 1000	12,10
4 m6 x 14	S 1000	12,80
4 m6 x 16	S 1000	13,40
4 m6 x 18	S 1000	13,80
4 m6 x 20	S 1000	14,70
4 m6 x 24	S 1000	15,80
4 m6 x 26	S 1000	16,10
4 m6 x 28	S 1000	16,40
4 m6 x 30	S 1000	17,00
4 m6 x 32	S 500	17,50
4 m6 x 36	S 500	18,40
4 m6 x 40	S 500	20,40
4 m6 x 45	S 500	26,00
4 m6 x 50	S 500	27,50
5 m6 x 5	S 500	11,70
5 m6 x 6	S 500	11,70
5 m6 x 8	S 500	12,10
5 m6 x 10	S 500	13,50
5 m6 x 12	S 500	14,10
5 m6 x 14	S 500	15,00
5 m6 x 16	S 500	15,40
5 m6 x 18	S 500	16,00
5 m6 x 20	S 500	17,10
5 m6 x 22	S 500	17,60
5 m6 x 24	S 500	18,00
5 m6 x 28	S 500	19,20
5 m6 x 30	S 500	20,60
5 m6 x 32	S 500	21,20
5 m6 x 36	S 500	21,60
5 m6 x 40	S 500	24,20
5 m6 x 45	S 500	26,00
5 m6 x 50	S 500	27,50
5 m6 x 55	S 500	36,50
5 m6 x 60	S 500	41,00
6 m6 x 6	S 500	14,10
6 m6 x 8	S 500	14,70
6 m6 x 10	S 500	15,70
6 m6 x 12	S 500	17,00
6 m6 x 14	S 500	18,00
6 m6 x 16	S 500	18,80
6 m6 x 18	S 500	19,80
6 m6 x 20	S 500	20,40
6 m6 x 22	S 500	20,90
6 m6 x 24	S 500	22,40
6 m6 x 26	S 500	22,80
6 m6 x 28	S 500	23,00
6 m6 x 30	S 500	24,20
6 m6 x 32	S 500	25,50
6 m6 x 36	S 500	27,50
6 m6 x 40	S 500	29,50
6 m6 x 45	S 500	32,50
6 m6 x 50	S 500	34,00
6 m6 x 55	S 500	36,50
6 m6 x 60	S 200	41,00
6 m6 x 70	S 200	77,00
6 m6 x 80	S 200	89,00
6 m6 x 90	S 200	153,00
6 m6 x 100	S 200	177,00
8 m6 x 8	S 500	21,30
8 m6 x 10	S 500	22,40
8 m6 x 12	S 500	22,90
8 m6 x 14	S 500	25,00
8 m6 x 16	S 500	26,50
8 m6 x 18	S 500	29,50

Abmessungen VE Stück €/100/Obf.

8 m6 x 20	S 500	30,50
8 m6 x 22	S 500	33,50
8 m6 x 24	S 500	35,00
8 m6 x 26	S 500	39,00
8 m6 x 28	S 500	41,00
8 m6 x 30	S 500	44,00
8 m6 x 32	S 500	45,50
8 m6 x 36	S 200	47,00
8 m6 x 40	S 200	52,00
8 m6 x 45	S 200	56,00
8 m6 x 50	S 200	59,00
8 m6 x 55	S 200	63,00
8 m6 x 60	S 200	68,00
8 m6 x 70	S 200	77,00
8 m6 x 80	S 200	89,00
8 m6 x 90	S 200	153,00
8 m6 x 100	S 200	195,00
10 m6 x 10	S 200	36,50
10 m6 x 12	S 200	38,00
10 m6 x 14	S 200	39,50
10 m6 x 16	S 200	42,50
10 m6 x 18	S 200	44,50
10 m6 x 20	S 200	47,00
10 m6 x 24	S 200	52,00
10 m6 x 28	S 200	57,00
10 m6 x 30	S 200	59,00
10 m6 x 32	S 200	62,00
10 m6 x 36	S 200	67,00
10 m6 x 40	S 200	74,00
10 m6 x 45	S 200	78,00
10 m6 x 50	S 200	85,00
10 m6 x 55	S 200	91,00
10 m6 x 60	S 200	97,00
10 m6 x 65	S 50	113,00
10 m6 x 70	S 50	121,00
10 m6 x 80	S 50	131,00
10 m6 x 90	S 50	153,00
10 m6 x 100	S 50	177,00
10 m6 x 120	S 50	223,00
12 m6 x 12	S 200	59,00
12 m6 x 14	S 200	60,00
12 m6 x 16	S 200	61,00
12 m6 x 18	S 200	62,00
12 m6 x 20	S 200	66,00
12 m6 x 24	S 200	69,00
12 m6 x 28	S 200	82,00
12 m6 x 30	S 200	86,00
12 m6 x 32	S 200	94,00
12 m6 x 36	S 200	103,00
12 m6 x 40	S 200	111,00
12 m6 x 45	S 100	128,00
12 m6 x 50	S 100	137,00
12 m6 x 55	S 100	147,00
12 m6 x 60	S 100	154,00
12 m6 x 70	S 100	167,00
12 m6 x 80	S 100	183,00
12 m6 x 90	S 100	200,00
12 m6 x 100	S 100	224,00
12 m6 x 120	S 100	255,00
13 m6 x 20	S 50	91,00
13 m6 x 28	S 50	115,00
13 m6 x 40	S 50	155,00
13 m6 x 50	S 25	193,00
13 m6 x 60	S 25	220,00
13 m6 x 70	S 25	244,00
13 m6 x 80	S 25	285,00
14 m6 x 20	S 25	99,00
14 m6 x 24	S 25	115,00
14 m6 x 28	S 25	121,00
14 m6 x 30	S 25	134,00
14 m6 x 32	S 25	143,00
14 m6 x 36	S 25	152,00
14 m6 x 40	S 25	165,00
14 m6 x 45	S 25	175,00
14 m6 x 50	S 25	200,00

Abmessungen	VE	Stück	€/100/Obf.
14 m6 x 55	S	25	205,00
14 m6 x 60	S	25	220,00
14 m6 x 70	S	25	255,00
14 m6 x 80	S	25	285,00
14 m6 x 90	S	25	315,00
14 m6 x 100	S	25	335,00
14 m6 x 120	S	25	360,00
16 m6 x 20	S	25	135,00
16 m6 x 24	S	25	153,00
16 m6 x 28	S	25	165,00
16 m6 x 30	S	25	176,00
16 m6 x 32	S	25	187,00
16 m6 x 36	S	25	201,00
16 m6 x 40	S	25	217,00
16 m6 x 45	S	25	239,00
16 m6 x 50	S	25	255,00
16 m6 x 55	S	25	265,00
16 m6 x 60	S	25	295,00
16 m6 x 70	S	25	335,00
16 m6 x 80	S	25	380,00
16 m6 x 90	S	25	415,00
16 m6 x 100	S	25	455,00
16 m6 x 120	S	25	540,00
20 m6 x 24	S	25	275,00
20 m6 x 28	S	25	285,00
20 m6 x 30	S	25	300,00
20 m6 x 32	S	25	310,00
20 m6 x 36	S	25	335,00
20 m6 x 40	S	25	360,00
20 m6 x 45	S	25	385,00
20 m6 x 50	S	25	415,00
20 m6 x 55	S	25	430,00
20 m6 x 60	S	25	470,00
20 m6 x 70	S	25	510,00
20 m6 x 80	S	25	540,00
20 m6 x 90	S	25	620,00
20 m6 x 100	S	25	680,00
20 m6 x 120	S	25	790,00
25 m6 x 40	S	10	1070,00
25 m6 x 45	S	10	1120,00
25 m6 x 50	S	10	1150,00
25 m6 x 60	S	10	1410,00
25 m6 x 70	S	10	1580,00
25 m6 x 80	S	10	1800,00
25 m6 x 90	S	10	1930,00
25 m6 x 100	S	10	2100,00
25 m6 x 120	S	10	2440,00
30 m6 x 50	S	10	2160,00
30 m6 x 60	S	10	2440,00
30 m6 x 70	S	10	2650,00
30 m6 x 80	S	10	2800,00
30 m6 x 90	S	10	3150,00
30 m6 x 100	S	10	3600,00
30 m6 x 120	S	10	4250,00

Abmessungen VE Stück €/100/Obf.

DIN 00084.004

84 Stahl blank gedreht

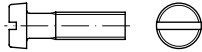

Zylinderschrauben mit Schlitz

Maße → TI-37 Normumstellung → TI-11
 Werkstoffeigensch. → TI-232 REACH → TI-262

Rostfrei → S. 455
 Messing → S. 611

DIN 84 → wird ersetzt durch ISO 1207 (austauschbar)

RoHS ✓

M 1 x 2	S	100	26,50 gedreht
M 1 x 3	S	100	28,00 gedreht
M 1 x 5	S	100	28,00 gedreht
M 1 x 6	S	100	28,50 gedreht
M 1 x 8	S	100	29,50 gedreht
M 1 x 10	S	100	34,00 gedreht
M 1,2 x 2	S	100	26,50 gedreht
M 1,2 x 3	S	100	26,50 gedreht
M 1,2 x 4	S	100	29,00 gedreht
M 1,2 x 6	S	100	29,00 gedreht
M 1,2 x 8	S	100	29,50 gedreht
M 1,2 x 10	S	100	32,00 gedreht
M 1,4 x 2	S	100	26,00 gedreht
M 1,4 x 3	S	100	26,00 gedreht
M 1,4 x 4	S	100	27,50 gedreht
M 1,4 x 5	S	100	28,00 gedreht
M 1,4 x 6	S	100	25,50 gedreht
M 1,4 x 8	S	100	30,50 gedreht
M 1,4 x 10	S	100	32,00 gedreht
M 1,4 x 16	S	100	39,50 gedreht
M 1,6 x 3	S	100	23,40 gedreht
M 1,6 x 4	S	100	24,70 gedreht
M 1,6 x 5	S	100	25,50 gedreht
M 1,6 x 6	S	100	26,50 gedreht
M 1,6 x 8	S	100	30,50 gedreht
M 1,6 x 10	S	100	31,50 gedreht
M 1,6 x 16	S	100	42,50 gedreht

Abmessungen VE Stück €/100/Obf.

DIN 00084.400

84 4.8

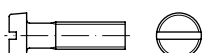

Zylinderschrauben mit Schlitz

Maße → TI-37 Normumstellung → TI-11
 Werkstoffeigensch. → TI-232 REACH → TI-262

Rostfrei → S. 455
 Messing, Kunststoff → S. 611

DIN 84 → wird ersetzt durch ISO 1207 (austauschbar)

RoHS ✓

M 2 x 3	S	2000	4,55
M 2 x 4	S	2000	3,65
M 2 x 5	S	2000	3,60

M 2 x 6	S	2000	3,15
M 2 x 8	S	2000	3,25
M 2 x 10	S	2000	3,35
M 2 x 12	S	2000	3,45
M 2 x 16	S	2000	3,90
M 2 x 20	S	2000	5,00
M 2,5 x 4	S	2000	5,10
M 2,5 x 5	S	2000	4,80
M 2,5 x 6	S	2000	3,00
M 2,5 x 8	S	2000	3,10
M 2,5 x 10	S	2000	3,30
M 2,5 x 12	S	2000	3,60
M 2,5 x 16	S	2000	4,15
M 2,5 x 18	S	2000	4,65
M 2,5 x 20	S	2000	4,85
M 2,5 x 25	S	2000	5,50
M 2,5 x 30	S	2000	7,20
M 3 x 3	S	2000	8,80
M 3 x 4	S	2000	5,30
M 3 x 5	S	2000	5,10
M 3 x 6	S	2000	1,35
M 3 x 8	S	2000	1,40
M 3 x 10	S	2000	1,45
M 3 x 12	S	2000	1,55
M 3 x 16	S	2000	1,75
M 3 x 18	S	2000	3,30
M 3 x 20	S	2000	3,60
M 3 x 22	S	2000	4,10
M 3 x 25	S	2000	4,30
M 3 x 30	S	2000	4,55
M 3 x 35	S	2000	4,85
M 3 x 40	S	1000	5,40
M 3 x 45	S	1000	7,80
M 3 x 50	S	1000	8,80
M 4 x 4	S	2000	9,60
M 4 x 5	S	2000	6,50
M 4 x 6	S	2000	2,15
M 4 x 8	S	2000	2,20
M 4 x 10	S	2000	2,25
M 4 x 12	S	2000	2,30
M 4 x 16	S	2000	2,75
M 4 x 20	S	2000	3,10
M 4 x 22	S	1000	3,40
M 4 x 25	S	1000	3,60
M 4 x 30	S	1000	4,20
M 4 x 35	S	1000	4,80
M 4 x 40	S	1000	5,30
M 4 x 45	S	1000	6,70
M 4 x 50	S	1000	8,20
M 4 x 55	S	500	12,30
M 4 x 60	S	500	13,50
M 4 x 65	S	500	15,00
M 4 x 70	S	500	21,10
M 5 x 6	S	2000	9,60
M 5 x 8	S	2000	3,25
M 5 x 10	S	2000	3,40
M 5 x 12	S	1000	3,65
M 5 x 16	S	1000	4,15
M 5 x 18	S	1000	5,70
M 5 x 20	S	1000	6,20
M 5 x 22	S	1000	7,30
M 5 x 25	S	1000	7,70
M 5 x 30	S	1000	8,00
M 5 x 35	S	500	8,20
M 5 x 40	S	500	9,20
M 5 x 45	S	500	9,70
M 5 x 50	S	500	10,20
M 5 x 55	S	500	13,50
M 5 x 60	S	200	13,90
M 5 x 70	S	200	15,00
M 5 x 75	S	200	27,50
M 5 x 80	S	200	32,00
M 6 x 8	S	1000	6,50
M 6 x 10	S	1000	5,30
M 6 x 12	S	1000	5,40



- ✓ Große Artikelvielfalt
- ✓ Verlässliche Qualität
- ✓ Hohe Lieferbereitschaft

Abmessungen	VE	Stück	€/100/Obf.	Abmessungen	VE	Stück	€/100/Obf.	Abmessungen	VE	Stück	€/100/Obf.
M 6 x 16	S	1000	5,90	M 2 x 18	K	200	8,00 gal Zn	M 3,5 x 16	S	2000	4,80 gal Zn
M 6 x 20	S	1000	6,70	M 2 x 20	S	2000	5,50 gal Zn	M 3,5 x 16	K	200	7,80 gal Zn
M 6 x 25	S	500	7,30	M 2 x 20	K	200	8,50 gal Zn	M 3,5 x 18	K	200	8,10 gal Zn
M 6 x 30	S	500	8,30	M 2 x 30	S	2000	10,80 gal Zn	M 3,5 x 20	S	2000	5,40 gal Zn
M 6 x 35	S	500	9,10	M 2 x 30	K	200	14,60 gal Zn	M 3,5 x 20	K	200	8,40 gal Zn
M 6 x 40	S	500	10,10	M 2,5 x 3	K	200	12,60 gal Zn	M 3,5 x 25	K	200	8,90 gal Zn
M 6 x 45	S	500	13,60	M 2,5 x 4	S	2000	5,60 gal Zn	M 3,5 x 30	K	200	10,50 gal Zn
M 6 x 50	S	200	15,50	M 2,5 x 4	K	200	8,60 gal Zn	M 3,5 x 35	K	200	12,10 gal Zn
M 6 x 55	S	200	17,70	M 2,5 x 5	S	2000	5,30 gal Zn	M 3,5 x 40	K	200	13,00 gal Zn
M 6 x 60	S	200	21,30	M 2,5 x 5	K	200	8,20 gal Zn	M 3,5 x 45	K	200	16,00 gal Zn
M 6 x 65	S	200	23,30	M 2,5 x 6	S	2000	3,30 gal Zn	M 3,5 x 50	K	200	19,30 gal Zn
M 6 x 70	S	200	24,50	M 2,5 x 6	K	200	6,30 gal Zn	M 4 x 4	S	2000	10,60 gal Zn
M 6 x 75	S	200	36,00	M 2,5 x 8	S	2000	3,35 gal Zn	M 4 x 4	K	200	13,40 gal Zn
M 6 x 80	S	200	40,00	M 2,5 x 8	K	200	6,20 gal Zn	M 4 x 5	S	2000	7,20 gal Zn
M 6 x 100	S	200	45,50	M 2,5 x 10	S	2000	3,60 gal Zn	M 4 x 5	K	200	10,20 gal Zn
M 8 x 10	S	500	36,50	M 2,5 x 10	K	200	5,90 gal Zn	M 4 x 6	S	2000	2,30 gal Zn
M 8 x 12	S	500	14,30	M 2,5 x 12	S	2000	3,85 gal Zn	M 4 x 6	K	200	5,30 gal Zn
M 8 x 16	S	500	14,80	M 2,5 x 12	K	200	6,00 gal Zn	M 4 x 8	S	2000	2,30 gal Zn
M 8 x 20	S	500	15,20	M 2,5 x 16	S	2000	4,45 gal Zn	M 4 x 8	K	200	5,30 gal Zn
M 8 x 25	S	500	15,70	M 2,5 x 16	K	200	7,40 gal Zn	M 4 x 10	S	2000	2,45 gal Zn
M 8 x 30	S	200	21,70	M 2,5 x 18	K	200	8,20 gal Zn	M 4 x 10	K	200	5,40 gal Zn
M 8 x 35	S	200	22,50	M 2,5 x 20	S	2000	5,40 gal Zn	M 4 x 12	S	2000	2,50 gal Zn
M 8 x 40	S	200	23,60	M 2,5 x 20	K	200	8,40 gal Zn	M 4 x 12	K	200	5,80 gal Zn
M 8 x 45	S	200	31,00	M 2,5 x 25	S	2000	6,20 gal Zn	M 4 x 14	S	2000	3,75 gal Zn
M 8 x 50	S	200	35,00	M 2,5 x 25	K	200	9,10 gal Zn	M 4 x 14	K	200	6,70 gal Zn
M 8 x 55	S	200	41,00	M 2,5 x 30	S	2000	8,00 gal Zn	M 4 x 16	S	2000	4,00 gal Zn
M 8 x 60	S	200	45,00	M 2,5 x 30	K	200	10,90 gal Zn	M 4 x 16	K	200	7,00 gal Zn
M 8 x 70	S	200	50,00	M 3 x 3	S	2000	9,70 gal Zn	M 4 x 18	S	2000	4,40 gal Zn
M 10 x 12	S	200	92,00	M 3 x 3	K	200	12,60 gal Zn	M 4 x 18	K	200	7,30 gal Zn
M 10 x 16	S	200	31,00	M 3 x 4	S	2000	5,90 gal Zn	M 4 x 20	S	2000	5,00 gal Zn
M 10 x 20	S	200	28,50	M 3 x 4	K	200	8,80 gal Zn	M 4 x 20	K	200	7,60 gal Zn
M 10 x 25	S	200	35,00	M 3 x 5	S	2000	5,60 gal Zn	M 4 x 22	S	1000	5,40 gal Zn
M 10 x 30	S	200	36,50	M 3 x 5	K	200	8,60 gal Zn	M 4 x 22	K	200	7,90 gal Zn
M 10 x 40	S	200	38,00	M 3 x 6	S	2000	1,50 gal Zn	M 4 x 25	S	1000	5,80 gal Zn
M 10 x 45	S	100	45,50	M 3 x 6	K	200	4,40 gal Zn	M 4 x 25	K	200	8,00 gal Zn
				M 3 x 8	S	2000	1,55 gal Zn	M 4 x 28	S	1000	6,20 gal Zn
				M 3 x 8	K	200	4,45 gal Zn	M 4 x 28	K	200	8,20 gal Zn
				M 3 x 10	S	2000	1,60 gal Zn	M 4 x 30	S	1000	6,60 gal Zn
				M 3 x 10	K	200	4,55 gal Zn	M 4 x 30	K	200	8,40 gal Zn
				M 3 x 12	S	2000	1,70 gal Zn	M 4 x 35	S	1000	6,80 gal Zn
				M 3 x 12	K	200	4,60 gal Zn	M 4 x 35	K	200	8,60 gal Zn
				M 3 x 14	S	2000	2,80 gal Zn	M 4 x 40	S	1000	7,00 gal Zn
				M 3 x 14	K	200	5,70 gal Zn	M 4 x 40	K	200	8,80 gal Zn
				M 3 x 16	S	2000	3,10 gal Zn	M 4 x 45	S	1000	7,30 gal Zn
				M 3 x 16	K	200	6,10 gal Zn	M 4 x 45	K	200	10,30 gal Zn
				M 3 x 18	S	2000	3,65 gal Zn	M 4 x 50	S	1000	8,90 gal Zn
				M 3 x 18	K	200	6,70 gal Zn	M 4 x 50	K	200	11,80 gal Zn
				M 3 x 20	S	2000	4,00 gal Zn	M 4 x 55	S	500	13,50 gal Zn
				M 3 x 20	K	200	7,10 gal Zn	M 4 x 55	K	200	12,90 gal Zn
				M 3 x 22	S	2000	4,45 gal Zn	M 4 x 60	S	500	18,00 gal Zn
				M 3 x 22	K	200	7,40 gal Zn	M 4 x 60	K	200	14,00 gal Zn
				M 3 x 25	S	2000	4,90 gal Zn	M 4 x 65	K	100	20,10 gal Zn
				M 3 x 25	K	200	7,60 gal Zn	M 4 x 70	S	500	23,00 gal Zn
				M 3 x 28	S	2000	5,10 gal Zn	M 4 x 70	K	100	29,00 gal Zn
				M 3 x 28	K	200	7,80 gal Zn	M 4 x 80	K	100	33,50 gal Zn
				M 3 x 30	S	2000	5,30 gal Zn	M 4 x 90	K	100	50,00 gal Zn
				M 3 x 30	K	200	8,00 gal Zn	M 4 x 100	K	100	54,00 gal Zn
				M 3 x 35	S	2000	5,40 gal Zn	M 5 x 6	S	2000	10,70 gal Zn
				M 3 x 35	K	200	8,30 gal Zn	M 5 x 6	K	200	13,60 gal Zn
				M 3 x 40	S	1000	5,90 gal Zn	M 5 x 8	S	2000	3,60 gal Zn
				M 3 x 40	K	200	8,90 gal Zn	M 5 x 8	K	200	6,50 gal Zn
				M 3 x 45	S	1000	8,60 gal Zn	M 5 x 10	S	2000	3,75 gal Zn
				M 3 x 45	K	200	11,50 gal Zn	M 5 x 10	K	200	6,70 gal Zn
				M 3 x 50	S	1000	9,60 gal Zn	M 5 x 12	S	1000	3,95 gal Zn
				M 3 x 50	K	200	12,60 gal Zn	M 5 x 12	K	200	6,90 gal Zn
				M 3 x 55	S	200	17,00 gal Zn	M 5 x 14	S	1000	6,00 gal Zn
				M 3 x 60	K	200	17,00 gal Zn	M 5 x 14	K	200	9,00 gal Zn
				M 3,5 x 5	K	200	11,10 gal Zn	M 5 x 16	S	1000	6,20 gal Zn
				M 3,5 x 6	S	2000	5,50 gal Zn	M 5 x 16	K	200	9,10 gal Zn
				M 3,5 x 6	K	200	8,50 gal Zn	M 5 x 18	S	1000	6,30 gal Zn
				M 3,5 x 8	K	200	6,70 gal Zn	M 5 x 18	K	200	9,20 gal Zn
				M 3,5 x 10	S	2000	3,90 gal Zn	M 5 x 20	S	1000	7,10 gal Zn
				M 3,5 x 10	K	200	6,80 gal Zn	M 5 x 20	K	200	10,10 gal Zn
				M 3,5 x 12	S	2000	3,95 gal Zn	M 5 x 22	S	1000	8,20 gal Zn
				M 3,5 x 12	K	200	6,90 gal Zn	M 5 x 22	K	200	11,10 gal Zn

DIN 00084.410
84 4.8 galvanisch verzinkt

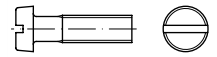

Zylinderschrauben mit Schlitz

Maße → TI-37 Normumstellung → TI-11
 Werkstoffeigensch. → TI-232 REACH → TI-262
 Korrosionsschutz → TI-228
 Rostfrei → S. 455
 Messing, Kunststoff → S. 611
 DIN 84 → wird ersetzt durch ISO 1207 (austauschbar)



Abmessungen	VE	Stück	€/100/Obf.
M 5 x 25	S	1000	8,50 gal Zn
M 5 x 25	K	200	11,30 gal Zn
M 5 x 30	S	1000	8,70 gal Zn
M 5 x 30	K	200	11,50 gal Zn
M 5 x 35	S	500	9,00 gal Zn
M 5 x 35	K	200	11,90 gal Zn
M 5 x 40	S	500	9,80 gal Zn
M 5 x 40	K	200	12,40 gal Zn
M 5 x 45	S	500	10,70 gal Zn
M 5 x 45	K	200	13,60 gal Zn
M 5 x 50	S	500	12,10 gal Zn
M 5 x 50	K	200	14,50 gal Zn
M 5 x 55	S	500	14,30 gal Zn
M 5 x 55	K	200	16,10 gal Zn
M 5 x 60	K	200	19,30 gal Zn
M 5 x 65	K	100	22,00 gal Zn
M 5 x 70	S	200	16,00 gal Zn
M 5 x 70	K	100	25,00 gal Zn
M 5 x 80	S	200	26,00 gal Zn
M 5 x 80	K	100	31,50 gal Zn
M 5 x 90	S	200	49,50 gal Zn
M 5 x 90	K	100	55,00 gal Zn
M 5 x 100	S	200	56,00 gal Zn
M 5 x 100	K	100	67,00 gal Zn
M 6 x 6	S	1000	21,00 gal Zn
M 6 x 6	K	200	23,90 gal Zn
M 6 x 8	S	1000	7,20 gal Zn
M 6 x 8	K	200	10,10 gal Zn
M 6 x 10	S	1000	5,90 gal Zn
M 6 x 10	K	200	8,80 gal Zn
M 6 x 12	S	1000	5,90 gal Zn
M 6 x 12	K	200	8,90 gal Zn
M 6 x 14	S	1000	7,20 gal Zn
M 6 x 14	K	200	9,10 gal Zn
M 6 x 16	S	1000	8,20 gal Zn
M 6 x 16	K	200	9,50 gal Zn
M 6 x 18	S	1000	8,60 gal Zn
M 6 x 18	K	200	9,80 gal Zn
M 6 x 20	S	1000	9,00 gal Zn
M 6 x 20	K	200	10,50 gal Zn
M 6 x 22	K	200	11,20 gal Zn
M 6 x 25	S	500	9,40 gal Zn
M 6 x 25	K	200	11,40 gal Zn
M 6 x 30	S	500	9,80 gal Zn
M 6 x 30	K	200	12,10 gal Zn
M 6 x 35	S	500	10,20 gal Zn
M 6 x 35	K	200	12,40 gal Zn
M 6 x 40	S	500	11,20 gal Zn
M 6 x 40	K	200	14,10 gal Zn
M 6 x 45	S	500	15,00 gal Zn
M 6 x 45	K	200	20,90 gal Zn
M 6 x 50	K	200	22,10 gal Zn
M 6 x 55	K	100	25,50 gal Zn
M 6 x 60	S	200	17,60 gal Zn
M 6 x 60	K	100	28,00 gal Zn
M 6 x 65	S	200	21,00 gal Zn
M 6 x 70	S	200	27,00 gal Zn
M 6 x 70	K	100	39,00 gal Zn
M 6 x 80	K	100	41,50 gal Zn
M 6 x 90	K	100	58,00 gal Zn
M 6 x 100	S	200	50,00 gal Zn
M 6 x 100	K	100	62,00 gal Zn
M 8 x 10	K	100	40,00 gal Zn
M 8 x 12	K	100	18,80 gal Zn
M 8 x 16	S	500	16,50 gal Zn
M 8 x 16	K	100	19,30 gal Zn
M 8 x 18	K	100	20,10 gal Zn
M 8 x 20	S	500	17,00 gal Zn
M 8 x 20	K	100	21,10 gal Zn
M 8 x 25	S	500	17,50 gal Zn
M 8 x 25	K	100	22,10 gal Zn
M 8 x 30	S	200	18,10 gal Zn
M 8 x 30	K	100	23,90 gal Zn
M 8 x 35	K	100	29,50 gal Zn
M 8 x 40	K	100	31,00 gal Zn

Abmessungen	VE	Stück	€/100/Obf.
M 8 x 45	K	100	36,50 gal Zn
M 8 x 50	K	100	39,50 gal Zn
M 8 x 55	K	100	44,00 gal Zn
M 8 x 60	K	100	46,00 gal Zn
M 8 x 70	K	100	48,00 gal Zn
M 8 x 80	K	100	63,00 gal Zn
M 8 x 90	K	100	69,00 gal Zn
M 8 x 100	K	100	80,00 gal Zn
M 10 x 12	K	100	98,00 gal Zn
M 10 x 16	K	100	36,50 gal Zn
M 10 x 20	K	100	34,50 gal Zn
M 10 x 25	K	100	36,00 gal Zn
M 10 x 30	K	100	42,50 gal Zn
M 10 x 35	K	100	47,50 gal Zn
M 10 x 40	K	100	49,00 gal Zn
M 10 x 50	K	100	53,00 gal Zn
M 10 x 60	K	100	60,00 gal Zn
M 10 x 70	K	100	73,00 gal Zn
M 10 x 80	K	50	86,00 gal Zn
M 10 x 100	K	50	118,00 gal Zn

DIN	00084.430
84	4.8 galvanisch vernickelt



Zylinderschrauben mit Schlitz

Maße → TI-37 Normumstellung → TI-11
 Werkstoffeigensch. → TI-232 REACH → TI-262
 Korrosionsschutz → TI-228

Rostfrei → S. 455
 Messing, Kunststoff → S. 611

DIN 84 → wird ersetzt durch ISO 1207 (austauschbar)



M 3 x 6	S	2000	2,50 gal Ni
M 3 x 8	S	2000	2,60 gal Ni
M 3 x 10	S	2000	2,75 gal Ni
M 3 x 12	S	2000	2,90 gal Ni
M 3 x 16	S	2000	3,40 gal Ni
M 4 x 8	S	2000	4,10 gal Ni
M 4 x 10	S	2000	4,25 gal Ni
M 4 x 12	S	2000	4,95 gal Ni
M 4 x 16	S	2000	5,30 gal Ni
M 5 x 8	S	2000	6,20 gal Ni
M 5 x 10	S	2000	6,70 gal Ni
M 5 x 12	S	1000	6,90 gal Ni
M 5 x 16	S	1000	7,90 gal Ni

Abmessungen	VE	Stück	€/100/Obf.
DIN	00085.400		

85 **4.8**

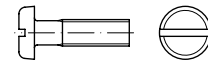

Flachkopfschrauben mit Schlitz

Maße → TI-37 Normumstellung → TI-11
 Werkstoffeigensch. → TI-232 REACH → TI-262

Rostfrei → S. 457
 Messing, Kunststoff → S. 612

DIN 85 → wird ersetzt durch ISO 1580 (austauschbar)



M 3 x 5	S	2000	6,20
M 3 x 6	S	2000	3,25
M 3 x 8	S	2000	1,40
M 3 x 10	S	2000	1,90
M 3 x 12	S	2000	2,15
M 3 x 16	S	2000	2,30
M 3 x 25	S	2000	3,35
M 4 x 6	S	2000	4,95
M 4 x 8	S	2000	2,40
M 4 x 10	S	2000	2,45
M 4 x 12	S	2000	2,50
M 4 x 16	S	2000	2,85
M 4 x 20	S	2000	3,30
M 4 x 25	S	1000	4,80
M 4 x 30	S	1000	5,30
M 4 x 35	S	1000	6,60
M 4 x 40	S	1000	7,20
M 5 x 8	S	2000	3,65
M 5 x 10	S	2000	3,70
M 5 x 12	S	1000	3,90
M 5 x 16	S	1000	4,45
M 5 x 20	S	1000	4,85
M 5 x 35	S	500	11,30
M 5 x 40	S	500	10,60
M 5 x 50	S	500	11,90
M 6 x 8	S	1000	13,20
M 6 x 10	S	1000	5,60
M 6 x 12	S	1000	5,80
M 6 x 16	S	1000	6,50
M 6 x 20	S	1000	9,80
M 6 x 25	S	500	8,00
M 6 x 30	S	500	8,90
M 6 x 35	S	500	10,00
M 6 x 50	S	200	22,30



- ✓ Große Artikelvielfalt
- ✓ Verlässliche Qualität
- ✓ Hohe Lieferbereitschaft



Wir versorgen Sie mit
 Verbindungselementen
 und Befestigungstechnik!

Abmessungen	VE Stück	€/100/Obf.
DIN	00085.410	
85	4.8	galvanisch verzinkt

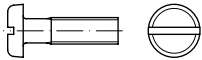

Flachkopfschrauben mit Schlitz

Maße → [TI-37](#) Normumstellung → [TI-11](#)
 Werkstoffeigensch. → [TI-232](#) REACH → [TI-262](#)
 Korrosionsschutz → [TI-228](#)

Rostfrei → [S. 457](#)
 Messing, Kunststoff → [S. 612](#)

DIN 85 → wird ersetzt durch ISO 1580 (austauschbar)



M 3	x	4	S	2000	7,20 gal Zn
M 3	x	4	K	200	10,20 gal Zn
M 3	x	5	S	2000	6,80 gal Zn
M 3	x	5	K	200	9,70 gal Zn
M 3	x	6	S	2000	3,15 gal Zn
M 3	x	6	K	200	6,50 gal Zn
M 3	x	8	S	2000	1,55 gal Zn
M 3	x	8	K	200	4,55 gal Zn
M 3	x	10	S	2000	1,70 gal Zn
M 3	x	10	K	200	5,00 gal Zn
M 3	x	12	S	2000	1,95 gal Zn
M 3	x	12	K	200	5,30 gal Zn
M 3	x	16	S	2000	2,15 gal Zn
M 3	x	16	K	200	5,40 gal Zn
M 3	x	20	S	2000	2,90 gal Zn
M 3	x	20	K	200	6,30 gal Zn
M 3	x	25	S	2000	3,35 gal Zn
M 3	x	25	K	200	6,70 gal Zn
M 3	x	30	K	200	7,70 gal Zn
M 3	x	35	K	200	9,10 gal Zn
M 3	x	40	K	200	9,90 gal Zn
M 3	x	45	K	200	13,70 gal Zn
M 3	x	50	K	200	15,50 gal Zn
M 3	x	60	K	200	19,30 gal Zn
M 4	x	5	S	2000	10,50 gal Zn
M 4	x	5	K	200	14,00 gal Zn
M 4	x	6	S	2000	4,85 gal Zn
M 4	x	6	K	200	8,40 gal Zn
M 4	x	8	S	2000	2,50 gal Zn
M 4	x	8	K	200	5,50 gal Zn
M 4	x	10	S	2000	2,60 gal Zn
M 4	x	10	K	200	5,60 gal Zn
M 4	x	12	S	2000	2,70 gal Zn
M 4	x	12	K	200	5,70 gal Zn
M 4	x	16	S	2000	3,15 gal Zn
M 4	x	16	K	200	6,20 gal Zn
M 4	x	20	S	2000	3,45 gal Zn
M 4	x	20	K	200	6,70 gal Zn
M 4	x	25	S	1000	4,20 gal Zn
M 4	x	25	K	200	8,30 gal Zn
M 4	x	30	S	1000	5,40 gal Zn
M 4	x	30	K	200	8,80 gal Zn
M 4	x	35	K	200	9,90 gal Zn
M 4	x	40	K	200	10,30 gal Zn
M 4	x	45	K	200	13,60 gal Zn
M 4	x	50	K	200	14,30 gal Zn
M 4	x	60	K	200	19,30 gal Zn
M 5	x	6	S	2000	12,80 gal Zn
M 5	x	6	K	200	17,70 gal Zn
M 5	x	8	S	2000	3,90 gal Zn
M 5	x	8	K	200	6,90 gal Zn
M 5	x	10	S	2000	4,10 gal Zn

Abmessungen	VE Stück	€/100/Obf.			
M 5	x	10	K	200	7,10 gal Zn
M 5	x	12	S	1000	4,20 gal Zn
M 5	x	12	K	200	7,30 gal Zn
M 5	x	16	S	1000	4,85 gal Zn
M 5	x	16	K	200	7,90 gal Zn
M 5	x	20	S	1000	5,30 gal Zn
M 5	x	20	K	200	8,40 gal Zn
M 5	x	25	S	1000	5,80 gal Zn
M 5	x	25	K	200	8,80 gal Zn
M 5	x	30	S	1000	6,90 gal Zn
M 5	x	30	K	200	9,90 gal Zn
M 5	x	35	S	2000	8,00 gal Zn
M 5	x	35	K	200	10,90 gal Zn
M 5	x	40	S	2000	10,50 gal Zn
M 5	x	40	K	200	13,50 gal Zn
M 5	x	45	S	500	11,60 gal Zn
M 5	x	45	K	200	14,60 gal Zn
M 5	x	50	K	200	16,10 gal Zn
M 5	x	60	K	200	22,00 gal Zn
M 6	x	8	S	1000	14,10 gal Zn
M 6	x	8	K	200	17,60 gal Zn
M 6	x	10	S	1000	6,10 gal Zn
M 6	x	10	K	200	9,10 gal Zn
M 6	x	12	S	1000	6,30 gal Zn
M 6	x	12	K	200	9,40 gal Zn
M 6	x	16	S	1000	6,90 gal Zn
M 6	x	16	K	200	10,10 gal Zn
M 6	x	20	S	1000	7,80 gal Zn
M 6	x	20	K	200	10,70 gal Zn
M 6	x	25	S	500	8,80 gal Zn
M 6	x	25	K	200	11,80 gal Zn
M 6	x	30	S	500	9,60 gal Zn
M 6	x	30	K	200	12,80 gal Zn
M 6	x	35	K	200	14,00 gal Zn
M 6	x	40	K	200	17,40 gal Zn
M 6	x	45	K	200	19,30 gal Zn
M 6	x	50	K	200	21,00 gal Zn
M 6	x	55	K	100	34,00 gal Zn
M 6	x	60	K	100	36,00 gal Zn
M 8	x	10	K	100	44,00 gal Zn
M 8	x	12	K	100	22,40 gal Zn
M 8	x	16	K	100	23,30 gal Zn
M 8	x	20	K	100	24,50 gal Zn
M 8	x	25	K	100	27,50 gal Zn
M 8	x	30	K	100	28,00 gal Zn
M 8	x	40	K	100	28,50 gal Zn
M 8	x	50	K	100	39,50 gal Zn

~DIN	00093.000
93	Stahl

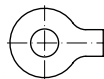

Scheiben mit Lappen

Achtung! Nicht geeignet für hochfeste Schraubenverbindungen.

Maße → [TI-88](#)

Rostfrei → [S. 458](#)

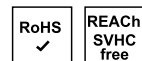

3,2	K	100	14,40
4,3	S	1000	10,80
4,3	K	100	15,30
5,3	S	1000	11,20
5,3	K	100	28,50
6,4	S	1000	12,50

Abmessungen	VE Stück	€/100/Obf.	
6,4	K	100	18,20
8,4	S	1000	15,50
8,4	K	100	20,40
10,5	S	1000	18,10
10,5	K	100	23,30
13	S	500	24,40
13	K	100	31,50
15	K	100	34,50
17	S	500	34,50
17	K	100	42,50
19	K	100	44,50
21	S	250	39,50
21	K	100	48,50
23	S	100	63,00
25	S	100	66,00
28	S	50	121,00
31	S	50	136,00
34	S	50	155,00
37	S	50	170,00
40	S	50	195,00
43	S	25	211,00
46	S	25	244,00
50	S	25	280,00
54	S	25	310,00

~DIN	00093.010
93	Stahl
	galvanisch verzinkt

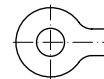

Scheiben mit Lappen

Achtung! Nicht geeignet für hochfeste Schraubenverbindungen.

Maße → [TI-88](#)

Schraubensicherung → [TI-256](#)

Korrosionsschutz → [TI-228](#)

Rostfrei → [S. 458](#)

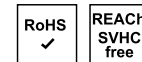

4,3	K	100	15,40 gal Zn
5,3	K	100	16,00 gal Zn
6,4	S	1000	12,90 gal Zn
6,4	K	100	18,70 gal Zn
8,4	S	1000	16,30 gal Zn
8,4	K	100	21,20 gal Zn
10,5	S	1000	19,00 gal Zn
10,5	K	100	24,40 gal Zn
13	S	500	26,50 gal Zn
13	K	100	34,00 gal Zn
15	K	100	38,00 gal Zn
17	S	500	38,00 gal Zn
17	K	100	46,00 gal Zn
19	K	100	48,50 gal Zn
21	S	250	44,00 gal Zn
21	K	100	53,00 gal Zn
23	S	100	68,00 gal Zn
25	S	100	72,00 gal Zn
28	S	50	132,00 gal Zn
31	S	50	148,00 gal Zn
34	S	50	170,00 gal Zn
37	S	50	187,00 gal Zn
43	S	25	234,00 gal Zn
50	S	25	315,00 gal Zn
54	S	25	340,00 gal Zn

Abmessungen	VE Stück	€/100/Obf.
DIN	00094.010	
94	Stahl	galvanisch verzinkt

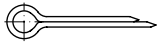

Splinte

Maße → **TI-22** Normumstellung → **TI-10**
 Korrosionsschutz → **TI-228**
 Rostfrei → **S. 458**
 Messing, Kupfer → **S. 613**
 DIN 94 → wird ersetzt durch ISO 1234 (austauschbar)



Nenn Ø = Bohrungs Ø x Länge

1	x	6	S	1000	1,70 gal Zn
1	x	8	S	1000	1,75 gal Zn
1	x	10	S	1000	1,80 gal Zn
1	x	12	S	1000	1,90 gal Zn
1	x	16	S	1000	2,00 gal Zn
1	x	18	S	1000	2,10 gal Zn
1	x	20	S	1000	2,20 gal Zn
1	x	22	S	1000	2,30 gal Zn
1	x	25	S	1000	2,45 gal Zn
1	x	32	S	1000	3,00 gal Zn
1	x	40	S	1000	3,75 gal Zn
1,2	x	8	S	1000	1,85 gal Zn
1,2	x	10	S	1000	1,90 gal Zn
1,2	x	12	S	1000	1,95 gal Zn
1,2	x	14	S	1000	2,00 gal Zn
1,2	x	16	S	1000	2,05 gal Zn
1,2	x	20	S	1000	2,10 gal Zn
1,2	x	25	S	1000	2,50 gal Zn
1,2	x	32	S	1000	3,00 gal Zn
1,2	x	36	S	1000	3,60 gal Zn
1,2	x	40	S	1000	3,75 gal Zn
1,6	x	8	S	1000	2,20 gal Zn
1,6	x	10	S	1000	2,25 gal Zn
1,6	x	12	S	1000	2,30 gal Zn
1,6	x	14	S	1000	2,35 gal Zn
1,6	x	16	S	1000	2,40 gal Zn
1,6	x	18	S	1000	2,45 gal Zn
1,6	x	20	S	1000	2,50 gal Zn
1,6	x	22	S	1000	2,60 gal Zn
1,6	x	25	S	1000	2,70 gal Zn
1,6	x	28	S	1000	2,75 gal Zn
1,6	x	32	S	1000	3,10 gal Zn
1,6	x	36	S	1000	3,60 gal Zn
1,6	x	40	S	1000	3,85 gal Zn
1,6	x	50	S	1000	5,30 gal Zn
2	x	8	S	1000	2,80 gal Zn
2	x	10	S	1000	2,85 gal Zn
2	x	12	S	1000	2,90 gal Zn
2	x	14	S	1000	2,95 gal Zn
2	x	16	S	1000	3,00 gal Zn
2	x	18	S	1000	3,05 gal Zn
2	x	20	S	1000	3,10 gal Zn
2	x	22	S	1000	3,20 gal Zn
2	x	25	S	1000	3,30 gal Zn
2	x	28	S	1000	3,40 gal Zn
2	x	32	S	1000	3,60 gal Zn
2	x	36	S	1000	3,85 gal Zn
2	x	40	S	1000	4,15 gal Zn
2	x	45	S	1000	5,40 gal Zn
2	x	50	S	1000	5,70 gal Zn
2,5	x	10	S	500	3,35 gal Zn
2,5	x	12	S	500	3,40 gal Zn
2,5	x	14	S	500	3,45 gal Zn

Abmessungen	VE Stück	€/100/Obf.			
2,5	x	16	S	500	3,50 gal Zn
2,5	x	18	S	500	3,55 gal Zn
2,5	x	20	S	500	3,60 gal Zn
2,5	x	22	S	500	3,75 gal Zn
2,5	x	25	S	500	3,95 gal Zn
2,5	x	28	S	500	4,25 gal Zn
2,5	x	32	S	500	4,45 gal Zn
2,5	x	36	S	500	4,75 gal Zn
2,5	x	40	S	500	5,10 gal Zn
2,5	x	45	S	500	5,50 gal Zn
2,5	x	50	S	500	5,80 gal Zn
2,5	x	56	S	500	7,80 gal Zn
2,5	x	63	S	500	8,80 gal Zn
3,2	x	10	S	500	4,15 gal Zn
3,2	x	12	S	500	4,20 gal Zn
3,2	x	14	S	500	4,25 gal Zn
3,2	x	16	S	500	4,30 gal Zn
3,2	x	18	S	500	4,35 gal Zn
3,2	x	20	S	500	4,45 gal Zn
3,2	x	22	S	500	4,60 gal Zn
3,2	x	25	S	500	4,95 gal Zn
3,2	x	28	S	500	5,30 gal Zn
3,2	x	32	S	500	5,60 gal Zn
3,2	x	36	S	500	6,00 gal Zn
3,2	x	40	S	500	6,50 gal Zn
3,2	x	45	S	500	7,20 gal Zn
3,2	x	50	S	500	7,70 gal Zn
3,2	x	56	S	500	8,20 gal Zn
3,2	x	63	S	500	9,20 gal Zn
3,2	x	71	S	500	10,30 gal Zn
4	x	15	S	500	5,90 gal Zn
4	x	18	S	500	6,00 gal Zn
4	x	20	S	500	6,20 gal Zn
4	x	22	S	500	6,50 gal Zn
4	x	25	S	500	6,80 gal Zn
4	x	28	S	500	7,30 gal Zn
4	x	32	S	500	7,90 gal Zn
4	x	36	S	500	8,40 gal Zn
4	x	40	S	500	9,10 gal Zn
4	x	45	S	500	9,70 gal Zn
4	x	50	S	500	10,60 gal Zn
4	x	56	S	500	11,40 gal Zn
4	x	63	S	500	12,50 gal Zn
4	x	71	S	500	13,70 gal Zn
4	x	80	S	500	15,30 gal Zn
4	x	90	S	500	26,00 gal Zn
4	x	100	S	500	29,00 gal Zn
4	x	112	S	250	33,50 gal Zn
4	x	125	S	250	37,50 gal Zn
5	x	20	S	250	9,10 gal Zn
5	x	22	S	250	9,40 gal Zn
5	x	25	S	250	9,70 gal Zn
5	x	28	S	250	11,10 gal Zn
5	x	32	S	250	12,30 gal Zn
5	x	36	S	250	13,40 gal Zn
5	x	40	S	250	14,30 gal Zn
5	x	45	S	250	15,50 gal Zn
5	x	50	S	250	16,60 gal Zn
5	x	56	S	250	18,20 gal Zn
5	x	63	S	250	20,30 gal Zn
5	x	71	S	250	22,30 gal Zn
5	x	80	S	250	24,10 gal Zn
5	x	90	S	250	27,00 gal Zn
5	x	100	S	250	30,00 gal Zn
5	x	112	S	250	51,00 gal Zn
5	x	125	S	250	58,00 gal Zn
5	x	210	S	50	850,00 gal Zn
5,5	x	50	S	250	24,60 gal Zn
6,3	x	25	S	250	18,30 gal Zn
6,3	x	32	S	250	18,40 gal Zn
6,3	x	36	S	250	20,10 gal Zn
6,3	x	40	S	250	21,30 gal Zn
6,3	x	45	S	250	23,00 gal Zn
6,3	x	50	S	250	25,00 gal Zn
6,3	x	56	S	250	28,00 gal Zn

Abmessungen	VE Stück	€/100/Obf.			
6,3	x	63	S	250	31,50 gal Zn
6,3	x	71	S	250	34,00 gal Zn
6,3	x	80	S	250	38,00 gal Zn
6,3	x	90	S	250	42,00 gal Zn
6,3	x	100	S	250	47,00 gal Zn
6,3	x	112	S	250	53,00 gal Zn
6,3	x	125	S	250	60,00 gal Zn
6,3	x	140	S	250	112,00 gal Zn
8	x	40	S	100	46,00 gal Zn
8	x	45	S	100	48,50 gal Zn
8	x	50	S	100	52,00 gal Zn
8	x	56	S	100	57,00 gal Zn
8	x	63	S	100	60,00 gal Zn
8	x	71	S	100	65,00 gal Zn
8	x	80	S	100	72,00 gal Zn
8	x	90	S	100	77,00 gal Zn
8	x	100	S	100	83,00 gal Zn
8	x	112	S	100	92,00 gal Zn
8	x	125	S	100	106,00 gal Zn
8	x	140	S	100	118,00 gal Zn
10	x	56	S	100	85,00 gal Zn
10	x	63	S	100	91,00 gal Zn
10	x	71	S	100	103,00 gal Zn
10	x	80	S	100	114,00 gal Zn
10	x	90	S	100	124,00 gal Zn
10	x	100	S	100	137,00 gal Zn
10	x	112	S	100	146,00 gal Zn
10	x	125	S	100	160,00 gal Zn
10	x	140	S	100	176,00 gal Zn
10	x	160	S	100	220,00 gal Zn
10	x	180	S	100	305,00 gal Zn
10	x	200	S	100	330,00 gal Zn
13	x	71	S	25	234,00 gal Zn
13	x	80	S	25	235,00 gal Zn
13	x	90	S	25	236,00 gal Zn
13	x	100	S	25	255,00 gal Zn
13	x	112	S	25	280,00 gal Zn
13	x	125	S	25	305,00 gal Zn
13	x	140	S	25	335,00 gal Zn
13	x	160	S	25	1010,00 gal Zn
13	x	180	S	25	1050,00 gal Zn
13	x	200	S	25	1170,00 gal Zn
13	x	250	S	25	2200,00 gal Zn
16	x	125	S	25	2440,00 gal Zn
16	x	140	S	25	2460,00 gal Zn
16	x	160	S	25	2550,00 gal Zn
16	x	180	S	25	2650,00 gal Zn
16	x	200	S	25	2750,00 gal Zn
16	x	250	S	25	2850,00 gal Zn

Artikel	82094.010
82094	Sortiment DIN 94
	Stahl, galv. verz.

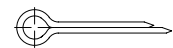

Splinte-Sortiment DIN 94

Inhalt: 12 gängige Abmessungen von 1 x 20 - 8 x 80, ca. 910 Stück (Metall-Koffer)

Wunschsortiment auf Anfrage

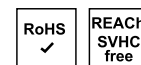

DIN 94	S	1	7700,00
--------	---	---	---------

Abmessungen	VE Stück	€/100/Obf.
DIN 00095.010		
95	Stahl	galvanisch verzinkt

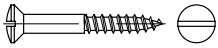

Linsenk-Holzschrauben mit Schlitz

Maße → **TI-50** Korrosionsschutz → **TI-228**
 Rostfrei → **S. 459**
 Messing → **S. 613**



2	x	10	S	500	11,00 gal Zn
2	x	20	S	500	16,20 gal Zn

DIN	00096.010
96	Stahl
	galvanisch verzinkt

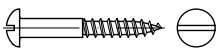

Halbrund-Holzschrauben mit Schlitz

Maße → **TI-51** Korrosionsschutz → **TI-228**
 Rostfrei → **S. 460**
 Messing → **S. 615**



1,6	x	8	S	500	9,60 gal Zn
1,6	x	10	S	500	5,80 gal Zn
1,6	x	12	S	500	7,60 gal Zn
1,6	x	16	S	500	10,20 gal Zn
2	x	8	S	500	6,30 gal Zn
2	x	10	S	500	4,40 gal Zn
2	x	12	S	500	4,75 gal Zn
2	x	16	S	500	5,80 gal Zn

DIN	00097.010
97	Stahl
	galvanisch verzinkt



Senk-Holzschrauben mit Schlitz

Maße → **TI-51** Korrosionsschutz → **TI-228**
 Rostfrei → **S. 460**
 Messing → **S. 615**



1,6	x	12	S	500	5,20 gal Zn
1,6	x	16	S	500	6,90 gal Zn

Abmessungen	VE Stück	€/100/Obf.
2 x 10	S 500	3,80 gal Zn
2 x 12	S 500	4,10 gal Zn
2 x 16	S 500	4,50 gal Zn

DIN	00098.004
98	Stahl
	Form E

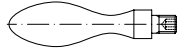

Drehbare Ballengriffe mit Innensechskant, E = mit Gewindezapfen

Maße → **TI-125** REACH → **TI-262**



Ballen Ø / Anschlussgewinde M					
E 16	M 6	S	10	2750,00	
E 20	M 8	S	10	3100,00	
E 25	M 10	S	10	3900,00	
E 32	M 12	S	10	6300,00	
E 36	M 16	S	10	8300,00	

DIN	00099.007
99	Stahl
	Form N

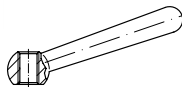

Kegelgriffe mit Griffaufnahme durch Gewinde, N = geneigte Griffachse

Maße → **TI-125** REACH → **TI-262**
 Rostfrei → **S. 460**



Länge/ Innengewinde M					
N 50	M 6	S	10	2030,00	
N 63	M 8	S	10	1250,00	
N 80	M 10	S	1	1510,00	
N 100	M 12	S	1	2000,00	
N 125	M 16	S	1	3450,00	
N 160	M 20	S	1	5900,00	
N 200	M 24	S	1	16300,00	

Abmessungen	VE Stück	€/100/Obf.
DIN 00099.017		
99	Stahl	Form N
	galvanisch verzinkt	

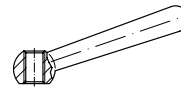

Kegelgriffe mit Griffaufnahme durch Gewinde, N = geneigte Griffachse

Maße → **TI-125** REACH → **TI-262**
 Korrosionsschutz → **TI-228**
 Rostfrei → **S. 460**



Länge / Innengewinde M					
N 80	M 10	S	10	1600,00 gal Zn	
N 100	M 12	S	1	2070,00 gal Zn	
N 125	M 16	S	1	3700,00 gal Zn	
N 160	M 20	S	1	6200,00 gal Zn	

DIN	00125.001
125-1	Stahl 140 HV
	Form A



Scheiben, A = ohne Fase

Maße → **TI-84** Normumstellung → **TI-84**
 Rostfrei → **S. 461**
 Messing, Kupfer, Kunststoff, Aluminium → **S. 616**
 DIN 125-1 Form A → wird ersetzt durch ISO 7089

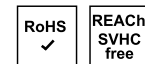

Innen Ø X Außen Ø x Dicke					
2,2	x	5	x	0,3	S 5000 0,85
2,2	x	5	x	0,3	K 200 2,90
2,5	x	6	x	0,5	S 5000 1,10
2,5	x	6	x	0,5	K 200 3,25
2,7	x	6	x	0,5	S 5000 1,25
2,7	x	6	x	0,5	K 200 3,40
2,8	x	7	x	0,5	K 200 3,40
3,2	x	7	x	0,5	S 5000 0,40
3,2	x	7	x	0,5	K 200 2,40
3,7	x	8	x	0,5	S 5000 1,45
3,7	x	8	x	0,5	K 200 3,25
4,3	x	9	x	0,8	S 1000 1,10
4,3	x	9	x	0,8	K 200 3,25
5,3	x	10	x	1	S 1000 1,30
5,3	x	10	x	1	K 100 3,40
6,4	x	12	x	1,6	S 1000 2,15
6,4	x	12	x	1,6	K 100 4,55
7,4	x	14	x	1,6	S 1000 3,10
7,4	x	14	x	1,6	K 100 5,70
8,4	x	16	x	1,6	S 1000 2,90
8,4	x	16	x	1,6	K 100 4,95
10,5	x	20	x	2	S 1000 4,80
10,5	x	20	x	2	K 100 7,20
13	x	24	x	2,5	S 500 8,60
13	x	24	x	2,5	K 100 11,70

Abmessungen	VE	Stück	€/100/Obf.
15 x 28 x 2,5 S	500	10,50	
15 x 28 x 2,5 K	100	13,80	
17 x 30 x 3 S	250	12,50	
17 x 30 x 3 K	100	16,40	
19 x 34 x 3 S	250	22,40	
19 x 34 x 3 K	100	27,50	
21 x 37 x 3 S	200	22,90	
21 x 37 x 3 K	100	27,50	

DIN	00125.011
125-1	Stahl 140 HV Form A galvanisch verzinkt

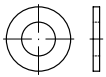

Scheiben, A = ohne Fase

Maße → **TI-84** Normumstellung → **TI-84**
 Korrosionsschutz → **TI-228**

Rostfrei → **S. 461**
 Messing, Kupfer, Kunststoff, Aluminium → **S. 616**

DIN 125-1 Form A → wird ersetzt durch ISO 7089

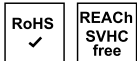

Innen Ø X Außen Ø x Dicke

2,2 x 5 x 0,3 S	5000	1,00 gal Zn
2,2 x 5 x 0,3 K	200	3,25 gal Zn
2,5 x 6 x 0,5 S	5000	1,25 gal Zn
2,5 x 6 x 0,5 K	200	3,35 gal Zn
2,7 x 6 x 0,5 S	5000	1,30 gal Zn
2,7 x 6 x 0,5 K	200	3,45 gal Zn
2,8 x 7 x 0,5 K	200	3,45 gal Zn
3,2 x 7 x 0,5 S	5000	0,75 gal Zn
3,2 x 7 x 0,5 K	200	2,60 gal Zn
3,7 x 8 x 0,5 S	5000	0,85 gal Zn
3,7 x 8 x 0,5 K	200	3,15 gal Zn
4,3 x 9 x 0,8 S	1000	1,10 gal Zn
4,3 x 9 x 0,8 K	200	3,25 gal Zn
5,3 x 10 x 1 S	1000	1,55 gal Zn
5,3 x 10 x 1 K	100	3,70 gal Zn
6,4 x 12 x 1,6 S	1000	2,70 gal Zn
6,4 x 12 x 1,6 K	100	5,20 gal Zn
7,4 x 14 x 1,6 S	1000	3,95 gal Zn
7,4 x 14 x 1,6 K	100	6,70 gal Zn
8,4 x 16 x 1,6 S	1000	3,75 gal Zn
8,4 x 16 x 1,6 K	100	5,90 gal Zn
10,5 x 20 x 2 S	1000	6,50 gal Zn
10,5 x 20 x 2 K	100	8,90 gal Zn
13 x 24 x 2,5 S	500	11,50 gal Zn
13 x 24 x 2,5 K	100	15,00 gal Zn
15 x 28 x 2,5 S	500	13,60 gal Zn
15 x 28 x 2,5 K	100	17,70 gal Zn
17 x 30 x 3 S	250	17,20 gal Zn
17 x 30 x 3 K	100	21,50 gal Zn
19 x 34 x 3 S	250	28,50 gal Zn
19 x 34 x 3 K	100	34,00 gal Zn
21 x 37 x 3 S	200	30,00 gal Zn
21 x 37 x 3 K	100	36,00 gal Zn

Abmessungen	VE	Stück	€/100/Obf.
Artikel	82125.010		
82125	Sortiment	DIN 125/A	
	Stahl, galv. verz.		

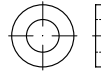

Scheiben-Sortimente DIN 125, Form A

Inhalt: 12 gängige Abmessungen von 3,2 - 25 Ø, ca. 810 Stück (Metall-Koffer)

Wunschsortiment auf Anfrage

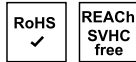

DIN 125	S	1	7700,00
---------	---	---	---------

DIN	00125.021
125-1	Stahl 140 HV Form A feuerverzinkt

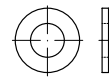

Scheiben, A = ohne Fase

Maße → **TI-84** Normumstellung → **TI-84**
 Korrosionsschutz → **TI-231**

Rostfrei → **S. 461**
 Messing, Kupfer, Kunststoff, Aluminium → **S. 616**

DIN 125-1 Form A → wird ersetzt durch ISO 7089

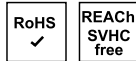

Innen Ø X Außen Ø x Dicke

6,4 x 12 x 1,6 S	1000	5,70 tZn
6,4 x 12 x 1,6 K	100	8,50 tZn
8,4 x 16 x 1,6 S	1000	7,90 tZn
8,4 x 16 x 1,6 K	100	10,70 tZn
10,5 x 20 x 2 S	1000	15,50 tZn
10,5 x 20 x 2 K	100	18,30 tZn
13 x 24 x 2,5 S	500	19,70 tZn
13 x 24 x 2,5 K	100	22,70 tZn
15 x 28 x 2,5 S	500	30,50 tZn
15 x 28 x 2,5 K	100	34,00 tZn
17 x 30 x 3 S	250	31,00 tZn
17 x 30 x 3 K	100	36,00 tZn
19 x 34 x 3 S	250	44,00 tZn
19 x 34 x 3 K	100	48,50 tZn
21 x 37 x 3 S	200	48,00 tZn
21 x 37 x 3 K	100	53,00 tZn

Abmessungen	VE	Stück	€/100/Obf.
DIN	00125.031		
125-1	Stahl 140 HV Form A galvanisch vernickelt		



Scheiben, A = ohne Fase

Maße → **TI-84** Normumstellung → **TI-84**
 Korrosionsschutz → **TI-228**

Rostfrei → **S. 461**
 Messing, Kupfer, Kunststoff, Aluminium → **S. 616**

DIN 125-1 Form A → wird ersetzt durch ISO 7089

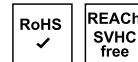

Innen Ø X Außen Ø x Dicke

3,2 x 7 x 0,5 S	1000	0,85 gal Ni
4,3 x 9 x 0,8 S	1000	1,30 gal Ni
5,3 x 10 x 1 S	1000	1,75 gal Ni
6,4 x 12 x 1,6 S	1000	2,90 gal Ni
8,4 x 16 x 1,6 S	1000	4,15 gal Ni
10,5 x 20 x 2 S	1000	7,20 gal Ni

DIN	00125.004
125-1	Stahl 140 HV Form B gedreht



Scheiben, B = mit Fase (gedreht)

Maße → **TI-84** REACH → **TI-262**
 Normumstellung → **TI-84**

Rostfrei → **S. 461**
 Messing → **S. 616**

DIN 125-1 Form B → wird ersetzt durch ISO 7090



Innen Ø X Außen Ø x Dicke

1,1 x 3 x 0,3 S	100	35,50 gedreht
1,3 x 3,5 x 0,3 S	100	35,50 gedreht
1,5 x 4 x 0,3 S	100	38,50 gedreht
1,7 x 4 x 0,3 S	100	25,50 gedreht
1,8 x 4,5 x 0,3 S	100	54,00 gedreht
2,2 x 5 x 0,5 S	100	25,50 gedreht
3,2 x 7 x 0,5 S	100	54,00 gedreht

DIN 125

Scheiben galvanisch verzinkt mit Dickschichtpassivierung

→ ISO 7089/7090



Abmessungen VE Stück €/100/Obf.
DIN 00125.002

125-1 Stahl 140 HV Form B

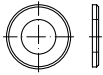

Scheiben, B = mit Fase (gestanz)

Maße → TI-84 Normumstellung → TI-84

Rostfrei → S. 461
Messing → S. 616

DIN 125-1 Form B → wird ersetzt durch ISO 7090

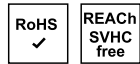

Innen Ø X Außen Ø x Dicke

4,3	x	9	x	0,8	S	1000	2,15
5,3	x	10	x	1	S	1000	2,60
6,4	x	12	x	1,6	S	1000	3,35
8,4	x	16	x	1,6	S	1000	4,75
10,5	x	20	x	2	S	1000	8,80
13	x	24	x	2,5	S	500	10,20
15	x	28	x	2,5	S	500	12,90
17	x	30	x	3	S	250	15,20
19	x	34	x	3	S	250	24,90
21	x	37	x	3	S	200	24,60
23	x	39	x	3	S	200	32,50
23	x	39	x	3	K	100	36,50
25	x	44	x	4	S	200	47,50
25	x	44	x	4	K	100	53,00
27	x	50	x	4	S	50	85,00
28	x	50	x	4	S	50	85,00
31	x	56	x	4	S	50	101,00
34	x	60	x	5	S	50	152,00
37	x	66	x	5	S	50	193,00
40	x	72	x	6	S	25	215,00
43	x	78	x	7	S	25	370,00
46	x	85	x	7	S	25	395,00
50	x	92	x	8	S	10	590,00
54	x	98	x	8	S	1	940,00
58	x	105	x	9	S	1	1260,00
60	x	110	x	9	S	1	1510,00
62	x	110	x	9	S	1	1510,00
66	x	115	x	9	S	1	1510,00
70	x	120	x	10	S	1	2850,00
74	x	125	x	10	S	1	2850,00
78	x	135	x	10	S	1	3450,00
82	x	140	x	12	S	1	4200,00
93	x	160	x	12	S	1	6000,00

Abmessungen VE Stück €/100/Obf.
DIN 00125.012

125-1 Stahl 140 HV Form B galvanisch verzinkt

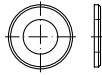

Scheiben, B = mit Fase (gestanz)

Maße → TI-84 Normumstellung → TI-84
Korrosionsschutz → TI-228

Rostfrei → S. 461
Messing → S. 616

DIN 125-1 Form B → wird ersetzt durch ISO 7090



Innen Ø X Außen Ø x Dicke

3,2	x	7	x	0,5	S	1000	3,80 gal Zn
3,2	x	7	x	0,5	K	200	6,20 gal Zn
4,3	x	9	x	0,8	S	1000	2,25 gal Zn
4,3	x	9	x	0,8	K	200	4,45 gal Zn
5,3	x	10	x	1	S	1000	2,80 gal Zn
5,3	x	10	x	1	K	100	5,00 gal Zn
6,4	x	12	x	1,6	S	1000	3,95 gal Zn
6,4	x	12	x	1,6	K	100	6,50 gal Zn
8,4	x	16	x	1,6	S	1000	5,90 gal Zn
8,4	x	16	x	1,6	K	100	7,90 gal Zn
10,5	x	20	x	2	S	1000	11,10 gal Zn
10,5	x	20	x	2	K	100	13,50 gal Zn
13	x	24	x	2,5	S	500	12,90 gal Zn
13	x	24	x	2,5	K	100	16,40 gal Zn
15	x	28	x	2,5	S	500	16,40 gal Zn
15	x	28	x	2,5	K	100	20,50 gal Zn
17	x	30	x	3	S	250	19,80 gal Zn
17	x	30	x	3	K	100	24,10 gal Zn
19	x	34	x	3	S	250	31,00 gal Zn
19	x	34	x	3	K	100	36,50 gal Zn
21	x	37	x	3	S	200	31,50 gal Zn
21	x	37	x	3	K	100	36,50 gal Zn
23	x	39	x	3	S	200	39,00 gal Zn
23	x	39	x	3	K	100	44,00 gal Zn
25	x	44	x	4	S	200	59,00 gal Zn
25	x	44	x	4	K	100	66,00 gal Zn
27	x	50	x	4	S	50	117,00 gal Zn
28	x	50	x	4	S	50	117,00 gal Zn
31	x	56	x	4	S	50	138,00 gal Zn
34	x	60	x	5	S	50	206,00 gal Zn
37	x	66	x	5	S	50	265,00 gal Zn
40	x	72	x	6	S	25	315,00 gal Zn
43	x	78	x	7	S	25	510,00 gal Zn
46	x	85	x	7	S	25	560,00 gal Zn
50	x	92	x	8	S	10	820,00 gal Zn
54	x	98	x	8	S	1	1170,00 gal Zn
58	x	105	x	9	S	1	1610,00 gal Zn
60	x	110	x	9	S	1	1870,00 gal Zn
62	x	110	x	9	S	1	1870,00 gal Zn
66	x	115	x	9	S	1	1900,00 gal Zn
70	x	120	x	10	S	1	3350,00 gal Zn
74	x	125	x	10	S	1	3350,00 gal Zn
78	x	135	x	10	S	1	4100,00 gal Zn
82	x	140	x	12	S	1	4950,00 gal Zn

Abmessungen VE Stück €/100/Obf.
DIN 00125.022

125-1 Stahl 140 HV Form B feuerverzinkt

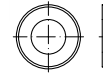

Scheiben, B = mit Fase (gestanz)

Maße → TI-84 Normumstellung → TI-84
Korrosionsschutz → TI-231

Rostfrei → S. 461
Messing → S. 616

DIN 125-1 Form B → wird ersetzt durch ISO 7090

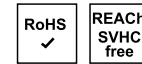

Innen Ø X Außen Ø x Dicke

6,4	x	12	x	1,6	S	1000	8,60 tZn
8,4	x	16	x	1,6	S	1000	9,10 tZn
10,5	x	20	x	2	S	1000	16,50 tZn
13	x	24	x	2,5	S	500	21,30 tZn
17	x	30	x	3	S	250	36,50 tZn
21	x	37	x	3	S	200	56,00 tZn
23	x	39	x	3	S	200	58,00 tZn
23	x	39	x	3	K	100	65,00 tZn
25	x	44	x	4	S	200	92,00 tZn
25	x	44	x	4	K	100	102,00 tZn
27	x	50	x	4	S	100	144,00 tZn
28	x	50	x	4	S	100	144,00 tZn
31	x	56	x	4	S	100	174,00 tZn
34	x	60	x	5	S	50	222,00 tZn
37	x	66	x	5	S	50	290,00 tZn
40	x	72	x	6	S	25	395,00 tZn
43	x	78	x	7	S	25	560,00 tZn
46	x	85	x	7	S	25	590,00 tZn
50	x	92	x	8	S	25	1080,00 tZn
54	x	98	x	8	S	1	1080,00 tZn

DIN 00126.000

126 Stahl 100 HV



Scheiben, gestanz

Maße → TI-84 Normumstellung → TI-84

DIN 126 → wird ersetzt durch ISO 7091

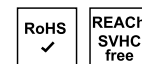

Innen Ø X Außen Ø x Dicke

5,5	x	10	x	1	S	1000	1,55
5,5	x	10	x	1	K	100	6,10
6,6	x	12	x	1,6	S	1000	1,75
6,6	x	12	x	1,6	K	100	6,30
9	x	16	x	1,6	S	1000	3,30
9	x	16	x	1,6	K	100	7,80
11	x	20	x	2	S	1000	4,85
11	x	20	x	2	K	100	9,90
13,5	x	24	x	2,5	S	500	6,90
13,5	x	24	x	2,5	K	100	13,80
15,5	x	28	x	2,5	K	100	18,40
17,5	x	30	x	3	S	250	10,20

Abmessungen	VE	Stück	€/100/Obf.
17,5	x	30 x 3	K 100 16,70
20	x	34 x 3	K 100 24,20
22	x	37 x 3	S 250 16,60
22	x	37 x 3	K 100 22,90
24	x	39 x 3	S 100 21,20
26	x	44 x 4	S 100 26,50
30	x	50 x 4	S 100 36,00
33	x	56 x 4	S 100 43,00
36	x	60 x 5	S 100 66,00
39	x	66 x 5	S 100 84,00
42	x	72 x 6	S 50 101,00
45	x	78 x 7	S 50 158,00
48	x	85 x 7	S 50 181,00
52	x	92 x 8	S 25 224,00
56	x	98 x 8	S 25 475,00
62	x	105 x 9	S 25 680,00
66	x	110 x 9	S 10 760,00
70	x	115 x 9	S 10 820,00
78	x	125 x 10	S 10 1060,00
86	x	140 x 12	S 1 1700,00

DIN	00126.010
126	Stahl 100 HV galvanisch verzinkt

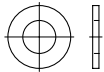

Scheiben, gestanzt

Maße → TI-84 Normumstellung → TI-84
Korrosionsschutz → TI-228

DIN 126 → wird ersetzt durch ISO 7091

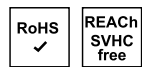

Innen Ø X Außen Ø x Dicke

5,5	x	10 x 1	S 1000 1,70 gal Zn
5,5	x	10 x 1	K 100 6,20 gal Zn
6,6	x	12 x 1,6	S 1000 2,20 gal Zn
6,6	x	12 x 1,6	K 100 6,70 gal Zn
9	x	16 x 1,6	S 1000 3,95 gal Zn
9	x	16 x 1,6	K 100 8,40 gal Zn
11	x	20 x 2	S 1000 6,20 gal Zn
11	x	20 x 2	K 100 11,10 gal Zn
13,5	x	24 x 2,5	S 500 9,20 gal Zn
13,5	x	24 x 2,5	K 100 16,00 gal Zn
15,5	x	28 x 2,5	K 100 21,50 gal Zn
17,5	x	30 x 3	S 250 14,30 gal Zn
17,5	x	30 x 3	K 100 20,50 gal Zn
20	x	34 x 3	K 100 29,50 gal Zn
22	x	37 x 3	S 250 22,90 gal Zn
22	x	37 x 3	K 100 28,50 gal Zn
24	x	39 x 3	S 100 28,00 gal Zn
26	x	44 x 4	S 100 38,50 gal Zn
30	x	50 x 4	S 100 49,50 gal Zn
33	x	56 x 4	S 100 61,00 gal Zn
36	x	60 x 5	S 100 89,00 gal Zn
39	x	66 x 5	S 100 113,00 gal Zn
42	x	72 x 6	S 50 143,00 gal Zn
45	x	78 x 7	S 50 216,00 gal Zn
48	x	85 x 7	S 50 255,00 gal Zn
52	x	92 x 8	S 25 325,00 gal Zn
56	x	98 x 8	S 25 590,00 gal Zn
62	x	105 x 9	S 25 830,00 gal Zn

Abmessungen	VE	Stück	€/100/Obf.
~DIN	00127.001		
127	Federstahl	Form A	

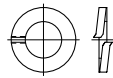

Federringe, A = aufgebogen

Maße → TI-88
Rostfrei → S. 462



A 3	S	1000	1,05
A 3	K	100	3,85
A 3,5	S	1000	1,10
A 3,5	K	100	3,95
A 4	S	1000	1,25
A 4	K	100	4,10
A 5	S	1000	1,55
A 5	K	100	4,30
A 6	S	1000	2,25
A 6	K	100	5,20
A 7	S	1000	2,70
A 7	K	100	5,50
A 8	S	1000	3,70
A 8	K	100	6,70
A 10	S	1000	5,30
A 10	K	100	8,50
A 12	S	500	7,90
A 12	K	100	11,40
A 14	S	500	13,10
A 14	K	100	16,70
A 16	S	250	16,50
A 16	K	100	20,50
A 18	S	250	17,60
A 18	K	100	21,60
A 20	S	100	26,50
A 22	S	100	30,00
A 24	S	100	45,50
A 27	S	100	53,00
A 30	S	50	108,00
A 33	S	25	157,00
A 36	S	25	180,00
A 39	S	25	195,00
A 42	S	25	345,00
A 45	S	25	385,00
A 48	S	25	410,00

Abmessungen	VE	Stück	€/100/Obf.
~DIN	00127.011		
127	Federstahl	Form A	
	galvanisch verzinkt		

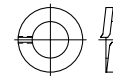

Federringe, A = aufgebogen

Maße → TI-88 Korrosionsschutz → TI-228
Rostfrei → S. 462

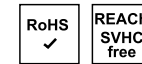

A 3	S	1000	1,15 gal Zn
A 3	K	100	4,30 gal Zn
A 3,5	S	1000	1,25 gal Zn
A 3,5	K	100	4,55 gal Zn
A 4	S	1000	1,35 gal Zn
A 4	K	100	4,60 gal Zn
A 5	S	1000	1,75 gal Zn
A 5	K	100	4,95 gal Zn
A 6	S	1000	3,10 gal Zn
A 6	K	100	6,10 gal Zn
A 7	S	1000	3,60 gal Zn
A 7	K	100	6,70 gal Zn
A 8	S	1000	5,30 gal Zn
A 8	K	100	8,50 gal Zn
A 10	S	1000	7,80 gal Zn
A 10	K	100	11,20 gal Zn
A 12	S	500	11,40 gal Zn
A 12	K	100	15,00 gal Zn
A 14	S	500	18,40 gal Zn
A 14	K	100	22,70 gal Zn
A 16	S	250	24,60 gal Zn
A 16	K	100	29,50 gal Zn
A 18	S	250	26,50 gal Zn
A 18	K	100	31,50 gal Zn
A 20	S	100	41,50 gal Zn
A 22	S	100	46,00 gal Zn
A 24	S	100	69,00 gal Zn
A 27	S	100	79,00 gal Zn
A 30	S	50	154,00 gal Zn
A 33	S	25	220,00 gal Zn
A 36	S	25	244,00 gal Zn
A 39	S	25	265,00 gal Zn
A 42	S	25	460,00 gal Zn
A 45	S	25	485,00 gal Zn
A 48	S	25	530,00 gal Zn
A 52	S	25	990,00 gal Zn



- ✓ Große Artikelvielfalt
- ✓ Verlässliche Qualität
- ✓ Hohe Lieferbereitschaft

Abmessungen	VE Stück	€/100/Obf.
Artikel	82127.000	
82127	Sortiment	DIN 125/127
	Stahl, galv. verz.	

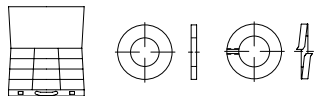

Scheiben-/Federringe-Sortiment, DIN 125 Form A/DIN 127 Form A

Inhalt: je 6 gängige Abmessungen
5,3 - 17 Ø / A 5 - A 16 Ø, ca. 1000 Stück
(Metall-Koffer)

Korrosionsschutz → **TI-228**

Wunschsortiment auf Anfrage



DIN 125 / 127	S	1	7700,00
---------------	---	---	---------

~DIN	00127.041
127	Federstahl Form A
	galv. verz. 8 DiSP*



Federringe, A = aufgebogen

* $\varnothing 6$ Mindestschichtdicke 5µm,
Korrosionsbeständigkeit NSS: 72h WR, 120h RR

Maße → **TI-88**

Korrosionsschutz → **TI-228**

Rostfrei → **S. 462**



A 3	S	1000	2,65 gal ZnDi
A 4	S	1000	1,70 gal ZnDi
A 5	S	1000	2,25 gal ZnDi
A 6	S	1000	3,90 gal ZnDi
A 8	S	1000	6,60 gal ZnDi
A 10	S	1000	10,20 gal ZnDi
A 12	S	500	14,80 gal ZnDi
A 14	S	500	23,90 gal ZnDi
A 16	S	250	33,00 gal ZnDi
A 20	S	100	54,00 gal ZnDi
A 24	S	100	90,00 gal ZnDi

Abmessungen	VE Stück	€/100/Obf.
~DIN	00127.021	
127	Federstahl Form A	
	feuerverzinkt	



Federringe, A = aufgebogen

Maße → **TI-88**

Korrosionsschutz → **TI-231**

Rostfrei → **S. 462**



A 6	S	1000	5,30 tzn
A 6	K	100	8,20 tzn
A 8	S	1000	5,30 tzn
A 8	K	100	8,20 tzn
A 10	S	1000	8,20 tzn
A 10	K	100	10,60 tzn
A 12	S	500	12,30 tzn
A 12	K	100	15,40 tzn
A 14	K	100	22,40 tzn
A 16	S	250	26,00 tzn
A 16	K	100	30,00 tzn
A 18	S	250	28,00 tzn
A 18	K	100	163,00 tzn
A 20	S	100	43,00 tzn
A 22	S	100	48,50 tzn
A 24	S	100	78,00 tzn
A 27	S	100	86,00 tzn
A 30	S	50	165,00 tzn
A 36	S	25	265,00 tzn

~DIN	00127.002
127	Federstahl Form B



Federringe, B = glatt

Maße → **TI-88**

Rostfrei → **S. 462**

Bronze → **S. 617**



B 2	S	1000	0,85
B 2	K	100	3,75
B 2,5	S	1000	1,05
B 2,5	K	100	19,00
B 3	S	1000	1,05
B 3	K	100	3,85
B 4	S	1000	1,25
B 4	K	100	4,10
B 5	S	1000	1,55
B 5	K	100	4,30
B 6	S	1000	2,25
B 6	K	100	5,20
B 7	S	1000	2,85
B 7	K	100	5,50

Abmessungen	VE Stück	€/100/Obf.	
B 8	S	1000	3,70
B 8	K	100	6,70
B 10	S	1000	5,30
B 10	K	100	8,50
B 12	S	500	7,90
B 12	K	100	11,40
B 14	S	500	13,10
B 14	K	100	16,70
B 16	S	250	16,50
B 16	K	100	20,50
B 18	S	250	17,60
B 18	K	100	21,60
B 20	S	100	26,50
B 22	S	100	30,00
B 24	S	100	45,50
B 27	S	100	53,00
B 30	S	50	108,00
B 33	S	25	157,00
B 36	S	25	180,00
B 39	S	25	195,00
B 42	S	25	345,00
B 48	S	25	410,00
B 52	S	25	830,00
B 56	S	1	3300,00
B 64	S	1	3300,00
B 80	S	1	4750,00
B 90	S	1	4750,00
B 100	S	1	4750,00

~DIN	00127.012
127	Federstahl Form B
	galvanisch verzinkt



Federringe, B = glatt

Maße → **TI-88**

Korrosionsschutz → **TI-228**

Rostfrei → **S. 462**

Bronze → **S. 617**



B 2	S	1000	1,05 gal Zn
B 2	K	100	4,15 gal Zn
B 2,5	S	1000	1,05 gal Zn
B 2,5	K	100	4,15 gal Zn
B 3	S	1000	1,15 gal Zn
B 3	K	100	4,30 gal Zn
B 3,5	S	1000	1,25 gal Zn
B 3,5	K	100	4,55 gal Zn
B 4	S	1000	1,35 gal Zn
B 4	K	100	4,60 gal Zn
B 5	S	1000	1,75 gal Zn
B 5	K	100	4,95 gal Zn
B 6	S	1000	3,10 gal Zn
B 6	K	100	6,10 gal Zn
B 7	S	1000	3,60 gal Zn
B 7	K	100	6,70 gal Zn
B 8	S	1000	5,30 gal Zn
B 8	K	100	8,50 gal Zn
B 10	S	1000	7,80 gal Zn
B 10	K	100	11,20 gal Zn
B 12	S	500	11,40 gal Zn
B 12	K	100	15,00 gal Zn
B 14	S	500	18,40 gal Zn
B 14	K	100	22,70 gal Zn
B 16	S	250	24,60 gal Zn

Abmessungen	VE	Stück	€/100/Obf.
B 16	K	100	29,50 gal Zn
B 18	S	250	26,50 gal Zn
B 18	K	100	31,50 gal Zn
B 20	S	100	41,50 gal Zn
B 22	S	100	46,00 gal Zn
B 24	S	100	69,00 gal Zn
B 27	S	100	79,00 gal Zn
B 30	S	50	154,00 gal Zn
B 33	S	25	220,00 gal Zn
B 36	S	25	244,00 gal Zn
B 39	S	25	265,00 gal Zn
B 42	S	25	460,00 gal Zn
B 48	S	25	530,00 gal Zn

~DIN	00127.043
127	Federstahl Form B
	galv. verz. 8 DiSP



Federringe, B = glatt

Maße → TI-88

Korrosionsschutz → TI-228

Rostfrei → S. 462
Bronze → S. 617

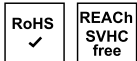

B 8	S	1000	6,60 gal ZnDi
B 10	S	1000	10,20 gal ZnDi
B 12	S	500	14,80 gal ZnDi
B 16	S	250	33,00 gal ZnDi
B 20	S	100	56,00 gal ZnDi
B 24	S	100	97,00 gal ZnDi

~DIN	00127.022
127	Federstahl Form B
	feuerverzinkt



Federringe, B = glatt

Maße → TI-88

Korrosionsschutz → TI-231

Rostfrei → S. 462
Bronze → S. 617



B 6	S	1000	5,30 tZn
B 6	K	100	8,20 tZn
B 8	S	1000	5,30 tZn
B 8	K	100	8,20 tZn
B 10	S	1000	8,20 tZn
B 10	K	100	10,60 tZn
B 12	S	500	12,30 tZn
B 12	K	100	15,40 tZn
B 14	K	100	22,40 tZn
B 16	S	250	26,00 tZn
B 16	K	100	30,00 tZn
B 18	S	250	34,00 tZn

Abmessungen	VE	Stück	€/100/Obf.
B 20	S	100	43,00 tZn
B 22	S	100	48,50 tZn
B 24	S	100	78,00 tZn
B 27	S	100	86,00 tZn
B 30	S	50	165,00 tZn
B 36	S	25	265,00 tZn
B 42	S	25	540,00 tZn

~DIN	00128.001
128	Federstahl Form A

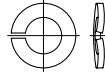

Federringe, A = gewölbt

Maße → TI-89

Rostfrei → S. 463



A 3	S	1000	1,65
A 3	K	100	4,70
A 4	S	1000	1,25
A 4	K	100	4,10
A 5	S	1000	1,55
A 5	K	100	4,30
A 6	S	1000	2,25
A 6	K	100	5,20
A 8	S	1000	3,70
A 8	K	100	6,70
A 10	S	1000	5,30
A 10	K	100	8,50
A 12	S	500	7,90
A 12	K	100	11,40
A 14	S	500	13,10
A 14	K	100	16,70
A 16	S	250	16,50
A 16	K	100	20,50
A 18	K	100	22,60
A 20	S	100	28,50
A 22	S	100	33,50
A 24	S	100	51,00
A 30	S	50	120,00
A 36	S	25	194,00

~DIN	00128.011
128	Federstahl Form A
	mechanisch verzinkt



Federringe, A = gewölbt

Maße → TI-89

Korrosionsschutz → TI-228

Rostfrei → S. 463



A 2,5	S	1000	1,70 mech Zn
A 3	S	1000	1,70 mech Zn

Abmessungen	VE	Stück	€/100/Obf.
A 3	K	100	5,30 mech Zn
A 4	S	1000	1,35 mech Zn
A 4	K	100	4,60 mech Zn
A 5	S	1000	1,75 mech Zn
A 5	K	100	4,95 mech Zn
A 6	S	1000	3,10 mech Zn
A 6	K	100	6,10 mech Zn
A 8	S	1000	5,30 mech Zn
A 8	K	100	8,50 mech Zn
A 10	S	1000	7,80 mech Zn
A 10	K	100	11,20 mech Zn
A 12	S	500	11,40 mech Zn
A 12	K	100	15,00 mech Zn
A 14	S	500	18,40 mech Zn
A 14	K	100	22,70 mech Zn
A 16	S	250	26,00 mech Zn
A 16	K	100	31,00 mech Zn
A 18	S	250	30,00 mech Zn
A 18	K	100	36,00 mech Zn
A 20	S	100	47,50 mech Zn
A 22	S	100	54,00 mech Zn
A 24	S	100	83,00 mech Zn
A 30	S	50	181,00 mech Zn
A 36	S	25	325,00 mech Zn

~DIN	00128.021
128	Federstahl Form A
	feuerverzinkt



Federringe, A = gewölbt

Maße → TI-89

Korrosionsschutz → TI-231

Rostfrei → S. 463

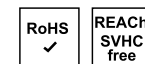

A 10	S	1000	11,50 tZn
A 12	S	500	17,20 tZn
A 16	S	250	38,50 tZn
A 20	S	100	91,00 tZn
A 27	S	100	144,00 tZn

~DIN	00128.012
128	Federstahl Form B
	mechanisch verzinkt



Federringe, B = gewellt

Maße → TI-89

Korrosionsschutz → TI-228

Rostfrei → S. 463

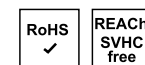

B 3	S	1000	1,70 mech Zn
B 4	S	1000	1,35 mech Zn
B 4	K	100	4,60 mech Zn
B 5	S	1000	1,75 mech Zn

Abmessungen	VE	Stück	€/100/Obf.
B 5	K	100	4,95 mech Zn
B 6	S	1000	3,10 mech Zn
B 6	K	100	6,10 mech Zn
B 8	S	1000	5,30 mech Zn
B 8	K	100	8,50 mech Zn
B 10	S	1000	7,80 mech Zn
B 10	K	100	11,20 mech Zn
B 12	S	500	11,40 mech Zn
B 12	K	100	15,00 mech Zn
B 14	S	500	18,40 mech Zn
B 14	K	100	22,70 mech Zn
B 16	S	250	26,00 mech Zn
B 16	K	100	31,00 mech Zn
B 18	S	250	30,00 mech Zn
B 20	S	100	47,50 mech Zn
B 22	S	100	54,00 mech Zn
B 24	S	100	83,00 mech Zn
B 30	S	50	181,00 mech Zn

~DIN 00137.001
137 Federstahl Form A



Federscheiben, A = gewölbt

Maße → TI-89
Rostfrei → S. 463

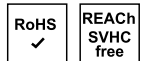

A 2	S	1000	0,65
A 2	K	100	4,25
A 2,3	S	1000	0,60
A 2,3	K	100	4,25
A 2,6	S	1000	1,10
A 2,6	K	100	5,70
A 3	S	1000	2,40
A 3	K	100	8,90
A 3,5	S	1000	0,65
A 4	S	1000	0,75
A 4	K	100	4,55
A 5	S	1000	1,10
A 5	K	100	4,80
A 6	S	1000	1,30
A 6	K	100	4,80
A 7	S	1000	1,85
A 7	K	100	5,60
A 8	S	1000	1,55
A 8	K	100	5,60
A 10	S	1000	4,20
A 10	K	100	8,30

Abmessungen VE Stück €/100/Obf.
~DIN 00137.011
137 Federstahl Form A
mechanisch verzinkt



Federscheiben, A = gewölbt

Maße → TI-89
Rostfrei → S. 463
Korrosionsschutz → TI-228

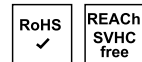

A 2	S	1000	0,65 mech Zn
A 2	K	100	4,30 mech Zn
A 2,3	S	1000	0,80 mech Zn
A 2,6	S	1000	0,65 mech Zn
A 2,6	K	100	4,30 mech Zn
A 3	S	1000	0,70 mech Zn
A 3	K	100	4,40 mech Zn
A 3,5	S	1000	0,75 mech Zn
A 3,5	K	100	4,40 mech Zn
A 4	S	1000	1,10 mech Zn
A 4	K	100	4,80 mech Zn
A 5	S	1000	1,30 mech Zn
A 5	K	100	5,00 mech Zn
A 6	S	1000	1,60 mech Zn
A 6	K	100	5,40 mech Zn
A 7	S	1000	2,00 mech Zn
A 7	K	100	5,90 mech Zn
A 8	S	1000	2,70 mech Zn
A 8	K	100	6,30 mech Zn
A 10	S	1000	5,50 mech Zn
A 10	K	100	9,60 mech Zn

~DIN 00137.002
137 Federstahl Form B



Federscheiben, B = gewellt

Maße → TI-89
Rostfrei → S. 463

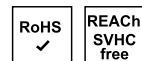

B 3	S	1000	0,95
B 3	K	100	4,60
B 3,5	K	100	4,60
B 4	S	1000	0,95
B 4	K	100	4,60
B 5	S	1000	1,30
B 5	K	100	5,00
B 6	S	1000	1,50
B 6	K	100	5,30
B 7	S	1000	3,60
B 7	K	100	7,60
B 8	S	1000	3,00
B 8	K	100	6,80

Abmessungen	VE	Stück	€/100/Obf.
B 10	S	1000	5,50
B 10	K	100	7,90
B 12	S	500	10,70
B 12	K	100	15,30
B 14	S	500	20,70
B 14	K	100	26,50
B 16	S	250	22,70
B 16	K	100	28,50
B 18	S	250	31,50
B 18	K	100	38,50
B 20	S	100	36,00
B 22	S	100	54,00
B 24	S	100	72,00
B 27	S	100	103,00
B 30	S	100	193,00
B 33	S	50	230,00
B 36	S	50	300,00

~DIN 00137.012
137 Federstahl Form B
mechanisch verzinkt



Federscheiben, B = gewellt

Maße → TI-89
Rostfrei → S. 463
Korrosionsschutz → TI-228

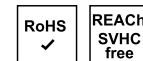

B 3	S	1000	1,10 mech Zn
B 3	K	100	4,80 mech Zn
B 4	S	1000	1,15 mech Zn
B 4	K	100	4,85 mech Zn
B 5	S	1000	1,60 mech Zn
B 5	K	100	5,40 mech Zn
B 6	S	1000	1,90 mech Zn
B 6	K	100	5,70 mech Zn
B 7	S	1000	4,40 mech Zn
B 7	K	100	8,40 mech Zn
B 8	S	1000	3,95 mech Zn
B 8	K	100	7,90 mech Zn
B 10	S	1000	7,70 mech Zn
B 10	K	100	11,90 mech Zn
B 12	S	500	14,40 mech Zn
B 12	K	100	19,40 mech Zn
B 14	S	500	27,50 mech Zn
B 14	K	100	33,50 mech Zn
B 16	S	250	30,00 mech Zn
B 16	K	100	37,00 mech Zn
B 18	S	250	41,50 mech Zn
B 18	K	100	48,00 mech Zn
B 20	S	100	46,00 mech Zn
B 22	S	100	69,00 mech Zn
B 24	S	100	88,00 mech Zn
B 27	S	100	130,00 mech Zn
B 30	S	100	229,00 mech Zn

Abmessungen	VE Stück	€/100/Obf.
DIN 00186.402		
186	Mu 4.6	Form B

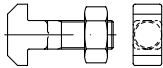

Hammerschrauben mit Vierkant, B = mit langem Gewinde, Mu = mit Sechskantmutter

Maße → **Ti-29** REACH → **Ti-262**
Werkstoffeigensch. → **Ti-232**



BM 6	x	25	S	50	230,00
BM 6	x	30	S	50	230,00
BM 6	x	45	S	50	275,00
BM 6	x	50	S	50	275,00
BM 6	x	60	S	25	365,00
BM 8	x	25	S	25	200,00
BM 8	x	30	S	25	200,00
BM 8	x	35	S	25	222,00
BM 8	x	40	S	25	222,00
BM 8	x	45	S	25	235,00
BM 8	x	50	S	25	235,00
BM 8	x	60	S	25	250,00
BM 8	x	80	S	25	425,00
BM 10	x	25	S	25	192,00
BM 10	x	30	S	25	192,00
BM 10	x	35	S	25	205,00
BM 10	x	40	S	25	205,00
BM 10	x	45	S	25	222,00
BM 10	x	50	S	25	222,00
BM 10	x	55	S	25	232,00
BM 10	x	60	S	25	232,00
BM 10	x	65	S	25	255,00
BM 10	x	70	S	10	285,00
BM 10	x	80	S	10	315,00
BM 10	x	90	S	10	370,00
BM 10	x	100	S	10	415,00
BM 10	x	110	S	10	620,00
BM 12	x	30	S	25	239,00
BM 12	x	35	S	25	275,00
BM 12	x	40	S	10	305,00
BM 12	x	45	S	10	360,00
BM 12	x	50	S	10	360,00
BM 12	x	55	S	10	380,00
BM 12	x	60	S	10	380,00
BM 12	x	65	S	10	410,00
BM 12	x	70	S	10	410,00
BM 12	x	80	S	10	425,00
BM 12	x	90	S	10	440,00
BM 12	x	100	S	10	470,00
BM 12	x	110	S	10	485,00
BM 12	x	120	S	10	510,00
BM 16	x	40	S	10	495,00
BM 16	x	45	S	10	530,00
BM 16	x	50	S	10	530,00
BM 16	x	60	S	10	560,00
BM 16	x	65	S	10	600,00
BM 16	x	70	S	10	600,00
BM 16	x	75	S	10	630,00
BM 16	x	80	S	10	630,00
BM 16	x	90	S	10	660,00
BM 16	x	100	S	10	680,00
BM 16	x	110	S	10	690,00
BM 16	x	120	S	10	730,00
BM 16	x	130	S	10	760,00

Abmessungen	VE Stück	€/100/Obf.
BM 16	x 140	S 10 780,00
BM 16	x 160	S 10 860,00
BM 20	x 60	S 10 820,00
BM 20	x 70	S 10 850,00
BM 20	x 80	S 10 880,00
BM 20	x 90	S 10 910,00
BM 20	x 100	S 10 950,00
BM 20	x 120	S 10 1030,00
BM 20	x 140	S 10 1110,00
BM 20	x 160	S 1 1170,00
BM 20	x 200	S 1 1340,00
BM 24	x 70	S 10 1110,00
BM 24	x 80	S 1 1130,00
BM 24	x 90	S 1 1170,00
BM 24	x 100	S 1 1240,00
BM 24	x 110	S 1 1300,00
BM 24	x 120	S 1 1340,00
BM 24	x 160	S 1 1530,00
BM 24	x 200	S 1 1670,00

DIN	00258.000
258	Stahl

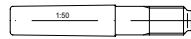

Kegelstifte mit Gewindezapfen und konstanten Kegellängen

REACH → **Ti-262**

Ausführung mit konstanten Gewindezapfenlängen → **DIN 7977**



5	x	40	S	100	132,00
5	x	50	S	100	152,00
6	x	45	S	25	176,00
6	x	50	S	25	186,00
6	x	55	S	100	199,00
6	x	60	S	25	203,00
8	x	55	S	10	232,00
8	x	60	S	10	232,00
8	x	65	S	100	241,00
8	x	75	S	100	255,00
10	x	65	S	10	325,00
10	x	75	S	100	345,00
10	x	85	S	10	385,00
10	x	100	S	10	420,00
12	x	85	S	10	455,00
12	x	100	S	10	530,00
12	x	120	S	10	620,00
12	x	140	S	10	720,00
16	x	100	S	1	840,00
16	x	120	S	1	840,00
16	x	140	S	1	1150,00
16	x	160	S	1	1250,00
20	x	120	S	1	1300,00
20	x	140	S	1	1320,00
20	x	190	S	1	1630,00
25	x	140	S	1	4300,00
25	x	160	S	1	5300,00

Abmessungen	VE Stück	€/100/Obf.
DIN 00261.400		
261	Mu 4.6	

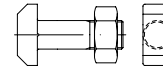

Hammerschrauben, Mu = mit Sechskantmutter

Maße → **Ti-29** REACH → **Ti-262**
Werkstoffeigensch. → **Ti-232**



M 8	x	30	S	25	200,00
M 10	x	30	S	25	192,00
M 10	x	40	S	25	205,00
M 10	x	50	S	25	222,00
M 10	x	60	S	25	232,00
M 12	x	40	S	10	305,00
M 12	x	50	S	10	360,00
M 12	x	60	S	10	380,00
M 16	x	60	S	10	560,00
M 16	x	70	S	10	600,00
M 16	x	80	S	10	630,00
M 16	x	120	S	10	730,00
M 20	x	60	S	10	820,00
M 20	x	80	S	10	880,00
M 20	x	90	S	10	910,00
M 24	x	90	S	1	1170,00

DIN	00315.000
315	Temperguss/Stahl

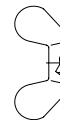

Flügelmuttern, runde Flügelform, Produktklasse C (g)

Maße → **Ti-72**

Rostfrei → **S. 464**

Messing → **S. 617**

DIN 314 = Kantige Flügelform, gepresst, auf Anfrage



M 4	S	100	28,00
M 5	S	100	32,50
M 6	S	100	42,00
M 8	S	100	62,00
M 10	S	100	103,00
M 12	S	50	177,00
M 14	S	50	224,00
M 16	S	20	335,00
M 20	S	25	770,00

Abmessungen	VE Stück	€/100/Obf.
DIN	00315.010	
315	Temperguss/Stahl	galvanisch verzinkt

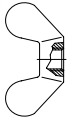

Flügelmuttern, runde Flügelform, Produktklasse C (g)

Maße → [TI-72](#) Korrosionsschutz → [TI-228](#)
 Rostfrei → [S. 464](#)
 Messing → [S. 617](#)

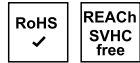

M 4	S	100	28,50 gal Zn
M 5	S	100	33,50 gal Zn
M 6	S	100	44,50 gal Zn
M 8	S	100	67,00 gal Zn
M 10	S	100	115,00 gal Zn
M 12	S	50	199,00 gal Zn
M 14	S	50	250,00 gal Zn
M 16	S	20	365,00 gal Zn
M 20	S	10	840,00 gal Zn
M 24	S	5	1610,00 gal Zn

~DIN	88215.010
315	Stahl Artikel 88215
	galvanisch verzinkt

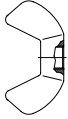

Flügelmuttern, kantige Flügelform, kleine "amerikanische" Ausführung, Produktklasse C (g)

Maße → [TI-79](#) Korrosionsschutz → [TI-228](#)
 Werkstoffeigensch. → [TI-233](#)

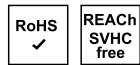

M 3	S	500	15,80 gal Zn
M 4	S	500	16,70 gal Zn
M 5	S	500	17,60 gal Zn
M 6	S	500	19,50 gal Zn
M 8	S	200	25,50 gal Zn
M 10	S	100	41,50 gal Zn
M 12	S	50	89,00 gal Zn

Abmessungen	VE Stück	€/100/Obf.
DIN	00316.010	
316	Temperguss/Stahl	galvanisch verzinkt

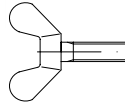

Flügelsschrauben, runde Flügelform, Produktklasse C (g)

Maße → [TI-29](#) Korrosionsschutz → [TI-228](#)
 Rostfrei → [S. 464](#)
 Messing → [S. 618](#)

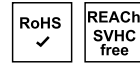

M 4	x	8	S	100	61,00 gal Zn
M 4	x	10	S	100	63,00 gal Zn
M 4	x	12	S	100	56,00 gal Zn
M 4	x	16	S	100	57,00 gal Zn
M 4	x	20	S	100	67,00 gal Zn
M 4	x	25	S	100	67,00 gal Zn
M 4	x	30	S	100	61,00 gal Zn
M 5	x	10	S	100	67,00 gal Zn
M 5	x	12	S	100	67,00 gal Zn
M 5	x	16	S	100	68,00 gal Zn
M 5	x	20	S	100	69,00 gal Zn
M 5	x	25	S	100	72,00 gal Zn
M 5	x	30	S	100	73,00 gal Zn
M 5	x	35	S	100	74,00 gal Zn
M 5	x	40	S	100	77,00 gal Zn
M 5	x	50	S	100	78,00 gal Zn
M 6	x	10	S	100	83,00 gal Zn
M 6	x	12	S	100	83,00 gal Zn
M 6	x	16	S	100	84,00 gal Zn
M 6	x	20	S	100	83,00 gal Zn
M 6	x	25	S	100	86,00 gal Zn
M 6	x	30	S	100	88,00 gal Zn
M 6	x	35	S	100	91,00 gal Zn
M 6	x	40	S	100	92,00 gal Zn
M 6	x	50	S	100	96,00 gal Zn
M 8	x	10	S	100	113,00 gal Zn
M 8	x	12	S	100	113,00 gal Zn
M 8	x	16	S	100	115,00 gal Zn
M 8	x	20	S	100	117,00 gal Zn
M 8	x	25	S	100	121,00 gal Zn
M 8	x	30	S	100	123,00 gal Zn
M 8	x	35	S	100	125,00 gal Zn
M 8	x	40	S	50	128,00 gal Zn
M 8	x	50	S	50	134,00 gal Zn
M 8	x	60	S	50	152,00 gal Zn
M 10	x	16	S	50	176,00 gal Zn
M 10	x	20	S	50	180,00 gal Zn
M 10	x	25	S	50	190,00 gal Zn
M 10	x	30	S	50	187,00 gal Zn
M 10	x	35	S	50	210,00 gal Zn
M 10	x	40	S	50	215,00 gal Zn
M 10	x	50	S	20	222,00 gal Zn
M 10	x	60	S	20	245,00 gal Zn
M 10	x	70	S	20	280,00 gal Zn
M 12	x	16	S	20	325,00 gal Zn
M 12	x	20	S	20	330,00 gal Zn
M 12	x	25	S	20	335,00 gal Zn
M 12	x	30	S	20	340,00 gal Zn
M 12	x	40	S	20	365,00 gal Zn
M 12	x	50	S	20	390,00 gal Zn
M 12	x	60	S	20	410,00 gal Zn
M 12	x	70	S	20	485,00 gal Zn
M 12	x	80	S	20	485,00 gal Zn

Abmessungen	VE Stück	€/100/Obf.
M 16	x 30	S 10 1180,00 gal Zn
M 16	x 40	S 10 1190,00 gal Zn
M 16	x 50	S 10 1300,00 gal Zn
M 16	x 60	S 10 1400,00 gal Zn

DIN	00404.500
404	5.8

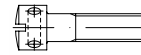

Kreuzlochschrauben mit Schlitz

Maße → [TI-29](#) REACH → [TI-262](#)
 Rostfrei → [S. 465](#)



M 3	x	6	S	100	67,00
M 3	x	8	S	100	68,00
M 3	x	10	S	100	72,00
M 4	x	5	S	100	69,00
M 4	x	6	S	100	69,00
M 4	x	8	S	100	77,00
M 4	x	10	S	100	80,00
M 5	x	10	S	100	150,00
M 5	x	16	S	100	109,00
M 5	x	18	S	100	111,00
M 5	x	20	S	100	119,00
M 6	x	16	S	100	156,00
M 6	x	20	S	100	170,00

DIN	00404.510
404	5.8
	galvanisch verzinkt

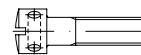

Kreuzlochschrauben mit Schlitz

Maße → [TI-29](#) REACH → [TI-262](#)
 Korrosionsschutz → [TI-228](#)
 Rostfrei → [S. 465](#)



M 3	x	5	S	100	85,00 gal Zn
M 3	x	6	S	100	87,00 gal Zn
M 3	x	8	S	100	87,00 gal Zn
M 3	x	10	S	100	92,00 gal Zn
M 4	x	6	S	100	130,00 gal Zn
M 4	x	8	S	100	95,00 gal Zn
M 4	x	10	S	100	100,00 gal Zn
M 5	x	8	S	100	90,00 gal Zn
M 5	x	10	S	100	111,00 gal Zn
M 5	x	16	S	100	129,00 gal Zn
M 5	x	20	S	100	138,00 gal Zn
M 6	x	10	S	100	165,00 gal Zn
M 6	x	12	S	100	173,00 gal Zn
M 6	x	16	S	100	175,00 gal Zn
M 6	x	20	S	100	189,00 gal Zn

Abmessungen	VE Stück	€/100/Obf.
DIN	00417.000	

417

14 H



Gewindestifte mit Schlitz und Zapfen

Maße → TI-19

REACH → TI-262

DIN 417 → wird ersetzt durch ISO 7435 (austauschbar)



M 3	x	5	S	100	17,00
M 3	x	6	S	100	11,10
M 3	x	8	S	100	11,40
M 3	x	10	S	100	14,40
M 3	x	12	S	100	15,10
M 4	x	5	S	100	23,50
M 4	x	6	S	100	18,80
M 4	x	8	S	100	11,80
M 4	x	10	S	100	12,10
M 4	x	12	S	100	16,00
M 4	x	16	S	100	13,70
M 5	x	8	S	100	13,50
M 5	x	10	S	100	14,60
M 5	x	12	S	100	15,10
M 5	x	16	S	100	18,10
M 5	x	20	S	100	23,50
M 5	x	25	S	100	24,70
M 6	x	8	S	100	15,40
M 6	x	10	S	100	16,00
M 6	x	12	S	100	16,70
M 6	x	16	S	100	18,60
M 6	x	20	S	100	20,20
M 6	x	25	S	100	22,60
M 6	x	30	S	100	31,50
M 8	x	10	S	100	38,00
M 8	x	12	S	100	21,60
M 8	x	16	S	100	22,40
M 8	x	20	S	100	27,00
M 8	x	25	S	100	29,50
M 8	x	30	S	100	36,00
M 8	x	35	S	100	51,00
M 8	x	40	S	100	69,00
M 10	x	12	S	50	77,00
M 10	x	16	S	50	50,00
M 10	x	20	S	50	69,00
M 10	x	25	S	50	59,00
M 10	x	30	S	50	78,00
M 10	x	35	S	50	85,00
M 10	x	40	S	50	90,00
M 10	x	50	S	50	160,00
M 12	x	20	S	50	109,00
M 12	x	25	S	50	118,00
M 12	x	40	S	50	148,00
M 12	x	50	S	50	165,00

Abmessungen	VE Stück	€/100/Obf.
DIN	00427.000	

427

14 H

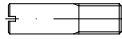

Schaftschrauben mit Kegelpuppe und Schlitz

Maße → TI-19

Normumstellung → TI-6

Werkstoffeigensch. → TI-232

REACH → TI-262

Rostfrei → S. 465

DIN 427 → wird ersetzt durch ISO 2342 (austauschbar)



M 3	x	6	S	100	18,80
M 3	x	8	S	100	28,00
M 3	x	10	S	100	14,40
M 3	x	12	S	100	19,00
M 4	x	8	S	100	24,80
M 4	x	10	S	100	15,20
M 4	x	12	S	100	16,40
M 4	x	16	S	100	20,40
M 4	x	20	S	100	23,60
M 4	x	25	S	100	26,50
M 5	x	10	S	100	28,00
M 5	x	12	S	100	23,20
M 5	x	16	S	100	23,00
M 5	x	18	S	100	23,80
M 5	x	20	S	100	23,80
M 5	x	25	S	100	31,50
M 5	x	30	S	100	36,00
M 5	x	35	S	100	53,00
M 5	x	40	S	100	72,00
M 6	x	12	S	100	21,20
M 6	x	16	S	100	23,60
M 6	x	18	S	100	26,00
M 6	x	20	S	100	26,00
M 6	x	25	S	100	29,50
M 6	x	30	S	100	40,50
M 6	x	35	S	100	76,00
M 6	x	40	S	100	114,00
M 6	x	45	S	100	118,00
M 6	x	50	S	100	124,00
M 8	x	16	S	100	29,00
M 8	x	18	S	100	34,50
M 8	x	20	S	100	34,50
M 8	x	25	S	100	37,50
M 8	x	30	S	100	46,00
M 8	x	35	S	100	54,00
M 8	x	40	S	100	72,00
M 8	x	45	S	100	136,00
M 8	x	50	S	100	114,00
M 8	x	60	S	100	156,00
M 10	x	20	S	50	84,00
M 10	x	25	S	50	91,00
M 10	x	30	S	50	97,00
M 10	x	35	S	50	106,00
M 10	x	40	S	50	112,00
M 10	x	45	S	50	138,00
M 10	x	50	S	50	146,00
M 12	x	20	S	50	210,00
M 12	x	25	S	50	224,00
M 12	x	30	S	50	260,00
M 12	x	35	S	50	285,00
M 12	x	40	S	50	330,00
M 12	x	50	S	50	410,00

Abmessungen	VE Stück	€/100/Obf.
DIN	00427.010	

427

14 H

galvanisch verzinkt

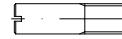

Schaftschrauben mit Kegelpuppe und Schlitz

Maße → TI-19

Normumstellung → TI-6

Werkstoffeigensch. → TI-232

REACH → TI-262

Korrosionsschutz → TI-228

Rostfrei → S. 465

DIN 427 → wird ersetzt durch ISO 2342 (austauschbar)



M 3	x	6	S	100	43,00 gal Zn
M 3	x	8	S	100	43,50 gal Zn
M 3	x	10	S	100	43,50 gal Zn
M 3	x	12	S	100	48,00 gal Zn
M 3	x	16	S	100	49,50 gal Zn
M 4	x	8	S	100	44,00 gal Zn
M 4	x	10	S	100	44,50 gal Zn
M 4	x	12	S	100	45,50 gal Zn
M 4	x	16	S	100	49,50 gal Zn
M 4	x	20	S	100	53,00 gal Zn
M 4	x	25	S	100	56,00 gal Zn
M 4	x	30	S	100	71,00 gal Zn
M 5	x	10	S	100	47,50 gal Zn
M 5	x	12	S	100	48,50 gal Zn
M 5	x	16	S	100	53,00 gal Zn
M 5	x	20	S	100	53,00 gal Zn
M 5	x	25	S	100	61,00 gal Zn
M 5	x	30	S	100	65,00 gal Zn
M 5	x	40	S	100	102,00 gal Zn
M 6	x	12	S	100	51,00 gal Zn
M 6	x	16	S	100	53,00 gal Zn
M 6	x	20	S	100	55,00 gal Zn
M 6	x	25	S	100	59,00 gal Zn
M 6	x	30	S	100	70,00 gal Zn
M 6	x	50	S	100	154,00 gal Zn
M 8	x	16	S	100	58,00 gal Zn
M 8	x	20	S	100	64,00 gal Zn
M 8	x	25	S	100	67,00 gal Zn
M 8	x	30	S	100	76,00 gal Zn
M 8	x	35	S	100	82,00 gal Zn
M 8	x	40	S	100	102,00 gal Zn
M 10	x	20	S	50	114,00 gal Zn
M 10	x	25	S	50	120,00 gal Zn
M 10	x	30	S	50	126,00 gal Zn
M 10	x	35	S	50	134,00 gal Zn
M 10	x	40	S	50	142,00 gal Zn
M 10	x	50	S	50	176,00 gal Zn

Abmessungen VE Stück €/100/Obf.

DIN	00431.002
-----	-----------

431 14 H Form B

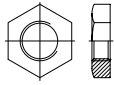

Rohrmuttern mit zölligem Rohrgewinde G, B = mit einseit. Gewindeansenkung

Maße → **TI-60** REACH → **TI-262**
Werkstoffeigensch. → **TI-233**

Rostfrei → **S. 465**
Messing → **S. 618**

Muttern mit ISO-Schlüsselweiten auf Anfrage



Nennmaß - SW

BG 1/8 SW19	S	50	72,00
BG 1/4 SW22	S	50	94,00
BG 3/8	S	50	132,00
BG 1/2 SW32	S	50	187,00
BG 3/4	S	25	265,00
BG 1	S	10	610,00
BG 1 1/4	S	1	760,00
BG 1 1/2	S	1	1020,00
BG 1 3/4	S	1	1700,00
BG 2	S	1	2160,00

DIN	00431.012
-----	-----------

431 14 H Form B
galvanisch verzinkt

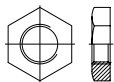

Rohrmuttern mit zölligem Rohrgewinde G, B = mit einseit. Gewindeansenkung

Maße → **TI-60** Korrosionsschutz → **TI-228**
Werkstoffeigensch. → **TI-233** REACH → **TI-262**

Rostfrei → **S. 465**
Messing → **S. 618**

Muttern mit ISO-Schlüsselweiten auf Anfrage



Nennmaß - SW

BG 1/8 SW19	S	50	77,00 gal Zn
BG 1/4 SW22	S	50	99,00 gal Zn
BG 3/8	S	50	141,00 gal Zn
BG 1/2 SW32	S	50	201,00 gal Zn
BG 3/4	S	25	280,00 gal Zn
BG 1	S	10	630,00 gal Zn
BG 1 1/2	S	1	1070,00 gal Zn
BG 2	S	1	2290,00 gal Zn

Abmessungen VE Stück €/100/Obf.

~DIN	00432.000
------	-----------

432 Stahl

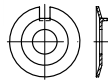

Scheiben mit Außennase

Achtung! Nicht geeignet für hochfeste Schraubenverbindungen!

Maße → **TI-90**

Rostfrei → **S. 465**

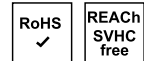

4,3	S	100	67,00
5,3	S	100	67,00
6,4	S	100	73,00
8,4	S	100	97,00
10,5	S	50	123,00
13	S	50	125,00
15	S	50	130,00
17	S	50	135,00
19	S	50	164,00
21	S	50	172,00
23	S	50	181,00
25	S	50	184,00
28	S	25	242,00
31	S	25	265,00
34	S	25	285,00
37	S	25	315,00
40	S	25	360,00
43	S	25	385,00
46	S	10	425,00
50	S	10	445,00
54	S	10	480,00
58	S	1	2010,00
66	S	1	2360,00

~DIN	00432.010
------	-----------

432 Stahl
galvanisch verzinkt



Scheiben mit Außennase

Achtung! Nicht geeignet für hochfeste Schraubenverbindungen!

Maße → **TI-90**

Korrosionsschutz → **TI-228**

Rostfrei → **S. 465**

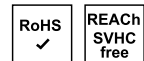

5,3	S	100	62,00 gal Zn
6,4	S	100	73,00 gal Zn
8,4	S	100	99,00 gal Zn
10,5	S	50	124,00 gal Zn
13	S	50	126,00 gal Zn
17	S	50	137,00 gal Zn
21	S	50	175,00 gal Zn
25	S	50	187,00 gal Zn
31	S	25	270,00 gal Zn

Abmessungen VE Stück €/100/Obf.

37	S	25	325,00 gal Zn
43	S	25	390,00 gal Zn

DIN	00433.000
-----	-----------

433-1 Stahl 140 HV

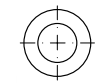

Scheiben

vorzugsweise für Zylinderschrauben

Maße → **TI-84**

Normumstellung → **TI-84**

Rostfrei → **S. 466**
Messing → **S. 618**

DIN 433 → wird ersetzt durch ISO 7092

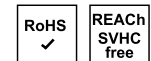

Innen Ø x Außen Ø x Dicke

2,2	x	4,5	x	0,3	S	5000	0,65
2,2	x	4,5	x	0,3	K	500	2,00
2,7	x	5	x	0,5	S	5000	0,55
2,7	x	5	x	0,5	K	500	1,65
3,2	x	6	x	0,5	S	5000	0,35
3,2	x	6	x	0,5	K	500	1,55
3,7	x	7	x	0,5	K	500	2,40
4,3	x	8	x	0,5	S	5000	0,45
4,3	x	8	x	0,5	K	500	1,60
5,3	x	9	x	1	S	5000	1,00
5,3	x	9	x	1	K	500	2,65
6,4	x	11	x	1,6	S	1000	1,70
6,4	x	11	x	1,6	K	250	3,95
8,4	x	15	x	1,6	S	1000	3,15
8,4	x	15	x	1,6	K	250	5,40
10,5	x	18	x	1,6	S	1000	4,80
10,5	x	18	x	1,6	K	250	8,30
13	x	20	x	2	S	1000	7,60
13	x	20	x	2	K	100	14,70
15	x	24	x	2,5	S	500	11,10
15	x	24	x	2,5	K	100	18,20
17	x	28	x	2,5	S	500	14,20
17	x	28	x	2,5	K	100	20,60
19	x	30	x	2,5	S	500	21,20
19	x	30	x	2,5	K	100	27,50
21	x	34	x	3	S	500	25,50
21	x	34	x	3	K	100	31,00

Abmessungen	VE Stück	€/100/Obf.
DIN	00433.010	
433-1	Stahl 140 HV	
	galvanisch verzinkt	

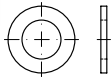

Scheiben

vorzugsweise für Zylinderschrauben

Maße → **TI-84** Normumstellung → **TI-84**
 Korrosionsschutz → **TI-228**
 Rostfrei → **S. 466**
 Messing → **S. 618**

DIN 433 → wird ersetzt durch ISO 7092

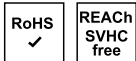

Innen Ø x Außen Ø x Dicke

2,2	x	4,5	x	0,3	S	5000	0,95 gal Zn
2,2	x	4,5	x	0,3	K	500	2,00 gal Zn
2,7	x	5	x	0,5	S	5000	0,70 gal Zn
2,7	x	5	x	0,5	K	500	2,20 gal Zn
3,2	x	6	x	0,5	S	5000	0,55 gal Zn
3,2	x	6	x	0,5	K	500	1,70 gal Zn
3,7	x	7	x	0,5	K	500	1,85 gal Zn
4,3	x	8	x	0,5	S	5000	0,45 gal Zn
4,3	x	8	x	0,5	K	500	1,55 gal Zn
5,3	x	9	x	1	S	5000	1,05 gal Zn
5,3	x	9	x	1	K	500	2,20 gal Zn
6,4	x	11	x	1,6	S	1000	1,95 gal Zn
6,4	x	11	x	1,6	K	250	4,15 gal Zn
8,4	x	15	x	1,6	S	1000	3,65 gal Zn
8,4	x	15	x	1,6	K	250	5,80 gal Zn
10,5	x	18	x	1,6	S	1000	5,40 gal Zn
10,5	x	18	x	1,6	K	250	8,60 gal Zn
13	x	20	x	2	S	1000	8,40 gal Zn
13	x	20	x	2	K	100	14,80 gal Zn
15	x	24	x	2,5	S	500	12,30 gal Zn
15	x	24	x	2,5	K	100	18,60 gal Zn
17	x	28	x	2,5	S	500	15,70 gal Zn
17	x	28	x	2,5	K	100	21,20 gal Zn
19	x	30	x	2,5	S	500	23,50 gal Zn
19	x	30	x	2,5	K	100	29,00 gal Zn
21	x	34	x	3	S	500	28,50 gal Zn
21	x	34	x	3	K	100	33,00 gal Zn

DIN	00434.000
434	Stahl

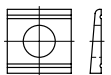

Scheiben, vierkant, keilförmig 8 %, für U-Träger

Maße → **TI-86**
 Rostfrei → **S. 466**

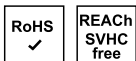

Innen Ø • ÜH-Fabrikate

9	S	100	32,50
11	S	100	32,50
13,5	S	100	44,00

Abmessungen	VE Stück	€/100/Obf.	
17,5	S	100	58,00
22	S	100	102,00
24	S	100	195,00
26	S	50	285,00

DIN	00434.010
434	Stahl
	galvanisch verzinkt

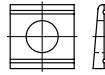

Scheiben, vierkant, keilförmig 8 %, für U-Träger

Maße → **TI-86** Korrosionsschutz → **TI-228**
 Rostfrei → **S. 466**

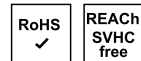

Innen Ø • ÜH-Fabrikate

9	S	100	30,00 gal Zn
11	S	100	38,00 gal Zn
13,5	S	100	44,50 gal Zn
17,5	S	100	66,00 gal Zn
22	S	100	106,00 gal Zn
26	S	50	310,00 gal Zn

DIN	00434.020
434	Stahl
	feuerverzinkt

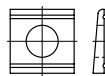

Scheiben, vierkant, keilförmig 8 %, für U-Träger

Maße → **TI-86** Korrosionsschutz → **TI-231**
 Rostfrei → **S. 466**



Innen Ø • ÜH-Fabrikate

9	S	100	38,00 tZn
11	S	100	37,00 tZn
13,5	S	100	54,00 tZn
17,5	S	100	76,00 tZn
22	S	100	132,00 tZn
24	S	100	240,00 tZn
26	S	50	360,00 tZn
33	S	50	440,00 tZn

Abmessungen	VE Stück	€/100/Obf.
DIN	00435.000	
435	Stahl	

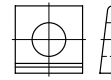

Scheiben, vierkant, keilförmig 14 %, für Doppel-T-Träger

Maße → **TI-86**
 Rostfrei → **S. 466**

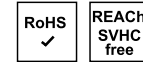

Innen Ø • ÜH-Fabrikate

9	S	100	54,00
11	S	100	54,00
13,5	S	100	57,00
17,5	S	100	86,00
22	S	100	141,00
24	S	100	236,00

DIN	00435.020
435	Stahl
	feuerverzinkt

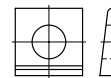

Scheiben, vierkant, keilförmig 14 %, für Doppel-T-Träger

Maße → **TI-86** Korrosionsschutz → **TI-231**
 Rostfrei → **S. 466**

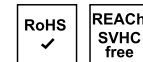

Innen Ø • ÜH-Fabrikate

9	S	100	61,00 tZn
11	S	100	60,00 tZn
13,5	S	100	68,00 tZn
17,5	S	100	107,00 tZn
22	S	100	182,00 tZn
24	S	100	295,00 tZn

Abmessungen	VE Stück	€/100/Obf.
DIN	00436.000	

436 Stahl

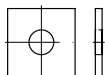

Scheiben, vierkant, vorwiegend für Holzkonstruktionen

Maße → [TI-86](#)

Rostfrei → [S. 467](#)



Innen Ø x Außenmaß x Dicke

11	x	30	x	3	S	100	17,10
13,5	x	40	x	4	S	100	36,00
17,5	x	50	x	5	S	50	65,00
22	x	60	x	5	S	50	96,00
24	x	70	x	6	S	50	195,00
26	x	80	x	6	S	50	255,00
30	x	90	x	6	S	25	315,00
33	x	95	x	6	S	25	345,00
36	x	100	x	6	S	25	385,00
39	x	110	x	8	S	25	650,00

DIN	00436.010
-----	-----------

436 Stahl galvanisch verzinkt

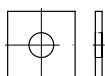

Scheiben, vierkant, vorwiegend für Holzkonstruktionen

Maße → [TI-86](#)

Korrosionsschutz → [TI-228](#)

Rostfrei → [S. 467](#)



Innen Ø x Außenmaß x Dicke

11	x	30	x	3	S	100	21,10 gal Zn
13,5	x	40	x	4	S	100	41,50 gal Zn
17,5	x	50	x	5	S	50	79,00 gal Zn
22	x	60	x	5	S	50	121,00 gal Zn
24	x	70	x	6	S	50	233,00 gal Zn
26	x	80	x	6	S	25	242,00 gal Zn
30	x	90	x	6	S	25	420,00 gal Zn
33	x	95	x	6	S	25	470,00 gal Zn
36	x	100	x	6	S	25	520,00 gal Zn
39	x	110	x	8	S	25	920,00 gal Zn

Abmessungen	VE Stück	€/100/Obf.
DIN	00436.020	

436 Stahl feuerverzinkt

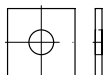

Scheiben, vierkant, vorwiegend für Holzkonstruktionen

Maße → [TI-86](#)

Korrosionsschutz → [TI-231](#)

Rostfrei → [S. 467](#)



Innen Ø x Außenmaß x Dicke

11	x	30	x	3	S	100	28,00 tZn
13,5	x	40	x	4	S	100	60,00 tZn
17,5	x	50	x	5	S	50	113,00 tZn
22	x	60	x	5	S	50	164,00 tZn
24	x	70	x	6	S	50	310,00 tZn
26	x	80	x	6	S	50	410,00 tZn
30	x	90	x	6	S	25	510,00 tZn
33	x	95	x	6	S	25	560,00 tZn
36	x	100	x	6	S	25	620,00 tZn
39	x	110	x	8	S	25	1060,00 tZn

DIN	00439.402
-----	-----------

439 04 Form B

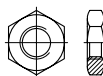

Sechskantmutter, niedrige Form, B = mit Fasen

Maße → [TI-61](#)

Normumstellung → [TI-7](#)

Werkstoffeigensch. → [TI-233](#)

REACH → [TI-262](#)

Rostfrei → [S. 467](#)

Messing → [S. 619](#)

DIN 439 → wird ersetzt durch ISO 4035



Abmessungen	VE Stück	€/100/Obf.
BM 18	S 100	73,00
BM 20	S 50	86,00
BM 22	S 50	132,00
BM 24	S 50	155,00
BM 27	S 25	295,00
BM 30	S 25	310,00
BM 33	S 10	560,00
BM 36	S 10	660,00
BM 42	S 10	1350,00

DIN	00439.412
-----	-----------

439 04 Form B galvanisch verzinkt

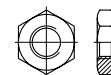

Sechskantmutter, niedrige Form, B = mit Fasen

Maße → [TI-61](#)

Normumstellung → [TI-7](#)

Werkstoffeigensch. → [TI-233](#)

REACH → [TI-262](#)

Korrosionsschutz → [TI-228](#)

Rostfrei → [S. 467](#)

Messing → [S. 619](#)

DIN 439 → wird ersetzt durch ISO 4035



BM 2	S 1000	3,95 gal Zn
BM 2,5	S 1000	3,95 gal Zn
BM 3	S 1000	3,15 gal Zn
BM 3	K 100	6,70 gal Zn
BM 4	S 1000	3,70 gal Zn
BM 4	K 100	7,30 gal Zn
BM 5	S 1000	4,30 gal Zn
BM 5	K 100	7,80 gal Zn
BM 6	S 1000	4,95 gal Zn
BM 6	K 100	8,50 gal Zn
BM 8	S 1000	9,60 gal Zn
BM 8	K 100	13,20 gal Zn
BM 10	S 500	19,00 gal Zn
BM 10	K 100	22,20 gal Zn
BM 12	S 100	33,50 gal Zn
BM 14	S 100	41,00 gal Zn
BM 16	S 100	44,50 gal Zn
BM 20	S 50	96,00 gal Zn
BM 24	S 50	174,00 gal Zn
BM 30	S 25	345,00 gal Zn
BM 33	S 10	630,00 gal Zn
BM 36	S 10	730,00 gal Zn
BM 42	S 10	1420,00 gal Zn

Abmessungen	VE Stück	€/100/Obf.
DIN	00439.304	
439	04	Form B
galv. verz. 8 DiSP*		

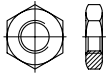

Sechskantmuttern, niedrige Form, B = mit Fasen

* < M 6 Mindestschichtdicke 5µm, Korrosionsbeständigkeit NSS: 72h WR, 120h RR

Maße → **TI-61** Normumstellung → **TI-7**
 Werkstoffeigensch. → **TI-233** REACH → **TI-262**
 Korrosionsschutz → **TI-228**

Rostfrei → **S. 467**
 Messing → **S. 619**

DIN 439 → wird ersetzt durch ISO 4035



BM 3	S 1000	4,25 gal ZnDi
BM 4	S 1000	5,10 gal ZnDi
BM 5	S 1000	6,00 gal ZnDi
BM 6	S 100	6,90 gal ZnDi
BM 8	S 1000	13,00 gal ZnDi
BM 10	S 500	25,50 gal ZnDi
BM 12	S 100	45,00 gal ZnDi
BM 16	S 100	60,00 gal ZnDi

Abmessungen	VE Stück	€/100/Obf.
DIN	00439.352	
439	04	Form B
flZn/TL480h		

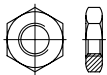

Sechskantmuttern, niedrige Form, B = mit Fasen

TL = Schmierstoff im Topcoat mit $\mu = 0,09 - 0,14$, Korrosionsbeständigkeit NSS: 480h RR, Chrom(VI)-frei

Maße → **TI-61** Normumstellung → **TI-7**
 Werkstoffeigensch. → **TI-233** REACH → **TI-262**
 Korrosionsschutz → **TI-230**

Rostfrei → **S. 467**
 Messing → **S. 619**

DIN 439 → wird ersetzt durch ISO 4035



BM 6	S 1000	6,50 flZn
BM 8	S 1000	12,50 flZn
BM 10	S 500	24,90 flZn
BM 12	S 100	44,00 flZn
BM 16	S 100	58,00 flZn
BM 20	S 50	125,00 flZn
BM 24	S 50	226,00 flZn
BM 30	S 25	510,00 flZn

Abmessungen	VE Stück	€/100/Obf.
DIN	00439.422	
439	04	Form B
feuerverzinkt*		

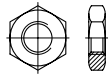

Sechskantmuttern, niedrige Form, B = mit Fasen

*Gewindetoleranz 6H

Maße → **TI-61** Normumstellung → **TI-7**
 Werkstoffeigensch. → **TI-233** REACH → **TI-262**
 Korrosionsschutz → **TI-231**

Rostfrei → **S. 467**
 Messing → **S. 619**

DIN 439 → wird ersetzt durch ISO 4035

BM 8	S 100	48,50 tZn
BM 10	S 100	48,50 tZn
BM 12	S 100	48,50 tZn
BM 16	S 100	56,00 tZn
BM 20	S 50	118,00 tZn
BM 24	S 50	210,00 tZn
BM 27	S 25	380,00 tZn
BM 30	S 25	420,00 tZn

Achtung!

Feuerverzinkte Schrauben-/Mutter-Garnituren dürfen nur miteinander verschraubt werden, wenn Gewindenspiel/-Toleranzen dieser Garnituren entsprechend ISO 10684 passend aufeinander abgestimmt sind. Die Verwendung mit anderen Schrauben-/Mutter-Ausführungen kann zu Verschraubungsproblemen und/oder zum Versagen der Verbindung führen.



Abmessungen	VE Stück	€/100/Obf.
DIN	00439.407	
439	04	Form B - Fein

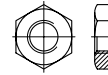

Sechskantmuttern, niedrige Form, mit metrischem Feingewinde, B = mit Fasen

Maße → **TI-61** Normumstellung → **TI-7**
 Werkstoffeigensch. → **TI-233** REACH → **TI-262**

Rostfrei → **S. 467**

DIN 439 Feingew. → wird ersetzt durch ISO 8675



BM 8	x 1	S 100	13,70
BM 10	x 1	S 100	21,10
BM 10	x 1,25	S 100	21,10
BM 12	x 1	S 100	33,00
BM 12	x 1,25	S 100	33,00
BM 12	x 1,5	S 100	33,00
BM 14	x 1,5	S 100	38,50
BM 16	x 1,5	S 50	45,50
BM 18	x 1,5	S 50	84,00
BM 20	x 1,5	S 50	95,00
BM 20	x 2	S 50	95,00
BM 24	x 1,5	S 25	190,00
BM 24	x 2	S 25	190,00
BM 27	x 1,5	S 25	315,00
BM 30	x 1,5	S 25	330,00
BM 30	x 2	S 25	330,00
BM 33	x 1,5	S 10	590,00
BM 36	x 1,5	S 10	690,00
BM 36	x 3	S 10	690,00
BM 39	x 1,5	S 10	1060,00
BM 39	x 3	S 10	1060,00
BM 42	x 1,5	S 10	1380,00
BM 42	x 2	S 10	1380,00
BM 42	x 3	S 10	1380,00
BM 48	x 1,5	S 10	2440,00
BM 48	x 2	S 10	2550,00
BM 48	x 3	S 10	2440,00

Abmessungen	VE Stück	€/100/obf.
DIN	00439.417	
439	04	Form B - Fein galvanisch verzinkt

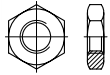

Sechskantmuttern, niedrige Form, mit metrischem Feingewinde, B = mit Fasen

Maße → **TI-61** Normumstellung → **TI-7**
 Werkstoffeigensch. → **TI-233** REACH → **TI-262**
 Korrosionsschutz → **TI-228**

Rostfrei → **S. 467**

DIN 439 Feingew. → wird ersetzt durch ISO 8675



BM 8	x 1	S 100	16,00 gal Zn
BM 10	x 1	S 100	23,60 gal Zn
BM 10	x 1,25	S 100	23,60 gal Zn
BM 12	x 1	S 100	37,00 gal Zn
BM 12	x 1,25	S 100	37,00 gal Zn
BM 12	x 1,5	S 100	37,00 gal Zn
BM 14	x 1,5	S 100	42,50 gal Zn
BM 16	x 1	S 100	55,00 gal Zn
BM 16	x 1,5	S 50	51,00 gal Zn
BM 18	x 1,5	S 50	91,00 gal Zn
BM 20	x 1,5	S 50	106,00 gal Zn
BM 22	x 1,5	S 50	170,00 gal Zn
BM 24	x 1,5	S 25	207,00 gal Zn
BM 24	x 2	S 25	230,00 gal Zn
BM 27	x 1,5	S 25	425,00 gal Zn
BM 30	x 1,5	S 25	370,00 gal Zn
BM 30	x 2	S 25	370,00 gal Zn
BM 33	x 1,5	S 50	710,00 gal Zn
BM 35	x 1,5	S 50	1520,00 gal Zn
BM 36	x 1,5	S 10	780,00 gal Zn
BM 36	x 2	S 10	780,00 gal Zn
BM 36	x 3	S 10	780,00 gal Zn
BM 39	x 2	S 10	1180,00 gal Zn
BM 42	x 1,5	S 10	1530,00 gal Zn
BM 42	x 2	S 10	1530,00 gal Zn
BM 42	x 3	S 10	1530,00 gal Zn

Abmessungen	VE Stück	€/100/obf.
DIN	00439.415	
439	04	Form B - Links galvanisch verzinkt

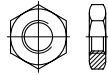

Sechskantmuttern, niedrige Form, mit metrischem Linksgewinde, B = mit Fasen

Maße → **TI-61** Normumstellung → **TI-7**
 Werkstoffeigensch. → **TI-233** REACH → **TI-262**
 Korrosionsschutz → **TI-228**

DIN 439 → wird ersetzt durch ISO 4035



BM 6	S 100	36,50 gal Zn
BM 8	S 100	18,20 gal Zn
BM 10	S 100	36,50 gal Zn
BM 12	S 100	73,00 gal Zn
BM 16	S 50	115,00 gal Zn
BM 20	S 50	218,00 gal Zn
BM 24	S 25	425,00 gal Zn
BM 30	S 25	730,00 gal Zn
BM 36	S 10	1940,00 gal Zn
BM 42	S 10	2180,00 gal Zn

DIN	00440.008
440	Stahl 100 HV Form R

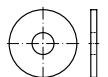

Scheiben, R = mit Rundloch

vorwiegend für Holzkonstruktionen

Maße → **TI-84** Normumstellung → **TI-84**

Rostfrei → **S. 467**

DIN 440 Form R → wird ersetzt durch ISO 7094

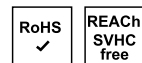

Innen Ø x Außen Ø x Dicke

R 5,5	x 18	x 2	S 100	6,20
R 6,6	x 22	x 2	S 100	6,80
R 9	x 28	x 3	S 100	11,40
R 11	x 34	x 3	S 100	16,00
R 13,5	x 44	x 4	S 100	28,50
R 17,5	x 56	x 5	S 50	49,50
R 22	x 72	x 6	S 50	83,00
R 24	x 80	x 6	S 50	126,00
R 26	x 85	x 6	S 50	164,00
R 30	x 98	x 6	S 25	215,00
R 33	x 105	x 6	S 25	250,00
R 36	x 112	x 6	S 25	285,00
R 39	x 125	x 8	S 25	460,00
R 42	x 140	x 8	S 25	910,00
R 45	x 150	x 8	S 10	970,00

Abmessungen	VE Stück	€/100/obf.
DIN	00440.018	
440	Stahl 100 HV	Form R galvanisch verzinkt



Scheiben, R = mit Rundloch

vorwiegend für Holzkonstruktionen

Maße → **TI-84** Normumstellung → **TI-84**
 Korrosionsschutz → **TI-228**

Rostfrei → **S. 467**

DIN 440 Form R → wird ersetzt durch ISO 7094



Innen Ø x Außen Ø x Dicke

R 5,5	x 18	x 2	S 100	7,20 gal Zn
R 6,6	x 22	x 2	S 100	8,30 gal Zn
R 9	x 28	x 3	S 100	14,70 gal Zn
R 11	x 34	x 3	S 100	20,70 gal Zn
R 13,5	x 44	x 4	S 100	39,50 gal Zn
R 17,5	x 56	x 5	S 50	73,00 gal Zn
R 22	x 72	x 6	S 50	142,00 gal Zn
R 24	x 80	x 6	S 50	181,00 gal Zn
R 26	x 85	x 6	S 50	224,00 gal Zn
R 30	x 98	x 6	S 25	300,00 gal Zn
R 33	x 105	x 6	S 25	345,00 gal Zn
R 36	x 112	x 6	S 25	395,00 gal Zn
R 39	x 125	x 8	S 25	630,00 gal Zn
R 42	x 140	x 8	S 25	1110,00 gal Zn

DIN	00440.028
440	Stahl 100 HV Form R feuerverzinkt



Scheiben, R = mit Rundloch

vorwiegend für Holzkonstruktionen

Maße → **TI-84** Normumstellung → **TI-84**
 Korrosionsschutz → **TI-231**

Rostfrei → **S. 467**

DIN 440 Form R → wird ersetzt durch ISO 7094



Innen Ø x Außen Ø x Dicke

R 6,6	x 22	x 2	S 100	29,50 tZn
R 9	x 28	x 3	S 100	39,50 tZn
R 11	x 34	x 3	S 100	39,50 tZn
R 13,5	x 44	x 4	S 100	48,00 tZn
R 17,5	x 56	x 5	S 50	89,00 tZn
R 22	x 72	x 6	S 50	143,00 tZn
R 26	x 85	x 6	S 50	295,00 tZn

Abmessungen	VE Stück	€/100/Obf.
DIN	00440.004	

440

Stahl 100 HV Form V

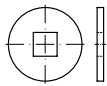

Scheiben, V = mit Vierkantloch

vorwiegend für Holzkonstruktionen

Maße → **TI-84** Normumstellung → **TI-84**



Innen x Außen Ø x Dicke

V 6,6	x	22	x	2	S	100	6,80
V 9	x	28	x	3	S	100	11,40
V 11	x	34	x	3	S	100	16,00
V 14	x	44	x	4	S	100	28,50
V 18	x	56	x	5	S	100	49,50

DIN	00440.014
440	Stahl 100 HV Form V galvanisch verzinkt

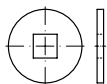

Scheiben, V = mit Vierkantloch

vorwiegend für Holzkonstruktionen

Maße → **TI-84** Normumstellung → **TI-84**

Korrosionsschutz → **TI-228**



Innen x Außen Ø x Dicke

V 6,6	x	22	x	2	S	100	10,60 gal Zn
V 9	x	28	x	3	S	100	15,20 gal Zn
V 11	x	34	x	3	S	100	19,80 gal Zn
V 14	x	44	x	4	S	100	38,00 gal Zn
V 18	x	56	x	5	S	100	68,00 gal Zn
V 22	x	72	x	6	S	50	101,00 gal Zn

DIN	00443.000
443	Stahl

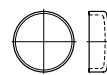

Verschlussdeckel zum Eindrücken

Maße → **TI-112** REACH → **TI-262**



8	S	100	23,90
10	S	100	27,00
12	S	100	31,50

Abmessungen	VE Stück	€/100/Obf.	
14	S	100	34,50
16	S	100	38,50
18	S	100	43,00
20	S	100	46,00
22	S	100	60,00
25	S	100	67,00
28	S	100	74,00
30	S	50	86,00
32	S	50	94,00
36	S	50	135,00
38	S	50	151,00
40	S	25	161,00
42	S	25	181,00
45	S	25	194,00
50	S	25	222,00
56	S	10	330,00

DIN	00444.402
444	4.6 Form B

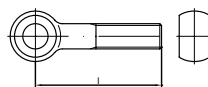

Augenschrauben, B = Produktklasse B (mg)

Maße → **TI-30** REACH → **TI-262**

Werkstoffeigensch. → **TI-232**

Rostfrei → **S. 468**

Messing → **S. 619**



Gewinde M x Länge l

BM 5	x	25	S	50	325,00
BM 5	x	30	S	50	325,00
BM 5	x	35	S	50	295,00
BM 5	x	40	S	25	425,00
BM 6	x	25	S	50	325,00
BM 6	x	30	S	50	325,00
BM 6	x	35	S	50	295,00
BM 6	x	40	S	50	295,00
BM 6	x	45	S	25	325,00
BM 6	x	50	S	25	325,00
BM 6	x	55	S	25	340,00
BM 6	x	60	S	25	340,00
BM 6	x	65	S	25	410,00
BM 6	x	70	S	25	410,00
BM 6	x	75	S	25	470,00
BM 6	x	80	S	25	470,00
BM 8	x	25	S	50	360,00
BM 8	x	30	S	50	360,00
BM 8	x	35	S	50	370,00
BM 8	x	40	S	25	380,00
BM 8	x	45	S	25	385,00
BM 8	x	50	S	25	385,00
BM 8	x	55	S	25	390,00
BM 8	x	60	S	25	390,00
BM 8	x	65	S	25	410,00
BM 8	x	70	S	25	410,00
BM 8	x	75	S	25	420,00
BM 8	x	80	S	25	420,00
BM 8	x	90	S	25	430,00
BM 8	x	100	S	25	440,00
BM 8	x	110	S	25	510,00
BM 8	x	120	S	25	540,00
BM 8	x	130	S	25	580,00
BM 8	x	140	S	25	610,00
BM 10	x	30	S	50	410,00
BM 10	x	35	S	50	420,00

Abmessungen	VE Stück	€/100/Obf.			
BM 10	x	40	S	25	425,00
BM 10	x	45	S	25	440,00
BM 10	x	50	S	25	440,00
BM 10	x	55	S	25	455,00
BM 10	x	60	S	25	455,00
BM 10	x	65	S	25	470,00
BM 10	x	70	S	25	470,00
BM 10	x	75	S	25	475,00
BM 10	x	80	S	25	475,00
BM 10	x	90	S	25	495,00
BM 10	x	100	S	25	510,00
BM 10	x	110	S	25	530,00
BM 10	x	120	S	10	580,00
BM 10	x	130	S	10	610,00
BM 10	x	140	S	10	660,00
BM 12	x	30	S	25	440,00
BM 12	x	40	S	25	455,00
BM 12	x	45	S	25	475,00
BM 12	x	50	S	10	510,00
BM 12	x	55	S	10	530,00
BM 12	x	60	S	10	530,00
BM 12	x	65	S	10	540,00
BM 12	x	70	S	10	540,00
BM 12	x	75	S	10	540,00
BM 12	x	80	S	10	540,00
BM 12	x	90	S	10	570,00
BM 12	x	100	S	10	620,00
BM 12	x	110	S	10	650,00
BM 12	x	120	S	10	680,00
BM 12	x	130	S	10	740,00
BM 12	x	140	S	10	790,00
BM 12	x	150	S	10	860,00
BM 12	x	160	S	10	970,00
BM 12	x	180	S	10	1030,00
BM 12	x	200	S	10	1080,00
BM 16	x	40	S	10	780,00
BM 16	x	50	S	10	780,00
BM 16	x	60	S	10	780,00
BM 16	x	65	S	10	820,00
BM 16	x	70	S	10	820,00
BM 16	x	75	S	10	830,00
BM 16	x	80	S	10	830,00
BM 16	x	90	S	10	850,00
BM 16	x	100	S	10	850,00
BM 16	x	110	S	10	890,00
BM 16	x	120	S	10	910,00
BM 16	x	130	S	10	940,00
BM 16	x	140	S	10	960,00
BM 16	x	150	S	10	990,00
BM 16	x	160	S	10	1020,00
BM 16	x	180	S	10	1080,00
BM 16	x	200	S	10	1140,00
BM 20	x	80	S	10	1120,00
BM 20	x	90	S	10	1170,00
BM 20	x	100	S	1	1230,00
BM 20	x	110	S	1	1260,00
BM 20	x	120	S	1	1320,00
BM 20	x	130	S	1	1360,00
BM 20	x	140	S	1	1470,00
BM 20	x	150	S	1	1570,00
BM 20	x	160	S	1	1660,00
BM 20	x	170	S	1	1820,00
BM 20	x	180	S	1	1970,00
BM 20	x	200	S	1	2220,00
BM 20	x	260	S	1	2800,00
BM 24	x	80	S	1	1550,00
BM 24	x	90	S	1	1630,00
BM 24	x	100	S	1	1700,00
BM 24	x	110	S	1	1770,00
BM 24	x	120	S	1	1860,00
BM 24	x	130	S	1	1950,00
BM 24	x	140	S	1	2050,00
BM 24	x	150	S	1	2160,00
BM 24	x	160	S	1	2240,00
BM 24	x	170	S	1	2360,00

Abmessungen	VE	Stück	€/100/obf.
BM 24 x 180	S	1	2500,00
BM 24 x 200	S	1	2750,00
BM 30 x 100	S	1	3550,00
BM 30 x 120	S	1	3650,00
BM 30 x 130	S	1	3700,00
BM 30 x 140	S	1	3850,00
BM 30 x 150	S	1	3900,00
BM 30 x 160	S	1	4100,00
BM 30 x 180	S	1	4400,00
BM 30 x 200	S	1	4600,00

DIN	00444.412
444	4.6 Form B galvanisch verzinkt

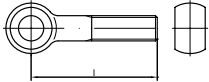

Augenschrauben, B = Produktklasse B (mg)

Maße → **TI-30** Korrosionsschutz → **TI-228**
 Werkstoffeigensch. → **TI-232** REACH → **TI-262**

Rostfrei → **S. 468**
 Messing → **S. 619**



Gewinde M x Länge l

BM 5 x 25	S	50	330,00 gal Zn
BM 5 x 30	S	50	330,00 gal Zn
BM 5 x 35	S	50	315,00 gal Zn
BM 5 x 40	S	50	305,00 gal Zn
BM 6 x 20	S	50	325,00 gal Zn
BM 6 x 25	S	50	330,00 gal Zn
BM 6 x 30	S	50	330,00 gal Zn
BM 6 x 35	S	50	335,00 gal Zn
BM 6 x 40	S	50	305,00 gal Zn
BM 6 x 45	S	25	330,00 gal Zn
BM 6 x 50	S	25	330,00 gal Zn
BM 6 x 55	S	25	340,00 gal Zn
BM 6 x 60	S	25	345,00 gal Zn
BM 6 x 65	S	25	415,00 gal Zn
BM 6 x 70	S	25	415,00 gal Zn
BM 6 x 75	S	25	455,00 gal Zn
BM 6 x 80	S	25	485,00 gal Zn
BM 8 x 25	S	50	410,00 gal Zn
BM 8 x 30	S	50	410,00 gal Zn
BM 8 x 35	S	50	425,00 gal Zn
BM 8 x 40	S	25	390,00 gal Zn
BM 8 x 45	S	25	420,00 gal Zn
BM 8 x 50	S	25	395,00 gal Zn
BM 8 x 55	S	25	520,00 gal Zn
BM 8 x 60	S	25	415,00 gal Zn
BM 8 x 65	S	50	510,00 gal Zn
BM 8 x 70	S	25	425,00 gal Zn
BM 8 x 75	S	25	580,00 gal Zn
BM 8 x 80	S	25	440,00 gal Zn
BM 8 x 90	S	25	450,00 gal Zn
BM 8 x 100	S	25	470,00 gal Zn
BM 8 x 110	S	25	540,00 gal Zn
BM 8 x 120	S	25	570,00 gal Zn
BM 8 x 130	S	25	630,00 gal Zn
BM 8 x 140	S	25	670,00 gal Zn
BM 10 x 30	S	50	420,00 gal Zn
BM 10 x 35	S	50	385,00 gal Zn
BM 10 x 40	S	25	440,00 gal Zn
BM 10 x 45	S	25	455,00 gal Zn
BM 10 x 50	S	25	460,00 gal Zn
BM 10 x 55	S	25	475,00 gal Zn
BM 10 x 60	S	25	475,00 gal Zn

Abmessungen	VE	Stück	€/100/obf.
BM 10 x 65	S	25	495,00 gal Zn
BM 10 x 70	S	25	495,00 gal Zn
BM 10 x 75	S	25	495,00 gal Zn
BM 10 x 80	S	25	510,00 gal Zn
BM 10 x 90	S	25	530,00 gal Zn
BM 10 x 100	S	25	540,00 gal Zn
BM 10 x 110	S	25	660,00 gal Zn
BM 10 x 120	S	10	710,00 gal Zn
BM 10 x 130	S	10	760,00 gal Zn
BM 10 x 140	S	10	820,00 gal Zn
BM 12 x 30	S	25	455,00 gal Zn
BM 12 x 40	S	25	480,00 gal Zn
BM 12 x 45	S	25	510,00 gal Zn
BM 12 x 50	S	10	540,00 gal Zn
BM 12 x 55	S	10	560,00 gal Zn
BM 12 x 60	S	10	560,00 gal Zn
BM 12 x 65	S	10	570,00 gal Zn
BM 12 x 70	S	10	580,00 gal Zn
BM 12 x 75	S	10	610,00 gal Zn
BM 12 x 80	S	10	590,00 gal Zn
BM 12 x 90	S	10	630,00 gal Zn
BM 12 x 100	S	10	670,00 gal Zn
BM 12 x 110	S	10	690,00 gal Zn
BM 12 x 120	S	10	760,00 gal Zn
BM 12 x 130	S	10	820,00 gal Zn
BM 12 x 140	S	10	880,00 gal Zn
BM 12 x 150	S	10	950,00 gal Zn
BM 12 x 160	S	10	1060,00 gal Zn
BM 12 x 180	S	10	1150,00 gal Zn
BM 12 x 200	S	10	1280,00 gal Zn
BM 16 x 40	S	25	730,00 gal Zn
BM 16 x 50	S	10	790,00 gal Zn
BM 16 x 60	S	10	850,00 gal Zn
BM 16 x 65	S	10	880,00 gal Zn
BM 16 x 70	S	10	880,00 gal Zn
BM 16 x 75	S	10	890,00 gal Zn
BM 16 x 80	S	10	910,00 gal Zn
BM 16 x 90	S	10	950,00 gal Zn
BM 16 x 100	S	10	950,00 gal Zn
BM 16 x 110	S	10	1010,00 gal Zn
BM 16 x 120	S	10	1030,00 gal Zn
BM 16 x 130	S	10	1020,00 gal Zn
BM 16 x 140	S	10	1110,00 gal Zn
BM 16 x 150	S	10	1140,00 gal Zn
BM 16 x 160	S	10	1170,00 gal Zn
BM 16 x 180	S	10	1240,00 gal Zn
BM 16 x 200	S	10	1320,00 gal Zn
BM 20 x 80	S	10	1260,00 gal Zn
BM 20 x 90	S	1	1280,00 gal Zn
BM 20 x 100	S	1	1380,00 gal Zn
BM 20 x 110	S	1	1440,00 gal Zn
BM 20 x 120	S	1	1520,00 gal Zn
BM 20 x 130	S	1	1570,00 gal Zn
BM 20 x 140	S	1	1700,00 gal Zn
BM 20 x 150	S	1	1710,00 gal Zn
BM 20 x 160	S	1	1920,00 gal Zn
BM 20 x 170	S	1	2060,00 gal Zn
BM 20 x 180	S	1	2240,00 gal Zn
BM 20 x 200	S	1	2550,00 gal Zn
BM 20 x 220	S	1	2800,00 gal Zn
BM 20 x 240	S	1	3100,00 gal Zn
BM 20 x 260	S	1	3400,00 gal Zn
BM 20 x 280	S	1	3700,00 gal Zn
BM 20 x 300	S	1	1970,00 gal Zn
BM 24 x 80	S	1	1920,00 gal Zn
BM 24 x 90	S	1	2000,00 gal Zn
BM 24 x 100	S	1	2060,00 gal Zn
BM 24 x 110	S	1	2130,00 gal Zn
BM 24 x 120	S	1	2220,00 gal Zn
BM 24 x 130	S	1	2320,00 gal Zn
BM 24 x 140	S	1	2410,00 gal Zn
BM 24 x 150	S	1	2550,00 gal Zn
BM 24 x 160	S	1	2700,00 gal Zn
BM 24 x 170	S	1	2800,00 gal Zn
BM 24 x 180	S	1	2900,00 gal Zn

Abmessungen	VE	Stück	€/100/obf.
BM 24 x 200	S	1	3150,00 gal Zn
BM 30 x 120	S	1	4750,00 gal Zn
BM 30 x 130	S	1	4850,00 gal Zn
BM 30 x 140	S	1	5000,00 gal Zn
BM 30 x 150	S	1	5100,00 gal Zn
BM 30 x 160	S	1	5300,00 gal Zn
BM 30 x 180	S	1	5700,00 gal Zn
BM 30 x 200	S	1	6000,00 gal Zn

DIN	00444.414
444	4.6 Form LB galvanisch verzinkt

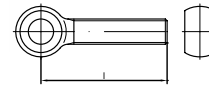

Augenschrauben, L = langes Gewinde B = Produktklasse B (mg)

Maße → **TI-30** Korrosionsschutz → **TI-228**
 Werkstoffeigensch. → **TI-232** REACH → **TI-262**



Gewinde M x Länge l

LBM 8 x 60	S	25	495,00 gal Zn
LBM 8 x 70	S	25	520,00 gal Zn
LBM 8 x 80	S	25	540,00 gal Zn
LBM 8 x 100	S	25	570,00 gal Zn
LBM 10 x 50	S	25	480,00 gal Zn
LBM 10 x 60	S	25	520,00 gal Zn
LBM 10 x 70	S	25	590,00 gal Zn
LBM 10 x 80	S	25	620,00 gal Zn
LBM 10 x 100	S	25	660,00 gal Zn
LBM 12 x 80	S	10	720,00 gal Zn
LBM 12 x 90	S	10	780,00 gal Zn
LBM 12 x 100	S	10	820,00 gal Zn
LBM 12 x 120	S	10	940,00 gal Zn
LBM 12 x 140	S	10	1070,00 gal Zn
LBM 16 x 80	S	10	1110,00 gal Zn
LBM 16 x 100	S	10	1150,00 gal Zn
LBM 16 x 120	S	10	1240,00 gal Zn
LBM 16 x 140	S	10	1310,00 gal Zn
LBM 16 x 150	S	10	1470,00 gal Zn
LBM 16 x 160	S	10	1570,00 gal Zn
LBM 16 x 180	S	10	1760,00 gal Zn
LBM 16 x 200	S	10	1970,00 gal Zn
LBM 20 x 100	S	10	1660,00 gal Zn
LBM 20 x 120	S	1	1810,00 gal Zn
LBM 20 x 130	S	1	1890,00 gal Zn
LBM 20 x 140	S	1	2040,00 gal Zn
LBM 20 x 150	S	1	2070,00 gal Zn
LBM 20 x 160	S	1	2300,00 gal Zn
LBM 24 x 80	S	1	2490,00 gal Zn
LBM 24 x 90	S	1	2650,00 gal Zn
LBM 24 x 100	S	1	2700,00 gal Zn
LBM 24 x 110	S	1	2800,00 gal Zn
LBM 24 x 120	S	1	2900,00 gal Zn
LBM 24 x 130	S	1	3050,00 gal Zn
LBM 24 x 140	S	1	3150,00 gal Zn
LBM 24 x 150	S	1	3300,00 gal Zn
LBM 24 x 160	S	1	3550,00 gal Zn
LBM 24 x 170	S	1	3650,00 gal Zn
LBM 24 x 180	S	1	3750,00 gal Zn
LBM 24 x 200	S	1	3950,00 gal Zn

Abmessungen	VE Stück	€/100/Obf.
DIN	00462.000	

462

Stahl

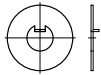

Scheiben mit Innennase

(für Nutmuttern DIN 1804)

Maße → TI-90



8	S	100	95,00
10	S	100	101,00
14	S	100	112,00
16	S	50	120,00
18	S	50	126,00
20	S	50	137,00
22	S	50	143,00
24	S	50	148,00
28	S	50	160,00
30	S	50	160,00
32	S	50	174,00
35	S	25	205,00
38	S	25	221,00
40	S	25	235,00
42	S	25	235,00
45	S	25	255,00
48	S	25	260,00
50	S	25	260,00
52	S	25	290,00
55	S	25	290,00
58	S	10	345,00
60	S	10	345,00
62	S	10	380,00
65	S	10	380,00
70	S	10	415,00
72	S	10	510,00
75	S	10	510,00
80	S	10	580,00
85	S	10	650,00
95	S	10	910,00
100	S	10	1070,00

~DIN	00463.000
------	-----------

463

Stahl

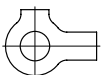

Scheiben mit 2 Lappen

Achtung! Nicht geeignet für hochfeste Schraubenverbindungen.

Maße → TI-91

Rostfrei → S. 469
Messing → S. 619

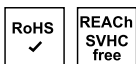

3,2	K	100	13,80
5,3	S	1000	11,30

Abmessungen	VE Stück	€/100/Obf.
-------------	----------	------------

5,3	K	100	15,40
6,4	S	1000	12,60
6,4	K	100	17,10
8,4	S	1000	17,00
8,4	K	100	21,70
10,5	S	1000	19,30
10,5	K	100	24,40
13	S	500	23,40
13	K	100	29,50
15	K	100	30,50
17	S	500	34,00
17	K	100	41,00
19	K	100	42,00
21	S	250	38,50
21	K	100	44,50
23	S	100	63,00
25	S	100	67,00
28	S	50	134,00
31	S	50	146,00
34	S	50	161,00
37	S	50	182,00
40	S	25	216,00
43	S	25	223,00
50	S	25	295,00
54	S	25	340,00

~DIN	00463.010
------	-----------

463 Stahl galvanisch verzinkt



Scheiben mit 2 Lappen

Achtung! Nicht geeignet für hochfeste Schraubenverbindungen.

Maße → TI-91 Korrosionsschutz → TI-228

Rostfrei → S. 469
Messing → S. 619



3,2	K	100	27,50 gal Zn
4,3	K	100	14,80 gal Zn
5,3	K	100	15,70 gal Zn
6,4	S	1000	12,90 gal Zn
6,4	K	100	17,20 gal Zn
8,4	S	1000	17,40 gal Zn
8,4	K	100	22,30 gal Zn
10,5	S	1000	20,00 gal Zn
10,5	K	100	25,50 gal Zn
13	S	500	24,90 gal Zn
13	K	100	31,00 gal Zn
15	K	100	32,50 gal Zn
17	S	500	36,50 gal Zn
17	K	100	42,50 gal Zn
19	K	100	44,50 gal Zn
21	S	250	41,50 gal Zn
21	K	100	47,50 gal Zn
23	S	100	67,00 gal Zn
25	S	100	72,00 gal Zn
28	S	50	142,00 gal Zn
31	S	50	157,00 gal Zn
34	S	50	174,00 gal Zn
37	S	50	195,00 gal Zn
40	S	25	229,00 gal Zn

Abmessungen	VE Stück	€/100/Obf.
-------------	----------	------------

464 Stahl

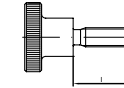

Rändelschrauben, hohe Form

Maße → TI-30 REACH → TI-262

Rostfrei → S. 469
Messing → S. 619



Gewinde M x Länge l

M 3	x	5	S	50	76,00
M 3	x	6	S	50	78,00
M 3	x	8	S	50	78,00
M 3	x	10	S	50	79,00
M 3	x	12	S	50	85,00
M 3	x	16	S	50	92,00
M 4	x	5	S	50	101,00
M 4	x	6	S	50	105,00
M 4	x	8	S	50	108,00
M 4	x	10	S	50	112,00
M 4	x	12	S	50	115,00
M 4	x	16	S	50	121,00
M 4	x	18	S	50	151,00
M 4	x	20	S	50	136,00
M 4	x	25	S	50	137,00
M 4	x	30	S	50	152,00
M 5	x	8	S	50	125,00
M 5	x	10	S	50	128,00
M 5	x	12	S	50	132,00
M 5	x	16	S	50	141,00
M 5	x	20	S	50	153,00
M 5	x	25	S	25	165,00
M 5	x	30	S	25	183,00
M 5	x	40	S	25	207,00
M 6	x	8	S	25	165,00
M 6	x	10	S	25	170,00
M 6	x	12	S	25	175,00
M 6	x	16	S	25	184,00
M 6	x	20	S	25	201,00
M 6	x	25	S	25	216,00
M 6	x	30	S	25	230,00
M 6	x	35	S	25	244,00
M 6	x	40	S	25	265,00
M 8	x	10	S	25	305,00
M 8	x	12	S	25	310,00
M 8	x	16	S	25	325,00
M 8	x	20	S	25	345,00
M 8	x	25	S	25	380,00
M 8	x	30	S	10	420,00
M 8	x	35	S	10	445,00
M 8	x	40	S	10	485,00
M 10	x	20	S	10	520,00
M 10	x	25	S	10	560,00
M 10	x	30	S	10	600,00
M 10	x	40	S	10	680,00

Abmessungen	VE Stück	€/100/Obf.
DIN	00464.510	
464	Stahl	galvanisch verzinkt

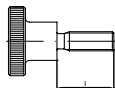

Rändelschrauben, hohe Form

Maße → **TI-30** REACH → **TI-262**
 Korrosionsschutz → **TI-228**
 Rostfrei → **S. 469**
 Messing → **S. 619**



Gewinde M x Länge l

M 3	x	6	S	50	91,00 gal Zn
M 3	x	8	S	50	97,00 gal Zn
M 3	x	10	S	50	105,00 gal Zn
M 3	x	16	S	50	112,00 gal Zn
M 4	x	6	S	50	121,00 gal Zn
M 4	x	8	S	50	128,00 gal Zn
M 4	x	10	S	50	138,00 gal Zn
M 4	x	12	S	50	146,00 gal Zn
M 4	x	16	S	50	153,00 gal Zn
M 4	x	20	S	50	174,00 gal Zn
M 5	x	8	S	50	138,00 gal Zn
M 5	x	10	S	50	153,00 gal Zn
M 5	x	12	S	50	164,00 gal Zn
M 5	x	16	S	50	174,00 gal Zn
M 5	x	20	S	50	181,00 gal Zn
M 5	x	25	S	25	193,00 gal Zn
M 5	x	30	S	25	211,00 gal Zn
M 5	x	40	S	25	236,00 gal Zn
M 6	x	10	S	25	227,00 gal Zn
M 6	x	12	S	25	235,00 gal Zn
M 6	x	16	S	25	250,00 gal Zn
M 6	x	20	S	25	280,00 gal Zn
M 6	x	25	S	25	335,00 gal Zn
M 6	x	30	S	25	365,00 gal Zn
M 6	x	35	S	25	390,00 gal Zn
M 6	x	40	S	25	400,00 gal Zn
M 8	x	12	S	25	345,00 gal Zn
M 8	x	16	S	25	365,00 gal Zn
M 8	x	20	S	25	380,00 gal Zn
M 8	x	25	S	25	690,00 gal Zn
M 10	x	25	S	10	600,00 gal Zn

Abmessungen	VE Stück	€/100/Obf.
DIN	00466.500	
466	5	



Rändelmuttern, hohe Form

Maße → **TI-72** REACH → **TI-262**
 Werkstoffeigensch. → **TI-233**
 Rostfrei → **S. 469**
 Messing → **S. 620**



M 3	S	100	29,00
M 4	S	100	44,50
M 5	S	100	66,00
M 6	S	50	106,00
M 8	S	50	195,00
M 10	S	25	335,00

DIN	00466.510
466	5
	galvanisch verzinkt



Rändelmuttern, hohe Form

Maße → **TI-72** Korrosionsschutz → **TI-228**
 Werkstoffeigensch. → **TI-233** REACH → **TI-262**
 Rostfrei → **S. 469**
 Messing → **S. 620**



M 3	S	100	30,00 gal Zn
M 4	S	100	47,00 gal Zn
M 5	S	100	68,00 gal Zn
M 6	S	50	113,00 gal Zn
M 8	S	50	210,00 gal Zn
M 10	S	25	355,00 gal Zn
M 12	S	25	425,00 gal Zn

Abmessungen	VE Stück	€/100/Obf.
DIN	00467.500	
467	5	



Rändelmuttern, niedrige Form

Maße → **TI-72** REACH → **TI-262**
 Werkstoffeigensch. → **TI-233**
 Rostfrei → **S. 469**
 Messing → **S. 620**



M 3	S	100	24,10
M 4	S	100	34,00
M 5	S	100	47,00
M 6	S	100	68,00
M 8	S	50	131,00
M 10	S	50	210,00

DIN	00467.510
467	5
	galvanisch verzinkt



Rändelmuttern, niedrige Form

Maße → **TI-72** Korrosionsschutz → **TI-228**
 Werkstoffeigensch. → **TI-233** REACH → **TI-262**
 Rostfrei → **S. 469**
 Messing → **S. 620**



M 3	S	100	24,90 gal Zn
M 4	S	100	36,50 gal Zn
M 5	S	100	49,50 gal Zn
M 6	S	100	74,00 gal Zn
M 8	S	50	142,00 gal Zn
M 10	S	50	206,00 gal Zn
M 12	S	25	305,00 gal Zn



- ✓ Große Artikelvielfalt
- ✓ Verlässliche Qualität
- ✓ Hohe Lieferbereitschaft



Wir versorgen Sie mit
 Verbindungselementen
 und Befestigungstechnik!

Abmessungen VE Stück €/100/Obf.
 DIN 00470.000

470

Stahl

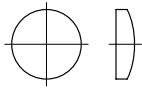

Verschluss Scheiben

Maße → TI-112 REACH → TI-262



Abm.	VE	Stück	€/100/Obf.
6	K	100	31,50
8	K	100	25,50
10	S	1000	20,60
10	K	100	25,50
12	K	100	26,50
14	S	1000	23,40
14	K	100	29,00
16	S	1000	24,00
16	K	100	29,50
18	K	100	30,00
20	S	500	28,00
20	K	100	33,00
22	K	100	43,00
25	S	500	42,50
25	K	100	49,50
28	S	500	47,00
28	K	100	54,00
30	S	250	53,00
30	K	100	61,00
32	S	100	58,00
34	S	50	68,00
36	S	50	73,00
38	S	50	83,00
40	S	50	86,00
42	S	50	95,00
45	S	50	102,00
48	S	50	112,00
50	S	50	117,00
52	S	50	130,00
56	S	50	142,00
60	S	50	166,00
63	S	25	177,00
80	S	25	310,00
100	S	10	480,00
125	S	10	990,00

DIN 00471.000

471

Federstahl

Regel



Sicherungsringe (Haltringe) für Wellen, Regelausführung

Maße → TI-91



Nennmaß = für Wellen Ø x Dicke

Abm.	VE	Stück	€/100/Obf.
3	x	0,4	S10000 1,35
3	x	0,4	K 200 4,95

Abmessungen VE Stück €/100/Obf.

4	x	0,4	S10000 1,35
4	x	0,4	K 200 4,95
5	x	0,6	S 5000 1,75
5	x	0,6	K 200 5,70
6	x	0,7	S 5000 1,75
6	x	0,7	K 200 5,70
7	x	0,8	S 2500 2,25
7	x	0,8	K 200 6,50
8	x	0,8	S 2000 2,00
8	x	0,8	K 200 6,20
9	x	1	S 2000 3,45
9	x	1	K 200 8,50
10	x	1	S 2000 2,90
10	x	1	K 200 7,80
11	x	1	S 1000 3,85
11	x	1	K 200 9,20
12	x	1	S 1000 3,35
12	x	1	K 200 8,40
13	x	1	S 1000 4,15
13	x	1	K 200 9,60
14	x	1	S 1000 4,10
14	x	1	K 200 9,60
15	x	1	S 1000 4,40
15	x	1	K 200 10,20
16	x	1	S 1000 4,60
16	x	1	K 200 10,50
17	x	1	S 1000 5,20
17	x	1	K 200 11,40
18	x	1,2	S 1000 6,70
18	x	1,2	K 200 13,80
19	x	1,2	S 1000 7,40
19	x	1,2	K 200 15,30
20	x	1,2	S 1000 7,30
20	x	1,2	K 200 14,80
21	x	1,2	S 1000 8,40
21	x	1,2	K 200 16,70
22	x	1,2	S 500 8,60
22	x	1,2	K 200 17,20
23	x	1,2	S 500 11,70
23	x	1,2	K 200 22,20
24	x	1,2	S 500 9,70
24	x	1,2	K 200 19,20
25	x	1,2	S 500 10,60
25	x	1,2	K 200 20,40
26	x	1,2	S 500 13,00
26	x	1,2	K 200 24,50
27	x	1,2	S 500 16,00
27	x	1,2	K 200 30,00
28	x	1,5	S 500 17,20
28	x	1,5	K 100 31,50
29	x	1,5	S 500 20,50
29	x	1,5	K 100 38,00
30	x	1,5	S 250 17,10
30	x	1,5	K 100 31,50
31	x	1,5	S 250 24,50
31	x	1,5	K 100 44,00
32	x	1,5	S 250 19,80
32	x	1,5	K 100 36,50
33	x	1,5	K 100 49,50
34	x	1,5	S 1000 23,40
34	x	1,5	K 100 42,50
35	x	1,5	S 1000 22,30
35	x	1,5	K 100 41,00
36	x	1,75	S 1000 31,50
36	x	1,75	K 100 56,00
37	x	1,75	S 1000 40,00
37	x	1,75	K 100 72,00
38	x	1,75	S 1000 33,50
38	x	1,75	K 100 59,00
39	x	1,75	K 100 76,00
40	x	1,75	S 1000 36,00
40	x	1,75	K 100 63,00
41	x	1,75	S 1000 49,50
41	x	1,75	K 100 73,00
42	x	1,75	S 1000 41,50

Abmessungen VE Stück €/100/Obf.

42	x	1,75	K 100 73,00
44	x	1,75	S 1000 50,00
44	x	1,75	K 100 73,00
45	x	1,75	S 1000 42,00
45	x	1,75	K 100 73,00
46	x	1,75	S 1000 65,00
46	x	1,75	K 100 88,00
47	x	1,75	S 1000 54,00
47	x	1,75	K 100 78,00
48	x	1,75	S 1000 54,00
48	x	1,75	K 100 79,00
50	x	2	S 100 51,00
52	x	2	S 100 63,00
54	x	2	S 100 69,00
55	x	2	S 100 55,00
56	x	2	S 100 78,00
57	x	2	S 100 74,00
58	x	2	S 100 74,00
60	x	2	S 100 63,00
62	x	2	S 100 76,00
63	x	2	S 100 86,00
65	x	2,5	S 50 89,00
67	x	2,5	S 50 111,00
68	x	2,5	S 50 111,00
70	x	2,5	S 50 95,00
72	x	2,5	S 50 128,00
75	x	2,5	S 50 109,00
77	x	2,5	S 50 132,00
78	x	2,5	S 50 132,00
80	x	2,5	S 50 113,00
82	x	2,5	S 50 137,00
85	x	3	S 50 152,00
87	x	3	S 50 216,00
88	x	3	S 50 190,00
90	x	3	S 50 161,00
92	x	3	S 50 205,00
95	x	3	S 50 176,00
97	x	3	S 50 220,00
98	x	3	S 50 220,00
100	x	3	S 50 180,00
102	x	4	S 1 470,00
105	x	4	S 1 470,00
107	x	4	S 1 560,00
108	x	4	S 1 1370,00
110	x	4	S 1 415,00
112	x	4	S 1 1480,00
115	x	4	S 1 520,00
117	x	4	S 1 1520,00
118	x	4	S 1 1520,00
120	x	4	S 1 445,00
122	x	4	S 1 1610,00
125	x	4	S 1 540,00
127	x	4	S 1 780,00
128	x	4	S 1 1860,00
130	x	4	S 1 590,00
132	x	4	S 1 2000,00
135	x	4	S 1 710,00
137	x	4	S 1 2050,00
138	x	4	S 1 2050,00
140	x	4	S 1 690,00
145	x	4	S 1 740,00
147	x	4	S 1 800,00
148	x	4	S 1 2220,00
150	x	4	S 1 680,00
155	x	4	S 1 850,00
160	x	4	S 1 800,00
165	x	4	S 1 970,00
168	x	4	S 1 1990,00
170	x	4	S 1 1200,00
175	x	4	S 1 1380,00
180	x	4	S 1 1260,00
185	x	4	S 1 1520,00
190	x	4	S 1 1490,00
195	x	4	S 1 1610,00
200	x	4	S 1 1430,00

Abmessungen	VE	Stück	€/100/Obf.
210 x 5	S	1	4600,00
215 x 5	S	1	5300,00
220 x 5	S	1	4450,00
230 x 5	S	1	5200,00
240 x 5	S	1	5300,00
250 x 5	S	1	5600,00
255 x 5	S	1	6900,00
260 x 5	S	1	6000,00
270 x 5	S	1	6300,00
280 x 5	S	1	6600,00
290 x 5	S	1	7700,00
300 x 5	S	1	6900,00
400 x 5	S	1	19400,00

Artikel 82471.000

82471 Sortiment Federstahl DIN 471



Sicherungsringe-Sortiment DIN 471

Inhalt: 12 gängige Abmessungen für Wellen \varnothing 8 - 30, ca. 925 Stück, Regelausführung (Metall-Koffer)

Wunschsortiment auf Anfrage

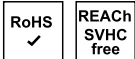

DIN 471 S 1 7700,00

DIN 00471.004

471 Federstahl schwer



Sicherungsringe (Haltringe) für Wellen, schwere Ausführung

Maße \rightarrow TI-91



Nennmaß = für Wellen \varnothing x Dicke

15 x 1,5	S	1000	17,20
16 x 1,5	S	1000	16,60
20 x 1,75	S	1000	28,50
22 x 1,75	S	500	32,50
24 x 1,75	S	500	36,00
25 x 2	S	500	39,50
30 x 2	S	250	51,00
35 x 2,5	S	200	99,00
40 x 2,5	S	50	111,00
45 x 2,5	S	50	136,00
50 x 3	S	50	255,00
55 x 3	S	50	270,00
60 x 3	S	50	310,00
65 x 4	S	50	365,00
70 x 4	S	50	224,00
80 x 4	S	50	315,00

Abmessungen VE Stück €/100/Obf.

DIN 00471.318

471 Federstahl Regel zinklamellenbesch.



Sicherungsringe (Haltringe) für Wellen, Regelausführung

Maße \rightarrow TI-91

Korrosionsschutz \rightarrow TI-230

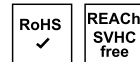

Nennmaß = für Wellen \varnothing x Dicke

10 x 1	S	2000	20,00 flZn
12 x 1	S	1000	26,50 flZn
14 x 1	S	1000	27,50 flZn
15 x 1	S	1000	28,00 flZn
16 x 1	S	1000	29,50 flZn
17 x 1	S	1000	30,50 flZn
20 x 1,2	S	1000	33,50 flZn
25 x 1,2	S	500	36,50 flZn
30 x 1,5	S	250	68,00 flZn
32 x 1,5	S	250	76,00 flZn
35 x 1,5	S	250	79,00 flZn
38 x 1,75	S	100	82,00 flZn
40 x 1,75	S	100	83,00 flZn
42 x 1,75	S	100	96,00 flZn
45 x 1,75	S	100	119,00 flZn
50 x 2	S	100	140,00 flZn
55 x 2	S	100	155,00 flZn
60 x 2	S	100	158,00 flZn
70 x 2,5	S	50	206,00 flZn

DIN 00472.000

472 Federstahl Regel



Sicherungsringe (Haltringe) für Bohrungen, Regelausführung

Maße \rightarrow TI-95

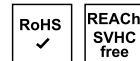

Nennmaß = für Bohrungen \varnothing x Dicke

8 x 0,8	S	2000	2,60
8 x 0,8	K	200	7,20
9 x 0,8	S	2000	2,60
9 x 0,8	K	200	7,20
10 x 1	S	2000	3,30
10 x 1	K	200	8,30
11 x 1	S	2000	3,30
11 x 1	K	200	8,30
12 x 1	S	2000	3,30
12 x 1	K	200	8,30
13 x 1	S	2000	3,75
13 x 1	K	200	9,10
14 x 1	S	2000	3,85
14 x 1	K	200	9,20
15 x 1	S	2000	3,65
15 x 1	K	200	8,80
16 x 1	S	2000	4,10

Abmessungen VE Stück €/100/Obf.

16 x 1	K	200	9,50
17 x 1	S	2000	4,75
17 x 1	K	200	10,70
18 x 1	S	2000	4,70
18 x 1	K	200	10,60
19 x 1	S	2000	4,85
19 x 1	K	200	11,10
20 x 1	S	2000	5,10
20 x 1	K	200	11,30
21 x 1	S	2000	6,00
21 x 1	K	200	12,80
22 x 1	S	2000	5,90
22 x 1	K	200	12,60
23 x 1,2	S	2000	8,80
23 x 1,2	K	200	17,40
24 x 1,2	S	2000	8,20
24 x 1,2	K	200	16,40
25 x 1,2	S	2000	8,50
25 x 1,2	K	200	17,00
26 x 1,2	S	2000	9,10
26 x 1,2	K	200	18,00
27 x 1,2	S	2000	10,30
27 x 1,2	K	200	20,00
28 x 1,2	S	2000	9,50
28 x 1,2	K	200	18,60
29 x 1,2	S	2000	12,50
29 x 1,2	K	200	23,60
30 x 1,2	S	2000	10,70
30 x 1,2	K	200	20,60
31 x 1,2	S	2000	14,00
31 x 1,2	K	200	26,50
32 x 1,2	S	2000	11,30
32 x 1,2	K	200	21,60
33 x 1,2	S	1000	16,90
33 x 1,2	K	100	31,50
34 x 1,5	S	1000	15,90
34 x 1,5	K	100	29,50
35 x 1,5	S	1000	16,90
35 x 1,5	K	100	31,50
36 x 1,5	S	1000	18,60
36 x 1,5	K	100	34,00
37 x 1,5	S	1000	21,70
37 x 1,5	K	100	39,50
38 x 1,5	S	1000	22,10
38 x 1,5	K	100	41,00
39 x 1,5	S	1000	31,50
39 x 1,5	K	100	56,00
40 x 1,75	S	100	29,50
41 x 1,75	S	100	44,00
42 x 1,75	S	100	32,50
44 x 1,75	S	100	44,00
45 x 1,75	S	100	34,00
46 x 1,75	S	100	43,00
47 x 1,75	S	100	36,00
48 x 1,75	S	100	37,00
50 x 2	S	100	39,50
51 x 2	S	100	49,50
52 x 2	S	100	40,00
53 x 2	S	100	57,00
54 x 2	S	100	56,00
55 x 2	S	100	44,50
56 x 2	S	100	57,00
57 x 2	S	100	57,00
58 x 2	S	100	54,00
60 x 2	S	100	51,00
62 x 2	S	100	51,00
62 x 3	S	100	176,00
63 x 2	S	100	68,00
64 x 2	S	100	213,00
65 x 2,5	S	100	79,00
67 x 2,5	S	100	92,00
68 x 2,5	S	100	76,00
70 x 2,5	S	100	89,00
72 x 2,5	S	50	79,00
75 x 2,5	S	50	83,00

Abmessungen	VE	Stück	€/100/Obf.
77 x 2,5	S	50	85,00
78 x 2,5	S	50	103,00
80 x 2,5	S	50	89,00
82 x 2,5	S	50	101,00
85 x 3	S	50	112,00
88 x 3	S	50	141,00
90 x 3	S	50	128,00
92 x 3	S	50	136,00
95 x 3	S	50	141,00
97 x 3	S	50	143,00
98 x 3	S	50	166,00
100 x 3	S	50	147,00
102 x 4	S	1	270,00
105 x 4	S	1	222,00
108 x 4	S	1	265,00
110 x 4	S	1	233,00
112 x 4	S	1	380,00
115 x 4	S	1	275,00
118 x 4	S	1	390,00
120 x 4	S	1	280,00
122 x 4	S	1	290,00
125 x 4	S	1	285,00
128 x 4	S	1	380,00
130 x 4	S	1	315,00
132 x 4	S	1	355,00
135 x 4	S	1	370,00
138 x 4	S	1	530,00
140 x 4	S	1	385,00
142 x 4	S	1	510,00
145 x 4	S	1	425,00
148 x 4	S	1	520,00
150 x 4	S	1	420,00
152 x 4	S	1	590,00
155 x 4	S	1	560,00
160 x 4	S	1	510,00
165 x 4	S	1	620,00
168 x 4	S	1	790,00
170 x 4	S	1	570,00
175 x 4	S	1	790,00
180 x 4	S	1	720,00
185 x 4	S	1	900,00
190 x 4	S	1	840,00
195 x 4	S	1	1000,00
200 x 4	S	1	910,00
205 x 5	S	1	4300,00
210 x 5	S	1	3150,00
215 x 5	S	1	3250,00
220 x 5	S	1	3850,00
225 x 5	S	1	3900,00
230 x 5	S	1	3600,00
240 x 5	S	1	3700,00
245 x 5	S	1	4400,00
250 x 5	S	1	3950,00
255 x 5	S	1	5100,00
260 x 5	S	1	4950,00
265 x 5	S	1	6200,00
270 x 5	S	1	5200,00
275 x 5	S	1	6300,00
280 x 5	S	1	4850,00
285 x 5	S	1	5300,00
290 x 5	S	1	5600,00
295 x 5	S	1	6600,00
300 x 5	S	1	6600,00
310 x 6	S	1	6200,00
320 x 6	S	1	4250,00
340 x 6	S	1	14800,00
360 x 6	S	1	21000,00

Abmessungen	VE	Stück	€/100/Obf.
DIN 00472.318			
472			Federstahl zinklamellenbesch.



Sicherungsringe (Haltinge) für Bohrungen, Regelausführung

Maße → **TI-95** Korrosionsschutz → **TI-230**



Nennmaß = für Bohrungs Ø x Dicke

10 x 1	S	1000	21,80 flZn
12 x 1	S	1000	27,00 flZn
16 x 1	S	1000	30,50 flZn
20 x 1	S	1000	34,00 flZn
25 x 1,2	S	1000	36,50 flZn
30 x 1,2	S	1000	73,00 flZn
35 x 1,5	S	1000	85,00 flZn
40 x 1,75	S	100	97,00 flZn
50 x 2	S	100	146,00 flZn
60 x 2	S	100	170,00 flZn
70 x 2,5	S	50	218,00 flZn

Abmessungen	VE	Stück	€/100/Obf.
DIN 00478.100			
478			10.9

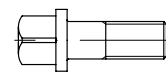

Vierkantschrauben mit Bund

Maße → **TI-30** Werkstoffeigensch. → **TI-232**

Schrauben mit ISO-Schlüsselweiten (M16, M20) auf Anfrage



M 8 x 30	S	50	199,00
M 10 x 30	S	50	249,00
M 10 x 40	S	50	265,00
M 10 x 50	S	50	275,00
M 12 x 40	S	25	415,00
M 16 x 60	S	10	670,00

Abmessungen	VE	Stück	€/100/Obf.
DIN 00479.800			
479			8.8

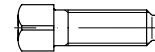

Vierkantschrauben mit Kernansatz

Maße → **TI-30** Werkstoffeigensch. → **TI-232**

Schrauben mit ISO-Schlüsselweiten (M16, M20) auf Anfrage

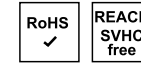

M 6 x 16	S	100	41,00
M 6 x 20	S	100	42,00
M 6 x 25	S	100	44,50
M 8 x 20	S	100	58,00
M 8 x 25	S	100	61,00
M 8 x 30	S	100	66,00
M 8 x 40	S	100	84,00
M 8 x 50	S	50	112,00
M 10 x 25	S	50	97,00
M 10 x 30	S	50	107,00
M 10 x 35	S	50	111,00
M 10 x 40	S	50	120,00
M 10 x 50	S	50	147,00
M 10 x 60	S	50	166,00
M 12 x 35	S	25	164,00
M 12 x 40	S	25	176,00
M 12 x 50	S	25	205,00
M 12 x 60	S	25	226,00
M 12 x 80	S	25	260,00
M 16 x 50	S	25	360,00
M 16 x 60	S	10	455,00
M 16 x 70	S	10	480,00
M 16 x 80	S	10	520,00
M 16 x 100	S	10	560,00
M 16 x 120	S	10	650,00
M 20 x 50	S	10	450,00
M 20 x 60	S	10	485,00
M 20 x 70	S	10	590,00
M 20 x 80	S	10	650,00
M 20 x 90	S	10	700,00
M 20 x 100	S	10	790,00
M 20 x 120	S	10	880,00



- ✓ Große Artikelvielfalt
- ✓ Verlässliche Qualität
- ✓ Hohe Lieferbereitschaft

Abmessungen	VE Stück	€/100/Obf.
DIN	00480.100	

480 10.9

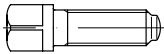

Vierkantschrauben mit Bund und Ansatzkuppe

Maße → **TI-31** Werkstoffeigensch. → **TI-232**

Schrauben mit ISO-Schlüsselweiten (M16, M20) auf Anfrage

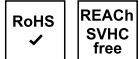

M 10	x	50	S	50	275,00
M 10	x	60	S	50	345,00
M 12	x	50	S	25	420,00
M 16	x	50	S	10	730,00
M 16	x	60	S	10	730,00
M 16	x	70	S	10	740,00
M 16	x	80	S	10	770,00
M 20	x	60	S	10	1410,00

DIN	00508.100
-----	-----------

508 10

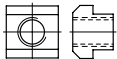

T-Nutensteine

Maße → **TI-70** Werkstoffeigensch. → **TI-233**

T-Nutenschrauben → DIN 787

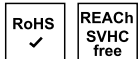

Innengew. M x Nutbreite a

M 4	x	5	S	25	385,00
M 5	x	6	S	25	395,00
M 6	x	8	S	25	430,00
M 6	x	10	S	25	445,00
M 8	x	10	S	25	455,00
M 10	x	12	S	10	470,00
M 12	x	14	S	10	530,00
M 14	x	16	S	10	730,00
M 16	x	18	S	10	880,00
M 20	x	22	S	10	1430,00
M 24	x	28	S	10	2750,00

Abmessungen	VE Stück	€/100/Obf.
DIN	00525.000	

525 Mu 3.6

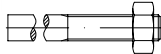

Anschweißenden, Mu = mit Sechskantmuttern

Maße → **TI-31**

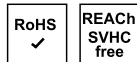

Nenn Ø x Länge // - Gewindelänge

M 6	x	130/35	S	100	123,00
M 8	x	140/40	S	100	148,00
M 10	x	150/45	S	100	232,00
M 12	x	170/55	S	50	265,00
M 14	x	180/60	S	50	490,00
M 16	x	190/65	S	25	500,00
M 20	x	210/75	S	25	720,00
M 22	x	220/80	S	25	1080,00
M 24	x	230/85	S	10	1090,00
M 27	x	250/95	S	10	1550,00
M 30	x	270/105	S	10	1990,00
M 36	x	310/125	S	1	3450,00

DIN	00529.013
-----	-----------

529 Mu Stahl Form C galvanisch verzinkt

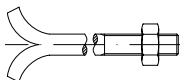

Steinschrauben, C = mit Spaltdolle Mu = mit Sechskantmutter

Maße → **TI-31** Korrosionsschutz → **TI-228**



CM 8	x	80	S	50	177,00 gal Zn
CM 8	x	100	S	50	193,00 gal Zn
CM 8	x	150	S	50	255,00 gal Zn
CM 10	x	100	S	50	245,00 gal Zn
CM 10	x	120	S	25	305,00 gal Zn
CM 10	x	130	S	25	315,00 gal Zn
CM 10	x	150	S	25	325,00 gal Zn
CM 10	x	160	S	25	345,00 gal Zn
CM 10	x	180	S	25	370,00 gal Zn
CM 10	x	200	S	25	380,00 gal Zn
CM 12	x	100	S	25	310,00 gal Zn
CM 12	x	120	S	25	315,00 gal Zn
CM 12	x	130	S	25	330,00 gal Zn
CM 12	x	140	S	25	335,00 gal Zn
CM 12	x	150	S	25	345,00 gal Zn
CM 12	x	160	S	25	365,00 gal Zn
CM 12	x	180	S	25	380,00 gal Zn
CM 12	x	200	S	25	390,00 gal Zn
CM 12	x	220	S	25	415,00 gal Zn
CM 12	x	250	S	25	440,00 gal Zn
CM 12	x	300	S	25	485,00 gal Zn
CM 16	x	100	S	25	510,00 gal Zn
CM 16	x	120	S	25	540,00 gal Zn

Abmessungen	VE Stück	€/100/Obf.
-------------	----------	------------

CM 16	x	150	S	25	590,00 gal Zn
CM 16	x	160	S	25	620,00 gal Zn
CM 16	x	180	S	25	690,00 gal Zn
CM 16	x	200	S	25	730,00 gal Zn
CM 16	x	220	S	10	780,00 gal Zn
CM 16	x	250	S	10	840,00 gal Zn
CM 16	x	275	S	10	890,00 gal Zn
CM 16	x	300	S	10	950,00 gal Zn
CM 16	x	320	S	10	990,00 gal Zn
CM 16	x	350	S	10	1050,00 gal Zn
CM 16	x	400	S	10	1130,00 gal Zn
CM 16	x	450	S	10	1460,00 gal Zn
CM 16	x	500	S	10	1570,00 gal Zn
CM 20	x	150	S	10	830,00 gal Zn
CM 20	x	160	S	10	1120,00 gal Zn
CM 20	x	200	S	10	1230,00 gal Zn
CM 20	x	220	S	10	1260,00 gal Zn
CM 20	x	250	S	10	1320,00 gal Zn
CM 20	x	300	S	10	1430,00 gal Zn
CM 20	x	320	S	10	1470,00 gal Zn
CM 20	x	350	S	10	1530,00 gal Zn
CM 20	x	400	S	10	1640,00 gal Zn
CM 20	x	500	S	1	2300,00 gal Zn
CM 24	x	180	S	5	1890,00 gal Zn
CM 24	x	200	S	5	1990,00 gal Zn
CM 24	x	250	S	1	2260,00 gal Zn
CM 24	x	300	S	1	2600,00 gal Zn
CM 24	x	320	S	1	2700,00 gal Zn
CM 24	x	350	S	1	2900,00 gal Zn
CM 24	x	400	S	1	3250,00 gal Zn
CM 24	x	450	S	1	3450,00 gal Zn
CM 24	x	500	S	1	3700,00 gal Zn
CM 30	x	250	S	1	3250,00 gal Zn
CM 30	x	320	S	1	3700,00 gal Zn
CM 30	x	400	S	1	4400,00 gal Zn
CM 30	x	500	S	1	5100,00 gal Zn

DIN	00546.500
-----	-----------

546 Stahl



Schlitzmuttern

Maße → **TI-72** REACH → **TI-262**

Rostfrei → **S. 470**
Messing → **S. 620**



M 3	S	1000	26,00
M 3	K	100	32,50
M 4	S	1000	27,50
M 4	K	100	34,00
M 5	S	1000	34,50
M 5	K	100	42,50
M 6	S	1000	39,50
M 6	K	100	47,50
M 8	S	500	92,00
M 8	K	100	106,00
M 10	K	100	215,00
M 12	K	50	265,00
M 16	S	50	460,00

Abmessungen	VE Stück	€/100/Obf.
DIN	00546.510	
546	Stahl	galvanisch verzinkt

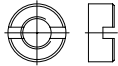

Schlitzmuttern

Maße → **TI-72** REACH → **TI-262**
 Korrosionsschutz → **TI-228**
 Rostfrei → **S. 470**
 Messing → **S. 620**



M 3	S 1000	31,50 gal Zn
M 4	S 1000	39,00 gal Zn
M 5	S 1000	45,00 gal Zn
M 6	S 1000	59,00 gal Zn
M 8	S 500	127,00 gal Zn
M 10	S 500	244,00 gal Zn
M 12	S 250	390,00 gal Zn
M 16	S 250	680,00 gal Zn

DIN	00551.000
551	14 H



Gewindestifte mit Kegelhülse, mit Schlitz

Maße → **TI-19** Normumstellung → **TI-6**
 Werkstoffeigensch. → **TI-232** REACH → **TI-262**
 Rostfrei → **S. 470**
 Messing, Kunststoff → **S. 620**

DIN 551 → wird ersetzt durch ISO 4766 (austauschbar)



M 1,6	x	2	K 100	15,10
M 1,6	x	3	K 100	12,10
M 2	x	3	K 200	10,60
M 2	x	4	K 200	10,70
M 2	x	5	K 200	10,80
M 2	x	6	K 200	11,10
M 2	x	8	K 200	11,20
M 2,5	x	3	K 200	11,20
M 2,5	x	4	K 200	10,80
M 2,5	x	5	K 200	11,10
M 2,5	x	6	K 200	11,20
M 2,5	x	8	K 200	11,30
M 2,5	x	10	K 200	11,80
M 2,5	x	16	K 200	13,40
M 3	x	3	S 1000	7,40
M 3	x	3	K 200	8,40
M 3	x	4	S 1000	4,15
M 3	x	4	K 200	5,00
M 3	x	5	S 1000	3,95
M 3	x	5	K 200	5,30
M 3	x	6	S 1000	4,10
M 3	x	6	K 200	5,50

Abmessungen	VE Stück	€/100/Obf.
M 3	x 8	S 1000 4,15
M 3	x 8	K 200 5,60
M 3	x 10	S 1000 4,15
M 3	x 10	K 200 5,60
M 3	x 12	S 1000 4,60
M 3	x 12	K 200 5,90
M 3	x 16	K 200 6,30
M 3	x 20	K 200 7,20
M 3	x 22	K 200 10,30
M 3	x 25	K 200 11,20
M 3	x 30	K 200 12,90
M 4	x 3	K 200 13,20
M 4	x 4	S 1000 4,15
M 4	x 4	K 200 5,10
M 4	x 5	S 1000 4,30
M 4	x 5	K 200 5,30
M 4	x 6	S 1000 4,30
M 4	x 6	K 200 5,30
M 4	x 8	S 1000 4,30
M 4	x 8	K 200 5,30
M 4	x 10	S 1000 4,60
M 4	x 10	K 200 5,50
M 4	x 12	S 1000 4,85
M 4	x 12	K 200 5,90
M 4	x 16	S 1000 5,40
M 4	x 16	K 200 6,60
M 4	x 20	K 200 7,20
M 4	x 25	K 200 7,90
M 4	x 30	K 200 9,40
M 4	x 40	K 100 42,50
M 5	x 4	K 200 9,40
M 5	x 5	S 1000 5,50
M 5	x 5	K 200 6,50
M 5	x 6	S 1000 4,85
M 5	x 6	K 200 5,90
M 5	x 8	S 1000 5,30
M 5	x 8	K 200 6,20
M 5	x 10	S 1000 5,90
M 5	x 10	K 200 6,80
M 5	x 12	S 1000 6,20
M 5	x 12	K 200 7,30
M 5	x 16	S 1000 7,90
M 5	x 16	K 200 8,80
M 5	x 20	K 200 9,20
M 5	x 25	K 200 9,70
M 5	x 30	K 200 11,30
M 5	x 35	K 100 23,80
M 5	x 40	K 100 23,90
M 6	x 4	K 200 9,40
M 6	x 5	K 200 9,40
M 6	x 6	S 1000 5,90
M 6	x 6	K 200 6,80
M 6	x 8	S 1000 6,30
M 6	x 8	K 200 7,40
M 6	x 10	S 1000 6,70
M 6	x 10	K 200 7,70
M 6	x 12	S 1000 7,20
M 6	x 12	K 200 9,20
M 6	x 16	S 1000 8,20
M 6	x 16	K 200 9,40
M 6	x 18	K 200 9,60
M 6	x 20	S 1000 9,10
M 6	x 20	K 200 9,90
M 6	x 25	S 1000 10,50
M 6	x 25	K 100 11,80
M 6	x 30	K 100 13,80
M 6	x 35	K 100 16,30
M 6	x 40	K 100 56,00
M 6	x 50	K 100 60,00
M 6	x 60	K 100 66,00
M 8	x 5	K 100 23,90
M 8	x 6	K 100 16,70
M 8	x 8	K 100 9,40
M 8	x 10	K 100 10,50
M 8	x 12	S 1000 9,70

Abmessungen	VE Stück	€/100/Obf.
M 8	x 12	K 100 11,80
M 8	x 16	S 1000 10,30
M 8	x 16	K 100 12,40
M 8	x 18	K 100 14,30
M 8	x 20	S 1000 12,60
M 8	x 20	K 100 14,70
M 8	x 25	S 1000 14,10
M 8	x 25	K 100 16,10
M 8	x 30	K 100 19,70
M 8	x 35	K 100 22,30
M 8	x 40	K 100 30,00
M 8	x 45	K 100 46,00
M 8	x 50	K 100 48,00
M 8	x 60	K 100 53,00
M 8	x 70	K 100 57,00
M 8	x 80	K 100 62,00
M 10	x 6	K 100 33,00
M 10	x 8	K 100 33,00
M 10	x 10	K 100 23,20
M 10	x 12	K 100 23,50
M 10	x 16	K 100 25,00
M 10	x 20	K 100 27,50
M 10	x 25	K 100 30,00
M 10	x 30	K 100 32,50
M 10	x 35	K 100 34,50
M 10	x 40	K 100 37,00
M 10	x 45	K 100 67,00
M 10	x 50	K 100 49,50
M 10	x 60	K 100 62,00
M 10	x 70	K 100 84,00
M 10	x 80	K 100 91,00
M 12	x 20	S 100 51,00
M 12	x 25	S 100 54,00
M 12	x 30	S 100 65,00
M 12	x 35	S 100 68,00
M 12	x 40	S 100 73,00
M 12	x 60	S 50 103,00

DIN	00551.010
551	14 H
	galvanisch verzinkt

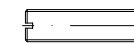

Gewindestifte mit Kegelhülse, mit Schlitz

Maße → **TI-19** Normumstellung → **TI-6**
 Werkstoffeigensch. → **TI-232** REACH → **TI-262**
 Korrosionsschutz → **TI-228**

Rostfrei → **S. 470**
 Messing, Kunststoff → **S. 620**

DIN 551 → wird ersetzt durch ISO 4766 (austauschbar)



M 3	x	3	S 200	11,20 gal Zn
M 3	x	4	S 200	7,80 gal Zn
M 3	x	5	S 200	7,70 gal Zn
M 3	x	6	S 200	7,80 gal Zn
M 3	x	8	S 200	7,80 gal Zn
M 3	x	10	S 200	7,80 gal Zn
M 3	x	12	S 200	8,30 gal Zn
M 3	x	16	S 200	9,10 gal Zn
M 3	x	20	S 200	18,40 gal Zn
M 4	x	4	S 200	7,80 gal Zn
M 4	x	5	S 200	8,00 gal Zn
M 4	x	6	S 200	8,20 gal Zn
M 4	x	8	S 200	8,20 gal Zn

Abmessungen	VE	Stück	€/100/Obf.
M 4 x 10	S	200	8,30 gal Zn
M 4 x 12	S	200	8,60 gal Zn
M 4 x 16	S	200	9,10 gal Zn
M 4 x 20	S	200	9,90 gal Zn
M 4 x 25	S	200	10,70 gal Zn
M 4 x 30	S	200	12,10 gal Zn
M 4 x 40	S	200	46,00 gal Zn
M 5 x 5	S	200	9,20 gal Zn
M 5 x 6	S	200	8,60 gal Zn
M 5 x 8	S	200	9,00 gal Zn
M 5 x 10	S	200	10,00 gal Zn
M 5 x 12	S	200	10,10 gal Zn
M 5 x 16	S	200	11,10 gal Zn
M 5 x 20	S	200	11,90 gal Zn
M 5 x 25	S	200	46,00 gal Zn
M 5 x 30	S	200	14,90 gal Zn
M 5 x 35	S	100	21,80 gal Zn
M 6 x 6	S	200	10,10 gal Zn
M 6 x 8	S	200	10,60 gal Zn
M 6 x 10	S	200	11,20 gal Zn
M 6 x 12	S	200	11,50 gal Zn
M 6 x 16	S	200	11,80 gal Zn
M 6 x 20	S	200	12,60 gal Zn
M 6 x 25	S	100	14,20 gal Zn
M 6 x 30	S	100	16,60 gal Zn
M 6 x 35	S	100	19,00 gal Zn
M 6 x 40	S	100	53,00 gal Zn
M 6 x 50	S	100	55,00 gal Zn
M 8 x 6	S	100	22,10 gal Zn
M 8 x 8	S	100	13,00 gal Zn
M 8 x 10	S	100	14,90 gal Zn
M 8 x 12	S	100	16,30 gal Zn
M 8 x 16	S	100	18,40 gal Zn
M 8 x 20	S	100	19,20 gal Zn
M 8 x 25	S	100	21,60 gal Zn
M 8 x 30	S	100	23,90 gal Zn
M 8 x 35	S	100	27,00 gal Zn
M 8 x 40	S	100	34,50 gal Zn
M 8 x 45	S	100	51,00 gal Zn
M 8 x 50	S	100	53,00 gal Zn
M 8 x 60	S	100	57,00 gal Zn
M 10 x 6	S	100	43,00 gal Zn
M 10 x 10	S	100	28,00 gal Zn
M 10 x 12	S	100	26,50 gal Zn
M 10 x 16	S	100	28,00 gal Zn
M 10 x 20	S	100	30,50 gal Zn
M 10 x 25	S	100	33,00 gal Zn
M 10 x 30	S	100	35,50 gal Zn
M 10 x 35	S	100	33,00 gal Zn
M 10 x 40	S	100	42,00 gal Zn
M 10 x 45	S	100	72,00 gal Zn
M 10 x 50	S	100	54,00 gal Zn
M 10 x 60	S	100	59,00 gal Zn
M 10 x 70	S	100	89,00 gal Zn
M 10 x 80	S	100	97,00 gal Zn
M 12 x 12	S	100	56,00 gal Zn
M 12 x 16	S	100	56,00 gal Zn
M 12 x 20	S	100	56,00 gal Zn
M 12 x 25	S	100	59,00 gal Zn
M 12 x 30	S	100	69,00 gal Zn
M 12 x 35	S	100	74,00 gal Zn
M 12 x 40	S	100	79,00 gal Zn
M 12 x 45	S	100	85,00 gal Zn
M 12 x 50	S	100	97,00 gal Zn
M 12 x 60	S	50	109,00 gal Zn

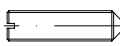
Abmessungen	VE	Stück	€/100/Obf.
DIN 00553.000			
553 14 H			
			
Gewindestifte mit Schlitz und Spitze			
Maße → TI-19 Normumstellung → TI-6			
Werkstoffeigensch. → TI-232 REACH → TI-262			
Rostfrei → S. 471			
Messing → S. 621			
DIN 553 → wird ersetzt durch ISO 7434 (austauschbar)			
RoHS ✓			
M 1,6 x 2	K	100	12,10
M 1,6 x 3	K	100	12,10
M 2 x 3	K	200	10,60
M 2 x 4	K	200	10,70
M 2 x 5	K	200	10,80
M 2 x 6	K	200	11,10
M 2 x 12	K	200	12,40
M 2,5 x 3	K	200	11,20
M 2,5 x 4	K	200	10,80
M 2,5 x 5	K	200	11,10
M 2,5 x 6	K	200	11,20
M 2,5 x 8	K	200	11,30
M 2,5 x 10	K	200	11,80
M 2,5 x 12	K	200	12,60
M 3 x 3	K	200	8,40
M 3 x 4	S	1000	4,15
M 3 x 4	K	200	5,00
M 3 x 5	S	1000	3,95
M 3 x 5	K	200	4,85
M 3 x 6	S	1000	4,10
M 3 x 6	K	200	5,30
M 3 x 8	S	1000	4,15
M 3 x 8	K	200	5,40
M 3 x 10	S	1000	4,15
M 3 x 10	K	200	5,70
M 3 x 12	K	200	5,50
M 3 x 16	K	200	9,10
M 3 x 20	K	200	12,90
M 4 x 4	S	1000	4,15
M 4 x 4	K	200	6,90
M 4 x 5	S	1000	4,30
M 4 x 5	K	200	5,30
M 4 x 6	S	1000	4,30
M 4 x 6	K	200	5,30
M 4 x 8	S	1000	4,30
M 4 x 8	K	200	5,30
M 4 x 10	S	1000	4,60
M 4 x 10	K	200	5,50
M 4 x 12	S	1000	4,85
M 4 x 12	K	200	5,90
M 4 x 16	K	200	6,30
M 4 x 20	K	200	7,20
M 4 x 30	K	200	9,40
M 5 x 5	S	1000	4,85
M 5 x 5	K	200	8,20
M 5 x 6	S	1000	4,85
M 5 x 6	K	200	9,00
M 5 x 8	S	1000	5,30
M 5 x 8	K	200	6,20
M 5 x 10	S	1000	5,90
M 5 x 10	K	200	6,80
M 5 x 12	S	1000	6,20
M 5 x 12	K	200	8,60

Abmessungen	VE	Stück	€/100/Obf.
M 5 x 16	S	1000	7,90
M 5 x 16	K	200	8,80
M 5 x 20	K	200	9,20
M 5 x 25	K	200	9,70
M 6 x 5	K	200	9,40
M 6 x 6	S	1000	8,20
M 6 x 6	K	200	7,20
M 6 x 8	S	1000	6,30
M 6 x 8	K	200	7,40
M 6 x 10	S	1000	6,70
M 6 x 10	K	200	7,70
M 6 x 12	S	1000	7,20
M 6 x 12	K	200	7,90
M 6 x 16	S	1000	8,20
M 6 x 16	K	200	9,60
M 6 x 20	S	1000	9,10
M 6 x 20	K	200	9,90
M 6 x 25	S	1000	10,50
M 6 x 25	K	100	12,50
M 6 x 30	K	100	13,80
M 6 x 40	K	100	39,00
M 8 x 8	K	100	16,40
M 8 x 10	S	1000	8,40
M 8 x 10	K	100	13,50
M 8 x 12	S	1000	9,70
M 8 x 12	K	100	11,80
M 8 x 16	S	1000	10,30
M 8 x 16	K	100	12,50
M 8 x 18	K	100	14,30
M 8 x 20	S	1000	12,60
M 8 x 20	K	100	14,70
M 8 x 25	S	1000	14,10
M 8 x 25	K	100	18,20
M 8 x 30	K	100	19,70
M 8 x 40	K	100	33,00
M 8 x 50	K	100	68,00
M 10 x 10	K	100	23,20
M 10 x 12	K	100	23,50
M 10 x 16	K	100	25,00
M 10 x 20	K	100	27,50
M 10 x 25	K	100	30,00
M 10 x 30	K	100	32,50
M 10 x 35	K	100	34,50
M 10 x 40	K	100	53,00
M 10 x 60	K	100	78,00

Abmessungen	VE	Stück	€/100/Obf.
DIN 00555.504			
555 5 Ww-BSW			

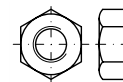

Sechskantmutter mit Whitworth-Regelgewinde

Maße → (TI-62 ~ ISO 4032) REACH → TI-262
Werkstoffeigensch. → TI-233



Gewinde Ø	VE	Stück	€/100/Obf.
WW 5/8	S	100	158,00
WW 3/4	S	50	260,00
WW 1	S	25	450,00
WW 1 1/8	S	25	600,00
WW 1 1/4	S	25	1030,00

Abmessungen	VE Stück	€/100/Obf.
DIN	00557.500	

557 5

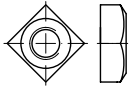

Vierkantmuttern

Maße → **TI-83** Normumstellung → **TI-7**
 Werkstoffeigensch. → **TI-233** REACH → **TI-262**
 Rostfrei → **S. 471**
 Muttern mit ISO-Schlüsselweiten (M10, M12) auf Anfrage



M 5	S 100	6,50
M 6	S 100	9,60
M 8	S 100	14,10
M 10 SW 17	S 100	23,40
M 12 SW 19	S 100	42,00
M 16	S 50	77,00

DIN	00557.510
557	5 galvanisch verzinkt

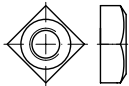

Vierkantmuttern

Maße → **TI-83** Normumstellung → **TI-7**
 Werkstoffeigensch. → **TI-233** REACH → **TI-262**
 Korrosionsschutz → **TI-228**
 Rostfrei → **S. 471**
 Muttern mit ISO-Schlüsselweiten (M10, M12) auf Anfrage



M 5	S 100	6,80 gal Zn
M 6	S 100	10,30 gal Zn
M 8	S 100	15,80 gal Zn
M 10 SW 17	S 100	27,00 gal Zn
M 12 SW 19	S 100	47,00 gal Zn
M 16	S 100	84,00 gal Zn

Abmessungen	VE Stück	€/100/Obf.
DIN	00561.801	

561 22 H (8.8) Ri



Sechskantschrauben mit Zapfen und kleinem Sechskant, Ri = Rille

(Form A)

Maße → **TI-16** Werkstoffeigensch. → **TI-232**
 Schrauben mit ISO-Schlüsselweiten (M12, M16) auf Anfrage



AM 6	x 12	S 100	88,00
AM 6	x 16	S 100	78,00
AM 6	x 20	S 100	82,00
AM 6	x 25	S 100	84,00
AM 6	x 30	S 100	88,00
AM 8	x 16	S 100	101,00
AM 8	x 20	S 100	103,00
AM 8	x 25	S 100	106,00
AM 8	x 30	S 100	111,00
AM 8	x 35	S 100	113,00
AM 8	x 40	S 100	120,00
AM 8	x 45	S 50	170,00
AM 8	x 50	S 50	170,00
AM 10	x 20	S 100	147,00
AM 10	x 25	S 100	157,00
AM 10	x 30	S 50	166,00
AM 10	x 35	S 50	174,00
AM 10	x 40	S 50	183,00
AM 10	x 50	S 50	215,00
AM 10	x 60	S 50	260,00
AM 12	x 25	S 50	250,00
AM 12	x 30	S 50	227,00
AM 12	x 35	S 25	270,00
AM 12	x 40	S 25	285,00
AM 12	x 45	S 25	315,00
AM 12	x 50	S 25	315,00
AM 12	x 60	S 25	340,00
AM 12	x 70	S 25	370,00
AM 12	x 80	S 25	475,00
AM 12	x 100	S 25	660,00
AM 12	x 120	S 25	860,00
AM 16	x 30	S 25	460,00
AM 16	x 35	S 25	470,00
AM 16	x 40	S 25	485,00
AM 16	x 45	S 25	510,00
AM 16	x 50	S 25	530,00
AM 16	x 60	S 10	590,00
AM 16	x 70	S 10	630,00
AM 16	x 80	S 10	660,00
AM 16	x 90	S 10	760,00
AM 16	x 100	S 10	790,00
AM 16	x 120	S 10	890,00
AM 20	x 40	S 10	960,00
AM 20	x 50	S 10	1020,00
AM 20	x 60	S 10	1060,00
AM 20	x 70	S 10	1130,00
AM 20	x 80	S 10	1170,00
AM 20	x 90	S 10	1230,00
AM 20	x 100	S 1	1280,00
AM 20	x 120	S 1	1360,00
AM 20	x 140	S 1	2450,00

Abmessungen	VE Stück	€/100/Obf.
-------------	----------	------------

AM 24	x 50	S 1	2800,00
AM 24	x 60	S 1	1750,00
AM 24	x 70	S 1	1820,00
AM 24	x 80	S 1	1890,00
AM 24	x 90	S 1	1950,00
AM 24	x 100	S 1	2040,00
AM 24	x 120	S 1	2210,00
AM 24	x 140	S 1	4100,00
AM 30	x 60	S 1	3850,00
AM 30	x 70	S 1	4150,00
AM 30	x 80	S 1	4300,00
AM 30	x 90	S 1	4550,00
AM 30	x 100	S 1	4800,00
AM 30	x 120	S 1	5400,00
AM 30	x 140	S 1	5900,00
AM 30	x 160	S 1	6600,00

DIN	00561.811
561	22 H (8.8) galvanisch verzinkt

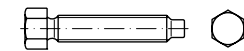

Sechskantschrauben mit Zapfen und kleinem Sechskant, Ri = Rille

(Form A)

Maße → **TI-16** Korrosionsschutz → **TI-228**
 Werkstoffeigensch. → **TI-232**
 Schrauben mit ISO-Schlüsselweiten (M12, M16) auf Anfrage



AM 6	x 12	S 100	90,00 gal Zn
AM 6	x 16	S 100	80,00 gal Zn
AM 6	x 20	S 100	85,00 gal Zn
AM 6	x 25	S 100	88,00 gal Zn
AM 6	x 30	S 100	91,00 gal Zn
AM 8	x 16	S 100	106,00 gal Zn
AM 8	x 20	S 100	109,00 gal Zn
AM 8	x 25	S 100	112,00 gal Zn
AM 8	x 30	S 100	117,00 gal Zn
AM 8	x 35	S 100	121,00 gal Zn
AM 8	x 40	S 100	129,00 gal Zn
AM 8	x 45	S 50	180,00 gal Zn
AM 8	x 50	S 50	182,00 gal Zn
AM 10	x 20	S 100	155,00 gal Zn
AM 10	x 25	S 100	166,00 gal Zn
AM 10	x 30	S 50	177,00 gal Zn
AM 10	x 35	S 50	186,00 gal Zn
AM 10	x 40	S 50	195,00 gal Zn
AM 10	x 50	S 50	230,00 gal Zn
AM 10	x 60	S 50	275,00 gal Zn
AM 12	x 25	S 50	270,00 gal Zn
AM 12	x 30	S 50	245,00 gal Zn
AM 12	x 35	S 25	295,00 gal Zn
AM 12	x 40	S 25	305,00 gal Zn
AM 12	x 45	S 25	340,00 gal Zn
AM 12	x 50	S 25	345,00 gal Zn
AM 12	x 60	S 25	370,00 gal Zn
AM 12	x 70	S 25	400,00 gal Zn
AM 12	x 80	S 25	510,00 gal Zn
AM 12	x 90	S 25	630,00 gal Zn
AM 12	x 100	S 25	700,00 gal Zn
AM 12	x 120	S 25	910,00 gal Zn
AM 16	x 30	S 25	495,00 gal Zn
AM 16	x 35	S 25	510,00 gal Zn

Abmessungen	VE	Stück	€/100/Obf.
AM 16 x 40	S	25	530,00 gal Zn
AM 16 x 45	S	25	550,00 gal Zn
AM 16 x 50	S	25	570,00 gal Zn
AM 16 x 60	S	10	640,00 gal Zn
AM 16 x 70	S	10	690,00 gal Zn
AM 16 x 80	S	10	720,00 gal Zn
AM 16 x 90	S	10	760,00 gal Zn
AM 16 x 100	S	10	860,00 gal Zn
AM 16 x 120	S	10	970,00 gal Zn
AM 20 x 40	S	10	1030,00 gal Zn
AM 20 x 50	S	10	1100,00 gal Zn
AM 20 x 60	S	10	1140,00 gal Zn
AM 20 x 70	S	10	1230,00 gal Zn
AM 20 x 80	S	10	1280,00 gal Zn
AM 20 x 90	S	10	1340,00 gal Zn
AM 20 x 100	S	1	1400,00 gal Zn
AM 20 x 120	S	1	1510,00 gal Zn
AM 20 x 140	S	1	2650,00 gal Zn
AM 24 x 50	S	1	2900,00 gal Zn
AM 24 x 60	S	1	1880,00 gal Zn
AM 24 x 70	S	1	1970,00 gal Zn
AM 24 x 80	S	1	2060,00 gal Zn
AM 24 x 90	S	1	2120,00 gal Zn
AM 24 x 100	S	1	2240,00 gal Zn
AM 24 x 120	S	1	2420,00 gal Zn
AM 24 x 140	S	1	4350,00 gal Zn
AM 30 x 60	S	1	4150,00 gal Zn
AM 30 x 70	S	1	4400,00 gal Zn
AM 30 x 80	S	1	4600,00 gal Zn
AM 30 x 90	S	1	4850,00 gal Zn
AM 30 x 100	S	1	5100,00 gal Zn
AM 30 x 120	S	1	5700,00 gal Zn
AM 30 x 140	S	1	6300,00 gal Zn
AM 30 x 160	S	1	7100,00 gal Zn

DIN 00561.802

561 22 H (8.8)

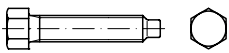

Sechskantschrauben mit Zapfen und kleinem Sechskant, mit Gewindeauslauf

(Form B)

Maße → TI-16 Werkstoffeigensch. → TI-232

Schrauben mit ISO-Schlüsselweiten (M12, M16) auf Anfrage

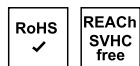

BM 6 x 12	S	100	52,00
BM 6 x 16	S	100	52,00
BM 6 x 20	S	100	56,00
BM 6 x 25	S	100	58,00
BM 6 x 30	S	100	68,00
BM 8 x 16	S	100	74,00
BM 8 x 18	S	100	78,00
BM 8 x 20	S	100	78,00
BM 8 x 25	S	100	84,00
BM 8 x 30	S	100	91,00
BM 8 x 35	S	100	101,00
BM 8 x 40	S	100	106,00
BM 8 x 50	S	50	123,00
BM 8 x 60	S	50	152,00
BM 8 x 70	S	50	230,00
BM 8 x 80	S	50	265,00

Abmessungen	VE	Stück	€/100/Obf.
BM 10 x 20	S	100	135,00
BM 10 x 25	S	100	144,00
BM 10 x 30	S	50	152,00
BM 10 x 35	S	50	161,00
BM 10 x 40	S	50	174,00
BM 10 x 45	S	50	205,00
BM 10 x 50	S	50	205,00
BM 10 x 60	S	50	215,00
BM 10 x 70	S	50	230,00
BM 10 x 80	S	50	265,00
BM 10 x 100	S	50	510,00
BM 12 x 25	S	50	137,00
BM 12 x 30	S	50	143,00
BM 12 x 35	S	25	151,00
BM 12 x 40	S	25	160,00
BM 12 x 45	S	25	183,00
BM 12 x 50	S	25	183,00
BM 12 x 60	S	25	195,00
BM 12 x 70	S	25	221,00
BM 12 x 80	S	25	290,00
BM 12 x 90	S	25	365,00
BM 12 x 100	S	25	415,00
BM 12 x 120	S	25	560,00
BM 16 x 30	S	25	265,00
BM 16 x 35	S	25	270,00
BM 16 x 40	S	25	285,00
BM 16 x 45	S	25	290,00
BM 16 x 50	S	25	305,00
BM 16 x 60	S	10	360,00
BM 16 x 70	S	10	380,00
BM 16 x 80	S	10	395,00
BM 16 x 90	S	10	440,00
BM 16 x 100	S	10	470,00
BM 16 x 120	S	10	540,00
BM 20 x 50	S	10	1020,00
BM 20 x 60	S	10	1060,00
BM 20 x 70	S	10	1130,00
BM 20 x 80	S	10	1170,00
BM 20 x 90	S	10	1230,00
BM 20 x 100	S	1	1280,00
BM 20 x 120	S	1	1360,00
BM 20 x 140	S	1	2450,00
BM 24 x 50	S	1	1830,00
BM 24 x 60	S	1	1150,00
BM 24 x 70	S	1	1200,00
BM 24 x 80	S	1	1250,00
BM 24 x 90	S	1	1300,00
BM 24 x 100	S	1	1350,00
BM 24 x 120	S	1	1440,00
BM 24 x 140	S	1	2650,00
BM 30 x 60	S	1	2500,00
BM 30 x 70	S	1	2650,00
BM 30 x 80	S	1	2800,00
BM 30 x 90	S	1	2950,00
BM 30 x 100	S	1	3150,00
BM 30 x 120	S	1	3450,00
BM 30 x 140	S	1	3900,00
BM 30 x 160	S	1	4250,00

Abmessungen	VE	Stück	€/100/Obf.
DIN	00561.812		
561	22 H (8.8)		
	galvanisch verzinkt		

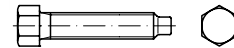

Sechskantschrauben mit Zapfen und kleinem Sechskant, mit Gewindeauslauf

(Form B)

Maße → TI-16 Korrosionsschutz → TI-228

Werkstoffeigensch. → TI-232

Schrauben mit ISO-Schlüsselweiten (M12, M16) auf Anfrage

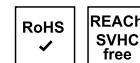

BM 6 x 12	S	100	55,00 gal Zn
BM 6 x 16	S	100	56,00 gal Zn
BM 6 x 20	S	100	59,00 gal Zn
BM 6 x 25	S	100	61,00 gal Zn
BM 6 x 30	S	100	73,00 gal Zn
BM 8 x 16	S	100	79,00 gal Zn
BM 8 x 18	S	100	83,00 gal Zn
BM 8 x 20	S	100	83,00 gal Zn
BM 8 x 25	S	100	90,00 gal Zn
BM 8 x 30	S	100	97,00 gal Zn
BM 8 x 35	S	100	108,00 gal Zn
BM 8 x 40	S	100	115,00 gal Zn
BM 8 x 50	S	50	134,00 gal Zn
BM 8 x 60	S	50	164,00 gal Zn
BM 8 x 70	S	50	242,00 gal Zn
BM 8 x 80	S	50	275,00 gal Zn
BM 10 x 20	S	100	143,00 gal Zn
BM 10 x 25	S	100	155,00 gal Zn
BM 10 x 30	S	50	164,00 gal Zn
BM 10 x 35	S	50	172,00 gal Zn
BM 10 x 40	S	50	188,00 gal Zn
BM 10 x 45	S	50	218,00 gal Zn
BM 10 x 50	S	50	222,00 gal Zn
BM 10 x 60	S	50	233,00 gal Zn
BM 10 x 70	S	50	255,00 gal Zn
BM 10 x 80	S	50	300,00 gal Zn
BM 10 x 90	S	50	475,00 gal Zn
BM 10 x 100	S	50	540,00 gal Zn
BM 12 x 25	S	50	155,00 gal Zn
BM 12 x 30	S	50	164,00 gal Zn
BM 12 x 35	S	25	170,00 gal Zn
BM 12 x 40	S	25	182,00 gal Zn
BM 12 x 45	S	25	206,00 gal Zn
BM 12 x 50	S	25	210,00 gal Zn
BM 12 x 60	S	25	224,00 gal Zn
BM 12 x 70	S	25	255,00 gal Zn
BM 12 x 80	S	25	330,00 gal Zn
BM 12 x 90	S	25	410,00 gal Zn
BM 12 x 100	S	25	455,00 gal Zn
BM 12 x 120	S	25	600,00 gal Zn
BM 16 x 30	S	25	295,00 gal Zn
BM 16 x 35	S	25	305,00 gal Zn
BM 16 x 40	S	25	325,00 gal Zn
BM 16 x 45	S	25	330,00 gal Zn
BM 16 x 50	S	25	355,00 gal Zn
BM 16 x 60	S	10	410,00 gal Zn
BM 16 x 70	S	10	430,00 gal Zn
BM 16 x 80	S	10	460,00 gal Zn
BM 16 x 90	S	10	510,00 gal Zn
BM 16 x 100	S	10	540,00 gal Zn
BM 16 x 120	S	10	620,00 gal Zn



- ✓ Große Artikelvielfalt
- ✓ Verlässliche Qualität
- ✓ Hohe Lieferbereitschaft

Abmessungen	VE	Stück	€/100/Obf.
BM 16 x 160	S	10	1030,00 gal Zn
BM 20 x 50	S	10	1090,00 gal Zn
BM 20 x 60	S	10	1140,00 gal Zn
BM 20 x 70	S	10	1220,00 gal Zn
BM 20 x 80	S	10	1280,00 gal Zn
BM 20 x 90	S	10	1340,00 gal Zn
BM 20 x 100	S	1	1400,00 gal Zn
BM 20 x 120	S	1	1510,00 gal Zn
BM 20 x 140	S	1	2650,00 gal Zn
BM 24 x 50	S	1	1950,00 gal Zn
BM 24 x 60	S	1	1340,00 gal Zn
BM 24 x 70	S	1	1370,00 gal Zn
BM 24 x 80	S	1	1410,00 gal Zn
BM 24 x 90	S	1	1480,00 gal Zn
BM 24 x 100	S	1	1550,00 gal Zn
BM 24 x 120	S	1	1670,00 gal Zn
BM 24 x 140	S	1	2900,00 gal Zn
BM 30 x 60	S	1	2750,00 gal Zn
BM 30 x 70	S	1	2900,00 gal Zn
BM 30 x 80	S	1	3100,00 gal Zn
BM 30 x 90	S	1	3300,00 gal Zn
BM 30 x 100	S	1	3550,00 gal Zn
BM 30 x 140	S	1	4300,00 gal Zn
BM 30 x 160	S	1	4750,00 gal Zn

DIN 00562.400

562 04

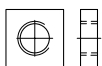

Vierkantmuttern, niedrige Form, Produktklasse B

Maße → TI-83 REACH → TI-262

Werkstoffeigensch. → TI-233

Rostfrei → S. 471



M 2	S	100	36,50
M 3	S	1000	2,85
M 3	K	100	6,30
M 4	S	1000	3,35
M 4	K	100	6,80
M 5	S	100	7,90
M 6	S	100	8,90
M 8	S	100	14,30
M 10 SW 17	S	100	22,30

Abmessungen	VE	Stück	€/100/Obf.
DIN	00562.410		
562	04	galvanisch verzinkt	



Vierkantmuttern, niedrige Form, Produktklasse B

Maße → TI-83 Korrosionsschutz → TI-228

Werkstoffeigensch. → TI-233 REACH → TI-262

Rostfrei → S. 471



M 2,5	S	1000	10,30 gal Zn
M 3	S	1000	2,90 gal Zn
M 4	S	1000	3,45 gal Zn
M 5	S	1000	8,30 gal Zn
M 6	S	1000	9,50 gal Zn
M 8	S	500	15,40 gal Zn
M 10 SW 17	S	100	28,00 gal Zn

DIN 00564.801

564 22 H (8.8) Ri

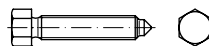

Sechskantschrauben mit Ansatzspitze und kleinem Sechskant, Ri = Rille

(Form A)

Maße → TI-16 Werkstoffeigensch. → TI-232

Schrauben mit ISO-Schlüsselweiten (M12, M16) auf Anfrage



AM 6 x 12	S	100	88,00
AM 6 x 20	S	100	82,00
AM 8 x 20	S	100	103,00
AM 8 x 25	S	100	106,00
AM 8 x 30	S	100	111,00
AM 8 x 40	S	100	120,00
AM 10 x 20	S	100	166,00
AM 10 x 30	S	50	189,00
AM 10 x 35	S	50	195,00
AM 10 x 50	S	50	242,00
AM 12 x 25	S	50	250,00
AM 12 x 50	S	25	315,00
AM 12 x 60	S	25	340,00
AM 12 x 80	S	25	475,00
AM 16 x 50	S	25	770,00
AM 16 x 60	S	10	880,00
AM 16 x 80	S	10	940,00
AM 20 x 100	S	1	2410,00

Abmessungen	VE	Stück	€/100/Obf.
DIN	00564.802		
564	22 H (8.8)		



Sechskantschrauben mit Auslauf, Ansatzspitze und kleinem Sechskant

(Form B)

Maße → TI-16

Werkstoffeigensch. → TI-232

Schrauben mit ISO-Schlüsselweiten (M12, M16) auf Anfrage



BM 6 x 12	S	100	52,00
BM 6 x 16	S	100	52,00
BM 6 x 20	S	100	56,00
BM 6 x 25	S	100	58,00
BM 6 x 30	S	100	68,00
BM 8 x 16	S	100	74,00
BM 8 x 20	S	100	78,00
BM 8 x 25	S	100	84,00
BM 8 x 30	S	100	91,00
BM 8 x 35	S	100	101,00
BM 10 x 20	S	100	151,00
BM 10 x 25	S	100	161,00
BM 10 x 30	S	50	167,00
BM 10 x 35	S	50	177,00
BM 10 x 40	S	50	193,00
BM 10 x 50	S	50	227,00
BM 10 x 60	S	50	239,00
BM 12 x 25	S	50	137,00
BM 12 x 30	S	50	143,00
BM 12 x 35	S	25	151,00
BM 12 x 40	S	25	160,00
BM 12 x 45	S	25	183,00
BM 12 x 50	S	25	183,00
BM 12 x 60	S	25	195,00
BM 12 x 70	S	25	221,00
BM 12 x 80	S	25	290,00
BM 16 x 40	S	25	475,00
BM 16 x 50	S	25	510,00
BM 16 x 60	S	10	570,00
BM 16 x 70	S	10	590,00
BM 16 x 80	S	10	620,00
BM 16 x 90	S	10	660,00
BM 16 x 100	S	10	740,00
BM 20 x 60	S	10	2060,00
BM 20 x 70	S	10	2160,00
BM 20 x 80	S	10	2240,00
BM 20 x 90	S	10	2330,00
BM 20 x 100	S	1	2410,00
BM 24 x 60	S	1	2260,00
BM 24 x 100	S	1	2600,00

Abmessungen VE Stück €/100/Obf.

DIN 00571.000

571

Stahl

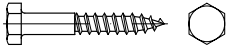

Sechskant-Holzschrauben

Maße → TI-51

Rostfrei → S. 471

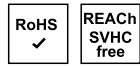

Abm.	VE	Stück	€/100/Obf.
6 x 35	S	200	10,90
6 x 40	S	200	11,80
6 x 50	S	200	14,00
6 x 60	S	200	15,70
8 x 30	S	200	16,70
8 x 40	S	200	18,40
8 x 50	S	200	20,10
8 x 60	S	200	22,40
8 x 70	S	200	26,00
10 x 50	S	100	33,50
10 x 60	S	100	35,00
10 x 70	S	100	40,50
10 x 80	S	100	42,50
10 x 100	S	100	56,00
10 x 120	S	50	69,00

DIN 00571.010

571

Stahl galvanisch verzinkt

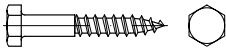

Sechskant-Holzschrauben

Maße → TI-51

Korrosionsschutz → TI-228

Rostfrei → S. 471

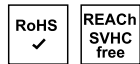

Abm.	VE	Stück	€/100/Obf.
5 x 20	S	500	13,00 gal Zn
5 x 20	K	100	16,70 gal Zn
5 x 25	S	500	12,60 gal Zn
5 x 25	K	100	16,30 gal Zn
5 x 30	S	500	12,60 gal Zn
5 x 30	K	100	16,30 gal Zn
5 x 35	S	200	13,20 gal Zn
5 x 40	S	200	13,80 gal Zn
5 x 45	S	200	15,70 gal Zn
5 x 50	S	200	16,20 gal Zn
5 x 60	S	200	18,40 gal Zn
6 x 20	S	500	13,50 gal Zn
6 x 20	K	100	17,20 gal Zn
6 x 25	S	500	13,10 gal Zn
6 x 25	K	100	16,80 gal Zn
6 x 30	S	500	13,20 gal Zn
6 x 30	K	100	17,00 gal Zn
6 x 35	S	200	14,00 gal Zn
6 x 40	S	200	14,60 gal Zn
6 x 45	S	200	16,40 gal Zn
6 x 50	S	200	17,00 gal Zn

Abmessungen VE Stück €/100/Obf.

6 x 55 S 200 19,10 gal Zn

6 x 60	S	200	19,30 gal Zn
6 x 65	S	200	23,60 gal Zn
6 x 70	S	200	23,90 gal Zn
6 x 75	S	200	24,20 gal Zn
6 x 80	S	200	27,00 gal Zn
6 x 90	S	100	31,50 gal Zn
6 x 100	S	100	36,00 gal Zn
6 x 110	S	100	57,00 gal Zn
6 x 120	S	100	58,00 gal Zn
6 x 140	S	100	99,00 gal Zn
8 x 25	S	200	22,40 gal Zn
8 x 30	S	200	22,60 gal Zn
8 x 35	S	200	23,00 gal Zn
8 x 40	S	200	23,50 gal Zn
8 x 45	S	200	25,50 gal Zn
8 x 50	S	200	26,00 gal Zn
8 x 55	S	200	29,00 gal Zn
8 x 60	S	200	29,50 gal Zn
8 x 65	S	200	33,00 gal Zn
8 x 70	S	200	33,50 gal Zn
8 x 75	S	200	36,50 gal Zn
8 x 80	S	200	37,00 gal Zn
8 x 90	S	100	46,50 gal Zn
8 x 100	S	100	49,50 gal Zn
8 x 110	S	100	65,00 gal Zn
8 x 120	S	100	66,00 gal Zn
8 x 130	S	100	87,00 gal Zn
8 x 140	S	50	87,00 gal Zn
8 x 150	S	50	158,00 gal Zn
8 x 160	S	50	160,00 gal Zn
8 x 180	S	50	183,00 gal Zn
8 x 200	S	50	211,00 gal Zn
10 x 30	S	200	47,50 gal Zn
10 x 35	S	100	48,50 gal Zn
10 x 40	S	100	44,50 gal Zn
10 x 45	S	100	43,00 gal Zn
10 x 50	S	100	44,00 gal Zn
10 x 55	S	100	46,00 gal Zn
10 x 60	S	100	46,50 gal Zn
10 x 65	S	100	53,00 gal Zn
10 x 70	S	100	54,00 gal Zn
10 x 75	S	100	57,00 gal Zn
10 x 80	S	100	57,00 gal Zn
10 x 90	S	100	70,00 gal Zn
10 x 100	S	100	74,00 gal Zn
10 x 110	S	50	88,00 gal Zn
10 x 120	S	50	89,00 gal Zn
10 x 130	S	50	107,00 gal Zn
10 x 140	S	50	109,00 gal Zn
10 x 150	S	50	186,00 gal Zn
10 x 160	S	50	187,00 gal Zn
10 x 180	S	50	209,00 gal Zn
10 x 200	S	50	241,00 gal Zn
10 x 220	S	25	350,00 gal Zn
10 x 240	S	25	375,00 gal Zn
10 x 260	S	25	410,00 gal Zn
10 x 280	S	25	465,00 gal Zn
10 x 300	S	25	510,00 gal Zn
12 x 40	S	100	82,00 gal Zn
12 x 45	S	100	84,00 gal Zn
12 x 50	S	100	87,00 gal Zn
12 x 60	S	100	89,00 gal Zn
12 x 65	S	50	93,00 gal Zn
12 x 70	S	50	93,00 gal Zn
12 x 75	S	50	95,00 gal Zn
12 x 80	S	50	96,00 gal Zn
12 x 90	S	50	111,00 gal Zn
12 x 100	S	50	118,00 gal Zn
12 x 110	S	50	143,00 gal Zn
12 x 120	S	50	146,00 gal Zn
12 x 130	S	50	160,00 gal Zn
12 x 140	S	50	161,00 gal Zn
12 x 150	S	50	213,00 gal Zn
12 x 160	S	25	215,00 gal Zn

Abmessungen VE Stück €/100/Obf.

12 x 180 S 25 239,00 gal Zn

12 x 200	S	25	275,00 gal Zn
12 x 220	S	25	390,00 gal Zn
12 x 240	S	25	415,00 gal Zn
12 x 260	S	25	455,00 gal Zn
12 x 280	S	25	500,00 gal Zn
12 x 300	S	25	550,00 gal Zn
12 x 320	S	25	1130,00 gal Zn
12 x 340	S	25	1230,00 gal Zn
12 x 360	S	25	1330,00 gal Zn
12 x 380	S	25	1430,00 gal Zn
16 x 60	S	50	183,00 gal Zn
16 x 70	S	25	193,00 gal Zn
16 x 80	S	25	199,00 gal Zn
16 x 90	S	25	220,00 gal Zn
16 x 100	S	25	226,00 gal Zn
16 x 110	S	25	260,00 gal Zn
16 x 120	S	25	265,00 gal Zn
16 x 130	S	25	315,00 gal Zn
16 x 140	S	25	320,00 gal Zn
16 x 150	S	25	365,00 gal Zn
16 x 160	S	25	370,00 gal Zn
16 x 180	S	25	405,00 gal Zn
16 x 200	S	25	440,00 gal Zn
16 x 220	S	25	475,00 gal Zn
16 x 240	S	25	490,00 gal Zn
16 x 260	S	25	540,00 gal Zn
16 x 280	S	25	590,00 gal Zn
16 x 300	S	25	620,00 gal Zn
20 x 80	S	25	460,00 gal Zn
20 x 90	S	25	485,00 gal Zn
20 x 100	S	25	510,00 gal Zn
20 x 110	S	25	530,00 gal Zn
20 x 120	S	25	550,00 gal Zn
20 x 130	S	25	590,00 gal Zn
20 x 140	S	25	620,00 gal Zn
20 x 150	S	25	650,00 gal Zn
20 x 160	S	25	670,00 gal Zn
20 x 180	S	10	700,00 gal Zn
20 x 200	S	10	780,00 gal Zn

DIN 00571.020

571

Stahl feuerverzinkt

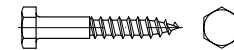

Sechskant-Holzschrauben

Maße → TI-51

Korrosionsschutz → TI-231

Rostfrei → S. 471

Kombi-Dichtungen für Ø 7 mm
→ Artikel-Nr. 88005 → S. 4000000

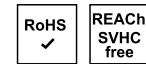

Abm.	VE	Stück	€/100/Obf.
6 x 35	S	200	15,60 tZn
6 x 40	S	200	17,30 tZn
6 x 50	S	200	20,30 tZn
7 x 60	S	200	57,00 tZn
7 x 70	S	200	60,00 tZn
7 x 80	S	200	63,00 tZn
7 x 90	S	200	67,00 tZn
7 x 100	S	100	72,00 tZn
7 x 110	S	100	75,00 tZn
7 x 120	S	100	81,00 tZn
7 x 130	S	100	87,00 tZn
8 x 40	S	200	28,00 tZn
8 x 50	S	200	31,50 tZn

Abmessungen	VE	Stück	€/100/Obf.
8 x 60	S	200	35,50 tZn
8 x 65	S	200	40,00 tZn
8 x 70	S	200	40,50 tZn
8 x 80	S	200	45,00 tZn
8 x 100	S	100	60,00 tZn
8 x 140	S	50	87,00 tZn
10 x 40	S	100	49,00 tZn
10 x 50	S	100	54,00 tZn
10 x 60	S	100	58,00 tZn
10 x 70	S	100	66,00 tZn
10 x 80	S	100	71,00 tZn
10 x 90	S	100	78,00 tZn
10 x 100	S	100	89,00 tZn
10 x 120	S	50	108,00 tZn
10 x 140	S	50	131,00 tZn
10 x 150	S	50	211,00 tZn
12 x 70	S	50	110,00 tZn
12 x 80	S	50	115,00 tZn
12 x 100	S	50	142,00 tZn
12 x 120	S	50	172,00 tZn
12 x 140	S	50	193,00 tZn
12 x 150	S	50	245,00 tZn
12 x 180	S	25	350,00 tZn

DIN 00580.300

580 C 15 E

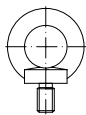

Ringschrauben

Achtung! Benutzer-Informationen beachten.
→ DIN 580 oder Technische Informationen

Maße → TI-32 Produktinformation → TI-142

Rostfrei → S. 472



M 6	S	25	385,00
M 8	S	25	385,00
M 10	S	25	460,00
M 12	S	10	620,00
M 14	S	10	890,00
M 16	S	10	840,00
M 18	S	1	1210,00
M 20	S	1	1140,00
M 22	S	1	2230,00
M 24	S	1	2230,00
M 27	S	1	3700,00
M 30	S	1	3950,00
M 33	S	1	5400,00
M 36	S	1	5900,00
M 39	S	1	9600,00
M 42	S	1	10100,00
M 45	S	1	14400,00
M 48	S	1	15100,00
M 52	S	1	16500,00
M 56	S	1	27500,00
M 64	S	1	40200,00

Abmessungen VE Stück €/100/Obf.
DIN 00580.310
580 C 15 E
galvanisch verzinkt

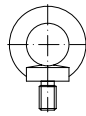

Ringschrauben

Achtung! Benutzer-Informationen beachten.
→ DIN 580 oder Technische Informationen

Maße → TI-32 Produktinformation → TI-142

Korrosionsschutz → TI-228

Rostfrei → S. 472

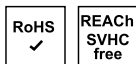

M 6	S	25	395,00 gal Zn
M 8	S	25	410,00 gal Zn
M 10	S	25	510,00 gal Zn
M 12	S	10	680,00 gal Zn
M 14	S	10	960,00 gal Zn
M 16	S	10	950,00 gal Zn
M 18	S	1	1380,00 gal Zn
M 20	S	1	1310,00 gal Zn
M 22	S	1	2400,00 gal Zn
M 24	S	1	2550,00 gal Zn
M 27	S	1	4300,00 gal Zn
M 30	S	1	4600,00 gal Zn
M 33	S	1	6600,00 gal Zn
M 36	S	1	6900,00 gal Zn
M 42	S	1	11200,00 gal Zn
M 48	S	1	16200,00 gal Zn
M 56	S	1	29000,00 gal Zn

DIN 00580.320

580 C 15 E
feuerverzinkt

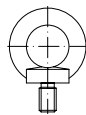

Ringschrauben

Gewinde mit Untermaß (6az + tZn = U)

Achtung! Benutzer-Informationen beachten.
→ DIN 580 oder Technische Informationen

Maße → TI-32 Produktinformation → TI-142

Korrosionsschutz → TI-231

Rostfrei → S. 472

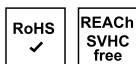

M 8	S	25	710,00 tZn
M 10	S	25	880,00 tZn
M 12	S	10	1190,00 tZn
M 16	S	10	1660,00 tZn
M 20	S	1	2290,00 tZn
M 24	S	1	4400,00 tZn

Abmessungen VE Stück €/100/Obf.
DIN 00582.300
582 C 15 E



Ringmuttern

Achtung! Benutzer-Informationen beachten.
→ DIN 582 oder Technische Informationen

Maße → TI-77

Produktinformation → TI-142

Rostfrei → S. 473

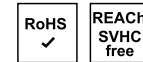

M 6	S	25	390,00
M 8	S	25	390,00
M 10	S	25	475,00
M 12	S	10	620,00
M 14	S	10	840,00
M 16	S	10	820,00
M 18	S	1	1150,00
M 20	S	1	1110,00
M 22	S	1	2050,00
M 24	S	1	2350,00
M 27	S	1	2700,00
M 30	S	1	4150,00
M 33	S	1	5900,00
M 36	S	1	5900,00
M 42	S	1	12800,00
M 48	S	1	17200,00
M 56	S	1	29100,00

DIN 00582.310

582 C 15 E
galvanisch verzinkt



Ringmuttern

Achtung! Benutzer-Informationen beachten.
→ DIN 582 oder Technische Informationen

Maße → TI-77

Produktinformation → TI-142

Korrosionsschutz → TI-228

Rostfrei → S. 473

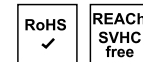

M 6	S	25	415,00 gal Zn
M 8	S	25	415,00 gal Zn
M 10	S	25	510,00 gal Zn
M 12	S	10	680,00 gal Zn
M 14	S	10	890,00 gal Zn
M 16	S	10	890,00 gal Zn
M 18	S	1	1250,00 gal Zn
M 20	S	1	1240,00 gal Zn
M 24	S	1	2650,00 gal Zn
M 27	S	1	3200,00 gal Zn
M 30	S	1	4600,00 gal Zn
M 33	S	1	6400,00 gal Zn

Abmessungen	VE	Stück	€/100/Obf.
M 36	S	1	6800,00 gal Zn
M 42	S	1	13700,00 gal Zn
M 48	S	1	18100,00 gal Zn

DIN	00582.320
582	C 15 E feuerverzinkt



Ringmuttern

Gewindetoleranz 6H

Achtung! Benutzer-Informationen beachten.
→ **DIN 582** oder **Technische Informationen**

Maße → [TI-77](#) Produktinformation → [TI-142](#)
Korrosionsschutz → [TI-231](#)

Rostfrei → [S. 473](#)

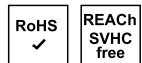

M 8	S	25	720,00 tZn
M 10	S	25	880,00 tZn
M 12	S	10	1190,00 tZn
M 16	S	10	1550,00 tZn
M 20	S	1	2440,00 tZn
M 24	S	1	4550,00 tZn

DIN	00601.400
601	Mu Stahl

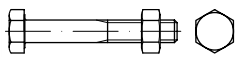

Sechskantschrauben, Mu = mit Sechskantmutter

Maße → [TI-15](#) REACH → [TI-262](#)
Normumstellung → [TI-6](#)

DIN 601 → wird ersetzt durch ISO 4016
→ ISO-Abmessungen M 10, 12, 14, 22 auf Anfrage



M 5	x	16	S	500	15,00
M 5	x	20	S	500	15,00
M 5	x	25	S	500	17,30
M 5	x	30	S	500	17,30
M 5	x	40	S	200	19,30
M 5	x	50	S	200	23,60
M 5	x	80	S	200	94,00
M 6	x	16	S	500	7,10
M 6	x	20	S	500	7,10
M 6	x	25	S	500	7,30
M 6	x	30	S	500	8,10
M 6	x	35	S	200	13,20
M 6	x	40	S	200	13,80
M 6	x	45	S	200	19,50
M 6	x	50	S	200	19,50
M 6	x	55	S	200	26,00
M 6	x	60	S	200	26,00
M 6	x	65	S	200	36,00

Abmessungen	VE	Stück	€/100/Obf.
M 6	x	70	S 200 32,50
M 6	x	75	S 200 39,00
M 6	x	80	S 200 36,00
M 6	x	90	S 100 48,00
M 6	x	100	S 100 48,00
M 8	x	16	S 200 11,50
M 8	x	20	S 200 11,50
M 8	x	25	S 200 12,20
M 8	x	30	S 200 12,70
M 8	x	35	S 200 14,30
M 8	x	40	S 200 14,70
M 8	x	45	S 200 15,90
M 8	x	50	S 200 16,90
M 8	x	55	S 200 27,00
M 8	x	60	S 200 27,00
M 8	x	65	S 200 41,00
M 8	x	70	S 200 40,50
M 8	x	75	S 200 57,00
M 8	x	80	S 200 55,00
M 8	x	90	S 100 67,00
M 8	x	100	S 100 72,00
M 8	x	110	S 100 78,00
M 8	x	120	S 100 78,00
M 8	x	130	S 100 105,00
M 8	x	140	S 50 111,00
M 8	x	150	S 50 126,00
M 10	x	16	S 200 46,50
M 10	x	20	S 200 21,10
M 10	x	25	S 200 21,20
M 10	x	30	S 200 22,00
M 10	x	35	S 100 23,00
M 10	x	40	S 100 24,20
M 10	x	45	S 100 26,00
M 10	x	50	S 100 26,50
M 10	x	55	S 100 31,50
M 10	x	60	S 100 31,50
M 10	x	65	S 100 36,00
M 10	x	70	S 100 36,00
M 10	x	75	S 100 59,00
M 10	x	80	S 100 56,00
M 10	x	90	S 100 82,00
M 10	x	100	S 100 88,00
M 10	x	110	S 50 101,00
M 10	x	120	S 50 143,00
M 10	x	130	S 50 170,00
M 10	x	140	S 50 170,00
M 10	x	150	S 50 177,00
M 10	x	160	S 50 221,00
M 10	x	170	S 50 249,00
M 10	x	190	S 50 275,00
M 10	x	200	S 50 275,00
M 10	x	220	S 25 340,00
M 10	x	240	S 25 360,00
M 12	x	20	S 100 30,50
M 12	x	25	S 100 30,00
M 12	x	30	S 100 31,50
M 12	x	35	S 100 33,00
M 12	x	40	S 100 34,50
M 12	x	45	S 100 36,50
M 12	x	50	S 100 38,00
M 12	x	55	S 100 41,50
M 12	x	60	S 100 43,50
M 12	x	65	S 50 49,00
M 12	x	70	S 50 47,50
M 12	x	75	S 50 80,00
M 12	x	80	S 50 76,00
M 12	x	85	S 50 113,00
M 12	x	90	S 50 103,00
M 12	x	100	S 50 113,00
M 12	x	110	S 50 152,00
M 12	x	120	S 50 160,00
M 12	x	130	S 50 232,00
M 12	x	140	S 50 255,00
M 12	x	150	S 50 250,00
M 12	x	160	S 50 244,00

Abmessungen	VE	Stück	€/100/Obf.
M 12	x	170	S 50 285,00
M 12	x	180	S 50 285,00
M 12	x	190	S 50 315,00
M 12	x	200	S 50 315,00
M 12	x	220	S 25 350,00
M 12	x	240	S 25 380,00
M 12	x	260	S 25 395,00
M 12	x	280	S 25 430,00
M 12	x	300	S 25 455,00
M 12	x	320	S 25 475,00
M 12	x	340	S 25 485,00
M 12	x	360	S 25 510,00
M 12	x	380	S 25 530,00
M 12	x	400	S 25 560,00
M 12	x	420	S 25 610,00
M 12	x	440	S 25 640,00
M 14	x	30	S 100 123,00
M 14	x	35	S 100 126,00
M 14	x	40	S 100 126,00
M 14	x	45	S 50 130,00
M 14	x	50	S 50 142,00
M 14	x	60	S 50 147,00
M 14	x	65	S 50 192,00
M 14	x	70	S 50 157,00
M 14	x	80	S 50 175,00
M 14	x	100	S 50 200,00
M 14	x	140	S 25 740,00
M 16	x	30	S 50 62,00
M 16	x	35	S 50 64,00
M 16	x	40	S 50 65,00
M 16	x	45	S 50 82,00
M 16	x	50	S 50 72,00
M 16	x	55	S 50 73,00
M 16	x	60	S 50 75,00
M 16	x	65	S 25 78,00
M 16	x	70	S 25 115,00
M 16	x	75	S 25 88,00
M 16	x	80	S 25 92,00
M 16	x	85	S 25 107,00
M 16	x	90	S 25 102,00
M 16	x	95	S 25 113,00
M 16	x	100	S 25 107,00
M 16	x	110	S 25 113,00
M 16	x	120	S 25 137,00
M 16	x	130	S 25 142,00
M 16	x	140	S 25 152,00
M 16	x	150	S 25 223,00
M 16	x	160	S 25 430,00
M 16	x	170	S 25 455,00
M 16	x	180	S 25 455,00
M 16	x	190	S 25 470,00
M 16	x	200	S 25 470,00
M 16	x	220	S 25 550,00
M 16	x	240	S 25 590,00
M 16	x	250	S 25 770,00
M 16	x	260	S 25 620,00
M 16	x	280	S 25 660,00
M 16	x	300	S 25 690,00
M 16	x	320	S 10 730,00
M 16	x	340	S 10 770,00
M 16	x	360	S 10 810,00
M 16	x	380	S 10 820,00
M 16	x	400	S 10 840,00
M 16	x	420	S 10 870,00
M 16	x	440	S 10 880,00
M 16	x	460	S 10 910,00
M 16	x	480	S 10 950,00
M 16	x	500	S 10 990,00
M 16	x	520	S 10 1640,00
M 16	x	540	S 10 1690,00
M 16	x	560	S 10 1750,00
M 16	x	580	S 10 1820,00
M 18	x	50	S 50 470,00
M 18	x	60	S 25 480,00
M 18	x	70	S 25 480,00

Abmessungen	VE	Stück	€/100/Obf.	Abmessungen	VE	Stück	€/100/Obf.	Abmessungen	VE	Stück	€/100/Obf.
M 18 x 80	S	25	495,00	M 24 x 140	S	10	370,00	M 33 x 160	S	1	2700,00
M 18 x 100	S	25	580,00	M 24 x 150	S	10	540,00	M 33 x 180	S	1	2900,00
M 18 x 110	S	25	600,00	M 24 x 160	S	10	1060,00	M 33 x 200	S	1	3050,00
M 20 x 30	S	25	305,00	M 24 x 170	S	10	1100,00	M 33 x 300	S	1	4450,00
M 20 x 35	S	25	305,00	M 24 x 180	S	10	1100,00	M 36 x 80	S	1	2160,00
M 20 x 40	S	25	130,00	M 24 x 200	S	10	1120,00	M 36 x 90	S	1	2160,00
M 20 x 45	S	25	137,00	M 24 x 220	S	10	1130,00	M 36 x 100	S	1	2160,00
M 20 x 50	S	25	137,00	M 24 x 240	S	10	1230,00	M 36 x 110	S	1	2330,00
M 20 x 55	S	25	138,00	M 24 x 250	S	10	1310,00	M 36 x 120	S	1	2330,00
M 20 x 60	S	25	138,00	M 24 x 260	S	10	1310,00	M 36 x 130	S	1	2480,00
M 20 x 65	S	25	142,00	M 24 x 280	S	1	1400,00	M 36 x 140	S	1	2480,00
M 20 x 70	S	25	142,00	M 24 x 300	S	1	1490,00	M 36 x 150	S	1	2600,00
M 20 x 75	S	25	147,00	M 24 x 320	S	1	1640,00	M 36 x 160	S	1	3150,00
M 20 x 80	S	25	152,00	M 24 x 340	S	1	1730,00	M 36 x 180	S	1	3350,00
M 20 x 85	S	25	176,00	M 24 x 360	S	1	1820,00	M 36 x 200	S	1	3550,00
M 20 x 90	S	25	161,00	M 24 x 380	S	1	1920,00	M 36 x 220	S	1	4100,00
M 20 x 95	S	25	186,00	M 24 x 400	S	1	2010,00	M 36 x 240	S	1	4350,00
M 20 x 100	S	25	176,00	M 24 x 440	S	1	2240,00	M 36 x 280	S	1	4850,00
M 20 x 110	S	25	186,00	M 24 x 480	S	1	2420,00	M 39 x 140	S	1	3400,00
M 20 x 120	S	25	197,00	M 24 x 500	S	1	2550,00	M 39 x 180	S	1	3750,00
M 20 x 130	S	25	223,00	M 24 x 520	S	1	3850,00	M 42 x 120	S	1	3550,00
M 20 x 140	S	25	233,00	M 24 x 540	S	1	4000,00	M 45 x 140	S	1	4800,00
M 20 x 150	S	25	375,00	M 24 x 560	S	1	4150,00	M 48 x 200	S	1	6800,00
M 20 x 160	S	10	690,00	M 24 x 580	S	1	4300,00				
M 20 x 170	S	10	690,00	M 24 x 600	S	1	4400,00				
M 20 x 180	S	10	720,00	M 27 x 60	S	10	760,00				
M 20 x 190	S	10	730,00	M 27 x 70	S	10	760,00				
M 20 x 200	S	10	760,00	M 27 x 75	S	10	760,00				
M 20 x 220	S	10	780,00	M 27 x 80	S	10	760,00				
M 20 x 240	S	10	790,00	M 27 x 85	S	10	860,00				
M 20 x 250	S	10	840,00	M 27 x 90	S	10	800,00				
M 20 x 260	S	10	840,00	M 27 x 100	S	10	860,00				
M 20 x 280	S	10	880,00	M 27 x 110	S	10	910,00				
M 20 x 300	S	10	900,00	M 27 x 120	S	10	910,00				
M 20 x 320	S	10	920,00	M 27 x 130	S	10	990,00				
M 20 x 340	S	10	950,00	M 27 x 140	S	10	990,00				
M 20 x 360	S	10	1000,00	M 27 x 150	S	10	1050,00				
M 20 x 380	S	10	1040,00	M 27 x 160	S	10	1330,00				
M 20 x 400	S	10	1110,00	M 27 x 180	S	10	1430,00				
M 20 x 420	S	10	1260,00	M 27 x 200	S	1	1500,00				
M 20 x 440	S	10	1320,00	M 27 x 220	S	1	2160,00				
M 20 x 460	S	10	1370,00	M 27 x 240	S	1	2380,00				
M 20 x 480	S	1	1430,00	M 27 x 260	S	1	2600,00				
M 20 x 500	S	1	1480,00	M 27 x 280	S	1	2850,00				
M 20 x 520	S	1	2470,00	M 27 x 300	S	1	3100,00				
M 20 x 540	S	1	2600,00	M 30 x 60	S	10	1030,00				
M 20 x 600	S	1	2850,00	M 30 x 65	S	10	1030,00				
M 22 x 50	S	25	610,00	M 30 x 70	S	10	1030,00				
M 22 x 60	S	25	620,00	M 30 x 80	S	10	1030,00				
M 22 x 70	S	25	620,00	M 30 x 90	S	10	1070,00				
M 22 x 80	S	25	640,00	M 30 x 100	S	10	1090,00				
M 22 x 90	S	25	650,00	M 30 x 110	S	10	1190,00				
M 22 x 100	S	10	730,00	M 30 x 120	S	10	1190,00				
M 22 x 110	S	10	890,00	M 30 x 130	S	1	1280,00				
M 22 x 120	S	10	920,00	M 30 x 140	S	1	1280,00				
M 22 x 130	S	10	1080,00	M 30 x 150	S	1	1320,00				
M 22 x 140	S	10	1110,00	M 30 x 160	S	1	1610,00				
M 22 x 150	S	10	1130,00	M 30 x 180	S	1	1670,00				
M 22 x 300	S	1	2550,00	M 30 x 200	S	1	1830,00				
M 22 x 340	S	1	2750,00	M 30 x 220	S	1	2700,00				
M 22 x 400	S	1	3150,00	M 30 x 240	S	1	3100,00				
M 24 x 40	S	25	560,00	M 30 x 260	S	1	3500,00				
M 24 x 50	S	25	236,00	M 30 x 280	S	1	3850,00				
M 24 x 55	S	25	236,00	M 30 x 300	S	1	4200,00				
M 24 x 60	S	25	236,00	M 30 x 320	S	1	4600,00				
M 24 x 65	S	25	260,00	M 30 x 340	S	1	4950,00				
M 24 x 70	S	25	234,00	M 30 x 360	S	1	5400,00				
M 24 x 75	S	25	250,00	M 30 x 400	S	1	6200,00				
M 24 x 80	S	25	240,00	M 33 x 80	S	1	1760,00				
M 24 x 85	S	10	275,00	M 33 x 100	S	1	1880,00				
M 24 x 90	S	10	260,00	M 33 x 110	S	1	1990,00				
M 24 x 100	S	10	275,00	M 33 x 120	S	1	1990,00				
M 24 x 110	S	10	300,00	M 33 x 130	S	1	2120,00				
M 24 x 120	S	10	310,00	M 33 x 140	S	1	2120,00				
M 24 x 130	S	10	340,00	M 33 x 150	S	1	2200,00				

DIN	00601.410
601	Mu Stahl galvanisch verzinkt

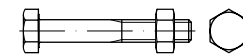

Sechskantschrauben, Mu = mit Sechskantmutter

Maße → TI-15 Normumstellung → TI-6
 Korrosionsschutz → TI-228 REACH → TI-262

DIN 601 → wird ersetzt durch ISO 4016
 → ISO-Abmessungen M 10, 12, 14, 22 auf Anfrage
 Bauschrauben → Artikel 89601



M 5 x 16	S	500	16,50 gal Zn
M 5 x 16	K	100	20,20 gal Zn
M 5 x 20	S	500	17,00 gal Zn
M 5 x 20	K	100	20,70 gal Zn
M 5 x 25	S	500	19,50 gal Zn
M 5 x 25	K	100	23,20 gal Zn
M 5 x 30	S	500	19,70 gal Zn
M 5 x 30	K	100	23,50 gal Zn
M 5 x 35	S	200	21,60 gal Zn
M 5 x 40	S	200	22,30 gal Zn
M 5 x 45	S	200	26,00 gal Zn
M 5 x 50	S	200	27,50 gal Zn
M 5 x 55	S	200	31,50 gal Zn
M 5 x 60	S	200	32,50 gal Zn
M 5 x 70	S	200	41,50 gal Zn
M 6 x 10	S	500	10,20 gal Zn
M 6 x 10	K	100	16,10 gal Zn
M 6 x 12	S	500	10,20 gal Zn
M 6 x 12	K	100	16,10 gal Zn
M 6 x 16	S	500	8,80 gal Zn
M 6 x 16	K	100	14,80 gal Zn
M 6 x 20	S	500	8,90 gal Zn
M 6 x 20	K	100	15,00 gal Zn
M 6 x 25	S	500	9,50 gal Zn
M 6 x 25	K	100	15,50 gal Zn
M 6 x 30	S	500	10,50 gal Zn
M 6 x 30	K	100	16,50 gal Zn
M 6 x 35	S	200	15,90 gal Zn

Abmessungen	VE	Stück	€/100/Obf.	Abmessungen	VE	Stück	€/100/Obf.	Abmessungen	VE	Stück	€/100/Obf.
M 6 x 40	S	200	16,70 gal Zn	M 12 x 80	S	50	100,00 gal Zn	M 24 x 130	S	10	495,00 gal Zn
M 6 x 45	S	200	23,20 gal Zn	M 12 x 85	S	50	143,00 gal Zn	M 24 x 140	S	10	540,00 gal Zn
M 6 x 50	S	200	23,60 gal Zn	M 12 x 90	S	50	134,00 gal Zn	M 24 x 150	S	10	710,00 gal Zn
M 6 x 55	S	200	30,00 gal Zn	M 12 x 110	S	50	187,00 gal Zn	M 24 x 160	S	10	1330,00 gal Zn
M 6 x 60	S	200	30,50 gal Zn	M 12 x 130	S	50	275,00 gal Zn	M 24 x 170	S	10	1360,00 gal Zn
M 6 x 65	S	200	41,00 gal Zn	M 12 x 250	S	25	470,00 gal Zn	M 24 x 180	S	10	1380,00 gal Zn
M 6 x 70	S	200	38,00 gal Zn	M 14 x 30	S	100	147,00 gal Zn	M 24 x 200	S	10	1390,00 gal Zn
M 6 x 75	S	200	44,50 gal Zn	M 14 x 35	S	100	152,00 gal Zn	M 27 x 60	S	10	920,00 gal Zn
M 6 x 80	S	200	42,00 gal Zn	M 14 x 40	S	100	155,00 gal Zn	M 27 x 65	S	10	930,00 gal Zn
M 6 x 90	S	100	55,00 gal Zn	M 14 x 45	S	50	160,00 gal Zn	M 27 x 70	S	10	930,00 gal Zn
M 6 x 100	S	100	56,00 gal Zn	M 14 x 50	S	50	174,00 gal Zn	M 27 x 75	S	10	940,00 gal Zn
M 8 x 16	S	200	15,30 gal Zn	M 14 x 55	S	50	176,00 gal Zn	M 27 x 80	S	10	950,00 gal Zn
M 8 x 20	S	200	15,70 gal Zn	M 14 x 60	S	50	183,00 gal Zn	M 27 x 85	S	10	1040,00 gal Zn
M 8 x 25	S	200	16,70 gal Zn	M 14 x 65	S	50	229,00 gal Zn	M 27 x 90	S	10	1000,00 gal Zn
M 8 x 30	S	200	17,70 gal Zn	M 14 x 70	S	50	197,00 gal Zn	M 27 x 100	S	10	1060,00 gal Zn
M 8 x 35	S	200	19,70 gal Zn	M 14 x 80	S	50	217,00 gal Zn	M 27 x 110	S	10	1130,00 gal Zn
M 8 x 40	S	200	20,60 gal Zn	M 14 x 90	S	50	234,00 gal Zn	M 27 x 120	S	10	1140,00 gal Zn
M 8 x 45	S	200	22,30 gal Zn	M 14 x 100	S	50	250,00 gal Zn	M 27 x 130	S	10	1230,00 gal Zn
M 8 x 50	S	200	23,80 gal Zn	M 14 x 110	S	50	270,00 gal Zn	M 27 x 140	S	10	1250,00 gal Zn
M 8 x 55	S	200	34,50 gal Zn	M 14 x 120	S	50	315,00 gal Zn	M 27 x 150	S	10	1320,00 gal Zn
M 8 x 60	S	200	35,00 gal Zn	M 14 x 130	S	50	840,00 gal Zn	M 27 x 200	S	1	1830,00 gal Zn
M 8 x 65	S	200	51,00 gal Zn	M 14 x 180	S	25	950,00 gal Zn	M 27 x 240	S	1	2800,00 gal Zn
M 8 x 70	S	200	51,00 gal Zn	M 14 x 200	S	25	1050,00 gal Zn	M 27 x 260	S	1	3050,00 gal Zn
M 8 x 75	S	200	68,00 gal Zn	M 16 x 30	S	50	89,00 gal Zn	M 30 x 60	S	10	1240,00 gal Zn
M 8 x 80	S	200	66,00 gal Zn	M 16 x 35	S	50	92,00 gal Zn	M 30 x 70	S	10	1250,00 gal Zn
M 8 x 90	S	100	80,00 gal Zn	M 16 x 40	S	50	94,00 gal Zn	M 30 x 80	S	10	1270,00 gal Zn
M 8 x 100	S	100	86,00 gal Zn	M 16 x 45	S	50	98,00 gal Zn	M 30 x 90	S	10	1320,00 gal Zn
M 8 x 110	S	100	93,00 gal Zn	M 16 x 50	S	50	105,00 gal Zn	M 30 x 100	S	10	1360,00 gal Zn
M 8 x 120	S	100	94,00 gal Zn	M 16 x 55	S	50	107,00 gal Zn	M 30 x 110	S	10	1480,00 gal Zn
M 8 x 130	S	100	123,00 gal Zn	M 16 x 60	S	50	112,00 gal Zn	M 30 x 120	S	10	1490,00 gal Zn
M 8 x 140	S	50	132,00 gal Zn	M 16 x 65	S	25	116,00 gal Zn	M 30 x 130	S	1	1590,00 gal Zn
M 8 x 150	S	50	148,00 gal Zn	M 16 x 70	S	25	123,00 gal Zn	M 30 x 140	S	1	1610,00 gal Zn
M 8 x 160	S	50	186,00 gal Zn	M 16 x 75	S	25	131,00 gal Zn	M 30 x 150	S	1	1670,00 gal Zn
M 10 x 16	S	200	56,00 gal Zn	M 16 x 80	S	25	136,00 gal Zn	M 30 x 160	S	1	1970,00 gal Zn
M 10 x 20	S	200	29,50 gal Zn	M 16 x 85	S	25	154,00 gal Zn	M 30 x 180	S	1	2070,00 gal Zn
M 10 x 25	S	200	30,00 gal Zn	M 16 x 90	S	25	151,00 gal Zn	M 30 x 200	S	1	2260,00 gal Zn
M 10 x 30	S	200	31,50 gal Zn	M 16 x 95	S	25	164,00 gal Zn	M 30 x 260	S	1	4050,00 gal Zn
M 10 x 35	S	100	33,00 gal Zn	M 16 x 250	S	25	770,00 gal Zn	M 30 x 360	S	1	6100,00 gal Zn
M 10 x 40	S	100	35,50 gal Zn	M 20 x 30	S	25	355,00 gal Zn	M 33 x 110	S	1	2350,00 gal Zn
M 10 x 45	S	100	37,50 gal Zn	M 20 x 35	S	25	355,00 gal Zn	M 33 x 120	S	1	2370,00 gal Zn
M 10 x 50	S	100	39,00 gal Zn	M 20 x 40	S	25	182,00 gal Zn	M 33 x 130	S	1	2550,00 gal Zn
M 10 x 55	S	100	44,50 gal Zn	M 20 x 45	S	25	190,00 gal Zn	M 33 x 150	S	1	2650,00 gal Zn
M 10 x 60	S	100	45,00 gal Zn	M 20 x 50	S	25	193,00 gal Zn	M 33 x 200	S	1	3600,00 gal Zn
M 10 x 65	S	100	51,00 gal Zn	M 20 x 55	S	25	195,00 gal Zn	M 36 x 100	S	1	2600,00 gal Zn
M 10 x 70	S	100	52,00 gal Zn	M 20 x 60	S	25	200,00 gal Zn	M 36 x 110	S	1	2800,00 gal Zn
M 10 x 75	S	100	75,00 gal Zn	M 20 x 65	S	25	205,00 gal Zn	M 36 x 120	S	1	2800,00 gal Zn
M 10 x 80	S	100	73,00 gal Zn	M 20 x 70	S	25	209,00 gal Zn	M 36 x 140	S	1	3000,00 gal Zn
M 10 x 90	S	100	104,00 gal Zn	M 20 x 75	S	25	217,00 gal Zn	M 36 x 160	S	1	3700,00 gal Zn
M 10 x 100	S	100	111,00 gal Zn	M 20 x 80	S	25	224,00 gal Zn	M 36 x 180	S	1	3950,00 gal Zn
M 10 x 110	S	50	126,00 gal Zn	M 20 x 85	S	25	255,00 gal Zn				
M 10 x 120	S	50	170,00 gal Zn	M 20 x 90	S	25	240,00 gal Zn				
M 10 x 130	S	50	197,00 gal Zn	M 20 x 95	S	25	270,00 gal Zn				
M 10 x 140	S	50	200,00 gal Zn	M 20 x 100	S	25	265,00 gal Zn				
M 10 x 150	S	50	211,00 gal Zn	M 20 x 110	S	25	280,00 gal Zn				
M 10 x 160	S	50	255,00 gal Zn	M 20 x 120	S	25	295,00 gal Zn				
M 10 x 170	S	50	285,00 gal Zn	M 20 x 130	S	25	330,00 gal Zn				
M 10 x 180	S	50	285,00 gal Zn	M 20 x 140	S	25	345,00 gal Zn				
M 10 x 200	S	50	315,00 gal Zn	M 20 x 150	S	25	490,00 gal Zn				
M 10 x 220	S	25	380,00 gal Zn	M 20 x 170	S	10	920,00 gal Zn				
M 10 x 240	S	25	410,00 gal Zn	M 20 x 190	S	10	940,00 gal Zn				
M 10 x 260	S	25	445,00 gal Zn	M 20 x 250	S	10	1050,00 gal Zn				
M 10 x 280	S	25	530,00 gal Zn	M 22 x 90	S	25	770,00 gal Zn				
M 10 x 300	S	25	530,00 gal Zn	M 24 x 45	S	25	660,00 gal Zn				
M 12 x 20	S	100	42,00 gal Zn	M 24 x 50	S	25	330,00 gal Zn				
M 12 x 25	S	100	43,00 gal Zn	M 24 x 55	S	25	330,00 gal Zn				
M 12 x 30	S	100	45,00 gal Zn	M 24 x 60	S	25	335,00 gal Zn				
M 12 x 35	S	100	47,50 gal Zn	M 24 x 65	S	25	360,00 gal Zn				
M 12 x 40	S	100	50,00 gal Zn	M 24 x 70	S	25	345,00 gal Zn				
M 12 x 45	S	100	53,00 gal Zn	M 24 x 75	S	25	360,00 gal Zn				
M 12 x 50	S	100	56,00 gal Zn	M 24 x 80	S	25	355,00 gal Zn				
M 12 x 55	S	100	60,00 gal Zn	M 24 x 85	S	10	395,00 gal Zn				
M 12 x 60	S	100	63,00 gal Zn	M 24 x 90	S	10	380,00 gal Zn				
M 12 x 65	S	50	68,00 gal Zn	M 24 x 100	S	10	410,00 gal Zn				
M 12 x 70	S	50	69,00 gal Zn	M 24 x 110	S	10	440,00 gal Zn				
M 12 x 75	S	50	103,00 gal Zn	M 24 x 120	S	10	460,00 gal Zn				



- ✓ Große Artikelvielfalt
- ✓ Verlässliche Qualität
- ✓ Hohe Lieferbereitschaft

Abmessungen	VE Stück	€/100/Obf.
DIN	00601.420	
601	Mu Stahl	
	feuerverzinkt	

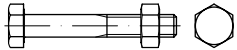

**Sechskantschrauben,
Mu = mit Sechskantmutter**

Achtung! Infoeinblender beachten.

Maße → **TI-15** Normumstellung → **TI-6**
 Korrosionsschutz → **TI-231** REACH → **TI-262**

DIN 601 → wird ersetzt durch ISO 4016
 → ISO-Abmessungen M 10, 12, 14, 22 auf Anfrage



M 10	x	20	S	200	36,00 tzn
M 10	x	25	S	200	37,00 tzn
M 10	x	30	S	200	39,00 tzn
M 10	x	35	S	100	41,50 tzn
M 10	x	40	S	100	43,50 tzn
M 10	x	50	S	100	49,00 tzn
M 10	x	60	S	100	56,00 tzn
M 12	x	25	S	100	53,00 tzn
M 12	x	30	S	100	56,00 tzn
M 12	x	35	S	100	59,00 tzn
M 12	x	40	S	100	62,00 tzn
M 12	x	45	S	100	66,00 tzn
M 12	x	50	S	100	69,00 tzn
M 12	x	55	S	100	75,00 tzn
M 12	x	60	S	100	78,00 tzn
M 12	x	70	S	50	86,00 tzn
M 12	x	80	S	50	118,00 tzn
M 12	x	90	S	50	151,00 tzn
M 12	x	100	S	50	164,00 tzn
M 12	x	110	S	50	209,00 tzn
M 12	x	120	S	50	220,00 tzn
M 12	x	130	S	50	295,00 tzn
M 12	x	140	S	50	320,00 tzn
M 12	x	150	S	50	320,00 tzn
M 16	x	30	S	50	107,00 tzn
M 16	x	35	S	50	113,00 tzn
M 16	x	40	S	50	116,00 tzn
M 16	x	45	S	50	120,00 tzn
M 16	x	50	S	50	130,00 tzn
M 16	x	55	S	50	135,00 tzn
M 16	x	60	S	50	141,00 tzn
M 16	x	65	S	25	146,00 tzn
M 16	x	70	S	25	154,00 tzn
M 16	x	75	S	25	166,00 tzn
M 16	x	80	S	25	170,00 tzn
M 16	x	90	S	25	186,00 tzn
M 16	x	100	S	25	200,00 tzn
M 16	x	110	S	25	211,00 tzn
M 16	x	120	S	25	241,00 tzn
M 16	x	130	S	25	255,00 tzn
M 16	x	140	S	25	270,00 tzn
M 16	x	150	S	25	350,00 tzn
M 16	x	160	S	25	570,00 tzn
M 16	x	170	S	25	580,00 tzn
M 16	x	180	S	25	600,00 tzn
M 16	x	200	S	25	630,00 tzn
M 20	x	40	S	25	220,00 tzn
M 20	x	45	S	25	230,00 tzn
M 20	x	50	S	25	234,00 tzn
M 20	x	55	S	25	241,00 tzn
M 20	x	60	S	25	245,00 tzn
M 20	x	65	S	25	255,00 tzn

Abmessungen	VE Stück	€/100/Obf.
M 20	x 70	S 25 260,00 tzn
M 20	x 75	S 25 275,00 tzn
M 20	x 80	S 25 285,00 tzn
M 20	x 90	S 25 305,00 tzn
M 20	x 100	S 25 330,00 tzn
M 20	x 110	S 25 350,00 tzn
M 20	x 120	S 25 370,00 tzn
M 20	x 130	S 25 410,00 tzn
M 20	x 140	S 25 430,00 tzn
M 20	x 150	S 25 580,00 tzn
M 20	x 160	S 10 900,00 tzn
M 20	x 180	S 10 950,00 tzn
M 20	x 200	S 10 1020,00 tzn
M 20	x 220	S 10 1060,00 tzn
M 20	x 240	S 10 1090,00 tzn
M 20	x 260	S 10 1160,00 tzn
M 20	x 280	S 10 1220,00 tzn
M 20	x 300	S 10 1260,00 tzn
M 24	x 80	S 10 445,00 tzn
M 24	x 90	S 10 480,00 tzn
M 24	x 100	S 10 510,00 tzn
M 24	x 120	S 10 570,00 tzn
M 24	x 150	S 10 1020,00 tzn
M 24	x 180	S 10 1980,00 tzn
M 24	x 200	S 10 2010,00 tzn

Abmessungen	VE Stück	€/100/Obf.
M 6	x 16	S 500 8,60
M 6	x 20	S 500 8,40
M 6	x 25	S 500 8,60
M 6	x 30	S 500 8,90
M 6	x 35	S 200 9,80
M 6	x 40	S 200 10,60
M 6	x 45	S 200 10,90
M 6	x 50	S 200 11,40
M 6	x 55	S 200 13,80
M 6	x 60	S 200 12,60
M 6	x 65	S 200 23,90
M 6	x 70	S 200 22,20
M 6	x 80	S 200 35,00
M 6	x 90	S 100 37,50
M 6	x 100	S 100 45,00
M 6	x 110	S 100 59,00
M 6	x 120	S 100 59,00
M 6	x 130	S 100 98,00
M 8	x 16	S 200 13,50
M 8	x 20	S 200 13,50
M 8	x 25	S 200 13,60
M 8	x 30	S 200 14,00
M 8	x 35	S 200 15,10
M 8	x 40	S 200 15,80
M 8	x 45	S 200 17,50
M 8	x 50	S 200 16,90
M 8	x 55	S 200 19,50
M 8	x 60	S 200 19,50
M 8	x 65	S 200 24,20
M 8	x 70	S 200 22,10
M 8	x 75	S 200 27,50
M 8	x 80	S 200 25,50
M 8	x 90	S 100 38,50
M 8	x 100	S 100 46,00
M 8	x 110	S 100 57,00
M 8	x 120	S 100 70,00
M 8	x 130	S 100 73,00
M 8	x 140	S 100 73,00
M 8	x 150	S 100 142,00
M 8	x 160	S 100 142,00
M 8	x 170	S 50 163,00
M 8	x 180	S 50 163,00
M 10	x 20	S 200 22,90
M 10	x 25	S 200 22,90
M 10	x 30	S 200 23,80
M 10	x 35	S 100 25,50
M 10	x 40	S 100 27,50
M 10	x 45	S 100 32,00
M 10	x 50	S 100 27,50
M 10	x 55	S 100 32,50
M 10	x 60	S 100 34,00
M 10	x 65	S 100 36,00
M 10	x 70	S 100 34,50
M 10	x 80	S 100 38,50
M 10	x 90	S 100 58,00
M 10	x 100	S 100 67,00
M 10	x 110	S 50 77,00
M 10	x 120	S 50 95,00
M 10	x 130	S 50 105,00
M 10	x 140	S 50 110,00
M 10	x 150	S 50 142,00
M 10	x 160	S 50 167,00
M 10	x 170	S 50 217,00
M 10	x 180	S 50 222,00
M 10	x 190	S 50 239,00
M 10	x 200	S 50 239,00
M 10	x 220	S 25 315,00
M 10	x 240	S 25 345,00
M 10	x 260	S 25 375,00
M 10	x 280	S 25 400,00
M 10	x 300	S 25 430,00
M 12	x 25	S 100 84,00
M 12	x 30	S 100 101,00
M 12	x 35	S 100 101,00
M 12	x 40	S 100 87,00

Achtung!

Feuerverzinkte Schrauben-/Mutter-Garnituren dürfen nur miteinander verschraubt werden, wenn Gewindenspiel / -Toleranzen dieser Garnituren entsprechend ISO 10684 passend aufeinander abgestimmt sind.

Die Verwendung mit anderen Schrauben-/Mutter-Ausführungen kann zu Verschraubungsproblemen und/oder zum Versagen der Verbindung führen.

DIN	00603.400
603	Mu Stahl

**Flachrundschraben
mit Vierkantansatz,
Mu = mit Sechskantmutter**

Maße → **TI-32** REACH → **TI-262**
 Rostfrei → **S. 473**
 Messing → **S. 621**



M 5	x	16	S	500	21,30
M 5	x	20	S	500	21,40
M 5	x	25	S	500	21,50
M 5	x	30	S	500	22,50
M 5	x	35	S	200	23,00
M 5	x	40	S	200	26,00
M 5	x	45	S	200	27,00
M 5	x	50	S	200	28,00
M 5	x	60	S	200	33,00
M 5	x	70	S	200	47,50

Abmessungen	VE	Stück	€/100/Obf.
M 12 x 45	S	100	92,00
M 12 x 50	S	100	95,00
M 12 x 55	S	100	99,00
M 12 x 60	S	100	102,00
M 12 x 65	S	50	121,00
M 12 x 70	S	50	107,00
M 12 x 75	S	50	130,00
M 12 x 80	S	50	118,00
M 12 x 90	S	50	136,00
M 12 x 100	S	50	142,00
M 12 x 110	S	50	160,00
M 12 x 120	S	50	170,00
M 12 x 130	S	50	182,00
M 12 x 140	S	50	197,00
M 12 x 150	S	50	215,00
M 12 x 160	S	25	234,00
M 12 x 170	S	25	260,00
M 12 x 180	S	25	260,00
M 12 x 190	S	25	290,00
M 12 x 200	S	25	290,00
M 12 x 220	S	25	330,00
M 12 x 240	S	25	355,00
M 12 x 250	S	25	380,00
M 12 x 260	S	25	380,00
M 12 x 280	S	25	410,00
M 12 x 300	S	25	440,00
M 12 x 320	S	25	520,00
M 12 x 340	S	25	560,00
M 12 x 360	S	25	630,00
M 12 x 380	S	25	700,00
M 12 x 400	S	25	810,00
M 16 x 40	S	50	265,00
M 16 x 45	S	50	265,00
M 16 x 50	S	50	239,00
M 16 x 55	S	50	260,00
M 16 x 60	S	50	260,00
M 16 x 65	S	25	295,00
M 16 x 70	S	25	275,00
M 16 x 75	S	25	330,00
M 16 x 80	S	25	275,00
M 16 x 90	S	25	285,00
M 16 x 100	S	25	295,00
M 16 x 110	S	25	330,00
M 16 x 120	S	25	335,00
M 16 x 130	S	25	400,00
M 16 x 140	S	25	400,00
M 16 x 150	S	25	410,00
M 16 x 160	S	25	450,00
M 16 x 170	S	25	475,00
M 16 x 180	S	25	475,00
M 16 x 200	S	25	495,00
M 16 x 220	S	25	590,00
M 16 x 240	S	25	640,00
M 16 x 260	S	25	690,00
M 16 x 280	S	25	740,00
M 16 x 300	S	25	780,00
M 16 x 320	S	10	810,00
M 16 x 340	S	10	850,00
M 16 x 360	S	10	890,00
M 16 x 400	S	10	980,00
M 20 x 80	S	25	890,00
M 20 x 100	S	25	960,00
M 20 x 120	S	25	1020,00
M 20 x 140	S	1	1090,00
M 20 x 160	S	1	1200,00
M 20 x 180	S	1	1250,00
M 20 x 200	S	1	1310,00
M 20 x 220	S	1	1350,00
M 20 x 240	S	1	1420,00
M 20 x 280	S	1	1600,00
M 20 x 300	S	1	1680,00

Abmessungen	VE	Stück	€/100/Obf.
DIN			00603.410
603			Mu Stahl galvanisch verzinkt

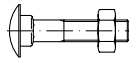

Flachrundsrauben mit Vierkantansatz, Mu = mit Sechskantmutter

Maße → **TI-32** REACH → **TI-262**
 Korrosionsschutz → **TI-228**
 Rostfrei → **S. 473**
 Messing → **S. 621**



M 5 x 16	S	500	23,00 gal Zn
M 5 x 16	K	100	29,00 gal Zn
M 5 x 20	S	500	23,20 gal Zn
M 5 x 20	K	100	29,50 gal Zn
M 5 x 25	S	500	23,60 gal Zn
M 5 x 25	K	100	30,00 gal Zn
M 5 x 30	S	500	24,90 gal Zn
M 5 x 30	K	100	31,00 gal Zn
M 5 x 35	S	200	25,50 gal Zn
M 5 x 40	S	200	29,00 gal Zn
M 5 x 45	S	200	30,50 gal Zn
M 5 x 50	S	200	31,50 gal Zn
M 5 x 55	S	200	36,50 gal Zn
M 5 x 60	S	200	37,00 gal Zn
M 5 x 65	S	200	52,00 gal Zn
M 5 x 70	S	200	52,00 gal Zn
M 5 x 80	S	200	58,00 gal Zn
M 5 x 90	S	200	98,00 gal Zn
M 6 x 16	S	500	10,80 gal Zn
M 6 x 16	K	100	16,70 gal Zn
M 6 x 20	S	500	10,80 gal Zn
M 6 x 20	K	100	16,70 gal Zn
M 6 x 25	S	500	11,20 gal Zn
M 6 x 25	K	100	17,20 gal Zn
M 6 x 30	S	500	11,70 gal Zn
M 6 x 30	K	100	17,70 gal Zn
M 6 x 35	S	200	12,90 gal Zn
M 6 x 40	S	200	14,00 gal Zn
M 6 x 45	S	200	14,60 gal Zn
M 6 x 50	S	200	15,30 gal Zn
M 6 x 55	S	200	18,00 gal Zn
M 6 x 60	S	200	17,10 gal Zn
M 6 x 65	S	200	28,50 gal Zn
M 6 x 70	S	200	27,50 gal Zn
M 6 x 75	S	200	33,50 gal Zn
M 6 x 80	S	200	41,50 gal Zn
M 6 x 90	S	100	44,50 gal Zn
M 6 x 100	S	100	53,00 gal Zn
M 6 x 110	S	100	67,00 gal Zn
M 6 x 120	S	100	68,00 gal Zn
M 6 x 130	S	100	107,00 gal Zn
M 6 x 140	S	100	113,00 gal Zn
M 6 x 150	S	100	184,00 gal Zn
M 8 x 16	S	200	17,60 gal Zn
M 8 x 20	S	200	17,90 gal Zn
M 8 x 25	S	200	18,40 gal Zn
M 8 x 30	S	200	19,20 gal Zn
M 8 x 35	S	200	20,90 gal Zn
M 8 x 40	S	200	22,00 gal Zn
M 8 x 45	S	200	23,30 gal Zn
M 8 x 50	S	200	24,00 gal Zn
M 8 x 55	S	200	27,50 gal Zn

Abmessungen	VE	Stück	€/100/Obf.
M 8 x 60	S	200	28,00 gal Zn
M 8 x 65	S	200	32,00 gal Zn
M 8 x 70	S	200	31,50 gal Zn
M 8 x 75	S	200	37,00 gal Zn
M 8 x 80	S	200	35,50 gal Zn
M 8 x 90	S	100	49,50 gal Zn
M 8 x 100	S	100	58,00 gal Zn
M 8 x 110	S	100	70,00 gal Zn
M 8 x 120	S	100	87,00 gal Zn
M 8 x 130	S	100	90,00 gal Zn
M 8 x 140	S	100	92,00 gal Zn
M 8 x 150	S	100	161,00 gal Zn
M 8 x 160	S	100	163,00 gal Zn
M 8 x 170	S	50	184,00 gal Zn
M 8 x 180	S	50	184,00 gal Zn
M 8 x 190	S	50	205,00 gal Zn
M 8 x 200	S	50	206,00 gal Zn
M 10 x 20	S	200	31,00 gal Zn
M 10 x 25	S	200	31,50 gal Zn
M 10 x 30	S	200	33,00 gal Zn
M 10 x 35	S	100	34,00 gal Zn
M 10 x 40	S	100	36,00 gal Zn
M 10 x 45	S	100	38,00 gal Zn
M 10 x 50	S	100	39,50 gal Zn
M 10 x 55	S	100	41,00 gal Zn
M 10 x 60	S	100	43,50 gal Zn
M 10 x 65	S	100	48,50 gal Zn
M 10 x 70	S	100	49,50 gal Zn
M 10 x 75	S	100	58,00 gal Zn
M 10 x 80	S	100	55,00 gal Zn
M 10 x 90	S	100	77,00 gal Zn
M 10 x 100	S	100	87,00 gal Zn
M 10 x 110	S	50	97,00 gal Zn
M 10 x 120	S	50	123,00 gal Zn
M 10 x 130	S	50	134,00 gal Zn
M 10 x 140	S	50	142,00 gal Zn
M 10 x 150	S	50	174,00 gal Zn
M 10 x 160	S	50	201,00 gal Zn
M 10 x 170	S	50	255,00 gal Zn
M 10 x 180	S	50	260,00 gal Zn
M 10 x 190	S	50	280,00 gal Zn
M 10 x 200	S	50	280,00 gal Zn
M 10 x 220	S	25	360,00 gal Zn
M 10 x 240	S	25	390,00 gal Zn
M 10 x 260	S	25	425,00 gal Zn
M 10 x 280	S	25	455,00 gal Zn
M 10 x 300	S	25	490,00 gal Zn
M 12 x 30	S	100	119,00 gal Zn
M 12 x 35	S	100	120,00 gal Zn
M 12 x 40	S	100	107,00 gal Zn
M 12 x 45	S	100	113,00 gal Zn
M 12 x 50	S	100	116,00 gal Zn
M 12 x 55	S	100	123,00 gal Zn
M 12 x 60	S	100	126,00 gal Zn
M 12 x 65	S	50	147,00 gal Zn
M 12 x 70	S	50	135,00 gal Zn
M 12 x 75	S	50	158,00 gal Zn
M 12 x 80	S	50	148,00 gal Zn
M 12 x 90	S	50	167,00 gal Zn
M 12 x 100	S	50	176,00 gal Zn
M 12 x 110	S	50	195,00 gal Zn
M 12 x 120	S	50	209,00 gal Zn
M 12 x 130	S	50	223,00 gal Zn
M 12 x 140	S	50	241,00 gal Zn
M 12 x 150	S	50	265,00 gal Zn
M 12 x 160	S	25	285,00 gal Zn
M 12 x 170	S	25	310,00 gal Zn
M 12 x 180	S	25	310,00 gal Zn
M 12 x 190	S	25	345,00 gal Zn
M 12 x 200	S	25	350,00 gal Zn
M 12 x 220	S	25	395,00 gal Zn
M 12 x 240	S	25	425,00 gal Zn
M 12 x 250	S	25	455,00 gal Zn
M 12 x 260	S	25	460,00 gal Zn
M 12 x 280	S	25	490,00 gal Zn

Abmessungen	VE	Stück	€/100/Obf.
M 12 x 300	S	25	530,00 gal Zn
M 12 x 320	S	25	610,00 gal Zn
M 12 x 340	S	25	670,00 gal Zn
M 12 x 360	S	25	740,00 gal Zn
M 12 x 380	S	25	810,00 gal Zn
M 12 x 400	S	25	930,00 gal Zn
M 16 x 35	S	50	325,00 gal Zn
M 16 x 40	S	50	305,00 gal Zn
M 16 x 45	S	50	305,00 gal Zn
M 16 x 50	S	50	285,00 gal Zn
M 16 x 55	S	50	305,00 gal Zn
M 16 x 60	S	50	305,00 gal Zn
M 16 x 65	S	25	345,00 gal Zn
M 16 x 70	S	25	325,00 gal Zn
M 16 x 75	S	25	380,00 gal Zn
M 16 x 80	S	25	330,00 gal Zn
M 16 x 90	S	25	350,00 gal Zn
M 16 x 100	S	25	360,00 gal Zn
M 16 x 110	S	25	400,00 gal Zn
M 16 x 120	S	25	410,00 gal Zn
M 16 x 130	S	25	475,00 gal Zn
M 16 x 140	S	25	485,00 gal Zn
M 16 x 150	S	25	500,00 gal Zn
M 16 x 160	S	25	540,00 gal Zn
M 16 x 170	S	25	570,00 gal Zn
M 16 x 180	S	25	580,00 gal Zn
M 16 x 190	S	25	600,00 gal Zn
M 16 x 200	S	25	610,00 gal Zn
M 16 x 220	S	25	710,00 gal Zn
M 16 x 240	S	25	770,00 gal Zn
M 16 x 260	S	25	840,00 gal Zn
M 16 x 280	S	25	880,00 gal Zn
M 16 x 300	S	25	940,00 gal Zn
M 16 x 320	S	10	990,00 gal Zn
M 16 x 340	S	10	1040,00 gal Zn
M 16 x 360	S	10	1080,00 gal Zn
M 16 x 380	S	10	1130,00 gal Zn
M 16 x 400	S	10	1190,00 gal Zn
M 20 x 80	S	25	990,00 gal Zn
M 20 x 100	S	25	1070,00 gal Zn
M 20 x 120	S	25	1150,00 gal Zn
M 20 x 140	S	1	1230,00 gal Zn
M 20 x 180	S	1	1420,00 gal Zn
M 20 x 200	S	1	1500,00 gal Zn
M 20 x 240	S	1	1630,00 gal Zn
M 20 x 280	S	1	1870,00 gal Zn
M 20 x 300	S	1	1960,00 gal Zn

DIN	00603.404	
603	Mu Stahl	F



Flachrundschrauben mit Vierkantansatz, Mu = mit Sechskantmutter F = Gewindelänge bis Vierkantansatz

Maße → TI-32 REACH → TI-262
 Rostfrei → S. 473
 Messing → S. 621



M 8 x 70	S	200	56,00
----------	---	-----	-------

DIN	00603.814
603	8.8 galvanisch verzinkt

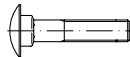

Flachrundschrauben mit Vierkantansatz (ohne Sechskantmutter)

Muttern → DIN 934/ISO 4034
 Festigkeitsklasse 8 gal Zn

Maße → TI-32 Korrosionsschutz → TI-228
 Werkstoffeigensch. → TI-232 Anziehmomente → TI-244

Rostfrei → S. 473
 Messing → S. 621



M 6 x 10	S	500	28,00 gal Zn
M 6 x 16	S	500	28,50 gal Zn
M 6 x 20	S	500	29,50 gal Zn
M 6 x 25	S	500	31,50 gal Zn
M 6 x 30	S	500	34,50 gal Zn
M 6 x 35	S	200	37,00 gal Zn
M 6 x 40	S	200	39,50 gal Zn
M 6 x 45	S	200	42,50 gal Zn
M 6 x 50	S	200	45,50 gal Zn
M 6 x 60	S	200	48,00 gal Zn
M 6 x 70	S	200	51,00 gal Zn
M 8 x 16	S	200	47,00 gal Zn
M 8 x 20	S	200	51,00 gal Zn
M 8 x 25	S	200	54,00 gal Zn
M 8 x 30	S	200	57,00 gal Zn
M 8 x 35	S	200	62,00 gal Zn
M 8 x 40	S	200	66,00 gal Zn
M 8 x 45	S	200	69,00 gal Zn
M 8 x 50	S	200	76,00 gal Zn
M 8 x 55	S	200	79,00 gal Zn
M 8 x 60	S	200	84,00 gal Zn
M 8 x 65	S	200	91,00 gal Zn
M 8 x 70	S	200	97,00 gal Zn
M 8 x 80	S	200	112,00 gal Zn
M 8 x 90	S	100	125,00 gal Zn
M 8 x 100	S	100	137,00 gal Zn
M 8 x 110	S	100	146,00 gal Zn
M 8 x 120	S	100	146,00 gal Zn
M 8 x 140	S	100	158,00 gal Zn
M 10 x 20	S	200	78,00 gal Zn
M 10 x 25	S	200	83,00 gal Zn
M 10 x 30	S	200	86,00 gal Zn
M 10 x 35	S	100	92,00 gal Zn
M 10 x 40	S	100	103,00 gal Zn
M 10 x 45	S	100	111,00 gal Zn
M 10 x 50	S	100	117,00 gal Zn
M 10 x 55	S	100	121,00 gal Zn
M 10 x 60	S	100	131,00 gal Zn
M 10 x 65	S	100	138,00 gal Zn
M 10 x 70	S	100	146,00 gal Zn
M 10 x 75	S	100	153,00 gal Zn
M 10 x 80	S	100	157,00 gal Zn
M 10 x 90	S	100	177,00 gal Zn
M 10 x 100	S	100	197,00 gal Zn
M 10 x 110	S	100	200,00 gal Zn
M 10 x 120	S	100	206,00 gal Zn
M 12 x 25	S	100	115,00 gal Zn
M 12 x 30	S	100	118,00 gal Zn
M 12 x 35	S	100	124,00 gal Zn

Abmessungen	VE	Stück	€/100/Obf.
M 12 x 40	S	100	132,00 gal Zn
M 12 x 45	S	100	141,00 gal Zn
M 12 x 50	S	100	148,00 gal Zn
M 12 x 60	S	100	166,00 gal Zn
M 12 x 70	S	50	181,00 gal Zn
M 12 x 75	S	50	182,00 gal Zn
M 12 x 80	S	50	203,00 gal Zn
M 12 x 90	S	50	230,00 gal Zn
M 12 x 100	S	50	244,00 gal Zn
M 12 x 110	S	50	260,00 gal Zn
M 12 x 120	S	50	275,00 gal Zn
M 12 x 130	S	50	295,00 gal Zn
M 16 x 40	S	50	630,00 gal Zn
M 16 x 45	S	50	660,00 gal Zn
M 16 x 50	S	50	660,00 gal Zn
M 16 x 60	S	50	680,00 gal Zn
M 16 x 65	S	25	720,00 gal Zn
M 16 x 70	S	25	720,00 gal Zn
M 16 x 80	S	25	760,00 gal Zn
M 16 x 90	S	25	780,00 gal Zn
M 16 x 100	S	25	820,00 gal Zn
M 16 x 110	S	25	830,00 gal Zn
M 16 x 120	S	25	840,00 gal Zn
M 16 x 130	S	25	860,00 gal Zn
M 16 x 140	S	25	880,00 gal Zn
M 16 x 160	S	25	910,00 gal Zn

DIN	00603.824
603	8.8 feuerverzinkt

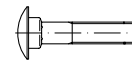

Flachrundschrauben mit Vierkantansatz

ohne Sechskantmutter, Gewinde mit Untermaß (Gaz + tZn = U)

Achtung! Infoeinblender beachten.

Muttern → DIN 934/ISO 4034
 Festigkeitsklasse 8 tZn

Maße → TI-32 Korrosionsschutz → TI-231
 Werkstoffeigensch. → TI-232 Anziehmomente → TI-244

Rostfrei → S. 473
 Messing → S. 621

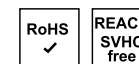

M 10 x 25	S	100	89,00 tZn
M 10 x 30	S	100	92,00 tZn
M 10 x 35	S	100	99,00 tZn
M 10 x 40	S	100	109,00 tZn
M 12 x 25	S	100	121,00 tZn
M 12 x 30	S	100	124,00 tZn
M 12 x 35	S	100	130,00 tZn
M 12 x 40	S	100	138,00 tZn

Achtung!

Feuerverzinkte Schrauben-/Mutter-Garnituren dürfen nur miteinander verschraubt werden, wenn Gewindespiel/-Toleranzen dieser Garnituren entsprechend ISO 10684 passend aufeinander abgestimmt sind. Die Verwendung mit anderen Schrauben-/Mutter-Ausführungen kann zu Verschraubungsproblemen und/oder zum Versagen der Verbindung führen.



Abmessungen	VE Stück	€/100/Obf.
DIN 00604.400		

604

Mu Stahl

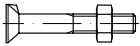

Senkschrauben mit Nase,
Mu = mit Sechskantmutter

Maße → TI-32

REACH → TI-262



M 6	x	20	S	500	41,00
M 6	x	25	S	500	43,00
M 6	x	30	S	500	44,50
M 6	x	35	S	200	45,50
M 6	x	40	S	200	47,50
M 6	x	60	S	200	60,00
M 8	x	20	S	200	48,00
M 8	x	25	S	200	48,00
M 8	x	30	S	200	49,50
M 8	x	35	S	200	52,00
M 8	x	40	S	200	53,00
M 8	x	45	S	200	54,00
M 8	x	50	S	200	57,00
M 8	x	55	S	200	64,00
M 8	x	60	S	200	66,00
M 8	x	70	S	200	76,00
M 10	x	25	S	200	84,00
M 10	x	30	S	200	86,00
M 10	x	35	S	100	88,00
M 10	x	40	S	100	91,00
M 10	x	45	S	100	94,00
M 10	x	50	S	100	95,00
M 10	x	55	S	100	104,00
M 10	x	60	S	100	104,00
M 10	x	70	S	100	112,00
M 10	x	80	S	100	120,00
M 10	x	100	S	100	170,00
M 12	x	25	S	100	114,00
M 12	x	30	S	100	114,00
M 12	x	35	S	100	114,00
M 12	x	40	S	100	118,00
M 12	x	45	S	100	120,00
M 12	x	50	S	100	125,00
M 12	x	55	S	100	128,00
M 12	x	60	S	100	130,00
M 12	x	65	S	50	152,00
M 12	x	70	S	50	142,00
M 12	x	80	S	50	146,00
M 12	x	90	S	50	160,00
M 12	x	100	S	50	166,00
M 12	x	110	S	50	410,00
M 12	x	120	S	50	435,00
M 16	x	30	S	50	221,00
M 16	x	35	S	50	221,00
M 16	x	40	S	50	224,00
M 16	x	45	S	50	230,00
M 16	x	50	S	50	235,00
M 16	x	55	S	50	244,00
M 16	x	60	S	50	244,00
M 16	x	65	S	25	260,00
M 16	x	70	S	25	260,00
M 16	x	75	S	25	330,00
M 16	x	80	S	25	330,00
M 16	x	90	S	25	340,00
M 16	x	100	S	25	360,00
M 16	x	110	S	25	500,00

Abmessungen	VE Stück	€/100/Obf.			
M 16	x	120	S	25	510,00
M 16	x	130	S	25	630,00
M 16	x	140	S	25	880,00
M 20	x	40	S	25	405,00
M 20	x	45	S	25	405,00
M 20	x	50	S	25	405,00
M 20	x	55	S	25	430,00
M 20	x	60	S	25	430,00
M 20	x	65	S	25	460,00
M 20	x	70	S	25	460,00
M 20	x	75	S	25	470,00
M 20	x	80	S	25	470,00
M 20	x	90	S	25	500,00
M 20	x	100	S	25	510,00
M 20	x	110	S	25	830,00
M 20	x	120	S	25	830,00
M 20	x	130	S	25	860,00
M 20	x	140	S	25	980,00
M 24	x	60	S	25	730,00
M 24	x	65	S	25	760,00
M 24	x	70	S	25	760,00
M 24	x	75	S	25	790,00
M 24	x	80	S	25	790,00
M 24	x	90	S	10	820,00
M 24	x	100	S	10	850,00
M 24	x	110	S	10	1090,00
M 24	x	120	S	10	1290,00
M 24	x	130	S	10	1500,00

Abmessungen	VE Stück	€/100/Obf.
DIN 00605.400		

605

Mu Stahl

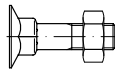

Senkschrauben
mit hohem Vierkantansatz,
Mu = mit Sechskantmutter

Maße → TI-33

REACH → TI-262



M 6	x	30	S	500	98,00
M 6	x	35	S	200	98,00
M 6	x	40	S	200	100,00
M 6	x	45	S	200	101,00
M 6	x	50	S	200	102,00
M 6	x	55	S	200	103,00
M 6	x	60	S	200	104,00
M 8	x	30	S	200	105,00
M 8	x	35	S	200	106,00
M 8	x	40	S	200	108,00
M 8	x	45	S	200	110,00
M 8	x	50	S	200	113,00
M 8	x	55	S	200	114,00
M 8	x	60	S	200	118,00
M 8	x	65	S	200	123,00
M 8	x	70	S	200	124,00
M 10	x	30	S	200	131,00
M 10	x	35	S	100	132,00
M 10	x	40	S	100	132,00
M 10	x	50	S	100	142,00
M 10	x	60	S	100	148,00
M 10	x	70	S	100	174,00

Abmessungen	VE Stück	€/100/Obf.
DIN 00607.400		

607

Mu Stahl

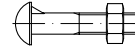

Halbrundschrauben mit Nase,
Mu = mit Sechskantmutter

Maße → TI-33

REACH → TI-262



M 8	x	20	S	200	78,00
M 8	x	25	S	200	79,00
M 8	x	35	S	200	86,00
M 8	x	40	S	200	86,00
M 10	x	20	S	200	89,00
M 10	x	25	S	200	89,00
M 10	x	30	S	200	89,00
M 10	x	40	S	100	98,00
M 12	x	30	S	100	126,00
M 12	x	35	S	100	129,00
M 12	x	40	S	100	138,00
M 16	x	35	S	50	285,00
M 16	x	40	S	50	290,00
M 16	x	45	S	50	300,00
M 16	x	50	S	50	305,00
M 16	x	60	S	50	330,00

Abmessungen	VE Stück	€/100/Obf.
DIN 00608.800		

608

Mu 8.8

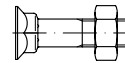

Senkschrauben
mit niedrigem Vierkantansatz,
Mu = mit Sechskantmutter

Maße → TI-33

Anziehmomente → TI-244

Werkstoffeigensch. → TI-232



M 8	x	30	S	200	175,00
M 8	x	35	S	200	182,00
M 10	x	25	S	200	158,00
M 10	x	30	S	200	167,00
M 10	x	35	S	100	184,00
M 10	x	40	S	100	200,00
M 10	x	45	S	100	205,00
M 10	x	50	S	100	270,00
M 10	x	60	S	100	375,00
M 12	x	25	S	100	265,00
M 12	x	30	S	100	275,00
M 12	x	35	S	100	305,00
M 12	x	40	S	100	305,00
M 12	x	45	S	100	315,00
M 12	x	50	S	100	345,00
M 12	x	55	S	100	440,00
M 12	x	60	S	100	440,00
M 12	x	65	S	50	495,00

Abmessungen	VE	Stück	€/100/Obf.
M 12 x 70	S	50	495,00
M 16 x 40	S	50	610,00
M 16 x 50	S	50	630,00
M 16 x 55	S	50	670,00
M 16 x 60	S	50	670,00
M 16 x 70	S	25	750,00
M 16 x 80	S	25	840,00

DIN	00609.800
-----	-----------

609 8.8

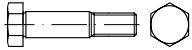

Sechskant-Passschrauben mit langem Gewindezapfen

Maße → TI-16 Anziehmomente → TI-244
Werkstoffeigensch. → TI-232



M 8 x 25	S	25	445,00
M 8 x 30	S	25	470,00
M 8 x 32	S	25	470,00
M 8 x 35	S	25	475,00
M 8 x 40	S	25	495,00
M 8 x 45	S	25	510,00
M 8 x 50	S	25	530,00
M 8 x 60	S	25	720,00
M 8 x 70	S	25	760,00
M 10 x 30	S	25	480,00
M 10 x 35	S	25	495,00
M 10 x 40	S	25	510,00
M 10 x 45	S	25	540,00
M 10 x 50	S	25	560,00
M 10 x 55	S	25	560,00
M 10 x 60	S	25	570,00
M 10 x 65	S	25	770,00
M 10 x 70	S	25	770,00
M 10 x 75	S	25	780,00
M 10 x 80	S	25	790,00
M 10 x 90	S	25	820,00
M 10 x 100	S	25	850,00
M 12 x 30	S	25	540,00
M 12 x 35	S	25	560,00
M 12 x 40	S	25	580,00
M 12 x 45	S	25	610,00
M 12 x 50	S	25	650,00
M 12 x 55	S	25	670,00
M 12 x 60	S	25	670,00
M 12 x 65	S	25	890,00
M 12 x 70	S	25	920,00
M 12 x 75	S	10	940,00
M 12 x 80	S	10	940,00
M 12 x 90	S	10	990,00
M 12 x 100	S	10	990,00
M 14 x 35	S	10	620,00
M 14 x 40	S	10	650,00
M 14 x 45	S	10	670,00
M 14 x 50	S	10	690,00
M 14 x 60	S	10	730,00
M 14 x 65	S	10	760,00
M 14 x 70	S	10	780,00
M 14 x 80	S	10	1120,00
M 16 x 40	S	10	690,00
M 16 x 45	S	10	730,00
M 16 x 50	S	10	760,00
M 16 x 55	S	10	780,00

Abmessungen	VE	Stück	€/100/Obf.
M 16 x 60	S	10	820,00
M 16 x 65	S	10	830,00
M 16 x 70	S	10	860,00
M 16 x 75	S	10	880,00
M 16 x 80	S	10	910,00
M 16 x 85	S	10	990,00
M 16 x 90	S	10	990,00
M 16 x 100	S	10	1120,00
M 16 x 120	S	10	1340,00
M 20 x 45	S	10	1150,00
M 20 x 50	S	10	1240,00
M 20 x 55	S	10	1250,00
M 20 x 60	S	10	1280,00
M 20 x 65	S	10	1340,00
M 20 x 70	S	10	1350,00
M 20 x 75	S	10	1380,00
M 20 x 80	S	1	1430,00
M 20 x 85	S	1	1460,00
M 20 x 90	S	1	1520,00
M 20 x 100	S	1	1600,00
M 20 x 110	S	1	1720,00
M 20 x 120	S	1	1770,00
M 20 x 130	S	1	4450,00
M 20 x 140	S	1	4600,00
M 20 x 150	S	1	4800,00
M 20 x 160	S	1	4950,00
M 20 x 180	S	1	5400,00
M 20 x 200	S	1	5700,00
M 24 x 60	S	1	2300,00
M 24 x 65	S	1	2340,00
M 24 x 70	S	1	2400,00
M 24 x 75	S	1	2440,00
M 24 x 80	S	1	2500,00
M 24 x 85	S	1	2550,00
M 24 x 90	S	1	2600,00
M 24 x 100	S	1	2700,00
M 24 x 110	S	1	2850,00
M 24 x 120	S	1	2950,00
M 24 x 130	S	1	5100,00
M 24 x 140	S	1	5300,00
M 24 x 150	S	1	5400,00
M 24 x 160	S	1	5700,00
M 24 x 180	S	1	6200,00
M 24 x 200	S	1	6700,00
M 30 x 70	S	1	3650,00
M 30 x 75	S	1	3700,00
M 30 x 80	S	1	3850,00
M 30 x 85	S	1	3900,00
M 30 x 90	S	1	3950,00
M 30 x 100	S	1	4200,00
M 30 x 110	S	1	4400,00
M 30 x 120	S	1	4600,00
M 30 x 130	S	1	4750,00
M 30 x 140	S	1	4950,00
M 30 x 150	S	1	5200,00
M 30 x 160	S	1	5400,00
M 30 x 200	S	1	6300,00
M 36 x 90	S	1	4750,00
M 36 x 100	S	1	5100,00
M 36 x 110	S	1	5300,00
M 36 x 120	S	1	5600,00
M 36 x 130	S	1	5700,00
M 36 x 140	S	1	5900,00
M 36 x 150	S	1	6200,00
M 36 x 160	S	1	6400,00

Abmessungen	VE	Stück	€/100/Obf.
DIN	00609.100		

609 10.9

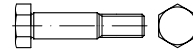

Sechskant-Passschrauben mit langem Gewindezapfen

Maße → TI-16 Anziehmomente → TI-244
Werkstoffeigensch. → TI-232

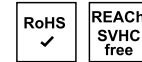

M 8 x 25	S	25	580,00
M 8 x 30	S	25	610,00
M 8 x 35	S	25	620,00
M 8 x 40	S	25	640,00
M 8 x 45	S	25	670,00
M 8 x 50	S	50	680,00
M 10 x 30	S	25	630,00
M 10 x 35	S	25	710,00
M 10 x 40	S	25	670,00
M 10 x 45	S	25	700,00
M 10 x 50	S	25	720,00
M 10 x 55	S	25	730,00
M 10 x 60	S	25	740,00
M 12 x 30	S	25	700,00
M 12 x 35	S	25	720,00
M 12 x 40	S	25	750,00
M 12 x 45	S	25	790,00
M 12 x 50	S	25	840,00
M 12 x 55	S	25	870,00
M 12 x 60	S	25	870,00
M 16 x 40	S	10	900,00
M 16 x 45	S	10	950,00
M 16 x 50	S	10	980,00
M 16 x 55	S	10	1010,00
M 16 x 60	S	10	1060,00
M 16 x 65	S	10	1070,00
M 16 x 70	S	10	1120,00
M 16 x 80	S	10	1180,00
M 16 x 90	S	10	1280,00
M 16 x 100	S	10	1450,00
M 20 x 45	S	10	1500,00
M 20 x 50	S	10	1610,00
M 20 x 55	S	10	1630,00
M 20 x 60	S	10	1660,00
M 20 x 65	S	10	1740,00
M 20 x 70	S	10	1750,00
M 20 x 75	S	10	1800,00
M 20 x 80	S	1	1860,00
M 20 x 85	S	1	1890,00
M 20 x 90	S	1	1970,00
M 20 x 100	S	1	2080,00
M 20 x 110	S	1	2240,00
M 20 x 120	S	1	2300,00
M 24 x 60	S	1	3000,00
M 24 x 65	S	1	3050,00
M 24 x 70	S	1	3150,00
M 24 x 75	S	1	3200,00
M 24 x 80	S	1	3250,00
M 24 x 85	S	1	3350,00
M 24 x 90	S	1	3400,00
M 24 x 100	S	1	3550,00
M 24 x 110	S	1	3650,00
M 24 x 120	S	1	3850,00
M 24 x 130	S	1	6700,00
M 24 x 140	S	1	6900,00

Abmessungen	VE Stück	€/100/Obf.
~DIN	00610.800	

610 8.8

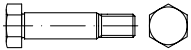

Sechskant-Passschrauben mit kurzem Gewindezapfen

Maße → TI-17 Anziehmomente → TI-244
Werkstoffeigensch. → TI-232



M 8	x	25	S	25	445,00
M 8	x	30	S	25	470,00
M 8	x	35	S	25	475,00
M 8	x	40	S	25	495,00
M 8	x	45	S	25	510,00
M 8	x	50	S	25	530,00
M 8	x	60	S	25	720,00
M 8	x	70	S	25	760,00
M 8	x	80	S	25	830,00
M 10	x	30	S	25	480,00
M 10	x	35	S	25	495,00
M 10	x	40	S	25	510,00
M 10	x	45	S	25	540,00
M 10	x	50	S	25	560,00
M 10	x	55	S	25	560,00
M 10	x	60	S	25	570,00
M 10	x	65	S	25	770,00
M 10	x	70	S	25	770,00
M 10	x	80	S	25	790,00
M 10	x	90	S	25	820,00
M 10	x	100	S	25	850,00
M 12	x	30	S	25	540,00
M 12	x	35	S	25	560,00
M 12	x	40	S	25	580,00
M 12	x	45	S	25	610,00
M 12	x	50	S	25	650,00
M 12	x	55	S	25	670,00
M 12	x	60	S	25	670,00
M 12	x	65	S	25	890,00
M 12	x	70	S	25	920,00
M 12	x	75	S	10	940,00
M 12	x	80	S	10	940,00
M 12	x	90	S	10	990,00
M 12	x	100	S	10	990,00
M 14	x	35	S	10	620,00
M 14	x	40	S	10	650,00
M 14	x	45	S	10	670,00
M 14	x	50	S	10	690,00
M 14	x	55	S	10	720,00
M 14	x	60	S	10	730,00
M 14	x	65	S	10	760,00
M 14	x	70	S	10	780,00
M 14	x	80	S	10	1120,00
M 16	x	35	S	10	670,00
M 16	x	40	S	10	690,00
M 16	x	45	S	10	730,00
M 16	x	50	S	10	760,00
M 16	x	55	S	10	780,00
M 16	x	60	S	10	820,00
M 16	x	65	S	10	830,00
M 16	x	70	S	10	860,00
M 16	x	75	S	10	880,00
M 16	x	80	S	10	910,00
M 16	x	85	S	10	990,00
M 16	x	90	S	10	990,00

M 16	x	100	S	10	1120,00
M 16	x	110	S	10	1210,00
M 16	x	120	S	10	1340,00
M 20	x	40	S	10	1120,00
M 20	x	45	S	10	1150,00
M 20	x	50	S	10	1240,00
M 20	x	55	S	10	1250,00
M 20	x	60	S	10	1280,00
M 20	x	65	S	10	1340,00
M 20	x	70	S	10	1350,00
M 20	x	75	S	10	1380,00
M 20	x	80	S	1	1430,00
M 20	x	85	S	1	1460,00
M 20	x	90	S	1	1520,00
M 20	x	100	S	1	1600,00
M 20	x	110	S	1	1720,00
M 20	x	120	S	1	1770,00
M 20	x	130	S	1	4450,00
M 20	x	150	S	1	4800,00
M 24	x	60	S	1	2300,00
M 24	x	65	S	1	2340,00
M 24	x	70	S	1	2400,00
M 24	x	75	S	1	2440,00
M 24	x	80	S	1	2500,00
M 24	x	85	S	1	2550,00
M 24	x	90	S	1	2600,00
M 24	x	100	S	1	2700,00
M 24	x	110	S	1	2850,00
M 24	x	120	S	1	2950,00
M 24	x	130	S	1	5100,00
M 24	x	140	S	1	5300,00
M 24	x	150	S	1	5600,00
M 30	x	80	S	1	3850,00
M 30	x	90	S	1	3950,00
M 30	x	95	S	1	4150,00
M 30	x	100	S	1	4200,00
M 30	x	110	S	1	4400,00
M 30	x	120	S	1	4600,00
M 30	x	130	S	1	4750,00
M 36	x	90	S	1	4750,00
M 36	x	100	S	1	5100,00
M 36	x	110	S	1	5300,00
M 36	x	120	S	1	5600,00
M 36	x	130	S	1	5700,00
M 36	x	140	S	1	5900,00
M 36	x	150	S	1	6200,00
M 36	x	160	S	1	6400,00

~DIN	00610.100
------	-----------

610 10.9

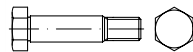

Sechskant-Passschrauben mit kurzem Gewindezapfen

Maße → TI-17 Anziehmomente → TI-244
Werkstoffeigensch. → TI-232

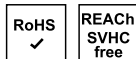

M 8	x	25	S	25	580,00
M 8	x	30	S	25	610,00
M 8	x	35	S	25	620,00
M 8	x	40	S	25	640,00
M 8	x	45	S	25	670,00
M 8	x	50	S	25	680,00
M 10	x	30	S	25	630,00

M 10	x	35	S	25	640,00
M 10	x	40	S	25	670,00
M 10	x	45	S	25	700,00
M 10	x	50	S	25	720,00
M 10	x	55	S	25	730,00
M 10	x	60	S	25	740,00
M 12	x	30	S	25	700,00
M 12	x	35	S	25	455,00
M 12	x	40	S	25	750,00
M 12	x	45	S	25	790,00
M 12	x	50	S	25	840,00
M 12	x	55	S	25	870,00
M 12	x	60	S	25	870,00
M 16	x	35	S	10	870,00
M 16	x	40	S	10	900,00
M 16	x	45	S	10	950,00
M 16	x	50	S	10	980,00
M 16	x	55	S	10	1010,00
M 16	x	60	S	10	1060,00
M 16	x	65	S	10	1070,00
M 16	x	70	S	10	1120,00
M 16	x	75	S	10	1140,00
M 16	x	80	S	10	1180,00
M 16	x	85	S	10	1280,00
M 16	x	90	S	10	1280,00
M 16	x	100	S	10	1450,00
M 16	x	110	S	10	1580,00
M 20	x	40	S	10	1450,00
M 20	x	45	S	10	1500,00
M 20	x	50	S	10	1610,00
M 20	x	55	S	10	1630,00
M 20	x	60	S	10	1660,00
M 20	x	65	S	10	1740,00
M 20	x	70	S	10	1750,00
M 20	x	75	S	10	1800,00
M 20	x	80	S	1	1860,00
M 20	x	85	S	1	1890,00
M 20	x	90	S	1	1970,00
M 20	x	100	S	1	2080,00
M 20	x	110	S	1	2240,00
M 20	x	120	S	1	2300,00
M 24	x	60	S	1	3000,00
M 24	x	65	S	1	3050,00
M 24	x	70	S	1	3150,00
M 24	x	75	S	1	3200,00
M 24	x	80	S	1	3250,00
M 24	x	85	S	1	3350,00
M 24	x	90	S	1	3400,00
M 24	x	100	S	1	3550,00
M 24	x	110	S	1	3650,00
M 24	x	120	S	1	3850,00
M 24	x	130	S	1	6700,00
M 24	x	140	S	1	6900,00

DIN	00653.000
-----	-----------

653 Stahl

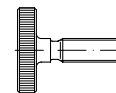

Rändelschrauben, niedrige Form

Maße → TI-33 REACH → TI-262

Rostfrei → S. 474



M 3	x	6	S	50	83,00
M 3	x	8	S	50	84,00

Abmessungen	VE	Stück	€/100/Obf.
M 3 x 10	S	50	88,00
M 3 x 12	S	50	92,00
M 3 x 16	S	50	96,00
M 4 x 8	S	50	96,00
M 4 x 10	S	50	105,00
M 4 x 12	S	50	107,00
M 4 x 16	S	50	112,00
M 4 x 20	S	50	117,00
M 4 x 25	S	50	126,00
M 4 x 30	S	50	176,00
M 4 x 35	S	50	186,00
M 5 x 10	S	50	124,00
M 5 x 12	S	50	131,00
M 5 x 16	S	50	137,00
M 5 x 20	S	50	153,00
M 5 x 25	S	25	171,00
M 5 x 30	S	25	184,00
M 5 x 35	S	25	206,00
M 5 x 40	S	25	229,00
M 6 x 12	S	25	160,00
M 6 x 16	S	25	172,00
M 6 x 20	S	25	192,00
M 6 x 25	S	25	211,00
M 6 x 30	S	25	233,00
M 6 x 35	S	25	255,00
M 6 x 40	S	25	275,00
M 6 x 45	S	25	315,00
M 8 x 16	S	25	246,00
M 8 x 20	S	25	275,00
M 8 x 25	S	25	295,00
M 8 x 30	S	25	335,00
M 8 x 35	S	25	360,00
M 8 x 40	S	10	410,00
M 8 x 45	S	10	445,00
M 8 x 50	S	10	495,00
M 8 x 60	S	10	660,00
M 10 x 20	S	25	445,00
M 10 x 25	S	10	530,00
M 10 x 30	S	10	600,00
M 10 x 40	S	10	690,00
M 10 x 50	S	10	770,00
M 10 x 60	S	10	1010,00
M 10 x 70	S	1	1230,00
M 10 x 80	S	1	1430,00

DIN 00660.000

660

Stahl

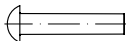

Halbrundniete

Maße → TI-134 REACH → TI-262

Rostfrei → S. 474
Messing, Kupfer, Aluminium → S. 621

Ø ≤ 9 = DIN 660
Ø 10 = DIN 124



2 x 4	S	1000	1,85
2 x 5	S	1000	1,85
2 x 6	S	1000	1,85
2 x 8	S	1000	1,95
2 x 10	S	1000	2,00
2 x 12	S	1000	2,20
2 x 16	S	1000	2,40
2,5 x 6	S	1000	1,90

Abmessungen	VE	Stück	€/100/Obf.
2,5 x 8	S	1000	2,00
2,5 x 10	S	1000	2,15
2,5 x 12	S	1000	2,20
2,5 x 16	S	1000	2,40
2,5 x 20	S	1000	2,90
3 x 4	S	1000	1,95
3 x 5	S	1000	1,95
3 x 6	S	1000	1,95
3 x 8	S	1000	2,15
3 x 10	S	1000	2,25
3 x 12	S	1000	2,40
3 x 16	S	1000	2,75
3 x 18	S	1000	2,90
3 x 20	S	1000	2,90
3 x 25	S	1000	4,85
3 x 30	S	1000	5,40
4 x 6	S	1000	2,60
4 x 8	S	1000	2,90
4 x 10	S	1000	3,30
4 x 12	S	1000	3,60
4 x 16	S	1000	4,25
4 x 18	S	1000	4,85
4 x 20	S	1000	4,85
4 x 22	S	500	6,60
4 x 25	S	500	6,60
4 x 30	S	500	7,40
4 x 35	S	500	8,20
4 x 40	S	250	9,10
4 x 45	S	250	9,70
4 x 50	S	250	10,60
5 x 6	S	1000	3,90
5 x 8	S	1000	3,90
5 x 10	S	1000	4,30
5 x 12	S	1000	4,70
5 x 16	S	1000	6,00
5 x 18	S	500	7,40
5 x 20	S	500	7,40
5 x 22	S	500	8,80
5 x 25	S	500	8,80
5 x 28	S	500	9,70
5 x 30	S	500	9,70
5 x 35	S	250	10,60
5 x 40	S	250	11,50
5 x 45	S	250	12,40
5 x 50	S	250	13,40
5 x 55	S	100	14,40
5 x 60	S	100	15,30
6 x 10	S	500	8,40
6 x 12	S	500	8,80
6 x 16	S	500	9,70
6 x 18	S	500	10,70
6 x 20	S	500	10,70
6 x 22	S	250	11,50
6 x 25	S	250	11,50
6 x 30	S	250	12,80
6 x 32	S	250	13,80
6 x 35	S	250	13,80
6 x 40	S	250	14,80
6 x 45	S	250	16,40
6 x 50	S	250	17,40
6 x 55	S	100	18,60
6 x 60	S	100	19,70
6 x 70	S	100	23,20
7 x 12	S	250	12,90
7 x 25	S	250	18,00
7 x 30	S	250	20,00
7 x 50	S	100	41,50
7 x 60	S	100	44,50
8 x 10	S	250	12,10
8 x 12	S	250	12,90
8 x 16	S	250	14,40
8 x 18	S	250	16,00
8 x 20	S	250	16,00
8 x 22	S	250	18,00
8 x 25	S	250	18,00

Abmessungen	VE	Stück	€/100/Obf.
8 x 30	S	250	20,00
8 x 32	S	100	22,00
8 x 35	S	100	22,00
8 x 40	S	100	23,90
8 x 45	S	100	39,00
8 x 50	S	100	41,50
8 x 55	S	100	43,00
8 x 60	S	100	44,50
10 x 12	S	100	32,50
10 x 16	S	100	38,00
10 x 20	S	100	43,00
10 x 25	S	100	48,00
10 x 30	S	100	56,00
10 x 35	S	100	65,00
10 x 40	S	100	72,00
10 x 45	S	100	78,00
10 x 50	S	100	85,00
10 x 60	S	100	99,00

DIN 00661.000

661

Stahl

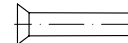

Senkniete

Maße → TI-134 REACH → TI-262

Rostfrei → S. 475
Messing, Kupfer, Aluminium → S. 622

Ø ≤ 9 = DIN 661
Ø 10 = DIN 302



2 x 6	S	1000	1,85
2 x 8	S	1000	1,95
2 x 10	S	1000	2,00
2 x 12	S	1000	2,20
2 x 16	S	1000	2,40
2,5 x 6	S	1000	1,90
2,5 x 8	S	1000	2,00
2,5 x 10	S	1000	2,15
2,5 x 12	S	1000	2,20
2,5 x 20	S	1000	2,90
3 x 5	S	1000	1,95
3 x 6	S	1000	1,95
3 x 8	S	1000	2,15
3 x 10	S	1000	2,25
3 x 12	S	1000	2,40
3 x 16	S	1000	2,75
3 x 18	S	1000	2,90
3 x 20	S	1000	2,90
3 x 22	S	1000	4,85
3 x 25	S	1000	4,85
3 x 30	S	1000	5,40
4 x 6	S	1000	2,60
4 x 8	S	1000	2,90
4 x 10	S	1000	3,30
4 x 12	S	1000	3,60
4 x 16	S	1000	4,25
4 x 18	S	1000	4,85
4 x 20	S	1000	4,85
4 x 22	S	500	6,60
4 x 25	S	500	6,60
4 x 30	S	500	7,40
4 x 40	S	250	9,70
4 x 50	S	250	10,60
5 x 6	S	1000	3,90

Abmessungen	VE	Stück	€/100/Obf.
5 x 8	S	1000	3,90
5 x 10	S	1000	4,30
5 x 12	S	1000	4,70
5 x 16	S	1000	6,00
5 x 18	S	500	7,40
5 x 20	S	500	7,40
5 x 22	S	500	8,80
5 x 25	S	500	8,80
5 x 30	S	500	9,70
5 x 32	S	250	10,60
5 x 35	S	250	10,60
5 x 40	S	250	11,50
5 x 45	S	250	12,40
5 x 50	S	250	13,40
5 x 60	S	100	15,30
6 x 10	S	500	8,40
6 x 12	S	500	8,80
6 x 16	S	500	9,70
6 x 18	S	500	10,70
6 x 20	S	500	10,70
6 x 22	S	250	11,50
6 x 25	S	250	11,50
6 x 30	S	250	12,80
6 x 35	S	250	13,80
6 x 40	S	250	14,80
6 x 45	S	250	16,40
6 x 50	S	250	17,40
6 x 60	S	100	19,70
7 x 25	S	250	18,00
7 x 30	S	250	20,00
8 x 12	S	250	12,90
8 x 16	S	250	14,40
8 x 20	S	250	16,00
8 x 25	S	250	18,00
8 x 30	S	250	20,00
8 x 35	S	100	22,00
8 x 40	S	100	23,90
8 x 50	S	100	41,50
8 x 60	S	100	44,50

DIN 00662.000

662

Stahl

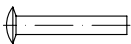

Linsenniete (Blechniete)

Maße → TI-134 REACH → TI-262

Kupfer, Aluminium → S. 623



2 x 4	S	2000	1,75
2,5 x 5	S	1000	2,25
3 x 6	S	1000	1,95
3 x 8	S	1000	2,15
3,5 x 8	S	1000	2,70
4 x 8	S	1000	2,90
4 x 12	S	1000	3,60
5 x 16	S	500	6,00
6 x 16	S	500	9,70

Abmessungen VE Stück €/100/Obf.
DIN 00674.000

674

Stahl

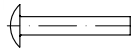

Flachrundniete

Maße → TI-135 REACH → TI-262



3 x 6	S	1000	2,15
3 x 8	S	1000	2,25
3 x 10	S	1000	2,40
3 x 16	S	1000	2,80
4 x 6	S	1000	2,75
4 x 8	S	1000	3,00
4 x 10	S	1000	3,40
4 x 12	S	1000	3,75
4 x 16	S	1000	4,40
5 x 10	S	1000	4,55
5 x 12	S	1000	4,95
5 x 16	S	1000	6,30

~DIN 00703.000

703

Stahl

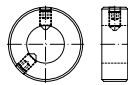

Stellringe, schwere Reihe, mit Gewindestift nach DIN 914/ISO 4027

Maße → TI-111 REACH → TI-262



Innen- / Nenn Ø x Außen Ø x Breite

20 x 40 x 20	S	1	840,00
25 x 56 x 22	S	1	1150,00
30 x 63 x 22	S	1	1650,00
35 x 70 x 22	S	1	1840,00
40 x 80 x 28	S	1	3150,00
45 x 80 x 28	S	1	3150,00
50 x 90 x 28	S	1	3950,00
60 x 100 x 28	S	1	4950,00
70 x 110 x 32	S	1	6300,00
80 x 125 x 32	S	1	7800,00
90 x 125 x 32	S	1	7800,00
100 x 140 x 32	S	1	11300,00

Abmessungen VE Stück €/100/Obf.
DIN 00705.001

705

Stahl Form A

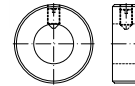

Stellringe, leichte Reihe, A = mit Gewindestift nach DIN 553/ISO 7434

ab Ø 75 mit Gewindestift DIN 914/ISO 4027

Maße → TI-111 REACH → TI-262

Rostfrei → S. 475



Innen- / Nenn Ø x Außen Ø x Breite

A 4 x 8 x 5	S	25	134,00
A 5 x 10 x 6	S	25	135,00
A 6 x 12 x 8	S	25	138,00
A 8 x 16 x 8	S	25	161,00
A 9 x 18 x 10	S	25	197,00
A 10 x 20 x 10	S	25	204,00
A 12 x 22 x 12	S	10	250,00
A 13 x 22 x 12	S	10	250,00
A 14 x 25 x 12	S	10	280,00
A 15 x 25 x 12	S	10	280,00
A 16 x 28 x 12	S	10	295,00
A 18 x 32 x 14	S	10	365,00
A 20 x 32 x 14	S	10	365,00
A 22 x 36 x 14	S	10	425,00
A 24 x 40 x 16	S	10	540,00
A 25 x 40 x 16	S	10	540,00
A 26 x 40 x 16	S	10	540,00
A 28 x 45 x 16	S	10	840,00
A 30 x 45 x 16	S	10	840,00
A 32 x 50 x 16	S	10	850,00
A 34 x 50 x 16	S	5	850,00
A 35 x 56 x 16	S	5	960,00
A 36 x 56 x 16	S	5	960,00
A 38 x 56 x 16	S	5	960,00
A 40 x 63 x 18	S	5	1230,00
A 42 x 63 x 18	S	5	1230,00
A 45 x 70 x 18	S	1	1460,00
A 50 x 80 x 18	S	1	1870,00
A 55 x 80 x 18	S	1	1870,00
A 60 x 90 x 20	S	1	2600,00
A 65 x 100 x 20	S	1	3250,00
A 70 x 100 x 20	S	1	3250,00
A 75 x 110 x 22	S	1	4300,00
A 80 x 110 x 22	S	1	4300,00
A 85 x 125 x 22	S	1	6700,00
A 90 x 125 x 22	S	1	6700,00
A 100 x 140 x 25	S	1	9500,00
A 110 x 160 x 25	S	1	12400,00
A 120 x 160 x 25	S	1	12400,00
A 125 x 180 x 28	S	1	17600,00
A 130 x 180 x 28	S	1	17600,00
A 140 x 200 x 28	S	1	26100,00

Abmessungen	VE Stück	€/100/Obf.
DIN	00705.011	
705	Stahl	Form A
	galvanisch verzinkt	

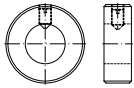

Stellringe, leichte Reihe, A = mit Gewindestift nach DIN 553/ISO 7434

ab \varnothing 75 mit Gewindestift DIN 914/ISO 4027

Maße \rightarrow **TI-111** REACH \rightarrow **TI-262**
 Korrosionsschutz \rightarrow **TI-228**
 Rostfrei \rightarrow **S. 475**



Innen- / Nenn \varnothing x Außen \varnothing x Breite

A 4	x	8	x	5	S	25	140,00 gal Zn
A 5	x	10	x	6	S	25	141,00 gal Zn
A 6	x	12	x	8	S	25	142,00 gal Zn
A 8	x	16	x	8	S	25	164,00 gal Zn
A 9	x	18	x	10	S	1	200,00 gal Zn
A 10	x	20	x	10	S	25	211,00 gal Zn
A 12	x	22	x	12	S	10	260,00 gal Zn
A 14	x	25	x	12	S	10	290,00 gal Zn
A 15	x	25	x	12	S	10	290,00 gal Zn
A 16	x	28	x	12	S	10	310,00 gal Zn
A 17	x	28	x	12	S	10	345,00 gal Zn
A 18	x	32	x	14	S	10	370,00 gal Zn
A 20	x	32	x	14	S	10	380,00 gal Zn
A 22	x	36	x	14	S	10	440,00 gal Zn
A 25	x	40	x	16	S	10	580,00 gal Zn
A 28	x	45	x	16	S	10	880,00 gal Zn
A 30	x	45	x	16	S	10	880,00 gal Zn
A 32	x	50	x	16	S	10	890,00 gal Zn
A 35	x	56	x	16	S	5	1010,00 gal Zn
A 36	x	56	x	16	S	5	1010,00 gal Zn
A 40	x	63	x	18	S	5	1300,00 gal Zn
A 42	x	63	x	18	S	5	1460,00 gal Zn
A 45	x	70	x	18	S	1	1540,00 gal Zn
A 50	x	80	x	18	S	1	1990,00 gal Zn
A 55	x	80	x	18	S	1	2240,00 gal Zn
A 60	x	90	x	20	S	1	2750,00 gal Zn
A 65	x	100	x	20	S	1	3300,00 gal Zn
A 70	x	100	x	20	S	1	3400,00 gal Zn
A 75	x	110	x	22	S	1	4000,00 gal Zn
A 80	x	110	x	22	S	1	4550,00 gal Zn
A 90	x	125	x	22	S	1	7400,00 gal Zn

Abmessungen	VE Stück	€/100/Obf.
DIN	00705.002	
705	Stahl	Form B

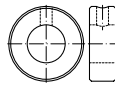

Stellringe, leichte Reihe, B = mit Bohrung für Kegelstift

Maße \rightarrow **TI-111** REACH \rightarrow **TI-262**



Innen- / Nenn \varnothing x Außen \varnothing x Breite

B 4	x	8	x	5	S	25	161,00
B 5	x	10	x	6	S	25	132,00
B 6	x	12	x	8	S	25	132,00
B 8	x	16	x	8	S	25	153,00
B 10	x	20	x	10	S	25	176,00
B 12	x	22	x	12	S	10	213,00
B 14	x	25	x	12	S	10	239,00
B 15	x	25	x	12	S	10	239,00
B 16	x	28	x	12	S	10	270,00
B 18	x	32	x	14	S	10	315,00
B 20	x	32	x	14	S	10	315,00
B 22	x	36	x	14	S	10	395,00
B 24	x	40	x	16	S	10	470,00
B 25	x	40	x	16	S	10	470,00
B 28	x	45	x	16	S	10	590,00
B 30	x	45	x	16	S	10	590,00
B 32	x	50	x	16	S	10	720,00
B 35	x	56	x	16	S	5	820,00
B 36	x	56	x	16	S	5	820,00
B 40	x	63	x	18	S	1	1150,00
B 45	x	70	x	18	S	1	1380,00
B 50	x	80	x	18	S	1	1810,00
B 55	x	80	x	18	S	1	1810,00
B 60	x	90	x	20	S	1	2550,00
B 65	x	100	x	20	S	1	3150,00
B 70	x	100	x	20	S	1	3150,00
B 80	x	110	x	22	S	1	4200,00
B 85	x	125	x	22	S	1	6600,00
B 90	x	125	x	22	S	1	6600,00
B 100	x	140	x	25	S	1	9400,00

Abmessungen	VE Stück	€/100/Obf.
~DIN	00741.010	
741	Stahl	
	galvanisch verzinkt	

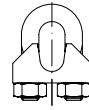

Drahtseilklemmen mit U-förmigem Klemmbügel

Kauschen \rightarrow DIN 6899

Maße \rightarrow **TI-133** Korrosionsschutz \rightarrow **TI-228**
 Rostfrei \rightarrow **S. 475**

Sicherheits-Drahtseilklemmen \rightarrow DIN 1142/EN 13411-5 auf Anfrage



für Seil \varnothing max./Gewinde \varnothing Klemmbügel

3	MM / M	4	S	100	47,50 gal Zn
5	MM / M	5	S	100	51,00 gal Zn
6,5	MM / M	5	S	100	54,00 gal Zn
8	MM / M	6	S	100	73,00 gal Zn
11	MM / M	8	S	20	186,00 gal Zn
13	MM / M	10	S	10	249,00 gal Zn
16	MM / M	12	S	10	330,00 gal Zn

DIN	00787.800
-----	-----------

787 8.8

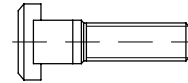

T-Nutenschrauben

Maße \rightarrow **TI-34** Anziehmomente \rightarrow **TI-244**
 Werkstoffeigensch. \rightarrow **TI-232**

T-Nutensteine \rightarrow DIN 508



8	M	8	x	32	S	25	2290,00
8	M	8	x	40	S	25	2490,00
8	M	8	x	50	S	25	2550,00
10	M	10	x	40	S	25	2320,00
10	M	10	x	50	S	25	2420,00
10	M	10	x	65	S	25	2490,00
12	M	12	x	40	S	10	1610,00
12	M	12	x	50	S	10	1640,00
12	M	12	x	65	S	10	1750,00
12	M	12	x	80	S	10	2650,00
12	M	12	x	100	S	10	2850,00
12	M	12	x	125	S	10	3000,00
18	M	16	x	63	S	10	2110,00
16	M	16	x	80	S	10	2220,00
16	M	16	x	100	S	10	2350,00
18	M	16	x	100	S	10	2220,00
16	M	16	x	125	S	10	2700,00
16	M	16	x	160	S	10	2750,00
20	M	20	x	80	S	5	3100,00
20	M	20	x	100	S	5	3250,00
20	M	20	x	125	S	5	3400,00
20	M	20	x	160	S	5	3600,00

- ✓ Große Artikelvielfalt
- ✓ Verlässliche Qualität
- ✓ Hohe Lieferbereitschaft

Abmessungen	VE	Stück	€/100/Obf.
20 M 20 x 200	S	5	4200,00
20 M 20 x 250	S	5	7600,00
28 M 24 x 100	S	5	7200,00
24 M 24 x 160	S	5	8500,00
28 M 24 x 160	S	5	8500,00

DIN 00835.500

835

5.8

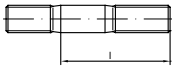

Stiftschrauben, Einschraubende ≈ 2 d

Maße → [TI-18](#) REACH → [TI-262](#)
Werkstoffeigensch. → [TI-232](#)

Rostfrei → [S. 476](#)



M 6 x 16	S	100	49,50
M 6 x 18	S	100	53,00
M 6 x 20	S	100	56,00
M 6 x 25	S	100	57,00
M 6 x 30	S	100	59,00
M 6 x 35	S	100	63,00
M 6 x 40	S	100	67,00
M 6 x 45	S	100	68,00
M 6 x 70	S	100	83,00
M 6 x 100	S	100	111,00
M 8 x 18	S	100	141,00
M 8 x 20	S	100	141,00
M 8 x 25	S	100	163,00
M 8 x 30	S	100	128,00
M 8 x 35	S	100	134,00
M 8 x 40	S	100	141,00
M 8 x 45	S	100	147,00
M 8 x 50	S	100	154,00
M 8 x 60	S	100	167,00
M 8 x 65	S	100	180,00
M 8 x 70	S	100	181,00
M 8 x 80	S	100	189,00
M 8 x 90	S	100	206,00
M 10 x 20	S	100	138,00
M 10 x 25	S	100	176,00
M 10 x 30	S	100	180,00
M 10 x 35	S	100	182,00
M 10 x 40	S	100	183,00
M 10 x 45	S	100	187,00
M 10 x 50	S	100	195,00
M 10 x 60	S	50	213,00
M 10 x 70	S	50	236,00
M 10 x 100	S	50	295,00
M 12 x 25	S	50	181,00
M 12 x 30	S	50	203,00
M 12 x 35	S	50	206,00
M 12 x 40	S	50	215,00
M 12 x 45	S	50	227,00
M 12 x 50	S	50	241,00
M 12 x 55	S	50	255,00
M 12 x 60	S	50	265,00
M 12 x 80	S	25	325,00
M 16 x 35	S	25	275,00
M 16 x 40	S	25	295,00
M 16 x 50	S	25	330,00
M 16 x 55	S	25	345,00
M 16 x 60	S	25	365,00

Abmessungen	VE	Stück	€/100/Obf.
M 16 x 65	S	25	385,00
M 16 x 80	S	25	440,00
M 16 x 100	S	25	510,00

DIN 00835.800

835

8.8

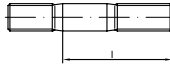

Stiftschrauben, Einschraubende ≈ 2 d

Maße → [TI-18](#) Anziehmomente → [TI-244](#)
Werkstoffeigensch. → [TI-232](#)

Rostfrei → [S. 476](#)

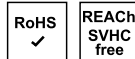

M 8 x 16	S	100	115,00
M 8 x 18	S	100	115,00
M 8 x 20	S	100	177,00
M 8 x 25	S	100	204,00
M 8 x 30	S	100	220,00
M 8 x 35	S	100	234,00
M 8 x 40	S	100	250,00
M 10 x 25	S	100	222,00
M 10 x 30	S	100	226,00
M 10 x 35	S	100	230,00
M 10 x 40	S	50	234,00
M 10 x 50	S	50	249,00
M 10 x 55	S	50	255,00
M 10 x 60	S	50	295,00
M 12 x 35	S	50	260,00
M 12 x 40	S	50	275,00
M 12 x 45	S	50	295,00

DIN 00906.500

906

Stahl

keg.-Fein

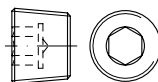

Verschlusschrauben mit Innensechskant, mit kegeligem Feingewinde

Maße → [TI-22](#) REACH → [TI-262](#)

Rostfrei → [S. 476](#)
Messing → [S. 624](#)



M 8 x 1	S	100	62,00
M 10 x 1	S	100	63,00
M 12 x 1,5	S	50	82,00
M 14 x 1,5	S	50	97,00
M 16 x 1,5	S	50	105,00
M 18 x 1,5	S	25	126,00
M 20 x 1,5	S	25	163,00
M 22 x 1,5	S	25	176,00
M 24 x 1,5	S	25	180,00
M 26 x 1,5	S	25	270,00

Abmessungen	VE	Stück	€/100/Obf.
M 27 x 2	S	10	365,00
M 30 x 1,5	S	10	380,00
M 30 x 2	S	10	430,00
M 33 x 2	S	10	540,00
M 36 x 1,5	S	10	720,00
M 36 x 2	S	10	720,00
M 38 x 1,5	S	10	890,00
M 42 x 1,5	S	10	1060,00

DIN 00906.510

906

Stahl

keg.-Fein

galvanisch verzinkt

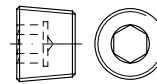

Verschlusschrauben mit Innensechskant, mit kegeligem Feingewinde

Maße → [TI-22](#) REACH → [TI-262](#)
Korrosionsschutz → [TI-228](#)

Rostfrei → [S. 476](#)
Messing → [S. 624](#)



M 8 x 1	S	100	74,00 gal Zn
M 10 x 1	S	100	77,00 gal Zn
M 12 x 1,5	S	50	97,00 gal Zn
M 16 x 1,5	S	50	125,00 gal Zn
M 20 x 1,5	S	25	187,00 gal Zn
M 24 x 1,5	S	25	210,00 gal Zn
M 30 x 1,5	S	10	410,00 gal Zn
M 33 x 2	S	10	570,00 gal Zn

DIN 00906.504

906

Stahl

keg.-Rohr R

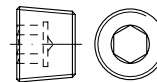

Verschlusschrauben mit Innensechskant, R = mit kegeligem Rohrgewinde

Maße → [TI-22](#) REACH → [TI-262](#)

Rostfrei → [S. 476](#)
Messing → [S. 624](#)



R 1/8	S	100	63,00
R 1/4	S	100	85,00
R 3/8	S	50	108,00
R 1/2	S	50	147,00
R 3/4	S	25	265,00
R 1	S	25	365,00
R 1 1/4	S	10	970,00
R 1 1/2	S	1	1640,00
R 1 3/4	S	1	2360,00
R 2	S	1	3600,00

Abmessungen	VE Stück	€/100/Obf.
DIN	00906.514	
906	Stahl	keg.-Rohr R
	galvanisch verzinkt	

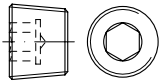

Verschlusschrauben mit Innensechskant, R = mit kegeligem Rohrgewinde

Maße → **TI-22** REACH → **TI-262**
 Korrosionsschutz → **TI-228**
 Rostfrei → **S. 476**
 Messing → **S. 624**



R 1/8	S 100	67,00 gal Zn
R 1/4	S 100	89,00 gal Zn
R 3/8	S 50	114,00 gal Zn
R 1/2	S 50	158,00 gal Zn
R 3/4	S 25	295,00 gal Zn
R 1	S 25	390,00 gal Zn

DIN	00908.500
908	Stahl zyl.-Fein

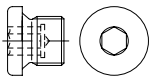

Verschlusschrauben mit Bund und Innensechskant, mit zylindrischem Feingewinde

Maße → **TI-22** REACH → **TI-262**
 Rostfrei → **S. 476**



M 8	x 1	S 100	63,00
M 10	x 1	S 100	63,00
M 12	x 1,5	S 50	102,00
M 14	x 1,5	S 50	134,00
M 16	x 1,5	S 50	175,00
M 18	x 1,5	S 25	184,00
M 20	x 1,5	S 25	223,00
M 22	x 1,5	S 25	255,00
M 24	x 1,5	S 25	290,00
M 26	x 1,5	S 25	365,00
M 27	x 2	S 10	415,00
M 30	x 1,5	S 10	460,00
M 30	x 2	S 10	560,00
M 33	x 2	S 10	620,00
M 36	x 1,5	S 10	790,00
M 36	x 2	S 10	790,00
M 38	x 1,5	S 10	960,00
M 42	x 1,5	S 1	1120,00
M 45	x 1,5	S 1	1610,00
M 48	x 1,5	S 1	1630,00
M 52	x 1,5	S 1	2110,00
M 52	x 2	S 1	2320,00
M 56	x 2	S 1	2950,00
M 64	x 2	S 1	3900,00

Abmessungen	VE Stück	€/100/Obf.
DIN	00908.510	
908	Stahl zyl.-Fein	
	galvanisch verzinkt	

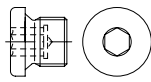

Verschlusschrauben mit Bund und Innensechskant, mit zylindrischem Feingewinde

Maße → **TI-22** REACH → **TI-262**
 Korrosionsschutz → **TI-228**
 Rostfrei → **S. 476**



M 8	x 1	S 100	67,00 gal Zn
M 10	x 1	S 100	67,00 gal Zn
M 12	x 1,5	S 50	108,00 gal Zn
M 14	x 1,5	S 50	142,00 gal Zn
M 16	x 1,5	S 50	186,00 gal Zn
M 18	x 1,5	S 100	192,00 gal Zn
M 20	x 1,5	S 25	275,00 gal Zn
M 22	x 1,5	S 25	305,00 gal Zn
M 24	x 1,5	S 25	400,00 gal Zn
M 26	x 1,5	S 25	480,00 gal Zn
M 30	x 1,5	S 10	510,00 gal Zn
M 36	x 1,5	S 10	1260,00 gal Zn
M 38	x 1,5	S 10	1570,00 gal Zn
M 42	x 1,5	S 5	2040,00 gal Zn

DIN	00908.504
908	Stahl zyl.-Rohr G

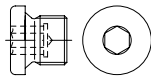

Verschlusschrauben mit Bund und Innensechskant, G = mit zylindrischem Rohrgewinde

Maße → **TI-22** REACH → **TI-262**
 Rostfrei → **S. 476**
 Messing → **S. 624**



G 1/8 A	S 100	92,00
G 1/4 A	S 100	132,00
G 3/8 A	S 50	157,00
G 1/2 A	S 50	223,00
G 3/4 A	S 25	340,00
G 1 A	S 25	590,00
G 1 1/8 A	S 10	1310,00
G 1 1/4 A	S 1	1410,00
G 1 1/2 A	S 1	1460,00
G 1 3/4 A	S 1	2230,00
G 2 A	S 1	2340,00

Abmessungen	VE Stück	€/100/Obf.
DIN	00908.514	
908	Stahl zyl.-Rohr G	
	galvanisch verzinkt	

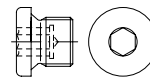

Verschlusschrauben mit Bund und Innensechskant, G = mit zylindrischem Rohrgewinde

Maße → **TI-22** REACH → **TI-262**
 Korrosionsschutz → **TI-228**
 Rostfrei → **S. 476**
 Messing → **S. 624**



G 1/8 A	S 100	97,00 gal Zn
G 1/4 A	S 100	141,00 gal Zn
G 3/8 A	S 50	167,00 gal Zn
G 1/2 A	S 50	246,00 gal Zn
G 3/4 A	S 25	385,00 gal Zn
G 1 A	S 25	660,00 gal Zn
G 1 1/4 A	S 1	1740,00 gal Zn
G 1 1/2 A	S 1	1910,00 gal Zn
G 2 A	S 1	3550,00 gal Zn

DIN	00909.500
909	Stahl keg.-Fein

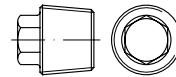

Verschlusschrauben mit Außensechskant, mit kegeligem Feingewinde

Maße → **TI-23** REACH → **TI-262**



M 16	x 1,5	S 50	265,00
M 18	x 1,5	S 25	305,00
M 24	x 1,5	S 25	385,00
M 30	x 1,5	S 10	760,00

Abmessungen VE Stück €/100/Obf.

DIN	00909.504
-----	-----------

909

Stahl

keg.-Rohr R

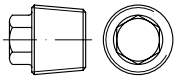

Verschlusschrauben mit Außensechskant, R = mit kegeligem Rohrgewinde

Maße → [TI-23](#)

REACH → [TI-262](#)



R 1/8	S	100	199,00
R 1/4	S	100	245,00
R 3/8	S	50	249,00
R 1/2	S	50	345,00
R 3/4	S	25	530,00
R 1	S	25	1230,00

DIN	00910.500
-----	-----------

910

Stahl

zyl.-Fein

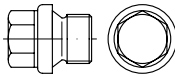

Verschlusschrauben mit Bund und Außensechskant, schwer, mit zylindrischem Feingewinde

Maße → [TI-23](#)

REACH → [TI-262](#)

Rostfrei → [S. 476](#)
Messing → [S. 624](#)



M 8	x	1	S	100	97,00
M 10	x	1	S	100	105,00
M 12	x	1,5	S	50	148,00
M 14	x	1,5	S	50	170,00
M 16	x	1,5	S	50	181,00
M 18	x	1,5	S	25	216,00
M 20	x	1,5	S	25	260,00
M 22	x	1,5	S	25	360,00
M 24	x	1,5	S	25	380,00
M 26	x	1,5	S	25	440,00
M 27	x	2	S	10	570,00
M 30	x	1,5	S	10	630,00
M 30	x	2	S	10	690,00
M 33	x	2	S	10	740,00
M 36	x	1,5	S	10	880,00
M 36	x	2	S	10	880,00
M 38	x	1,5	S	5	990,00
M 42	x	1,5	S	1	1370,00
M 42	x	2	S	1	1530,00
M 45	x	1,5	S	1	2110,00
M 45	x	2	S	1	1640,00
M 48	x	1,5	S	1	2110,00
M 48	x	2	S	1	2110,00

Abmessungen VE Stück €/100/Obf.

M 52	x	1,5	S	1	2340,00
M 56	x	2	S	1	2950,00
M 64	x	2	S	1	4250,00

DIN	00910.510
-----	-----------

910

Stahl

zyl.-Fein

galvanisch verzinkt

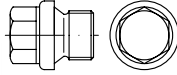

Verschlusschrauben mit Bund und Außensechskant, schwer, mit zylindrischem Feingewinde

Maße → [TI-23](#)

REACH → [TI-262](#)

Korrosionsschutz → [TI-228](#)

Rostfrei → [S. 476](#)
Messing → [S. 624](#)



M 10	x	1	S	100	111,00 gal Zn
M 12	x	1,5	S	50	158,00 gal Zn
M 14	x	1,5	S	50	180,00 gal Zn
M 16	x	1,5	S	50	197,00 gal Zn
M 18	x	1,5	S	25	240,00 gal Zn
M 20	x	1,5	S	25	290,00 gal Zn
M 22	x	1,5	S	25	395,00 gal Zn
M 24	x	1,5	S	25	420,00 gal Zn
M 26	x	1,5	S	25	480,00 gal Zn
M 27	x	2	S	10	860,00 gal Zn
M 30	x	1,5	S	10	680,00 gal Zn
M 30	x	2	S	10	1050,00 gal Zn
M 33	x	2	S	10	1110,00 gal Zn
M 36	x	1,5	S	10	1310,00 gal Zn
M 36	x	2	S	10	1310,00 gal Zn

DIN	00910.504
-----	-----------

910

Stahl

zyl.-Rohr G

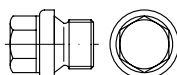

Verschlusschrauben mit Bund und Außensechskant, schwer, G = mit zylindrischem Rohrgewinde

Maße → [TI-23](#)

REACH → [TI-262](#)

Rostfrei → [S. 477](#)
Messing → [S. 624](#)

Ausführung mit Entlüftung und Dichtung
→ DIN 5586



G 1/8 A	S	100	99,00
G 1/4 A	S	100	141,00
G 3/8 A	S	50	182,00
G 1/2 A	S	50	223,00
G 5/8 A	S	25	370,00

Abmessungen VE Stück €/100/Obf.

G 3/4 A	S	25	470,00
G 7/8 A	S	25	880,00
G 1 A	S	25	610,00
G 1 1/8 A	S	1	1230,00
G 1 1/4 A	S	1	1430,00
G 1 1/2 A	S	1	1820,00
G 1 3/4 A	S	1	2550,00
G 2 A	S	1	2900,00

DIN	00910.514
-----	-----------

910

Stahl

zyl.-Rohr G

galvanisch verzinkt

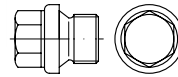

Verschlusschrauben mit Bund und Außensechskant, schwer, G = mit zylindrischem Rohrgewinde

Maße → [TI-23](#)

REACH → [TI-262](#)

Korrosionsschutz → [TI-228](#)

Rostfrei → [S. 477](#)
Messing → [S. 624](#)

Ausführung mit Entlüftung und Dichtung
→ DIN 5586



G 1/8 A	S	100	115,00 gal Zn
G 1/4 A	S	100	152,00 gal Zn
G 3/8 A	S	50	199,00 gal Zn
G 1/2 A	S	50	255,00 gal Zn
G 3/4 A	S	25	540,00 gal Zn
G 1 A	S	25	730,00 gal Zn
G 1 1/4 A	S	1	1600,00 gal Zn
G 1 1/2 A	S	1	2010,00 gal Zn
G 2 A	S	1	3300,00 gal Zn

DIN 911 Winkelschraubendreher



→ ISO 2936

Abmessungen	VE Stück	€/100/Obf.
DIN	00912.800	

912

8.8



Zylinderschrauben mit Innensechskant

Maße → **TI-12** Anziehungsmomente → **TI-244**
 Werkstoffeigensch. → **TI-232** Normumstellung → **TI-6**

Rostfrei → **S. 477**

DIN 912 → wird ersetzt durch ISO 4762

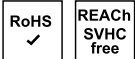

M 3	x	4	S	500	33,50
M 3	x	5	S	500	33,50
M 3	x	6	S	500	9,40
M 3	x	8	S	500	6,50
M 3	x	10	S	500	5,40
M 3	x	12	S	500	5,70
M 3	x	14	S	500	9,20
M 3	x	16	S	500	5,90
M 3	x	18	S	500	6,20
M 3	x	20	S	500	6,30
M 3	x	22	S	500	11,80
M 3	x	25	S	500	6,80
M 3	x	30	S	500	7,60
M 3	x	35	S	500	29,50
M 3	x	35	K	100	33,00
M 3	x	40	S	500	31,00
M 3	x	40	K	100	35,00
M 3	x	45	S	500	79,00
M 3	x	45	K	100	83,00
M 3	x	50	S	500	88,00
M 3	x	50	K	100	91,00
M 4	x	4	S	500	105,00
M 4	x	5	S	500	19,50
M 4	x	5	K	100	23,20
M 4	x	6	S	500	11,20
M 4	x	6	K	100	14,90
M 4	x	8	S	500	6,60
M 4	x	8	K	100	10,20
M 4	x	10	S	500	4,85
M 4	x	10	K	100	8,60
M 4	x	12	S	500	5,30
M 4	x	12	K	100	8,90
M 4	x	14	S	500	8,30
M 4	x	16	S	500	5,00
M 4	x	16	K	100	8,70
M 4	x	18	S	500	5,30
M 4	x	18	K	100	8,90
M 4	x	20	S	500	5,40
M 4	x	20	K	100	9,10
M 4	x	22	S	500	10,20
M 4	x	25	S	500	6,00
M 4	x	25	K	100	9,70
M 4	x	28	S	500	11,80
M 4	x	30	S	500	6,60
M 4	x	30	K	100	10,30
M 4	x	35	S	500	7,90
M 4	x	35	K	100	11,60
M 4	x	40	S	500	8,30
M 4	x	40	K	100	12,00
M 4	x	45	S	500	18,00
M 4	x	45	K	100	21,60
M 4	x	50	S	500	19,90
M 4	x	50	K	100	23,60
M 4	x	55	S	200	23,90

M 4	x	55	K	100	27,50
M 4	x	60	S	200	23,90
M 4	x	60	K	100	27,50
M 4	x	65	S	200	37,50
M 4	x	65	K	100	41,00
M 4	x	70	S	200	37,50
M 4	x	70	K	100	41,00
M 4	x	75	S	200	68,00
M 4	x	80	S	200	78,00
M 4	x	85	S	200	300,00
M 4	x	90	S	200	330,00
M 4	x	95	S	200	365,00
M 4	x	100	S	200	390,00
M 4	x	110	S	200	420,00
M 4	x	120	S	200	480,00
M 5	x	5	S	500	107,00
M 5	x	6	S	500	11,80
M 5	x	6	K	100	15,50
M 5	x	8	S	500	9,20
M 5	x	8	K	100	12,80
M 5	x	10	S	500	4,75
M 5	x	10	K	100	8,40
M 5	x	12	S	500	4,85
M 5	x	12	K	100	8,60
M 5	x	14	S	500	8,30
M 5	x	16	S	500	4,75
M 5	x	16	K	100	8,40
M 5	x	18	S	500	5,10
M 5	x	18	K	100	8,80
M 5	x	20	S	500	5,30
M 5	x	20	K	100	8,90
M 5	x	22	S	500	9,40
M 5	x	25	S	500	5,40
M 5	x	25	K	100	9,10
M 5	x	30	S	500	6,60
M 5	x	30	K	100	10,30
M 5	x	35	S	200	7,10
M 5	x	40	S	200	7,60
M 5	x	45	S	200	12,90
M 5	x	50	S	200	18,40
M 5	x	55	S	200	22,70
M 5	x	60	S	200	24,20
M 5	x	65	S	200	34,50
M 5	x	70	S	200	35,50
M 5	x	75	S	200	44,50
M 5	x	80	S	200	47,00
M 5	x	85	S	200	65,00
M 5	x	90	S	200	60,00
M 5	x	95	S	200	77,00
M 5	x	100	S	200	64,00
M 5	x	105	S	100	165,00
M 5	x	110	S	200	72,00
M 5	x	115	S	100	195,00
M 5	x	120	S	100	79,00
M 5	x	125	S	100	335,00
M 5	x	130	S	100	305,00
M 5	x	135	S	100	365,00
M 5	x	140	S	100	510,00
M 5	x	145	S	100	680,00
M 5	x	150	S	100	660,00
M 5	x	155	S	100	690,00
M 5	x	160	S	100	670,00
M 5	x	165	S	100	720,00
M 5	x	170	S	100	710,00
M 5	x	175	S	100	760,00
M 5	x	180	S	100	740,00
M 5	x	185	S	100	910,00
M 5	x	190	S	100	910,00
M 5	x	195	S	100	990,00
M 5	x	200	S	100	970,00
M 5	x	210	S	100	1150,00
M 5	x	220	S	100	1180,00
M 6	x	6	S	500	31,00
M 6	x	8	S	500	10,40
M 6	x	8	K	100	14,10

M 6	x	10	S	500	5,00
M 6	x	10	K	100	8,70
M 6	x	12	S	500	5,30
M 6	x	12	K	100	8,90
M 6	x	14	S	500	7,70
M 6	x	16	S	500	4,85
M 6	x	16	K	100	8,60
M 6	x	18	S	500	5,30
M 6	x	18	K	100	8,90
M 6	x	20	S	500	5,30
M 6	x	20	K	100	8,90
M 6	x	22	S	500	9,40
M 6	x	22	K	100	13,10
M 6	x	25	S	500	5,40
M 6	x	25	K	100	9,10
M 6	x	28	S	500	14,60
M 6	x	30	S	500	6,30
M 6	x	30	K	100	9,90
M 6	x	35	S	200	6,80
M 6	x	40	S	200	7,60
M 6	x	45	S	200	9,90
M 6	x	50	S	200	10,30
M 6	x	55	S	200	16,40
M 6	x	60	S	200	17,50
M 6	x	65	S	200	23,60
M 6	x	70	S	200	24,20
M 6	x	75	S	200	34,00
M 6	x	80	S	200	34,50
M 6	x	85	S	200	45,50
M 6	x	90	S	200	41,00
M 6	x	95	S	200	107,00
M 6	x	100	S	200	48,00
M 6	x	105	S	100	107,00
M 6	x	110	S	100	70,00
M 6	x	115	S	100	135,00
M 6	x	120	S	100	81,00
M 6	x	125	S	100	184,00
M 6	x	130	S	100	130,00
M 6	x	135	S	100	206,00
M 6	x	140	S	100	176,00
M 6	x	145	S	100	400,00
M 6	x	150	S	100	209,00
M 6	x	155	S	100	520,00
M 6	x	160	S	100	590,00
M 6	x	165	S	100	620,00
M 6	x	170	S	100	710,00
M 6	x	175	S	100	800,00
M 6	x	180	S	100	800,00
M 6	x	185	S	100	970,00
M 6	x	190	S	100	970,00
M 6	x	195	S	100	1060,00
M 6	x	200	S	100	1060,00
M 6	x	210	S	100	1120,00
M 6	x	220	S	100	1180,00
M 6	x	230	S	100	1270,00
M 6	x	240	S	100	1270,00
M 6	x	250	S	100	1330,00
M 6	x	280	S	100	1430,00
M 6	x	300	S	100	1590,00
M 8	x	8	S	200	27,50
M 8	x	10	S	200	12,30
M 8	x	12	S	200	12,80
M 8	x	14	S	200	12,90
M 8	x	16	S	200	7,90
M 8	x	18	S	200	8,40
M 8	x	20	S	200	8,00
M 8	x	22	S	200	14,30
M 8	x	25	S	200	8,80
M 8	x	30	S	200	9,20
M 8	x	35	S	200	10,50
M 8	x	40	S	200	11,90
M 8	x	45	S	200	12,60
M 8	x	50	S	200	13,00
M 8	x	55	S	200	15,30
M 8	x	60	S	200	17,00

Abmessungen	VE	Stück	€/100/Obf.	Abmessungen	VE	Stück	€/100/Obf.	Abmessungen	VE	Stück	€/100/Obf.
M 8 x 65	S	200	24,70	M 10 x 220	S	50	650,00	M 14 x 70	S	50	124,00
M 8 x 70	S	200	25,50	M 10 x 230	S	50	670,00	M 14 x 75	S	50	137,00
M 8 x 75	S	200	31,50	M 10 x 240	S	50	670,00	M 14 x 80	S	50	143,00
M 8 x 80	S	200	40,50	M 10 x 250	S	50	830,00	M 14 x 85	S	50	154,00
M 8 x 85	S	100	60,00	M 10 x 260	S	50	800,00	M 14 x 90	S	50	154,00
M 8 x 90	S	100	50,00	M 10 x 270	S	50	880,00	M 14 x 95	S	50	182,00
M 8 x 95	S	100	83,00	M 10 x 280	S	50	880,00	M 14 x 100	S	50	170,00
M 8 x 100	S	100	56,00	M 10 x 290	S	50	960,00	M 14 x 110	S	50	204,00
M 8 x 105	S	100	83,00	M 10 x 300	S	50	960,00	M 14 x 120	S	50	223,00
M 8 x 110	S	100	66,00	M 10 x 320	S	50	1280,00	M 14 x 130	S	50	255,00
M 8 x 115	S	100	129,00	M 10 x 340	S	50	1440,00	M 14 x 140	S	25	265,00
M 8 x 120	S	100	78,00	M 12 x 14	S	100	137,00	M 14 x 150	S	25	345,00
M 8 x 125	S	100	164,00	M 12 x 16	S	100	29,00	M 14 x 160	S	25	600,00
M 8 x 130	S	100	102,00	M 12 x 18	S	100	50,00	M 14 x 170	S	25	630,00
M 8 x 135	S	100	174,00	M 12 x 20	S	100	27,00	M 14 x 180	S	25	660,00
M 8 x 140	S	100	114,00	M 12 x 22	S	100	46,00	M 14 x 190	S	25	680,00
M 8 x 145	S	100	300,00	M 12 x 25	S	100	23,50	M 14 x 200	S	25	700,00
M 8 x 150	S	100	192,00	M 12 x 30	S	100	23,40	M 14 x 210	S	25	1060,00
M 8 x 155	S	100	330,00	M 12 x 35	S	100	24,70	M 14 x 220	S	25	850,00
M 8 x 160	S	100	242,00	M 12 x 40	S	100	27,00	M 14 x 230	S	25	1100,00
M 8 x 165	S	100	355,00	M 12 x 45	S	100	29,00	M 14 x 240	S	25	880,00
M 8 x 170	S	100	375,00	M 12 x 50	S	100	29,50	M 14 x 250	S	25	1160,00
M 8 x 180	S	100	335,00	M 12 x 55	S	100	33,50	M 14 x 260	S	25	920,00
M 8 x 190	S	100	440,00	M 12 x 60	S	100	35,00	M 14 x 270	S	25	1220,00
M 8 x 200	S	100	355,00	M 12 x 65	S	50	39,00	M 14 x 280	S	25	970,00
M 8 x 210	S	100	490,00	M 12 x 70	S	50	40,00	M 14 x 290	S	25	1410,00
M 8 x 220	S	100	510,00	M 12 x 75	S	50	42,00	M 14 x 300	S	25	1040,00
M 8 x 230	S	100	550,00	M 12 x 80	S	50	45,00	M 16 x 16	S	50	325,00
M 8 x 240	S	100	590,00	M 12 x 85	S	50	94,00	M 16 x 18	S	50	325,00
M 8 x 250	S	100	610,00	M 12 x 90	S	50	53,00	M 16 x 20	S	50	99,00
M 8 x 260	S	100	650,00	M 12 x 95	S	50	147,00	M 16 x 25	S	50	73,00
M 8 x 270	S	100	670,00	M 12 x 100	S	50	66,00	M 16 x 30	S	50	46,50
M 8 x 280	S	100	690,00	M 12 x 105	S	50	158,00	M 16 x 35	S	50	47,00
M 8 x 300	S	100	730,00	M 12 x 110	S	50	75,00	M 16 x 40	S	50	51,00
M 10 x 10	S	200	104,00	M 12 x 115	S	50	174,00	M 16 x 45	S	50	54,00
M 10 x 12	S	200	45,50	M 12 x 120	S	50	88,00	M 16 x 50	S	50	58,00
M 10 x 14	S	200	35,50	M 12 x 125	S	50	195,00	M 16 x 55	S	50	62,00
M 10 x 16	S	200	23,20	M 12 x 130	S	50	125,00	M 16 x 60	S	50	66,00
M 10 x 18	S	200	47,50	M 12 x 135	S	50	215,00	M 16 x 65	S	25	75,00
M 10 x 20	S	200	14,50	M 12 x 140	S	50	148,00	M 16 x 70	S	25	78,00
M 10 x 22	S	200	28,50	M 12 x 145	S	50	241,00	M 16 x 75	S	25	83,00
M 10 x 25	S	200	14,90	M 12 x 150	S	50	190,00	M 16 x 80	S	25	85,00
M 10 x 28	S	200	32,50	M 12 x 155	S	50	260,00	M 16 x 85	S	25	216,00
M 10 x 30	S	200	16,10	M 12 x 160	S	50	229,00	M 16 x 90	S	25	101,00
M 10 x 35	S	100	17,50	M 12 x 165	S	50	380,00	M 16 x 95	S	25	171,00
M 10 x 40	S	100	18,60	M 12 x 170	S	50	310,00	M 16 x 100	S	25	111,00
M 10 x 45	S	100	20,50	M 12 x 180	S	50	310,00	M 16 x 110	S	25	146,00
M 10 x 50	S	100	21,80	M 12 x 190	S	50	360,00	M 16 x 120	S	25	160,00
M 10 x 55	S	100	23,60	M 12 x 200	S	50	360,00	M 16 x 130	S	25	183,00
M 10 x 60	S	100	25,50	M 12 x 210	S	25	920,00	M 16 x 140	S	25	236,00
M 10 x 65	S	100	27,50	M 12 x 220	S	25	670,00	M 16 x 150	S	25	305,00
M 10 x 70	S	100	28,50	M 12 x 230	S	25	990,00	M 16 x 160	S	25	320,00
M 10 x 75	S	100	35,00	M 12 x 240	S	25	750,00	M 16 x 170	S	25	420,00
M 10 x 80	S	100	36,00	M 12 x 250	S	25	1070,00	M 16 x 180	S	25	375,00
M 10 x 85	S	100	71,00	M 12 x 260	S	25	820,00	M 16 x 190	S	25	600,00
M 10 x 90	S	100	47,50	M 12 x 270	S	25	1140,00	M 16 x 200	S	25	450,00
M 10 x 95	S	100	124,00	M 12 x 280	S	25	880,00	M 16 x 210	S	25	720,00
M 10 x 100	S	100	52,00	M 12 x 290	S	25	1370,00	M 16 x 220	S	25	540,00
M 10 x 105	S	100	136,00	M 12 x 300	S	25	950,00	M 16 x 230	S	25	810,00
M 10 x 110	S	100	60,00	M 12 x 310	S	25	1190,00	M 16 x 240	S	25	690,00
M 10 x 115	S	100	147,00	M 12 x 320	S	25	1190,00	M 16 x 250	S	25	750,00
M 10 x 120	S	50	73,00	M 12 x 340	S	25	1410,00	M 16 x 260	S	25	750,00
M 10 x 125	S	50	166,00	M 12 x 360	S	25	1990,00	M 16 x 270	S	25	960,00
M 10 x 130	S	50	108,00	M 12 x 380	S	25	2120,00	M 16 x 280	S	25	810,00
M 10 x 135	S	50	204,00	M 12 x 400	S	25	2210,00	M 16 x 290	S	25	980,00
M 10 x 140	S	50	131,00	M 14 x 20	S	100	111,00	M 16 x 300	S	25	950,00
M 10 x 150	S	50	180,00	M 14 x 25	S	100	82,00	M 16 x 310	S	10	1750,00
M 10 x 155	S	50	285,00	M 14 x 30	S	100	74,00	M 16 x 320	S	10	1600,00
M 10 x 160	S	50	197,00	M 14 x 35	S	100	85,00	M 16 x 330	S	10	2050,00
M 10 x 170	S	50	325,00	M 14 x 40	S	100	76,00	M 16 x 340	S	10	1880,00
M 10 x 180	S	50	300,00	M 14 x 45	S	50	86,00	M 16 x 350	S	10	2440,00
M 10 x 185	S	50	440,00	M 14 x 50	S	50	85,00	M 16 x 360	S	10	2220,00
M 10 x 190	S	50	355,00	M 14 x 55	S	50	106,00	M 16 x 370	S	10	2750,00
M 10 x 200	S	50	330,00	M 14 x 60	S	50	97,00	M 16 x 380	S	10	2480,00
M 10 x 210	S	50	650,00	M 14 x 65	S	50	123,00	M 16 x 390	S	10	2950,00

Abmessungen	VE	Stück	€/100/Obf.	Abmessungen	VE	Stück	€/100/Obf.	Abmessungen	VE	Stück	€/100/Obf.
M 16 x 400	S	10	2650,00	M 20 x 220	S	1	870,00	M 24 x 100	S	10	395,00
M 16 x 410	S	10	3200,00	M 20 x 230	S	1	1020,00	M 24 x 105	S	10	1060,00
M 16 x 420	S	10	2950,00	M 20 x 240	S	1	1020,00	M 24 x 110	S	10	460,00
M 16 x 440	S	10	3100,00	M 20 x 250	S	1	1080,00	M 24 x 120	S	10	495,00
M 16 x 460	S	10	3400,00	M 20 x 260	S	1	1080,00	M 24 x 125	S	10	1060,00
M 16 x 480	S	10	3550,00	M 20 x 270	S	1	1220,00	M 24 x 130	S	1	570,00
M 16 x 500	S	10	4250,00	M 20 x 280	S	1	1220,00	M 24 x 140	S	1	730,00
M 16 x 520	S	10	4450,00	M 20 x 290	S	1	1330,00	M 24 x 150	S	1	910,00
M 16 x 540	S	10	4700,00	M 20 x 300	S	1	1330,00	M 24 x 160	S	1	800,00
M 16 x 560	S	10	5100,00	M 20 x 310	S	1	1520,00	M 24 x 170	S	1	860,00
M 16 x 580	S	10	5300,00	M 20 x 320	S	1	1160,00	M 24 x 180	S	1	890,00
M 16 x 600	S	10	5700,00	M 20 x 330	S	1	1490,00	M 24 x 190	S	1	950,00
M 18 x 30	S	50	242,00	M 20 x 340	S	1	1510,00	M 24 x 200	S	1	970,00
M 18 x 35	S	50	242,00	M 20 x 350	S	1	1770,00	M 24 x 210	S	1	1660,00
M 18 x 40	S	50	212,00	M 20 x 360	S	1	1610,00	M 24 x 220	S	1	1330,00
M 18 x 45	S	50	226,00	M 20 x 370	S	1	2050,00	M 24 x 230	S	1	1760,00
M 18 x 50	S	50	230,00	M 20 x 380	S	1	1860,00	M 24 x 240	S	1	1420,00
M 18 x 55	S	25	239,00	M 20 x 390	S	1	2400,00	M 24 x 250	S	1	1870,00
M 18 x 60	S	25	244,00	M 20 x 400	S	1	2180,00	M 24 x 260	S	1	1500,00
M 18 x 65	S	25	270,00	M 20 x 410	S	1	2250,00	M 24 x 270	S	1	2010,00
M 18 x 70	S	25	280,00	M 20 x 420	S	1	2250,00	M 24 x 280	S	1	1610,00
M 18 x 75	S	25	290,00	M 20 x 440	S	1	2410,00	M 24 x 290	S	1	2190,00
M 18 x 80	S	25	295,00	M 20 x 450	S	1	2850,00	M 24 x 300	S	1	1750,00
M 18 x 85	S	25	320,00	M 20 x 460	S	1	2600,00	M 24 x 310	S	1	3000,00
M 18 x 90	S	25	320,00	M 20 x 480	S	1	2750,00	M 24 x 320	S	1	2600,00
M 18 x 100	S	25	355,00	M 20 x 500	S	1	2900,00	M 24 x 330	S	1	3050,00
M 18 x 110	S	25	465,00	M 20 x 520	S	1	3850,00	M 24 x 340	S	1	2650,00
M 18 x 120	S	25	510,00	M 20 x 540	S	1	4000,00	M 24 x 350	S	1	3100,00
M 18 x 130	S	25	540,00	M 20 x 560	S	1	4150,00	M 24 x 360	S	1	3000,00
M 18 x 140	S	25	630,00	M 20 x 580	S	1	4350,00	M 24 x 370	S	1	3200,00
M 18 x 150	S	25	740,00	M 20 x 600	S	1	4600,00	M 24 x 380	S	1	3200,00
M 18 x 160	S	25	800,00	M 22 x 35	S	25	630,00	M 24 x 390	S	1	3400,00
M 18 x 170	S	25	840,00	M 22 x 40	S	25	630,00	M 24 x 400	S	1	3400,00
M 18 x 180	S	25	880,00	M 22 x 45	S	25	630,00	M 24 x 410	S	1	3650,00
M 18 x 190	S	25	920,00	M 22 x 50	S	25	790,00	M 24 x 420	S	1	2600,00
M 18 x 200	S	1	1090,00	M 22 x 55	S	25	790,00	M 24 x 430	S	1	3900,00
M 18 x 210	S	1	1420,00	M 22 x 60	S	25	790,00	M 24 x 440	S	1	3900,00
M 18 x 220	S	1	1160,00	M 22 x 65	S	25	820,00	M 24 x 450	S	1	4150,00
M 18 x 230	S	1	1590,00	M 22 x 70	S	25	820,00	M 24 x 460	S	1	4150,00
M 18 x 240	S	1	1220,00	M 22 x 75	S	25	850,00	M 24 x 470	S	1	4400,00
M 18 x 250	S	1	1700,00	M 22 x 80	S	25	850,00	M 24 x 480	S	1	4400,00
M 18 x 260	S	1	1300,00	M 22 x 85	S	25	850,00	M 24 x 490	S	1	4700,00
M 18 x 270	S	1	1820,00	M 22 x 90	S	25	910,00	M 24 x 500	S	1	4700,00
M 18 x 280	S	1	1390,00	M 22 x 100	S	10	930,00	M 24 x 520	S	1	6400,00
M 18 x 300	S	1	1490,00	M 22 x 110	S	1	950,00	M 24 x 530	S	1	6700,00
M 18 x 320	S	1	1860,00	M 22 x 120	S	1	970,00	M 24 x 540	S	1	6900,00
M 18 x 350	S	1	2600,00	M 22 x 130	S	1	1000,00	M 24 x 560	S	1	7200,00
M 20 x 20	S	25	400,00	M 22 x 140	S	1	1040,00	M 24 x 580	S	1	7500,00
M 20 x 25	S	25	400,00	M 22 x 150	S	1	1070,00	M 24 x 600	S	1	7700,00
M 20 x 30	S	25	184,00	M 22 x 160	S	1	1090,00	M 27 x 40	S	10	1550,00
M 20 x 35	S	25	184,00	M 22 x 170	S	1	1300,00	M 27 x 45	S	10	1550,00
M 20 x 40	S	25	105,00	M 22 x 180	S	1	1180,00	M 27 x 50	S	10	1080,00
M 20 x 45	S	25	109,00	M 22 x 190	S	1	1400,00	M 27 x 55	S	10	1080,00
M 20 x 50	S	25	112,00	M 22 x 200	S	1	1270,00	M 27 x 60	S	10	1080,00
M 20 x 55	S	25	119,00	M 22 x 210	S	1	1880,00	M 27 x 65	S	10	1120,00
M 20 x 60	S	25	119,00	M 22 x 220	S	1	1500,00	M 27 x 70	S	10	1120,00
M 20 x 65	S	25	131,00	M 22 x 240	S	1	1600,00	M 27 x 75	S	10	1170,00
M 20 x 70	S	25	131,00	M 22 x 250	S	1	2100,00	M 27 x 80	S	10	1170,00
M 20 x 75	S	25	138,00	M 22 x 260	S	1	1680,00	M 27 x 85	S	10	1220,00
M 20 x 80	S	25	140,00	M 22 x 280	S	1	1770,00	M 27 x 90	S	10	1220,00
M 20 x 85	S	25	1050,00	M 22 x 300	S	1	1890,00	M 27 x 100	S	10	1270,00
M 20 x 90	S	25	171,00	M 24 x 30	S	25	1250,00	M 27 x 110	S	10	1310,00
M 20 x 95	S	25	1100,00	M 24 x 35	S	25	1250,00	M 27 x 120	S	10	1440,00
M 20 x 100	S	25	182,00	M 24 x 40	S	25	720,00	M 27 x 130	S	1	1500,00
M 20 x 110	S	25	197,00	M 24 x 45	S	25	720,00	M 27 x 140	S	1	1560,00
M 20 x 120	S	25	212,00	M 24 x 50	S	25	260,00	M 27 x 150	S	1	1620,00
M 20 x 130	S	25	310,00	M 24 x 55	S	25	290,00	M 27 x 160	S	1	1660,00
M 20 x 140	S	25	455,00	M 24 x 60	S	25	290,00	M 27 x 170	S	1	1910,00
M 20 x 150	S	25	530,00	M 24 x 65	S	25	310,00	M 27 x 180	S	1	1780,00
M 20 x 160	S	10	530,00	M 24 x 70	S	25	310,00	M 27 x 190	S	1	2020,00
M 20 x 170	S	10	650,00	M 24 x 75	S	25	315,00	M 27 x 200	S	1	1860,00
M 20 x 180	S	10	650,00	M 24 x 80	S	25	315,00	M 27 x 210	S	1	2800,00
M 20 x 190	S	10	770,00	M 24 x 85	S	10	1060,00	M 27 x 220	S	1	2010,00
M 20 x 200	S	1	770,00	M 24 x 90	S	10	380,00	M 27 x 230	S	1	3000,00
M 20 x 210	S	1	870,00	M 24 x 95	S	10	1100,00	M 27 x 240	S	1	2170,00

Abmessungen	VE	Stück	€/100/Obf.	Abmessungen	VE	Stück	€/100/Obf.	Abmessungen	VE	Stück	€/100/Obf.
M 27 x 250	S	1	3200,00	M 33 x 180	S	1	2650,00	M 48 x 80	S	1	6600,00
M 27 x 260	S	1	2310,00	M 33 x 190	S	1	3800,00	M 48 x 90	S	1	6600,00
M 27 x 270	S	1	3450,00	M 33 x 200	S	1	2850,00	M 48 x 100	S	1	6600,00
M 27 x 280	S	1	2460,00	M 36 x 50	S	1	2120,00	M 48 x 110	S	1	7000,00
M 27 x 300	S	1	2650,00	M 36 x 55	S	1	2120,00	M 48 x 120	S	1	7300,00
M 27 x 320	S	1	5500,00	M 36 x 60	S	1	2120,00	M 48 x 130	S	1	7600,00
M 30 x 35	S	10	1990,00	M 36 x 65	S	1	2120,00	M 48 x 140	S	1	8000,00
M 30 x 40	S	10	1990,00	M 36 x 70	S	1	2080,00	M 48 x 150	S	1	8500,00
M 30 x 45	S	10	1990,00	M 36 x 75	S	1	2080,00	M 48 x 160	S	1	8900,00
M 30 x 50	S	10	1310,00	M 36 x 80	S	1	2080,00	M 48 x 170	S	1	9700,00
M 30 x 55	S	10	1310,00	M 36 x 85	S	1	2140,00	M 48 x 180	S	1	9700,00
M 30 x 60	S	10	1310,00	M 36 x 90	S	1	2140,00	M 48 x 190	S	1	10400,00
M 30 x 65	S	10	1340,00	M 36 x 95	S	1	2200,00	M 48 x 200	S	1	10400,00
M 30 x 70	S	10	1370,00	M 36 x 100	S	1	2200,00	M 48 x 210	S	1	13900,00
M 30 x 75	S	10	1430,00	M 36 x 110	S	1	2250,00	M 48 x 220	S	1	13900,00
M 30 x 80	S	10	1430,00	M 36 x 120	S	1	2360,00	M 48 x 240	S	1	15100,00
M 30 x 85	S	1	1480,00	M 36 x 130	S	1	2430,00	M 48 x 260	S	1	16300,00
M 30 x 90	S	1	1480,00	M 36 x 140	S	1	2550,00	M 48 x 270	S	1	25000,00
M 30 x 95	S	1	1480,00	M 36 x 150	S	1	2650,00	M 48 x 280	S	1	17400,00
M 30 x 100	S	1	1540,00	M 36 x 160	S	1	2700,00	M 48 x 300	S	1	18000,00
M 30 x 110	S	1	1590,00	M 36 x 170	S	1	3100,00	M 56 x 120	S	1	15800,00
M 30 x 120	S	1	1650,00	M 36 x 180	S	1	2950,00	M 56 x 130	S	1	17200,00
M 30 x 130	S	1	1710,00	M 36 x 190	S	1	3350,00	M 56 x 140	S	1	17900,00
M 30 x 140	S	1	1760,00	M 36 x 200	S	1	3150,00	M 56 x 150	S	1	19100,00
M 30 x 150	S	1	1850,00	M 36 x 210	S	1	3700,00	M 56 x 160	S	1	19900,00
M 30 x 160	S	1	1930,00	M 36 x 220	S	1	3350,00	M 56 x 180	S	1	20600,00
M 30 x 170	S	1	1990,00	M 36 x 230	S	1	3900,00	M 56 x 200	S	1	22000,00
M 30 x 180	S	1	2050,00	M 36 x 240	S	1	3500,00	M 56 x 210	S	1	24700,00
M 30 x 190	S	1	2130,00	M 36 x 250	S	1	4100,00	M 56 x 220	S	1	22400,00
M 30 x 200	S	1	2220,00	M 36 x 260	S	1	3700,00	M 56 x 230	S	1	26000,00
M 30 x 210	S	1	2390,00	M 36 x 270	S	1	4350,00	M 56 x 260	S	1	24400,00
M 30 x 220	S	1	2390,00	M 36 x 280	S	1	3950,00	M 56 x 280	S	1	25700,00
M 30 x 230	S	1	2500,00	M 36 x 290	S	1	4750,00	M 56 x 300	S	1	27700,00
M 30 x 240	S	1	2500,00	M 36 x 300	S	1	4300,00				
M 30 x 250	S	1	2650,00	M 36 x 310	S	1	6400,00				
M 30 x 260	S	1	2650,00	M 36 x 320	S	1	5800,00				
M 30 x 270	S	1	2800,00	M 36 x 330	S	1	6900,00				
M 30 x 280	S	1	2800,00	M 36 x 340	S	1	6300,00				
M 30 x 290	S	1	3800,00	M 36 x 350	S	1	7600,00				
M 30 x 300	S	1	3000,00	M 36 x 360	S	1	6900,00				
M 30 x 310	S	1	3800,00	M 36 x 370	S	1	9400,00				
M 30 x 320	S	1	3400,00	M 36 x 380	S	1	8500,00				
M 30 x 330	S	1	3850,00	M 36 x 390	S	1	9900,00				
M 30 x 340	S	1	3600,00	M 36 x 400	S	1	9000,00				
M 30 x 350	S	1	3850,00	M 36 x 420	S	1	17500,00				
M 30 x 360	S	1	4000,00	M 36 x 430	S	1	17800,00				
M 30 x 370	S	1	5400,00	M 36 x 440	S	1	17800,00				
M 30 x 380	S	1	5400,00	M 36 x 500	S	1	18800,00				
M 30 x 390	S	1	5900,00	M 36 x 560	S	1	19800,00				
M 30 x 400	S	1	5900,00	M 36 x 600	S	1	20500,00				
M 30 x 420	S	1	5900,00	M 42 x 70	S	1	3600,00				
M 30 x 430	S	1	5900,00	M 42 x 80	S	1	3600,00				
M 30 x 440	S	1	6400,00	M 42 x 90	S	1	3600,00				
M 30 x 450	S	1	6400,00	M 42 x 100	S	1	3700,00				
M 30 x 460	S	1	7500,00	M 42 x 110	S	1	3700,00				
M 30 x 470	S	1	7900,00	M 42 x 120	S	1	3900,00				
M 30 x 480	S	1	7900,00	M 42 x 130	S	1	4050,00				
M 30 x 490	S	1	8400,00	M 42 x 140	S	1	4000,00				
M 30 x 500	S	1	8400,00	M 42 x 150	S	1	4500,00				
M 30 x 540	S	1	15500,00	M 42 x 160	S	1	4200,00				
M 30 x 700	S	1	18400,00	M 42 x 170	S	1	4850,00				
M 33 x 50	S	1	3900,00	M 42 x 180	S	1	4450,00				
M 33 x 55	S	1	3900,00	M 42 x 190	S	1	5400,00				
M 33 x 60	S	1	1600,00	M 42 x 200	S	1	5100,00				
M 33 x 65	S	1	1600,00	M 42 x 210	S	1	5800,00				
M 33 x 70	S	1	1600,00	M 42 x 220	S	1	5800,00				
M 33 x 80	S	1	1600,00	M 42 x 240	S	1	9600,00				
M 33 x 90	S	1	1690,00	M 42 x 260	S	1	10300,00				
M 33 x 100	S	1	1820,00	M 42 x 270	S	1	20200,00				
M 33 x 110	S	1	1900,00	M 42 x 280	S	1	10900,00				
M 33 x 120	S	1	2040,00	M 42 x 300	S	1	11800,00				
M 33 x 130	S	1	2110,00	M 42 x 350	S	1	22600,00				
M 33 x 140	S	1	2230,00	M 42 x 400	S	1	23900,00				
M 33 x 150	S	1	2360,00	M 42 x 500	S	1	27100,00				
M 33 x 160	S	1	2410,00	M 42 x 560	S	1	28900,00				

DIN	00912.810
912	8.8 galvanisch verzinkt

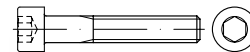

Zylinderschrauben mit Innensechskant

Maße → TI-12 Anziehmomente → TI-244
 Werkstoffeigensch. → TI-232 Normumstellung → TI-6
 Korrosionsschutz → TI-228

Rostfrei → S. 477

DIN 912 → wird ersetzt durch ISO 4762



M 3 x 4	S	500	33,50 gal Zn
M 3 x 5	S	500	33,50 gal Zn
M 3 x 6	S	500	9,40 gal Zn
M 3 x 8	S	500	6,60 gal Zn
M 3 x 10	S	500	5,60 gal Zn
M 3 x 12	S	500	5,80 gal Zn
M 3 x 14	S	500	9,40 gal Zn
M 3 x 16	S	500	6,20 gal Zn
M 3 x 18	S	500	6,30 gal Zn
M 3 x 20	S	500	6,60 gal Zn
M 3 x 22	S	500	12,10 gal Zn
M 3 x 25	S	500	7,10 gal Zn
M 3 x 30	S	500	7,90 gal Zn
M 3 x 35	S	500	30,00 gal Zn
M 3 x 40	S	500	31,50 gal Zn
M 3 x 45	S	500	80,00 gal Zn
M 3 x 50	S	500	89,00 gal Zn
M 4 x 4	S	500	106,00 gal Zn
M 4 x 5	S	500	20,00 gal Zn

Abmessungen	VE	Stück	€/100/Obf.	Abmessungen	VE	Stück	€/100/Obf.	Abmessungen	VE	Stück	€/100/Obf.
M 4 x 6	S	500	11,60 gal Zn	M 5 x 110	S	200	76,00 gal Zn	M 8 x 25	S	200	11,30 gal Zn
M 4 x 6	K	100	15,20 gal Zn	M 5 x 115	S	100	200,00 gal Zn	M 8 x 30	S	200	12,10 gal Zn
M 4 x 8	S	500	6,80 gal Zn	M 5 x 120	S	100	83,00 gal Zn	M 8 x 35	S	200	13,20 gal Zn
M 4 x 8	K	100	10,50 gal Zn	M 5 x 125	S	100	340,00 gal Zn	M 8 x 40	S	200	15,00 gal Zn
M 4 x 10	S	500	5,30 gal Zn	M 5 x 130	S	100	310,00 gal Zn	M 8 x 45	S	200	15,50 gal Zn
M 4 x 10	K	100	8,90 gal Zn	M 5 x 140	S	100	520,00 gal Zn	M 8 x 50	S	200	17,30 gal Zn
M 4 x 12	S	500	5,50 gal Zn	M 5 x 150	S	100	660,00 gal Zn	M 8 x 55	S	200	20,00 gal Zn
M 4 x 12	K	100	9,20 gal Zn	M 5 x 160	S	100	680,00 gal Zn	M 8 x 60	S	200	22,00 gal Zn
M 4 x 14	S	500	8,80 gal Zn	M 5 x 170	S	100	720,00 gal Zn	M 8 x 65	S	200	32,00 gal Zn
M 4 x 16	S	500	5,40 gal Zn	M 5 x 180	S	100	750,00 gal Zn	M 8 x 70	S	200	33,00 gal Zn
M 4 x 16	K	100	9,10 gal Zn	M 5 x 200	S	100	980,00 gal Zn	M 8 x 75	S	200	39,50 gal Zn
M 4 x 18	S	500	5,70 gal Zn	M 6 x 6	S	500	32,00 gal Zn	M 8 x 80	S	200	49,00 gal Zn
M 4 x 20	S	500	5,90 gal Zn	M 6 x 6	K	100	36,00 gal Zn	M 8 x 85	S	100	75,00 gal Zn
M 4 x 20	K	100	9,50 gal Zn	M 6 x 8	S	500	11,50 gal Zn	M 8 x 90	S	100	60,00 gal Zn
M 4 x 22	S	500	10,90 gal Zn	M 6 x 8	K	100	15,10 gal Zn	M 8 x 95	S	100	85,00 gal Zn
M 4 x 25	S	500	6,60 gal Zn	M 6 x 10	S	500	5,80 gal Zn	M 8 x 100	S	100	66,00 gal Zn
M 4 x 25	K	100	10,30 gal Zn	M 6 x 10	K	100	9,40 gal Zn	M 8 x 105	S	100	94,00 gal Zn
M 4 x 28	S	500	12,80 gal Zn	M 6 x 12	S	500	6,10 gal Zn	M 8 x 110	S	100	78,00 gal Zn
M 4 x 30	S	500	7,20 gal Zn	M 6 x 12	K	100	9,70 gal Zn	M 8 x 115	S	100	142,00 gal Zn
M 4 x 30	K	100	10,90 gal Zn	M 6 x 14	S	500	8,90 gal Zn	M 8 x 120	S	100	90,00 gal Zn
M 4 x 35	S	500	8,60 gal Zn	M 6 x 14	K	100	12,60 gal Zn	M 8 x 125	S	100	176,00 gal Zn
M 4 x 35	K	100	12,30 gal Zn	M 6 x 16	S	500	5,90 gal Zn	M 8 x 130	S	100	116,00 gal Zn
M 4 x 40	S	500	9,20 gal Zn	M 6 x 16	K	100	9,50 gal Zn	M 8 x 135	S	100	187,00 gal Zn
M 4 x 40	K	100	12,80 gal Zn	M 6 x 18	S	500	6,30 gal Zn	M 8 x 140	S	100	128,00 gal Zn
M 4 x 45	S	500	19,20 gal Zn	M 6 x 18	K	100	9,90 gal Zn	M 8 x 145	S	100	310,00 gal Zn
M 4 x 50	S	500	21,20 gal Zn	M 6 x 20	S	500	6,40 gal Zn	M 8 x 150	S	100	206,00 gal Zn
M 4 x 55	S	200	29,00 gal Zn	M 6 x 20	K	100	10,10 gal Zn	M 8 x 160	S	100	260,00 gal Zn
M 4 x 60	S	200	29,00 gal Zn	M 6 x 22	S	500	11,00 gal Zn	M 8 x 170	S	100	390,00 gal Zn
M 4 x 65	S	200	44,00 gal Zn	M 6 x 22	K	100	14,60 gal Zn	M 8 x 180	S	100	355,00 gal Zn
M 4 x 70	S	200	44,00 gal Zn	M 6 x 25	S	500	6,80 gal Zn	M 8 x 190	S	100	460,00 gal Zn
M 4 x 75	S	200	76,00 gal Zn	M 6 x 25	K	100	10,40 gal Zn	M 8 x 200	S	100	375,00 gal Zn
M 4 x 80	S	200	86,00 gal Zn	M 6 x 28	S	500	16,00 gal Zn	M 8 x 210	S	100	510,00 gal Zn
M 4 x 85	S	200	310,00 gal Zn	M 6 x 28	K	100	19,60 gal Zn	M 8 x 220	S	100	550,00 gal Zn
M 4 x 90	S	200	340,00 gal Zn	M 6 x 30	S	500	7,70 gal Zn	M 8 x 230	S	100	590,00 gal Zn
M 4 x 95	S	200	370,00 gal Zn	M 6 x 30	K	100	11,50 gal Zn	M 8 x 240	S	100	630,00 gal Zn
M 4 x 100	S	200	400,00 gal Zn	M 6 x 35	S	200	8,50 gal Zn	M 8 x 250	S	100	650,00 gal Zn
M 4 x 110	S	200	430,00 gal Zn	M 6 x 40	S	200	9,40 gal Zn	M 8 x 260	S	100	650,00 gal Zn
M 4 x 120	S	200	495,00 gal Zn	M 6 x 45	S	200	12,00 gal Zn	M 8 x 270	S	100	710,00 gal Zn
M 5 x 5	S	500	107,00 gal Zn	M 6 x 50	S	200	12,60 gal Zn	M 8 x 280	S	100	890,00 gal Zn
M 5 x 6	S	500	12,40 gal Zn	M 6 x 55	S	200	19,70 gal Zn	M 10 x 10	S	200	108,00 gal Zn
M 5 x 6	K	100	16,10 gal Zn	M 6 x 60	S	200	21,00 gal Zn	M 10 x 12	S	200	50,00 gal Zn
M 5 x 8	S	500	9,80 gal Zn	M 6 x 65	S	200	27,50 gal Zn	M 10 x 14	S	200	39,50 gal Zn
M 5 x 8	K	100	13,50 gal Zn	M 6 x 70	S	200	28,50 gal Zn	M 10 x 16	S	200	27,00 gal Zn
M 5 x 10	S	500	5,30 gal Zn	M 6 x 75	S	200	38,00 gal Zn	M 10 x 18	S	200	53,00 gal Zn
M 5 x 10	K	100	8,90 gal Zn	M 6 x 80	S	200	39,50 gal Zn	M 10 x 20	S	200	18,40 gal Zn
M 5 x 12	S	500	5,40 gal Zn	M 6 x 85	S	200	50,00 gal Zn	M 10 x 22	S	200	34,00 gal Zn
M 5 x 12	K	100	9,10 gal Zn	M 6 x 90	S	200	46,00 gal Zn	M 10 x 25	S	200	19,30 gal Zn
M 5 x 14	S	500	9,10 gal Zn	M 6 x 95	S	200	112,00 gal Zn	M 10 x 30	S	200	20,90 gal Zn
M 5 x 14	K	100	12,80 gal Zn	M 6 x 100	S	200	54,00 gal Zn	M 10 x 35	S	100	22,40 gal Zn
M 5 x 16	S	500	5,40 gal Zn	M 6 x 105	S	100	112,00 gal Zn	M 10 x 40	S	100	24,40 gal Zn
M 5 x 16	K	100	9,10 gal Zn	M 6 x 110	S	100	77,00 gal Zn	M 10 x 45	S	100	27,00 gal Zn
M 5 x 18	S	500	5,70 gal Zn	M 6 x 115	S	100	141,00 gal Zn	M 10 x 50	S	100	29,00 gal Zn
M 5 x 18	K	100	9,40 gal Zn	M 6 x 120	S	100	88,00 gal Zn	M 10 x 55	S	100	31,00 gal Zn
M 5 x 20	S	500	5,90 gal Zn	M 6 x 125	S	100	190,00 gal Zn	M 10 x 60	S	100	33,50 gal Zn
M 5 x 20	K	100	9,50 gal Zn	M 6 x 130	S	100	138,00 gal Zn	M 10 x 65	S	100	36,00 gal Zn
M 5 x 22	S	500	10,30 gal Zn	M 6 x 140	S	100	184,00 gal Zn	M 10 x 70	S	100	37,50 gal Zn
M 5 x 22	K	100	14,00 gal Zn	M 6 x 145	S	100	410,00 gal Zn	M 10 x 75	S	100	44,50 gal Zn
M 5 x 25	S	500	6,30 gal Zn	M 6 x 150	S	100	216,00 gal Zn	M 10 x 80	S	100	46,00 gal Zn
M 5 x 25	K	100	9,90 gal Zn	M 6 x 160	S	100	600,00 gal Zn	M 10 x 85	S	100	62,00 gal Zn
M 5 x 30	S	500	7,70 gal Zn	M 6 x 170	S	100	740,00 gal Zn	M 10 x 90	S	100	63,00 gal Zn
M 5 x 30	K	100	11,30 gal Zn	M 6 x 180	S	100	810,00 gal Zn	M 10 x 95	S	100	142,00 gal Zn
M 5 x 35	S	200	8,20 gal Zn	M 6 x 200	S	100	1080,00 gal Zn	M 10 x 100	S	100	69,00 gal Zn
M 5 x 40	S	200	8,70 gal Zn	M 6 x 210	S	100	1140,00 gal Zn	M 10 x 110	S	100	78,00 gal Zn
M 5 x 45	S	200	14,70 gal Zn	M 6 x 220	S	100	1190,00 gal Zn	M 10 x 115	S	100	166,00 gal Zn
M 5 x 50	S	200	20,40 gal Zn	M 6 x 230	S	100	1290,00 gal Zn	M 10 x 120	S	50	93,00 gal Zn
M 5 x 55	S	200	25,00 gal Zn	M 6 x 280	S	100	1450,00 gal Zn	M 10 x 125	S	50	187,00 gal Zn
M 5 x 60	S	200	26,50 gal Zn	M 6 x 300	S	100	1620,00 gal Zn	M 10 x 130	S	50	129,00 gal Zn
M 5 x 65	S	200	37,00 gal Zn	M 8 x 8	S	200	30,00 gal Zn	M 10 x 135	S	50	224,00 gal Zn
M 5 x 70	S	200	38,00 gal Zn	M 8 x 10	S	200	14,10 gal Zn	M 10 x 140	S	50	154,00 gal Zn
M 5 x 75	S	200	47,50 gal Zn	M 8 x 12	S	200	14,70 gal Zn	M 10 x 150	S	50	203,00 gal Zn
M 5 x 80	S	200	50,00 gal Zn	M 8 x 14	S	200	15,50 gal Zn	M 10 x 155	S	50	310,00 gal Zn
M 5 x 85	S	200	69,00 gal Zn	M 8 x 16	S	200	10,00 gal Zn	M 10 x 160	S	50	223,00 gal Zn
M 5 x 90	S	200	63,00 gal Zn	M 8 x 18	S	200	10,60 gal Zn	M 10 x 170	S	50	315,00 gal Zn
M 5 x 95	S	200	80,00 gal Zn	M 8 x 20	S	200	10,30 gal Zn	M 10 x 180	S	50	325,00 gal Zn
M 5 x 100	S	200	68,00 gal Zn	M 8 x 22	S	200	17,50 gal Zn	M 10 x 190	S	50	385,00 gal Zn

Abmessungen	VE	Stück	€/100/0bf.	Abmessungen	VE	Stück	€/100/0bf.	Abmessungen	VE	Stück	€/100/0bf.
M 10 x 200	S	50	360,00 gal Zn	M 14 x 200	S	25	760,00 gal Zn	M 20 x 180	S	10	770,00 gal Zn
M 10 x 210	S	50	680,00 gal Zn	M 16 x 20	S	50	114,00 gal Zn	M 20 x 190	S	10	890,00 gal Zn
M 10 x 220	S	50	680,00 gal Zn	M 16 x 25	S	50	89,00 gal Zn	M 20 x 200	S	1	900,00 gal Zn
M 10 x 230	S	50	710,00 gal Zn	M 16 x 30	S	50	60,00 gal Zn	M 20 x 210	S	1	1000,00 gal Zn
M 10 x 240	S	50	710,00 gal Zn	M 16 x 35	S	50	62,00 gal Zn	M 20 x 220	S	1	1010,00 gal Zn
M 10 x 250	S	50	870,00 gal Zn	M 16 x 40	S	50	65,00 gal Zn	M 20 x 230	S	1	1160,00 gal Zn
M 10 x 260	S	50	850,00 gal Zn	M 16 x 45	S	50	70,00 gal Zn	M 20 x 240	S	1	1480,00 gal Zn
M 10 x 270	S	50	930,00 gal Zn	M 16 x 50	S	50	76,00 gal Zn	M 20 x 250	S	1	1230,00 gal Zn
M 10 x 280	S	50	930,00 gal Zn	M 16 x 55	S	50	82,00 gal Zn	M 20 x 260	S	1	1230,00 gal Zn
M 10 x 300	S	50	1010,00 gal Zn	M 16 x 60	S	50	86,00 gal Zn	M 20 x 270	S	1	1380,00 gal Zn
M 12 x 14	S	100	143,00 gal Zn	M 16 x 65	S	25	97,00 gal Zn	M 20 x 280	S	1	1390,00 gal Zn
M 12 x 16	S	100	34,00 gal Zn	M 16 x 70	S	25	98,00 gal Zn	M 20 x 300	S	1	1480,00 gal Zn
M 12 x 20	S	100	32,50 gal Zn	M 16 x 75	S	25	109,00 gal Zn	M 20 x 310	S	1	1710,00 gal Zn
M 12 x 22	S	100	54,00 gal Zn	M 16 x 80	S	25	111,00 gal Zn	M 20 x 320	S	1	1720,00 gal Zn
M 12 x 25	S	100	29,00 gal Zn	M 16 x 85	S	25	250,00 gal Zn	M 22 x 50	S	25	850,00 gal Zn
M 12 x 30	S	100	30,50 gal Zn	M 16 x 90	S	25	131,00 gal Zn	M 22 x 80	S	25	930,00 gal Zn
M 12 x 35	S	100	31,50 gal Zn	M 16 x 95	S	25	205,00 gal Zn	M 22 x 100	S	10	1030,00 gal Zn
M 12 x 40	S	100	33,00 gal Zn	M 16 x 100	S	25	144,00 gal Zn	M 24 x 30	S	25	1270,00 gal Zn
M 12 x 45	S	100	35,00 gal Zn	M 16 x 110	S	25	193,00 gal Zn	M 24 x 40	S	25	780,00 gal Zn
M 12 x 50	S	100	38,50 gal Zn	M 16 x 120	S	25	211,00 gal Zn	M 24 x 45	S	25	780,00 gal Zn
M 12 x 55	S	100	42,00 gal Zn	M 16 x 130	S	25	236,00 gal Zn	M 24 x 50	S	25	310,00 gal Zn
M 12 x 60	S	100	45,00 gal Zn	M 16 x 140	S	25	295,00 gal Zn	M 24 x 55	S	25	345,00 gal Zn
M 12 x 65	S	50	51,00 gal Zn	M 16 x 150	S	25	370,00 gal Zn	M 24 x 60	S	25	345,00 gal Zn
M 12 x 70	S	50	53,00 gal Zn	M 16 x 160	S	25	385,00 gal Zn	M 24 x 65	S	25	370,00 gal Zn
M 12 x 75	S	50	56,00 gal Zn	M 16 x 170	S	25	485,00 gal Zn	M 24 x 70	S	25	375,00 gal Zn
M 12 x 80	S	50	57,00 gal Zn	M 16 x 180	S	25	445,00 gal Zn	M 24 x 75	S	25	380,00 gal Zn
M 12 x 85	S	50	118,00 gal Zn	M 16 x 190	S	25	690,00 gal Zn	M 24 x 80	S	25	385,00 gal Zn
M 12 x 90	S	50	69,00 gal Zn	M 16 x 200	S	25	530,00 gal Zn	M 24 x 85	S	10	1130,00 gal Zn
M 12 x 95	S	50	163,00 gal Zn	M 16 x 210	S	25	820,00 gal Zn	M 24 x 90	S	10	455,00 gal Zn
M 12 x 100	S	50	83,00 gal Zn	M 16 x 220	S	25	630,00 gal Zn	M 24 x 100	S	10	475,00 gal Zn
M 12 x 110	S	50	101,00 gal Zn	M 16 x 230	S	25	920,00 gal Zn	M 24 x 110	S	10	580,00 gal Zn
M 12 x 115	S	50	200,00 gal Zn	M 16 x 240	S	25	780,00 gal Zn	M 24 x 120	S	10	620,00 gal Zn
M 12 x 120	S	50	115,00 gal Zn	M 16 x 250	S	25	850,00 gal Zn	M 24 x 130	S	1	710,00 gal Zn
M 12 x 125	S	50	222,00 gal Zn	M 16 x 260	S	25	850,00 gal Zn	M 24 x 140	S	1	870,00 gal Zn
M 12 x 130	S	50	155,00 gal Zn	M 16 x 270	S	25	1070,00 gal Zn	M 24 x 150	S	1	1060,00 gal Zn
M 12 x 135	S	50	241,00 gal Zn	M 16 x 280	S	25	920,00 gal Zn	M 24 x 160	S	1	950,00 gal Zn
M 12 x 140	S	50	181,00 gal Zn	M 16 x 300	S	25	1070,00 gal Zn	M 24 x 170	S	10	1020,00 gal Zn
M 12 x 145	S	50	275,00 gal Zn	M 16 x 320	S	10	1720,00 gal Zn	M 24 x 180	S	1	1060,00 gal Zn
M 12 x 150	S	50	223,00 gal Zn	M 16 x 340	S	10	2010,00 gal Zn	M 24 x 200	S	1	1160,00 gal Zn
M 12 x 155	S	50	295,00 gal Zn	M 16 x 360	S	10	2360,00 gal Zn	M 24 x 210	S	1	1530,00 gal Zn
M 12 x 160	S	50	265,00 gal Zn	M 18 x 30	S	50	270,00 gal Zn	M 24 x 220	S	1	1530,00 gal Zn
M 12 x 170	S	50	350,00 gal Zn	M 18 x 35	S	50	270,00 gal Zn	M 24 x 230	S	1	1630,00 gal Zn
M 12 x 180	S	50	350,00 gal Zn	M 18 x 40	S	50	242,00 gal Zn	M 24 x 240	S	1	1630,00 gal Zn
M 12 x 190	S	50	405,00 gal Zn	M 18 x 45	S	50	260,00 gal Zn	M 24 x 250	S	1	1720,00 gal Zn
M 12 x 200	S	50	405,00 gal Zn	M 18 x 50	S	50	265,00 gal Zn	M 24 x 260	S	1	1730,00 gal Zn
M 12 x 210	S	25	970,00 gal Zn	M 18 x 55	S	25	275,00 gal Zn	M 24 x 280	S	1	1860,00 gal Zn
M 12 x 220	S	25	720,00 gal Zn	M 18 x 60	S	25	285,00 gal Zn	M 24 x 300	S	1	2010,00 gal Zn
M 12 x 230	S	25	1040,00 gal Zn	M 18 x 70	S	25	320,00 gal Zn	M 25 x 50	S	10	1170,00 gal Zn
M 12 x 240	S	25	800,00 gal Zn	M 18 x 80	S	25	345,00 gal Zn	M 27 x 60	S	10	1180,00 gal Zn
M 12 x 250	S	25	1130,00 gal Zn	M 18 x 90	S	25	375,00 gal Zn	M 27 x 65	S	10	1220,00 gal Zn
M 12 x 260	S	25	880,00 gal Zn	M 18 x 100	S	25	415,00 gal Zn	M 27 x 70	S	10	1220,00 gal Zn
M 12 x 270	S	25	1200,00 gal Zn	M 18 x 110	S	25	530,00 gal Zn	M 27 x 80	S	10	1280,00 gal Zn
M 12 x 290	S	25	1430,00 gal Zn	M 18 x 120	S	25	580,00 gal Zn	M 27 x 90	S	10	1340,00 gal Zn
M 12 x 300	S	25	1010,00 gal Zn	M 20 x 25	S	25	425,00 gal Zn	M 27 x 100	S	10	1410,00 gal Zn
M 14 x 20	S	100	120,00 gal Zn	M 20 x 30	S	25	213,00 gal Zn	M 27 x 110	S	10	1450,00 gal Zn
M 14 x 25	S	100	93,00 gal Zn	M 20 x 35	S	25	216,00 gal Zn	M 27 x 120	S	10	1600,00 gal Zn
M 14 x 30	S	100	86,00 gal Zn	M 20 x 40	S	25	131,00 gal Zn	M 27 x 130	S	1	1670,00 gal Zn
M 14 x 35	S	100	98,00 gal Zn	M 20 x 45	S	25	137,00 gal Zn	M 27 x 140	S	1	1740,00 gal Zn
M 14 x 40	S	100	91,00 gal Zn	M 20 x 50	S	25	143,00 gal Zn	M 27 x 200	S	1	2100,00 gal Zn
M 14 x 45	S	50	102,00 gal Zn	M 20 x 55	S	25	152,00 gal Zn	M 30 x 35	S	10	2040,00 gal Zn
M 14 x 50	S	50	102,00 gal Zn	M 20 x 60	S	25	154,00 gal Zn	M 30 x 40	S	10	2040,00 gal Zn
M 14 x 55	S	50	126,00 gal Zn	M 20 x 65	S	25	166,00 gal Zn	M 30 x 50	S	10	1360,00 gal Zn
M 14 x 60	S	50	117,00 gal Zn	M 20 x 70	S	25	170,00 gal Zn	M 30 x 55	S	10	1360,00 gal Zn
M 14 x 65	S	50	144,00 gal Zn	M 20 x 75	S	25	180,00 gal Zn	M 30 x 60	S	10	1360,00 gal Zn
M 14 x 70	S	50	148,00 gal Zn	M 20 x 80	S	25	181,00 gal Zn	M 30 x 65	S	10	1390,00 gal Zn
M 14 x 75	S	50	161,00 gal Zn	M 20 x 85	S	25	1090,00 gal Zn	M 30 x 70	S	10	1420,00 gal Zn
M 14 x 80	S	50	167,00 gal Zn	M 20 x 90	S	25	217,00 gal Zn	M 30 x 80	S	10	1480,00 gal Zn
M 14 x 90	S	50	182,00 gal Zn	M 20 x 100	S	25	232,00 gal Zn	M 30 x 85	S	1	1540,00 gal Zn
M 14 x 100	S	50	201,00 gal Zn	M 20 x 110	S	25	270,00 gal Zn	M 30 x 90	S	1	1540,00 gal Zn
M 14 x 110	S	50	236,00 gal Zn	M 20 x 120	S	25	295,00 gal Zn	M 30 x 100	S	1	1600,00 gal Zn
M 14 x 120	S	50	260,00 gal Zn	M 20 x 130	S	25	395,00 gal Zn	M 30 x 110	S	1	1660,00 gal Zn
M 14 x 130	S	50	295,00 gal Zn	M 20 x 140	S	25	550,00 gal Zn	M 30 x 120	S	1	1720,00 gal Zn
M 14 x 140	S	25	310,00 gal Zn	M 20 x 150	S	25	620,00 gal Zn	M 30 x 130	S	1	1780,00 gal Zn
M 14 x 150	S	25	390,00 gal Zn	M 20 x 160	S	10	640,00 gal Zn	M 30 x 140	S	1	1840,00 gal Zn
M 14 x 160	S	25	650,00 gal Zn	M 20 x 170	S	10	770,00 gal Zn	M 30 x 150	S	1	1950,00 gal Zn

Abmessungen	VE	Stück	€/100/Obf.
M 30 x 160	S	1	2020,00 gal Zn
M 30 x 170	S	1	2110,00 gal Zn
M 30 x 180	S	1	2130,00 gal Zn
M 30 x 190	S	1	2240,00 gal Zn
M 30 x 200	S	1	2320,00 gal Zn
M 30 x 210	S	1	2500,00 gal Zn
M 30 x 220	S	1	2500,00 gal Zn
M 30 x 240	S	1	2650,00 gal Zn
M 30 x 250	S	1	2800,00 gal Zn
M 30 x 260	S	1	2800,00 gal Zn
M 30 x 280	S	1	2900,00 gal Zn
M 30 x 300	S	1	3200,00 gal Zn
M 36 x 50	S	1	2340,00 gal Zn
M 36 x 60	S	1	2340,00 gal Zn
M 36 x 65	S	1	2340,00 gal Zn
M 36 x 70	S	1	2300,00 gal Zn
M 36 x 80	S	1	2320,00 gal Zn
M 36 x 90	S	1	2400,00 gal Zn
M 36 x 100	S	1	2480,00 gal Zn
M 36 x 110	S	1	2600,00 gal Zn
M 36 x 120	S	1	2700,00 gal Zn
M 36 x 130	S	1	2800,00 gal Zn
M 36 x 140	S	1	2900,00 gal Zn
M 36 x 150	S	1	3000,00 gal Zn
M 36 x 160	S	1	3100,00 gal Zn
M 36 x 180	S	1	3350,00 gal Zn
M 36 x 200	S	1	3600,00 gal Zn
M 36 x 220	S	1	3850,00 gal Zn
M 36 x 230	S	1	4050,00 gal Zn
M 36 x 260	S	1	4250,00 gal Zn
M 36 x 310	S	1	7100,00 gal Zn
M 36 x 320	S	1	6500,00 gal Zn
M 42 x 70	S	1	3950,00 gal Zn
M 42 x 80	S	1	3950,00 gal Zn
M 42 x 90	S	1	4000,00 gal Zn
M 42 x 100	S	1	4150,00 gal Zn

~DIN	00912.814
912	8.8
	galvanisch verzinkt
	ISR

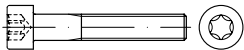

Zylinderschrauben, ISR = Innensechsrund-Antrieb

Maße → **TI-12** Anziehmomente → **TI-244**
 Werkstoffeigensch. → **TI-232** Normumstellung → **TI-6**
 Korrosionsschutz → **TI-228**

Identisch mit ISO 14579

RoHS ✓	REACH SVHC free
------------------	---------------------------

M 6 x 16 -T30	S	200	8,80 gal Zn
M 6 x 20 -T30	S	200	9,60 gal Zn
M 8 x 20 -T45	S	200	15,50 gal Zn
M 8 x 25 -T45	S	200	16,90 gal Zn
M 8 x 30 -T45	S	200	18,10 gal Zn
M 8 x 35 -T45	S	200	19,80 gal Zn

Abmessungen	VE	Stück	€/100/Obf.
DIN	00912.362		
912	8.8		
	galv. verz. 8 DiSP*		

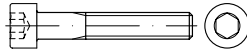

Zylinderschrauben mit Innensechskant

* < M 6 Mindestschichtdicke 5µm,
 Korrosionsbeständigkeit NSS: 72h WR, 120h RR

Maße → **TI-12** Anziehmomente → **TI-244**
 Werkstoffeigensch. → **TI-232** Normumstellung → **TI-6**
 Korrosionsschutz → **TI-228**

Rostfrei → **S. 477**

DIN 912 → wird ersetzt durch ISO 4762

RoHS ✓	REACH SVHC free
------------------	---------------------------

M 3 x 6	S	500	11,80 gal ZnDi
M 3 x 8	S	500	8,20 gal ZnDi
M 3 x 10	S	500	7,00 gal ZnDi
M 3 x 12	S	500	7,20 gal ZnDi
M 3 x 16	S	500	7,70 gal ZnDi
M 3 x 20	S	500	8,20 gal ZnDi
M 4 x 6	S	500	14,40 gal ZnDi
M 4 x 8	S	500	8,50 gal ZnDi
M 4 x 10	S	500	6,60 gal ZnDi
M 4 x 12	S	500	6,90 gal ZnDi
M 4 x 16	S	500	6,70 gal ZnDi
M 4 x 20	S	500	7,30 gal ZnDi
M 4 x 25	S	500	8,30 gal ZnDi
M 4 x 30	S	500	8,90 gal ZnDi
M 4 x 35	S	500	10,90 gal ZnDi
M 4 x 40	S	500	11,50 gal ZnDi
M 5 x 6	S	500	15,50 gal ZnDi
M 5 x 8	S	500	12,30 gal ZnDi
M 5 x 10	S	500	6,60 gal ZnDi
M 5 x 12	S	500	6,80 gal ZnDi
M 5 x 16	S	500	6,80 gal ZnDi
M 5 x 20	S	500	7,30 gal ZnDi
M 5 x 25	S	500	7,90 gal ZnDi
M 5 x 30	S	500	9,60 gal ZnDi
M 5 x 35	S	200	10,30 gal ZnDi
M 5 x 40	S	200	10,90 gal ZnDi
M 5 x 45	S	200	20,00 gal ZnDi
M 5 x 50	S	200	26,00 gal ZnDi
M 6 x 8	S	500	14,40 gal ZnDi
M 6 x 10	S	500	7,20 gal ZnDi
M 6 x 12	S	500	7,60 gal ZnDi
M 6 x 16	S	500	7,30 gal ZnDi
M 6 x 20	S	500	8,10 gal ZnDi
M 6 x 22	S	500	14,10 gal ZnDi
M 6 x 25	S	500	9,60 gal ZnDi
M 6 x 30	S	500	10,30 gal ZnDi
M 6 x 35	S	200	10,80 gal ZnDi
M 6 x 40	S	200	11,70 gal ZnDi
M 6 x 45	S	200	15,00 gal ZnDi
M 6 x 50	S	200	15,80 gal ZnDi
M 6 x 55	S	200	24,60 gal ZnDi
M 6 x 60	S	200	26,50 gal ZnDi
M 6 x 65	S	200	38,00 gal ZnDi
M 6 x 70	S	200	39,50 gal ZnDi
M 6 x 75	S	200	52,00 gal ZnDi
M 6 x 80	S	200	54,00 gal ZnDi
M 6 x 100	S	200	67,00 gal ZnDi
M 8 x 10	S	200	17,60 gal ZnDi
M 8 x 12	S	200	18,40 gal ZnDi
M 8 x 16	S	200	12,60 gal ZnDi
M 8 x 20	S	200	12,90 gal ZnDi

Abmessungen	VE	Stück	€/100/Obf.
M 8 x 25	S	200	14,10 gal ZnDi
M 8 x 30	S	200	15,20 gal ZnDi
M 8 x 35	S	200	16,60 gal ZnDi
M 8 x 40	S	200	18,70 gal ZnDi
M 8 x 45	S	200	19,40 gal ZnDi
M 8 x 50	S	200	21,60 gal ZnDi
M 8 x 55	S	200	33,00 gal ZnDi
M 8 x 60	S	200	28,00 gal ZnDi
M 8 x 65	S	200	47,00 gal ZnDi
M 8 x 70	S	200	49,50 gal ZnDi
M 8 x 80	S	200	69,00 gal ZnDi
M 8 x 90	S	100	78,00 gal ZnDi
M 8 x 100	S	100	94,00 gal ZnDi
M 10 x 16	S	200	34,00 gal ZnDi
M 10 x 20	S	200	23,00 gal ZnDi
M 10 x 25	S	200	24,50 gal ZnDi
M 10 x 30	S	200	26,50 gal ZnDi
M 10 x 35	S	100	28,50 gal ZnDi
M 10 x 40	S	100	31,00 gal ZnDi
M 10 x 45	S	100	34,50 gal ZnDi
M 10 x 50	S	100	36,00 gal ZnDi
M 10 x 55	S	100	39,00 gal ZnDi
M 10 x 60	S	100	42,00 gal ZnDi
M 10 x 70	S	100	62,00 gal ZnDi
M 10 x 80	S	100	75,00 gal ZnDi
M 10 x 90	S	100	94,00 gal ZnDi
M 10 x 100	S	100	101,00 gal ZnDi
M 12 x 20	S	100	50,00 gal ZnDi
M 12 x 25	S	100	36,50 gal ZnDi
M 12 x 30	S	100	38,50 gal ZnDi
M 12 x 35	S	100	39,50 gal ZnDi
M 12 x 40	S	100	41,50 gal ZnDi
M 12 x 45	S	100	44,50 gal ZnDi
M 12 x 50	S	100	48,00 gal ZnDi
M 12 x 60	S	100	57,00 gal ZnDi
M 12 x 65	S	50	64,00 gal ZnDi
M 12 x 70	S	50	66,00 gal ZnDi
M 12 x 75	S	50	70,00 gal ZnDi
M 12 x 80	S	50	71,00 gal ZnDi
M 12 x 90	S	50	87,00 gal ZnDi
M 16 x 25	S	50	107,00 gal ZnDi
M 16 x 30	S	50	76,00 gal ZnDi
M 16 x 35	S	50	77,00 gal ZnDi
M 16 x 40	S	50	82,00 gal ZnDi
M 16 x 50	S	50	95,00 gal ZnDi
M 16 x 55	S	50	110,00 gal ZnDi
M 16 x 60	S	50	141,00 gal ZnDi
M 16 x 65	S	25	124,00 gal ZnDi
M 16 x 70	S	25	125,00 gal ZnDi
M 16 x 80	S	25	182,00 gal ZnDi
M 16 x 90	S	25	212,00 gal ZnDi
M 16 x 100	S	25	230,00 gal ZnDi
M 16 x 120	S	25	310,00 gal ZnDi

Abmessungen	VE Stück	€/100/Obf.
DIN 00912.422		
912	8.8	galv. verz. 8 DiSP* + SL**



Zylinderschrauben mit Innensechskant

* < M 6 Mindestschichtdicke 5µm,
 **SL = Sealer and Lubrication
 (Versiegelung und Schmierung mit $\mu = 0,12 - 0,18$),
 Korrosionsbeständigkeit NSS: 120h WR, 264h RR

Maße → **TI-12** Anziehmomente → **TI-244**
 Werkstoffeigensch. → **TI-232** Normumstellung → **TI-6**
 Korrosionsschutz → **TI-228**

Rostfrei → **S. 477**

DIN 912 → wird ersetzt durch ISO 4762

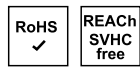

M 3 x 6	S 500	11,30
M 3 x 8	S 500	7,90
M 3 x 10	S 500	6,70
M 3 x 12	S 500	6,90
M 3 x 16	S 500	7,40
M 3 x 20	S 500	7,90
M 4 x 6	S 500	13,80
M 4 x 8	S 500	8,20
M 4 x 10	S 500	6,30
M 4 x 12	S 500	6,60
M 4 x 16	S 500	6,40
M 4 x 20	S 500	7,00
M 4 x 25	S 500	8,00
M 4 x 30	S 500	8,50
M 4 x 35	S 500	10,40
M 4 x 40	S 500	11,10
M 4 x 45	S 500	24,00
M 4 x 50	S 500	28,50
M 5 x 6	S 500	14,90
M 5 x 8	S 500	11,70
M 5 x 10	S 500	6,40
M 5 x 12	S 500	6,50
M 5 x 14	S 500	11,10
M 5 x 16	S 500	6,40
M 5 x 20	S 500	7,00
M 5 x 22	S 500	12,90
M 5 x 25	S 500	7,50
M 5 x 30	S 500	9,20
M 5 x 35	S 200	9,90
M 5 x 40	S 200	10,50
M 5 x 45	S 200	19,20
M 5 x 50	S 200	24,70
M 5 x 55	S 200	27,00
M 6 x 8	S 500	13,80
M 6 x 10	S 500	6,90
M 6 x 12	S 500	7,30
M 6 x 16	S 500	7,00
M 6 x 20	S 500	7,70
M 6 x 22	S 500	13,50
M 6 x 25	S 500	8,10
M 6 x 30	S 500	9,30
M 6 x 32	S 200	9,80
M 6 x 35	S 200	10,30
M 6 x 40	S 200	11,20
M 6 x 45	S 200	14,40
M 6 x 50	S 200	15,20
M 6 x 55	S 200	23,60
M 6 x 60	S 200	25,50
M 6 x 65	S 200	36,50

Abmessungen	VE Stück	€/100/Obf.
M 6 x 70	S 200	37,50
M 6 x 75	S 200	49,50
M 6 x 80	S 200	51,00
M 6 x 85	S 200	47,50
M 6 x 100	S 200	64,00
M 6 x 105	S 100	154,00
M 6 x 110	S 100	62,00
M 6 x 130	S 100	76,00
M 8 x 10	S 200	16,90
M 8 x 12	S 200	17,60
M 8 x 16	S 200	12,20
M 8 x 20	S 200	12,40
M 8 x 25	S 200	13,60
M 8 x 30	S 200	14,60
M 8 x 35	S 200	15,90
M 8 x 40	S 200	18,00
M 8 x 45	S 200	18,60
M 8 x 50	S 200	20,70
M 8 x 55	S 200	31,50
M 8 x 60	S 200	26,50
M 8 x 65	S 200	45,00
M 8 x 70	S 200	47,50
M 8 x 80	S 200	67,00
M 8 x 85	S 200	59,00
M 8 x 90	S 100	75,00
M 8 x 100	S 100	90,00
M 8 x 110	S 100	104,00
M 8 x 200	S 50	200,00
M 10 x 12	S 200	60,00
M 10 x 16	S 200	32,50
M 10 x 20	S 200	22,10
M 10 x 25	S 200	23,40
M 10 x 30	S 200	25,50
M 10 x 35	S 100	27,00
M 10 x 40	S 100	30,00
M 10 x 45	S 100	33,00
M 10 x 50	S 100	34,50
M 10 x 55	S 100	37,50
M 10 x 60	S 100	40,50
M 10 x 65	S 100	39,50
M 10 x 70	S 100	60,00
M 10 x 80	S 100	72,00
M 10 x 90	S 100	90,00
M 10 x 100	S 100	97,00
M 10 x 110	S 100	108,00
M 10 x 120	S 50	128,00
M 10 x 135	S 50	152,00
M 12 x 20	S 100	48,00
M 12 x 25	S 100	35,00
M 12 x 30	S 100	37,00
M 12 x 35	S 100	37,50
M 12 x 40	S 100	40,00
M 12 x 45	S 100	42,50
M 12 x 50	S 100	106,00
M 12 x 60	S 100	54,00
M 12 x 65	S 50	61,00
M 12 x 70	S 50	64,00
M 12 x 75	S 50	67,00
M 12 x 80	S 50	68,00
M 12 x 90	S 50	83,00
M 12 x 100	S 50	106,00
M 12 x 110	S 50	105,00
M 12 x 120	S 50	128,00
M 14 x 30	S 100	79,00
M 16 x 25	S 50	103,00
M 16 x 30	S 50	73,00
M 16 x 35	S 50	74,00
M 16 x 40	S 50	78,00
M 16 x 45	S 50	87,00
M 16 x 50	S 50	92,00
M 16 x 55	S 50	105,00
M 16 x 60	S 50	135,00
M 16 x 65	S 25	118,00
M 16 x 70	S 25	120,00
M 16 x 75	S 25	137,00

Abmessungen	VE Stück	€/100/Obf.
M 16 x 80	S 25	175,00
M 16 x 85	S 25	305,00
M 16 x 90	S 25	204,00
M 16 x 100	S 25	221,00
M 16 x 120	S 25	295,00
M 16 x 130	S 25	330,00
M 16 x 140	S 25	365,00
M 16 x 150	S 25	455,00
M 16 x 180	S 25	540,00
M 16 x 300	S 25	1070,00
M 20 x 35	S 25	136,00
M 20 x 50	S 25	172,00
M 20 x 55	S 25	147,00
M 20 x 60	S 25	185,00
M 20 x 65	S 25	199,00
M 20 x 70	S 25	195,00
M 20 x 100	S 25	236,00
M 20 x 120	S 25	345,00
M 20 x 150	S 25	760,00
M 20 x 180	S 25	770,00

Abmessungen	VE Stück	€/100/Obf.
DIN 00912.453		
912	8.8	f1Zn/TL480h

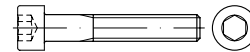

Zylinderschrauben mit Innensechskant

TL = Schmierstoff im Topcoat mit $\mu = 0,09 - 0,14$,
 Korrosionsbeständigkeit NSS: 480h RR,
 Chrom(VI)-frei

Achtung! Gegenüber galv. verzinkt geänderte Anziehdrehmomente.

Maße → **TI-12** Anziehmomente → **TI-245**
 Werkstoffeigensch. → **TI-233** Normumstellung → **TI-6**
 Korrosionsschutz → **TI-230**

Rostfrei → **S. 477**

DIN 912 → wird ersetzt durch ISO 4762



M 6 x 12	S 500	10,30 f1Zn
M 6 x 14	S 500	15,30 f1Zn
M 6 x 16	S 500	9,90 f1Zn
M 6 x 18	S 500	10,70 f1Zn
M 6 x 20	S 500	10,80 f1Zn
M 6 x 22	S 500	18,60 f1Zn
M 6 x 25	S 500	11,50 f1Zn
M 6 x 28	S 500	27,00 f1Zn
M 6 x 30	S 500	13,20 f1Zn
M 6 x 35	S 200	14,30 f1Zn
M 6 x 40	S 200	15,90 f1Zn
M 6 x 45	S 200	20,50 f1Zn
M 6 x 50	S 200	21,40 f1Zn
M 6 x 55	S 200	34,00 f1Zn
M 6 x 60	S 200	36,00 f1Zn
M 6 x 65	S 200	47,00 f1Zn
M 6 x 70	S 200	48,50 f1Zn
M 6 x 75	S 200	65,00 f1Zn
M 6 x 80	S 200	67,00 f1Zn
M 8 x 16	S 200	17,10 f1Zn
M 8 x 20	S 200	17,50 f1Zn
M 8 x 25	S 200	19,20 f1Zn
M 8 x 30	S 200	20,50 f1Zn
M 8 x 35	S 200	22,40 f1Zn
M 8 x 40	S 200	25,50 f1Zn
M 8 x 45	S 200	26,50 f1Zn

Abmessungen	VE	Stück	€/100/Obf.
M 8 x 50	S	200	29,50 flZn
M 8 x 55	S	200	34,00 flZn
M 8 x 60	S	200	38,00 flZn
M 8 x 65	S	200	54,00 flZn
M 8 x 70	S	200	56,00 flZn
M 8 x 75	S	200	68,00 flZn
M 8 x 80	S	200	84,00 flZn
M 8 x 90	S	100	102,00 flZn
M 10 x 20	S	200	31,50 flZn
M 10 x 25	S	200	33,50 flZn
M 10 x 30	S	200	36,00 flZn
M 10 x 35	S	100	38,50 flZn
M 10 x 40	S	100	42,00 flZn
M 10 x 45	S	100	45,50 flZn
M 10 x 50	S	100	49,00 flZn
M 10 x 55	S	100	53,00 flZn
M 10 x 60	S	100	57,00 flZn
M 10 x 65	S	100	62,00 flZn
M 10 x 70	S	100	64,00 flZn
M 10 x 75	S	100	76,00 flZn
M 10 x 80	S	100	78,00 flZn
M 10 x 90	S	100	107,00 flZn
M 12 x 20	S	100	55,00 flZn
M 12 x 25	S	100	49,50 flZn
M 12 x 30	S	100	52,00 flZn
M 12 x 35	S	100	54,00 flZn
M 12 x 40	S	100	56,00 flZn
M 12 x 45	S	100	60,00 flZn
M 12 x 50	S	100	65,00 flZn
M 12 x 55	S	100	72,00 flZn
M 12 x 60	S	100	77,00 flZn
M 12 x 65	S	50	86,00 flZn
M 12 x 70	S	50	90,00 flZn
M 12 x 75	S	50	94,00 flZn
M 12 x 80	S	50	97,00 flZn
M 12 x 90	S	50	118,00 flZn
M 12 x 100	S	50	141,00 flZn
M 16 x 30	S	50	102,00 flZn
M 16 x 35	S	50	105,00 flZn
M 16 x 40	S	50	111,00 flZn
M 16 x 45	S	50	119,00 flZn
M 16 x 50	S	50	129,00 flZn
M 16 x 55	S	50	138,00 flZn
M 16 x 60	S	50	145,00 flZn
M 16 x 65	S	25	164,00 flZn
M 16 x 70	S	25	167,00 flZn
M 16 x 75	S	25	185,00 flZn
M 16 x 80	S	25	188,00 flZn
M 16 x 90	S	25	223,00 flZn
M 16 x 100	S	25	245,00 flZn
M 16 x 110	S	25	335,00 flZn
M 16 x 120	S	25	360,00 flZn
M 20 x 65	S	25	285,00 flZn
M 20 x 70	S	25	290,00 flZn
M 20 x 75	S	25	305,00 flZn
M 20 x 80	S	25	310,00 flZn
M 20 x 90	S	25	375,00 flZn
M 20 x 100	S	25	400,00 flZn
M 20 x 110	S	25	465,00 flZn
M 20 x 120	S	25	495,00 flZn
M 20 x 130	S	25	680,00 flZn
M 20 x 140	S	25	930,00 flZn
M 20 x 150	S	25	1060,00 flZn
M 20 x 160	S	10	1080,00 flZn
M 20 x 170	S	10	1290,00 flZn
M 20 x 180	S	10	1290,00 flZn
M 24 x 75	S	25	650,00 flZn
M 24 x 80	S	25	650,00 flZn
M 24 x 90	S	10	770,00 flZn
M 24 x 100	S	10	810,00 flZn
M 24 x 110	S	10	980,00 flZn
M 24 x 120	S	10	1060,00 flZn
M 24 x 130	S	1	1200,00 flZn
M 24 x 140	S	1	1470,00 flZn
M 24 x 150	S	1	1790,00 flZn

Abmessungen	VE	Stück	€/100/Obf.
M 24 x 160	S	1	1620,00 flZn
M 24 x 170	S	1	1720,00 flZn
M 24 x 180	S	1	1800,00 flZn

~DIN 00912.807

912 8.8 VG



Zylinderschrauben mit Innensechskant, VG = Vollgewinde (Gew. Bis Kopf)

Maße → TI-12 Anziehmomente → TI-244
 Werkstoffeigensch. → TI-232 Normumstellung → TI-6

Form und übrige Maße identisch mit ISO 4762

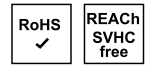

M 5 x 40	S	200	24,60
M 5 x 50	S	200	28,50
M 5 x 60	S	200	31,50
M 5 x 70	S	200	35,00
M 5 x 80	S	200	38,50
M 6 x 40	S	200	27,50
M 6 x 50	S	200	34,00
M 6 x 60	S	200	41,00
M 6 x 70	S	200	46,50
M 6 x 80	S	200	52,00
M 6 x 90	S	200	67,00
M 6 x 100	S	200	138,00
M 8 x 50	S	200	52,00
M 8 x 60	S	200	59,00
M 8 x 70	S	200	73,00
M 8 x 80	S	200	88,00
M 8 x 90	S	100	95,00
M 8 x 100	S	100	111,00
M 10 x 50	S	100	80,00
M 10 x 60	S	100	131,00
M 10 x 70	S	100	152,00
M 10 x 80	S	100	177,00
M 10 x 90	S	100	255,00
M 10 x 100	S	100	295,00
M 12 x 70	S	50	182,00
M 12 x 80	S	50	218,00
M 12 x 90	S	50	295,00
M 12 x 100	S	50	415,00
M 16 x 70	S	25	242,00
M 16 x 80	S	25	295,00
M 16 x 90	S	25	390,00
M 16 x 100	S	25	550,00
M 16 x 120	S	25	660,00

Abmessungen	VE	Stück	€/100/Obf.
-------------	----	-------	------------

~DIN 00912.815
912 8.8 VG galvanisch verzinkt



Zylinderschrauben mit Innensechskant, VG = Vollgewinde (Gew. Bis Kopf)

Maße → TI-12 Anziehmomente → TI-244
 Werkstoffeigensch. → TI-232 Normumstellung → TI-6
 Korrosionsschutz → TI-228

Form und übrige Maße identisch mit ISO 4762

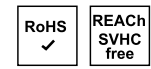

M 4 x 30	S	500	35,50 gal Zn
M 5 x 40	S	200	35,50 gal Zn
M 5 x 45	S	200	38,00 gal Zn
M 5 x 50	S	200	40,50 gal Zn
M 5 x 60	S	200	45,00 gal Zn
M 5 x 70	S	200	50,00 gal Zn
M 5 x 80	S	200	55,00 gal Zn
M 6 x 40	S	200	39,00 gal Zn
M 6 x 50	S	200	48,50 gal Zn
M 6 x 60	S	200	58,00 gal Zn
M 6 x 70	S	200	67,00 gal Zn
M 6 x 75	S	200	91,00 gal Zn
M 6 x 80	S	200	74,00 gal Zn
M 6 x 90	S	200	95,00 gal Zn
M 6 x 100	S	200	197,00 gal Zn
M 8 x 45	S	200	71,00 gal Zn
M 8 x 50	S	200	74,00 gal Zn
M 8 x 60	S	200	85,00 gal Zn
M 8 x 70	S	200	105,00 gal Zn
M 8 x 75	S	200	115,00 gal Zn
M 8 x 80	S	200	125,00 gal Zn
M 8 x 90	S	100	136,00 gal Zn
M 8 x 100	S	100	159,00 gal Zn
M 10 x 50	S	100	114,00 gal Zn
M 10 x 60	S	100	187,00 gal Zn
M 10 x 80	S	100	255,00 gal Zn
M 10 x 90	S	100	360,00 gal Zn
M 10 x 100	S	100	420,00 gal Zn
M 12 x 60	S	100	222,00 gal Zn
M 12 x 80	S	50	315,00 gal Zn
M 12 x 100	S	50	590,00 gal Zn

i

- ✓ Große Artikelvielfalt
- ✓ Verlässliche Qualität
- ✓ Hohe Lieferbereitschaft

i

Wir versorgen Sie mit Verbindungselementen und Befestigungstechnik!

Abmessungen	VE Stück	€/100/Obf.
DIN 912 8.8 Fein	00912.805	



Zylinderschrauben mit Innensechskant, mit metrischem Feingewinde

Maße → TI-12 Anziehmomente → TI-244
 Werkstoffeigensch. → TI-232 Normumstellung → TI-6

DIN 912 Feingew. → wird ersetzt durch ISO 12474

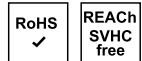

M 8	x	1	x	12	S	200	138,00
M 8	x	1	x	16	S	200	143,00
M 8	x	1	x	20	S	200	148,00
M 8	x	1	x	25	S	200	152,00
M 8	x	1	x	30	S	200	158,00
M 10	x	1	x	16	S	200	102,00
M 10	x	1	x	20	S	200	110,00
M 10	x	1,25	x	20	S	200	85,00
M 10	x	1	x	25	S	200	121,00
M 10	x	1,25	x	25	S	200	121,00
M 10	x	1	x	30	S	200	126,00
M 10	x	1,25	x	30	S	200	126,00
M 10	x	1	x	40	S	100	138,00
M 10	x	1,25	x	40	S	100	138,00
M 10	x	1	x	50	S	100	149,00
M 10	x	1	x	60	S	100	160,00
M 10	x	1	x	70	S	100	171,00
M 10	x	1	x	80	S	100	184,00
M 10	x	1	x	90	S	100	199,00
M 10	x	1	x	100	S	100	209,00
M 12	x	1,5	x	20	S	100	140,00
M 12	x	1,5	x	25	S	100	157,00
M 12	x	1,5	x	30	S	100	167,00
M 12	x	1,5	x	35	S	100	182,00
M 12	x	1,25	x	40	S	100	242,00
M 12	x	1,5	x	40	S	100	195,00
M 12	x	1,5	x	50	S	100	212,00
M 14	x	1,5	x	30	S	100	223,00
M 14	x	1,5	x	35	S	100	255,00
M 14	x	1,5	x	40	S	100	270,00
M 14	x	1,5	x	45	S	50	285,00
M 16	x	1,5	x	30	S	50	335,00
M 16	x	1,5	x	35	S	50	355,00
M 16	x	1,5	x	40	S	50	390,00
M 16	x	1,5	x	45	S	50	410,00
M 16	x	1,5	x	50	S	50	450,00
M 16	x	1,5	x	55	S	50	485,00
M 16	x	1,5	x	60	S	50	520,00
M 16	x	1,5	x	70	S	25	580,00

Abmessungen	VE Stück	€/100/Obf.
DIN 912 10.9	00912.100	

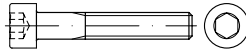

Zylinderschrauben mit Innensechskant

Maße → TI-12 Anziehmomente → TI-244
 Werkstoffeigensch. → TI-232 Normumstellung → TI-6

Rostfrei → S. 477

DIN 912 → wird ersetzt durch ISO 4762



M 3	x	6	S	500	10,10
M 3	x	8	S	500	8,00
M 3	x	10	S	500	6,60
M 3	x	12	S	500	6,90
M 3	x	14	S	500	16,30
M 3	x	16	S	500	7,10
M 3	x	20	S	500	7,60
M 3	x	25	S	500	8,20
M 3	x	30	S	500	9,40
M 4	x	6	S	500	20,20
M 4	x	8	S	500	7,70
M 4	x	10	S	500	7,10
M 4	x	12	S	500	7,20
M 4	x	14	S	500	20,40
M 4	x	16	S	500	7,30
M 4	x	18	S	500	7,60
M 4	x	20	S	500	7,70
M 4	x	22	S	500	20,50
M 4	x	25	S	500	8,00
M 4	x	30	S	500	8,60
M 4	x	35	S	500	8,90
M 4	x	40	S	500	9,70
M 4	x	45	S	500	25,00
M 4	x	50	S	500	26,00
M 4	x	55	S	200	28,50
M 4	x	60	S	200	30,50
M 4	x	65	S	200	31,00
M 4	x	70	S	200	34,50
M 5	x	6	S	500	23,50
M 5	x	8	S	500	16,70
M 5	x	10	S	500	6,20
M 5	x	12	S	500	6,50
M 5	x	14	S	500	17,00
M 5	x	16	S	500	6,60
M 5	x	18	S	500	8,00
M 5	x	20	S	500	6,90
M 5	x	22	S	500	17,70
M 5	x	25	S	500	7,30
M 5	x	30	S	500	7,80
M 5	x	35	S	200	10,40
M 5	x	40	S	200	10,60
M 5	x	45	S	200	18,00
M 5	x	50	S	200	24,20
M 5	x	55	S	200	27,50
M 5	x	60	S	200	29,00
M 5	x	65	S	200	40,00
M 5	x	70	S	200	40,50
M 5	x	75	S	200	64,00
M 5	x	80	S	200	64,00
M 5	x	85	S	200	136,00
M 5	x	90	S	200	70,00
M 5	x	95	S	200	194,00
M 5	x	100	S	200	78,00
M 5	x	110	S	100	181,00

Abmessungen	VE Stück	€/100/Obf.			
M 5	x	120	S	100	186,00
M 5	x	130	S	100	530,00
M 5	x	135	S	100	640,00
M 5	x	140	S	100	640,00
M 5	x	150	S	100	650,00
M 5	x	160	S	100	660,00
M 5	x	170	S	100	700,00
M 5	x	180	S	100	720,00
M 5	x	190	S	100	830,00
M 5	x	200	S	100	910,00
M 6	x	8	S	500	18,60
M 6	x	10	S	500	6,30
M 6	x	12	S	500	6,50
M 6	x	14	S	500	14,60
M 6	x	16	S	500	6,60
M 6	x	18	S	500	7,40
M 6	x	20	S	500	6,70
M 6	x	22	S	500	18,10
M 6	x	25	S	500	6,90
M 6	x	30	S	500	7,90
M 6	x	35	S	200	8,40
M 6	x	40	S	200	9,40
M 6	x	45	S	200	12,30
M 6	x	50	S	200	14,60
M 6	x	55	S	200	23,20
M 6	x	60	S	200	23,60
M 6	x	65	S	200	30,00
M 6	x	70	S	200	39,50
M 6	x	75	S	200	49,00
M 6	x	80	S	200	54,00
M 6	x	85	S	200	96,00
M 6	x	90	S	200	66,00
M 6	x	95	S	200	115,00
M 6	x	100	S	200	79,00
M 6	x	110	S	100	108,00
M 6	x	120	S	100	117,00
M 6	x	130	S	100	360,00
M 6	x	135	S	100	420,00
M 6	x	140	S	100	380,00
M 6	x	145	S	100	520,00
M 6	x	150	S	100	425,00
M 6	x	160	S	100	720,00
M 6	x	170	S	100	790,00
M 6	x	180	S	100	840,00
M 6	x	190	S	100	1030,00
M 6	x	200	S	100	1140,00
M 6	x	210	S	50	1170,00
M 6	x	220	S	50	1190,00
M 6	x	230	S	50	1290,00
M 6	x	240	S	50	1290,00
M 8	x	10	S	200	15,30
M 8	x	12	S	200	15,30
M 8	x	14	S	200	22,70
M 8	x	16	S	200	10,80
M 8	x	18	S	200	11,70
M 8	x	20	S	200	10,20
M 8	x	22	S	200	23,50
M 8	x	25	S	200	11,00
M 8	x	30	S	200	11,60
M 8	x	35	S	200	12,90
M 8	x	40	S	200	14,30
M 8	x	45	S	200	15,10
M 8	x	50	S	200	16,60
M 8	x	55	S	200	22,50
M 8	x	60	S	200	23,00
M 8	x	65	S	200	31,00
M 8	x	70	S	200	32,00
M 8	x	75	S	200	39,50
M 8	x	80	S	200	52,00
M 8	x	85	S	100	78,00
M 8	x	90	S	100	63,00
M 8	x	95	S	100	90,00
M 8	x	100	S	100	74,00
M 8	x	110	S	100	96,00
M 8	x	120	S	100	97,00

Abmessungen	VE	Stück	€/100/Obf.	Abmessungen	VE	Stück	€/100/Obf.	Abmessungen	VE	Stück	€/100/Obf.
M 8 x 125	S	100	209,00	M 12 x 35	S	100	33,50	M 16 x 50	S	50	75,00
M 8 x 130	S	100	148,00	M 12 x 40	S	100	34,00	M 16 x 55	S	50	78,00
M 8 x 135	S	100	224,00	M 12 x 45	S	100	36,00	M 16 x 60	S	50	81,00
M 8 x 140	S	50	163,00	M 12 x 50	S	100	37,50	M 16 x 65	S	25	93,00
M 8 x 150	S	50	275,00	M 12 x 55	S	100	41,50	M 16 x 70	S	25	93,00
M 8 x 160	S	50	310,00	M 12 x 60	S	100	43,50	M 16 x 75	S	25	106,00
M 8 x 170	S	50	355,00	M 12 x 65	S	50	48,00	M 16 x 80	S	25	106,00
M 8 x 180	S	50	375,00	M 12 x 70	S	50	50,00	M 16 x 85	S	25	375,00
M 8 x 190	S	50	590,00	M 12 x 75	S	50	53,00	M 16 x 90	S	25	129,00
M 8 x 200	S	50	590,00	M 12 x 80	S	50	54,00	M 16 x 100	S	25	141,00
M 8 x 220	S	50	660,00	M 12 x 85	S	50	144,00	M 16 x 110	S	25	170,00
M 8 x 240	S	50	830,00	M 12 x 90	S	50	68,00	M 16 x 120	S	25	205,00
M 8 x 250	S	50	880,00	M 12 x 95	S	50	160,00	M 16 x 125	S	25	450,00
M 8 x 260	S	50	880,00	M 12 x 100	S	50	76,00	M 16 x 130	S	25	290,00
M 8 x 270	S	50	950,00	M 12 x 110	S	50	116,00	M 16 x 140	S	25	375,00
M 8 x 280	S	50	950,00	M 12 x 120	S	50	130,00	M 16 x 150	S	25	425,00
M 8 x 300	S	50	1000,00	M 12 x 125	S	50	265,00	M 16 x 160	S	25	520,00
M 10 x 10	S	200	70,00	M 12 x 130	S	50	200,00	M 16 x 170	S	25	610,00
M 10 x 12	S	200	70,00	M 12 x 135	S	50	315,00	M 16 x 180	S	25	610,00
M 10 x 16	S	200	31,00	M 12 x 140	S	50	234,00	M 16 x 190	S	25	760,00
M 10 x 18	S	200	72,00	M 12 x 150	S	50	305,00	M 16 x 200	S	25	860,00
M 10 x 20	S	200	18,70	M 12 x 160	S	25	340,00	M 16 x 210	S	25	1360,00
M 10 x 22	S	200	53,00	M 12 x 170	S	25	365,00	M 16 x 220	S	25	920,00
M 10 x 25	S	200	20,30	M 12 x 180	S	25	390,00	M 16 x 230	S	25	1410,00
M 10 x 30	S	200	21,00	M 12 x 190	S	25	770,00	M 16 x 240	S	25	920,00
M 10 x 35	S	100	22,30	M 12 x 200	S	25	500,00	M 16 x 250	S	25	1500,00
M 10 x 40	S	100	23,20	M 12 x 210	S	25	740,00	M 16 x 260	S	25	1030,00
M 10 x 45	S	100	26,00	M 12 x 220	S	25	740,00	M 16 x 270	S	25	1590,00
M 10 x 50	S	100	27,50	M 12 x 230	S	25	860,00	M 16 x 280	S	25	1130,00
M 10 x 55	S	100	30,00	M 12 x 240	S	25	840,00	M 16 x 290	S	25	1830,00
M 10 x 60	S	100	30,50	M 12 x 250	S	25	1240,00	M 16 x 300	S	25	1270,00
M 10 x 65	S	100	32,00	M 12 x 260	S	25	920,00	M 16 x 320	S	10	1700,00
M 10 x 70	S	100	33,00	M 12 x 270	S	25	1260,00	M 16 x 330	S	10	1700,00
M 10 x 75	S	100	45,00	M 12 x 280	S	25	980,00	M 16 x 340	S	10	1840,00
M 10 x 80	S	100	46,00	M 12 x 290	S	25	1280,00	M 16 x 350	S	10	1860,00
M 10 x 85	S	100	104,00	M 12 x 300	S	25	1060,00	M 16 x 360	S	10	1980,00
M 10 x 90	S	100	60,00	M 12 x 310	S	25	2080,00	M 16 x 380	S	10	2800,00
M 10 x 95	S	100	113,00	M 12 x 320	S	25	2280,00	M 16 x 400	S	10	2950,00
M 10 x 100	S	100	67,00	M 12 x 330	S	25	2700,00	M 18 x 35	S	50	375,00
M 10 x 110	S	50	111,00	M 12 x 340	S	25	2700,00	M 18 x 40	S	50	315,00
M 10 x 115	S	50	229,00	M 12 x 360	S	25	3400,00	M 18 x 45	S	50	320,00
M 10 x 120	S	50	146,00	M 12 x 380	S	25	4050,00	M 18 x 50	S	50	320,00
M 10 x 125	S	50	229,00	M 12 x 400	S	25	4400,00	M 18 x 55	S	25	320,00
M 10 x 130	S	50	172,00	M 14 x 20	S	100	197,00	M 18 x 60	S	25	320,00
M 10 x 135	S	50	260,00	M 14 x 25	S	100	152,00	M 18 x 65	S	25	345,00
M 10 x 140	S	50	193,00	M 14 x 30	S	100	146,00	M 18 x 70	S	25	345,00
M 10 x 145	S	50	380,00	M 14 x 35	S	100	151,00	M 18 x 75	S	25	385,00
M 10 x 150	S	50	285,00	M 14 x 40	S	100	120,00	M 18 x 80	S	25	380,00
M 10 x 160	S	50	320,00	M 14 x 45	S	50	124,00	M 18 x 90	S	25	385,00
M 10 x 170	S	50	375,00	M 14 x 50	S	50	131,00	M 18 x 120	S	25	495,00
M 10 x 180	S	50	395,00	M 14 x 55	S	50	197,00	M 18 x 130	S	25	850,00
M 10 x 190	S	50	445,00	M 14 x 60	S	50	144,00	M 18 x 140	S	25	930,00
M 10 x 200	S	50	445,00	M 14 x 65	S	50	176,00	M 18 x 150	S	25	1040,00
M 10 x 210	S	50	560,00	M 14 x 70	S	50	182,00	M 18 x 160	S	25	1140,00
M 10 x 220	S	50	540,00	M 14 x 75	S	50	206,00	M 18 x 180	S	25	1260,00
M 10 x 230	S	50	650,00	M 14 x 80	S	50	206,00	M 18 x 200	S	25	1260,00
M 10 x 240	S	50	630,00	M 14 x 90	S	50	221,00	M 18 x 210	S	10	1500,00
M 10 x 250	S	50	690,00	M 14 x 100	S	50	249,00	M 18 x 220	S	10	1500,00
M 10 x 260	S	50	710,00	M 14 x 110	S	50	265,00	M 18 x 240	S	10	1590,00
M 10 x 270	S	50	960,00	M 14 x 120	S	50	300,00	M 18 x 250	S	10	1700,00
M 10 x 280	S	50	800,00	M 14 x 125	S	50	660,00	M 18 x 260	S	10	1700,00
M 10 x 290	S	50	1070,00	M 14 x 130	S	50	335,00	M 18 x 280	S	10	1820,00
M 10 x 300	S	50	890,00	M 14 x 140	S	25	425,00	M 18 x 300	S	10	1930,00
M 10 x 310	S	50	2180,00	M 14 x 150	S	25	485,00	M 20 x 20	S	25	570,00
M 10 x 320	S	50	2350,00	M 14 x 160	S	25	780,00	M 20 x 25	S	25	570,00
M 10 x 340	S	50	2850,00	M 14 x 170	S	25	820,00	M 20 x 30	S	25	315,00
M 10 x 350	S	50	3700,00	M 14 x 180	S	25	860,00	M 20 x 35	S	25	315,00
M 10 x 400	S	50	4900,00	M 14 x 190	S	25	880,00	M 20 x 40	S	25	136,00
M 12 x 12	S	100	285,00	M 14 x 200	S	25	910,00	M 20 x 45	S	25	137,00
M 12 x 14	S	100	83,00	M 16 x 20	S	50	197,00	M 20 x 50	S	25	138,00
M 12 x 16	S	100	83,00	M 16 x 25	S	50	143,00	M 20 x 55	S	25	147,00
M 12 x 18	S	100	83,00	M 16 x 30	S	50	66,00	M 20 x 60	S	25	152,00
M 12 x 20	S	100	37,00	M 16 x 35	S	50	69,00	M 20 x 65	S	25	165,00
M 12 x 25	S	100	31,00	M 16 x 40	S	50	71,00	M 20 x 70	S	25	165,00
M 12 x 30	S	100	32,50	M 16 x 45	S	50	73,00	M 20 x 75	S	25	172,00

Abmessungen	VE	Stück	€/100/Obf.	Abmessungen	VE	Stück	€/100/Obf.	Abmessungen	VE	Stück	€/100/Obf.
M 20 x 80	S	25	172,00	M 24 x 160	S	10	1360,00	M 30 x 75	S	10	1630,00
M 20 x 85	S	25	425,00	M 24 x 170	S	10	1630,00	M 30 x 80	S	10	1630,00
M 20 x 90	S	25	201,00	M 24 x 180	S	10	1690,00	M 30 x 85	S	10	1700,00
M 20 x 95	S	25	780,00	M 24 x 190	S	10	2060,00	M 30 x 90	S	10	1700,00
M 20 x 100	S	25	220,00	M 24 x 200	S	10	1810,00	M 30 x 95	S	10	1800,00
M 20 x 110	S	25	249,00	M 24 x 210	S	1	2320,00	M 30 x 100	S	10	1800,00
M 20 x 120	S	25	305,00	M 24 x 220	S	1	2110,00	M 30 x 110	S	10	1890,00
M 20 x 125	S	25	1420,00	M 24 x 230	S	1	2550,00	M 30 x 120	S	10	1980,00
M 20 x 130	S	25	390,00	M 24 x 240	S	1	2300,00	M 30 x 130	S	10	2050,00
M 20 x 135	S	25	1450,00	M 24 x 250	S	1	2750,00	M 30 x 140	S	10	2130,00
M 20 x 140	S	25	570,00	M 24 x 260	S	1	2460,00	M 30 x 150	S	10	2240,00
M 20 x 145	S	25	1480,00	M 24 x 270	S	1	2900,00	M 30 x 160	S	10	2340,00
M 20 x 150	S	25	660,00	M 24 x 280	S	1	2550,00	M 30 x 170	S	10	2460,00
M 20 x 160	S	10	860,00	M 24 x 290	S	1	3050,00	M 30 x 180	S	10	2480,00
M 20 x 170	S	10	1050,00	M 24 x 300	S	1	2650,00	M 30 x 190	S	10	2650,00
M 20 x 180	S	10	920,00	M 24 x 310	S	1	2850,00	M 30 x 200	S	10	2700,00
M 20 x 190	S	10	1020,00	M 24 x 320	S	1	2850,00	M 30 x 210	S	1	2950,00
M 20 x 200	S	10	860,00	M 24 x 330	S	1	3200,00	M 30 x 220	S	1	2950,00
M 20 x 210	S	1	1780,00	M 24 x 340	S	1	3200,00	M 30 x 230	S	1	3250,00
M 20 x 220	S	1	1250,00	M 24 x 350	S	1	3500,00	M 30 x 240	S	1	3250,00
M 20 x 230	S	1	2000,00	M 24 x 360	S	1	3500,00	M 30 x 250	S	1	3500,00
M 20 x 240	S	1	1330,00	M 24 x 380	S	1	3750,00	M 30 x 260	S	1	3500,00
M 20 x 250	S	1	2140,00	M 24 x 400	S	1	4100,00	M 30 x 270	S	1	3750,00
M 20 x 260	S	1	1400,00	M 24 x 420	S	1	5400,00	M 30 x 280	S	1	3400,00
M 20 x 270	S	1	2290,00	M 24 x 440	S	1	5900,00	M 30 x 290	S	1	4300,00
M 20 x 280	S	1	1470,00	M 24 x 450	S	1	6000,00	M 30 x 300	S	1	3700,00
M 20 x 290	S	1	2650,00	M 24 x 460	S	1	6300,00	M 30 x 310	S	1	5500,00
M 20 x 300	S	1	1630,00	M 24 x 480	S	1	6800,00	M 30 x 320	S	1	4800,00
M 20 x 310	S	1	2060,00	M 24 x 500	S	1	7300,00	M 30 x 330	S	1	5900,00
M 20 x 320	S	1	2120,00	M 24 x 520	S	1	7700,00	M 30 x 340	S	1	6100,00
M 20 x 330	S	1	2330,00	M 27 x 40	S	10	1660,00	M 30 x 350	S	1	7000,00
M 20 x 340	S	1	2400,00	M 27 x 45	S	10	1660,00	M 30 x 360	S	1	6600,00
M 20 x 350	S	1	2600,00	M 27 x 50	S	10	1350,00	M 30 x 380	S	1	7200,00
M 20 x 360	S	1	2650,00	M 27 x 55	S	10	1350,00	M 30 x 400	S	1	7900,00
M 20 x 380	S	1	2900,00	M 27 x 60	S	10	1350,00	M 30 x 420	S	1	8400,00
M 20 x 400	S	1	3200,00	M 27 x 65	S	10	1410,00	M 30 x 440	S	1	10900,00
M 22 x 40	S	25	1070,00	M 27 x 70	S	10	1410,00	M 30 x 450	S	1	11900,00
M 22 x 45	S	25	860,00	M 27 x 75	S	10	1470,00	M 30 x 460	S	1	11900,00
M 22 x 50	S	25	1070,00	M 27 x 80	S	10	1470,00	M 30 x 480	S	1	13300,00
M 22 x 60	S	25	1130,00	M 27 x 85	S	10	1520,00	M 30 x 500	S	1	13900,00
M 22 x 65	S	25	1160,00	M 27 x 90	S	10	1520,00	M 30 x 520	S	1	14200,00
M 22 x 70	S	25	1160,00	M 27 x 95	S	10	1590,00	M 33 x 60	S	1	2000,00
M 22 x 75	S	25	1220,00	M 27 x 100	S	10	1590,00	M 33 x 70	S	1	2000,00
M 22 x 80	S	25	1220,00	M 27 x 110	S	10	1630,00	M 33 x 80	S	1	2000,00
M 22 x 90	S	25	1300,00	M 27 x 120	S	10	1800,00	M 33 x 90	S	1	2120,00
M 22 x 100	S	10	1330,00	M 27 x 130	S	1	1880,00	M 33 x 100	S	1	2280,00
M 22 x 110	S	10	1360,00	M 27 x 140	S	1	1950,00	M 33 x 110	S	1	2380,00
M 22 x 120	S	10	1360,00	M 27 x 150	S	1	2020,00	M 33 x 120	S	1	2550,00
M 22 x 130	S	10	1430,00	M 27 x 160	S	1	2080,00	M 33 x 130	S	1	2650,00
M 22 x 140	S	10	1490,00	M 27 x 170	S	1	2600,00	M 33 x 140	S	1	2800,00
M 22 x 150	S	10	1530,00	M 27 x 180	S	1	2230,00	M 33 x 150	S	1	2950,00
M 22 x 160	S	10	1560,00	M 27 x 190	S	1	2800,00	M 33 x 160	S	1	3050,00
M 22 x 180	S	10	1750,00	M 27 x 200	S	1	2330,00	M 33 x 170	S	1	3950,00
M 22 x 200	S	10	2050,00	M 27 x 210	S	1	3600,00	M 33 x 180	S	1	3350,00
M 22 x 220	S	10	2120,00	M 27 x 220	S	1	2650,00	M 33 x 190	S	1	4250,00
M 24 x 30	S	25	930,00	M 27 x 230	S	1	3900,00	M 33 x 200	S	1	3550,00
M 24 x 35	S	25	930,00	M 27 x 240	S	1	2850,00	M 33 x 220	S	1	3850,00
M 24 x 40	S	25	840,00	M 27 x 250	S	1	4150,00	M 33 x 240	S	1	4100,00
M 24 x 45	S	25	860,00	M 27 x 260	S	1	3050,00	M 33 x 260	S	1	4400,00
M 24 x 50	S	25	420,00	M 27 x 270	S	1	3150,00	M 33 x 280	S	1	4600,00
M 24 x 55	S	25	445,00	M 27 x 280	S	1	3200,00	M 33 x 300	S	1	4950,00
M 24 x 60	S	25	445,00	M 27 x 290	S	1	3300,00	M 33 x 320	S	1	5700,00
M 24 x 65	S	25	460,00	M 27 x 300	S	1	3450,00	M 33 x 340	S	1	6200,00
M 24 x 70	S	25	460,00	M 27 x 320	S	1	5000,00	M 33 x 360	S	1	6500,00
M 24 x 75	S	25	480,00	M 27 x 340	S	1	5400,00	M 33 x 380	S	1	7100,00
M 24 x 80	S	25	480,00	M 27 x 360	S	1	5800,00	M 33 x 400	S	1	7700,00
M 24 x 85	S	10	870,00	M 27 x 380	S	1	6600,00	M 36 x 50	S	1	4000,00
M 24 x 90	S	10	550,00	M 27 x 400	S	1	7800,00	M 36 x 55	S	1	4000,00
M 24 x 95	S	10	900,00	M 30 x 40	S	10	1670,00	M 36 x 60	S	1	2700,00
M 24 x 100	S	10	570,00	M 30 x 45	S	10	1670,00	M 36 x 65	S	1	2700,00
M 24 x 110	S	10	630,00	M 30 x 50	S	10	1530,00	M 36 x 70	S	1	2700,00
M 24 x 120	S	10	650,00	M 30 x 55	S	10	1530,00	M 36 x 75	S	1	2700,00
M 24 x 130	S	10	850,00	M 30 x 60	S	10	1530,00	M 36 x 80	S	1	2700,00
M 24 x 140	S	10	1080,00	M 30 x 65	S	10	1590,00	M 36 x 90	S	1	2800,00
M 24 x 150	S	10	1270,00	M 30 x 70	S	10	1590,00	M 36 x 100	S	1	2850,00

Abmessungen	VE	Stück	€/100/Obf.
M 36 x 110	S	1	2950,00
M 36 x 120	S	1	3050,00
M 36 x 130	S	1	3200,00
M 36 x 140	S	1	3300,00
M 36 x 150	S	1	3400,00
M 36 x 160	S	1	3500,00
M 36 x 170	S	1	4350,00
M 36 x 180	S	1	3800,00
M 36 x 190	S	1	3950,00
M 36 x 200	S	1	4100,00
M 36 x 210	S	1	4350,00
M 36 x 220	S	1	4350,00
M 36 x 230	S	1	4550,00
M 36 x 240	S	1	4550,00
M 36 x 250	S	1	4800,00
M 36 x 260	S	1	4800,00
M 36 x 270	S	1	4850,00
M 36 x 280	S	1	5100,00
M 36 x 290	S	1	5400,00
M 36 x 300	S	1	5600,00
M 36 x 310	S	1	6200,00
M 36 x 320	S	1	6600,00
M 36 x 330	S	1	6900,00
M 36 x 340	S	1	7000,00
M 36 x 350	S	1	7200,00
M 36 x 360	S	1	7300,00
M 36 x 380	S	1	7700,00
M 36 x 400	S	1	8300,00
M 36 x 420	S	1	10600,00
M 36 x 440	S	1	12800,00
M 36 x 450	S	1	13300,00
M 36 x 460	S	1	13300,00
M 36 x 480	S	1	13900,00
M 36 x 500	S	1	14300,00
M 42 x 80	S	1	9100,00
M 42 x 90	S	1	9100,00
M 42 x 100	S	1	4500,00
M 42 x 110	S	1	4650,00
M 42 x 120	S	1	4950,00
M 42 x 130	S	1	5000,00
M 42 x 140	S	1	5600,00
M 42 x 150	S	1	5900,00
M 42 x 160	S	1	6100,00
M 42 x 170	S	1	6300,00
M 42 x 180	S	1	6400,00
M 42 x 190	S	1	6700,00
M 42 x 200	S	1	7000,00
M 42 x 220	S	1	8100,00
M 42 x 240	S	1	8800,00
M 42 x 260	S	1	9500,00
M 42 x 280	S	1	10000,00
M 42 x 300	S	1	10900,00
M 42 x 320	S	1	19000,00
M 42 x 400	S	1	22800,00
M 42 x 420	S	1	23200,00
M 48 x 110	S	1	8800,00
M 48 x 160	S	1	10700,00
M 48 x 200	S	1	12500,00
M 48 x 400	S	1	51500,00

Abmessungen	VE	Stück	€/100/Obf.
DIN 00912.110			
912			10.9
			galvanisch verzinkt*

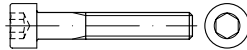

Zylinderschrauben mit Innensechskant
(*getempert)

Maße → **TI-12** Anziehmomente → **TI-244**
 Werkstoffeigensch. → **TI-232** Normumstellung → **TI-6**
 Korrosionsschutz → **TI-228**

Rostfrei → **S. 477**

DIN 912 → wird ersetzt durch ISO 4762



M 3 x 6	S	500	10,50 gal Zn
M 3 x 8	S	500	8,50 gal Zn
M 3 x 10	S	500	7,10 gal Zn
M 3 x 12	S	500	7,50 gal Zn
M 3 x 16	S	500	7,90 gal Zn
M 3 x 20	S	500	8,40 gal Zn
M 3 x 25	S	500	9,20 gal Zn
M 3 x 30	S	500	10,60 gal Zn
M 4 x 6	S	500	14,80 gal Zn
M 4 x 8	S	500	8,70 gal Zn
M 4 x 10	S	500	8,20 gal Zn
M 4 x 12	S	500	8,30 gal Zn
M 4 x 14	S	500	21,70 gal Zn
M 4 x 16	S	500	8,60 gal Zn
M 4 x 18	S	500	8,80 gal Zn
M 4 x 20	S	500	9,10 gal Zn
M 4 x 25	S	500	9,70 gal Zn
M 4 x 30	S	500	10,60 gal Zn
M 4 x 35	S	500	11,50 gal Zn
M 4 x 40	S	500	12,50 gal Zn
M 4 x 45	S	500	28,00 gal Zn
M 4 x 50	S	500	29,50 gal Zn
M 4 x 60	S	200	33,50 gal Zn
M 4 x 65	S	200	34,50 gal Zn
M 5 x 6	S	500	24,90 gal Zn
M 5 x 8	S	500	18,20 gal Zn
M 5 x 10	S	500	7,70 gal Zn
M 5 x 12	S	500	8,20 gal Zn
M 5 x 14	S	500	18,20 gal Zn
M 5 x 16	S	500	8,60 gal Zn
M 5 x 18	S	500	10,30 gal Zn
M 5 x 20	S	500	9,20 gal Zn
M 5 x 25	S	500	9,90 gal Zn
M 5 x 30	S	500	10,80 gal Zn
M 5 x 35	S	200	13,70 gal Zn
M 5 x 40	S	200	14,40 gal Zn
M 5 x 45	S	200	22,10 gal Zn
M 5 x 50	S	200	29,00 gal Zn
M 5 x 55	S	200	32,50 gal Zn
M 5 x 60	S	200	34,50 gal Zn
M 5 x 65	S	200	46,00 gal Zn
M 5 x 70	S	200	47,00 gal Zn
M 5 x 75	S	200	71,00 gal Zn
M 5 x 80	S	200	71,00 gal Zn
M 5 x 85	S	200	143,00 gal Zn
M 5 x 90	S	200	77,00 gal Zn
M 5 x 95	S	200	201,00 gal Zn
M 5 x 100	S	200	85,00 gal Zn
M 5 x 110	S	100	189,00 gal Zn
M 5 x 120	S	100	193,00 gal Zn
M 5 x 130	S	100	540,00 gal Zn

Abmessungen	VE	Stück	€/100/Obf.
M 5 x 140	S	100	540,00 gal Zn
M 5 x 150	S	100	660,00 gal Zn
M 5 x 160	S	100	670,00 gal Zn
M 6 x 8	S	500	23,00 gal Zn
M 6 x 10	S	500	11,80 gal Zn
M 6 x 12	S	500	12,30 gal Zn
M 6 x 14	S	500	20,00 gal Zn
M 6 x 16	S	500	12,60 gal Zn
M 6 x 18	S	500	13,90 gal Zn
M 6 x 20	S	500	13,20 gal Zn
M 6 x 22	S	500	24,60 gal Zn
M 6 x 25	S	500	14,00 gal Zn
M 6 x 30	S	500	15,90 gal Zn
M 6 x 35	S	200	16,70 gal Zn
M 6 x 40	S	200	19,50 gal Zn
M 6 x 45	S	200	21,00 gal Zn
M 6 x 50	S	200	22,10 gal Zn
M 6 x 55	S	200	31,00 gal Zn
M 6 x 60	S	200	32,50 gal Zn
M 6 x 65	S	200	38,00 gal Zn
M 6 x 70	S	200	49,50 gal Zn
M 6 x 75	S	200	59,00 gal Zn
M 6 x 80	S	200	63,00 gal Zn
M 6 x 85	S	200	106,00 gal Zn
M 6 x 90	S	200	76,00 gal Zn
M 6 x 100	S	200	88,00 gal Zn
M 6 x 110	S	100	118,00 gal Zn
M 6 x 120	S	100	128,00 gal Zn
M 6 x 125	S	100	221,00 gal Zn
M 6 x 130	S	100	375,00 gal Zn
M 6 x 140	S	100	395,00 gal Zn
M 6 x 150	S	100	445,00 gal Zn
M 6 x 160	S	100	750,00 gal Zn
M 8 x 10	S	200	20,10 gal Zn
M 8 x 12	S	200	20,10 gal Zn
M 8 x 14	S	200	28,50 gal Zn
M 8 x 16	S	200	16,10 gal Zn
M 8 x 20	S	200	21,70 gal Zn
M 8 x 22	S	200	35,00 gal Zn
M 8 x 25	S	200	23,60 gal Zn
M 8 x 30	S	200	25,00 gal Zn
M 8 x 35	S	200	28,00 gal Zn
M 8 x 40	S	200	31,00 gal Zn
M 8 x 45	S	200	32,50 gal Zn
M 8 x 50	S	200	36,00 gal Zn
M 8 x 55	S	200	43,50 gal Zn
M 8 x 60	S	200	45,00 gal Zn
M 8 x 65	S	200	53,00 gal Zn
M 8 x 70	S	200	50,00 gal Zn
M 8 x 75	S	200	57,00 gal Zn
M 8 x 80	S	200	72,00 gal Zn
M 8 x 90	S	100	84,00 gal Zn
M 8 x 100	S	100	95,00 gal Zn
M 8 x 110	S	100	119,00 gal Zn
M 8 x 120	S	100	128,00 gal Zn
M 8 x 125	S	100	240,00 gal Zn
M 8 x 130	S	100	178,00 gal Zn
M 8 x 140	S	50	193,00 gal Zn
M 8 x 150	S	50	305,00 gal Zn
M 8 x 160	S	50	345,00 gal Zn
M 8 x 170	S	50	390,00 gal Zn
M 8 x 180	S	50	415,00 gal Zn
M 8 x 200	S	50	640,00 gal Zn
M 10 x 10	S	200	80,00 gal Zn
M 10 x 12	S	200	80,00 gal Zn
M 10 x 16	S	200	42,50 gal Zn
M 10 x 20	S	200	39,00 gal Zn
M 10 x 25	S	200	43,00 gal Zn
M 10 x 30	S	200	45,00 gal Zn
M 10 x 35	S	100	48,00 gal Zn
M 10 x 40	S	100	51,00 gal Zn
M 10 x 45	S	100	42,50 gal Zn
M 10 x 50	S	100	45,50 gal Zn
M 10 x 55	S	100	54,00 gal Zn
M 10 x 60	S	100	57,00 gal Zn

Abmessungen	VE	Stück	€/100/Obf.	Abmessungen	VE	Stück	€/100/Obf.	Abmessungen	VE	Stück	€/100/Obf.
M 10 x 65	S	100	58,00 gal Zn	M 14 x 120	S	50	375,00 gal Zn	M 24 x 40	S	25	990,00 gal Zn
M 10 x 70	S	100	63,00 gal Zn	M 14 x 130	S	50	415,00 gal Zn	M 24 x 45	S	25	1000,00 gal Zn
M 10 x 75	S	100	76,00 gal Zn	M 16 x 20	S	50	228,00 gal Zn	M 24 x 50	S	25	580,00 gal Zn
M 10 x 80	S	100	78,00 gal Zn	M 16 x 25	S	50	178,00 gal Zn	M 24 x 60	S	25	630,00 gal Zn
M 10 x 85	S	100	134,00 gal Zn	M 16 x 30	S	50	109,00 gal Zn	M 24 x 65	S	25	630,00 gal Zn
M 10 x 90	S	100	94,00 gal Zn	M 16 x 35	S	50	116,00 gal Zn	M 24 x 70	S	25	660,00 gal Zn
M 10 x 95	S	100	147,00 gal Zn	M 16 x 40	S	50	111,00 gal Zn	M 24 x 80	S	25	700,00 gal Zn
M 10 x 100	S	100	104,00 gal Zn	M 16 x 45	S	50	116,00 gal Zn	M 24 x 90	S	10	790,00 gal Zn
M 10 x 110	S	50	152,00 gal Zn	M 16 x 50	S	50	123,00 gal Zn	M 24 x 100	S	10	830,00 gal Zn
M 10 x 120	S	50	190,00 gal Zn	M 16 x 55	S	50	143,00 gal Zn	M 24 x 110	S	10	910,00 gal Zn
M 10 x 130	S	50	218,00 gal Zn	M 16 x 60	S	50	149,00 gal Zn	M 24 x 120	S	10	950,00 gal Zn
M 10 x 140	S	50	239,00 gal Zn	M 16 x 65	S	25	163,00 gal Zn	M 24 x 130	S	10	1170,00 gal Zn
M 10 x 160	S	50	365,00 gal Zn	M 16 x 70	S	25	166,00 gal Zn	M 24 x 140	S	10	1420,00 gal Zn
M 10 x 170	S	50	420,00 gal Zn	M 16 x 75	S	25	175,00 gal Zn	M 24 x 150	S	10	1630,00 gal Zn
M 10 x 180	S	50	445,00 gal Zn	M 16 x 80	S	25	175,00 gal Zn	M 24 x 160	S	10	1740,00 gal Zn
M 10 x 210	S	50	610,00 gal Zn	M 16 x 85	S	25	445,00 gal Zn	M 24 x 170	S	10	2020,00 gal Zn
M 10 x 220	S	50	610,00 gal Zn	M 16 x 90	S	25	213,00 gal Zn	M 24 x 180	S	10	2110,00 gal Zn
M 12 x 20	S	100	51,00 gal Zn	M 16 x 100	S	25	244,00 gal Zn	M 24 x 190	S	10	2490,00 gal Zn
M 12 x 25	S	100	64,00 gal Zn	M 16 x 110	S	25	280,00 gal Zn	M 24 x 200	S	10	2270,00 gal Zn
M 12 x 30	S	100	67,00 gal Zn	M 16 x 120	S	25	330,00 gal Zn	M 24 x 210	S	1	2750,00 gal Zn
M 12 x 35	S	100	70,00 gal Zn	M 16 x 125	S	25	560,00 gal Zn	M 24 x 220	S	1	2600,00 gal Zn
M 12 x 40	S	100	72,00 gal Zn	M 16 x 130	S	25	420,00 gal Zn	M 24 x 230	S	1	3000,00 gal Zn
M 12 x 45	S	100	65,00 gal Zn	M 16 x 140	S	25	510,00 gal Zn	M 24 x 240	S	1	2800,00 gal Zn
M 12 x 50	S	100	82,00 gal Zn	M 16 x 150	S	25	560,00 gal Zn	M 24 x 260	S	1	2950,00 gal Zn
M 12 x 55	S	100	89,00 gal Zn	M 16 x 160	S	25	720,00 gal Zn	M 24 x 280	S	1	3050,00 gal Zn
M 12 x 60	S	100	94,00 gal Zn	M 16 x 170	S	25	830,00 gal Zn	M 24 x 300	S	1	3150,00 gal Zn
M 12 x 65	S	50	103,00 gal Zn	M 16 x 180	S	25	840,00 gal Zn	M 24 x 320	S	1	4400,00 gal Zn
M 12 x 70	S	50	107,00 gal Zn	M 16 x 200	S	25	1110,00 gal Zn	M 24 x 330	S	1	3800,00 gal Zn
M 12 x 75	S	50	114,00 gal Zn	M 16 x 210	S	25	1630,00 gal Zn	M 27 x 50	S	10	1530,00 gal Zn
M 12 x 80	S	50	115,00 gal Zn	M 16 x 230	S	25	1600,00 gal Zn	M 27 x 60	S	10	1550,00 gal Zn
M 12 x 85	S	50	187,00 gal Zn	M 16 x 240	S	25	1120,00 gal Zn	M 27 x 65	S	10	1610,00 gal Zn
M 12 x 90	S	50	116,00 gal Zn	M 16 x 250	S	25	1710,00 gal Zn	M 27 x 70	S	10	1620,00 gal Zn
M 12 x 95	S	50	206,00 gal Zn	M 16 x 270	S	25	1810,00 gal Zn	M 30 x 40	S	10	1900,00 gal Zn
M 12 x 100	S	50	132,00 gal Zn	M 18 x 50	S	50	395,00 gal Zn	M 30 x 50	S	10	1780,00 gal Zn
M 12 x 110	S	50	188,00 gal Zn	M 18 x 55	S	25	400,00 gal Zn	M 30 x 60	S	10	1810,00 gal Zn
M 12 x 120	S	50	193,00 gal Zn	M 18 x 60	S	25	400,00 gal Zn	M 30 x 65	S	10	1880,00 gal Zn
M 12 x 125	S	50	325,00 gal Zn	M 18 x 65	S	25	425,00 gal Zn	M 30 x 70	S	10	1890,00 gal Zn
M 12 x 130	S	50	295,00 gal Zn	M 18 x 70	S	25	430,00 gal Zn	M 30 x 80	S	10	1970,00 gal Zn
M 12 x 135	S	50	375,00 gal Zn	M 18 x 80	S	25	480,00 gal Zn	M 30 x 90	S	10	2060,00 gal Zn
M 12 x 140	S	50	335,00 gal Zn	M 18 x 90	S	25	500,00 gal Zn	M 30 x 100	S	10	2200,00 gal Zn
M 12 x 150	S	50	410,00 gal Zn	M 18 x 120	S	25	640,00 gal Zn	M 30 x 110	S	10	2300,00 gal Zn
M 12 x 160	S	25	450,00 gal Zn	M 18 x 130	S	25	1000,00 gal Zn	M 30 x 120	S	10	2420,00 gal Zn
M 12 x 170	S	25	485,00 gal Zn	M 18 x 140	S	25	1080,00 gal Zn	M 30 x 130	S	10	2550,00 gal Zn
M 12 x 180	S	25	520,00 gal Zn	M 18 x 150	S	25	1200,00 gal Zn	M 30 x 150	S	10	2800,00 gal Zn
M 12 x 190	S	25	910,00 gal Zn	M 18 x 160	S	25	1320,00 gal Zn	M 30 x 160	S	10	2900,00 gal Zn
M 12 x 200	S	25	640,00 gal Zn	M 18 x 180	S	25	1460,00 gal Zn	M 30 x 170	S	10	3050,00 gal Zn
M 12 x 210	S	25	880,00 gal Zn	M 20 x 20	S	25	660,00 gal Zn	M 30 x 180	S	10	3100,00 gal Zn
M 12 x 220	S	25	890,00 gal Zn	M 20 x 30	S	25	400,00 gal Zn	M 30 x 200	S	10	3350,00 gal Zn
M 12 x 230	S	25	1020,00 gal Zn	M 20 x 35	S	25	400,00 gal Zn	M 30 x 220	S	1	3650,00 gal Zn
M 12 x 240	S	25	1010,00 gal Zn	M 20 x 40	S	25	221,00 gal Zn	M 30 x 230	S	1	4000,00 gal Zn
M 12 x 250	S	25	1410,00 gal Zn	M 20 x 45	S	25	224,00 gal Zn	M 30 x 240	S	1	4000,00 gal Zn
M 12 x 260	S	25	1100,00 gal Zn	M 20 x 50	S	25	236,00 gal Zn	M 30 x 250	S	1	4250,00 gal Zn
M 12 x 270	S	25	1440,00 gal Zn	M 20 x 55	S	25	260,00 gal Zn	M 30 x 260	S	1	4300,00 gal Zn
M 12 x 280	S	25	1170,00 gal Zn	M 20 x 60	S	25	265,00 gal Zn	M 30 x 280	S	1	4300,00 gal Zn
M 12 x 290	S	25	1480,00 gal Zn	M 20 x 65	S	25	285,00 gal Zn	M 30 x 300	S	1	4600,00 gal Zn
M 12 x 300	S	25	1270,00 gal Zn	M 20 x 70	S	25	290,00 gal Zn	M 30 x 320	S	1	5800,00 gal Zn
M 12 x 310	S	25	2290,00 gal Zn	M 20 x 75	S	25	285,00 gal Zn	M 30 x 340	S	1	7300,00 gal Zn
M 12 x 320	S	25	2500,00 gal Zn	M 20 x 80	S	25	310,00 gal Zn	M 30 x 350	S	1	8000,00 gal Zn
M 12 x 330	S	25	2950,00 gal Zn	M 20 x 90	S	25	340,00 gal Zn	M 36 x 50	S	1	4450,00 gal Zn
M 12 x 340	S	25	2950,00 gal Zn	M 20 x 100	S	25	385,00 gal Zn	M 36 x 60	S	1	3150,00 gal Zn
M 12 x 360	S	25	3600,00 gal Zn	M 20 x 110	S	25	420,00 gal Zn	M 36 x 70	S	1	3200,00 gal Zn
M 12 x 380	S	25	4300,00 gal Zn	M 20 x 120	S	25	485,00 gal Zn	M 36 x 80	S	1	3200,00 gal Zn
M 14 x 30	S	100	171,00 gal Zn	M 20 x 130	S	25	590,00 gal Zn	M 36 x 90	S	1	3350,00 gal Zn
M 14 x 35	S	100	178,00 gal Zn	M 20 x 140	S	25	780,00 gal Zn	M 36 x 100	S	1	3450,00 gal Zn
M 14 x 40	S	100	151,00 gal Zn	M 20 x 150	S	25	880,00 gal Zn	M 36 x 110	S	1	3600,00 gal Zn
M 14 x 45	S	50	158,00 gal Zn	M 20 x 160	S	10	1100,00 gal Zn	M 36 x 130	S	1	3900,00 gal Zn
M 14 x 50	S	50	167,00 gal Zn	M 20 x 170	S	10	1290,00 gal Zn	M 36 x 140	S	1	4000,00 gal Zn
M 14 x 55	S	50	236,00 gal Zn	M 20 x 180	S	10	1180,00 gal Zn	M 36 x 150	S	1	4200,00 gal Zn
M 14 x 60	S	50	187,00 gal Zn	M 20 x 190	S	10	1400,00 gal Zn	M 36 x 160	S	1	4350,00 gal Zn
M 14 x 65	S	50	221,00 gal Zn	M 20 x 200	S	10	1250,00 gal Zn	M 36 x 170	S	1	4550,00 gal Zn
M 14 x 70	S	50	229,00 gal Zn	M 20 x 210	S	1	2200,00 gal Zn	M 36 x 180	S	1	4700,00 gal Zn
M 14 x 80	S	50	260,00 gal Zn	M 20 x 220	S	1	1680,00 gal Zn	M 36 x 200	S	1	5400,00 gal Zn
M 14 x 90	S	50	280,00 gal Zn	M 20 x 230	S	1	2430,00 gal Zn	M 36 x 220	S	1	5400,00 gal Zn
M 14 x 100	S	50	315,00 gal Zn	M 20 x 240	S	1	2430,00 gal Zn				
M 14 x 110	S	50	335,00 gal Zn	M 20 x 260	S	1	1840,00 gal Zn				

Abmessungen	VE Stück	€/100/Obf.
DIN	00912.454	
912	10.9	
	fiZn/TL480h	

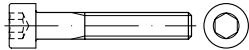

Zylinderschrauben mit Innensechskant

TL = Schmierstoff im Topcoat mit $\mu = 0,09 - 0,14$,
Korrosionsbeständigkeit NSS: 480h RR,
Chrom(VI)-frei

Achtung! Gegenüber galv. verzinkt geänderte Anziehdrehmomente.

Maße → **TI-12** Anziehdrehmomente → **TI-245**
Werkstoffeigensch. → **TI-232** Normumstellung → **TI-6**
Korrosionsschutz → **TI-230**

Rostfrei → **S. 477**

DIN 912 → wird ersetzt durch ISO 4762



M 6	x	12	S	500	14,10 fiZn
M 6	x	14	S	500	23,60 fiZn
M 6	x	16	S	500	14,60 fiZn
M 6	x	18	S	500	16,00 fiZn
M 6	x	20	S	500	15,20 fiZn
M 6	x	22	S	500	28,50 fiZn
M 6	x	25	S	500	16,10 fiZn
M 6	x	30	S	500	18,30 fiZn
M 6	x	35	S	200	19,20 fiZn
M 6	x	40	S	200	22,50 fiZn
M 6	x	45	S	200	24,10 fiZn
M 6	x	50	S	200	25,50 fiZn
M 6	x	55	S	200	35,50 fiZn
M 6	x	60	S	200	37,50 fiZn
M 6	x	65	S	200	43,50 fiZn
M 6	x	70	S	200	57,00 fiZn
M 6	x	75	S	200	68,00 fiZn
M 6	x	80	S	200	73,00 fiZn
M 8	x	16	S	200	18,50 fiZn
M 8	x	20	S	200	25,00 fiZn
M 8	x	25	S	200	27,50 fiZn
M 8	x	30	S	200	29,00 fiZn
M 8	x	35	S	200	32,50 fiZn
M 8	x	40	S	200	36,00 fiZn
M 8	x	45	S	200	37,50 fiZn
M 8	x	50	S	200	41,50 fiZn
M 8	x	55	S	200	50,00 fiZn
M 8	x	60	S	200	52,00 fiZn
M 8	x	65	S	200	61,00 fiZn
M 8	x	70	S	200	58,00 fiZn
M 8	x	75	S	200	66,00 fiZn
M 8	x	80	S	200	83,00 fiZn
M 8	x	90	S	100	97,00 fiZn
M 10	x	20	S	200	45,00 fiZn
M 10	x	25	S	200	49,50 fiZn
M 10	x	30	S	200	52,00 fiZn
M 10	x	35	S	100	55,00 fiZn
M 10	x	40	S	100	59,00 fiZn
M 10	x	45	S	100	49,00 fiZn
M 10	x	50	S	100	52,00 fiZn
M 10	x	55	S	100	62,00 fiZn
M 10	x	60	S	100	66,00 fiZn
M 10	x	65	S	100	67,00 fiZn
M 10	x	70	S	100	72,00 fiZn
M 10	x	75	S	100	88,00 fiZn
M 10	x	80	S	100	89,00 fiZn
M 10	x	90	S	100	108,00 fiZn

Abmessungen	VE Stück	€/100/Obf.			
M 12	x	20	S	100	59,00 fiZn
M 12	x	25	S	100	74,00 fiZn
M 12	x	30	S	100	77,00 fiZn
M 12	x	35	S	100	81,00 fiZn
M 12	x	40	S	100	83,00 fiZn
M 12	x	45	S	100	75,00 fiZn
M 12	x	50	S	100	94,00 fiZn
M 12	x	55	S	100	103,00 fiZn
M 12	x	60	S	100	109,00 fiZn
M 12	x	65	S	50	118,00 fiZn
M 12	x	70	S	50	123,00 fiZn
M 12	x	75	S	50	132,00 fiZn
M 12	x	80	S	50	132,00 fiZn
M 12	x	90	S	50	135,00 fiZn
M 12	x	100	S	50	153,00 fiZn
M 16	x	30	S	50	126,00 fiZn
M 16	x	35	S	50	135,00 fiZn
M 16	x	40	S	50	128,00 fiZn
M 16	x	45	S	50	134,00 fiZn
M 16	x	50	S	50	142,00 fiZn
M 16	x	55	S	50	165,00 fiZn
M 16	x	60	S	50	172,00 fiZn
M 16	x	65	S	25	188,00 fiZn
M 16	x	70	S	25	192,00 fiZn
M 16	x	75	S	25	201,00 fiZn
M 16	x	80	S	25	201,00 fiZn
M 16	x	90	S	25	246,00 fiZn
M 16	x	100	S	25	285,00 fiZn
M 16	x	110	S	25	320,00 fiZn
M 16	x	120	S	25	380,00 fiZn
M 20	x	65	S	25	325,00 fiZn
M 20	x	70	S	25	335,00 fiZn
M 20	x	75	S	25	330,00 fiZn
M 20	x	80	S	25	360,00 fiZn
M 20	x	90	S	25	390,00 fiZn
M 20	x	100	S	25	445,00 fiZn
M 20	x	110	S	25	480,00 fiZn
M 20	x	120	S	25	560,00 fiZn
M 20	x	130	S	25	670,00 fiZn
M 20	x	140	S	25	890,00 fiZn
M 20	x	150	S	25	1010,00 fiZn
M 20	x	160	S	10	1260,00 fiZn
M 20	x	170	S	10	1490,00 fiZn
M 20	x	180	S	10	1360,00 fiZn
M 24	x	80	S	25	810,00 fiZn
M 24	x	90	S	10	910,00 fiZn
M 24	x	100	S	10	950,00 fiZn
M 24	x	110	S	10	1050,00 fiZn
M 24	x	120	S	10	1090,00 fiZn
M 24	x	130	S	10	1350,00 fiZn
M 24	x	140	S	10	1630,00 fiZn
M 24	x	150	S	10	1880,00 fiZn
M 24	x	160	S	10	2010,00 fiZn
M 24	x	170	S	10	2320,00 fiZn
M 24	x	180	S	10	2420,00 fiZn

Abmessungen	VE Stück	€/100/Obf.
DIN	00912.435	
912	10.9	
	fiZnL480h	



Zylinderschrauben mit Innensechskant

fiZnL = int. Schmierstoff mit $\mu = 0,12 - 0,18$,
Korrosionsbeständigkeit NSS: 480h RR,
Chrom(VI)-frei

Maße → **TI-12** Anziehdrehmomente → **TI-244**
Werkstoffeigensch. → **TI-232** Normumstellung → **TI-6**
Korrosionsschutz → **TI-230**

Rostfrei → **S. 477**

DIN 912 → wird ersetzt durch ISO 4762

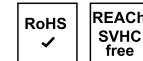

M 4	x	35	S	500	21,20 fiZn
M 5	x	30	S	500	11,90 fiZn
M 5	x	35	S	200	16,40 fiZn
M 5	x	40	S	200	18,40 fiZn
M 5	x	45	S	200	22,00 fiZn
M 6	x	12	S	500	14,10 fiZn
M 6	x	14	S	500	23,60 fiZn
M 6	x	16	S	500	14,60 fiZn
M 6	x	18	S	500	16,00 fiZn
M 6	x	20	S	500	15,20 fiZn
M 6	x	22	S	500	28,50 fiZn
M 6	x	25	S	500	16,10 fiZn
M 6	x	30	S	500	18,30 fiZn
M 6	x	35	S	200	19,20 fiZn
M 6	x	40	S	200	22,50 fiZn
M 6	x	45	S	200	24,10 fiZn
M 6	x	50	S	200	25,50 fiZn
M 6	x	55	S	200	35,50 fiZn
M 6	x	60	S	200	37,50 fiZn
M 6	x	65	S	200	43,50 fiZn
M 6	x	70	S	200	57,00 fiZn
M 6	x	75	S	200	68,00 fiZn
M 6	x	80	S	200	73,00 fiZn
M 6	x	85	S	200	83,00 fiZn
M 6	x	90	S	200	97,00 fiZn
M 6	x	95	S	200	107,00 fiZn
M 6	x	100	S	200	121,00 fiZn
M 6	x	105	S	200	135,00 fiZn
M 6	x	110	S	200	149,00 fiZn
M 6	x	115	S	200	163,00 fiZn
M 6	x	120	S	200	177,00 fiZn
M 6	x	125	S	200	191,00 fiZn
M 6	x	130	S	200	205,00 fiZn
M 6	x	135	S	200	219,00 fiZn
M 6	x	140	S	200	233,00 fiZn
M 6	x	145	S	200	247,00 fiZn
M 6	x	150	S	200	261,00 fiZn
M 6	x	155	S	200	275,00 fiZn
M 6	x	160	S	200	289,00 fiZn
M 6	x	165	S	200	303,00 fiZn
M 6	x	170	S	200	317,00 fiZn
M 6	x	175	S	200	331,00 fiZn
M 6	x	180	S	200	345,00 fiZn
M 6	x	185	S	200	359,00 fiZn
M 6	x	190	S	200	373,00 fiZn
M 6	x	195	S	200	387,00 fiZn
M 6	x	200	S	200	401,00 fiZn
M 6	x	205	S	200	415,00 fiZn
M 6	x	210	S	200	429,00 fiZn
M 6	x	215	S	200	443,00 fiZn
M 6	x	220	S	200	457,00 fiZn
M 6	x	225	S	200	471,00 fiZn
M 6	x	230	S	200	485,00 fiZn
M 6	x	235	S	200	499,00 fiZn
M 6	x	240	S	200	513,00 fiZn
M 6	x	245	S	200	527,00 fiZn
M 6	x	250	S	200	541,00 fiZn
M 6	x	255	S	200	555,00 fiZn
M 6	x	260	S	200	569,00 fiZn
M 6	x	265	S	200	583,00 fiZn
M 6	x	270	S	200	597,00 fiZn
M 6	x	275	S	200	611,00 fiZn
M 6	x	280	S	200	625,00 fiZn
M 6	x	285	S	200	639,00 fiZn
M 6	x	290	S	200	653,00 fiZn
M 6	x	295	S	200	667,00 fiZn
M 6	x	300	S	200	681,00 fiZn
M 6	x	305	S	200	695,00 fiZn
M 6	x	310	S	200	709,00 fiZn
M 6	x	315	S	200	723,00 fiZn
M 6	x	320	S	200	737,00 fiZn
M 6	x	325	S	200	751,00 fiZn
M 6	x	330	S	200	765,00 fiZn
M 6	x	335	S	200	779,00 fiZn
M 6	x	340	S	200	793,00 fiZn
M 6	x	345	S	200	807,00 fiZn
M 6	x	350	S	200	821,00 fiZn

- ✓ Große Artikelvielfalt
- ✓ Verlässliche Qualität
- ✓ Hohe Lieferbereitschaft

Abmessungen	VE	Stück	€/100/Obf.	Abmessungen	VE	Stück	€/100/Obf.	Abmessungen	VE	Stück	€/100/Obf.
M 5 x 105	S	100	182,00	M 6 x 200	S	100	1110,00	M 10 x 110	S	50	111,00
M 5 x 110	S	100	87,00	M 6 x 210	S	100	1160,00	M 10 x 120	S	50	146,00
M 5 x 115	S	100	212,00	M 6 x 220	S	100	1200,00	M 10 x 130	S	50	172,00
M 5 x 120	S	100	128,00	M 6 x 230	S	100	1300,00	M 10 x 140	S	50	193,00
M 5 x 125	S	100	590,00	M 6 x 240	S	100	1320,00	M 10 x 150	S	50	285,00
M 5 x 130	S	100	530,00	M 6 x 250	S	100	1440,00	M 10 x 160	S	50	355,00
M 5 x 135	S	100	650,00	M 6 x 260	S	100	1470,00	M 10 x 170	S	50	420,00
M 5 x 140	S	100	670,00	M 6 x 270	S	100	1620,00	M 10 x 180	S	50	445,00
M 5 x 145	S	100	650,00	M 6 x 280	S	100	2040,00	M 10 x 190	S	50	600,00
M 5 x 150	S	100	670,00	M 6 x 290	S	100	2370,00	M 10 x 200	S	50	500,00
M 5 x 155	S	100	660,00	M 6 x 300	S	100	2800,00	M 10 x 210	S	50	560,00
M 5 x 160	S	100	710,00	M 8 x 8	S	200	181,00	M 10 x 220	S	50	540,00
M 5 x 165	S	100	700,00	M 8 x 10	S	200	15,30	M 10 x 230	S	50	650,00
M 5 x 170	S	100	750,00	M 8 x 12	S	200	15,30	M 10 x 240	S	50	630,00
M 5 x 175	S	100	750,00	M 8 x 14	S	200	22,60	M 10 x 250	S	50	690,00
M 5 x 180	S	100	750,00	M 8 x 16	S	200	10,80	M 10 x 260	S	50	710,00
M 5 x 190	S	100	910,00	M 8 x 18	S	200	11,70	M 10 x 270	S	50	960,00
M 5 x 200	S	100	910,00	M 8 x 20	S	200	10,20	M 10 x 280	S	50	800,00
M 5 x 210	S	100	1150,00	M 8 x 22	S	200	23,50	M 10 x 290	S	50	1070,00
M 5 x 220	S	100	1150,00	M 8 x 25	S	200	11,00	M 10 x 300	S	50	890,00
M 5 x 230	S	100	1170,00	M 8 x 30	S	200	11,60	M 12 x 12	S	100	325,00
M 5 x 240	S	100	1220,00	M 8 x 35	S	200	12,90	M 12 x 16	S	100	42,00
M 6 x 6	S	500	192,00	M 8 x 40	S	200	14,30	M 12 x 18	S	100	42,00
M 6 x 6	K	100	195,00	M 8 x 45	S	200	15,10	M 12 x 20	S	100	37,00
M 6 x 8	S	500	18,60	M 8 x 50	S	200	16,60	M 12 x 22	S	100	102,00
M 6 x 8	K	100	22,20	M 8 x 55	S	200	22,50	M 12 x 25	S	100	31,00
M 6 x 10	S	500	6,30	M 8 x 60	S	200	23,00	M 12 x 30	S	100	32,50
M 6 x 10	K	100	10,00	M 8 x 65	S	200	31,00	M 12 x 35	S	100	33,50
M 6 x 12	S	500	14,20	M 8 x 70	S	200	32,00	M 12 x 40	S	100	34,00
M 6 x 12	K	100	17,90	M 8 x 75	S	200	39,50	M 12 x 45	S	100	36,00
M 6 x 14	S	500	14,60	M 8 x 80	S	200	52,00	M 12 x 50	S	100	37,50
M 6 x 16	S	500	6,60	M 8 x 90	S	100	63,00	M 12 x 55	S	100	41,50
M 6 x 16	K	100	10,20	M 8 x 100	S	100	74,00	M 12 x 60	S	100	43,50
M 6 x 18	S	500	7,40	M 8 x 110	S	100	96,00	M 12 x 65	S	50	48,00
M 6 x 18	K	100	11,10	M 8 x 120	S	100	97,00	M 12 x 70	S	50	50,00
M 6 x 20	S	500	6,60	M 8 x 130	S	100	148,00	M 12 x 75	S	50	59,00
M 6 x 20	K	100	10,30	M 8 x 140	S	50	163,00	M 12 x 80	S	50	60,00
M 6 x 22	S	500	16,20	M 8 x 150	S	50	275,00	M 12 x 90	S	50	68,00
M 6 x 22	K	100	19,90	M 8 x 160	S	50	325,00	M 12 x 100	S	50	76,00
M 6 x 25	S	500	6,90	M 8 x 170	S	50	375,00	M 12 x 110	S	50	116,00
M 6 x 25	K	100	10,60	M 8 x 180	S	50	400,00	M 12 x 120	S	50	130,00
M 6 x 30	S	500	7,80	M 8 x 190	S	50	660,00	M 12 x 130	S	50	200,00
M 6 x 30	K	100	11,50	M 8 x 200	S	50	570,00	M 12 x 140	S	50	234,00
M 6 x 35	S	200	8,40	M 8 x 210	S	50	710,00	M 12 x 150	S	50	310,00
M 6 x 40	S	200	9,40	M 8 x 220	S	50	730,00	M 12 x 160	S	25	345,00
M 6 x 45	S	200	12,30	M 8 x 230	S	50	770,00	M 12 x 170	S	25	390,00
M 6 x 50	S	200	14,60	M 8 x 240	S	50	800,00	M 12 x 180	S	25	395,00
M 6 x 55	S	200	23,20	M 8 x 250	S	50	850,00	M 12 x 190	S	25	510,00
M 6 x 60	S	200	23,60	M 8 x 260	S	50	890,00	M 12 x 200	S	25	510,00
M 6 x 65	S	200	30,00	M 8 x 270	S	50	920,00	M 12 x 220	S	25	790,00
M 6 x 70	S	200	39,50	M 8 x 280	S	50	950,00	M 12 x 230	S	25	1130,00
M 6 x 75	S	200	49,00	M 8 x 290	S	50	1220,00	M 12 x 240	S	25	840,00
M 6 x 80	S	200	54,00	M 8 x 300	S	50	1300,00	M 12 x 250	S	25	1240,00
M 6 x 85	S	200	101,00	M 8 x 310	S	50	1640,00	M 12 x 260	S	25	920,00
M 6 x 90	S	100	66,00	M 10 x 10	S	200	235,00	M 12 x 280	S	25	980,00
M 6 x 95	S	100	130,00	M 10 x 12	S	200	79,00	M 12 x 300	S	25	1060,00
M 6 x 100	S	100	79,00	M 10 x 16	S	200	31,00	M 12 x 310	S	25	2900,00
M 6 x 105	S	100	160,00	M 10 x 18	S	200	31,00	M 12 x 320	S	1	2900,00
M 6 x 110	S	100	108,00	M 10 x 20	S	200	18,70	M 12 x 340	S	1	3150,00
M 6 x 115	S	100	209,00	M 10 x 22	S	200	52,00	M 12 x 360	S	1	3600,00
M 6 x 120	S	100	117,00	M 10 x 25	S	200	20,30	M 12 x 380	S	1	5600,00
M 6 x 125	S	100	330,00	M 10 x 30	S	200	21,00	M 12 x 400	S	1	6400,00
M 6 x 130	S	100	350,00	M 10 x 35	S	100	22,30	M 14 x 20	S	100	193,00
M 6 x 135	S	100	460,00	M 10 x 40	S	100	23,20	M 14 x 25	S	100	152,00
M 6 x 140	S	100	365,00	M 10 x 45	S	100	26,00	M 14 x 30	S	100	146,00
M 6 x 145	S	100	650,00	M 10 x 50	S	100	27,50	M 14 x 35	S	100	151,00
M 6 x 150	S	100	700,00	M 10 x 55	S	100	30,00	M 14 x 40	S	100	135,00
M 6 x 155	S	100	720,00	M 10 x 60	S	100	33,00	M 14 x 45	S	50	138,00
M 6 x 160	S	100	700,00	M 10 x 65	S	100	37,00	M 14 x 50	S	50	147,00
M 6 x 165	S	100	750,00	M 10 x 70	S	100	33,00	M 14 x 55	S	50	197,00
M 6 x 170	S	100	770,00	M 10 x 75	S	100	45,00	M 14 x 60	S	50	161,00
M 6 x 175	S	100	830,00	M 10 x 80	S	100	46,00	M 14 x 65	S	50	176,00
M 6 x 180	S	100	820,00	M 10 x 85	S	100	104,00	M 14 x 70	S	50	182,00
M 6 x 185	S	100	1020,00	M 10 x 90	S	100	60,00	M 14 x 75	S	50	206,00
M 6 x 190	S	100	1000,00	M 10 x 100	S	100	67,00	M 14 x 80	S	50	206,00

Abmessungen	VE	Stück	€/100/Obf.	Abmessungen	VE	Stück	€/100/Obf.	Abmessungen	VE	Stück	€/100/Obf.
M 14 x 90	S	50	221,00	M 18 x 80	S	25	380,00	M 22 x 110	S	10	1420,00
M 14 x 100	S	50	249,00	M 18 x 90	S	25	385,00	M 22 x 120	S	10	1450,00
M 14 x 110	S	50	265,00	M 18 x 100	S	25	420,00	M 22 x 130	S	1	1490,00
M 14 x 120	S	50	300,00	M 18 x 110	S	25	450,00	M 22 x 140	S	1	1550,00
M 14 x 130	S	50	335,00	M 18 x 120	S	25	495,00	M 22 x 150	S	1	1590,00
M 14 x 140	S	25	425,00	M 18 x 130	S	25	550,00	M 22 x 160	S	1	1630,00
M 14 x 150	S	25	485,00	M 18 x 140	S	25	650,00	M 22 x 170	S	1	1700,00
M 14 x 160	S	25	780,00	M 18 x 150	S	25	760,00	M 22 x 180	S	1	1750,00
M 14 x 170	S	25	820,00	M 18 x 160	S	25	1040,00	M 22 x 200	S	1	2050,00
M 14 x 180	S	25	860,00	M 18 x 170	S	25	1100,00	M 22 x 220	S	1	2120,00
M 14 x 190	S	25	880,00	M 18 x 180	S	25	1150,00	M 22 x 240	S	1	2230,00
M 14 x 200	S	25	910,00	M 18 x 190	S	25	1190,00	M 22 x 260	S	1	2310,00
M 14 x 220	S	10	1100,00	M 18 x 200	S	10	1230,00	M 22 x 280	S	1	2390,00
M 14 x 240	S	10	1140,00	M 18 x 220	S	10	1500,00	M 22 x 300	S	1	2460,00
M 14 x 260	S	10	1190,00	M 18 x 240	S	10	1590,00	M 24 x 40	S	25	840,00
M 14 x 280	S	10	1260,00	M 18 x 260	S	1	1700,00	M 24 x 45	S	25	860,00
M 14 x 300	S	10	1340,00	M 18 x 280	S	1	1820,00	M 24 x 50	S	25	420,00
M 16 x 20	S	50	197,00	M 18 x 300	S	1	1930,00	M 24 x 55	S	25	445,00
M 16 x 22	S	50	480,00	M 20 x 30	S	25	355,00	M 24 x 60	S	25	445,00
M 16 x 25	S	50	143,00	M 20 x 35	S	25	355,00	M 24 x 65	S	25	460,00
M 16 x 30	S	50	66,00	M 20 x 40	S	25	136,00	M 24 x 70	S	25	460,00
M 16 x 35	S	50	69,00	M 20 x 45	S	25	137,00	M 24 x 75	S	25	480,00
M 16 x 40	S	50	71,00	M 20 x 50	S	25	138,00	M 24 x 80	S	25	480,00
M 16 x 45	S	50	73,00	M 20 x 55	S	25	147,00	M 24 x 90	S	10	550,00
M 16 x 50	S	50	75,00	M 20 x 60	S	25	152,00	M 24 x 100	S	10	570,00
M 16 x 55	S	50	78,00	M 20 x 65	S	25	165,00	M 24 x 110	S	10	630,00
M 16 x 60	S	50	81,00	M 20 x 70	S	25	165,00	M 24 x 120	S	10	650,00
M 16 x 65	S	25	93,00	M 20 x 75	S	25	172,00	M 24 x 130	S	1	1080,00
M 16 x 70	S	25	93,00	M 20 x 80	S	25	192,00	M 24 x 140	S	1	1100,00
M 16 x 75	S	25	106,00	M 20 x 90	S	25	201,00	M 24 x 150	S	1	1290,00
M 16 x 80	S	25	106,00	M 20 x 100	S	25	220,00	M 24 x 160	S	1	1700,00
M 16 x 85	S	25	129,00	M 20 x 110	S	25	249,00	M 24 x 170	S	1	1900,00
M 16 x 90	S	25	129,00	M 20 x 120	S	25	305,00	M 24 x 180	S	1	2130,00
M 16 x 100	S	25	141,00	M 20 x 130	S	25	390,00	M 24 x 190	S	1	2240,00
M 16 x 110	S	25	170,00	M 20 x 140	S	25	570,00	M 24 x 200	S	1	2240,00
M 16 x 120	S	25	205,00	M 20 x 150	S	25	660,00	M 24 x 210	S	1	2440,00
M 16 x 130	S	25	305,00	M 20 x 160	S	10	670,00	M 24 x 220	S	1	2300,00
M 16 x 140	S	25	335,00	M 20 x 170	S	10	940,00	M 24 x 230	S	1	2600,00
M 16 x 150	S	25	395,00	M 20 x 180	S	10	920,00	M 24 x 240	S	1	2390,00
M 16 x 160	S	25	440,00	M 20 x 190	S	10	1020,00	M 24 x 250	S	1	2750,00
M 16 x 170	S	25	540,00	M 20 x 200	S	10	860,00	M 24 x 260	S	1	2470,00
M 16 x 180	S	25	540,00	M 20 x 210	S	10	1780,00	M 24 x 270	S	1	2900,00
M 16 x 190	S	25	710,00	M 20 x 220	S	10	1250,00	M 24 x 280	S	1	2550,00
M 16 x 200	S	25	610,00	M 20 x 230	S	10	2000,00	M 24 x 290	S	1	3050,00
M 16 x 210	S	25	1380,00	M 20 x 240	S	10	1330,00	M 24 x 300	S	1	2650,00
M 16 x 220	S	25	920,00	M 20 x 250	S	10	2140,00	M 24 x 310	S	1	2850,00
M 16 x 230	S	25	1440,00	M 20 x 260	S	10	1400,00	M 24 x 320	S	1	2850,00
M 16 x 240	S	25	920,00	M 20 x 270	S	10	2290,00	M 24 x 330	S	1	3200,00
M 16 x 250	S	25	1500,00	M 20 x 280	S	10	1470,00	M 24 x 340	S	1	3200,00
M 16 x 260	S	25	1030,00	M 20 x 290	S	10	2650,00	M 24 x 350	S	1	3500,00
M 16 x 270	S	25	1590,00	M 20 x 300	S	10	1630,00	M 24 x 360	S	1	3500,00
M 16 x 280	S	25	1130,00	M 20 x 310	S	1	2060,00	M 24 x 380	S	1	3750,00
M 16 x 290	S	25	1830,00	M 20 x 320	S	1	2120,00	M 24 x 400	S	1	4100,00
M 16 x 300	S	25	1270,00	M 20 x 330	S	1	2330,00	M 24 x 420	S	1	5400,00
M 16 x 310	S	1	1560,00	M 20 x 340	S	1	2400,00	M 24 x 440	S	1	5900,00
M 16 x 320	S	1	1700,00	M 20 x 350	S	1	2600,00	M 24 x 450	S	1	6500,00
M 16 x 330	S	1	1700,00	M 20 x 360	S	1	2650,00	M 24 x 460	S	1	6300,00
M 16 x 340	S	1	1840,00	M 20 x 380	S	1	2900,00	M 24 x 480	S	1	6800,00
M 16 x 350	S	1	1860,00	M 20 x 400	S	1	3200,00	M 24 x 500	S	1	7300,00
M 16 x 360	S	1	1980,00	M 20 x 420	S	1	3550,00	M 27 x 50	S	10	1410,00
M 16 x 370	S	1	2900,00	M 20 x 440	S	1	3900,00	M 27 x 55	S	10	1410,00
M 16 x 380	S	1	2800,00	M 20 x 460	S	1	4250,00	M 27 x 60	S	10	1410,00
M 16 x 390	S	1	3350,00	M 20 x 480	S	1	4600,00	M 27 x 65	S	10	1460,00
M 16 x 400	S	1	2950,00	M 20 x 500	S	1	4950,00	M 27 x 70	S	10	1460,00
M 16 x 420	S	1	3750,00	M 22 x 40	S	25	820,00	M 27 x 75	S	10	1520,00
M 18 x 30	S	50	415,00	M 22 x 45	S	25	820,00	M 27 x 80	S	10	1520,00
M 18 x 35	S	50	415,00	M 22 x 50	S	25	1030,00	M 27 x 90	S	10	1580,00
M 18 x 40	S	50	315,00	M 22 x 55	S	25	1170,00	M 27 x 100	S	10	1660,00
M 18 x 45	S	50	320,00	M 22 x 60	S	25	1170,00	M 27 x 110	S	10	1700,00
M 18 x 50	S	50	320,00	M 22 x 65	S	25	1210,00	M 27 x 120	S	10	1870,00
M 18 x 55	S	25	320,00	M 22 x 70	S	25	1210,00	M 27 x 130	S	1	1950,00
M 18 x 60	S	25	320,00	M 22 x 75	S	25	1270,00	M 27 x 140	S	1	2030,00
M 18 x 65	S	25	345,00	M 22 x 80	S	25	1270,00	M 27 x 150	S	1	2110,00
M 18 x 70	S	25	345,00	M 22 x 90	S	25	1360,00	M 27 x 160	S	1	2160,00
M 18 x 75	S	25	380,00	M 22 x 100	S	10	1390,00	M 27 x 170	S	1	3100,00

Abmessungen	VE	Stück	€/100/Obf.
M 12 x 25	S	100	81,00 flZn
M 12 x 30	S	100	85,00 flZn
M 12 x 35	S	100	89,00 flZn
M 12 x 40	S	100	92,00 flZn
M 12 x 45	S	100	82,00 flZn
M 12 x 50	S	100	104,00 flZn
M 12 x 55	S	100	113,00 flZn
M 12 x 60	S	100	119,00 flZn
M 12 x 65	S	50	130,00 flZn
M 12 x 70	S	50	136,00 flZn
M 12 x 75	S	50	146,00 flZn
M 12 x 80	S	50	146,00 flZn
M 12 x 90	S	50	149,00 flZn
M 12 x 100	S	50	169,00 flZn
M 16 x 30	S	50	140,00 flZn
M 16 x 35	S	50	149,00 flZn
M 16 x 40	S	50	141,00 flZn
M 16 x 45	S	50	147,00 flZn
M 16 x 50	S	50	157,00 flZn
M 16 x 55	S	50	182,00 flZn
M 16 x 60	S	50	190,00 flZn
M 16 x 65	S	25	207,00 flZn
M 16 x 70	S	25	211,00 flZn
M 16 x 75	S	25	222,00 flZn
M 16 x 80	S	25	222,00 flZn
M 16 x 90	S	25	275,00 flZn
M 16 x 100	S	25	310,00 flZn
M 16 x 110	S	25	355,00 flZn
M 16 x 120	S	25	420,00 flZn
M 20 x 65	S	25	360,00 flZn
M 20 x 70	S	25	370,00 flZn
M 20 x 75	S	25	365,00 flZn
M 20 x 80	S	25	395,00 flZn
M 20 x 90	S	25	430,00 flZn
M 20 x 100	S	25	490,00 flZn
M 20 x 110	S	25	530,00 flZn
M 20 x 120	S	25	610,00 flZn
M 20 x 130	S	25	740,00 flZn
M 20 x 140	S	25	980,00 flZn
M 20 x 150	S	25	1110,00 flZn
M 20 x 160	S	10	1390,00 flZn
M 20 x 170	S	10	1640,00 flZn
M 20 x 180	S	10	1500,00 flZn
M 24 x 80	S	25	890,00 flZn
M 24 x 90	S	10	1000,00 flZn
M 24 x 100	S	10	1050,00 flZn
M 24 x 110	S	10	1150,00 flZn
M 24 x 120	S	10	1200,00 flZn
M 24 x 130	S	10	1480,00 flZn
M 24 x 140	S	10	1800,00 flZn
M 24 x 150	S	10	2070,00 flZn
M 24 x 160	S	10	2210,00 flZn
M 24 x 170	S	10	2550,00 flZn
M 24 x 180	S	10	2700,00 flZn

Abmessungen	VE	Stück	€/100/Obf.
DIN 00912.205			

912 12.9 Fein

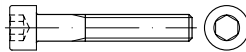

Zylinderschrauben mit Innensechskant, mit metrischem Feingewinde

Maße → **TI-12** Anziehmomente → **TI-244**
 Werkstoffeigensch. → **TI-232** Normumstellung → **TI-6**

DIN 912 Feingew. → wird ersetzt durch ISO 12474

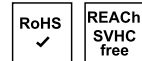

M 8 x 1 x 20	S	200	165,00
M 8 x 1 x 25	S	200	170,00
M 8 x 1 x 30	S	200	204,00
M 8 x 1 x 35	S	200	236,00
M 10 x 1,25 x 20	S	200	128,00
M 10 x 1,25 x 25	S	200	134,00
M 10 x 1 x 30	S	200	163,00
M 10 x 1,25 x 30	S	200	163,00
M 10 x 1 x 35	S	100	213,00
M 10 x 1 x 40	S	100	205,00
M 10 x 1,25 x 40	S	100	205,00
M 10 x 1 x 45	S	100	223,00
M 10 x 1 x 50	S	100	235,00
M 10 x 1,25 x 50	S	100	235,00
M 10 x 1 x 60	S	100	255,00
M 10 x 1,25 x 60	S	100	285,00
M 10 x 1 x 70	S	100	265,00
M 10 x 1 x 80	S	100	275,00
M 10 x 1 x 90	S	100	280,00
M 10 x 1 x 100	S	100	355,00
M 12 x 1,5 x 30	S	100	205,00
M 12 x 1,5 x 35	S	100	223,00
M 12 x 1,5 x 40	S	100	235,00
M 12 x 1,5 x 50	S	100	275,00
M 12 x 1,5 x 60	S	100	320,00
M 12 x 1,5 x 65	S	100	345,00
M 12 x 1,5 x 70	S	50	345,00
M 12 x 1,5 x 80	S	50	370,00
M 14 x 1,5 x 35	S	100	300,00
M 14 x 1,5 x 40	S	100	325,00
M 14 x 1,5 x 45	S	50	355,00
M 14 x 1,5 x 50	S	50	385,00
M 14 x 1,5 x 60	S	50	415,00
M 14 x 1,5 x 80	S	50	445,00
M 14 x 1,5 x 100	S	25	485,00
M 16 x 1,5 x 30	S	50	390,00
M 16 x 1,5 x 35	S	50	410,00
M 16 x 1,5 x 40	S	50	450,00
M 16 x 1,5 x 45	S	50	485,00
M 16 x 1,5 x 50	S	50	520,00
M 16 x 1,5 x 60	S	50	610,00
M 16 x 1,5 x 70	S	25	700,00
M 16 x 1,5 x 80	S	25	760,00
M 16 x 1,5 x 90	S	25	860,00
M 16 x 1,5 x 100	S	25	860,00
M 16 x 1,5 x 110	S	25	910,00
M 16 x 1,5 x 120	S	25	940,00
M 16 x 1,5 x 130	S	25	1010,00
M 16 x 1,5 x 140	S	25	1060,00
M 16 x 1,5 x 150	S	25	1110,00
M 16 x 1,5 x 160	S	25	1150,00
M 20 x 1,5 x 40	S	25	760,00
M 20 x 1,5 x 45	S	25	850,00
M 20 x 1,5 x 50	S	25	850,00

Abmessungen	VE	Stück	€/100/Obf.
M 20 x 1,5 x 55	S	25	940,00
M 20 x 1,5 x 60	S	25	940,00
M 20 x 1,5 x 70	S	25	1050,00
M 20 x 1,5 x 80	S	25	1140,00
M 20 x 1,5 x 90	S	25	1280,00
M 20 x 1,5 x 100	S	25	1410,00
M 24 x 1,5 x 50	S	25	1630,00
M 24 x 2 x 50	S	25	1190,00
M 24 x 2 x 55	S	25	1360,00
M 24 x 1,5 x 60	S	25	1980,00
M 24 x 2 x 60	S	25	1360,00
M 24 x 1,5 x 70	S	25	2230,00
M 24 x 2 x 70	S	25	1510,00
M 24 x 2 x 80	S	25	1670,00
M 24 x 2 x 90	S	10	1840,00
M 24 x 2 x 100	S	10	2040,00

Abmessungen	VE	Stück	€/100/Obf.
DIN 00913.200			

913 45 H

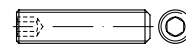

Gewindestifte mit Kegelspitze, mit Innensechskant

Achtung! Nicht für Zugbelastung.

Maße → **TI-20** Normumstellung → **TI-6**
 Werkstoffeigensch. → **TI-232**

Rostfrei → **S. 481**

DIN 913 → wird ersetzt durch ISO 4026 (austauschbar)

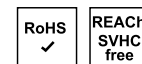

M 1,6 x 2	S	500	305,00
M 1,6 x 2,5	S	500	128,00
M 1,6 x 3	S	500	113,00
M 1,6 x 4	S	500	112,00
M 1,6 x 5	S	500	118,00
M 1,6 x 6	S	500	118,00
M 1,6 x 8	S	500	119,00
M 1,6 x 10	S	500	119,00
M 2 x 2	S	500	112,00
M 2 x 3	S	500	101,00
M 2 x 4	S	500	103,00
M 2 x 5	S	500	105,00
M 2 x 6	S	500	108,00
M 2 x 8	S	500	114,00
M 2 x 10	S	500	123,00
M 2,5 x 3	S	500	83,00
M 2,5 x 4	S	500	86,00
M 2,5 x 5	S	500	89,00
M 2,5 x 6	S	500	94,00
M 2,5 x 8	S	500	97,00
M 2,5 x 10	S	500	101,00
M 3 x 3	S	1000	9,40
M 3 x 4	S	1000	8,80
M 3 x 5	S	1000	8,90
M 3 x 6	S	1000	9,10
M 3 x 6	K	200	9,10
M 3 x 8	S	1000	9,50
M 3 x 8	K	200	9,50
M 3 x 10	S	1000	9,90
M 3 x 12	S	1000	10,50
M 3 x 16	S	500	11,70
M 3 x 20	S	500	12,40
M 4 x 3	S	1000	7,70
M 4 x 4	S	1000	8,20



- ✓ Große Artikelvielfalt
- ✓ Verlässliche Qualität
- ✓ Hohe Lieferbereitschaft

Abmessungen	VE	Stück	€/100/Obf.
M 4 x 5	S	1000	7,80
M 4 x 6	S	1000	7,90
M 4 x 6	K	200	7,90
M 4 x 8	S	1000	8,20
M 4 x 8	K	200	8,20
M 4 x 10	S	1000	8,40
M 4 x 10	K	200	8,40
M 4 x 12	S	1000	8,90
M 4 x 16	S	1000	10,10
M 4 x 16	K	200	10,10
M 4 x 20	S	500	10,30
M 4 x 25	S	500	17,00
M 4 x 30	S	200	45,00
M 4 x 35	S	200	62,00
M 4 x 40	S	200	73,00
M 5 x 4	S	1000	11,90
M 5 x 5	S	1000	8,90
M 5 x 6	S	1000	8,60
M 5 x 8	S	1000	8,90
M 5 x 8	K	200	8,90
M 5 x 10	S	1000	9,20
M 5 x 10	K	200	9,20
M 5 x 12	S	1000	9,90
M 5 x 16	S	1000	10,70
M 5 x 18	S	500	11,80
M 5 x 20	S	500	11,80
M 5 x 25	S	500	17,20
M 5 x 30	S	200	19,00
M 5 x 35	S	200	26,00
M 5 x 40	S	200	29,50
M 6 x 4	S	1000	19,40
M 6 x 5	S	1000	13,20
M 6 x 6	S	1000	10,10
M 6 x 6	K	200	10,10
M 6 x 8	S	1000	9,40
M 6 x 8	K	200	9,40
M 6 x 10	S	1000	9,60
M 6 x 10	K	200	9,60
M 6 x 12	S	1000	10,10
M 6 x 12	K	200	10,10
M 6 x 16	S	500	11,30
M 6 x 16	K	200	11,30
M 6 x 18	S	500	12,90
M 6 x 20	S	500	12,90
M 6 x 20	K	200	12,90
M 6 x 25	S	200	17,60
M 6 x 30	S	200	19,30
M 6 x 35	S	200	23,50
M 6 x 40	S	200	28,00
M 6 x 45	S	200	33,00
M 6 x 50	S	200	36,50
M 6 x 55	S	100	91,00
M 6 x 60	S	100	41,00
M 6 x 70	S	100	184,00
M 8 x 6	S	500	15,30
M 8 x 8	S	500	11,70
M 8 x 8	K	200	11,70
M 8 x 10	S	500	10,90
M 8 x 12	S	500	11,80
M 8 x 16	S	200	13,00
M 8 x 18	S	200	15,50
M 8 x 20	S	200	15,50
M 8 x 25	S	200	20,30
M 8 x 30	S	200	24,60
M 8 x 35	S	200	27,00
M 8 x 40	S	200	34,50
M 8 x 45	S	100	41,50
M 8 x 50	S	100	47,50
M 8 x 55	S	100	68,00
M 8 x 60	S	100	68,00
M 8 x 70	S	100	78,00
M 8 x 80	S	100	92,00
M 10 x 8	S	200	22,80
M 10 x 10	S	200	17,20
M 10 x 12	S	200	15,90

Abmessungen	VE	Stück	€/100/Obf.
M 10 x 16	S	200	18,20
M 10 x 18	S	200	21,50
M 10 x 20	S	200	21,50
M 10 x 25	S	100	25,50
M 10 x 30	S	100	29,50
M 10 x 35	S	100	34,00
M 10 x 40	S	100	42,00
M 10 x 45	S	100	54,00
M 10 x 50	S	100	60,00
M 10 x 55	S	100	92,00
M 10 x 60	S	100	92,00
M 10 x 70	S	100	112,00
M 10 x 80	S	100	134,00
M 10 x 90	S	100	136,00
M 10 x 100	S	100	155,00
M 12 x 10	S	200	42,50
M 12 x 12	S	200	32,50
M 12 x 16	S	200	29,50
M 12 x 18	S	100	34,00
M 12 x 20	S	100	34,00
M 12 x 25	S	100	38,00
M 12 x 30	S	100	42,00
M 12 x 35	S	100	45,50
M 12 x 40	S	100	50,00
M 12 x 45	S	100	57,00
M 12 x 50	S	100	68,00
M 12 x 55	S	100	82,00
M 12 x 60	S	50	82,00
M 12 x 70	S	50	114,00
M 12 x 80	S	50	136,00
M 12 x 90	S	50	355,00
M 12 x 100	S	50	610,00
M 14 x 16	S	100	310,00
M 14 x 20	S	100	91,00
M 14 x 30	S	100	105,00
M 14 x 40	S	50	118,00
M 14 x 50	S	50	151,00
M 16 x 12	S	100	255,00
M 16 x 16	S	100	63,00
M 16 x 18	S	100	68,00
M 16 x 20	S	100	68,00
M 16 x 25	S	100	74,00
M 16 x 30	S	100	79,00
M 16 x 35	S	100	85,00
M 16 x 40	S	50	89,00
M 16 x 45	S	50	101,00
M 16 x 50	S	50	113,00
M 16 x 55	S	50	129,00
M 16 x 60	S	50	159,00
M 16 x 70	S	50	181,00
M 16 x 80	S	50	204,00
M 16 x 90	S	25	227,00
M 16 x 100	S	25	580,00
M 20 x 20	S	100	124,00
M 20 x 25	S	100	132,00
M 20 x 30	S	50	141,00
M 20 x 35	S	50	148,00
M 20 x 40	S	50	157,00
M 20 x 45	S	50	165,00
M 20 x 50	S	50	177,00
M 20 x 60	S	25	230,00
M 20 x 70	S	25	290,00
M 20 x 80	S	25	315,00
M 20 x 90	S	25	370,00
M 24 x 20	S	50	680,00
M 24 x 25	S	50	610,00
M 24 x 30	S	50	255,00
M 24 x 35	S	50	265,00
M 24 x 40	S	25	280,00
M 24 x 45	S	25	550,00
M 24 x 50	S	25	325,00
M 24 x 60	S	25	480,00
M 24 x 70	S	25	530,00

Abmessungen	VE	Stück	€/100/Obf.
M 24 x 80	S	25	570,00
M 24 x 90	S	25	620,00
M 24 x 100	S	25	890,00

DIN	00913.210
913	45 H galvanisch verzinkt

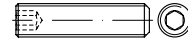

Gewindestifte mit Kegelhuppe, mit Innensechskant

Achtung! Nicht für Zugbelastung.

Maße → **TI-20** Korrosionsschutz → **TI-228**
 Werkstoffeigensch. → **TI-232** Normumstellung → **TI-6**

Rostfrei → **S. 481**

DIN 913 → wird ersetzt durch ISO 4026 (austauschbar)

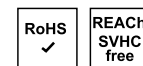

M 2 x 4	S	500	182,00 gal Zn
M 2 x 6	S	500	195,00 gal Zn
M 2 x 8	S	500	201,00 gal Zn
M 2 x 10	S	500	225,00 gal Zn
M 3 x 3	S	1000	14,60 gal Zn
M 3 x 4	S	1000	13,20 gal Zn
M 3 x 5	S	1000	13,40 gal Zn
M 3 x 6	S	1000	13,60 gal Zn
M 3 x 8	S	1000	14,20 gal Zn
M 3 x 10	S	1000	14,70 gal Zn
M 3 x 12	S	1000	15,70 gal Zn
M 3 x 16	S	500	18,10 gal Zn
M 3 x 20	S	500	18,70 gal Zn
M 4 x 4	S	1000	10,50 gal Zn
M 4 x 5	S	1000	10,10 gal Zn
M 4 x 6	S	1000	10,30 gal Zn
M 4 x 8	S	1000	12,10 gal Zn
M 4 x 10	S	1000	12,60 gal Zn
M 4 x 12	S	1000	13,40 gal Zn
M 4 x 14	S	1000	30,00 gal Zn
M 4 x 16	S	1000	15,00 gal Zn
M 4 x 18	S	1000	15,50 gal Zn
M 4 x 20	S	500	15,50 gal Zn
M 4 x 25	S	500	25,50 gal Zn
M 4 x 30	S	500	68,00 gal Zn
M 4 x 35	S	500	92,00 gal Zn
M 4 x 40	S	500	108,00 gal Zn
M 5 x 4	S	1000	17,80 gal Zn
M 5 x 5	S	1000	17,90 gal Zn
M 5 x 6	S	1000	11,30 gal Zn
M 5 x 8	S	1000	11,80 gal Zn
M 5 x 10	S	1000	12,40 gal Zn
M 5 x 12	S	1000	14,10 gal Zn
M 5 x 16	S	1000	15,20 gal Zn
M 5 x 18	S	500	17,10 gal Zn
M 5 x 20	S	500	17,10 gal Zn
M 5 x 25	S	500	26,00 gal Zn
M 5 x 30	S	200	31,00 gal Zn
M 5 x 35	S	200	39,00 gal Zn
M 5 x 40	S	200	44,50 gal Zn
M 6 x 5	S	1000	23,50 gal Zn
M 6 x 6	S	1000	13,40 gal Zn
M 6 x 8	S	1000	12,60 gal Zn
M 6 x 10	S	1000	13,10 gal Zn
M 6 x 12	S	1000	14,10 gal Zn
M 6 x 14	S	1000	17,50 gal Zn
M 6 x 16	S	500	16,70 gal Zn

Abmessungen	VE	Stück	€/100/0bf.	Abmessungen	VE	Stück	€/100/0bf.	Abmessungen	VE	Stück	€/100/0bf.
M 6 x 18	S	500	35,50 gal Zn	M 16 x 70	S	50	335,00 gal Zn	M 8 x 0,5 x 12	S	500	209,00
M 6 x 20	S	500	19,50 gal Zn	M 16 x 80	S	50	365,00 gal Zn	M 8 x 0,75 x 12	S	500	111,00
M 6 x 25	S	200	26,50 gal Zn	M 16 x 90	S	25	410,00 gal Zn	M 8 x 1 x 12	S	500	230,00
M 6 x 30	S	200	29,50 gal Zn	M 20 x 20	S	100	216,00 gal Zn	M 8 x 0,5 x 16	S	200	580,00
M 6 x 35	S	200	37,00 gal Zn	M 20 x 25	S	100	232,00 gal Zn	M 8 x 0,75 x 16	S	200	158,00
M 6 x 40	S	200	42,50 gal Zn	M 20 x 30	S	50	250,00 gal Zn	M 8 x 1 x 16	S	200	236,00
M 6 x 45	S	200	53,00 gal Zn	M 20 x 35	S	50	260,00 gal Zn	M 8 x 0,75 x 20	S	200	199,00
M 6 x 50	S	200	67,00 gal Zn	M 20 x 40	S	50	280,00 gal Zn	M 8 x 1 x 20	S	200	265,00
M 6 x 60	S	100	72,00 gal Zn	M 20 x 50	S	50	315,00 gal Zn	M 8 x 0,75 x 25	S	200	216,00
M 8 x 6	S	500	30,50 gal Zn	M 20 x 60	S	25	340,00 gal Zn	M 8 x 1 x 25	S	200	121,00
M 8 x 8	S	500	16,00 gal Zn	M 20 x 70	S	25	640,00 gal Zn	M 8 x 0,75 x 30	S	200	242,00
M 8 x 10	S	500	15,40 gal Zn	M 20 x 80	S	25	710,00 gal Zn	M 8 x 1 x 30	S	200	128,00
M 8 x 12	S	500	16,70 gal Zn	M 20 x 90	S	25	790,00 gal Zn	M 8 x 1 x 35	S	200	131,00
M 8 x 16	S	200	19,30 gal Zn	M 24 x 25	S	50	800,00 gal Zn	M 8 x 1 x 40	S	200	140,00
M 8 x 18	S	200	27,50 gal Zn	M 24 x 30	S	50	450,00 gal Zn	M 8 x 1 x 50	S	100	182,00
M 8 x 20	S	200	23,20 gal Zn	M 24 x 35	S	50	460,00 gal Zn	M 8 x 1 x 60	S	100	242,00
M 8 x 25	S	200	33,00 gal Zn	M 24 x 40	S	25	495,00 gal Zn	M 8 x 1 x 70	S	100	280,00
M 8 x 30	S	200	39,50 gal Zn	M 24 x 60	S	25	840,00 gal Zn	M 8 x 1 x 80	S	100	325,00
M 8 x 35	S	200	35,50 gal Zn	M 24 x 70	S	25	950,00 gal Zn	M 8 x 1 x 90	S	100	380,00
M 8 x 40	S	200	52,00 gal Zn	M 24 x 80	S	25	1050,00 gal Zn	M 8 x 1 x 100	S	100	420,00
M 8 x 45	S	100	62,00 gal Zn					M 10 x 1 x 8	S	200	250,00
M 8 x 50	S	100	72,00 gal Zn					M 10 x 1,25 x 8	S	200	325,00
M 8 x 55	S	100	108,00 gal Zn					M 10 x 1 x 10	S	200	250,00
M 8 x 60	S	100	118,00 gal Zn					M 10 x 1,25 x 10	S	200	138,00
M 8 x 70	S	100	132,00 gal Zn					M 10 x 1 x 12	S	200	233,00
M 8 x 80	S	100	194,00 gal Zn					M 10 x 1,25 x 12	S	200	157,00
M 8 x 90	S	100	345,00 gal Zn					M 10 x 1 x 16	S	200	335,00
M 8 x 100	S	100	385,00 gal Zn					M 10 x 1,25 x 16	S	200	192,00
M 8 x 130	S	50	480,00 gal Zn					M 10 x 1 x 20	S	200	345,00
M 10 x 8	S	200	34,50 gal Zn					M 10 x 1,25 x 20	S	200	205,00
M 10 x 10	S	200	24,20 gal Zn					M 10 x 1 x 25	S	100	119,00
M 10 x 12	S	200	23,20 gal Zn					M 10 x 1,25 x 25	S	100	228,00
M 10 x 16	S	200	27,50 gal Zn					M 10 x 1 x 30	S	100	136,00
M 10 x 20	S	200	35,50 gal Zn					M 10 x 1,25 x 30	S	100	234,00
M 10 x 25	S	100	42,50 gal Zn					M 10 x 1 x 35	S	100	146,00
M 10 x 30	S	100	51,00 gal Zn					M 10 x 1,25 x 35	S	100	247,00
M 10 x 35	S	100	57,00 gal Zn					M 10 x 1 x 40	S	100	221,00
M 10 x 40	S	100	71,00 gal Zn					M 10 x 1,25 x 40	S	100	265,00
M 10 x 45	S	100	86,00 gal Zn					M 10 x 1 x 45	S	100	221,00
M 10 x 50	S	100	96,00 gal Zn					M 10 x 1 x 50	S	100	232,00
M 10 x 60	S	100	164,00 gal Zn					M 10 x 1,25 x 50	S	100	340,00
M 10 x 70	S	100	195,00 gal Zn					M 10 x 1 x 60	S	100	255,00
M 10 x 80	S	100	233,00 gal Zn					M 10 x 1,25 x 60	S	100	345,00
M 10 x 90	S	100	590,00 gal Zn					M 12 x 1 x 8	S	100	182,00
M 10 x 100	S	100	670,00 gal Zn					M 12 x 1 x 10	S	200	560,00
M 12 x 10	S	200	77,00 gal Zn	M 4 x 0,5 x 4	S	1000	236,00	M 12 x 1,25 x 10	S	200	186,00
M 12 x 12	S	200	48,00 gal Zn	M 4 x 0,5 x 5	S	1000	265,00	M 12 x 1,5 x 10	S	200	600,00
M 12 x 14	S	200	44,00 gal Zn	M 4 x 0,5 x 6	S	1000	280,00	M 12 x 1,25 x 12	S	200	171,00
M 12 x 16	S	200	44,00 gal Zn	M 5 x 0,5 x 6	S	1000	158,00	M 12 x 1,5 x 12	S	200	131,00
M 12 x 20	S	200	54,00 gal Zn	M 5 x 0,5 x 8	S	1000	170,00	M 12 x 1 x 16	S	200	620,00
M 12 x 25	S	100	62,00 gal Zn	M 5 x 0,5 x 10	S	1000	255,00	M 12 x 1,25 x 16	S	200	188,00
M 12 x 30	S	100	72,00 gal Zn	M 5 x 0,5 x 12	S	1000	187,00	M 12 x 1,5 x 16	S	200	137,00
M 12 x 35	S	100	78,00 gal Zn	M 5 x 0,5 x 16	S	1000	212,00	M 12 x 1 x 20	S	100	640,00
M 12 x 40	S	100	91,00 gal Zn	M 5 x 0,5 x 20	S	500	590,00	M 12 x 1,25 x 20	S	100	199,00
M 12 x 45	S	100	105,00 gal Zn	M 5 x 0,5 x 25	S	500	620,00	M 12 x 1,5 x 20	S	100	147,00
M 12 x 50	S	100	120,00 gal Zn	M 5 x 0,5 x 30	S	200	650,00	M 12 x 1 x 25	S	100	790,00
M 12 x 55	S	100	143,00 gal Zn	M 6 x 0,75 x 5	S	1000	128,00	M 12 x 1,25 x 25	S	100	212,00
M 12 x 60	S	50	146,00 gal Zn	M 6 x 0,5 x 6	S	1000	210,00	M 12 x 1,5 x 25	S	100	155,00
M 12 x 70	S	50	201,00 gal Zn	M 6 x 0,75 x 6	S	1000	188,00	M 12 x 1 x 30	S	100	157,00
M 12 x 80	S	50	242,00 gal Zn	M 6 x 0,5 x 8	S	1000	230,00	M 12 x 1,25 x 30	S	100	224,00
M 12 x 90	S	50	340,00 gal Zn	M 6 x 0,75 x 8	S	1000	265,00	M 12 x 1,5 x 30	S	100	165,00
M 12 x 100	S	50	1060,00 gal Zn	M 6 x 0,5 x 10	S	1000	178,00	M 12 x 1 x 40	S	100	201,00
M 14 x 20	S	100	140,00 gal Zn	M 6 x 0,75 x 10	S	1000	295,00	M 12 x 1,25 x 40	S	100	236,00
M 14 x 50	S	50	199,00 gal Zn	M 6 x 0,5 x 12	S	1000	315,00	M 12 x 1,5 x 40	S	100	201,00
M 14 x 60	S	50	275,00 gal Zn	M 6 x 0,75 x 12	S	1000	295,00	M 12 x 1 x 45	S	100	245,00
M 16 x 16	S	100	111,00 gal Zn	M 6 x 0,5 x 16	S	500	238,00	M 12 x 1,5 x 45	S	100	245,00
M 16 x 20	S	100	120,00 gal Zn	M 6 x 0,5 x 20	S	500	217,00	M 12 x 1 x 50	S	100	249,00
M 16 x 25	S	100	132,00 gal Zn	M 6 x 0,75 x 20	S	500	325,00	M 12 x 1,5 x 55	S	100	300,00
M 16 x 30	S	100	138,00 gal Zn	M 8 x 1 x 5	S	500	102,00	M 12 x 1 x 60	S	50	385,00
M 16 x 35	S	100	149,00 gal Zn	M 8 x 1 x 6	S	500	55,00	M 12 x 1,5 x 70	S	50	520,00
M 16 x 40	S	50	160,00 gal Zn	M 8 x 0,75 x 8	S	500	204,00	M 14 x 1 x 10	S	200	415,00
M 16 x 45	S	50	182,00 gal Zn	M 8 x 1 x 8	S	500	140,00	M 14 x 1,5 x 10	S	200	485,00
M 16 x 50	S	50	206,00 gal Zn	M 8 x 0,5 x 10	S	500	345,00	M 14 x 1 x 12	S	200	425,00
M 16 x 55	S	50	249,00 gal Zn	M 8 x 0,75 x 10	S	500	290,00	M 14 x 1,5 x 12	S	200	355,00
M 16 x 60	S	50	249,00 gal Zn	M 8 x 1 x 10	S	500	200,00	M 14 x 1 x 16	S	100	490,00

~DIN 00913.205

913 45 H Fein

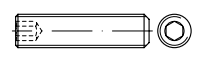

Gewindestifte mit Kegelkuppe, mit Innensechskant, mit metrischem Feingewinde

Achtung! Nicht für Zugbelastung.

Maße → **TI-20** Normumstellung → **TI-6**
 Werkstoffeigensch. → **TI-232**

DIN 913 → wird ersetzt durch ISO 4026 (austauschbar)

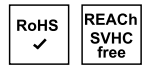

Abmessungen	VE	Stück	€/100/Obf.	Abmessungen	VE	Stück	€/100/Obf.	Abmessungen	VE	Stück	€/100/Obf.
M 14 x 1,5 x 16 S	100		325,00	M 3 x 3 S	1000		10,30	M 10 x 40 S	100		42,00
M 14 x 1 x 20 S	100		720,00	M 3 x 4 S	1000		8,80	M 10 x 45 S	100		54,00
M 14 x 1,5 x 20 S	100		295,00	M 3 x 5 S	1000		8,90	M 10 x 50 S	100		60,00
M 14 x 1,5 x 25 S	100		305,00	M 3 x 6 S	1000		9,10	M 10 x 60 S	100		92,00
M 14 x 1,5 x 30 S	100		320,00	M 3 x 8 S	1000		9,50	M 10 x 70 S	100		112,00
M 14 x 1,5 x 35 S	50		335,00	M 3 x 10 S	1000		9,90	M 10 x 80 S	100		134,00
M 14 x 1,5 x 40 S	50		345,00	M 3 x 12 S	1000		10,50	M 10 x 100 S	100		229,00
M 14 x 1,5 x 45 S	50		360,00	M 3 x 16 S	500		11,70	M 12 x 10 S	200		42,50
M 14 x 1,5 x 50 S	50		415,00	M 3 x 20 S	500		12,40	M 12 x 12 S	200		35,50
M 14 x 1,5 x 60 S	50		460,00	M 4 x 4 S	1000		8,90	M 12 x 16 S	200		29,50
M 16 x 1 x 12 S	100		530,00	M 4 x 5 S	1000		7,80	M 12 x 20 S	100		34,00
M 16 x 1,5 x 12 S	100		260,00	M 4 x 6 S	1000		7,90	M 12 x 25 S	100		38,00
M 16 x 1 x 16 S	100		425,00	M 4 x 8 S	1000		8,20	M 12 x 30 S	100		42,00
M 16 x 1,5 x 16 S	100		320,00	M 4 x 10 S	1000		8,40	M 12 x 35 S	100		45,50
M 16 x 1 x 20 S	100		510,00	M 4 x 12 S	1000		8,90	M 12 x 40 S	100		50,00
M 16 x 1,5 x 20 S	100		325,00	M 4 x 16 S	1000		10,10	M 12 x 45 S	100		57,00
M 16 x 1,5 x 25 S	100		340,00	M 4 x 18 S	1000		10,30	M 12 x 50 S	100		68,00
M 16 x 1,5 x 30 S	100		345,00	M 4 x 20 S	500		10,30	M 12 x 55 S	100		82,00
M 16 x 1,5 x 40 S	50		380,00	M 4 x 25 S	500		17,00	M 12 x 60 S	50		82,00
M 16 x 1,5 x 50 S	50		395,00	M 4 x 30 S	200		45,00	M 12 x 70 S	50		114,00
M 16 x 1,5 x 60 S	50		415,00	M 4 x 35 S	200		62,00	M 12 x 80 S	50		136,00
M 16 x 1,5 x 70 S	50		460,00	M 4 x 40 S	200		73,00	M 14 x 20 S	100		91,00
M 20 x 1,5 x 20 S	100		590,00	M 5 x 4 S	1000		11,90	M 14 x 30 S	100		105,00
M 20 x 1,5 x 25 S	100		630,00	M 5 x 5 S	1000		9,90	M 14 x 40 S	50		118,00
M 20 x 1,5 x 30 S	50		670,00	M 5 x 6 S	1000		8,60	M 16 x 16 S	100		69,00
M 20 x 1,5 x 35 S	50		710,00	M 5 x 8 S	1000		8,90	M 16 x 20 S	100		68,00
M 20 x 1,5 x 40 S	50		740,00	M 5 x 10 S	1000		9,20	M 16 x 25 S	100		74,00
M 20 x 1,5 x 45 S	50		790,00	M 5 x 12 S	1000		9,90	M 16 x 30 S	100		79,00
M 20 x 1,5 x 50 S	50		850,00	M 5 x 16 S	1000		10,70	M 16 x 35 S	100		85,00
M 20 x 1,5 x 60 S	25		920,00	M 5 x 18 S	500		11,80	M 16 x 40 S	50		89,00
M 20 x 1,5 x 70 S	25		1020,00	M 5 x 20 S	500		11,80	M 16 x 45 S	50		121,00
M 20 x 1,5 x 80 S	25		1120,00	M 5 x 25 S	500		17,20	M 16 x 50 S	50		133,00
M 20 x 1,5 x 100 S	25		1230,00	M 5 x 30 S	200		19,00	M 16 x 55 S	50		149,00
M 24 x 1,5 x 25 S	50		1120,00	M 5 x 35 S	200		26,00	M 16 x 60 S	50		149,00
M 24 x 1,5 x 30 S	50		1170,00	M 5 x 40 S	200		29,50	M 16 x 70 S	50		181,00
M 24 x 1,5 x 40 S	25		1350,00	M 6 x 5 S	1000		13,20	M 16 x 80 S	50		204,00
M 24 x 1,5 x 60 S	25		1470,00	M 6 x 6 S	1000		11,10	M 16 x 90 S	25		227,00
				M 6 x 8 S	1000		9,40	M 20 x 20 S	100		136,00
				M 6 x 10 S	1000		9,60	M 20 x 25 S	100		132,00
				M 6 x 12 S	500		10,10	M 20 x 30 S	50		141,00
				M 6 x 16 S	500		11,30	M 20 x 35 S	50		148,00
				M 6 x 18 S	500		12,90	M 20 x 40 S	50		157,00
				M 6 x 20 S	500		12,90	M 20 x 45 S	50		195,00
				M 6 x 25 S	200		17,60	M 20 x 50 S	50		207,00
				M 6 x 30 S	200		19,30	M 20 x 60 S	25		223,00
				M 6 x 35 S	200		23,50	M 20 x 70 S	25		300,00
				M 6 x 40 S	200		28,00	M 20 x 80 S	25		345,00
				M 6 x 45 S	200		33,00	M 20 x 90 S	25		385,00
				M 6 x 50 S	200		36,50	M 24 x 30 S	50		255,00
				M 8 x 6 S	500		15,30	M 24 x 35 S	50		265,00
				M 8 x 8 S	500		12,90	M 24 x 40 S	25		280,00
				M 8 x 10 S	500		10,90	M 24 x 50 S	25		325,00
				M 8 x 12 S	500		11,80	M 24 x 60 S	25		480,00
				M 8 x 16 S	500		13,00	M 24 x 80 S	25		570,00
				M 8 x 18 S	200		15,50	M 24 x 100 S	25		890,00
				M 8 x 20 S	200		15,50				
				M 8 x 25 S	200		20,30				
				M 8 x 30 S	200		24,60				
				M 8 x 35 S	200		27,00				
				M 8 x 40 S	200		34,50				
				M 8 x 45 S	100		41,50				
				M 8 x 50 S	100		47,50				
				M 8 x 55 S	100		68,00				
				M 8 x 60 S	100		68,00				
				M 8 x 70 S	100		78,00				
				M 8 x 80 S	100		92,00				
				M 10 x 8 S	200		22,80				
				M 10 x 10 S	200		18,90				
				M 10 x 12 S	200		15,90				
				M 10 x 16 S	200		18,20				
				M 10 x 18 S	200		21,50				
				M 10 x 20 S	200		21,50				
				M 10 x 25 S	100		25,50				
				M 10 x 30 S	100		29,50				
				M 10 x 35 S	100		34,00				

DIN 00914.200

914 45 H



Gewindestifte mit Spitze, mit Innensechskant

Achtung! Nicht für Zugbelastung.

Maße → TI-20 Normumstellung → TI-6

Werkstoffeigensch. → TI-232

Rostfrei → S. 482

DIN 914 → wird ersetzt durch ISO 4027 (austauschbar)



M 2 x 2 S	500	129,00
M 2 x 3 S	500	117,00
M 2 x 4 S	500	119,00
M 2 x 5 S	500	121,00
M 2 x 6 S	500	126,00
M 2 x 8 S	500	134,00
M 2 x 10 S	500	143,00
M 2,5 x 3 S	500	97,00
M 2,5 x 4 S	500	100,00
M 2,5 x 5 S	500	102,00
M 2,5 x 6 S	500	109,00
M 2,5 x 8 S	500	114,00
M 2,5 x 10 S	500	117,00

- ✓ Große Artikelvielfalt
- ✓ Verlässliche Qualität
- ✓ Hohe Lieferbereitschaft

Abmessungen	VE Stück	€/100/Obf.
DIN 00914.210		
914	45 H	galvanisch verzinkt

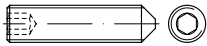

Gewindestifte mit Spitze, mit Innensechskant

Achtung! Nicht für Zugbelastung.

Maße → **TI-20** Korrosionsschutz → **TI-228**
 Werkstoffeigensch. → **TI-232** Normumstellung → **TI-6**

Rostfrei → **S. 482**

DIN 914 → wird ersetzt durch ISO 4027 (austauschbar)



M 3	x	3	S	1000	18,20 gal Zn
M 3	x	4	S	1000	11,30 gal Zn
M 3	x	5	S	1000	11,40 gal Zn
M 3	x	6	S	1000	11,70 gal Zn
M 3	x	8	S	1000	12,30 gal Zn
M 3	x	10	S	1000	13,20 gal Zn
M 4	x	4	S	1000	11,40 gal Zn
M 4	x	5	S	1000	10,30 gal Zn
M 4	x	6	S	1000	10,30 gal Zn
M 4	x	8	S	1000	10,60 gal Zn
M 4	x	10	S	1000	11,20 gal Zn
M 4	x	12	S	1000	12,30 gal Zn
M 4	x	16	S	1000	13,80 gal Zn
M 4	x	18	S	1000	18,20 gal Zn
M 4	x	20	S	500	15,50 gal Zn
M 4	x	25	S	500	30,00 gal Zn
M 4	x	30	S	500	79,00 gal Zn
M 4	x	35	S	500	108,00 gal Zn
M 5	x	4	S	1000	20,80 gal Zn
M 5	x	5	S	1000	17,60 gal Zn
M 5	x	6	S	1000	11,30 gal Zn
M 5	x	8	S	1000	11,80 gal Zn
M 5	x	10	S	1000	12,30 gal Zn
M 5	x	12	S	1000	13,40 gal Zn
M 5	x	16	S	1000	14,60 gal Zn
M 5	x	20	S	500	16,30 gal Zn
M 5	x	25	S	500	55,00 gal Zn
M 5	x	30	S	200	61,00 gal Zn
M 6	x	5	S	1000	16,30 gal Zn
M 6	x	6	S	1000	14,10 gal Zn
M 6	x	8	S	1000	12,50 gal Zn
M 6	x	10	S	1000	13,10 gal Zn
M 6	x	12	S	1000	13,80 gal Zn
M 6	x	16	S	500	16,00 gal Zn
M 6	x	18	S	500	22,50 gal Zn
M 6	x	20	S	500	18,30 gal Zn
M 6	x	25	S	200	26,50 gal Zn
M 6	x	30	S	200	29,50 gal Zn
M 6	x	40	S	200	49,00 gal Zn
M 6	x	45	S	200	58,00 gal Zn
M 8	x	8	S	500	20,00 gal Zn
M 8	x	10	S	500	15,30 gal Zn
M 8	x	12	S	500	17,60 gal Zn
M 8	x	16	S	200	19,20 gal Zn
M 8	x	20	S	200	23,00 gal Zn
M 8	x	25	S	200	33,00 gal Zn
M 8	x	30	S	200	39,50 gal Zn
M 8	x	35	S	200	44,00 gal Zn
M 8	x	40	S	200	61,00 gal Zn
M 8	x	45	S	100	72,00 gal Zn
M 8	x	50	S	100	83,00 gal Zn

Abmessungen	VE Stück	€/100/Obf.			
M 8	x	60	S	100	119,00 gal Zn
M 10	x	10	S	200	27,50 gal Zn
M 10	x	12	S	200	24,50 gal Zn
M 10	x	16	S	200	27,50 gal Zn
M 10	x	20	S	200	38,50 gal Zn
M 10	x	25	S	100	42,50 gal Zn
M 10	x	30	S	100	51,00 gal Zn
M 10	x	35	S	100	63,00 gal Zn
M 10	x	40	S	100	77,00 gal Zn
M 10	x	45	S	100	97,00 gal Zn
M 10	x	50	S	100	105,00 gal Zn
M 12	x	10	S	200	60,00 gal Zn
M 12	x	12	S	200	52,00 gal Zn
M 12	x	16	S	200	46,00 gal Zn
M 12	x	20	S	100	54,00 gal Zn
M 12	x	25	S	100	62,00 gal Zn
M 12	x	30	S	100	72,00 gal Zn
M 12	x	35	S	100	92,00 gal Zn
M 12	x	40	S	100	77,00 gal Zn
M 12	x	50	S	100	120,00 gal Zn
M 12	x	60	S	50	134,00 gal Zn
M 16	x	16	S	100	121,00 gal Zn
M 16	x	20	S	100	120,00 gal Zn
M 16	x	25	S	100	132,00 gal Zn
M 16	x	30	S	100	138,00 gal Zn
M 16	x	35	S	100	144,00 gal Zn
M 16	x	40	S	50	158,00 gal Zn
M 16	x	45	S	50	182,00 gal Zn
M 16	x	50	S	50	200,00 gal Zn
M 16	x	60	S	50	230,00 gal Zn
M 16	x	70	S	50	325,00 gal Zn
M 16	x	80	S	50	360,00 gal Zn
M 16	x	90	S	25	400,00 gal Zn
M 20	x	20	S	100	238,00 gal Zn
M 20	x	30	S	50	265,00 gal Zn
M 20	x	40	S	50	280,00 gal Zn
M 20	x	50	S	50	315,00 gal Zn
M 20	x	60	S	25	345,00 gal Zn

Abmessungen	VE Stück	€/100/Obf.
DIN 00915.200		
915	45 H	

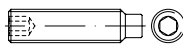

Gewindestifte mit Zapfen, mit Innensechskant

Achtung! Nicht für Zugbelastung.

Maße → **TI-20** Normumstellung → **TI-6**
 Werkstoffeigensch. → **TI-232**

Rostfrei → **S. 483**

DIN 915 → wird ersetzt durch ISO 4028 (austauschbar)



M 3	x	3	S	1000	10,30
M 3	x	4	S	1000	8,80
M 3	x	5	S	1000	8,90
M 3	x	6	S	1000	9,10
M 3	x	8	S	1000	9,50
M 3	x	10	S	1000	9,90
M 3	x	12	S	1000	10,50
M 3	x	16	S	500	11,70
M 3	x	20	S	500	12,40
M 4	x	4	S	1000	8,90
M 4	x	5	S	1000	7,80
M 4	x	6	S	1000	7,90

Abmessungen	VE Stück	€/100/Obf.			
M 4	x	8	S	1000	8,20
M 4	x	10	S	1000	8,40
M 4	x	12	S	1000	8,90
M 4	x	16	S	1000	10,10
M 4	x	20	S	500	10,30
M 4	x	25	S	500	17,00
M 4	x	30	S	200	45,00
M 4	x	35	S	200	62,00
M 4	x	40	S	200	73,00
M 5	x	4	S	1000	11,90
M 5	x	5	S	1000	9,90
M 5	x	6	S	1000	8,60
M 5	x	8	S	1000	8,90
M 5	x	10	S	1000	9,20
M 5	x	12	S	1000	9,90
M 5	x	16	S	1000	10,70
M 5	x	18	S	500	11,80
M 5	x	20	S	500	11,80
M 5	x	25	S	500	17,20
M 5	x	30	S	200	19,00
M 5	x	35	S	200	26,00
M 5	x	40	S	200	29,50
M 6	x	5	S	1000	13,20
M 6	x	6	S	1000	11,10
M 6	x	8	S	1000	9,40
M 6	x	10	S	1000	9,60
M 6	x	12	S	1000	10,10
M 6	x	16	S	500	11,30
M 6	x	18	S	500	12,90
M 6	x	20	S	500	12,90
M 6	x	25	S	500	17,60
M 6	x	30	S	200	19,30
M 6	x	35	S	200	23,50
M 6	x	40	S	200	28,00
M 6	x	45	S	200	33,00
M 6	x	50	S	200	36,50
M 8	x	6	S	500	15,30
M 8	x	8	S	500	12,90
M 8	x	10	S	500	10,90
M 8	x	12	S	500	11,80
M 8	x	16	S	200	13,00
M 8	x	18	S	200	15,50
M 8	x	20	S	200	15,50
M 8	x	25	S	200	20,30
M 8	x	30	S	200	24,60
M 8	x	35	S	200	27,00
M 8	x	40	S	200	34,50
M 8	x	45	S	100	41,50
M 8	x	50	S	100	47,50
M 8	x	55	S	100	68,00
M 8	x	60	S	100	68,00
M 8	x	70	S	100	78,00
M 8	x	80	S	100	92,00
M 10	x	8	S	200	22,80
M 10	x	10	S	200	18,90
M 10	x	12	S	200	15,90
M 10	x	16	S	200	18,20
M 10	x	18	S	200	21,50
M 10	x	20	S	200	21,50
M 10	x	25	S	100	25,50
M 10	x	30	S	100	29,50
M 10	x	35	S	100	34,00
M 10	x	40	S	100	42,00
M 10	x	45	S	100	54,00
M 10	x	50	S	100	60,00
M 10	x	55	S	100	99,00
M 10	x	60	S	100	92,00
M 10	x	70	S	100	112,00
M 10	x	80	S	100	134,00
M 12	x	10	S	200	42,50
M 12	x	12	S	200	35,50
M 12	x	16	S	200	29,50
M 12	x	18	S	100	34,00
M 12	x	20	S	100	34,00
M 12	x	25	S	100	38,00

Abmessungen	VE	Stück	€/100/Obf.
M 12 x 30	S	100	42,00
M 12 x 35	S	100	45,50
M 12 x 40	S	100	50,00
M 12 x 45	S	100	57,00
M 12 x 50	S	100	68,00
M 12 x 55	S	100	82,00
M 12 x 60	S	50	82,00
M 12 x 70	S	50	114,00
M 12 x 80	S	50	136,00
M 14 x 20	S	100	91,00
M 14 x 30	S	100	105,00
M 14 x 40	S	50	118,00
M 16 x 16	S	100	69,00
M 16 x 20	S	100	68,00
M 16 x 25	S	100	74,00
M 16 x 30	S	100	79,00
M 16 x 35	S	100	85,00
M 16 x 40	S	50	89,00
M 16 x 45	S	50	101,00
M 16 x 50	S	50	113,00
M 16 x 55	S	50	129,00
M 16 x 60	S	50	149,00
M 16 x 70	S	50	181,00
M 16 x 80	S	50	204,00
M 16 x 90	S	25	227,00
M 16 x 100	S	25	265,00
M 20 x 20	S	100	136,00
M 20 x 25	S	100	132,00
M 20 x 30	S	50	141,00
M 20 x 35	S	50	148,00
M 20 x 40	S	50	157,00
M 20 x 45	S	50	230,00
M 20 x 50	S	50	177,00
M 20 x 60	S	25	255,00
M 20 x 70	S	25	270,00
M 20 x 80	S	25	340,00
M 20 x 90	S	25	395,00
M 24 x 30	S	50	255,00
M 24 x 35	S	50	265,00
M 24 x 40	S	25	280,00
M 24 x 45	S	25	315,00
M 24 x 50	S	25	325,00
M 24 x 60	S	25	480,00
M 24 x 70	S	25	530,00
M 24 x 80	S	25	570,00
M 24 x 90	S	25	620,00
M 24 x 100	S	25	890,00

DIN	00915.210
915	45 H
	galvanisch verzinkt

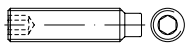

Gewindestifte mit Zapfen, mit Innensechskant

Achtung! Nicht für Zugbelastung.

Maße → **TI-20** Korrosionsschutz → **TI-228**
 Werkstoffeigensch. → **TI-232** Normumstellung → **TI-6**

Rostfrei → **S. 483**

DIN 915 → wird ersetzt durch ISO 4028 (austauschbar)

RoHS	REACH SVHC free
✓	

M 3 x 6	S	1000	12,00 gal Zn
M 3 x 8	S	1000	12,40 gal Zn
M 3 x 10	S	1000	12,80 gal Zn

Abmessungen	VE	Stück	€/100/Obf.
M 3 x 12	S	1000	13,40 gal Zn
M 3 x 16	S	1000	14,60 gal Zn
M 3 x 20	S	500	15,00 gal Zn
M 4 x 4	S	1000	19,70 gal Zn
M 4 x 5	S	1000	18,20 gal Zn
M 4 x 6	S	1000	16,70 gal Zn
M 4 x 8	S	1000	11,10 gal Zn
M 4 x 10	S	1000	11,50 gal Zn
M 4 x 12	S	1000	18,20 gal Zn
M 4 x 16	S	1000	21,80 gal Zn
M 4 x 20	S	500	27,00 gal Zn
M 4 x 25	S	500	30,50 gal Zn
M 4 x 30	S	500	79,00 gal Zn
M 5 x 5	S	1000	13,20 gal Zn
M 5 x 6	S	1000	17,60 gal Zn
M 5 x 8	S	1000	18,00 gal Zn
M 5 x 10	S	1000	12,60 gal Zn
M 5 x 12	S	1000	13,80 gal Zn
M 5 x 16	S	1000	15,20 gal Zn
M 5 x 20	S	500	29,50 gal Zn
M 5 x 25	S	500	20,60 gal Zn
M 5 x 30	S	200	22,60 gal Zn
M 6 x 6	S	1000	22,10 gal Zn
M 6 x 8	S	1000	18,70 gal Zn
M 6 x 10	S	1000	13,50 gal Zn
M 6 x 12	S	1000	14,40 gal Zn
M 6 x 16	S	500	16,60 gal Zn
M 6 x 20	S	500	32,50 gal Zn
M 6 x 25	S	200	37,50 gal Zn
M 6 x 30	S	200	41,00 gal Zn
M 6 x 35	S	200	47,50 gal Zn
M 6 x 40	S	200	33,50 gal Zn
M 6 x 45	S	200	38,00 gal Zn
M 6 x 50	S	200	42,00 gal Zn
M 8 x 8	S	500	18,70 gal Zn
M 8 x 10	S	500	16,70 gal Zn
M 8 x 12	S	500	17,60 gal Zn
M 8 x 16	S	200	20,30 gal Zn
M 8 x 20	S	200	24,50 gal Zn
M 8 x 25	S	200	52,00 gal Zn
M 8 x 30	S	200	59,00 gal Zn
M 8 x 35	S	200	36,00 gal Zn
M 8 x 40	S	200	78,00 gal Zn
M 8 x 50	S	100	107,00 gal Zn
M 10 x 8	S	200	36,50 gal Zn
M 10 x 12	S	200	30,00 gal Zn
M 10 x 16	S	200	32,00 gal Zn
M 10 x 20	S	200	35,50 gal Zn
M 10 x 25	S	100	42,50 gal Zn
M 10 x 30	S	100	56,00 gal Zn
M 10 x 35	S	100	44,00 gal Zn
M 10 x 40	S	100	77,00 gal Zn
M 10 x 50	S	100	148,00 gal Zn
M 10 x 55	S	100	113,00 gal Zn
M 10 x 60	S	100	213,00 gal Zn
M 12 x 12	S	200	56,00 gal Zn
M 12 x 16	S	200	59,00 gal Zn
M 12 x 20	S	100	54,00 gal Zn
M 12 x 25	S	100	66,00 gal Zn
M 12 x 30	S	100	74,00 gal Zn
M 12 x 35	S	100	81,00 gal Zn
M 12 x 40	S	100	87,00 gal Zn
M 12 x 50	S	100	136,00 gal Zn
M 12 x 55	S	100	102,00 gal Zn
M 12 x 60	S	50	102,00 gal Zn
M 12 x 70	S	50	134,00 gal Zn
M 12 x 80	S	50	156,00 gal Zn
M 16 x 16	S	100	134,00 gal Zn
M 16 x 20	S	100	131,00 gal Zn
M 16 x 25	S	100	148,00 gal Zn
M 16 x 30	S	100	161,00 gal Zn
M 16 x 35	S	100	175,00 gal Zn
M 16 x 40	S	50	189,00 gal Zn
M 16 x 45	S	50	211,00 gal Zn
M 16 x 50	S	50	226,00 gal Zn

Abmessungen	VE	Stück	€/100/Obf.
M 16 x 55	S	50	242,00 gal Zn
M 16 x 60	S	50	255,00 gal Zn
M 16 x 70	S	50	365,00 gal Zn
M 20 x 25	S	100	231,00 gal Zn
M 20 x 35	S	50	260,00 gal Zn
M 20 x 40	S	50	275,00 gal Zn
M 20 x 50	S	50	310,00 gal Zn
M 20 x 60	S	25	340,00 gal Zn
M 20 x 70	S	25	450,00 gal Zn
M 20 x 80	S	25	500,00 gal Zn
M 24 x 30	S	50	255,00 gal Zn
M 24 x 40	S	25	270,00 gal Zn

DIN	00916.200
916	45 H

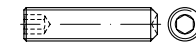

Gewindestifte mit Ringschneide, mit Innensechskant

Achtung! Nicht für Zugbelastung.

Maße → **TI-21** Normumstellung → **TI-6**
 Werkstoffeigensch. → **TI-232**

Rostfrei → **S. 484**

DIN 916 → wird ersetzt durch ISO 4029 (austauschbar)

RoHS	REACH SVHC free
✓	

M 2 x 2,5	S	500	112,00
M 2 x 3	S	500	101,00
M 2 x 4	S	500	103,00
M 2 x 5	S	500	105,00
M 2 x 6	S	500	108,00
M 2,5 x 3	S	500	83,00
M 2,5 x 4	S	500	86,00
M 2,5 x 5	S	500	89,00
M 2,5 x 6	S	500	94,00
M 2,5 x 10	S	500	101,00
M 3 x 3	S	1000	9,40
M 3 x 4	S	1000	8,80
M 3 x 5	S	1000	8,90
M 3 x 6	S	1000	9,10
M 3 x 8	S	1000	9,50
M 3 x 10	S	1000	9,90
M 3 x 12	S	1000	10,50
M 3 x 16	S	500	11,70
M 3 x 20	S	500	12,40
M 4 x 4	S	1000	8,20
M 4 x 5	S	1000	7,80
M 4 x 6	S	1000	7,90
M 4 x 8	S	1000	8,20
M 4 x 10	S	1000	8,40
M 4 x 12	S	1000	8,90
M 4 x 16	S	1000	10,10
M 4 x 20	S	500	10,30
M 4 x 25	S	500	17,00
M 4 x 30	S	200	45,00
M 4 x 40	S	200	73,00
M 5 x 4	S	1000	11,90
M 5 x 5	S	1000	8,90
M 5 x 6	S	1000	8,60
M 5 x 8	S	1000	7,80
M 5 x 10	S	1000	9,20
M 5 x 12	S	1000	9,90
M 5 x 16	S	1000	10,70

Abmessungen	VE	Stück	€/100/Obf.	Abmessungen	VE	Stück	€/100/Obf.	Abmessungen	VE	Stück	€/100/Obf.
M 5 x 18	S	500	11,80	M 16 x 16	S	100	63,00	M 5 x 6	S	1000	11,30 gal Zn
M 5 x 20	S	500	11,80	M 16 x 20	S	100	68,00	M 5 x 8	S	1000	11,80 gal Zn
M 5 x 25	S	500	16,70	M 16 x 25	S	100	74,00	M 5 x 10	S	1000	12,40 gal Zn
M 5 x 30	S	200	19,00	M 16 x 30	S	100	79,00	M 5 x 12	S	1000	18,10 gal Zn
M 5 x 35	S	200	26,00	M 16 x 35	S	100	85,00	M 5 x 16	S	1000	18,70 gal Zn
M 5 x 40	S	200	29,50	M 16 x 40	S	50	89,00	M 5 x 20	S	500	20,70 gal Zn
M 6 x 5	S	1000	13,20	M 16 x 45	S	50	101,00	M 5 x 25	S	500	31,00 gal Zn
M 6 x 6	S	1000	8,80	M 16 x 50	S	50	113,00	M 5 x 30	S	200	33,50 gal Zn
M 6 x 6	K	200	10,10	M 16 x 55	S	50	129,00	M 5 x 40	S	200	43,50 gal Zn
M 6 x 8	S	1000	8,20	M 16 x 60	S	50	129,00	M 6 x 5	S	1000	23,60 gal Zn
M 6 x 8	K	200	9,40	M 16 x 70	S	50	181,00	M 6 x 6	S	1000	16,10 gal Zn
M 6 x 10	S	1000	8,30	M 16 x 80	S	50	204,00	M 6 x 8	S	1000	12,60 gal Zn
M 6 x 10	K	200	9,60	M 16 x 90	S	25	227,00	M 6 x 10	S	1000	13,10 gal Zn
M 6 x 12	S	1000	8,80	M 16 x 100	S	25	495,00	M 6 x 12	S	1000	13,80 gal Zn
M 6 x 12	K	200	10,10	M 20 x 20	S	100	124,00	M 6 x 16	S	500	16,00 gal Zn
M 6 x 16	S	500	9,90	M 20 x 25	S	100	132,00	M 6 x 20	S	500	19,50 gal Zn
M 6 x 16	K	200	11,30	M 20 x 30	S	50	141,00	M 6 x 25	S	200	26,50 gal Zn
M 6 x 18	S	500	12,90	M 20 x 35	S	50	148,00	M 6 x 30	S	200	34,50 gal Zn
M 6 x 20	S	500	12,90	M 20 x 40	S	50	157,00	M 6 x 35	S	200	41,50 gal Zn
M 6 x 25	S	200	17,60	M 20 x 45	S	50	165,00	M 6 x 40	S	200	60,00 gal Zn
M 6 x 30	S	200	19,30	M 20 x 50	S	50	177,00	M 6 x 45	S	200	58,00 gal Zn
M 6 x 35	S	200	23,50	M 20 x 60	S	25	193,00	M 6 x 50	S	200	67,00 gal Zn
M 6 x 40	S	200	28,00	M 20 x 70	S	25	260,00	M 8 x 6	S	500	28,00 gal Zn
M 6 x 45	S	200	33,00	M 20 x 80	S	25	285,00	M 8 x 8	S	500	16,00 gal Zn
M 6 x 50	S	200	36,50	M 20 x 90	S	25	315,00	M 8 x 10	S	500	15,40 gal Zn
M 8 x 6	S	500	15,30	M 24 x 30	S	50	255,00	M 8 x 12	S	500	16,70 gal Zn
M 8 x 8	S	500	10,20	M 24 x 35	S	50	265,00	M 8 x 16	S	200	19,30 gal Zn
M 8 x 8	K	200	11,70	M 24 x 50	S	25	325,00	M 8 x 20	S	200	24,90 gal Zn
M 8 x 10	S	500	10,90	M 24 x 60	S	25	480,00	M 8 x 25	S	200	33,00 gal Zn
M 8 x 12	S	500	11,80	M 24 x 70	S	25	530,00	M 8 x 30	S	200	39,50 gal Zn
M 8 x 16	S	200	13,00	M 24 x 80	S	25	620,00	M 8 x 35	S	200	42,00 gal Zn
M 8 x 18	S	200	15,50	M 24 x 90	S	25	620,00	M 8 x 40	S	200	49,50 gal Zn
M 8 x 20	S	200	15,50	M 24 x 100	S	25	890,00	M 8 x 45	S	100	72,00 gal Zn
M 8 x 25	S	200	20,30					M 8 x 50	S	100	83,00 gal Zn
M 8 x 30	S	200	24,60					M 10 x 8	S	200	27,00 gal Zn
M 8 x 35	S	200	27,00					M 10 x 10	S	200	26,00 gal Zn
M 8 x 40	S	200	34,50					M 10 x 12	S	200	23,20 gal Zn
M 8 x 45	S	100	41,50					M 10 x 14	S	200	36,50 gal Zn
M 8 x 50	S	100	47,50					M 10 x 16	S	200	27,50 gal Zn
M 8 x 55	S	100	68,00					M 10 x 20	S	200	33,00 gal Zn
M 8 x 60	S	100	68,00					M 10 x 25	S	100	44,50 gal Zn
M 8 x 70	S	100	78,00					M 10 x 30	S	100	48,50 gal Zn
M 8 x 80	S	100	92,00					M 10 x 35	S	100	63,00 gal Zn
M 10 x 8	S	200	22,80					M 10 x 40	S	100	77,00 gal Zn
M 10 x 10	S	200	17,20					M 10 x 50	S	100	105,00 gal Zn
M 10 x 12	S	200	15,90					M 10 x 60	S	100	128,00 gal Zn
M 10 x 16	S	200	18,20					M 10 x 70	S	100	147,00 gal Zn
M 10 x 20	S	200	21,50					M 10 x 80	S	100	147,00 gal Zn
M 10 x 25	S	100	25,50					M 12 x 10	S	200	47,50 gal Zn
M 10 x 30	S	100	29,50					M 12 x 12	S	200	38,00 gal Zn
M 10 x 35	S	100	34,00					M 12 x 16	S	200	47,00 gal Zn
M 10 x 40	S	100	42,00					M 12 x 20	S	100	54,00 gal Zn
M 10 x 45	S	100	54,00					M 12 x 25	S	100	62,00 gal Zn
M 10 x 50	S	100	60,00					M 12 x 30	S	100	72,00 gal Zn
M 10 x 60	S	100	92,00					M 12 x 35	S	100	78,00 gal Zn
M 10 x 70	S	100	112,00					M 12 x 40	S	100	85,00 gal Zn
M 10 x 80	S	100	134,00					M 12 x 45	S	100	100,00 gal Zn
M 12 x 10	S	200	42,50					M 12 x 50	S	100	94,00 gal Zn
M 12 x 12	S	200	32,50	M 3 x 3	S	1000	11,80 gal Zn	M 12 x 60	S	50	102,00 gal Zn
M 12 x 16	S	200	29,50	M 3 x 4	S	1000	11,20 gal Zn	M 16 x 16	S	100	111,00 gal Zn
M 12 x 20	S	100	34,00	M 3 x 5	S	1000	11,40 gal Zn	M 16 x 20	S	100	120,00 gal Zn
M 12 x 25	S	100	38,00	M 3 x 6	S	1000	11,70 gal Zn	M 16 x 25	S	100	132,00 gal Zn
M 12 x 30	S	100	42,00	M 3 x 8	S	1000	12,10 gal Zn	M 16 x 30	S	100	138,00 gal Zn
M 12 x 35	S	100	45,50	M 3 x 10	S	1000	12,40 gal Zn	M 16 x 35	S	100	147,00 gal Zn
M 12 x 40	S	100	50,00	M 3 x 12	S	1000	13,10 gal Zn	M 16 x 40	S	50	160,00 gal Zn
M 12 x 45	S	100	57,00	M 3 x 16	S	500	14,20 gal Zn	M 16 x 50	S	50	184,00 gal Zn
M 12 x 50	S	100	68,00	M 3 x 20	S	500	15,00 gal Zn	M 16 x 60	S	50	200,00 gal Zn
M 12 x 55	S	100	82,00	M 4 x 4	S	1000	10,30 gal Zn	M 16 x 70	S	50	255,00 gal Zn
M 12 x 60	S	50	82,00	M 4 x 5	S	1000	10,30 gal Zn	M 16 x 90	S	25	305,00 gal Zn
M 12 x 70	S	50	114,00	M 4 x 6	S	1000	10,30 gal Zn	M 20 x 20	S	100	197,00 gal Zn
M 12 x 80	S	50	136,00	M 4 x 8	S	1000	10,60 gal Zn	M 20 x 30	S	50	213,00 gal Zn
M 14 x 20	S	100	91,00	M 4 x 10	S	1000	15,30 gal Zn				
M 14 x 30	S	100	105,00	M 4 x 12	S	1000	16,60 gal Zn				
M 14 x 40	S	50	118,00	M 4 x 16	S	1000	18,10 gal Zn				
M 14 x 50	S	50	151,00	M 4 x 20	S	500	18,70 gal Zn				
				M 5 x 5	S	1000	11,70 gal Zn				

DIN	00916.210
916	45 H galvanisch verzinkt



Gewindestifte mit Ringschneide, mit Innensechskant

Achtung! Nicht für Zugbelastung.

Maße → **TI-21** Korrosionsschutz → **TI-228**
 Werkstoffeigensch. → **TI-232** Normumstellung → **TI-6**

Rostfrei → **S. 484**

DIN 916 → wird ersetzt durch ISO 4029 (austauschbar)

RoHS	REACH
✓	SVHC free

Abmessungen	VE Stück	€/100/Obf.
DIN	00916.302	
916	45 H	Fein



Gewindestifte mit Ringschneide, mit Innensechskant, mit metrischem Feingewinde

Achtung! Nicht für Zugbelastung.

Maße → TI-21 Normumstellung → TI-6
 Werkstoffeigensch. → TI-232

DIN 916 → wird ersetzt durch ISO 4029 (austauschbar)



M 6	x	0,75	x	6	S	1000	111,00
M 6	x	0,75	x	8	S	1000	119,00
M 6	x	0,75	x	10	S	1000	130,00
M 6	x	0,75	x	12	S	1000	136,00
M 6	x	0,75	x	16	S	500	144,00
M 6	x	0,75	x	20	S	500	146,00
M 8	x	1	x	6	S	500	99,00
M 8	x	1	x	8	S	500	39,00
M 8	x	1	x	10	S	200	50,00
M 8	x	1	x	12	S	200	60,00
M 8	x	1	x	16	S	200	89,00
M 8	x	1	x	20	S	200	99,00
M 8	x	1	x	25	S	200	124,00
M 8	x	1	x	30	S	200	134,00
M 8	x	1	x	40	S	200	169,00
M 8	x	1	x	50	S	100	210,00
M 10	x	1	x	8	S	200	78,00
M 10	x	1,25	x	8	S	200	365,00
M 10	x	1	x	10	S	200	59,00
M 10	x	1,25	x	10	S	200	192,00
M 10	x	1	x	12	S	200	80,00
M 10	x	1,25	x	12	S	200	236,00
M 10	x	1	x	16	S	200	100,00
M 10	x	1,25	x	16	S	200	260,00
M 10	x	1	x	20	S	200	147,00
M 10	x	1,25	x	20	S	200	265,00
M 10	x	1	x	25	S	100	151,00
M 10	x	1,25	x	25	S	100	270,00
M 10	x	1	x	30	S	100	157,00
M 10	x	1,25	x	30	S	100	285,00
M 12	x	1	x	10	S	200	410,00
M 12	x	1,5	x	10	S	200	211,00
M 12	x	1	x	12	S	200	160,00
M 12	x	1,25	x	12	S	200	244,00
M 12	x	1,5	x	12	S	200	215,00
M 12	x	1	x	16	S	200	175,00
M 12	x	1,25	x	16	S	200	250,00
M 12	x	1,25	x	20	S	100	270,00
M 12	x	1,5	x	20	S	100	244,00
M 12	x	1,25	x	25	S	100	285,00
M 12	x	1,5	x	25	S	100	255,00
M 12	x	1,25	x	30	S	100	300,00
M 16	x	1,5	x	16	S	100	365,00
M 16	x	1,5	x	20	S	100	370,00
M 16	x	1,5	x	25	S	100	380,00
M 16	x	1,5	x	30	S	100	400,00
M 16	x	1,5	x	40	S	50	425,00

Abmessungen	VE Stück	€/100/Obf.
DIN	00917.300	
917	6	

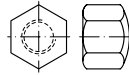

Sechskant-Hutmuttern, niedrige Form

ab M 12 mit Rille oder entsprechender Einschraubtiefe t min.

Maße → TI-62 Normumstellung → TI-7
 Werkstoffeigensch. → TI-233 REACH → TI-262

Rostfrei → S. 485
 Messing → S. 624



M 4	S	1000	12,40
M 5	S	1000	12,60
M 6	S	1000	19,70
M 8	S	500	34,00
M 10 SW 17	S	500	62,00
M 12 SW 19	S	250	89,00
M 16	S	250	151,00
M 20	S	25	295,00
M 24	S	10	620,00
M 30	S	1	1110,00
M 36	S	1	2650,00

DIN	00917.310
917	6 galvanisch verzinkt

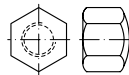

Sechskant-Hutmuttern, niedrige Form

ab M 12 mit Rille oder entsprechender Einschraubtiefe t min.

Maße → TI-62 Normumstellung → TI-7
 Werkstoffeigensch. → TI-233 REACH → TI-262

Korrosionsschutz → TI-228

Rostfrei → S. 485
 Messing → S. 624



M 4	S	1000	15,40 gal Zn
M 4	K	100	18,60 gal Zn
M 5	S	1000	16,00 gal Zn
M 5	K	100	19,20 gal Zn
M 6	S	1000	24,10 gal Zn
M 6	K	100	27,50 gal Zn
M 8	S	500	42,00 gal Zn
M 8	K	100	45,50 gal Zn
M 10 SW 17	S	500	78,00 gal Zn
M 10 SW 17	K	100	82,00 gal Zn
M 12 SW 19	S	250	114,00 gal Zn
M 12 SW 19	K	100	117,00 gal Zn
M 14 SW 22	S	50	163,00 gal Zn
M 16	S	50	190,00 gal Zn

Abmessungen	VE Stück	€/100/Obf.
M 20	S	25 345,00 gal Zn
M 24	S	10 610,00 gal Zn
M 30	S	1 1460,00 gal Zn
M 36	S	1 5400,00 gal Zn

DIN	00917.305
917	6 Fein

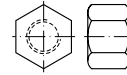

Sechskant-Hutmuttern, niedrige Form, mit metrischem Feingewinde

ab M 12 mit Rille oder entsprechender Einschraubtiefe t min.

Maße → TI-62 Normumstellung → TI-7
 Werkstoffeigensch. → TI-233 REACH → TI-262



M 8	x1	S	100	55,00
M 10	x1 SW 17	S	100	83,00
M 12	x1,5 SW 19	S	50	118,00
M 16	x1,5	S	50	193,00
M 20	x1,5	S	25	345,00
M 24	x2	S	10	620,00

DIN	00920.500
920	4.8/5.8



Flachkopfschrauben mit Schlitz und kleinem Kopf

Maße → TI-37 REACH → TI-262
 Werkstoffeigensch. → TI-232



M 3	x	3	S	100	11,40
M 3	x	4	S	100	11,30
M 3	x	5	S	100	11,50
M 3	x	6	S	100	11,80
M 3	x	8	S	100	12,10
M 3	x	10	S	100	12,40
M 3	x	12	S	100	12,60
M 3	x	16	S	100	13,40
M 4	x	6	S	100	15,30
M 4	x	8	S	100	15,50
M 4	x	10	S	100	15,80
M 4	x	12	S	100	16,10
M 4	x	16	S	100	16,40
M 5	x	8	S	100	19,40
M 5	x	10	S	100	20,00
M 5	x	12	S	100	21,20
M 5	x	16	S	100	29,00
M 5	x	25	S	100	61,00

Abmessungen	VE Stück	€/100/Obf.
DIN	00920.510	
920	4.8/5.8	galvanisch verzinkt

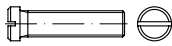

Flachkopfschrauben mit Schlitz und kleinem Kopf

Maße → **TI-37** Korrosionsschutz → **TI-228**
 Werkstoffeigensch. → **TI-232** REACH → **TI-262**



M 3	x	3	S	100	15,80 gal Zn
M 3	x	4	S	100	14,60 gal Zn
M 3	x	5	S	100	15,80 gal Zn
M 3	x	6	S	100	16,00 gal Zn
M 3	x	8	S	100	16,40 gal Zn
M 3	x	10	S	100	16,70 gal Zn
M 3	x	12	S	100	17,00 gal Zn
M 3	x	16	S	100	18,20 gal Zn
M 4	x	6	S	100	20,00 gal Zn
M 4	x	8	S	100	20,40 gal Zn
M 4	x	10	S	100	14,30 gal Zn
M 4	x	12	S	100	21,00 gal Zn
M 4	x	16	S	100	21,60 gal Zn

DIN	00921.500
921	4.8/5.8

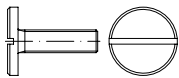

Flachkopfschrauben mit Schlitz und gr. Kopf, pressblank

Maße → **TI-38** REACH → **TI-262**
 Werkstoffeigensch. → **TI-232**

Rostfrei → **S. 485**



M 3	x	4	S	100	26,50
M 3	x	5	S	100	21,20
M 3	x	6	S	100	21,60
M 3	x	8	S	100	22,20
M 3	x	10	S	100	41,00
M 4	x	5	S	100	31,50
M 4	x	6	S	100	31,00
M 4	x	8	S	100	31,50
M 4	x	10	S	100	32,50
M 4	x	12	S	100	33,00
M 4	x	16	S	100	34,00
M 5	x	6	S	100	57,00
M 5	x	8	S	100	47,00
M 5	x	10	S	100	48,50
M 5	x	12	S	100	57,00
M 5	x	16	S	100	94,00
M 6	x	8	S	100	176,00
M 6	x	10	S	100	102,00
M 6	x	12	S	100	106,00
M 6	x	16	S	100	118,00

Abmessungen	VE Stück	€/100/Obf.
M 6	x 20	S 100 132,00
M 8	x 10	S 100 230,00
M 8	x 12	S 100 234,00
M 8	x 16	S 100 270,00
M 8	x 20	S 100 280,00

DIN	00921.510
921	4.8/5.8
	galvanisch verzinkt

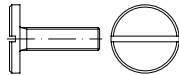

Flachkopfschrauben mit Schlitz und großem Kopf

Maße → **TI-38** Korrosionsschutz → **TI-228**
 Werkstoffeigensch. → **TI-232** REACH → **TI-262**

Rostfrei → **S. 485**



M 3	x	4	S	100	28,50 gal Zn
M 3	x	5	S	100	23,00 gal Zn
M 3	x	6	S	100	23,60 gal Zn
M 3	x	8	S	100	24,00 gal Zn
M 3	x	10	S	100	42,50 gal Zn
M 4	x	5	S	100	33,50 gal Zn
M 4	x	6	S	100	33,00 gal Zn
M 4	x	8	S	100	33,50 gal Zn
M 4	x	10	S	100	34,00 gal Zn
M 4	x	12	S	100	34,50 gal Zn
M 4	x	16	S	100	36,50 gal Zn
M 5	x	6	S	100	59,00 gal Zn
M 5	x	8	S	100	48,50 gal Zn
M 5	x	10	S	100	52,00 gal Zn
M 5	x	12	S	100	60,00 gal Zn
M 5	x	16	S	100	96,00 gal Zn
M 6	x	8	S	100	180,00 gal Zn
M 6	x	10	S	100	106,00 gal Zn
M 6	x	12	S	100	111,00 gal Zn
M 6	x	16	S	100	123,00 gal Zn
M 6	x	20	S	100	140,00 gal Zn
M 8	x	10	S	100	234,00 gal Zn
M 8	x	12	S	100	239,00 gal Zn
M 8	x	16	S	100	275,00 gal Zn
M 8	x	20	S	100	280,00 gal Zn
M 10	x	12	S	100	520,00 gal Zn
M 10	x	16	S	100	550,00 gal Zn
M 10	x	20	S	100	640,00 gal Zn

Abmessungen	VE Stück	€/100/Obf.
DIN	00923.500	
923	4.8/5.8	

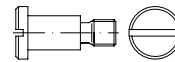

Flachkopfschrauben mit Schlitz und Ansatz, ohne Freistich

Maße → **TI-38** REACH → **TI-262**
 Werkstoffeigensch. → **TI-232**

Rostfrei → **S. 485**



Gewinde Ø x Schaftlänge x Gewindelänge

M 3	x	2	x	4,5	S	100	22,20
M 3	x	3	x	4,5	S	100	32,50
M 3	x	4	x	4,5	S	100	24,20
M 3	x	5	x	4,5	S	100	36,50
M 3	x	6	x	4,5	S	100	26,50
M 3	x	8	x	4,5	S	100	39,00
M 3	x	10	x	4,5	S	100	30,50
M 4	x	2,5	x	6,0	S	100	24,20
M 4	x	3	x	6,0	S	100	24,90
M 4	x	4	x	6,0	S	100	26,00
M 4	x	5	x	6,0	S	100	26,50
M 4	x	6	x	6,0	S	100	27,50
M 4	x	8	x	6,0	S	100	30,00
M 4	x	10	x	6,0	S	100	33,50
M 4	x	12	x	6,0	S	100	37,00
M 4	x	16	x	6,0	S	100	58,00
M 5	x	2,5	x	7,0	S	100	48,50
M 5	x	3	x	7,0	S	100	36,50
M 5	x	4	x	7,0	S	100	38,00
M 5	x	5	x	7,0	S	100	39,00
M 5	x	6	x	7,0	S	100	41,50
M 5	x	8	x	7,0	S	100	44,50
M 5	x	10	x	7,0	S	100	46,00
M 5	x	12	x	7,0	S	100	49,50
M 5	x	16	x	7,0	S	100	57,00
M 5	x	20	x	7,0	S	100	66,00
M 6	x	3	x	9,0	S	100	54,00
M 6	x	4	x	9,0	S	100	56,00
M 6	x	5	x	9,0	S	100	57,00
M 6	x	6	x	9,0	S	100	58,00
M 6	x	8	x	9,0	S	100	67,00
M 6	x	10	x	9,0	S	100	68,00
M 6	x	12	x	9,0	S	100	69,00
M 6	x	16	x	9,0	S	100	89,00
M 6	x	20	x	9,0	S	100	95,00
M 8	x	4	x	11,0	S	100	99,00
M 8	x	5	x	11,0	S	100	141,00
M 8	x	6	x	11,0	S	100	103,00
M 8	x	8	x	11,0	S	100	113,00
M 8	x	10	x	11,0	S	100	118,00
M 8	x	12	x	11,0	S	100	125,00
M 8	x	16	x	11,0	S	100	146,00
M 8	x	20	x	11,0	S	50	160,00
M 8	x	25	x	11,0	S	50	180,00
M 10	x	6	x	13,5	S	50	270,00
M 10	x	10	x	13,5	S	50	280,00
M 10	x	12	x	13,5	S	50	260,00
M 10	x	16	x	13,5	S	50	300,00
M 10	x	20	x	13,5	S	50	475,00
M 10	x	25	x	13,5	S	50	485,00

Abmessungen	VE Stück	€/100/Obf.
DIN	00923.510	
923	4.8/5.8	galvanisch verzinkt

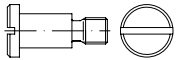

Flachkopfschrauben mit Schlitz und Ansatz, ohne Freistich

Maße → **TI-38** Korrosionsschutz → **TI-228**
 Werkstoffeigensch. → **TI-232** REACH → **TI-262**

Rostfrei → **S. 485**



Gewinde Ø x Schaftlänge x Gewindelänge

M 3	x	2	x	4,5	S	100	25,50 gal Zn
M 3	x	3	x	4,5	S	100	34,00 gal Zn
M 3	x	4	x	4,5	S	100	26,50 gal Zn
M 3	x	5	x	4,5	S	100	38,50 gal Zn
M 3	x	6	x	4,5	S	100	28,00 gal Zn
M 3	x	8	x	4,5	S	100	41,00 gal Zn
M 3	x	10	x	4,5	S	100	32,50 gal Zn
M 4	x	2,5	x	6,0	S	100	26,50 gal Zn
M 4	x	3	x	6,0	S	100	27,00 gal Zn
M 4	x	4	x	6,0	S	100	28,00 gal Zn
M 4	x	5	x	6,0	S	100	28,50 gal Zn
M 4	x	6	x	6,0	S	100	29,50 gal Zn
M 4	x	8	x	6,0	S	100	32,50 gal Zn
M 4	x	10	x	6,0	S	100	35,50 gal Zn
M 4	x	12	x	6,0	S	100	39,00 gal Zn
M 4	x	16	x	6,0	S	100	60,00 gal Zn
M 5	x	2,5	x	7,0	S	100	51,00 gal Zn
M 5	x	3	x	7,0	S	100	38,50 gal Zn
M 5	x	4	x	7,0	S	100	39,50 gal Zn
M 5	x	5	x	7,0	S	100	41,00 gal Zn
M 5	x	6	x	7,0	S	100	43,00 gal Zn
M 5	x	8	x	7,0	S	100	47,50 gal Zn
M 5	x	10	x	7,0	S	100	48,50 gal Zn
M 5	x	12	x	7,0	S	100	53,00 gal Zn
M 5	x	16	x	7,0	S	100	59,00 gal Zn
M 6	x	3	x	9,0	S	100	58,00 gal Zn
M 6	x	4	x	9,0	S	100	59,00 gal Zn
M 6	x	5	x	9,0	S	100	61,00 gal Zn
M 6	x	6	x	9,0	S	100	62,00 gal Zn
M 6	x	8	x	9,0	S	100	71,00 gal Zn
M 6	x	10	x	9,0	S	100	72,00 gal Zn
M 6	x	12	x	9,0	S	100	74,00 gal Zn
M 6	x	16	x	9,0	S	100	94,00 gal Zn
M 6	x	20	x	9,0	S	100	99,00 gal Zn
M 8	x	4	x	11,0	S	100	102,00 gal Zn
M 8	x	5	x	11,0	S	100	144,00 gal Zn
M 8	x	6	x	11,0	S	100	107,00 gal Zn
M 8	x	8	x	11,0	S	100	117,00 gal Zn
M 8	x	10	x	11,0	S	100	123,00 gal Zn
M 8	x	12	x	11,0	S	100	130,00 gal Zn
M 8	x	16	x	11,0	S	100	151,00 gal Zn
M 8	x	20	x	11,0	S	100	166,00 gal Zn
M 8	x	25	x	11,0	S	50	188,00 gal Zn
M10	x	10	x	13,5	S	50	280,00 gal Zn
M10	x	12	x	13,5	S	50	325,00 gal Zn
M10	x	16	x	13,5	S	50	310,00 gal Zn
M10	x	20	x	13,5	S	50	485,00 gal Zn
M10	x	25	x	13,5	S	50	500,00 gal Zn

Abmessungen	VE Stück	€/100/Obf.
DIN	00927.000	
927	14 H	

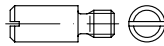

Zapfenschrauben mit Schlitz

Maße → **TI-38** REACH → **TI-262**
 Werkstoffeigensch. → **TI-232**



Gewinde Ø x Zapfenlänge

M 3	x	3	S	100	22,80
M 3	x	4	S	100	24,00
M 3	x	5	S	100	24,70
M 3	x	6	S	100	26,00
M 3	x	8	S	100	26,50
M 4	x	4	S	100	33,50
M 4	x	5	S	100	31,00
M 4	x	6	S	100	42,50
M 4	x	8	S	100	34,50
M 4	x	10	S	100	38,00
M 5	x	5	S	100	40,50
M 5	x	6	S	100	42,50
M 5	x	8	S	100	44,00
M 5	x	10	S	100	44,50
M 5	x	12	S	100	47,00
M 6	x	8	S	100	56,00
M 6	x	10	S	100	62,00
M 6	x	12	S	100	67,00
M 8	x	16	S	100	107,00

DIN	00928.000
928	Stahl

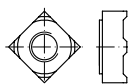

Vierkant-Schweißmuttern

Maße → **TI-71**
 Mit Feingewinde oder mit Flansch (DIN 977) auf Anfrage



M 4	S	1000	6,20
M 5	S	1000	6,60
M 6	S	1000	7,40
M 8	S	500	11,90
M 10	S	500	18,20
M 12	S	500	22,00

Abmessungen	VE Stück	€/100/Obf.
DIN	00929.000	
929	Stahl	

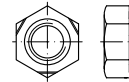

Sechskant-Schweißmuttern

Maße → **TI-71**
 Rostfrei → **S. 486**

Mit Feingewinde oder mit Flansch (DIN 977) auf Anfrage



M 3	S	1000	3,95
M 3	K	500	4,85
M 4	S	1000	4,30
M 4	K	500	5,30
M 5	S	1000	4,75
M 5	K	500	5,70
M 6	S	1000	5,60
M 6	K	250	7,20
M 8	S	1000	8,80
M 8	K	250	10,60
M 10	S	500	13,20
M 10	K	100	18,00
M 12	S	100	23,60
M 14	S	100	39,50
M 16	S	100	43,00

DIN	00931.800
931	8.8



Sechskantschrauben mit Schaft

kurze Abmessungen z. T. Gewinde bis Kopf

Maße → **TI-15** Anziehmomente → **TI-244**
 Werkstoffeigensch. → **TI-232** Normumstellung → **TI-6**

Rostfrei → **S. 486**
 Messing → **S. 625**

DIN 931 → wird ersetzt durch ISO 4014



M 3	x	30	S	500	14,30
M 3	x	30	K	100	17,90
M 3	x	35	S	500	14,60
M 3	x	35	K	100	18,30
M 3	x	40	S	500	15,30
M 3	x	40	K	100	19,00
M 4	x	25	S	500	12,30
M 4	x	25	K	100	16,00
M 4	x	30	S	500	12,30
M 4	x	30	K	100	16,00
M 4	x	35	S	500	13,70
M 4	x	40	S	500	14,60
M 4	x	40	K	100	18,10
M 4	x	45	S	500	14,80

Abmessungen	VE	Stück	€/100/Obf.	Abmessungen	VE	Stück	€/100/Obf.	Abmessungen	VE	Stück	€/100/Obf.
M 8 x 230	S	100	385,00	M 12 x 240	S	25	610,00	M 16 x 230	S	25	730,00
M 8 x 240	S	100	385,00	M 12 x 250	S	25	670,00	M 16 x 240	S	25	730,00
M 8 x 250	S	100	465,00	M 12 x 260	S	25	670,00	M 16 x 250	S	25	820,00
M 8 x 260	S	100	465,00	M 12 x 270	S	25	730,00	M 16 x 260	S	25	820,00
M 8 x 280	S	100	550,00	M 12 x 280	S	25	730,00	M 16 x 270	S	25	1130,00
M 8 x 300	S	100	600,00	M 12 x 290	S	25	800,00	M 16 x 280	S	1	1130,00
M 10 x 40	S	100	21,20	M 12 x 300	S	25	800,00	M 16 x 290	S	1	1270,00
M 10 x 45	S	100	22,10	M 12 x 310	S	25	1250,00	M 16 x 300	S	1	1270,00
M 10 x 50	S	100	23,10	M 12 x 320	S	25	1150,00	M 16 x 310	S	1	1480,00
M 10 x 55	S	100	25,50	M 12 x 330	S	25	1450,00	M 16 x 320	S	1	1350,00
M 10 x 60	S	100	26,00	M 12 x 340	S	25	1260,00	M 16 x 330	S	1	1580,00
M 10 x 65	S	100	28,00	M 12 x 350	S	25	1530,00	M 16 x 340	S	1	1440,00
M 10 x 70	S	100	28,50	M 12 x 360	S	25	1420,00	M 16 x 350	S	1	1780,00
M 10 x 75	S	100	31,50	M 12 x 380	S	25	1530,00	M 16 x 360	S	1	1610,00
M 10 x 80	S	100	31,50	M 12 x 400	S	25	1910,00	M 16 x 370	S	1	2170,00
M 10 x 85	S	100	42,50	M 12 x 420	S	25	2370,00	M 16 x 380	S	1	1970,00
M 10 x 90	S	100	42,50	M 12 x 440	S	25	2650,00	M 16 x 390	S	1	2460,00
M 10 x 95	S	100	49,00	M 12 x 460	S	25	3150,00	M 16 x 400	S	1	2240,00
M 10 x 100	S	100	49,00	M 12 x 480	S	25	3450,00	M 16 x 410	S	1	2750,00
M 10 x 105	S	50	110,00	M 12 x 500	S	25	3800,00	M 16 x 420	S	1	2550,00
M 10 x 110	S	50	75,00	M 14 x 50	S	100	88,00	M 16 x 430	S	1	3150,00
M 10 x 115	S	50	141,00	M 14 x 55	S	50	94,00	M 16 x 440	S	1	2900,00
M 10 x 120	S	50	85,00	M 14 x 60	S	50	94,00	M 16 x 450	S	1	3250,00
M 10 x 125	S	50	176,00	M 14 x 65	S	50	103,00	M 16 x 460	S	1	3600,00
M 10 x 130	S	50	96,00	M 14 x 70	S	50	103,00	M 16 x 480	S	1	3950,00
M 10 x 135	S	50	212,00	M 14 x 75	S	50	129,00	M 16 x 500	S	1	4300,00
M 10 x 140	S	50	142,00	M 14 x 80	S	50	134,00	M 18 x 65	S	25	265,00
M 10 x 145	S	50	275,00	M 14 x 85	S	50	151,00	M 18 x 70	S	25	275,00
M 10 x 150	S	50	171,00	M 14 x 90	S	50	151,00	M 18 x 75	S	25	285,00
M 10 x 160	S	50	213,00	M 14 x 95	S	50	170,00	M 18 x 80	S	25	285,00
M 10 x 170	S	50	213,00	M 14 x 100	S	50	170,00	M 18 x 85	S	25	310,00
M 10 x 180	S	50	236,00	M 14 x 110	S	50	195,00	M 18 x 90	S	25	310,00
M 10 x 190	S	50	300,00	M 14 x 120	S	50	223,00	M 18 x 95	S	25	335,00
M 10 x 200	S	50	300,00	M 14 x 130	S	50	255,00	M 18 x 100	S	25	335,00
M 10 x 210	S	50	310,00	M 14 x 140	S	25	280,00	M 18 x 110	S	25	385,00
M 10 x 220	S	50	600,00	M 14 x 150	S	25	305,00	M 18 x 120	S	25	385,00
M 10 x 230	S	50	810,00	M 14 x 160	S	25	345,00	M 18 x 130	S	25	420,00
M 10 x 240	S	50	650,00	M 14 x 170	S	25	395,00	M 18 x 140	S	25	520,00
M 10 x 250	S	50	880,00	M 14 x 180	S	25	395,00	M 18 x 150	S	25	520,00
M 10 x 260	S	50	700,00	M 14 x 190	S	25	470,00	M 18 x 160	S	25	580,00
M 10 x 270	S	50	940,00	M 14 x 200	S	25	470,00	M 18 x 170	S	25	790,00
M 10 x 280	S	50	750,00	M 14 x 210	S	25	610,00	M 18 x 180	S	25	790,00
M 10 x 300	S	50	790,00	M 14 x 220	S	25	610,00	M 18 x 190	S	1	1110,00
M 10 x 320	S	50	940,00	M 14 x 230	S	25	670,00	M 18 x 200	S	1	1110,00
M 10 x 340	S	50	1080,00	M 14 x 240	S	25	670,00	M 18 x 210	S	1	1290,00
M 10 x 360	S	50	1140,00	M 14 x 250	S	25	940,00	M 18 x 220	S	1	1290,00
M 10 x 380	S	50	1820,00	M 14 x 260	S	25	940,00	M 18 x 230	S	1	1440,00
M 10 x 400	S	50	1900,00	M 14 x 270	S	25	990,00	M 18 x 240	S	1	1440,00
M 12 x 45	S	100	33,00	M 14 x 280	S	25	990,00	M 18 x 250	S	1	1580,00
M 12 x 50	S	100	34,00	M 14 x 290	S	25	1060,00	M 18 x 260	S	1	1580,00
M 12 x 55	S	100	35,00	M 14 x 300	S	25	1060,00	M 18 x 270	S	1	1800,00
M 12 x 60	S	100	37,50	M 14 x 310	S	25	1360,00	M 18 x 280	S	1	1800,00
M 12 x 65	S	50	40,50	M 14 x 320	S	25	1620,00	M 18 x 290	S	1	2060,00
M 12 x 70	S	50	41,00	M 16 x 55	S	50	62,00	M 18 x 300	S	1	2060,00
M 12 x 75	S	50	44,00	M 16 x 60	S	50	64,00	M 20 x 60	S	25	118,00
M 12 x 80	S	50	45,50	M 16 x 65	S	25	70,00	M 20 x 65	S	25	121,00
M 12 x 85	S	50	61,00	M 16 x 70	S	25	74,00	M 20 x 70	S	25	124,00
M 12 x 90	S	50	53,00	M 16 x 75	S	25	78,00	M 20 x 75	S	25	129,00
M 12 x 95	S	50	66,00	M 16 x 80	S	25	82,00	M 20 x 80	S	25	140,00
M 12 x 100	S	50	66,00	M 16 x 85	S	25	103,00	M 20 x 85	S	25	152,00
M 12 x 105	S	50	183,00	M 16 x 90	S	25	90,00	M 20 x 90	S	25	152,00
M 12 x 110	S	50	99,00	M 16 x 95	S	25	111,00	M 20 x 95	S	25	182,00
M 12 x 115	S	50	190,00	M 16 x 100	S	25	111,00	M 20 x 100	S	25	182,00
M 12 x 120	S	50	107,00	M 16 x 110	S	25	167,00	M 20 x 110	S	25	285,00
M 12 x 130	S	50	120,00	M 16 x 120	S	25	186,00	M 20 x 120	S	25	295,00
M 12 x 140	S	50	175,00	M 16 x 130	S	25	199,00	M 20 x 130	S	25	300,00
M 12 x 150	S	50	200,00	M 16 x 140	S	25	270,00	M 20 x 140	S	25	410,00
M 12 x 160	S	25	265,00	M 16 x 150	S	25	305,00	M 20 x 150	S	25	455,00
M 12 x 170	S	25	300,00	M 16 x 160	S	25	345,00	M 20 x 160	S	10	520,00
M 12 x 180	S	25	335,00	M 16 x 170	S	25	425,00	M 20 x 170	S	10	660,00
M 12 x 190	S	25	355,00	M 16 x 180	S	25	425,00	M 20 x 180	S	10	660,00
M 12 x 200	S	25	390,00	M 16 x 190	S	25	500,00	M 20 x 190	S	1	1030,00
M 12 x 210	S	25	440,00	M 16 x 200	S	25	500,00	M 20 x 200	S	1	1030,00
M 12 x 220	S	25	440,00	M 16 x 210	S	25	650,00	M 20 x 210	S	1	1290,00
M 12 x 230	S	25	610,00	M 16 x 220	S	25	650,00	M 20 x 220	S	1	1290,00

Abmessungen	VE	Stück	€/100/Obf.	Abmessungen	VE	Stück	€/100/Obf.	Abmessungen	VE	Stück	€/100/Obf.
M 20 x 230	S	1	1440,00	M 24 x 290	S	1	2700,00	M 30 x 220	S	1	2600,00
M 20 x 240	S	1	1440,00	M 24 x 300	S	1	2700,00	M 30 x 240	S	1	2800,00
M 20 x 250	S	1	1580,00	M 24 x 310	S	1	2750,00	M 30 x 250	S	1	3100,00
M 20 x 260	S	1	1580,00	M 24 x 320	S	1	2750,00	M 30 x 260	S	1	3100,00
M 20 x 270	S	1	1800,00	M 24 x 330	S	1	2800,00	M 30 x 270	S	1	3100,00
M 20 x 280	S	1	1800,00	M 24 x 340	S	1	2800,00	M 30 x 280	S	1	3100,00
M 20 x 290	S	1	2060,00	M 24 x 350	S	1	2900,00	M 30 x 290	S	1	3250,00
M 20 x 300	S	1	2060,00	M 24 x 360	S	1	2900,00	M 30 x 300	S	1	3250,00
M 20 x 310	S	1	2190,00	M 24 x 370	S	1	3100,00	M 30 x 310	S	1	3750,00
M 20 x 320	S	1	2190,00	M 24 x 380	S	1	3100,00	M 30 x 320	S	1	3750,00
M 20 x 330	S	1	2340,00	M 24 x 390	S	1	3350,00	M 30 x 330	S	1	3850,00
M 20 x 340	S	1	2340,00	M 24 x 400	S	1	3350,00	M 30 x 340	S	1	3850,00
M 20 x 350	S	1	2490,00	M 24 x 410	S	1	3550,00	M 30 x 350	S	1	4100,00
M 20 x 360	S	1	2490,00	M 24 x 420	S	1	3550,00	M 30 x 360	S	1	4100,00
M 20 x 370	S	1	2700,00	M 24 x 430	S	1	3850,00	M 30 x 370	S	1	4400,00
M 20 x 380	S	1	2700,00	M 24 x 440	S	1	3850,00	M 30 x 380	S	1	4400,00
M 20 x 390	S	1	2800,00	M 24 x 450	S	1	4100,00	M 30 x 390	S	1	4800,00
M 20 x 400	S	1	2800,00	M 24 x 460	S	1	4100,00	M 30 x 400	S	1	4800,00
M 20 x 410	S	1	2900,00	M 24 x 480	S	1	4350,00	M 30 x 420	S	1	5000,00
M 20 x 420	S	1	2900,00	M 24 x 500	S	1	4600,00	M 30 x 440	S	1	5900,00
M 20 x 430	S	1	3600,00	M 24 x 560	S	1	9800,00	M 30 x 450	S	1	6700,00
M 20 x 440	S	1	3600,00	M 24 x 600	S	1	10300,00	M 30 x 460	S	1	6700,00
M 20 x 450	S	1	3600,00	M 24 x 640	S	1	10700,00	M 30 x 480	S	1	7900,00
M 20 x 460	S	1	3600,00	M 27 x 75	S	10	600,00	M 30 x 500	S	1	8500,00
M 20 x 480	S	1	3650,00	M 27 x 80	S	10	600,00	M 30 x 520	S	1	14600,00
M 20 x 500	S	1	3700,00	M 27 x 85	S	10	750,00	M 30 x 560	S	1	15400,00
M 22 x 70	S	25	510,00	M 27 x 90	S	10	750,00	M 30 x 580	S	1	15700,00
M 22 x 75	S	25	530,00	M 27 x 100	S	10	890,00	M 30 x 600	S	1	16100,00
M 22 x 80	S	25	530,00	M 27 x 110	S	1	1030,00	M 33 x 90	S	1	1790,00
M 22 x 90	S	25	550,00	M 27 x 120	S	1	1030,00	M 33 x 100	S	1	1790,00
M 22 x 100	S	10	600,00	M 27 x 130	S	1	1110,00	M 33 x 110	S	1	1900,00
M 22 x 110	S	10	640,00	M 27 x 140	S	1	1110,00	M 33 x 120	S	1	1990,00
M 22 x 120	S	10	690,00	M 27 x 150	S	1	1140,00	M 33 x 130	S	1	2080,00
M 22 x 130	S	10	730,00	M 27 x 160	S	1	1140,00	M 33 x 140	S	1	2180,00
M 22 x 140	S	10	730,00	M 27 x 170	S	1	1200,00	M 33 x 150	S	1	2260,00
M 22 x 150	S	10	870,00	M 27 x 180	S	1	1200,00	M 33 x 160	S	1	2700,00
M 22 x 160	S	10	980,00	M 27 x 190	S	1	1430,00	M 33 x 170	S	1	2750,00
M 22 x 170	S	1	1220,00	M 27 x 200	S	1	1430,00	M 33 x 180	S	1	2750,00
M 22 x 180	S	1	1220,00	M 27 x 210	S	1	2110,00	M 33 x 190	S	1	2850,00
M 22 x 190	S	1	1550,00	M 27 x 220	S	1	2110,00	M 33 x 200	S	1	2850,00
M 22 x 200	S	1	1550,00	M 27 x 230	S	1	2280,00	M 33 x 210	S	1	2950,00
M 22 x 210	S	1	1740,00	M 27 x 240	S	1	2280,00	M 33 x 220	S	1	2950,00
M 22 x 220	S	1	1740,00	M 27 x 250	S	1	2460,00	M 33 x 230	S	1	3100,00
M 22 x 230	S	1	1940,00	M 27 x 260	S	1	2460,00	M 33 x 240	S	1	3100,00
M 22 x 240	S	1	1940,00	M 27 x 270	S	1	2650,00	M 33 x 250	S	1	3650,00
M 22 x 250	S	1	2380,00	M 27 x 280	S	1	2650,00	M 33 x 260	S	1	3650,00
M 22 x 260	S	1	2380,00	M 27 x 290	S	1	3050,00	M 33 x 270	S	1	3800,00
M 22 x 270	S	1	2700,00	M 27 x 300	S	1	3050,00	M 33 x 280	S	1	3800,00
M 22 x 280	S	1	2700,00	M 27 x 320	S	1	3850,00	M 33 x 300	S	1	4000,00
M 22 x 300	S	1	2950,00	M 27 x 340	S	1	4250,00	M 33 x 400	S	1	12400,00
M 22 x 320	S	1	3550,00	M 27 x 360	S	1	4650,00	M 36 x 100	S	1	2260,00
M 24 x 75	S	25	220,00	M 27 x 380	S	1	5000,00	M 36 x 110	S	1	2260,00
M 24 x 80	S	25	220,00	M 27 x 400	S	1	5300,00	M 36 x 120	S	1	2380,00
M 24 x 85	S	10	290,00	M 27 x 420	S	1	5700,00	M 36 x 130	S	1	2550,00
M 24 x 90	S	10	270,00	M 27 x 440	S	1	6000,00	M 36 x 140	S	1	2650,00
M 24 x 95	S	10	295,00	M 27 x 460	S	1	6300,00	M 36 x 150	S	1	2750,00
M 24 x 100	S	10	295,00	M 27 x 480	S	1	6700,00	M 36 x 160	S	1	3100,00
M 24 x 110	S	10	445,00	M 27 x 500	S	1	7100,00	M 36 x 170	S	1	3300,00
M 24 x 120	S	10	475,00	M 27 x 520	S	1	9800,00	M 36 x 180	S	1	3300,00
M 24 x 130	S	10	485,00	M 27 x 540	S	1	10600,00	M 36 x 190	S	1	3450,00
M 24 x 140	S	10	670,00	M 27 x 560	S	1	11300,00	M 36 x 200	S	1	3450,00
M 24 x 150	S	10	730,00	M 30 x 80	S	1	1570,00	M 36 x 210	S	1	3600,00
M 24 x 160	S	10	810,00	M 30 x 90	S	1	1570,00	M 36 x 220	S	1	3600,00
M 24 x 170	S	1	1030,00	M 30 x 100	S	1	1570,00	M 36 x 230	S	1	3950,00
M 24 x 180	S	1	1030,00	M 30 x 110	S	1	1860,00	M 36 x 240	S	1	3950,00
M 24 x 190	S	1	1460,00	M 30 x 120	S	1	1860,00	M 36 x 250	S	1	4200,00
M 24 x 200	S	1	1460,00	M 30 x 130	S	1	2060,00	M 36 x 260	S	1	4200,00
M 24 x 210	S	1	1730,00	M 30 x 140	S	1	2060,00	M 36 x 270	S	1	4400,00
M 24 x 220	S	1	1870,00	M 30 x 150	S	1	2140,00	M 36 x 280	S	1	4400,00
M 24 x 230	S	1	1920,00	M 30 x 160	S	1	2140,00	M 36 x 290	S	1	4600,00
M 24 x 240	S	1	2010,00	M 30 x 170	S	1	2360,00	M 36 x 300	S	1	4600,00
M 24 x 250	S	1	2070,00	M 30 x 180	S	1	2360,00	M 36 x 310	S	1	5300,00
M 24 x 260	S	1	2070,00	M 30 x 190	S	1	2550,00	M 36 x 320	S	1	5300,00
M 24 x 270	S	1	2440,00	M 30 x 200	S	1	2550,00	M 36 x 330	S	1	5500,00
M 24 x 280	S	1	2440,00	M 30 x 210	S	1	2600,00	M 36 x 340	S	1	5500,00

Abmessungen	VE	Stück	€/100/Obf.	Abmessungen	VE	Stück	€/100/Obf.	Abmessungen	VE	Stück	€/100/Obf.
M 36 x 350	S	1	5700,00	M 48 x 340	S	1	13800,00	M 5 x 30	K	100	17,70 gal Zn
M 36 x 360	S	1	5700,00	M 48 x 360	S	1	14600,00	M 5 x 35	S	200	15,70 gal Zn
M 36 x 380	S	1	5900,00	M 48 x 380	S	1	15200,00	M 5 x 40	S	200	16,70 gal Zn
M 36 x 400	S	1	5900,00	M 48 x 400	S	1	16000,00	M 5 x 45	S	200	17,20 gal Zn
M 36 x 420	S	1	6000,00	M 48 x 420	S	1	21900,00	M 5 x 50	S	200	19,10 gal Zn
M 36 x 440	S	1	6400,00	M 48 x 480	S	1	28600,00	M 5 x 55	S	200	20,40 gal Zn
M 36 x 460	S	1	6900,00	M 52 x 140	S	1	19600,00	M 5 x 60	S	200	22,00 gal Zn
M 36 x 480	S	1	7200,00	M 52 x 150	S	1	19800,00	M 5 x 65	S	200	28,50 gal Zn
M 36 x 500	S	1	7500,00	M 52 x 160	S	1	20200,00	M 5 x 70	S	200	30,00 gal Zn
M 36 x 540	S	1	18000,00	M 52 x 170	S	1	20600,00	M 5 x 80	S	200	35,50 gal Zn
M 36 x 580	S	1	18500,00	M 52 x 180	S	1	21000,00	M 5 x 85	S	200	79,00 gal Zn
M 39 x 110	S	1	3700,00	M 52 x 190	S	1	21400,00	M 5 x 90	S	200	80,00 gal Zn
M 39 x 120	S	1	3700,00	M 52 x 200	S	1	21800,00	M 5 x 95	S	200	88,00 gal Zn
M 39 x 130	S	1	3900,00	M 52 x 220	S	1	22500,00	M 5 x 100	S	200	91,00 gal Zn
M 39 x 140	S	1	4050,00	M 52 x 240	S	1	23300,00	M 5 x 120	S	200	151,00 gal Zn
M 39 x 150	S	1	4300,00	M 52 x 250	S	1	23700,00	M 5 x 130	S	200	260,00 gal Zn
M 39 x 160	S	1	4400,00	M 52 x 260	S	1	24100,00	M 6 x 30	S	500	8,40 gal Zn
M 39 x 170	S	1	4550,00	M 52 x 280	S	1	24800,00	M 6 x 30	K	100	12,10 gal Zn
M 39 x 180	S	1	4800,00	M 52 x 300	S	1	25600,00	M 6 x 35	S	200	9,40 gal Zn
M 39 x 190	S	1	5100,00	M 56 x 130	S	1	11600,00	M 6 x 40	S	200	10,60 gal Zn
M 39 x 200	S	1	5300,00	M 56 x 140	S	1	12100,00	M 6 x 45	S	200	11,80 gal Zn
M 39 x 220	S	1	5600,00	M 56 x 150	S	1	12200,00	M 6 x 50	S	200	13,80 gal Zn
M 39 x 240	S	1	6000,00	M 56 x 160	S	1	12800,00	M 6 x 55	S	200	17,10 gal Zn
M 39 x 250	S	1	15400,00	M 56 x 170	S	1	13100,00	M 6 x 60	S	200	18,30 gal Zn
M 39 x 260	S	1	15600,00	M 56 x 180	S	1	13700,00	M 6 x 65	S	200	28,50 gal Zn
M 39 x 280	S	1	16000,00	M 56 x 190	S	1	13900,00	M 6 x 70	S	200	29,00 gal Zn
M 39 x 300	S	1	16400,00	M 56 x 200	S	1	14500,00	M 6 x 75	S	200	31,50 gal Zn
M 42 x 120	S	1	3900,00	M 56 x 220	S	1	14500,00	M 6 x 80	S	200	38,50 gal Zn
M 42 x 130	S	1	4100,00	M 56 x 240	S	1	15600,00	M 6 x 85	S	100	49,50 gal Zn
M 42 x 140	S	1	4300,00	M 56 x 250	S	1	16600,00	M 6 x 90	S	100	50,00 gal Zn
M 42 x 150	S	1	4550,00	M 56 x 260	S	1	16600,00	M 6 x 95	S	100	62,00 gal Zn
M 42 x 160	S	1	4650,00	M 56 x 280	S	1	17700,00	M 6 x 100	S	100	63,00 gal Zn
M 42 x 170	S	1	4850,00	M 56 x 300	S	1	18500,00	M 6 x 105	S	100	151,00 gal Zn
M 42 x 180	S	1	5200,00	M 56 x 380	S	1	30100,00	M 6 x 110	S	100	64,00 gal Zn
M 42 x 190	S	1	5500,00	M 64 x 300	S	1	34600,00	M 6 x 120	S	100	78,00 gal Zn
M 42 x 200	S	1	5500,00					M 6 x 130	S	100	101,00 gal Zn
M 42 x 210	S	5	5900,00					M 6 x 140	S	100	116,00 gal Zn
M 42 x 220	S	1	6300,00					M 6 x 150	S	100	300,00 gal Zn
M 42 x 240	S	1	6700,00					M 6 x 160	S	100	305,00 gal Zn
M 42 x 250	S	1	7200,00					M 6 x 170	S	100	325,00 gal Zn
M 42 x 260	S	1	7200,00					M 6 x 180	S	100	360,00 gal Zn
M 42 x 280	S	1	8100,00					M 6 x 190	S	100	400,00 gal Zn
M 42 x 300	S	1	8500,00					M 6 x 200	S	100	460,00 gal Zn
M 42 x 320	S	1	9300,00					M 7 x 40	S	200	32,50 gal Zn
M 42 x 340	S	1	9900,00					M 7 x 50	S	200	35,00 gal Zn
M 42 x 360	S	1	10800,00					M 7 x 60	S	200	51,00 gal Zn
M 42 x 380	S	1	11600,00					M 8 x 35	S	200	15,50 gal Zn
M 42 x 400	S	1	12200,00					M 8 x 40	S	200	17,50 gal Zn
M 42 x 420	S	1	13100,00					M 8 x 45	S	200	19,60 gal Zn
M 45 x 120	S	1	5200,00					M 8 x 50	S	200	20,90 gal Zn
M 45 x 130	S	1	5500,00					M 8 x 55	S	200	21,60 gal Zn
M 45 x 140	S	1	5700,00					M 8 x 60	S	200	23,00 gal Zn
M 45 x 150	S	1	5900,00					M 8 x 65	S	200	26,00 gal Zn
M 45 x 160	S	1	6300,00					M 8 x 70	S	200	26,50 gal Zn
M 45 x 170	S	1	6500,00					M 8 x 75	S	200	32,00 gal Zn
M 45 x 180	S	1	6800,00					M 8 x 80	S	200	34,00 gal Zn
M 45 x 190	S	1	7100,00					M 8 x 85	S	100	52,00 gal Zn
M 45 x 200	S	1	7400,00					M 8 x 90	S	100	53,00 gal Zn
M 45 x 220	S	1	17100,00					M 8 x 95	S	100	59,00 gal Zn
M 48 x 130	S	1	6600,00					M 8 x 100	S	100	71,00 gal Zn
M 48 x 140	S	1	6900,00					M 8 x 110	S	100	82,00 gal Zn
M 48 x 150	S	1	7400,00					M 8 x 115	S	100	147,00 gal Zn
M 48 x 160	S	1	7700,00					M 8 x 120	S	100	95,00 gal Zn
M 48 x 170	S	1	7900,00					M 8 x 125	S	100	161,00 gal Zn
M 48 x 180	S	1	7900,00					M 8 x 130	S	100	104,00 gal Zn
M 48 x 190	S	1	8400,00					M 8 x 135	S	100	201,00 gal Zn
M 48 x 200	S	1	8400,00					M 8 x 140	S	100	116,00 gal Zn
M 48 x 220	S	1	8800,00					M 8 x 145	S	100	232,00 gal Zn
M 48 x 240	S	1	9300,00					M 8 x 150	S	100	147,00 gal Zn
M 48 x 250	S	1	9800,00					M 8 x 160	S	100	155,00 gal Zn
M 48 x 260	S	1	9800,00					M 8 x 170	S	100	174,00 gal Zn
M 48 x 280	S	1	10500,00					M 8 x 180	S	100	204,00 gal Zn
M 48 x 290	S	1	11600,00					M 8 x 190	S	100	233,00 gal Zn
M 48 x 300	S	1	11600,00					M 8 x 200	S	100	250,00 gal Zn
M 48 x 320	S	1	13100,00					M 8 x 210	S	100	290,00 gal Zn
M 3 x 30	S	500	15,10 gal Zn	M 3 x 35	S	500	15,60 gal Zn	M 3 x 40	S	500	16,40 gal Zn
M 3 x 35	S	500	15,60 gal Zn	M 3 x 40	S	500	16,40 gal Zn	M 4 x 25	S	500	13,30 gal Zn
M 3 x 40	S	500	16,40 gal Zn	M 4 x 30	S	500	13,50 gal Zn	M 4 x 30	S	500	13,50 gal Zn
M 4 x 25	S	500	13,30 gal Zn	M 4 x 35	S	500	15,00 gal Zn	M 4 x 35	S	500	15,00 gal Zn
M 4 x 30	S	500	13,50 gal Zn	M 4 x 40	S	500	16,00 gal Zn	M 4 x 40	S	500	16,00 gal Zn
M 4 x 35	S	500	15,00 gal Zn	M 4 x 40	K	100	19,50 gal Zn	M 4 x 45	S	500	16,30 gal Zn
M 4 x 40	S	500	16,00 gal Zn	M 4 x 45	S	500	16,30 gal Zn	M 4 x 50	S	500	18,10 gal Zn
M 4 x 40	K	100	19,50 gal Zn	M 4 x 50	S	500	18,10 gal Zn	M 4 x 55	S	200	54,00 gal Zn
M 4 x 45	S	500	16,30 gal Zn	M 4 x 55	S	200	54,00 gal Zn	M 4 x 60	S	200	61,00 gal Zn
M 4 x 50	S	500	18,10 gal Zn	M 4 x 60	S	200	61,00 gal Zn	M 4 x 70	S	200	78,00 gal Zn
M 4 x 55	S	200	54,00 gal Zn	M 4 x 70	S	200	78,00 gal Zn	M 4 x 80	S	200	107,00 gal Zn
M 4 x 60	S	200	61,00 gal Zn	M 4 x 80	S	200	107,00 gal Zn	M 5 x 30	S	500	14,00 gal Zn
M 4 x 70	S	200	78,00 gal Zn								
M 4 x 80	S	200	107,00 gal Zn								
M 5 x 30	S	500	14,00 gal Zn								

DIN 00931.810
931 8.8
 galvanisch verzinkt



Sechskantschrauben mit Schaft

kurze Abmessungen z. T. Gewinde bis Kopf

Maße → TI-15 Anziehmomente → TI-244
 Werkstoffeigensch. → TI-232 Normumstellung → TI-6
 Korrosionsschutz → TI-228

Rostfrei → S. 486
 Messing → S. 625

DIN 931 → wird ersetzt durch ISO 4014

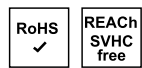

Abmessungen	VE	Stück	€/100/Obf.	Abmessungen	VE	Stück	€/100/Obf.	Abmessungen	VE	Stück	€/100/Obf.
M 8 x 220	S	100	370,00 gal Zn	M 14 x 65	S	50	134,00 gal Zn	M 18 x 150	S	25	620,00 gal Zn
M 10 x 40	S	100	29,50 gal Zn	M 14 x 70	S	50	136,00 gal Zn	M 18 x 160	S	25	690,00 gal Zn
M 10 x 45	S	100	31,00 gal Zn	M 14 x 75	S	50	163,00 gal Zn	M 18 x 170	S	25	910,00 gal Zn
M 10 x 50	S	100	32,50 gal Zn	M 14 x 80	S	50	170,00 gal Zn	M 18 x 180	S	25	910,00 gal Zn
M 10 x 55	S	100	35,50 gal Zn	M 14 x 85	S	50	187,00 gal Zn	M 18 x 190	S	1	1230,00 gal Zn
M 10 x 60	S	100	36,50 gal Zn	M 14 x 90	S	50	189,00 gal Zn	M 18 x 200	S	1	1240,00 gal Zn
M 10 x 65	S	100	39,50 gal Zn	M 14 x 95	S	50	210,00 gal Zn	M 18 x 220	S	1	1460,00 gal Zn
M 10 x 70	S	100	40,50 gal Zn	M 14 x 100	S	50	211,00 gal Zn	M 18 x 230	S	1	1620,00 gal Zn
M 10 x 75	S	100	44,50 gal Zn	M 14 x 110	S	50	241,00 gal Zn	M 18 x 240	S	1	1630,00 gal Zn
M 10 x 80	S	100	45,00 gal Zn	M 14 x 120	S	50	275,00 gal Zn	M 20 x 60	S	25	172,00 gal Zn
M 10 x 85	S	100	57,00 gal Zn	M 14 x 130	S	50	310,00 gal Zn	M 20 x 65	S	25	172,00 gal Zn
M 10 x 90	S	100	58,00 gal Zn	M 14 x 140	S	25	335,00 gal Zn	M 20 x 70	S	25	177,00 gal Zn
M 10 x 95	S	100	65,00 gal Zn	M 14 x 150	S	25	365,00 gal Zn	M 20 x 75	S	25	186,00 gal Zn
M 10 x 100	S	100	65,00 gal Zn	M 14 x 160	S	25	405,00 gal Zn	M 20 x 80	S	25	193,00 gal Zn
M 10 x 105	S	50	130,00 gal Zn	M 14 x 170	S	25	460,00 gal Zn	M 20 x 85	S	25	210,00 gal Zn
M 10 x 110	S	50	98,00 gal Zn	M 14 x 180	S	25	465,00 gal Zn	M 20 x 90	S	25	212,00 gal Zn
M 10 x 115	S	50	176,00 gal Zn	M 14 x 190	S	25	550,00 gal Zn	M 20 x 95	S	25	250,00 gal Zn
M 10 x 120	S	50	110,00 gal Zn	M 14 x 200	S	25	550,00 gal Zn	M 20 x 100	S	25	255,00 gal Zn
M 10 x 130	S	50	124,00 gal Zn	M 14 x 220	S	25	690,00 gal Zn	M 20 x 110	S	25	385,00 gal Zn
M 10 x 140	S	50	171,00 gal Zn	M 14 x 240	S	25	760,00 gal Zn	M 20 x 120	S	25	405,00 gal Zn
M 10 x 150	S	50	203,00 gal Zn	M 16 x 50	S	50	89,00 gal Zn	M 20 x 130	S	25	410,00 gal Zn
M 10 x 160	S	50	246,00 gal Zn	M 16 x 55	S	50	89,00 gal Zn	M 20 x 140	S	25	530,00 gal Zn
M 10 x 170	S	50	250,00 gal Zn	M 16 x 60	S	50	92,00 gal Zn	M 20 x 150	S	25	590,00 gal Zn
M 10 x 180	S	50	275,00 gal Zn	M 16 x 65	S	25	99,00 gal Zn	M 20 x 160	S	10	650,00 gal Zn
M 10 x 190	S	50	335,00 gal Zn	M 16 x 70	S	25	104,00 gal Zn	M 20 x 170	S	10	810,00 gal Zn
M 10 x 200	S	50	340,00 gal Zn	M 16 x 75	S	25	110,00 gal Zn	M 20 x 180	S	10	810,00 gal Zn
M 10 x 210	S	50	355,00 gal Zn	M 16 x 80	S	25	116,00 gal Zn	M 20 x 190	S	1	1190,00 gal Zn
M 10 x 220	S	50	650,00 gal Zn	M 16 x 85	S	25	142,00 gal Zn	M 20 x 200	S	1	1200,00 gal Zn
M 10 x 230	S	50	860,00 gal Zn	M 16 x 90	S	25	130,00 gal Zn	M 20 x 210	S	1	1460,00 gal Zn
M 10 x 240	S	50	700,00 gal Zn	M 16 x 95	S	25	154,00 gal Zn	M 20 x 220	S	1	1470,00 gal Zn
M 10 x 250	S	50	930,00 gal Zn	M 16 x 100	S	25	155,00 gal Zn	M 20 x 230	S	1	1620,00 gal Zn
M 10 x 260	S	50	760,00 gal Zn	M 16 x 110	S	25	229,00 gal Zn	M 20 x 240	S	1	1630,00 gal Zn
M 10 x 270	S	50	990,00 gal Zn	M 16 x 120	S	25	255,00 gal Zn	M 20 x 250	S	1	1780,00 gal Zn
M 10 x 280	S	50	810,00 gal Zn	M 16 x 130	S	25	270,00 gal Zn	M 20 x 260	S	1	1790,00 gal Zn
M 10 x 290	S	50	1170,00 gal Zn	M 16 x 140	S	25	345,00 gal Zn	M 20 x 270	S	1	1870,00 gal Zn
M 10 x 300	S	50	850,00 gal Zn	M 16 x 150	S	25	385,00 gal Zn	M 20 x 280	S	1	2020,00 gal Zn
M 12 x 45	S	100	45,50 gal Zn	M 16 x 160	S	25	430,00 gal Zn	M 20 x 290	S	1	2150,00 gal Zn
M 12 x 50	S	100	47,50 gal Zn	M 16 x 170	S	25	520,00 gal Zn	M 20 x 300	S	1	2300,00 gal Zn
M 12 x 55	S	100	49,50 gal Zn	M 16 x 180	S	25	520,00 gal Zn	M 20 x 310	S	1	2490,00 gal Zn
M 12 x 60	S	100	53,00 gal Zn	M 16 x 190	S	25	600,00 gal Zn	M 20 x 320	S	1	2440,00 gal Zn
M 12 x 65	S	50	57,00 gal Zn	M 16 x 200	S	25	610,00 gal Zn	M 20 x 330	S	1	2550,00 gal Zn
M 12 x 70	S	50	59,00 gal Zn	M 16 x 210	S	25	760,00 gal Zn	M 20 x 340	S	1	2650,00 gal Zn
M 12 x 75	S	50	62,00 gal Zn	M 16 x 220	S	1	760,00 gal Zn	M 20 x 350	S	1	2850,00 gal Zn
M 12 x 80	S	50	65,00 gal Zn	M 16 x 230	S	1	840,00 gal Zn	M 20 x 360	S	1	2850,00 gal Zn
M 12 x 85	S	50	81,00 gal Zn	M 16 x 240	S	1	850,00 gal Zn	M 20 x 380	S	1	3050,00 gal Zn
M 12 x 90	S	50	74,00 gal Zn	M 16 x 250	S	1	950,00 gal Zn	M 20 x 390	S	1	3200,00 gal Zn
M 12 x 95	S	50	88,00 gal Zn	M 16 x 260	S	1	950,00 gal Zn	M 20 x 400	S	1	3200,00 gal Zn
M 12 x 100	S	50	90,00 gal Zn	M 16 x 270	S	1	1260,00 gal Zn	M 20 x 420	S	1	3250,00 gal Zn
M 12 x 110	S	50	132,00 gal Zn	M 16 x 280	S	1	1270,00 gal Zn	M 20 x 430	S	1	4000,00 gal Zn
M 12 x 115	S	50	233,00 gal Zn	M 16 x 290	S	1	1410,00 gal Zn	M 20 x 440	S	1	4000,00 gal Zn
M 12 x 120	S	50	144,00 gal Zn	M 16 x 300	S	1	1420,00 gal Zn	M 20 x 450	S	1	4050,00 gal Zn
M 12 x 130	S	50	160,00 gal Zn	M 16 x 310	S	1	1670,00 gal Zn	M 20 x 460	S	1	4050,00 gal Zn
M 12 x 140	S	50	216,00 gal Zn	M 16 x 320	S	1	1590,00 gal Zn	M 20 x 480	S	1	4100,00 gal Zn
M 12 x 150	S	50	242,00 gal Zn	M 16 x 330	S	1	1780,00 gal Zn	M 20 x 500	S	1	4150,00 gal Zn
M 12 x 160	S	25	315,00 gal Zn	M 16 x 340	S	1	1610,00 gal Zn	M 22 x 70	S	25	590,00 gal Zn
M 12 x 170	S	25	350,00 gal Zn	M 16 x 350	S	1	1990,00 gal Zn	M 22 x 75	S	25	620,00 gal Zn
M 12 x 180	S	25	385,00 gal Zn	M 16 x 360	S	1	1790,00 gal Zn	M 22 x 80	S	25	620,00 gal Zn
M 12 x 190	S	25	410,00 gal Zn	M 16 x 370	S	1	2390,00 gal Zn	M 22 x 90	S	25	650,00 gal Zn
M 12 x 200	S	25	445,00 gal Zn	M 16 x 380	S	1	2200,00 gal Zn	M 22 x 100	S	10	710,00 gal Zn
M 12 x 210	S	25	500,00 gal Zn	M 16 x 390	S	1	2700,00 gal Zn	M 22 x 110	S	10	760,00 gal Zn
M 12 x 220	S	25	500,00 gal Zn	M 16 x 400	S	1	2480,00 gal Zn	M 22 x 120	S	10	820,00 gal Zn
M 12 x 230	S	25	670,00 gal Zn	M 16 x 420	S	1	2800,00 gal Zn	M 22 x 130	S	10	870,00 gal Zn
M 12 x 240	S	25	680,00 gal Zn	M 16 x 430	S	1	3400,00 gal Zn	M 22 x 140	S	10	880,00 gal Zn
M 12 x 250	S	25	760,00 gal Zn	M 16 x 440	S	1	3150,00 gal Zn	M 22 x 150	S	10	1020,00 gal Zn
M 12 x 260	S	25	740,00 gal Zn	M 18 x 65	S	25	320,00 gal Zn	M 22 x 160	S	10	1140,00 gal Zn
M 12 x 270	S	25	820,00 gal Zn	M 18 x 70	S	25	335,00 gal Zn	M 22 x 180	S	1	1410,00 gal Zn
M 12 x 280	S	25	810,00 gal Zn	M 18 x 75	S	25	345,00 gal Zn	M 22 x 200	S	1	1740,00 gal Zn
M 12 x 290	S	25	840,00 gal Zn	M 18 x 80	S	25	345,00 gal Zn	M 22 x 240	S	1	2180,00 gal Zn
M 12 x 300	S	25	880,00 gal Zn	M 18 x 90	S	25	375,00 gal Zn	M 22 x 260	S	1	2650,00 gal Zn
M 12 x 310	S	25	1360,00 gal Zn	M 18 x 95	S	25	405,00 gal Zn	M 22 x 280	S	1	2950,00 gal Zn
M 12 x 320	S	25	1260,00 gal Zn	M 18 x 100	S	25	410,00 gal Zn	M 22 x 300	S	1	3250,00 gal Zn
M 12 x 330	S	1	1780,00 gal Zn	M 18 x 110	S	25	460,00 gal Zn	M 24 x 75	S	25	305,00 gal Zn
M 14 x 50	S	100	113,00 gal Zn	M 18 x 120	S	25	470,00 gal Zn	M 24 x 80	S	25	310,00 gal Zn
M 14 x 55	S	50	120,00 gal Zn	M 18 x 130	S	25	510,00 gal Zn	M 24 x 85	S	10	385,00 gal Zn
M 14 x 60	S	50	123,00 gal Zn	M 18 x 140	S	25	610,00 gal Zn	M 24 x 90	S	10	370,00 gal Zn

Abmessungen	VE	Stück	€/100/Obf.
M 10 x 85	S	100	71,00 gal ZnDi
M 10 x 90	S	100	72,00 gal ZnDi
M 10 x 95	S	100	81,00 gal ZnDi
M 10 x 100	S	100	82,00 gal ZnDi
M 10 x 110	S	50	123,00 gal ZnDi
M 10 x 120	S	50	138,00 gal ZnDi
M 10 x 130	S	50	155,00 gal ZnDi
M 10 x 140	S	50	215,00 gal ZnDi
M 10 x 150	S	50	255,00 gal ZnDi
M 12 x 45	S	100	57,00 gal ZnDi
M 12 x 40	S	100	59,00 gal ZnDi
M 12 x 55	S	100	62,00 gal ZnDi
M 12 x 60	S	100	66,00 gal ZnDi
M 12 x 65	S	50	71,00 gal ZnDi
M 12 x 70	S	50	73,00 gal ZnDi
M 12 x 75	S	50	78,00 gal ZnDi
M 12 x 80	S	50	81,00 gal ZnDi
M 12 x 85	S	50	101,00 gal ZnDi
M 12 x 90	S	50	92,00 gal ZnDi
M 12 x 100	S	50	112,00 gal ZnDi
M 12 x 110	S	50	166,00 gal ZnDi
M 12 x 120	S	50	181,00 gal ZnDi
M 12 x 130	S	50	200,00 gal ZnDi
M 12 x 140	S	50	270,00 gal ZnDi
M 12 x 150	S	50	305,00 gal ZnDi
M 12 x 160	S	25	390,00 gal ZnDi
M 12 x 180	S	25	485,00 gal ZnDi
M 16 x 55	S	50	111,00 gal ZnDi
M 16 x 60	S	50	115,00 gal ZnDi
M 16 x 65	S	25	124,00 gal ZnDi
M 16 x 70	S	25	131,00 gal ZnDi
M 16 x 75	S	25	137,00 gal ZnDi
M 16 x 80	S	25	146,00 gal ZnDi
M 16 x 90	S	25	163,00 gal ZnDi
M 16 x 100	S	25	194,00 gal ZnDi
M 16 x 110	S	25	290,00 gal ZnDi
M 16 x 120	S	25	315,00 gal ZnDi
M 16 x 130	S	25	340,00 gal ZnDi
M 16 x 140	S	25	430,00 gal ZnDi
M 16 x 150	S	25	480,00 gal ZnDi
M 16 x 160	S	25	540,00 gal ZnDi
M 16 x 180	S	25	650,00 gal ZnDi
M 16 x 190	S	25	750,00 gal ZnDi
M 16 x 200	S	25	760,00 gal ZnDi
M 20 x 70	S	25	222,00 gal ZnDi
M 20 x 75	S	25	233,00 gal ZnDi
M 20 x 80	S	25	241,00 gal ZnDi
M 20 x 100	S	25	315,00 gal ZnDi
M 20 x 110	S	25	480,00 gal ZnDi
M 20 x 120	S	25	510,00 gal ZnDi
M 20 x 130	S	25	520,00 gal ZnDi
M 20 x 140	S	25	660,00 gal ZnDi
M 20 x 160	S	10	810,00 gal ZnDi
M 20 x 240	S	1	2040,00 gal ZnDi
M 24 x 75	S	25	380,00 gal ZnDi
M 24 x 80	S	25	390,00 gal ZnDi
M 24 x 90	S	10	460,00 gal ZnDi
M 24 x 100	S	10	500,00 gal ZnDi
M 24 x 110	S	10	740,00 gal ZnDi
M 24 x 120	S	10	800,00 gal ZnDi
M 24 x 130	S	10	820,00 gal ZnDi
M 24 x 140	S	10	1060,00 gal ZnDi
M 24 x 150	S	10	1150,00 gal ZnDi
M 24 x 180	S	1	1560,00 gal ZnDi
M 24 x 200	S	1	2130,00 gal ZnDi

Abmessungen	VE	Stück	€/100/Obf.
DIN		00931.428	
931		8.8	
		galv. verz. 8 DiSP* + SL**	



Sechskantschrauben mit Schaft

* < M 6 Mindestschichtdicke 5µm,
 **SL = Sealer and Lubrication
 (Versiegelung und Schmierung mit µ = 0,12 - 0,18),
 Korrosionsbeständigkeit NSS: 120h WR, 264h RR

- Maße → **TI-15** Anziehmomente → **TI-244**
- Werkstoffeigensch. → **TI-232** Normumstellung → **TI-6**
- Korrosionsschutz → **TI-228**
- Rostfrei → **S. 486**
- Messing → **S. 625**
- DIN 931 → wird ersetzt durch ISO 4014
- Ø M10, 12, 14, 22 mit ISO-Schlüsselweiten unter ISO 4014 vorrätig



M 5 x 50	S	200	22,90 gal ZnDi
M 6 x 30	S	500	10,10 gal ZnDi
M 6 x 35	S	200	11,30 gal ZnDi
M 6 x 40	S	200	12,80 gal ZnDi
M 6 x 45	S	200	14,10 gal ZnDi
M 6 x 50	S	200	16,60 gal ZnDi
M 6 x 55	S	200	20,50 gal ZnDi
M 6 x 60	S	200	22,00 gal ZnDi
M 6 x 65	S	200	34,50 gal ZnDi
M 6 x 70	S	200	35,00 gal ZnDi
M 6 x 75	S	200	38,00 gal ZnDi
M 6 x 80	S	200	46,00 gal ZnDi
M 6 x 90	S	100	60,00 gal ZnDi
M 6 x 95	S	100	79,00 gal ZnDi
M 6 x 100	S	100	75,00 gal ZnDi
M 6 x 110	S	100	77,00 gal ZnDi
M 6 x 120	S	100	94,00 gal ZnDi
M 6 x 130	S	100	107,00 gal ZnDi
M 6 x 140	S	100	151,00 gal ZnDi
M 6 x 175	S	100	222,00 gal ZnDi
M 6 x 220	S	100	1020,00 gal ZnDi
M 8 x 35	S	200	18,60 gal ZnDi
M 8 x 40	S	200	22,50 gal ZnDi
M 8 x 45	S	200	23,50 gal ZnDi
M 8 x 50	S	200	25,00 gal ZnDi
M 8 x 55	S	200	26,00 gal ZnDi
M 8 x 60	S	200	28,00 gal ZnDi
M 8 x 65	S	200	31,00 gal ZnDi
M 8 x 70	S	200	32,00 gal ZnDi
M 8 x 75	S	200	38,50 gal ZnDi
M 8 x 80	S	200	40,50 gal ZnDi
M 8 x 85	S	100	62,00 gal ZnDi
M 8 x 90	S	100	64,00 gal ZnDi
M 8 x 95	S	100	85,00 gal ZnDi
M 8 x 100	S	100	85,00 gal ZnDi
M 8 x 110	S	100	98,00 gal ZnDi
M 8 x 115	S	100	176,00 gal ZnDi
M 8 x 120	S	100	114,00 gal ZnDi
M 8 x 130	S	100	124,00 gal ZnDi
M 8 x 140	S	100	90,00 gal ZnDi
M 8 x 150	S	100	176,00 gal ZnDi
M 8 x 160	S	100	194,00 gal ZnDi
M 8 x 180	S	100	255,00 gal ZnDi
M 16 x 55	S	50	107,00 gal ZnDi
M 16 x 60	S	50	110,00 gal ZnDi
M 16 x 65	S	25	118,00 gal ZnDi

Abmessungen	VE	Stück	€/100/Obf.
M 16 x 70	S	25	125,00 gal ZnDi
M 16 x 75	S	25	131,00 gal ZnDi
M 16 x 80	S	25	139,00 gal ZnDi
M 16 x 90	S	25	156,00 gal ZnDi
M 16 x 100	S	25	186,00 gal ZnDi
M 16 x 110	S	25	275,00 gal ZnDi
M 16 x 120	S	25	305,00 gal ZnDi
M 16 x 130	S	25	325,00 gal ZnDi
M 16 x 140	S	25	410,00 gal ZnDi
M 16 x 150	S	25	460,00 gal ZnDi
M 16 x 160	S	25	520,00 gal ZnDi
M 14 x 130	S	25	610,00 gal ZnDi
M 16 x 180	S	25	630,00 gal ZnDi
M 16 x 190	S	25	720,00 gal ZnDi
M 16 x 200	S	25	730,00 gal ZnDi
M 16 x 220	S	25	780,00 gal ZnDi
M 16 x 230	S	25	880,00 gal ZnDi
M 16 x 260	S	25	1180,00 gal ZnDi
M 16 x 280	S	25	1280,00 gal ZnDi
M 16 x 300	S	25	1540,00 gal ZnDi
M 16 x 320	S	10	1800,00 gal ZnDi
M 16 x 360	S	10	2050,00 gal ZnDi
M 16 x 480	S	10	2850,00 gal ZnDi
M 18 x 70	S	25	425,00 gal ZnDi
M 20 x 65	S	25	207,00 gal ZnDi
M 20 x 70	S	25	212,00 gal ZnDi
M 20 x 75	S	25	223,00 gal ZnDi
M 20 x 80	S	25	231,00 gal ZnDi
M 20 x 90	S	25	255,00 gal ZnDi
M 20 x 100	S	25	305,00 gal ZnDi
M 20 x 105	S	25	370,00 gal ZnDi
M 20 x 110	S	25	460,00 gal ZnDi
M 20 x 120	S	25	485,00 gal ZnDi
M 20 x 130	S	25	495,00 gal ZnDi
M 20 x 140	S	25	640,00 gal ZnDi
M 20 x 150	S	25	660,00 gal ZnDi
M 20 x 160	S	25	770,00 gal ZnDi
M 20 x 170	S	25	860,00 gal ZnDi
M 20 x 180	S	10	950,00 gal ZnDi
M 20 x 190	S	10	1460,00 gal ZnDi
M 20 x 200	S	1	1580,00 gal ZnDi
M 20 x 210	S	1	1710,00 gal ZnDi
M 20 x 220	S	1	1850,00 gal ZnDi
M 20 x 230	S	10	1930,00 gal ZnDi
M 20 x 240	S	1	1960,00 gal ZnDi
M 20 x 260	S	10	2130,00 gal ZnDi
M 20 x 280	S	10	2290,00 gal ZnDi
M 20 x 300	S	10	2600,00 gal ZnDi
M 24 x 75	S	25	365,00 gal ZnDi
M 24 x 80	S	25	375,00 gal ZnDi
M 24 x 90	S	10	440,00 gal ZnDi
M 24 x 100	S	10	480,00 gal ZnDi
M 24 x 110	S	10	710,00 gal ZnDi
M 24 x 120	S	10	770,00 gal ZnDi
M 24 x 130	S	10	790,00 gal ZnDi
M 24 x 140	S	10	1020,00 gal ZnDi
M 24 x 150	S	10	1100,00 gal ZnDi
M 24 x 180	S	1	1500,00 gal ZnDi
M 24 x 200	S	1	2050,00 gal ZnDi
M 24 x 300	S	1	4250,00 gal ZnDi
M 27 x 180	S	1	1720,00 gal ZnDi
M 30 x 170	S	1	3400,00 gal ZnDi

Abmessungen	VE Stück	€/100/Obf.
DIN 00931.353		
931	8.8	
	flZn/TL480h	



Sechskantschrauben mit Schaft

kurze Abmessungen z. T. Gewinde bis Kopf,
 TL = Schmierstoff im Topcoat mit $\mu = 0,09 - 0,14$,
 Korrosionsbeständigkeit NSS: 480h RR,
 Chrom(VI)-frei

Achtung! Gegenüber galv. verzinkt geänderte Anziehdrehmomente.

Maße → **TI-15** Anziehdrehmomente → **TI-245**
 Werkstoffeigensch. → **TI-232** Normumstellung → **TI-6**
 Korrosionsschutz → **TI-230**

Rostfrei → **S. 486**
 Messing → **S. 625**

DIN 931 → wird ersetzt durch ISO 4014

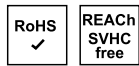

M 6	x	30	S	500	10,90 flZn
M 6	x	35	S	200	12,30 flZn
M 6	x	40	S	200	13,80 flZn
M 6	x	45	S	200	15,40 flZn
M 6	x	50	S	200	18,00 flZn
M 6	x	55	S	200	22,30 flZn
M 6	x	60	S	200	23,80 flZn
M 6	x	65	S	200	37,50 flZn
M 6	x	70	S	200	37,50 flZn
M 6	x	75	S	200	41,00 flZn
M 6	x	80	S	200	50,00 flZn
M 8	x	35	S	200	21,20 flZn
M 8	x	40	S	200	22,70 flZn
M 8	x	45	S	200	25,50 flZn
M 8	x	50	S	200	27,50 flZn
M 8	x	55	S	200	28,50 flZn
M 8	x	60	S	200	30,00 flZn
M 8	x	65	S	200	33,50 flZn
M 8	x	70	S	200	34,50 flZn
M 8	x	75	S	200	42,00 flZn
M 8	x	80	S	200	44,00 flZn
M 8	x	90	S	100	69,00 flZn
M 8	x	100	S	100	92,00 flZn
M 16	x	55	S	50	116,00 flZn
M 16	x	60	S	50	133,00 flZn
M 16	x	65	S	25	136,00 flZn
M 16	x	70	S	25	139,00 flZn
M 16	x	75	S	25	143,00 flZn
M 16	x	80	S	25	152,00 flZn
M 16	x	90	S	25	170,00 flZn
M 16	x	100	S	25	203,00 flZn
M 16	x	110	S	25	300,00 flZn
M 16	x	120	S	25	330,00 flZn
M 16	x	130	S	25	350,00 flZn
M 16	x	140	S	25	445,00 flZn
M 20	x	65	S	25	224,00 flZn
M 20	x	70	S	25	230,00 flZn
M 20	x	75	S	25	241,00 flZn
M 20	x	80	S	25	255,00 flZn
M 20	x	90	S	25	310,00 flZn
M 20	x	100	S	25	330,00 flZn
M 20	x	110	S	25	500,00 flZn
M 20	x	120	S	25	530,00 flZn
M 20	x	130	S	25	540,00 flZn
M 20	x	140	S	25	690,00 flZn
M 20	x	150	S	25	760,00 flZn

Abmessungen	VE Stück	€/100/Obf.			
M 20	x	160	S	10	840,00 flZn
M 20	x	170	S	10	1050,00 flZn
M 20	x	180	S	10	1060,00 flZn
M 24	x	75	S	25	395,00 flZn
M 24	x	80	S	25	530,00 flZn
M 24	x	90	S	10	560,00 flZn
M 24	x	100	S	10	770,00 flZn
M 24	x	110	S	10	800,00 flZn
M 24	x	120	S	10	830,00 flZn
M 24	x	130	S	10	850,00 flZn
M 24	x	140	S	10	1100,00 flZn
M 24	x	150	S	10	1200,00 flZn
M 24	x	160	S	10	1310,00 flZn
M 24	x	170	S	1	1610,00 flZn
M 24	x	180	S	1	1630,00 flZn

Abmessungen	VE Stück	€/100/Obf.
DIN 00931.820		
931	8.8	
	feuerverzinkt	

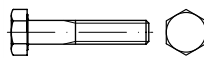

Sechskantschrauben mit Schaft

kurze Abmessungen z. T. Gewinde bis Kopf,
 Gewinde mit Untermaß (Gaz + tZn = U)

Achtung! Warneinblender zu Feuerverzinkung beachten.

Maße → **TI-15** Anziehdrehmomente → **TI-244**
 Werkstoffeigensch. → **TI-232** Normumstellung → **TI-6**
 Korrosionsschutz → **TI-231**

Rostfrei → **S. 486**
 Messing → **S. 625**

DIN 931 → wird ersetzt durch ISO 4014

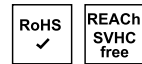

M 8	x	35	S	200	115,00 tZn
M 8	x	40	S	200	126,00 tZn
M 8	x	45	S	200	132,00 tZn
M 8	x	50	S	200	151,00 tZn
M 8	x	60	S	200	167,00 tZn
M 8	x	65	S	200	184,00 tZn
M 8	x	70	S	200	195,00 tZn
M 8	x	80	S	200	315,00 tZn
M 8	x	100	S	200	350,00 tZn
M 10	x	40	S	100	78,00 tZn
M 10	x	45	S	100	84,00 tZn
M 10	x	50	S	100	88,00 tZn
M 10	x	55	S	100	95,00 tZn
M 10	x	60	S	100	99,00 tZn
M 10	x	65	S	100	107,00 tZn
M 10	x	70	S	100	110,00 tZn
M 10	x	75	S	100	119,00 tZn
M 10	x	80	S	100	123,00 tZn
M 10	x	90	S	100	153,00 tZn
M 10	x	100	S	100	172,00 tZn
M 10	x	110	S	50	230,00 tZn
M 10	x	120	S	50	260,00 tZn
M 12	x	45	S	100	121,00 tZn
M 12	x	50	S	100	128,00 tZn
M 12	x	55	S	100	138,00 tZn
M 12	x	60	S	100	143,00 tZn
M 12	x	65	S	50	153,00 tZn
M 12	x	70	S	50	158,00 tZn
M 12	x	75	S	50	167,00 tZn
M 12	x	80	S	50	176,00 tZn
M 12	x	90	S	50	200,00 tZn

Abmessungen	VE Stück	€/100/Obf.			
M 12	x	100	S	50	236,00 tZn
M 12	x	110	S	50	315,00 tZn
M 12	x	120	S	50	340,00 tZn
M 12	x	130	S	50	375,00 tZn
M 12	x	140	S	50	495,00 tZn
M 12	x	150	S	50	560,00 tZn
M 12	x	160	S	25	700,00 tZn
M 12	x	180	S	25	860,00 tZn
M 12	x	200	S	25	990,00 tZn
M 16	x	55	S	50	241,00 tZn
M 16	x	60	S	50	255,00 tZn
M 16	x	65	S	25	275,00 tZn
M 16	x	70	S	25	285,00 tZn
M 16	x	75	S	25	305,00 tZn
M 16	x	80	S	25	320,00 tZn
M 16	x	90	S	25	385,00 tZn
M 16	x	100	S	25	415,00 tZn
M 16	x	110	S	25	550,00 tZn
M 16	x	120	S	25	600,00 tZn
M 16	x	130	S	25	630,00 tZn
M 16	x	140	S	25	800,00 tZn
M 16	x	150	S	25	880,00 tZn
M 16	x	160	S	25	980,00 tZn
M 16	x	180	S	25	1180,00 tZn
M 16	x	190	S	25	1400,00 tZn
M 16	x	200	S	25	1360,00 tZn
M 16	x	220	S	1	1700,00 tZn
M 16	x	240	S	1	1910,00 tZn
M 16	x	260	S	1	2140,00 tZn
M 16	x	300	S	1	3150,00 tZn
M 20	x	65	S	25	470,00 tZn
M 20	x	70	S	25	480,00 tZn
M 20	x	75	S	25	510,00 tZn
M 20	x	80	S	25	530,00 tZn
M 20	x	85	S	25	1050,00 tZn
M 20	x	90	S	25	580,00 tZn
M 20	x	100	S	25	670,00 tZn
M 20	x	110	S	25	910,00 tZn
M 20	x	120	S	25	960,00 tZn
M 20	x	130	S	25	980,00 tZn
M 20	x	140	S	25	1230,00 tZn
M 20	x	150	S	25	1350,00 tZn
M 20	x	160	S	10	1490,00 tZn
M 20	x	170	S	10	1650,00 tZn
M 20	x	180	S	10	1850,00 tZn
M 20	x	200	S	10	2700,00 tZn
M 20	x	210	S	1	3150,00 tZn
M 20	x	220	S	1	3250,00 tZn
M 20	x	240	S	1	3600,00 tZn
M 20	x	260	S	1	4000,00 tZn
M 20	x	300	S	1	5100,00 tZn
M 24	x	75	S	25	810,00 tZn
M 24	x	80	S	25	840,00 tZn
M 24	x	85	S	10	2550,00 tZn
M 24	x	90	S	10	980,00 tZn
M 24	x	95	S	10	2550,00 tZn
M 24	x	100	S	10	1050,00 tZn
M 24	x	110	S	10	1400,00 tZn
M 24	x	120	S	10	1500,00 tZn
M 24	x	130	S	10	1550,00 tZn
M 24	x	140	S	10	1990,00 tZn
M 24	x	150	S	10	2140,00 tZn
M 24	x	160	S	10	2320,00 tZn
M 24	x	180	S	1	2850,00 tZn
M 24	x	200	S	1	3850,00 tZn
M 24	x	220	S	1	4750,00 tZn
M 24	x	240	S	1	5100,00 tZn
M 24	x	260	S	1	5300,00 tZn
M 24	x	300	S	1	6700,00 tZn
M 27	x	90	S	10	2080,00 tZn
M 27	x	100	S	10	2470,00 tZn
M 27	x	110	S	1	2900,00 tZn
M 27	x	120	S	1	3000,00 tZn
M 27	x	130	S	1	3000,00 tZn
M 27	x	140	S	1	3100,00 tZn

Abmessungen	VE	Stück	€/100/Obf.
M 27 x 150	S	1	3150,00 tZn
M 27 x 160	S	1	3200,00 tZn
M 27 x 180	S	1	3600,00 tZn
M 27 x 200	S	1	4600,00 tZn
M 30 x 90	S	1	4000,00 tZn
M 30 x 100	S	1	4000,00 tZn
M 30 x 110	S	1	4650,00 tZn
M 30 x 120	S	1	4750,00 tZn
M 30 x 130	S	1	5200,00 tZn
M 30 x 140	S	1	5300,00 tZn
M 30 x 150	S	1	5500,00 tZn
M 30 x 160	S	1	5500,00 tZn
M 30 x 180	S	1	6100,00 tZn
M 30 x 200	S	1	6600,00 tZn
M 30 x 220	S	1	7500,00 tZn
M 30 x 240	S	1	8700,00 tZn
M 30 x 260	S	1	9800,00 tZn
M 30 x 280	S	1	10900,00 tZn
M 30 x 300	S	1	12300,00 tZn
M 33 x 120	S	1	5600,00 tZn
M 33 x 130	S	1	6000,00 tZn
M 33 x 140	S	1	6100,00 tZn
M 33 x 150	S	1	6300,00 tZn
M 33 x 180	S	1	7100,00 tZn
M 33 x 200	S	1	7500,00 tZn
M 36 x 120	S	1	6200,00 tZn
M 36 x 130	S	1	6600,00 tZn
M 36 x 140	S	1	6900,00 tZn
M 36 x 150	S	1	7200,00 tZn
M 36 x 160	S	1	7900,00 tZn
M 36 x 180	S	1	8400,00 tZn
M 36 x 190	S	1	8800,00 tZn
M 36 x 200	S	1	8900,00 tZn
M 36 x 220	S	1	9200,00 tZn

Abmessungen	VE	Stück	€/100/Obf.
DIN	00931.100		

931 10.9

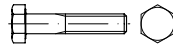

Sechskantschrauben mit Schaft

kurze Abmessungen z. T. Gewinde bis Kopf

Maße → TI-15 Anziehmomente → TI-244
 Werkstoffeigensch. → TI-232 Normumstellung → TI-6
 Rostfrei → S. 486
 Messing → S. 625

DIN 931 → wird ersetzt durch ISO 4014



M 5 x 25	S	500	24,60
M 5 x 30	S	500	26,00
M 5 x 35	S	200	27,50
M 5 x 40	S	200	29,50
M 5 x 45	S	200	31,50
M 5 x 50	S	200	33,00
M 5 x 55	S	200	35,00
M 5 x 60	S	200	38,00
M 5 x 65	S	200	51,00
M 5 x 70	S	200	52,00
M 5 x 75	S	200	58,00
M 5 x 80	S	200	63,00
M 6 x 30	S	500	14,90
M 6 x 35	S	200	15,70
M 6 x 40	S	200	16,70
M 6 x 45	S	200	19,70
M 6 x 50	S	200	22,00
M 6 x 55	S	200	24,20
M 6 x 60	S	200	26,50
M 6 x 65	S	200	32,00
M 6 x 70	S	200	32,00
M 6 x 80	S	200	70,00
M 6 x 90	S	200	120,00
M 6 x 100	S	100	129,00
M 6 x 110	S	100	138,00
M 6 x 120	S	100	152,00
M 6 x 130	S	100	189,00
M 6 x 140	S	100	209,00
M 8 x 35	S	200	27,00
M 8 x 40	S	200	29,50
M 8 x 45	S	200	33,00
M 8 x 50	S	200	33,50
M 8 x 55	S	200	33,50
M 8 x 60	S	200	35,00
M 8 x 65	S	200	39,50
M 8 x 70	S	200	42,50
M 8 x 75	S	200	54,00
M 8 x 80	S	200	54,00
M 8 x 90	S	100	59,00
M 8 x 100	S	100	68,00
M 8 x 110	S	100	83,00
M 8 x 120	S	100	92,00
M 8 x 130	S	100	148,00
M 8 x 140	S	100	176,00
M 8 x 150	S	100	199,00
M 8 x 160	S	100	224,00
M 8 x 170	S	100	275,00
M 8 x 180	S	100	246,00
M 8 x 190	S	100	320,00
M 8 x 200	S	100	295,00
M 8 x 220	S	100	395,00

Abmessungen	VE	Stück	€/100/Obf.
M 8 x 240	S	100	465,00
M 10 x 35	S	100	42,00
M 10 x 40	S	100	42,00
M 10 x 45	S	100	45,00
M 10 x 50	S	100	48,50
M 10 x 55	S	100	50,00
M 10 x 60	S	100	53,00
M 10 x 65	S	100	53,00
M 10 x 70	S	100	58,00
M 10 x 75	S	100	64,00
M 10 x 80	S	100	64,00
M 10 x 90	S	100	78,00
M 10 x 100	S	100	88,00
M 10 x 110	S	50	110,00
M 10 x 120	S	50	123,00
M 10 x 130	S	50	161,00
M 10 x 140	S	50	174,00
M 10 x 150	S	50	197,00
M 10 x 160	S	50	470,00
M 10 x 170	S	50	500,00
M 10 x 180	S	50	530,00
M 10 x 190	S	50	550,00
M 10 x 200	S	50	560,00
M 10 x 210	S	25	750,00
M 10 x 220	S	50	600,00
M 10 x 240	S	50	650,00
M 10 x 260	S	50	710,00
M 10 x 280	S	50	750,00
M 10 x 300	S	50	790,00
M 12 x 40	S	100	63,00
M 12 x 45	S	100	63,00
M 12 x 50	S	100	71,00
M 12 x 55	S	100	71,00
M 12 x 60	S	100	75,00
M 12 x 65	S	50	78,00
M 12 x 70	S	50	86,00
M 12 x 75	S	50	95,00
M 12 x 80	S	50	95,00
M 12 x 85	S	50	108,00
M 12 x 90	S	50	108,00
M 12 x 95	S	50	119,00
M 12 x 100	S	50	119,00
M 12 x 110	S	50	142,00
M 12 x 120	S	50	158,00
M 12 x 130	S	50	187,00
M 12 x 140	S	50	213,00
M 12 x 150	S	50	236,00
M 12 x 160	S	25	470,00
M 12 x 170	S	25	500,00
M 12 x 180	S	25	530,00
M 12 x 190	S	25	550,00
M 12 x 200	S	25	560,00
M 12 x 210	S	25	750,00
M 12 x 220	S	25	600,00
M 12 x 240	S	25	650,00
M 12 x 260	S	25	710,00
M 12 x 280	S	25	750,00
M 12 x 300	S	25	790,00
M 12 x 320	S	25	940,00
M 14 x 45	S	100	108,00
M 14 x 50	S	50	108,00
M 14 x 55	S	50	108,00
M 14 x 60	S	50	112,00
M 14 x 65	S	50	130,00
M 14 x 70	S	50	130,00
M 14 x 75	S	50	143,00
M 14 x 80	S	50	143,00
M 14 x 90	S	50	161,00
M 14 x 100	S	50	170,00
M 14 x 110	S	50	199,00
M 14 x 120	S	50	226,00
M 14 x 130	S	50	280,00
M 14 x 140	S	25	300,00
M 14 x 150	S	25	325,00
M 14 x 160	S	25	630,00

Achtung!

Feuerverzinkte Schrauben-/Mutter-Garnituren dürfen nur miteinander verschraubt werden, wenn Gewindenspiel/-Toleranzen dieser Garnituren entsprechend ISO 10684 passend aufeinander abgestimmt sind. Die Verwendung mit anderen Schrauben-/Mutter-Ausführungen kann zu Verschraubungsproblemen und/oder zum Versagen der Verbindung führen.



Abmessungen	VE	Stück	€/100/Obf.	Abmessungen	VE	Stück	€/100/Obf.	Abmessungen	VE	Stück	€/100/Obf.
M 14 x 170	S	25	690,00	M 20 x 110	S	25	455,00	M 24 x 290	S	1	2380,00
M 14 x 180	S	25	720,00	M 20 x 120	S	25	470,00	M 24 x 300	S	1	1990,00
M 14 x 190	S	25	730,00	M 20 x 130	S	25	560,00	M 24 x 310	S	1	2850,00
M 14 x 200	S	25	760,00	M 20 x 140	S	25	610,00	M 24 x 320	S	1	2320,00
M 14 x 220	S	25	810,00	M 20 x 150	S	25	680,00	M 24 x 330	S	1	3000,00
M 14 x 240	S	25	870,00	M 20 x 160	S	10	960,00	M 24 x 340	S	1	2600,00
M 16 x 55	S	50	143,00	M 20 x 170	S	10	980,00	M 24 x 350	S	1	3250,00
M 16 x 60	S	50	151,00	M 20 x 180	S	10	1030,00	M 24 x 360	S	1	2800,00
M 16 x 65	S	25	166,00	M 20 x 190	S	1	1090,00	M 24 x 370	S	1	4350,00
M 16 x 70	S	25	174,00	M 20 x 200	S	1	1110,00	M 24 x 380	S	1	4350,00
M 16 x 75	S	25	187,00	M 20 x 210	S	1	1350,00	M 24 x 390	S	1	4650,00
M 16 x 80	S	25	189,00	M 20 x 220	S	1	1160,00	M 24 x 400	S	1	4650,00
M 16 x 85	S	25	195,00	M 20 x 230	S	1	1450,00	M 27 x 80	S	10	1200,00
M 16 x 90	S	25	195,00	M 20 x 240	S	1	1240,00	M 27 x 90	S	10	1230,00
M 16 x 95	S	25	209,00	M 20 x 250	S	1	1580,00	M 27 x 100	S	10	1290,00
M 16 x 100	S	25	209,00	M 20 x 260	S	1	1330,00	M 27 x 110	S	10	1340,00
M 16 x 110	S	25	255,00	M 20 x 270	S	1	1680,00	M 27 x 120	S	10	1400,00
M 16 x 120	S	25	255,00	M 20 x 280	S	1	1400,00	M 27 x 130	S	10	1460,00
M 16 x 130	S	25	285,00	M 20 x 290	S	1	1950,00	M 27 x 140	S	1	1530,00
M 16 x 140	S	25	305,00	M 20 x 300	S	1	1500,00	M 27 x 150	S	1	1600,00
M 16 x 150	S	25	540,00	M 20 x 310	S	1	2250,00	M 27 x 160	S	1	1690,00
M 16 x 160	S	25	630,00	M 20 x 320	S	1	1730,00	M 27 x 170	S	1	1780,00
M 16 x 170	S	25	690,00	M 20 x 330	S	1	2380,00	M 27 x 180	S	1	1860,00
M 16 x 180	S	25	720,00	M 20 x 340	S	1	1880,00	M 27 x 190	S	1	1950,00
M 16 x 190	S	25	730,00	M 20 x 350	S	1	2700,00	M 27 x 200	S	1	2040,00
M 16 x 200	S	25	760,00	M 20 x 360	S	1	2050,00	M 27 x 210	S	1	2700,00
M 16 x 210	S	25	960,00	M 20 x 370	S	1	3350,00	M 27 x 220	S	1	2190,00
M 16 x 220	S	25	810,00	M 20 x 380	S	1	3350,00	M 27 x 230	S	1	3000,00
M 16 x 230	S	25	1020,00	M 20 x 390	S	1	3750,00	M 27 x 240	S	1	2380,00
M 16 x 240	S	25	870,00	M 20 x 400	S	1	3750,00	M 27 x 250	S	1	3200,00
M 16 x 250	S	25	1100,00	M 22 x 70	S	25	1170,00	M 27 x 260	S	1	2550,00
M 16 x 260	S	25	920,00	M 22 x 75	S	25	1170,00	M 27 x 270	S	1	3400,00
M 16 x 270	S	25	1240,00	M 22 x 80	S	25	850,00	M 27 x 280	S	1	2750,00
M 16 x 280	S	25	1160,00	M 22 x 90	S	25	970,00	M 27 x 290	S	1	3950,00
M 16 x 290	S	1	1430,00	M 22 x 100	S	10	1030,00	M 27 x 300	S	1	2950,00
M 16 x 300	S	1	1590,00	M 22 x 110	S	10	1110,00	M 27 x 320	S	1	3250,00
M 16 x 310	S	1	1700,00	M 22 x 120	S	10	1140,00	M 30 x 80	S	1	1420,00
M 16 x 320	S	1	1680,00	M 22 x 130	S	10	1190,00	M 30 x 90	S	1	1470,00
M 16 x 330	S	1	1780,00	M 22 x 140	S	10	1240,00	M 30 x 100	S	1	1500,00
M 16 x 340	S	1	1950,00	M 22 x 150	S	10	1290,00	M 30 x 110	S	1	1540,00
M 16 x 350	S	1	2070,00	M 22 x 160	S	10	1340,00	M 30 x 120	S	1	1660,00
M 16 x 360	S	1	1930,00	M 22 x 170	S	1	1380,00	M 30 x 130	S	1	1740,00
M 16 x 380	S	1	2470,00	M 22 x 180	S	1	1420,00	M 30 x 140	S	1	1850,00
M 16 x 400	S	1	2750,00	M 22 x 200	S	1	1500,00	M 30 x 150	S	1	1910,00
M 16 x 420	S	1	3450,00	M 22 x 220	S	1	1590,00	M 30 x 160	S	1	1990,00
M 18 x 65	S	25	340,00	M 22 x 230	S	1	1880,00	M 30 x 170	S	1	2090,00
M 18 x 70	S	25	350,00	M 22 x 240	S	1	1680,00	M 30 x 180	S	1	2190,00
M 18 x 75	S	25	370,00	M 22 x 260	S	1	1760,00	M 30 x 190	S	1	2290,00
M 18 x 80	S	25	375,00	M 22 x 280	S	1	1860,00	M 30 x 200	S	1	2370,00
M 18 x 90	S	25	420,00	M 22 x 300	S	1	3000,00	M 30 x 210	S	1	2700,00
M 18 x 100	S	25	440,00	M 22 x 320	S	1	3400,00	M 30 x 220	S	1	2450,00
M 18 x 110	S	25	455,00	M 24 x 75	S	25	850,00	M 30 x 230	S	1	3000,00
M 18 x 120	S	25	470,00	M 24 x 80	S	25	850,00	M 30 x 240	S	1	2700,00
M 18 x 130	S	25	560,00	M 24 x 85	S	10	970,00	M 30 x 250	S	1	3200,00
M 18 x 140	S	25	610,00	M 24 x 90	S	10	970,00	M 30 x 260	S	1	2900,00
M 18 x 150	S	25	680,00	M 24 x 100	S	10	1080,00	M 30 x 270	S	1	3400,00
M 18 x 160	S	25	960,00	M 24 x 105	S	10	1080,00	M 30 x 280	S	1	3100,00
M 18 x 170	S	25	980,00	M 24 x 110	S	10	1110,00	M 30 x 290	S	1	3950,00
M 18 x 180	S	25	1030,00	M 24 x 120	S	10	1140,00	M 30 x 300	S	1	3300,00
M 18 x 190	S	1	1090,00	M 24 x 130	S	10	1190,00	M 30 x 320	S	1	3800,00
M 18 x 200	S	1	1110,00	M 24 x 140	S	10	1240,00	M 30 x 330	S	1	4850,00
M 18 x 220	S	1	1160,00	M 24 x 150	S	10	1290,00	M 30 x 340	S	1	4050,00
M 18 x 240	S	1	1760,00	M 24 x 160	S	10	1340,00	M 30 x 350	S	1	5100,00
M 18 x 260	S	1	1830,00	M 24 x 170	S	1	1380,00	M 30 x 360	S	1	4400,00
M 18 x 280	S	1	1950,00	M 24 x 180	S	1	1420,00	M 30 x 380	S	1	4650,00
M 18 x 300	S	1	2120,00	M 24 x 190	S	1	1460,00	M 30 x 400	S	1	4900,00
M 18 x 320	S	1	2420,00	M 24 x 200	S	1	1500,00	M 33 x 100	S	1	1800,00
M 20 x 65	S	25	340,00	M 24 x 210	S	1	1770,00	M 33 x 110	S	1	1910,00
M 20 x 70	S	25	350,00	M 24 x 220	S	1	1590,00	M 33 x 120	S	1	2050,00
M 20 x 75	S	25	370,00	M 24 x 230	S	1	1880,00	M 33 x 130	S	1	2160,00
M 20 x 80	S	25	375,00	M 24 x 240	S	1	1680,00	M 33 x 140	S	1	2290,00
M 20 x 85	S	25	420,00	M 24 x 250	S	1	2030,00	M 33 x 150	S	1	2420,00
M 20 x 90	S	25	420,00	M 24 x 260	S	1	1760,00	M 33 x 160	S	1	2550,00
M 20 x 95	S	25	440,00	M 24 x 270	S	1	2140,00	M 33 x 170	S	1	2700,00
M 20 x 100	S	25	440,00	M 24 x 280	S	1	1860,00	M 33 x 180	S	1	2800,00

Abmessungen	VE	Stück	€/100/Obf.
M 33 x 190	S	1	2950,00
M 33 x 200	S	1	3050,00
M 33 x 220	S	1	3200,00
M 33 x 240	S	1	3400,00
M 33 x 250	S	1	4750,00
M 33 x 260	S	1	3650,00
M 33 x 280	S	1	3900,00
M 33 x 300	S	1	4150,00
M 33 x 320	S	1	4750,00
M 36 x 110	S	1	2280,00
M 36 x 120	S	1	2430,00
M 36 x 130	S	1	2600,00
M 36 x 140	S	1	2750,00
M 36 x 150	S	1	2900,00
M 36 x 160	S	1	3000,00
M 36 x 170	S	1	3150,00
M 36 x 180	S	1	3300,00
M 36 x 190	S	1	3450,00
M 36 x 200	S	1	3600,00
M 36 x 210	S	1	4100,00
M 36 x 220	S	1	3750,00
M 36 x 230	S	1	4400,00
M 36 x 240	S	1	4000,00
M 36 x 250	S	1	4750,00
M 36 x 260	S	1	4350,00
M 36 x 270	S	1	5100,00
M 36 x 280	S	1	4600,00
M 36 x 290	S	1	5900,00
M 36 x 300	S	1	4900,00
M 36 x 320	S	1	5600,00
M 36 x 340	S	1	6000,00
M 36 x 360	S	1	6300,00
M 36 x 380	S	1	6700,00
M 36 x 400	S	1	7300,00
M 39 x 110	S	1	3250,00
M 39 x 120	S	1	3250,00
M 39 x 130	S	1	3450,00
M 39 x 140	S	1	3600,00
M 39 x 150	S	1	3800,00
M 39 x 160	S	1	3900,00
M 39 x 170	S	1	4050,00
M 39 x 180	S	1	4250,00
M 39 x 200	S	1	4600,00
M 39 x 220	S	1	4950,00
M 39 x 240	S	1	5300,00
M 39 x 260	S	1	5700,00
M 39 x 280	S	1	6000,00
M 39 x 300	S	1	6400,00
M 39 x 320	S	1	7100,00
M 42 x 120	S	1	3850,00
M 42 x 130	S	1	4050,00
M 42 x 140	S	1	4250,00
M 42 x 150	S	1	4450,00
M 42 x 160	S	1	4550,00
M 42 x 170	S	1	4750,00
M 42 x 180	S	1	4950,00
M 42 x 190	S	1	5200,00
M 42 x 200	S	1	5400,00
M 42 x 220	S	1	5800,00
M 42 x 240	S	1	6200,00
M 42 x 260	S	1	6600,00
M 42 x 280	S	1	7000,00
M 42 x 300	S	1	7500,00
M 42 x 320	S	1	8300,00
M 45 x 130	S	1	9700,00
M 45 x 140	S	1	10100,00
M 45 x 150	S	1	10500,00
M 45 x 160	S	1	11200,00
M 45 x 180	S	1	12000,00
M 45 x 200	S	1	13100,00
M 45 x 220	S	1	14000,00
M 45 x 240	S	1	14900,00
M 45 x 260	S	1	15900,00
M 45 x 280	S	1	16800,00
M 45 x 300	S	1	17700,00

Abmessungen	VE	Stück	€/100/Obf.
M 45 x 320	S	1	21400,00
M 48 x 140	S	1	12200,00
M 48 x 150	S	1	13100,00
M 48 x 160	S	1	13700,00
M 48 x 180	S	1	14000,00
M 48 x 200	S	1	15700,00
M 48 x 220	S	1	16400,00
M 48 x 240	S	1	17400,00
M 48 x 260	S	1	18700,00
M 48 x 280	S	1	20500,00
M 48 x 300	S	1	23200,00
M 48 x 320	S	1	26100,00

DIN	00931.110
931	10.9
	galvanisch verzinkt

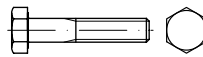

Sechskantschrauben mit Schaft

kurze Abmessungen z. T. Gewinde bis Kopf, getempert

Achtung! Warneinblender zu Wasserstoffversprödung beachten.

Maße → **TI-15** Anziehmomente → **TI-244**
 Werkstoffeigensch. → **TI-232** Normumstellung → **TI-6**
 Korrosionsschutz → **TI-228**

Rostfrei → **S. 486**
 Messing → **S. 625**

DIN 931 → wird ersetzt durch ISO 4014

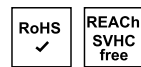

M 6 x 30	S	500	20,00 gal Zn
M 6 x 35	S	200	20,80 gal Zn
M 6 x 40	S	200	21,80 gal Zn
M 6 x 45	S	200	25,50 gal Zn
M 6 x 50	S	200	28,00 gal Zn
M 6 x 55	S	200	31,00 gal Zn
M 6 x 60	S	200	33,50 gal Zn
M 6 x 65	S	200	39,50 gal Zn
M 6 x 70	S	200	41,50 gal Zn
M 6 x 80	S	200	79,00 gal Zn
M 6 x 90	S	200	134,00 gal Zn
M 6 x 100	S	100	140,00 gal Zn
M 8 x 35	S	200	36,50 gal Zn
M 8 x 40	S	200	39,50 gal Zn
M 8 x 45	S	200	44,00 gal Zn
M 8 x 50	S	200	46,00 gal Zn
M 8 x 55	S	200	46,50 gal Zn
M 8 x 60	S	200	48,00 gal Zn
M 8 x 65	S	200	54,00 gal Zn
M 8 x 70	S	200	58,00 gal Zn
M 8 x 75	S	200	69,00 gal Zn
M 8 x 80	S	200	70,00 gal Zn
M 8 x 100	S	100	89,00 gal Zn
M 8 x 110	S	100	106,00 gal Zn
M 8 x 120	S	100	117,00 gal Zn
M 8 x 130	S	100	176,00 gal Zn
M 8 x 140	S	100	206,00 gal Zn
M 8 x 150	S	100	230,00 gal Zn
M 10 x 40	S	100	60,00 gal Zn
M 10 x 45	S	100	64,00 gal Zn
M 10 x 50	S	100	68,00 gal Zn
M 10 x 55	S	100	72,00 gal Zn
M 10 x 60	S	100	74,00 gal Zn
M 10 x 65	S	100	77,00 gal Zn

Abmessungen	VE	Stück	€/100/Obf.
M 10 x 70	S	100	83,00 gal Zn
M 10 x 75	S	100	91,00 gal Zn
M 10 x 80	S	100	92,00 gal Zn
M 10 x 90	S	100	109,00 gal Zn
M 10 x 100	S	100	123,00 gal Zn
M 10 x 110	S	50	147,00 gal Zn
M 10 x 120	S	50	163,00 gal Zn
M 10 x 130	S	50	205,00 gal Zn
M 10 x 140	S	100	224,00 gal Zn
M 10 x 150	S	50	249,00 gal Zn
M 10 x 160	S	50	530,00 gal Zn
M 10 x 170	S	50	560,00 gal Zn
M 10 x 180	S	50	590,00 gal Zn
M 12 x 45	S	100	88,00 gal Zn
M 12 x 50	S	100	93,00 gal Zn
M 12 x 55	S	100	101,00 gal Zn
M 12 x 60	S	100	101,00 gal Zn
M 12 x 65	S	50	104,00 gal Zn
M 12 x 70	S	50	113,00 gal Zn
M 12 x 75	S	50	126,00 gal Zn
M 12 x 80	S	50	129,00 gal Zn
M 12 x 85	S	50	143,00 gal Zn
M 12 x 90	S	50	147,00 gal Zn
M 12 x 95	S	50	165,00 gal Zn
M 12 x 100	S	50	161,00 gal Zn
M 12 x 110	S	50	186,00 gal Zn
M 12 x 120	S	50	205,00 gal Zn
M 12 x 130	S	50	240,00 gal Zn
M 12 x 140	S	50	280,00 gal Zn
M 12 x 150	S	50	305,00 gal Zn
M 12 x 160	S	25	550,00 gal Zn
M 12 x 170	S	25	590,00 gal Zn
M 12 x 180	S	25	620,00 gal Zn
M 12 x 190	S	25	630,00 gal Zn
M 12 x 200	S	25	650,00 gal Zn
M 14 x 45	S	100	140,00 gal Zn
M 14 x 50	S	50	144,00 gal Zn
M 14 x 55	S	50	148,00 gal Zn
M 14 x 60	S	50	154,00 gal Zn
M 14 x 70	S	50	177,00 gal Zn
M 14 x 75	S	50	197,00 gal Zn
M 14 x 80	S	50	195,00 gal Zn
M 14 x 90	S	50	217,00 gal Zn
M 14 x 100	S	50	230,00 gal Zn
M 14 x 110	S	50	270,00 gal Zn
M 14 x 120	S	50	305,00 gal Zn
M 14 x 130	S	50	365,00 gal Zn
M 14 x 140	S	25	390,00 gal Zn
M 14 x 150	S	25	420,00 gal Zn
M 16 x 55	S	50	197,00 gal Zn
M 16 x 60	S	50	200,00 gal Zn
M 16 x 65	S	25	227,00 gal Zn
M 16 x 70	S	25	222,00 gal Zn
M 16 x 75	S	25	246,00 gal Zn
M 16 x 80	S	25	260,00 gal Zn
M 16 x 85	S	25	270,00 gal Zn
M 16 x 90	S	25	270,00 gal Zn

Wichtiger Hinweis!

Bei galvanischen Überzügen auf hochfesten und federharten Teilen ($\geq 1000 \text{ N/mm}^2$ oder $\geq 320 \text{ HV}$) ist die Gefahr einer Wasserstoffversprödung (Sprödbruchgefahr) nicht mit Sicherheit auszuschließen (ISO 4042). Durch eine rechtzeitig eingeleitete thermische Nachbehandlung (Tempern) kann die Gefahr eines wasserstoffinduzierten Sprödbruches im Regelfall verringert werden. Da aber ein Restrisiko nicht mit Sicherheit auszuschließen ist, erfolgen galvanische Überzüge auf derartigen Teilen nur auf ausdrücklichen Wunsch und auf Risiko des Auftraggebers.



Abmessungen	VE	Stück	€/100/0bf.	Abmessungen	VE	Stück	€/100/0bf.	Abmessungen	VE	Stück	€/100/0bf.
M 16 x 100	S	25	290,00 gal Zn	M 24 x 260	S	1	2380,00 gal Zn	M 8 x 40	S	200	45,50 flZn
M 16 x 110	S	25	345,00 gal Zn	M 24 x 270	S	1	2470,00 gal Zn	M 8 x 45	S	200	51,00 flZn
M 16 x 120	S	25	350,00 gal Zn	M 24 x 280	S	1	2550,00 gal Zn	M 8 x 50	S	200	53,00 flZn
M 16 x 130	S	25	410,00 gal Zn	M 24 x 290	S	1	2600,00 gal Zn	M 8 x 55	S	200	54,00 flZn
M 16 x 140	S	25	420,00 gal Zn	M 24 x 300	S	1	2550,00 gal Zn	M 8 x 60	S	200	56,00 flZn
M 16 x 150	S	25	660,00 gal Zn	M 27 x 80	S	10	1440,00 gal Zn	M 8 x 65	S	200	62,00 flZn
M 16 x 160	S	25	760,00 gal Zn	M 27 x 90	S	10	1490,00 gal Zn	M 8 x 70	S	200	67,00 flZn
M 16 x 170	S	25	830,00 gal Zn	M 27 x 100	S	10	1580,00 gal Zn	M 8 x 75	S	200	80,00 flZn
M 16 x 180	S	25	860,00 gal Zn	M 27 x 110	S	10	1650,00 gal Zn	M 8 x 80	S	200	81,00 flZn
M 16 x 190	S	25	890,00 gal Zn	M 27 x 120	S	10	1740,00 gal Zn	M 8 x 100	S	100	102,00 flZn
M 16 x 200	S	25	930,00 gal Zn	M 27 x 130	S	10	1790,00 gal Zn	M 16 x 55	S	50	227,00 flZn
M 16 x 210	S	25	1140,00 gal Zn	M 27 x 140	S	1	1890,00 gal Zn	M 16 x 60	S	50	230,00 flZn
M 16 x 230	S	25	1210,00 gal Zn	M 30 x 80	S	1	1730,00 gal Zn	M 16 x 65	S	25	265,00 flZn
M 16 x 240	S	25	1060,00 gal Zn	M 30 x 90	S	1	1810,00 gal Zn	M 16 x 70	S	25	260,00 flZn
M 16 x 250	S	25	1320,00 gal Zn	M 30 x 100	S	1	1860,00 gal Zn	M 16 x 75	S	25	285,00 flZn
M 16 x 260	S	25	1130,00 gal Zn	M 30 x 110	S	1	1930,00 gal Zn	M 16 x 80	S	25	295,00 flZn
M 16 x 270	S	25	1460,00 gal Zn	M 30 x 120	S	1	2070,00 gal Zn	M 16 x 90	S	25	315,00 flZn
M 16 x 280	S	25	1400,00 gal Zn	M 30 x 130	S	1	2180,00 gal Zn	M 16 x 100	S	25	335,00 flZn
M 18 x 65	S	25	420,00 gal Zn	M 30 x 140	S	1	2300,00 gal Zn	M 16 x 110	S	25	395,00 flZn
M 18 x 70	S	25	445,00 gal Zn	M 30 x 150	S	1	2400,00 gal Zn	M 16 x 120	S	25	405,00 flZn
M 18 x 80	S	25	470,00 gal Zn	M 30 x 160	S	1	2500,00 gal Zn	M 16 x 130	S	25	470,00 flZn
M 18 x 90	S	25	530,00 gal Zn	M 30 x 170	S	1	2650,00 gal Zn	M 16 x 140	S	25	480,00 flZn
M 18 x 100	S	25	550,00 gal Zn	M 30 x 180	S	1	2800,00 gal Zn	M 20 x 65	S	25	510,00 flZn
M 18 x 110	S	25	590,00 gal Zn	M 30 x 190	S	1	2900,00 gal Zn	M 20 x 70	S	25	510,00 flZn
M 18 x 120	S	25	620,00 gal Zn	M 30 x 200	S	1	3000,00 gal Zn	M 20 x 75	S	25	530,00 flZn
M 18 x 130	S	25	690,00 gal Zn	M 30 x 210	S	1	3350,00 gal Zn	M 20 x 80	S	25	550,00 flZn
M 18 x 140	S	25	760,00 gal Zn	M 30 x 220	S	1	3150,00 gal Zn	M 20 x 90	S	25	610,00 flZn
M 18 x 160	S	25	1130,00 gal Zn	M 30 x 230	S	1	3700,00 gal Zn	M 20 x 100	S	25	640,00 flZn
M 20 x 65	S	25	445,00 gal Zn	M 30 x 240	S	1	3450,00 gal Zn	M 20 x 110	S	25	700,00 flZn
M 20 x 70	S	25	440,00 gal Zn	M 30 x 250	S	1	3950,00 gal Zn	M 20 x 120	S	25	740,00 flZn
M 20 x 75	S	25	460,00 gal Zn	M 30 x 260	S	1	3650,00 gal Zn	M 20 x 130	S	25	850,00 flZn
M 20 x 80	S	25	475,00 gal Zn	M 30 x 270	S	1	4250,00 gal Zn	M 20 x 140	S	25	910,00 flZn
M 20 x 85	S	25	550,00 gal Zn	M 30 x 280	S	1	3950,00 gal Zn	M 20 x 150	S	25	1010,00 flZn
M 20 x 90	S	25	530,00 gal Zn	M 30 x 300	S	1	4200,00 gal Zn	M 20 x 160	S	10	1460,00 flZn
M 20 x 100	S	25	560,00 gal Zn					M 20 x 170	S	10	1390,00 flZn
M 20 x 110	S	25	610,00 gal Zn					M 20 x 180	S	10	1560,00 flZn
M 20 x 115	S	25	630,00 gal Zn					M 24 x 75	S	25	1170,00 flZn
M 20 x 120	S	25	640,00 gal Zn					M 24 x 80	S	25	1180,00 flZn
M 20 x 130	S	25	740,00 gal Zn					M 24 x 90	S	10	1340,00 flZn
M 20 x 140	S	25	790,00 gal Zn					M 24 x 100	S	10	1420,00 flZn
M 20 x 150	S	25	870,00 gal Zn					M 24 x 110	S	10	1550,00 flZn
M 20 x 160	S	10	1270,00 gal Zn					M 24 x 120	S	10	1590,00 flZn
M 20 x 170	S	10	1210,00 gal Zn					M 24 x 130	S	10	1670,00 flZn
M 20 x 180	S	10	1360,00 gal Zn					M 24 x 140	S	10	1730,00 flZn
M 20 x 200	S	10	1370,00 gal Zn					M 24 x 150	S	10	1820,00 flZn
M 20 x 220	S	1	1440,00 gal Zn					M 24 x 160	S	10	1900,00 flZn
M 20 x 230	S	1	1750,00 gal Zn					M 24 x 170	S	1	1980,00 flZn
M 20 x 240	S	1	1540,00 gal Zn					M 24 x 180	S	1	2030,00 flZn
M 20 x 250	S	1	1890,00 gal Zn					M 24 x 200	S	1	2130,00 flZn
M 20 x 260	S	1	1670,00 gal Zn					M 24 x 230	S	1	2180,00 flZn
M 20 x 270	S	1	2030,00 gal Zn								
M 20 x 280	S	1	1760,00 gal Zn								
M 20 x 290	S	1	2330,00 gal Zn								
M 20 x 300	S	1	1880,00 gal Zn								
M 20 x 310	S	1	2650,00 gal Zn								
M 20 x 320	S	1	2130,00 gal Zn								
M 20 x 340	S	1	2180,00 gal Zn								
M 24 x 75	S	25	1010,00 gal Zn								
M 24 x 80	S	25	1030,00 gal Zn								
M 24 x 90	S	10	1170,00 gal Zn								
M 24 x 100	S	10	1240,00 gal Zn								
M 24 x 110	S	10	1350,00 gal Zn								
M 24 x 120	S	10	1390,00 gal Zn								
M 24 x 130	S	10	1450,00 gal Zn								
M 24 x 140	S	10	1500,00 gal Zn								
M 24 x 145	S	10	1590,00 gal Zn								
M 24 x 150	S	10	1590,00 gal Zn								
M 24 x 160	S	10	1660,00 gal Zn								
M 24 x 170	S	1	1720,00 gal Zn								
M 24 x 180	S	1	1760,00 gal Zn								
M 24 x 190	S	1	1810,00 gal Zn								
M 24 x 200	S	1	1880,00 gal Zn								
M 24 x 220	S	1	2130,00 gal Zn								
M 24 x 240	S	1	2260,00 gal Zn								
M 24 x 250	S	1	2370,00 gal Zn								
M 6 x 30	S	500	23,00 flZn								
M 6 x 35	S	200	23,90 flZn								
M 6 x 40	S	200	25,50 flZn								
M 6 x 45	S	200	29,50 flZn								
M 6 x 50	S	200	32,50 flZn								
M 6 x 55	S	200	36,00 flZn								
M 6 x 60	S	200	38,50 flZn								
M 6 x 65	S	200	45,50 flZn								
M 6 x 70	S	200	47,50 flZn								
M 6 x 80	S	200	91,00 flZn								
M 8 x 35	S	200	42,00 flZn								

DIN 00931.354

931 10.9 flZn/TL480h

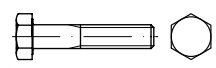

Sechskantschrauben mit Schaft

kurze Abmessungen z. T. Gewinde bis Kopf,
 TL = Schmierstoff im Topcoat mit $\mu = 0,09 - 0,14$,
 Korrosionsbeständigkeit NSS: 480h RR,
 Chrom(VI)-frei

Achtung! Gegenüber galv. verzinkt geänderte Anziehdrehmomente.

- Maße → **TI-15** Anziehmomente → **TI-245**
- Werkstoffeigensch. → **TI-232** Normumstellung → **TI-6**
- Korrosionsschutz → **TI-230**
- Rostfrei → **S. 486**
- Messing → **S. 625**

DIN 931 → wird ersetzt durch ISO 4014

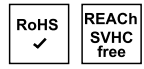

Abmessungen	VE Stück	€/100/Obf.
DIN	00931.132	
931	10.9	
	flZnL480h	



Sechskantschrauben mit Schaft

kurze Abmessungen z. T. Gewinde bis Kopf,
flZnL = int. Schmierstoff mit $\mu = 0,12 - 0,18$,
Korrosionsbeständigkeit NSS: 480h RR, Chrom(VI)-frei

Maße → **TI-15** Anziehungsmomente → **TI-244**
Werkstoffeigensch. → **TI-232** Normumstellung → **TI-6**
Korrosionsschutz → **TI-230**

Rostfrei → **S. 486**
Messing → **S. 625**

• DIN 931 → wird ersetzt durch ISO 4014
• Ø M10, 12, 14, 22 mit ISO-Schlüsselweiten unter ISO 4014 vorrätig

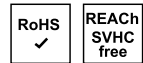

M 6	x	30	S	500	23,00 flZn
M 6	x	35	S	200	23,90 flZn
M 6	x	40	S	200	25,50 flZn
M 6	x	45	S	200	29,50 flZn
M 6	x	50	S	200	32,50 flZn
M 6	x	55	S	200	36,00 flZn
M 6	x	60	S	200	38,50 flZn
M 6	x	65	S	200	45,50 flZn
M 6	x	70	S	200	47,50 flZn
M 6	x	80	S	200	91,00 flZn
M 8	x	35	S	200	42,00 flZn
M 8	x	40	S	200	45,50 flZn
M 8	x	45	S	200	51,00 flZn
M 8	x	50	S	200	53,00 flZn
M 8	x	55	S	200	54,00 flZn
M 8	x	60	S	200	56,00 flZn
M 8	x	65	S	200	62,00 flZn
M 8	x	70	S	200	67,00 flZn
M 8	x	75	S	200	80,00 flZn
M 8	x	80	S	200	81,00 flZn
M 8	x	90	S	100	90,00 flZn
M 8	x	100	S	100	102,00 flZn
M 8	x	150	S	100	365,00 flZn
M 8	x	240	S	100	530,00 flZn
M 16	x	55	S	50	227,00 flZn
M 16	x	60	S	50	230,00 flZn
M 16	x	65	S	25	265,00 flZn
M 16	x	70	S	25	260,00 flZn
M 16	x	75	S	25	285,00 flZn
M 16	x	80	S	25	295,00 flZn
M 16	x	90	S	25	315,00 flZn
M 16	x	95	S	25	320,00 flZn
M 16	x	100	S	25	335,00 flZn
M 16	x	110	S	25	395,00 flZn
M 16	x	120	S	25	405,00 flZn
M 16	x	125	S	25	435,00 flZn
M 16	x	130	S	25	470,00 flZn
M 16	x	140	S	25	480,00 flZn
M 16	x	150	S	25	510,00 flZn
M 16	x	190	S	25	550,00 flZn
M 16	x	200	S	25	570,00 flZn
M 18	x	90	S	25	335,00 flZn
M 18	x	100	S	25	355,00 flZn
M 20	x	65	S	25	510,00 flZn
M 20	x	70	S	25	510,00 flZn
M 20	x	75	S	25	530,00 flZn
M 20	x	80	S	25	550,00 flZn

Abmessungen	VE Stück	€/100/Obf.			
M 20	x	90	S	25	610,00 flZn
M 20	x	95	S	25	620,00 flZn
M 20	x	100	S	25	640,00 flZn
M 20	x	105	S	25	670,00 flZn
M 20	x	110	S	25	700,00 flZn
M 20	x	120	S	25	740,00 flZn
M 20	x	130	S	25	850,00 flZn
M 20	x	140	S	25	910,00 flZn
M 20	x	150	S	25	1010,00 flZn
M 20	x	160	S	10	1460,00 flZn
M 20	x	170	S	10	1390,00 flZn
M 20	x	180	S	10	1560,00 flZn
M 20	x	200	S	10	2170,00 flZn
M 20	x	290	S	1	2600,00 flZn
M 20	x	340	S	1	3100,00 flZn
M 20	x	360	S	1	3200,00 flZn
M 20	x	380	S	1	3350,00 flZn
M 24	x	75	S	25	1170,00 flZn
M 24	x	80	S	25	1180,00 flZn
M 24	x	90	S	10	1340,00 flZn
M 24	x	100	S	10	1420,00 flZn
M 24	x	110	S	10	1550,00 flZn
M 24	x	120	S	10	1590,00 flZn
M 24	x	130	S	10	1670,00 flZn
M 24	x	135	S	10	1710,00 flZn
M 24	x	140	S	10	1730,00 flZn
M 24	x	150	S	10	1820,00 flZn
M 24	x	160	S	10	1900,00 flZn
M 24	x	170	S	1	1980,00 flZn
M 24	x	180	S	1	2030,00 flZn
M 24	x	200	S	1	2130,00 flZn
M 24	x	230	S	1	2180,00 flZn
M 24	x	240	S	1	2320,00 flZn
M 24	x	300	S	1	2600,00 flZn

Abmessungen	VE Stück	€/100/Obf.
DIN	00931.200	
931	12.9	

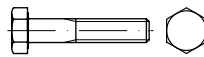

Sechskantschrauben mit Schaft

kurze Abmessungen z. T. Gewinde bis Kopf

Maße → **TI-15** Anziehungsmomente → **TI-244**
Werkstoffeigensch. → **TI-232** Normumstellung → **TI-6**

Rostfrei → **S. 486**
Messing → **S. 625**

DIN 931 → wird ersetzt durch ISO 4014

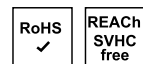

M 10	x	40	S	100	180,00
M 10	x	45	S	100	180,00
M 10	x	50	S	100	213,00
M 10	x	60	S	100	285,00
M 10	x	70	S	100	360,00
M 10	x	80	S	100	395,00
M 10	x	90	S	100	480,00
M 10	x	100	S	100	510,00
M 12	x	45	S	100	199,00
M 12	x	50	S	100	236,00
M 12	x	55	S	100	260,00
M 12	x	60	S	100	315,00
M 12	x	65	S	50	365,00
M 12	x	70	S	50	395,00
M 12	x	80	S	50	480,00
M 12	x	90	S	50	630,00

Abmessungen	VE Stück	€/100/Obf.			
M 12	x	100	S	50	720,00
M 12	x	120	S	50	840,00
M 12	x	140	S	50	860,00
M 14	x	60	S	50	920,00
M 14	x	80	S	50	960,00
M 14	x	100	S	50	1010,00
M 16	x	55	S	50	560,00
M 16	x	60	S	50	560,00
M 16	x	70	S	25	600,00
M 16	x	80	S	25	780,00
M 16	x	90	S	25	960,00
M 16	x	100	S	25	1020,00
M 16	x	120	S	25	1150,00
M 16	x	130	S	25	1240,00
M 16	x	140	S	25	1340,00
M 16	x	150	S	25	1540,00
M 20	x	65	S	25	600,00
M 20	x	70	S	25	790,00
M 20	x	80	S	25	840,00
M 20	x	90	S	25	880,00
M 20	x	100	S	25	1030,00
M 20	x	110	S	25	1200,00
M 20	x	120	S	25	1240,00
M 20	x	130	S	25	1430,00
M 20	x	140	S	25	1510,00
M 20	x	150	S	25	1900,00
M 20	x	160	S	25	2040,00
M 24	x	80	S	25	1510,00
M 24	x	90	S	10	1580,00
M 24	x	100	S	10	1900,00
M 24	x	110	S	10	2010,00
M 24	x	120	S	10	2100,00
M 24	x	130	S	10	2360,00
M 24	x	140	S	10	2450,00
M 24	x	150	S	10	2550,00
M 24	x	160	S	10	2650,00
M 24	x	180	S	10	2700,00
M 24	x	200	S	10	3000,00
M 24	x	220	S	10	3000,00
M 24	x	240	S	10	3050,00
M 30	x	90	S	5	3150,00
M 30	x	100	S	5	3300,00
M 30	x	110	S	5	3400,00
M 30	x	120	S	5	3600,00
M 30	x	130	S	5	3950,00
M 30	x	140	S	5	4200,00
M 30	x	150	S	5	4400,00
M 30	x	160	S	5	4600,00
M 30	x	180	S	5	4800,00
M 30	x	200	S	5	5600,00



- ✓ Große Artikelvielfalt
- ✓ Verlässliche Qualität
- ✓ Hohe Lieferbereitschaft

Abmessungen VE Stück €/100/Obf.
 DIN 00933.800

933 8.8



Sechskantschrauben mit Gewinde bis Kopf

Maße → TI-15 Anziehmomente → TI-244
 Werkstoffeigensch. → TI-232 Normumstellung → TI-6

Rostfrei → S. 490
 Messing, Kunststoff → S. 625

DIN 933 → wird ersetzt durch ISO 4017



Abmessungen	VE	Stück	€/100/Obf.
M 3 x 5	S	500	11,70
M 3 x 5	K	100	15,40
M 3 x 6	S	500	5,80
M 3 x 6	K	100	9,40
M 3 x 8	S	500	5,80
M 3 x 8	K	100	9,40
M 3 x 10	S	500	5,80
M 3 x 10	K	100	9,40
M 3 x 12	S	500	6,30
M 3 x 12	K	100	10,00
M 3 x 16	S	500	6,30
M 3 x 16	K	100	10,00
M 3 x 18	S	500	7,20
M 3 x 20	S	500	6,60
M 3 x 20	K	100	10,30
M 3 x 22	S	500	8,00
M 3 x 25	S	500	7,40
M 3 x 25	K	100	11,10
M 3 x 30	S	500	20,40
M 3 x 35	S	500	44,00
M 3 x 40	S	500	55,00
M 3 x 50	S	500	84,00
M 3 x 60	S	500	91,00
M 4 x 6	S	500	5,80
M 4 x 6	K	100	9,40
M 4 x 8	S	500	5,80
M 4 x 8	K	100	9,40
M 4 x 10	S	500	5,80
M 4 x 10	K	100	9,40
M 4 x 12	S	500	6,30
M 4 x 12	K	100	10,00
M 4 x 14	S	500	6,90
M 4 x 16	S	500	6,30
M 4 x 16	K	100	10,00
M 4 x 18	S	500	7,20
M 4 x 20	S	500	6,60
M 4 x 20	K	100	10,30
M 4 x 22	S	500	8,00
M 4 x 25	S	500	7,40
M 4 x 25	K	100	11,10
M 4 x 30	S	500	8,60
M 4 x 30	K	100	12,20
M 4 x 35	S	500	9,10
M 4 x 35	K	100	12,80
M 4 x 40	S	500	9,90
M 4 x 40	K	100	13,50
M 4 x 45	S	500	11,70
M 4 x 50	S	500	12,70
M 4 x 50	K	100	16,30
M 4 x 55	S	100	58,00
M 4 x 60	S	100	88,00
M 4 x 65	S	200	125,00

Abmessungen	VE	Stück	€/100/Obf.
M 4 x 70	S	100	125,00
M 5 x 6	S	500	15,30
M 5 x 6	K	100	19,00
M 5 x 8	S	500	4,10
M 5 x 8	K	100	7,70
M 5 x 10	S	500	4,10
M 5 x 10	K	100	7,70
M 5 x 12	S	500	4,20
M 5 x 12	K	100	7,80
M 5 x 14	S	500	4,40
M 5 x 16	S	500	4,20
M 5 x 16	K	100	7,80
M 5 x 18	S	500	4,60
M 5 x 18	K	100	8,20
M 5 x 20	S	500	4,40
M 5 x 20	K	100	8,20
M 5 x 22	S	500	11,50
M 5 x 25	S	500	5,00
M 5 x 25	K	100	8,60
M 5 x 30	S	500	5,80
M 5 x 30	K	100	9,40
M 5 x 35	S	200	6,60
M 5 x 40	S	200	8,90
M 5 x 45	S	200	10,40
M 5 x 50	S	200	11,50
M 5 x 55	S	200	17,10
M 5 x 60	S	200	17,30
M 5 x 65	S	200	56,00
M 5 x 70	S	200	56,00
M 5 x 80	S	200	84,00
M 5 x 90	S	200	135,00
M 5 x 100	S	200	158,00
M 6 x 6	S	500	21,90
M 6 x 6	K	100	25,50
M 6 x 8	S	500	6,10
M 6 x 8	K	100	9,70
M 6 x 10	S	500	5,50
M 6 x 10	K	100	9,20
M 6 x 12	S	500	5,50
M 6 x 12	K	100	9,20
M 6 x 14	S	500	4,85
M 6 x 16	S	500	4,85
M 6 x 16	K	100	8,50
M 6 x 18	S	500	5,10
M 6 x 18	K	100	8,80
M 6 x 20	S	500	5,10
M 6 x 20	K	100	8,80
M 6 x 22	S	500	5,50
M 6 x 22	K	100	9,20
M 6 x 25	S	500	5,50
M 6 x 25	K	100	9,20
M 6 x 28	S	500	12,10
M 6 x 28	K	100	15,70
M 6 x 30	S	500	5,90
M 6 x 30	K	100	9,60
M 6 x 35	S	200	6,60
M 6 x 40	S	200	7,20
M 6 x 45	S	200	10,60
M 6 x 50	S	200	10,80
M 6 x 55	S	200	18,60
M 6 x 60	S	200	21,00
M 6 x 65	S	200	27,50
M 6 x 70	S	200	34,00
M 6 x 75	S	200	40,50
M 6 x 80	S	200	40,50
M 6 x 85	S	200	73,00
M 6 x 90	S	200	72,00
M 6 x 100	S	100	111,00
M 6 x 110	S	100	129,00
M 6 x 120	S	100	137,00
M 6 x 130	S	100	216,00
M 6 x 140	S	100	232,00
M 6 x 150	S	100	280,00
M 7 x 12	S	500	18,90
M 7 x 16	S	500	14,60

Abmessungen	VE	Stück	€/100/Obf.
M 7 x 20	S	500	15,30
M 7 x 25	S	500	17,80
M 7 x 30	S	500	19,20
M 7 x 35	S	200	21,40
M 7 x 40	S	200	23,20
M 7 x 45	S	200	24,90
M 8 x 8	S	200	30,50
M 8 x 10	S	200	10,40
M 8 x 12	S	200	9,20
M 8 x 14	S	200	9,20
M 8 x 16	S	200	7,10
M 8 x 18	S	200	7,60
M 8 x 20	S	200	7,60
M 8 x 22	S	200	8,70
M 8 x 25	S	200	8,70
M 8 x 28	S	200	9,40
M 8 x 30	S	200	9,40
M 8 x 35	S	200	10,40
M 8 x 40	S	200	11,40
M 8 x 45	S	200	14,00
M 8 x 50	S	200	16,20
M 8 x 55	S	200	22,70
M 8 x 60	S	200	24,30
M 8 x 65	S	200	33,50
M 8 x 70	S	200	42,00
M 8 x 75	S	200	51,00
M 8 x 80	S	200	51,00
M 8 x 85	S	200	64,00
M 8 x 90	S	100	60,00
M 8 x 100	S	100	69,00
M 8 x 110	S	100	88,00
M 8 x 120	S	100	92,00
M 8 x 130	S	100	148,00
M 8 x 140	S	100	184,00
M 8 x 150	S	100	226,00
M 8 x 160	S	100	290,00
M 8 x 170	S	100	330,00
M 8 x 180	S	100	355,00
M 8 x 200	S	100	460,00
M 10 x 10	S	200	59,00
M 10 x 12	S	200	21,50
M 10 x 16	S	200	13,70
M 10 x 18	S	200	12,80
M 10 x 20	S	200	12,80
M 10 x 22	S	200	13,70
M 10 x 25	S	200	13,70
M 10 x 28	S	200	16,50
M 10 x 30	S	200	14,60
M 10 x 35	S	100	16,20
M 10 x 40	S	100	17,30
M 10 x 45	S	100	20,70
M 10 x 50	S	100	21,60
M 10 x 55	S	100	30,00
M 10 x 60	S	100	32,50
M 10 x 65	S	100	50,00
M 10 x 70	S	100	50,00
M 10 x 75	S	100	56,00
M 10 x 80	S	100	70,00
M 10 x 85	S	100	84,00
M 10 x 90	S	100	84,00
M 10 x 100	S	100	99,00
M 10 x 110	S	50	136,00
M 10 x 120	S	50	141,00
M 10 x 130	S	50	186,00
M 10 x 140	S	50	193,00
M 10 x 150	S	50	212,00
M 10 x 160	S	50	325,00
M 10 x 170	S	50	650,00
M 10 x 180	S	50	640,00
M 10 x 190	S	50	660,00
M 10 x 200	S	50	690,00
M 10 x 220	S	50	1020,00
M 10 x 240	S	50	1930,00
M 10 x 280	S	50	2170,00
M 10 x 300	S	50	2290,00

Abmessungen	VE	Stück	€/100/Obf.	Abmessungen	VE	Stück	€/100/Obf.	Abmessungen	VE	Stück	€/100/Obf.
M 12 x 10	S	100	211,00	M 16 x 80	S	25	153,00	M 20 x 170	S	1	1140,00
M 12 x 12	S	100	132,00	M 16 x 85	S	25	199,00	M 20 x 180	S	1	1200,00
M 12 x 16	S	100	25,50	M 16 x 90	S	25	199,00	M 20 x 190	S	1	1250,00
M 12 x 18	S	100	25,50	M 16 x 95	S	25	226,00	M 20 x 200	S	1	1300,00
M 12 x 20	S	100	22,50	M 16 x 100	S	25	226,00	M 20 x 210	S	1	1580,00
M 12 x 22	S	100	22,50	M 16 x 110	S	25	300,00	M 20 x 220	S	1	1680,00
M 12 x 25	S	100	22,50	M 16 x 120	S	25	325,00	M 20 x 230	S	1	1770,00
M 12 x 28	S	100	24,10	M 16 x 130	S	25	335,00	M 20 x 240	S	1	1860,00
M 12 x 30	S	100	21,20	M 16 x 140	S	25	355,00	M 20 x 250	S	1	1880,00
M 12 x 35	S	100	23,10	M 16 x 150	S	25	400,00	M 20 x 260	S	1	1980,00
M 12 x 40	S	100	25,50	M 16 x 160	S	25	660,00	M 20 x 280	S	1	2100,00
M 12 x 45	S	100	28,00	M 16 x 170	S	25	750,00	M 20 x 300	S	1	2270,00
M 12 x 50	S	100	30,00	M 16 x 180	S	25	750,00	M 20 x 360	S	1	4850,00
M 12 x 55	S	100	37,50	M 16 x 190	S	25	900,00	M 22 x 30	S	25	610,00
M 12 x 60	S	100	40,50	M 16 x 200	S	25	900,00	M 22 x 35	S	25	610,00
M 12 x 65	S	50	61,00	M 16 x 210	S	25	940,00	M 22 x 40	S	25	530,00
M 12 x 70	S	50	61,00	M 16 x 220	S	1	970,00	M 22 x 45	S	25	395,00
M 12 x 75	S	50	69,00	M 16 x 230	S	1	1010,00	M 22 x 50	S	25	395,00
M 12 x 80	S	50	87,00	M 16 x 240	S	1	1050,00	M 22 x 55	S	25	440,00
M 12 x 85	S	50	104,00	M 16 x 250	S	1	1320,00	M 22 x 60	S	25	440,00
M 12 x 90	S	50	104,00	M 16 x 260	S	1	1420,00	M 22 x 65	S	25	540,00
M 12 x 100	S	50	116,00	M 16 x 280	S	1	1530,00	M 22 x 70	S	25	540,00
M 12 x 110	S	50	180,00	M 16 x 300	S	1	1780,00	M 22 x 75	S	25	590,00
M 12 x 120	S	50	182,00	M 16 x 320	S	1	2010,00	M 22 x 80	S	25	590,00
M 12 x 130	S	50	217,00	M 16 x 340	S	1	2180,00	M 22 x 90	S	25	590,00
M 12 x 140	S	50	226,00	M 16 x 400	S	1	3350,00	M 22 x 100	S	10	730,00
M 12 x 150	S	50	244,00	M 16 x 500	S	1	4300,00	M 22 x 110	S	10	880,00
M 12 x 160	S	25	475,00	M 18 x 20	S	50	285,00	M 22 x 120	S	10	880,00
M 12 x 170	S	25	580,00	M 18 x 25	S	50	285,00	M 22 x 130	S	10	1130,00
M 12 x 180	S	25	580,00	M 18 x 30	S	50	209,00	M 22 x 140	S	10	1200,00
M 12 x 190	S	25	700,00	M 18 x 35	S	50	215,00	M 22 x 150	S	10	1280,00
M 12 x 200	S	25	700,00	M 18 x 40	S	50	215,00	M 22 x 160	S	10	1440,00
M 12 x 220	S	25	820,00	M 18 x 45	S	50	215,00	M 22 x 170	S	1	1510,00
M 12 x 240	S	25	900,00	M 18 x 50	S	50	222,00	M 22 x 180	S	1	1580,00
M 12 x 300	S	25	2850,00	M 18 x 55	S	25	239,00	M 22 x 190	S	1	1650,00
M 14 x 16	S	100	250,00	M 18 x 60	S	25	239,00	M 22 x 200	S	1	1720,00
M 14 x 20	S	100	63,00	M 18 x 65	S	25	255,00	M 24 x 25	S	25	530,00
M 14 x 25	S	100	63,00	M 18 x 70	S	25	255,00	M 24 x 30	S	25	530,00
M 14 x 30	S	100	71,00	M 18 x 75	S	25	300,00	M 24 x 35	S	25	330,00
M 14 x 35	S	100	80,00	M 18 x 80	S	25	300,00	M 24 x 40	S	25	183,00
M 14 x 40	S	100	80,00	M 18 x 85	S	25	385,00	M 24 x 45	S	25	183,00
M 14 x 45	S	100	87,00	M 18 x 90	S	25	385,00	M 24 x 50	S	25	171,00
M 14 x 50	S	100	91,00	M 18 x 100	S	25	385,00	M 24 x 55	S	25	181,00
M 14 x 55	S	100	106,00	M 18 x 110	S	25	500,00	M 24 x 60	S	25	186,00
M 14 x 60	S	50	106,00	M 18 x 120	S	25	500,00	M 24 x 65	S	25	212,00
M 14 x 65	S	50	118,00	M 18 x 130	S	25	870,00	M 24 x 70	S	25	212,00
M 14 x 70	S	50	118,00	M 18 x 140	S	25	940,00	M 24 x 75	S	25	295,00
M 14 x 75	S	50	147,00	M 18 x 150	S	25	1010,00	M 24 x 80	S	25	270,00
M 14 x 80	S	50	147,00	M 18 x 160	S	25	1080,00	M 24 x 85	S	10	415,00
M 14 x 90	S	50	209,00	M 18 x 170	S	25	1140,00	M 24 x 90	S	10	415,00
M 14 x 100	S	50	239,00	M 18 x 180	S	25	1200,00	M 24 x 100	S	10	560,00
M 14 x 110	S	50	435,00	M 18 x 190	S	25	1260,00	M 24 x 110	S	10	650,00
M 14 x 120	S	50	315,00	M 18 x 200	S	25	1310,00	M 24 x 120	S	10	680,00
M 14 x 130	S	50	510,00	M 20 x 20	S	25	241,00	M 24 x 130	S	1	1150,00
M 14 x 140	S	50	550,00	M 20 x 25	S	25	182,00	M 24 x 140	S	1	1220,00
M 14 x 150	S	50	570,00	M 20 x 30	S	25	106,00	M 24 x 150	S	1	1280,00
M 14 x 160	S	25	710,00	M 20 x 35	S	25	106,00	M 24 x 160	S	1	1350,00
M 14 x 170	S	25	760,00	M 20 x 40	S	25	99,00	M 24 x 170	S	1	1510,00
M 14 x 180	S	25	800,00	M 20 x 45	S	25	100,00	M 24 x 180	S	1	1510,00
M 14 x 200	S	25	870,00	M 20 x 50	S	25	101,00	M 24 x 190	S	1	1750,00
M 14 x 220	S	25	3850,00	M 20 x 55	S	25	107,00	M 24 x 200	S	1	1750,00
M 16 x 12	S	50	201,00	M 20 x 60	S	25	108,00	M 24 x 210	S	1	1940,00
M 16 x 16	S	50	205,00	M 20 x 65	S	25	126,00	M 24 x 220	S	1	2010,00
M 16 x 20	S	50	47,50	M 20 x 70	S	25	130,00	M 24 x 230	S	1	2090,00
M 16 x 25	S	50	47,50	M 20 x 75	S	25	166,00	M 24 x 240	S	1	2160,00
M 16 x 30	S	50	45,00	M 20 x 80	S	25	161,00	M 24 x 250	S	1	2240,00
M 16 x 35	S	50	47,50	M 20 x 85	S	25	240,00	M 24 x 260	S	1	2700,00
M 16 x 40	S	50	49,50	M 20 x 90	S	25	240,00	M 24 x 280	S	1	2950,00
M 16 x 45	S	50	53,00	M 20 x 100	S	25	345,00	M 24 x 300	S	1	3100,00
M 16 x 50	S	50	57,00	M 20 x 110	S	25	380,00	M 24 x 320	S	1	3500,00
M 16 x 55	S	50	69,00	M 20 x 120	S	25	420,00	M 24 x 500	S	1	8700,00
M 16 x 60	S	50	72,00	M 20 x 130	S	25	540,00	M 27 x 30	S	10	970,00
M 16 x 65	S	25	102,00	M 20 x 140	S	25	630,00	M 27 x 40	S	10	970,00
M 16 x 70	S	25	102,00	M 20 x 150	S	25	720,00	M 27 x 45	S	10	970,00
M 16 x 75	S	25	121,00	M 20 x 160	S	10	780,00	M 27 x 50	S	10	830,00

Abmessungen	VE	Stück	€/100/Obf.	Abmessungen	VE	Stück	€/100/Obf.	Abmessungen	VE	Stück	€/100/Obf.
M 27 x 55	S	10	830,00	M 33 x 190	S	1	3400,00	M 45 x 140	S	1	9100,00
M 27 x 60	S	10	830,00	M 33 x 200	S	1	3550,00	M 45 x 150	S	1	9400,00
M 27 x 65	S	10	880,00	M 33 x 300	S	1	5100,00	M 48 x 60	S	1	9400,00
M 27 x 70	S	10	880,00	M 36 x 40	S	1	1740,00	M 48 x 70	S	1	9400,00
M 27 x 75	S	10	910,00	M 36 x 45	S	1	1740,00	M 48 x 80	S	1	9400,00
M 27 x 80	S	10	910,00	M 36 x 50	S	1	1740,00	M 48 x 90	S	1	9400,00
M 27 x 85	S	10	960,00	M 36 x 55	S	1	1740,00	M 48 x 100	S	1	9600,00
M 27 x 90	S	1	960,00	M 36 x 60	S	1	1740,00	M 48 x 110	S	1	10000,00
M 27 x 100	S	1	1020,00	M 36 x 65	S	1	1810,00	M 48 x 120	S	1	10300,00
M 27 x 110	S	1	1310,00	M 36 x 70	S	1	1810,00	M 48 x 130	S	1	10600,00
M 27 x 120	S	1	1310,00	M 36 x 75	S	1	1900,00	M 48 x 140	S	1	10700,00
M 27 x 130	S	1	1320,00	M 36 x 80	S	1	1900,00	M 48 x 150	S	1	11000,00
M 27 x 140	S	1	1650,00	M 36 x 85	S	1	2030,00	M 48 x 160	S	1	11200,00
M 27 x 150	S	1	1730,00	M 36 x 90	S	1	2030,00	M 48 x 170	S	1	12000,00
M 27 x 160	S	1	1930,00	M 36 x 100	S	1	2160,00	M 48 x 180	S	1	12900,00
M 27 x 170	S	1	2030,00	M 36 x 110	S	1	2270,00	M 48 x 190	S	1	13600,00
M 27 x 180	S	1	2120,00	M 36 x 120	S	1	2330,00	M 48 x 200	S	1	14600,00
M 27 x 190	S	1	2210,00	M 36 x 130	S	1	2500,00	M 48 x 420	S	1	20400,00
M 27 x 200	S	1	2300,00	M 36 x 140	S	1	2600,00				
M 27 x 300	S	1	4450,00	M 36 x 150	S	1	2750,00				
M 30 x 35	S	1	1090,00	M 36 x 160	S	1	2850,00				
M 30 x 40	S	1	1090,00	M 36 x 170	S	1	3000,00				
M 30 x 45	S	1	1090,00	M 36 x 180	S	1	3150,00				
M 30 x 50	S	1	1090,00	M 36 x 190	S	1	3300,00				
M 30 x 55	S	1	1090,00	M 36 x 200	S	1	3450,00				
M 30 x 60	S	1	1090,00	M 36 x 220	S	1	4400,00				
M 30 x 65	S	1	1170,00	M 36 x 260	S	1	5300,00				
M 30 x 70	S	1	1170,00	M 36 x 280	S	1	5800,00				
M 30 x 75	S	1	1250,00	M 36 x 300	S	1	6200,00				
M 30 x 80	S	1	1250,00	M 36 x 320	S	1	11000,00				
M 30 x 85	S	1	1310,00	M 36 x 340	S	1	11400,00				
M 30 x 90	S	1	1310,00	M 36 x 400	S	1	12300,00				
M 30 x 100	S	1	1360,00	M 36 x 600	S	1	15400,00				
M 30 x 110	S	1	1440,00	M 39 x 80	S	1	4050,00				
M 30 x 120	S	1	1520,00	M 39 x 90	S	1	4250,00				
M 30 x 130	S	1	1650,00	M 39 x 100	S	1	4550,00				
M 30 x 140	S	1	1710,00	M 39 x 110	S	1	4800,00				
M 30 x 150	S	1	1770,00	M 39 x 120	S	1	5300,00				
M 30 x 160	S	1	1980,00	M 39 x 130	S	1	5400,00				
M 30 x 170	S	1	2090,00	M 39 x 140	S	1	5800,00				
M 30 x 180	S	1	2160,00	M 39 x 150	S	1	6200,00				
M 30 x 190	S	1	2240,00	M 39 x 160	S	1	6800,00				
M 30 x 200	S	1	2310,00	M 39 x 180	S	1	7900,00				
M 30 x 210	S	1	2650,00	M 39 x 190	S	1	8800,00				
M 30 x 220	S	1	2700,00	M 39 x 200	S	1	8800,00				
M 30 x 230	S	1	2800,00	M 42 x 50	S	1	4100,00				
M 30 x 240	S	1	2850,00	M 42 x 55	S	1	4100,00				
M 30 x 250	S	1	3350,00	M 42 x 60	S	1	4100,00				
M 30 x 260	S	1	3450,00	M 42 x 70	S	1	4100,00				
M 30 x 280	S	1	3750,00	M 42 x 75	S	1	4200,00				
M 30 x 300	S	1	4100,00	M 42 x 80	S	1	4200,00				
M 30 x 320	S	1	4600,00	M 42 x 85	S	1	4400,00				
M 30 x 340	S	1	4950,00	M 42 x 90	S	1	4400,00				
M 30 x 360	S	1	5400,00	M 42 x 100	S	1	4600,00				
M 30 x 380	S	1	5800,00	M 42 x 110	S	1	5100,00				
M 30 x 400	S	1	6400,00	M 42 x 120	S	1	5400,00				
M 30 x 500	S	1	10100,00	M 42 x 130	S	1	5600,00				
M 30 x 600	S	1	11300,00	M 42 x 140	S	1	5800,00				
M 33 x 40	S	1	1440,00	M 42 x 150	S	1	6200,00				
M 33 x 50	S	1	1440,00	M 42 x 160	S	1	6300,00				
M 33 x 60	S	1	1440,00	M 42 x 170	S	1	7200,00				
M 33 x 65	S	1	1580,00	M 42 x 180	S	1	7500,00				
M 33 x 70	S	1	1580,00	M 42 x 190	S	1	7800,00				
M 33 x 75	S	1	1620,00	M 42 x 200	S	1	8300,00				
M 33 x 80	S	1	1620,00	M 42 x 220	S	1	9900,00				
M 33 x 90	S	1	1710,00	M 42 x 250	S	1	11500,00				
M 33 x 100	S	1	1800,00	M 42 x 260	S	1	12300,00				
M 33 x 110	S	1	1970,00	M 42 x 300	S	1	14000,00				
M 33 x 120	S	1	1970,00	M 42 x 360	S	1	16000,00				
M 33 x 130	S	1	2350,00	M 42 x 400	S	1	16700,00				
M 33 x 140	S	1	2550,00	M 45 x 90	S	1	7700,00				
M 33 x 150	S	1	2700,00	M 45 x 100	S	1	7900,00				
M 33 x 160	S	1	3000,00	M 45 x 110	S	1	8300,00				
M 33 x 170	S	1	3150,00	M 45 x 120	S	1	8200,00				
M 33 x 180	S	1	3250,00	M 45 x 130	S	1	8800,00				

DIN	00933.810
933	8.8 galvanisch verzinkt

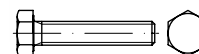

Sechskantschrauben mit Gewinde bis Kopf

Maße → TI-15 Anziehmomente → TI-244
 Werkstoffeigensch. → TI-232 Normumstellung → TI-6
 Korrosionsschutz → TI-228
 Rostfrei → S. 490
 Messing, Kunststoff → S. 625

DIN 933 → wird ersetzt durch ISO 4017

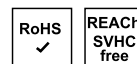

M 3 x 5	S	500	12,10 gal Zn
M 3 x 6	S	500	6,00 gal Zn
M 3 x 8	S	500	6,00 gal Zn
M 3 x 8	K	100	9,70 gal Zn
M 3 x 10	S	500	6,10 gal Zn
M 3 x 10	K	100	9,70 gal Zn
M 3 x 12	S	500	6,60 gal Zn
M 3 x 12	K	100	10,30 gal Zn
M 3 x 16	S	500	6,70 gal Zn
M 3 x 16	K	100	10,30 gal Zn
M 3 x 20	S	500	6,90 gal Zn
M 3 x 20	K	100	10,60 gal Zn
M 3 x 25	S	500	7,90 gal Zn
M 3 x 30	S	500	21,00 gal Zn
M 3 x 35	S	500	48,50 gal Zn
M 3 x 40	S	500	56,00 gal Zn
M 3 x 50	S	500	86,00 gal Zn
M 4 x 5	S	500	5,90 gal Zn
M 4 x 6	S	500	6,20 gal Zn
M 4 x 8	S	500	6,30 gal Zn
M 4 x 8	K	100	9,90 gal Zn
M 4 x 10	S	500	6,30 gal Zn
M 4 x 10	K	100	9,90 gal Zn
M 4 x 12	S	500	6,90 gal Zn
M 4 x 12	K	100	10,60 gal Zn
M 4 x 14	S	500	7,40 gal Zn
M 4 x 16	S	500	6,90 gal Zn
M 4 x 16	K	100	10,60 gal Zn
M 4 x 18	S	500	7,90 gal Zn
M 4 x 20	S	500	7,40 gal Zn
M 4 x 20	K	100	11,00 gal Zn
M 4 x 22	S	500	8,80 gal Zn

Abmessungen	VE	Stück	€/100/Obf.	Abmessungen	VE	Stück	€/100/Obf.	Abmessungen	VE	Stück	€/100/Obf.
M 4 x 25	S	500	8,30 gal Zn	M 6 x 85	S	200	78,00 gal Zn	M 10 x 130	S	50	210,00 gal Zn
M 4 x 25	K	100	11,90 gal Zn	M 6 x 90	S	200	78,00 gal Zn	M 10 x 140	S	50	216,00 gal Zn
M 4 x 30	S	500	9,50 gal Zn	M 6 x 100	S	200	118,00 gal Zn	M 10 x 150	S	50	239,00 gal Zn
M 4 x 30	K	100	13,10 gal Zn	M 6 x 110	S	100	137,00 gal Zn	M 10 x 160	S	50	360,00 gal Zn
M 4 x 35	S	500	10,60 gal Zn	M 6 x 120	S	100	147,00 gal Zn	M 10 x 170	S	50	680,00 gal Zn
M 4 x 35	K	100	14,20 gal Zn	M 6 x 130	S	100	226,00 gal Zn	M 10 x 180	S	50	670,00 gal Zn
M 4 x 40	S	500	11,50 gal Zn	M 6 x 140	S	100	241,00 gal Zn	M 10 x 190	S	50	700,00 gal Zn
M 4 x 40	K	100	15,10 gal Zn	M 6 x 150	S	100	290,00 gal Zn	M 10 x 200	S	50	730,00 gal Zn
M 4 x 45	S	500	13,50 gal Zn	M 7 x 12	S	500	22,30 gal Zn	M 10 x 220	S	50	1070,00 gal Zn
M 4 x 50	S	500	14,60 gal Zn	M 7 x 16	S	500	16,90 gal Zn	M 12 x 12	S	100	142,00 gal Zn
M 4 x 55	S	100	65,00 gal Zn	M 7 x 20	S	500	18,00 gal Zn	M 12 x 16	S	100	31,50 gal Zn
M 4 x 60	S	100	91,00 gal Zn	M 7 x 25	S	500	20,90 gal Zn	M 12 x 18	S	100	32,00 gal Zn
M 4 x 70	S	100	129,00 gal Zn	M 7 x 30	S	500	22,60 gal Zn	M 12 x 20	S	100	29,50 gal Zn
M 5 x 6	S	500	16,00 gal Zn	M 7 x 40	S	500	27,50 gal Zn	M 12 x 22	S	100	30,00 gal Zn
M 5 x 8	S	500	4,60 gal Zn	M 7 x 45	S	200	30,00 gal Zn	M 12 x 25	S	100	30,50 gal Zn
M 5 x 8	K	100	8,30 gal Zn	M 8 x 8	S	200	33,00 gal Zn	M 12 x 28	S	100	38,00 gal Zn
M 5 x 10	S	500	4,70 gal Zn	M 8 x 10	S	200	12,50 gal Zn	M 12 x 30	S	100	30,00 gal Zn
M 5 x 10	K	100	8,30 gal Zn	M 8 x 12	S	200	11,50 gal Zn	M 12 x 35	S	100	32,50 gal Zn
M 5 x 12	S	500	4,85 gal Zn	M 8 x 14	S	200	11,70 gal Zn	M 12 x 40	S	100	35,50 gal Zn
M 5 x 12	K	100	8,50 gal Zn	M 8 x 16	S	200	9,70 gal Zn	M 12 x 45	S	100	39,00 gal Zn
M 5 x 14	S	500	5,20 gal Zn	M 8 x 18	S	200	10,20 gal Zn	M 12 x 50	S	100	42,00 gal Zn
M 5 x 16	S	500	5,00 gal Zn	M 8 x 20	S	200	10,30 gal Zn	M 12 x 55	S	100	51,00 gal Zn
M 5 x 16	K	100	8,60 gal Zn	M 8 x 22	S	200	11,70 gal Zn	M 12 x 60	S	100	54,00 gal Zn
M 5 x 18	S	500	5,40 gal Zn	M 8 x 25	S	200	11,80 gal Zn	M 12 x 65	S	50	80,00 gal Zn
M 5 x 20	S	500	5,40 gal Zn	M 8 x 28	S	200	17,20 gal Zn	M 12 x 70	S	50	81,00 gal Zn
M 5 x 20	K	100	8,90 gal Zn	M 8 x 30	S	200	12,90 gal Zn	M 12 x 75	S	50	91,00 gal Zn
M 5 x 22	S	500	12,60 gal Zn	M 8 x 35	S	200	14,30 gal Zn	M 12 x 80	S	50	109,00 gal Zn
M 5 x 25	S	500	6,10 gal Zn	M 8 x 40	S	200	15,70 gal Zn	M 12 x 85	S	50	129,00 gal Zn
M 5 x 25	K	100	9,70 gal Zn	M 8 x 45	S	200	18,60 gal Zn	M 12 x 90	S	50	129,00 gal Zn
M 5 x 30	S	500	6,90 gal Zn	M 8 x 50	S	200	21,20 gal Zn	M 12 x 95	S	50	199,00 gal Zn
M 5 x 30	K	100	10,60 gal Zn	M 8 x 55	S	200	30,00 gal Zn	M 12 x 100	S	50	144,00 gal Zn
M 5 x 35	S	200	7,90 gal Zn	M 8 x 60	S	200	32,00 gal Zn	M 12 x 110	S	50	209,00 gal Zn
M 5 x 40	S	200	10,40 gal Zn	M 8 x 65	S	200	41,50 gal Zn	M 12 x 120	S	50	213,00 gal Zn
M 5 x 45	S	200	12,00 gal Zn	M 8 x 70	S	200	51,00 gal Zn	M 12 x 130	S	50	255,00 gal Zn
M 5 x 50	S	200	13,20 gal Zn	M 8 x 75	S	200	60,00 gal Zn	M 12 x 140	S	50	265,00 gal Zn
M 5 x 55	S	200	19,60 gal Zn	M 8 x 80	S	200	60,00 gal Zn	M 12 x 150	S	50	285,00 gal Zn
M 5 x 60	S	200	20,00 gal Zn	M 8 x 85	S	200	74,00 gal Zn	M 12 x 160	S	25	520,00 gal Zn
M 5 x 65	S	200	59,00 gal Zn	M 8 x 90	S	100	70,00 gal Zn	M 12 x 170	S	25	620,00 gal Zn
M 5 x 70	S	200	59,00 gal Zn	M 8 x 95	S	100	80,00 gal Zn	M 12 x 180	S	25	620,00 gal Zn
M 5 x 75	S	200	160,00 gal Zn	M 8 x 100	S	100	80,00 gal Zn	M 12 x 190	S	25	750,00 gal Zn
M 5 x 80	S	200	88,00 gal Zn	M 8 x 110	S	100	101,00 gal Zn	M 12 x 200	S	25	750,00 gal Zn
M 5 x 90	S	200	141,00 gal Zn	M 8 x 120	S	100	105,00 gal Zn	M 12 x 220	S	25	880,00 gal Zn
M 5 x 100	S	200	164,00 gal Zn	M 8 x 130	S	100	164,00 gal Zn	M 12 x 240	S	25	950,00 gal Zn
M 6 x 6	S	500	23,00 gal Zn	M 8 x 140	S	100	201,00 gal Zn	M 12 x 260	S	25	2650,00 gal Zn
M 6 x 6	K	100	27,00 gal Zn	M 8 x 150	S	100	242,00 gal Zn	M 14 x 20	S	100	78,00 gal Zn
M 6 x 8	S	500	6,90 gal Zn	M 8 x 160	S	100	305,00 gal Zn	M 14 x 25	S	100	80,00 gal Zn
M 6 x 8	K	100	10,60 gal Zn	M 8 x 170	S	100	350,00 gal Zn	M 14 x 30	S	100	89,00 gal Zn
M 6 x 10	S	500	6,50 gal Zn	M 8 x 180	S	100	375,00 gal Zn	M 14 x 35	S	100	99,00 gal Zn
M 6 x 10	K	100	10,20 gal Zn	M 8 x 190	S	100	540,00 gal Zn	M 14 x 40	S	100	100,00 gal Zn
M 6 x 12	S	500	6,60 gal Zn	M 8 x 200	S	100	490,00 gal Zn	M 14 x 45	S	50	110,00 gal Zn
M 6 x 12	K	100	10,20 gal Zn	M 10 x 10	S	200	65,00 gal Zn	M 14 x 50	S	50	115,00 gal Zn
M 6 x 14	S	500	5,90 gal Zn	M 10 x 12	S	200	25,50 gal Zn	M 14 x 55	S	50	131,00 gal Zn
M 6 x 16	S	500	6,10 gal Zn	M 10 x 16	S	200	18,10 gal Zn	M 14 x 60	S	50	132,00 gal Zn
M 6 x 16	K	100	9,70 gal Zn	M 10 x 18	S	200	17,40 gal Zn	M 14 x 65	S	50	146,00 gal Zn
M 6 x 18	S	500	6,30 gal Zn	M 10 x 20	S	200	17,70 gal Zn	M 14 x 70	S	50	147,00 gal Zn
M 6 x 18	K	100	10,00 gal Zn	M 10 x 22	S	200	18,70 gal Zn	M 14 x 75	S	50	177,00 gal Zn
M 6 x 20	S	500	6,40 gal Zn	M 10 x 25	S	200	19,10 gal Zn	M 14 x 80	S	50	180,00 gal Zn
M 6 x 20	K	100	10,10 gal Zn	M 10 x 28	S	200	22,20 gal Zn	M 14 x 90	S	50	242,00 gal Zn
M 6 x 22	S	500	6,90 gal Zn	M 10 x 30	S	200	20,60 gal Zn	M 14 x 100	S	50	280,00 gal Zn
M 6 x 22	K	100	10,60 gal Zn	M 10 x 35	S	100	22,70 gal Zn	M 14 x 110	S	50	475,00 gal Zn
M 6 x 25	S	500	7,10 gal Zn	M 10 x 40	S	100	24,40 gal Zn	M 14 x 120	S	50	355,00 gal Zn
M 6 x 25	K	100	10,70 gal Zn	M 10 x 45	S	100	28,50 gal Zn	M 14 x 130	S	50	570,00 gal Zn
M 6 x 28	S	500	14,30 gal Zn	M 10 x 50	S	100	30,00 gal Zn	M 14 x 140	S	50	590,00 gal Zn
M 6 x 30	S	500	7,70 gal Zn	M 10 x 55	S	100	39,00 gal Zn	M 14 x 200	S	25	940,00 gal Zn
M 6 x 30	K	100	11,20 gal Zn	M 10 x 60	S	100	42,00 gal Zn	M 16 x 16	S	50	220,00 gal Zn
M 6 x 35	S	200	8,50 gal Zn	M 10 x 65	S	100	63,00 gal Zn	M 16 x 20	S	50	62,00 gal Zn
M 6 x 40	S	200	9,40 gal Zn	M 10 x 70	S	100	64,00 gal Zn	M 16 x 25	S	50	64,00 gal Zn
M 6 x 45	S	200	12,90 gal Zn	M 10 x 75	S	100	71,00 gal Zn	M 16 x 30	S	50	63,00 gal Zn
M 6 x 50	S	200	13,20 gal Zn	M 10 x 80	S	100	86,00 gal Zn	M 16 x 35	S	50	67,00 gal Zn
M 6 x 55	S	200	22,20 gal Zn	M 10 x 85	S	100	100,00 gal Zn	M 16 x 40	S	50	70,00 gal Zn
M 6 x 60	S	200	24,90 gal Zn	M 10 x 90	S	100	101,00 gal Zn	M 16 x 45	S	50	75,00 gal Zn
M 6 x 65	S	200	31,50 gal Zn	M 10 x 95	S	100	176,00 gal Zn	M 16 x 50	S	50	80,00 gal Zn
M 6 x 70	S	200	38,50 gal Zn	M 10 x 100	S	100	118,00 gal Zn	M 16 x 55	S	50	94,00 gal Zn
M 6 x 75	S	200	45,00 gal Zn	M 10 x 110	S	50	157,00 gal Zn	M 16 x 60	S	50	99,00 gal Zn
M 6 x 80	S	200	45,50 gal Zn	M 10 x 120	S	50	161,00 gal Zn	M 16 x 65	S	25	141,00 gal Zn

Abmessungen	VE	Stück	€/100/Obf.	Abmessungen	VE	Stück	€/100/Obf.	Abmessungen	VE	Stück	€/100/Obf.
M 16 x 70	S	25	143,00 gal Zn	M 20 x 300	S	1	2600,00 gal Zn	M 30 x 60	S	1	1260,00 gal Zn
M 16 x 75	S	50	164,00 gal Zn	M 20 x 320	S	1	4100,00 gal Zn	M 30 x 65	S	1	1340,00 gal Zn
M 16 x 80	S	25	195,00 gal Zn	M 20 x 340	S	1	4300,00 gal Zn	M 30 x 70	S	1	1350,00 gal Zn
M 16 x 85	S	25	244,00 gal Zn	M 20 x 360	S	1	5200,00 gal Zn	M 30 x 75	S	1	1440,00 gal Zn
M 16 x 90	S	25	245,00 gal Zn	M 20 x 460	S	1	7900,00 gal Zn	M 30 x 80	S	1	1440,00 gal Zn
M 16 x 95	S	25	280,00 gal Zn	M 22 x 40	S	25	620,00 gal Zn	M 30 x 85	S	1	1520,00 gal Zn
M 16 x 100	S	25	280,00 gal Zn	M 22 x 50	S	25	460,00 gal Zn	M 30 x 90	S	1	1520,00 gal Zn
M 16 x 110	S	25	355,00 gal Zn	M 22 x 55	S	25	510,00 gal Zn	M 30 x 100	S	1	1580,00 gal Zn
M 16 x 120	S	25	380,00 gal Zn	M 22 x 60	S	25	520,00 gal Zn	M 30 x 110	S	1	1670,00 gal Zn
M 16 x 130	S	25	400,00 gal Zn	M 22 x 65	S	25	620,00 gal Zn	M 30 x 120	S	1	1770,00 gal Zn
M 16 x 140	S	25	420,00 gal Zn	M 22 x 70	S	25	620,00 gal Zn	M 30 x 130	S	1	1910,00 gal Zn
M 16 x 150	S	25	470,00 gal Zn	M 22 x 75	S	25	670,00 gal Zn	M 30 x 140	S	1	1990,00 gal Zn
M 16 x 160	S	25	740,00 gal Zn	M 22 x 80	S	25	680,00 gal Zn	M 30 x 150	S	1	2070,00 gal Zn
M 16 x 170	S	25	820,00 gal Zn	M 22 x 90	S	25	680,00 gal Zn	M 30 x 160	S	1	2280,00 gal Zn
M 16 x 180	S	25	830,00 gal Zn	M 22 x 100	S	10	840,00 gal Zn	M 30 x 170	S	1	2350,00 gal Zn
M 16 x 190	S	25	980,00 gal Zn	M 22 x 110	S	10	990,00 gal Zn	M 30 x 180	S	1	2500,00 gal Zn
M 16 x 200	S	25	990,00 gal Zn	M 22 x 120	S	10	1000,00 gal Zn	M 30 x 190	S	1	2700,00 gal Zn
M 16 x 210	S	25	1050,00 gal Zn	M 24 x 25	S	25	600,00 gal Zn	M 30 x 200	S	1	2700,00 gal Zn
M 16 x 220	S	1	1070,00 gal Zn	M 24 x 30	S	25	610,00 gal Zn	M 30 x 210	S	1	2900,00 gal Zn
M 16 x 230	S	1	1110,00 gal Zn	M 24 x 35	S	25	400,00 gal Zn	M 30 x 220	S	1	3100,00 gal Zn
M 16 x 240	S	1	1150,00 gal Zn	M 24 x 40	S	25	239,00 gal Zn	M 30 x 240	S	1	3300,00 gal Zn
M 16 x 250	S	1	1430,00 gal Zn	M 24 x 45	S	25	242,00 gal Zn	M 30 x 260	S	1	4200,00 gal Zn
M 16 x 260	S	1	1550,00 gal Zn	M 24 x 50	S	25	233,00 gal Zn	M 30 x 280	S	1	4550,00 gal Zn
M 16 x 280	S	1	1680,00 gal Zn	M 24 x 55	S	25	245,00 gal Zn	M 30 x 300	S	1	4950,00 gal Zn
M 16 x 300	S	1	1940,00 gal Zn	M 24 x 60	S	25	260,00 gal Zn	M 30 x 320	S	1	5300,00 gal Zn
M 16 x 320	S	1	2170,00 gal Zn	M 24 x 65	S	25	285,00 gal Zn	M 33 x 60	S	1	1650,00 gal Zn
M 16 x 340	S	1	2360,00 gal Zn	M 24 x 70	S	25	290,00 gal Zn	M 33 x 70	S	1	1810,00 gal Zn
M 18 x 20	S	50	315,00 gal Zn	M 24 x 75	S	25	375,00 gal Zn	M 33 x 75	S	1	1910,00 gal Zn
M 18 x 25	S	50	315,00 gal Zn	M 24 x 80	S	25	355,00 gal Zn	M 33 x 80	S	1	1870,00 gal Zn
M 18 x 30	S	50	240,00 gal Zn	M 24 x 85	S	25	530,00 gal Zn	M 33 x 90	S	1	1970,00 gal Zn
M 18 x 35	S	50	249,00 gal Zn	M 24 x 90	S	10	530,00 gal Zn	M 33 x 100	S	1	2080,00 gal Zn
M 18 x 40	S	50	255,00 gal Zn	M 24 x 95	S	10	890,00 gal Zn	M 33 x 110	S	1	2260,00 gal Zn
M 18 x 45	S	50	255,00 gal Zn	M 24 x 100	S	10	690,00 gal Zn	M 33 x 120	S	1	2280,00 gal Zn
M 18 x 50	S	50	265,00 gal Zn	M 24 x 110	S	10	790,00 gal Zn	M 33 x 130	S	1	2700,00 gal Zn
M 18 x 55	S	25	285,00 gal Zn	M 24 x 120	S	10	820,00 gal Zn	M 33 x 140	S	1	2900,00 gal Zn
M 18 x 60	S	25	285,00 gal Zn	M 24 x 130	S	1	1300,00 gal Zn	M 33 x 150	S	1	3050,00 gal Zn
M 18 x 65	S	25	305,00 gal Zn	M 24 x 140	S	1	1390,00 gal Zn	M 33 x 160	S	1	3400,00 gal Zn
M 18 x 70	S	25	305,00 gal Zn	M 24 x 150	S	1	1460,00 gal Zn	M 33 x 170	S	1	3550,00 gal Zn
M 18 x 75	S	25	350,00 gal Zn	M 24 x 160	S	1	1540,00 gal Zn	M 33 x 180	S	1	3700,00 gal Zn
M 18 x 80	S	25	355,00 gal Zn	M 24 x 170	S	1	1740,00 gal Zn	M 33 x 190	S	1	3850,00 gal Zn
M 18 x 90	S	25	445,00 gal Zn	M 24 x 180	S	1	1700,00 gal Zn	M 33 x 200	S	1	4000,00 gal Zn
M 18 x 100	S	25	450,00 gal Zn	M 24 x 190	S	1	2000,00 gal Zn	M 36 x 50	S	1	1980,00 gal Zn
M 20 x 20	S	25	305,00 gal Zn	M 24 x 200	S	1	1970,00 gal Zn	M 36 x 55	S	1	1990,00 gal Zn
M 20 x 25	S	25	220,00 gal Zn	M 24 x 210	S	1	2160,00 gal Zn	M 36 x 60	S	1	2000,00 gal Zn
M 20 x 30	S	25	137,00 gal Zn	M 24 x 220	S	1	1970,00 gal Zn	M 36 x 70	S	1	2080,00 gal Zn
M 20 x 35	S	25	141,00 gal Zn	M 24 x 240	S	1	2470,00 gal Zn	M 36 x 75	S	1	2190,00 gal Zn
M 20 x 40	S	25	135,00 gal Zn	M 24 x 250	S	1	2550,00 gal Zn	M 36 x 80	S	1	2200,00 gal Zn
M 20 x 45	S	25	138,00 gal Zn	M 24 x 260	S	1	3050,00 gal Zn	M 36 x 85	S	1	2340,00 gal Zn
M 20 x 50	S	25	143,00 gal Zn	M 24 x 280	S	1	3300,00 gal Zn	M 36 x 90	S	1	2350,00 gal Zn
M 20 x 55	S	25	151,00 gal Zn	M 24 x 300	S	1	3450,00 gal Zn	M 36 x 100	S	1	2500,00 gal Zn
M 20 x 60	S	25	154,00 gal Zn	M 24 x 320	S	1	3900,00 gal Zn	M 36 x 110	S	1	2650,00 gal Zn
M 20 x 65	S	25	174,00 gal Zn	M 27 x 40	S	10	1200,00 gal Zn	M 36 x 120	S	1	2750,00 gal Zn
M 20 x 70	S	25	181,00 gal Zn	M 27 x 45	S	10	1460,00 gal Zn	M 36 x 130	S	1	2900,00 gal Zn
M 20 x 75	S	25	217,00 gal Zn	M 27 x 50	S	10	1330,00 gal Zn	M 36 x 140	S	1	3000,00 gal Zn
M 20 x 80	S	25	215,00 gal Zn	M 27 x 55	S	10	1340,00 gal Zn	M 36 x 150	S	1	3200,00 gal Zn
M 20 x 85	S	25	315,00 gal Zn	M 27 x 60	S	10	960,00 gal Zn	M 36 x 160	S	1	3300,00 gal Zn
M 20 x 90	S	25	320,00 gal Zn	M 27 x 65	S	10	950,00 gal Zn	M 36 x 170	S	1	3500,00 gal Zn
M 20 x 100	S	25	430,00 gal Zn	M 27 x 70	S	10	1020,00 gal Zn	M 36 x 180	S	1	3650,00 gal Zn
M 20 x 110	S	25	470,00 gal Zn	M 27 x 75	S	10	1120,00 gal Zn	M 36 x 190	S	1	3800,00 gal Zn
M 20 x 120	S	25	520,00 gal Zn	M 27 x 80	S	10	1060,00 gal Zn	M 36 x 200	S	1	4000,00 gal Zn
M 20 x 130	S	25	650,00 gal Zn	M 27 x 90	S	1	1120,00 gal Zn	M 36 x 220	S	1	5000,00 gal Zn
M 20 x 140	S	25	740,00 gal Zn	M 27 x 100	S	1	1190,00 gal Zn	M 36 x 280	S	1	5200,00 gal Zn
M 20 x 150	S	25	830,00 gal Zn	M 27 x 110	S	1	1490,00 gal Zn	M 39 x 80	S	1	4500,00 gal Zn
M 20 x 160	S	10	900,00 gal Zn	M 27 x 120	S	1	1500,00 gal Zn	M 39 x 90	S	1	4500,00 gal Zn
M 20 x 170	S	10	1290,00 gal Zn	M 27 x 130	S	1	1530,00 gal Zn	M 39 x 100	S	1	5100,00 gal Zn
M 20 x 180	S	1	1480,00 gal Zn	M 27 x 140	S	1	1860,00 gal Zn	M 39 x 110	S	1	5300,00 gal Zn
M 20 x 190	S	1	1540,00 gal Zn	M 27 x 150	S	1	1960,00 gal Zn	M 39 x 120	S	1	5900,00 gal Zn
M 20 x 200	S	1	1610,00 gal Zn	M 27 x 160	S	1	2170,00 gal Zn	M 39 x 130	S	1	6000,00 gal Zn
M 20 x 210	S	1	1780,00 gal Zn	M 27 x 180	S	1	2390,00 gal Zn	M 39 x 140	S	1	6400,00 gal Zn
M 20 x 220	S	1	1960,00 gal Zn	M 27 x 200	S	1	2600,00 gal Zn	M 39 x 150	S	1	6900,00 gal Zn
M 20 x 230	S	1	1970,00 gal Zn	M 30 x 35	S	1	1250,00 gal Zn	M 39 x 160	S	1	7500,00 gal Zn
M 20 x 240	S	1	2170,00 gal Zn	M 30 x 40	S	1	1230,00 gal Zn	M 39 x 180	S	1	8600,00 gal Zn
M 20 x 250	S	1	2190,00 gal Zn	M 30 x 45	S	1	1230,00 gal Zn	M 39 x 200	S	1	9600,00 gal Zn
M 20 x 260	S	1	2260,00 gal Zn	M 30 x 50	S	1	1240,00 gal Zn	M 42 x 50	S	1	4550,00 gal Zn
M 20 x 280	S	1	2390,00 gal Zn	M 30 x 55	S	1	1250,00 gal Zn	M 42 x 60	S	1	4550,00 gal Zn

Abmessungen	VE	Stück	€/100/Obf.
M 4,2 x 70	S	1	4600,00 gal Zn
M 4,2 x 75	S	1	4750,00 gal Zn
M 4,2 x 80	S	1	4750,00 gal Zn
M 4,2 x 90	S	1	4950,00 gal Zn
M 4,2 x 100	S	1	5200,00 gal Zn
M 4,2 x 110	S	1	5700,00 gal Zn
M 4,2 x 120	S	1	6000,00 gal Zn
M 4,2 x 130	S	1	6300,00 gal Zn
M 4,2 x 140	S	1	6600,00 gal Zn
M 4,2 x 150	S	1	7000,00 gal Zn
M 4,2 x 160	S	1	7100,00 gal Zn
M 4,2 x 170	S	1	8100,00 gal Zn
M 4,2 x 180	S	1	8400,00 gal Zn
M 4,2 x 190	S	1	8700,00 gal Zn
M 4,2 x 200	S	1	9200,00 gal Zn
M 4,2 x 220	S	1	10900,00 gal Zn
M 4,8 x 60	S	1	10100,00 gal Zn
M 4,8 x 70	S	1	10100,00 gal Zn
M 4,8 x 80	S	1	10200,00 gal Zn
M 4,8 x 90	S	1	10200,00 gal Zn
M 4,8 x 100	S	1	10500,00 gal Zn
M 4,8 x 110	S	1	10800,00 gal Zn
M 4,8 x 120	S	1	11200,00 gal Zn
M 4,8 x 130	S	1	11500,00 gal Zn
M 4,8 x 140	S	1	11800,00 gal Zn
M 4,8 x 150	S	1	12000,00 gal Zn
M 4,8 x 200	S	1	19500,00 gal Zn

DIN	00933.349
933	8.8 galv. verz. 8 DiSP*

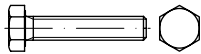

Sechskantschrauben mit Gewinde bis Kopf

* < M 6 Mindestschichtdicke 5µm, Korrosionsbeständigkeit NSS: 72h WR, 120h RR

Maße → **TI-15** Anziehmomente → **TI-244**
 Werkstoffeigensch. → **TI-232** Normumstellung → **TI-6**
 Korrosionsschutz → **TI-228**

Rostfrei → **S. 490**
 Messing, Kunststoff → **S. 625**

DIN 933 → wird ersetzt durch ISO 4017



M 3 x 8	S	500	7,50 gal ZnDi
M 3 x 10	S	500	7,60 gal ZnDi
M 3 x 12	S	500	8,30 gal ZnDi
M 3 x 16	S	500	8,30 gal ZnDi
M 3 x 20	S	500	8,70 gal ZnDi
M 3 x 25	S	500	9,90 gal ZnDi
M 4 x 6	S	500	7,80 gal ZnDi
M 4 x 10	S	500	7,90 gal ZnDi
M 4 x 12	S	500	8,60 gal ZnDi
M 4 x 16	S	500	8,70 gal ZnDi
M 4 x 20	S	500	9,20 gal ZnDi
M 4 x 25	S	500	10,30 gal ZnDi
M 4 x 30	S	500	12,00 gal ZnDi
M 4 x 35	S	500	13,20 gal ZnDi
M 4 x 40	S	500	14,40 gal ZnDi
M 5 x 8	S	500	5,80 gal ZnDi
M 5 x 10	S	500	5,90 gal ZnDi
M 5 x 12	S	500	6,10 gal ZnDi
M 5 x 16	S	500	6,30 gal ZnDi
M 5 x 20	S	500	6,70 gal ZnDi
M 5 x 25	S	500	7,60 gal ZnDi

Abmessungen	VE	Stück	€/100/Obf.
M 5 x 30	S	500	8,70 gal ZnDi
M 5 x 35	S	200	9,90 gal ZnDi
M 5 x 40	S	200	13,00 gal ZnDi
M 5 x 50	S	200	16,90 gal ZnDi
M 6 x 8	S	500	8,60 gal ZnDi
M 6 x 10	S	500	8,10 gal ZnDi
M 6 x 12	S	500	8,20 gal ZnDi
M 6 x 16	S	500	7,60 gal ZnDi
M 6 x 18	S	500	7,90 gal ZnDi
M 6 x 20	S	500	8,00 gal ZnDi
M 6 x 25	S	500	8,80 gal ZnDi
M 6 x 30	S	100	9,60 gal ZnDi
M 6 x 35	S	200	10,60 gal ZnDi
M 6 x 40	S	200	11,70 gal ZnDi
M 6 x 45	S	200	16,10 gal ZnDi
M 6 x 50	S	200	16,60 gal ZnDi
M 6 x 55	S	200	28,00 gal ZnDi
M 6 x 60	S	200	31,50 gal ZnDi
M 6 x 65	S	200	39,50 gal ZnDi
M 6 x 70	S	200	48,00 gal ZnDi
M 6 x 75	S	200	56,00 gal ZnDi
M 6 x 80	S	200	57,00 gal ZnDi
M 8 x 10	S	200	15,70 gal ZnDi
M 8 x 12	S	200	14,40 gal ZnDi
M 8 x 16	S	200	12,10 gal ZnDi
M 8 x 18	S	200	12,80 gal ZnDi
M 8 x 20	S	200	12,90 gal ZnDi
M 8 x 22	S	200	14,60 gal ZnDi
M 8 x 25	S	200	14,80 gal ZnDi
M 8 x 30	S	200	16,10 gal ZnDi
M 8 x 35	S	200	17,90 gal ZnDi
M 8 x 40	S	200	19,60 gal ZnDi
M 8 x 45	S	200	23,20 gal ZnDi
M 8 x 50	S	200	26,50 gal ZnDi
M 8 x 55	S	200	37,50 gal ZnDi
M 8 x 60	S	200	40,00 gal ZnDi
M 8 x 65	S	200	52,00 gal ZnDi
M 8 x 70	S	200	63,00 gal ZnDi
M 8 x 75	S	200	75,00 gal ZnDi
M 8 x 80	S	200	75,00 gal ZnDi
M 8 x 90	S	100	88,00 gal ZnDi
M 8 x 100	S	100	101,00 gal ZnDi
M 8 x 110	S	100	126,00 gal ZnDi
M 10 x 12	S	200	32,00 gal ZnDi
M 10 x 16	S	200	22,60 gal ZnDi
M 10 x 20	S	200	22,10 gal ZnDi
M 10 x 25	S	200	23,90 gal ZnDi
M 10 x 30	S	200	26,00 gal ZnDi
M 10 x 35	S	100	28,50 gal ZnDi
M 10 x 40	S	100	30,50 gal ZnDi
M 10 x 45	S	100	36,00 gal ZnDi
M 10 x 50	S	100	37,50 gal ZnDi
M 10 x 55	S	100	48,50 gal ZnDi
M 10 x 60	S	100	53,00 gal ZnDi
M 10 x 65	S	100	79,00 gal ZnDi
M 10 x 70	S	100	80,00 gal ZnDi
M 10 x 80	S	100	108,00 gal ZnDi
M 10 x 90	S	100	126,00 gal ZnDi
M 10 x 100	S	100	148,00 gal ZnDi
M 10 x 110	S	50	197,00 gal ZnDi
M 10 x 120	S	50	203,00 gal ZnDi
M 10 x 130	S	50	265,00 gal ZnDi
M 12 x 16	S	100	39,50 gal ZnDi
M 12 x 20	S	100	37,00 gal ZnDi
M 12 x 25	S	100	38,00 gal ZnDi
M 12 x 30	S	100	37,50 gal ZnDi
M 12 x 35	S	100	41,00 gal ZnDi
M 12 x 40	S	100	44,50 gal ZnDi
M 12 x 45	S	100	49,00 gal ZnDi
M 12 x 50	S	100	53,00 gal ZnDi
M 12 x 55	S	100	63,00 gal ZnDi
M 12 x 60	S	100	67,00 gal ZnDi
M 12 x 65	S	50	100,00 gal ZnDi
M 12 x 70	S	50	101,00 gal ZnDi
M 12 x 75	S	50	113,00 gal ZnDi

Abmessungen	VE	Stück	€/100/Obf.
M 12 x 80	S	50	136,00 gal ZnDi
M 12 x 90	S	50	161,00 gal ZnDi
M 12 x 100	S	50	181,00 gal ZnDi
M 12 x 120	S	50	270,00 gal ZnDi
M 14 x 30	S	100	111,00 gal ZnDi
M 14 x 35	S	100	124,00 gal ZnDi
M 14 x 40	S	100	125,00 gal ZnDi
M 14 x 45	S	100	137,00 gal ZnDi
M 14 x 50	S	100	144,00 gal ZnDi
M 16 x 20	S	50	78,00 gal ZnDi
M 16 x 25	S	50	80,00 gal ZnDi
M 16 x 30	S	50	78,00 gal ZnDi
M 16 x 35	S	50	84,00 gal ZnDi
M 16 x 40	S	50	88,00 gal ZnDi
M 16 x 45	S	50	94,00 gal ZnDi
M 16 x 50	S	50	101,00 gal ZnDi
M 16 x 55	S	50	118,00 gal ZnDi
M 16 x 60	S	50	125,00 gal ZnDi
M 16 x 65	S	25	176,00 gal ZnDi
M 16 x 70	S	25	180,00 gal ZnDi
M 16 x 75	S	25	205,00 gal ZnDi
M 16 x 80	S	25	245,00 gal ZnDi
M 16 x 85	S	25	305,00 gal ZnDi
M 16 x 90	S	25	310,00 gal ZnDi
M 16 x 100	S	25	350,00 gal ZnDi
M 16 x 120	S	25	480,00 gal ZnDi
M 16 x 130	S	25	500,00 gal ZnDi
M 16 x 140	S	25	530,00 gal ZnDi
M 16 x 150	S	25	590,00 gal ZnDi
M 20 x 30	S	25	172,00 gal ZnDi
M 20 x 35	S	25	176,00 gal ZnDi
M 20 x 40	S	25	169,00 gal ZnDi
M 20 x 45	S	25	174,00 gal ZnDi
M 20 x 50	S	25	180,00 gal ZnDi
M 20 x 55	S	25	188,00 gal ZnDi
M 20 x 60	S	25	193,00 gal ZnDi
M 20 x 65	S	25	217,00 gal ZnDi
M 20 x 70	S	25	227,00 gal ZnDi
M 20 x 75	S	25	275,00 gal ZnDi
M 20 x 80	S	25	270,00 gal ZnDi
M 20 x 90	S	25	400,00 gal ZnDi
M 20 x 100	S	25	540,00 gal ZnDi
M 20 x 110	S	25	590,00 gal ZnDi
M 20 x 120	S	25	650,00 gal ZnDi
M 24 x 50	S	25	295,00 gal ZnDi
M 24 x 55	S	25	310,00 gal ZnDi
M 24 x 60	S	25	320,00 gal ZnDi
M 24 x 65	S	25	360,00 gal ZnDi
M 24 x 70	S	25	365,00 gal ZnDi
M 24 x 75	S	25	465,00 gal ZnDi
M 24 x 80	S	25	445,00 gal ZnDi
M 24 x 90	S	10	670,00 gal ZnDi
M 24 x 100	S	10	860,00 gal ZnDi
M 24 x 110	S	10	990,00 gal ZnDi
M 30 x 100	S	1	1970,00 gal ZnDi
M 30 x 120	S	1	2210,00 gal ZnDi



- ✓ Große Artikelvielfalt
- ✓ Verlässliche Qualität
- ✓ Hohe Lieferbereitschaft

Abmessungen	VE Stück	€/100/Obf.
DIN	00933.428	
933	8.8	galv. verz. 8 DiSP* + SL**



Sechskantschrauben mit Gewinde bis Kopf

*M 6 Mindestschichtdicke 5µm,
 **SL = Sealer and Lubrication
 (Versiegelung und Schmierung mit $\mu = 0,12 - 0,18$),
 Korrosionsbeständigkeit NSS: 120h WR, 264h RR

Maße → **TI-15** Anziehmomente → **TI-244**
 Werkstoffeigensch. → **TI-232** Normumstellung → **TI-6**
 Korrosionsschutz → **TI-228**

Rostfrei → **S. 490**
 Messing, Kunststoff → **S. 625**

• DIN 933 → wird ersetzt durch ISO 4017
 • Ø M10, 12, 14, 22 mit ISO-Schlüsselweiten
 unter ISO 4017 vorrätig

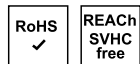

M 3	x	8	S	500	7,20 gal ZnDi
M 3	x	10	S	500	7,30 gal ZnDi
M 3	x	12	S	500	8,00 gal ZnDi
M 3	x	16	S	500	8,00 gal ZnDi
M 3	x	20	S	500	8,30 gal ZnDi
M 3	x	25	S	500	9,40 gal ZnDi
M 4	x	6	S	500	7,50 gal ZnDi
M 4	x	8	S	500	7,50 gal ZnDi
M 4	x	10	S	500	7,60 gal ZnDi
M 4	x	12	S	500	8,30 gal ZnDi
M 4	x	16	S	500	8,30 gal ZnDi
M 4	x	20	S	500	8,80 gal ZnDi
M 4	x	25	S	500	9,90 gal ZnDi
M 4	x	30	S	500	11,40 gal ZnDi
M 4	x	35	S	500	12,70 gal ZnDi
M 4	x	40	S	500	13,80 gal ZnDi
M 5	x	8	S	500	5,60 gal ZnDi
M 5	x	8	S	500	5,60 gal ZnDi
M 5	x	12	S	500	5,90 gal ZnDi
M 5	x	16	S	500	6,00 gal ZnDi
M 5	x	20	S	500	6,40 gal ZnDi
M 5	x	25	S	500	7,30 gal ZnDi
M 5	x	30	S	500	8,30 gal ZnDi
M 5	x	35	S	200	9,50 gal ZnDi
M 5	x	40	S	200	12,50 gal ZnDi
M 5	x	50	S	200	16,20 gal ZnDi
M 6	x	8	S	500	8,30 gal ZnDi
M 6	x	10	S	500	7,70 gal ZnDi
M 6	x	12	S	500	7,90 gal ZnDi
M 6	x	16	S	500	7,30 gal ZnDi
M 6	x	18	S	500	7,60 gal ZnDi
M 6	x	20	S	500	7,70 gal ZnDi
M 6	x	22	S	500	7,90 gal ZnDi
M 6	x	25	S	500	8,50 gal ZnDi
M 6	x	30	S	500	9,20 gal ZnDi
M 6	x	35	S	200	10,10 gal ZnDi
M 6	x	40	S	200	11,20 gal ZnDi
M 6	x	45	S	200	15,40 gal ZnDi
M 6	x	50	S	200	15,90 gal ZnDi
M 6	x	55	S	200	27,00 gal ZnDi
M 6	x	60	S	200	30,00 gal ZnDi
M 6	x	65	S	200	37,50 gal ZnDi
M 6	x	70	S	200	46,00 gal ZnDi
M 6	x	75	S	200	54,00 gal ZnDi
M 6	x	80	S	200	55,00 gal ZnDi

Abmessungen	VE Stück	€/100/Obf.			
M 8	x	10	S	200	15,00 gal ZnDi
M 8	x	12	S	200	13,80 gal ZnDi
M 8	x	14	S	200	12,80 gal ZnDi
M 8	x	16	S	200	11,60 gal ZnDi
M 8	x	18	S	200	12,20 gal ZnDi
M 8	x	20	S	200	12,40 gal ZnDi
M 8	x	22	S	200	14,00 gal ZnDi
M 8	x	25	S	200	14,20 gal ZnDi
M 8	x	28	S	200	14,70 gal ZnDi
M 8	x	30	S	200	15,40 gal ZnDi
M 8	x	35	S	200	17,20 gal ZnDi
M 8	x	40	S	200	18,80 gal ZnDi
M 8	x	45	S	200	22,30 gal ZnDi
M 8	x	50	S	200	25,50 gal ZnDi
M 8	x	55	S	200	36,00 gal ZnDi
M 8	x	60	S	200	38,50 gal ZnDi
M 8	x	65	S	200	50,00 gal ZnDi
M 8	x	70	S	200	61,00 gal ZnDi
M 8	x	75	S	200	72,00 gal ZnDi
M 8	x	80	S	200	72,00 gal ZnDi
M 8	x	90	S	100	84,00 gal ZnDi
M 8	x	100	S	100	96,00 gal ZnDi
M 8	x	110	S	100	121,00 gal ZnDi
M 16	x	20	S	50	75,00 gal ZnDi
M 16	x	25	S	50	77,00 gal ZnDi
M 16	x	30	S	50	75,00 gal ZnDi
M 16	x	35	S	50	80,00 gal ZnDi
M 16	x	40	S	50	84,00 gal ZnDi
M 16	x	45	S	50	90,00 gal ZnDi
M 16	x	50	S	50	96,00 gal ZnDi
M 16	x	55	S	50	113,00 gal ZnDi
M 16	x	60	S	50	119,00 gal ZnDi
M 16	x	65	S	25	169,00 gal ZnDi
M 16	x	70	S	25	172,00 gal ZnDi
M 16	x	75	S	25	197,00 gal ZnDi
M 16	x	80	S	25	234,00 gal ZnDi
M 16	x	85	S	25	295,00 gal ZnDi
M 16	x	90	S	25	295,00 gal ZnDi
M 16	x	100	S	25	335,00 gal ZnDi
M 16	x	110	S	25	425,00 gal ZnDi
M 16	x	120	S	25	460,00 gal ZnDi
M 16	x	130	S	25	480,00 gal ZnDi
M 16	x	140	S	25	510,00 gal ZnDi
M 16	x	140	S	25	570,00 gal ZnDi
M 16	x	180	S	25	830,00 gal ZnDi
M 16	x	200	S	25	860,00 gal ZnDi
M 18	x	100	S	25	255,00 gal ZnDi
M 20	x	30	S	25	165,00 gal ZnDi
M 20	x	40	S	25	162,00 gal ZnDi
M 20	x	45	S	25	166,00 gal ZnDi
M 20	x	50	S	25	172,00 gal ZnDi
M 20	x	55	S	25	181,00 gal ZnDi
M 20	x	60	S	25	185,00 gal ZnDi
M 20	x	65	S	25	208,00 gal ZnDi
M 20	x	70	S	25	217,00 gal ZnDi
M 20	x	75	S	25	260,00 gal ZnDi
M 20	x	80	S	25	260,00 gal ZnDi
M 20	x	85	S	25	325,00 gal ZnDi
M 20	x	90	S	25	385,00 gal ZnDi
M 20	x	100	S	25	520,00 gal ZnDi
M 20	x	110	S	25	570,00 gal ZnDi
M 20	x	120	S	25	620,00 gal ZnDi
M 20	x	150	S	25	1030,00 gal ZnDi
M 24	x	50	S	25	280,00 gal ZnDi
M 24	x	55	S	25	295,00 gal ZnDi
M 24	x	60	S	25	310,00 gal ZnDi
M 24	x	65	S	25	345,00 gal ZnDi
M 24	x	70	S	25	350,00 gal ZnDi
M 24	x	75	S	25	445,00 gal ZnDi
M 24	x	80	S	25	425,00 gal ZnDi
M 24	x	90	S	10	640,00 gal ZnDi
M 24	x	100	S	10	820,00 gal ZnDi
M 24	x	110	S	10	950,00 gal ZnDi
M 30	x	100	S	1	1890,00 gal ZnDi
M 30	x	120	S	1	2120,00 gal ZnDi

Abmessungen	VE Stück	€/100/Obf.
DIN	00933.353	
933	8.8	fiZn/TL480h

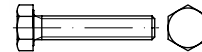

Sechskantschrauben mit Gewinde bis Kopf

TL = Schmierstoff im Topcoat mit $\mu = 0,09 - 0,14$,
 Korrosionsbeständigkeit NSS: 480h RR,
 Chrom(VI)-frei

Achtung! Gegenüber galv. verzinkt geänderte Anziehdrehmomente.

Maße → **TI-15** Anziehmomente → **TI-245**
 Werkstoffeigensch. → **TI-232** Normumstellung → **TI-6**

Rostfrei → **S. 490**
 Messing, Kunststoff → **S. 625**

DIN 933 → wird ersetzt durch ISO 4017

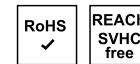

M 6	x	10	S	500	8,40 fiZn
M 6	x	12	S	500	8,60 fiZn
M 6	x	14	S	500	7,70 fiZn
M 6	x	16	S	500	7,90 fiZn
M 6	x	18	S	500	8,30 fiZn
M 6	x	20	S	500	8,30 fiZn
M 6	x	25	S	500	9,20 fiZn
M 6	x	30	S	500	10,00 fiZn
M 6	x	35	S	200	11,00 fiZn
M 6	x	40	S	200	12,20 fiZn
M 6	x	45	S	200	16,70 fiZn
M 6	x	50	S	200	17,20 fiZn
M 6	x	55	S	200	29,00 fiZn
M 6	x	60	S	200	32,50 fiZn
M 8	x	12	S	200	15,00 fiZn
M 8	x	16	S	200	12,60 fiZn
M 8	x	20	S	200	13,40 fiZn
M 8	x	25	S	200	15,40 fiZn
M 8	x	30	S	200	16,70 fiZn
M 8	x	35	S	200	18,60 fiZn
M 8	x	40	S	200	20,40 fiZn
M 8	x	45	S	200	24,10 fiZn
M 8	x	50	S	200	27,50 fiZn
M 8	x	55	S	200	39,00 fiZn
M 8	x	60	S	200	41,50 fiZn
M 8	x	65	S	200	54,00 fiZn
M 8	x	70	S	200	66,00 fiZn
M 16	x	25	S	50	83,00 fiZn
M 16	x	30	S	50	82,00 fiZn
M 16	x	35	S	50	87,00 fiZn
M 16	x	40	S	50	91,00 fiZn
M 16	x	45	S	50	98,00 fiZn
M 16	x	50	S	50	109,00 fiZn
M 16	x	55	S	50	123,00 fiZn
M 16	x	60	S	50	130,00 fiZn
M 16	x	65	S	25	183,00 fiZn
M 16	x	70	S	25	187,00 fiZn
M 16	x	75	S	25	213,00 fiZn
M 16	x	80	S	25	255,00 fiZn
M 16	x	90	S	25	320,00 fiZn
M 16	x	100	S	25	365,00 fiZn
M 16	x	110	S	25	460,00 fiZn
M 16	x	120	S	25	495,00 fiZn
M 20	x	30	S	25	178,00 fiZn
M 20	x	35	S	25	183,00 fiZn
M 20	x	40	S	25	176,00 fiZn

Abmessungen	VE	Stück	€/100/Obf.
M 20 x 45	S	25	181,00 flZn
M 20 x 50	S	25	187,00 flZn
M 20 x 55	S	25	197,00 flZn
M 20 x 60	S	25	201,00 flZn
M 20 x 65	S	25	226,00 flZn
M 20 x 70	S	25	235,00 flZn
M 20 x 75	S	25	285,00 flZn
M 20 x 80	S	25	280,00 flZn
M 20 x 90	S	25	415,00 flZn
M 20 x 100	S	25	560,00 flZn
M 20 x 110	S	25	610,00 flZn
M 20 x 120	S	25	670,00 flZn
M 24 x 40	S	25	365,00 flZn
M 24 x 45	S	25	315,00 flZn
M 24 x 50	S	25	305,00 flZn
M 24 x 55	S	25	320,00 flZn
M 24 x 60	S	25	455,00 flZn
M 24 x 65	S	25	380,00 flZn
M 24 x 70	S	25	470,00 flZn
M 24 x 75	S	25	485,00 flZn
M 24 x 80	S	25	820,00 flZn
M 24 x 90	S	10	790,00 flZn
M 24 x 100	S	10	890,00 flZn
M 24 x 110	S	10	1030,00 flZn
M 24 x 120	S	10	1070,00 flZn

DIN	00933.820
933	8.8 feuerverzinkt

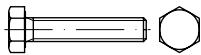

Sechskantschrauben mit Gewinde bis Kopf

Gewinde mit Untermaß (6az + tZn = U)

Achtung! Warneinblender zu Feuerverzinkung beachten!

Maße → **TI-15** Anziehmomente → **TI-244**
 Werkstoffeigensch. → **TI-232** Normumstellung → **TI-6**
 Korrosionsschutz → **TI-231**

Rostfrei → **S. 490**
 Messing, Kunststoff → **S. 625**

DIN 933 → wird ersetzt durch ISO 4017

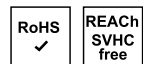

M 6 x 12	S	500	61,00 tZn
M 6 x 16	S	500	60,00 tZn
M 6 x 20	S	500	63,00 tZn
M 6 x 25	S	500	66,00 tZn
M 6 x 30	S	500	75,00 tZn
M 6 x 35	S	200	79,00 tZn
M 6 x 40	S	200	98,00 tZn
M 8 x 10	S	200	92,00 tZn
M 8 x 12	S	200	28,50 tZn
M 8 x 16	S	200	25,50 tZn
M 8 x 18	S	200	76,00 tZn
M 8 x 20	S	200	27,50 tZn
M 8 x 25	S	200	31,50 tZn
M 8 x 30	S	200	34,50 tZn
M 8 x 35	S	200	38,50 tZn
M 8 x 40	S	200	42,00 tZn
M 8 x 45	S	200	49,00 tZn
M 8 x 50	S	200	55,00 tZn
M 8 x 60	S	200	75,00 tZn
M 8 x 70	S	200	114,00 tZn
M 8 x 80	S	200	135,00 tZn

Abmessungen	VE	Stück	€/100/Obf.
M 8 x 90	S	100	430,00 tZn
M 8 x 100	S	100	450,00 tZn
M 10 x 12	S	200	62,00 tZn
M 10 x 16	S	200	47,50 tZn
M 10 x 18	S	200	142,00 tZn
M 10 x 20	S	200	47,50 tZn
M 10 x 25	S	200	52,00 tZn
M 10 x 30	S	200	57,00 tZn
M 10 x 35	S	100	62,00 tZn
M 10 x 40	S	100	66,00 tZn
M 10 x 45	S	100	76,00 tZn
M 10 x 50	S	100	81,00 tZn
M 10 x 55	S	100	100,00 tZn
M 10 x 60	S	100	107,00 tZn
M 10 x 70	S	100	148,00 tZn
M 10 x 80	S	100	195,00 tZn
M 10 x 90	S	100	234,00 tZn
M 10 x 100	S	100	270,00 tZn
M 10 x 110	S	50	355,00 tZn
M 10 x 120	S	50	400,00 tZn
M 12 x 16	S	100	80,00 tZn
M 12 x 20	S	100	77,00 tZn
M 12 x 25	S	100	80,00 tZn
M 12 x 30	S	100	81,00 tZn
M 12 x 35	S	100	89,00 tZn
M 12 x 40	S	100	96,00 tZn
M 12 x 45	S	100	105,00 tZn
M 12 x 50	S	100	113,00 tZn
M 12 x 55	S	100	132,00 tZn
M 12 x 60	S	100	141,00 tZn
M 12 x 65	S	50	177,00 tZn
M 12 x 70	S	50	193,00 tZn
M 12 x 80	S	50	255,00 tZn
M 12 x 90	S	50	295,00 tZn
M 12 x 100	S	50	330,00 tZn
M 12 x 120	S	50	475,00 tZn
M 12 x 130	S	50	510,00 tZn
M 12 x 140	S	50	680,00 tZn
M 16 x 20	S	50	161,00 tZn
M 16 x 25	S	50	167,00 tZn
M 16 x 30	S	50	167,00 tZn
M 16 x 35	S	50	181,00 tZn
M 16 x 40	S	50	193,00 tZn
M 16 x 45	S	50	204,00 tZn
M 16 x 50	S	50	220,00 tZn
M 16 x 55	S	50	255,00 tZn
M 16 x 60	S	50	265,00 tZn
M 16 x 65	S	25	335,00 tZn
M 16 x 70	S	25	340,00 tZn
M 16 x 75	S	25	410,00 tZn
M 16 x 80	S	25	460,00 tZn
M 16 x 85	S	25	510,00 tZn
M 16 x 90	S	25	570,00 tZn
M 16 x 100	S	25	630,00 tZn
M 16 x 110	S	25	800,00 tZn
M 16 x 120	S	25	860,00 tZn
M 16 x 130	S	25	950,00 tZn
M 16 x 140	S	25	960,00 tZn
M 16 x 150	S	25	1010,00 tZn
M 16 x 160	S	25	1080,00 tZn
M 16 x 170	S	25	1140,00 tZn
M 16 x 180	S	25	1190,00 tZn
M 16 x 200	S	25	1310,00 tZn
M 16 x 220	S	1	1380,00 tZn
M 16 x 240	S	1	1540,00 tZn
M 16 x 260	S	1	1640,00 tZn
M 16 x 280	S	1	1770,00 tZn
M 16 x 300	S	1	2180,00 tZn
M 20 x 30	S	25	350,00 tZn
M 20 x 35	S	25	365,00 tZn
M 20 x 40	S	25	360,00 tZn
M 20 x 45	S	25	370,00 tZn
M 20 x 50	S	25	385,00 tZn
M 20 x 55	S	25	410,00 tZn
M 20 x 60	S	25	420,00 tZn

Abmessungen	VE	Stück	€/100/Obf.
M 20 x 65	S	25	470,00 tZn
M 20 x 70	S	25	480,00 tZn
M 20 x 75	S	25	540,00 tZn
M 20 x 80	S	25	570,00 tZn
M 20 x 90	S	25	750,00 tZn
M 20 x 100	S	25	980,00 tZn
M 20 x 110	S	25	1010,00 tZn
M 20 x 120	S	25	1180,00 tZn
M 20 x 130	S	1	1380,00 tZn
M 20 x 140	S	1	1780,00 tZn
M 20 x 150	S	1	1880,00 tZn
M 20 x 160	S	1	1940,00 tZn
M 20 x 180	S	1	2180,00 tZn
M 24 x 40	S	25	620,00 tZn
M 24 x 45	S	25	630,00 tZn
M 24 x 50	S	25	620,00 tZn
M 24 x 55	S	25	660,00 tZn
M 24 x 60	S	25	690,00 tZn
M 24 x 65	S	25	750,00 tZn
M 24 x 70	S	25	770,00 tZn
M 24 x 80	S	25	920,00 tZn
M 24 x 90	S	10	1230,00 tZn
M 24 x 100	S	10	1560,00 tZn
M 24 x 110	S	10	2900,00 tZn
M 24 x 120	S	10	3550,00 tZn
M 24 x 130	S	10	4200,00 tZn
M 24 x 140	S	10	4500,00 tZn
M 24 x 150	S	1	4950,00 tZn
M 24 x 180	S	1	6400,00 tZn
M 30 x 60	S	1	2800,00 tZn
M 30 x 70	S	1	3000,00 tZn
M 30 x 80	S	1	3250,00 tZn
M 30 x 90	S	1	3450,00 tZn
M 30 x 100	S	1	3700,00 tZn
M 30 x 120	S	1	3850,00 tZn
M 30 x 130	S	1	3950,00 tZn
M 30 x 140	S	1	4050,00 tZn
M 30 x 150	S	1	4100,00 tZn
M 30 x 160	S	1	4400,00 tZn
M 30 x 170	S	1	4550,00 tZn
M 30 x 180	S	1	4600,00 tZn
M 30 x 190	S	1	4700,00 tZn
M 30 x 200	S	1	4750,00 tZn

Achtung!

Feuerverzinkte Schrauben-/Muttern-Garnituren dürfen nur miteinander verschraubt werden, wenn Gewindenspiel/-Toleranzen dieser Garnituren entsprechend ISO 10684 passend aufeinander abgestimmt sind. Die Verwendung mit anderen Schrauben-/Muttern-Ausführungen kann zu Verschraubungsproblemen und/oder zum Versagen der Verbindung führen.



Abmessungen	VE Stück	€/100/Obf.
DIN 00933.814		
933	8.8	Sz
galvanisch verzinkt		

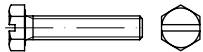

Sechskantschrauben mit Gewinde bis Kopf, Sz = Kopf mit Schlitz nach DIN 962

Maße → TI-15 Anziehmomente → TI-244
 Werkstoffeigensch. → TI-232 Normumstellung → TI-6
 Korrosionsschutz → TI-228
 Rostfrei → S. 492

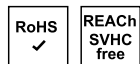

M 4 x 6	S	500	46,50 gal Zn
M 4 x 8	S	500	20,40 gal Zn
M 4 x 10	S	500	20,60 gal Zn
M 4 x 12	S	500	20,70 gal Zn
M 4 x 16	S	500	20,90 gal Zn
M 4 x 20	S	500	21,20 gal Zn
M 5 x 8	S	500	23,40 gal Zn
M 5 x 10	S	500	23,80 gal Zn
M 5 x 12	S	500	24,20 gal Zn
M 5 x 16	S	500	26,00 gal Zn
M 5 x 20	S	500	27,00 gal Zn
M 5 x 25	S	500	28,50 gal Zn
M 6 x 10	S	500	33,50 gal Zn
M 6 x 12	S	500	34,00 gal Zn
M 6 x 16	S	500	36,00 gal Zn
M 6 x 20	S	500	37,50 gal Zn
M 6 x 22	S	500	38,00 gal Zn
M 6 x 25	S	500	39,50 gal Zn
M 6 x 30	S	500	41,50 gal Zn
M 8 x 12	S	200	53,00 gal Zn
M 8 x 16	S	200	54,00 gal Zn
M 8 x 20	S	200	56,00 gal Zn
M 8 x 25	S	200	59,00 gal Zn
M 8 x 30	S	200	63,00 gal Zn

Abmessungen	VE Stück	€/100/Obf.
DIN 00933.100		
933	10.9	



Sechskantschrauben mit Gewinde bis Kopf

Maße → TI-15 Anziehmomente → TI-244
 Werkstoffeigensch. → TI-232 Normumstellung → TI-6
 Rostfrei → S. 490
 Messing, Kunststoff → S. 625
 DIN 933 → wird ersetzt durch ISO 4017

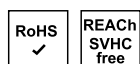

M 5 x 10	S	500	8,20
M 5 x 12	S	500	8,40
M 5 x 14	S	500	8,80
M 5 x 16	S	500	9,00

Abmessungen	VE Stück	€/100/Obf.	Abmessungen	VE Stück	€/100/Obf.		
M 5 x 18	S	500	9,20	M 10 x 150	S	50	860,00
M 5 x 20	S	500	9,50	M 10 x 200	S	50	1180,00
M 5 x 22	S	500	9,70	M 12 x 16	S	100	190,00
M 5 x 25	S	500	10,00	M 12 x 20	S	100	55,00
M 5 x 30	S	500	11,50	M 12 x 25	S	100	51,00
M 5 x 35	S	200	13,10	M 12 x 30	S	100	54,00
M 6 x 10	S	500	22,50	M 12 x 35	S	100	56,00
M 6 x 12	S	500	13,80	M 12 x 40	S	100	59,00
M 6 x 12	K	100	17,50	M 12 x 45	S	100	67,00
M 6 x 16	S	500	11,80	M 12 x 50	S	100	70,00
M 6 x 16	K	100	15,50	M 12 x 55	S	100	97,00
M 6 x 18	S	500	12,60	M 12 x 60	S	100	104,00
M 6 x 20	S	500	12,60	M 12 x 65	S	50	170,00
M 6 x 20	K	100	16,20	M 12 x 70	S	50	215,00
M 6 x 22	S	500	13,10	M 12 x 75	S	50	295,00
M 6 x 25	S	500	13,10	M 12 x 80	S	50	295,00
M 6 x 25	K	100	16,70	M 12 x 90	S	50	390,00
M 6 x 30	S	500	15,80	M 12 x 100	S	50	460,00
M 6 x 30	K	100	20,10	M 12 x 110	S	50	530,00
M 6 x 35	S	200	18,00	M 12 x 120	S	50	590,00
M 6 x 40	S	200	19,70	M 12 x 130	S	50	760,00
M 6 x 45	S	200	77,00	M 12 x 140	S	50	830,00
M 6 x 50	S	200	92,00	M 12 x 150	S	50	870,00
M 6 x 55	S	200	107,00	M 12 x 160	S	25	910,00
M 6 x 60	S	200	123,00	M 12 x 170	S	25	940,00
M 6 x 70	S	200	236,00	M 12 x 180	S	25	1020,00
M 6 x 80	S	200	255,00	M 12 x 200	S	25	1190,00
M 8 x 12	S	200	23,00	M 14 x 25	S	100	101,00
M 8 x 16	S	200	16,40	M 14 x 30	S	100	96,00
M 8 x 18	S	200	17,10	M 14 x 35	S	100	99,00
M 8 x 20	S	200	17,70	M 14 x 40	S	100	104,00
M 8 x 22	S	200	19,60	M 14 x 45	S	50	108,00
M 8 x 25	S	200	20,70	M 14 x 50	S	50	113,00
M 8 x 30	S	200	20,70	M 14 x 55	S	50	138,00
M 8 x 35	S	200	24,40	M 14 x 60	S	50	138,00
M 8 x 40	S	200	26,50	M 14 x 65	S	50	245,00
M 8 x 45	S	200	39,00	M 14 x 70	S	50	245,00
M 8 x 50	S	200	42,50	M 14 x 75	S	50	280,00
M 8 x 55	S	200	55,00	M 14 x 80	S	50	340,00
M 8 x 60	S	200	55,00	M 14 x 90	S	50	490,00
M 8 x 65	S	200	138,00	M 14 x 100	S	50	590,00
M 8 x 70	S	200	138,00	M 14 x 110	S	50	880,00
M 8 x 75	S	200	170,00	M 14 x 120	S	50	920,00
M 8 x 80	S	200	170,00	M 14 x 160	S	25	1340,00
M 8 x 90	S	100	222,00	M 14 x 200	S	25	1740,00
M 8 x 100	S	100	325,00	M 16 x 20	S	50	176,00
M 8 x 110	S	100	445,00	M 16 x 25	S	50	110,00
M 8 x 120	S	100	500,00	M 16 x 30	S	50	110,00
M 8 x 130	S	100	690,00	M 16 x 35	S	50	110,00
M 8 x 140	S	100	750,00	M 16 x 40	S	50	120,00
M 8 x 150	S	100	780,00	M 16 x 45	S	50	123,00
M 8 x 180	S	100	940,00	M 16 x 50	S	50	136,00
M 10 x 12	S	200	47,00	M 16 x 55	S	50	147,00
M 10 x 16	S	200	33,50	M 16 x 60	S	50	147,00
M 10 x 18	S	200	33,50	M 16 x 65	S	25	310,00
M 10 x 20	S	200	29,50	M 16 x 70	S	25	310,00
M 10 x 22	S	200	31,50	M 16 x 75	S	25	395,00
M 10 x 25	S	200	31,50	M 16 x 80	S	25	325,00
M 10 x 30	S	200	33,00	M 16 x 90	S	25	460,00
M 10 x 35	S	100	35,50	M 16 x 100	S	25	590,00
M 10 x 40	S	100	37,50	M 16 x 110	S	25	660,00
M 10 x 45	S	100	44,50	M 16 x 120	S	25	720,00
M 10 x 50	S	100	50,00	M 16 x 130	S	25	810,00
M 10 x 55	S	100	83,00	M 16 x 140	S	25	870,00
M 10 x 60	S	100	83,00	M 16 x 150	S	25	910,00
M 10 x 65	S	100	176,00	M 16 x 160	S	25	960,00
M 10 x 70	S	100	194,00	M 16 x 170	S	25	1010,00
M 10 x 75	S	100	223,00	M 16 x 180	S	25	1060,00
M 10 x 80	S	100	223,00	M 16 x 190	S	25	1160,00
M 10 x 90	S	100	335,00	M 16 x 200	S	25	1250,00
M 10 x 100	S	100	415,00	M 16 x 220	S	1	1390,00
M 10 x 110	S	50	480,00	M 16 x 240	S	1	1730,00
M 10 x 120	S	50	660,00	M 16 x 260	S	1	1890,00
M 10 x 130	S	50	750,00	M 16 x 280	S	1	2050,00
M 10 x 140	S	50	810,00	M 16 x 300	S	1	2200,00

Abmessungen	VE	Stück	€/100/Obf.
M 18 x 30	S	50	300,00
M 18 x 35	S	50	300,00
M 18 x 40	S	50	270,00
M 18 x 45	S	50	290,00
M 18 x 50	S	50	295,00
M 18 x 55	S	25	305,00
M 18 x 60	S	25	320,00
M 18 x 65	S	25	730,00
M 18 x 70	S	25	840,00
M 18 x 75	S	25	840,00
M 18 x 80	S	25	1030,00
M 18 x 90	S	25	1050,00
M 18 x 100	S	25	1070,00
M 18 x 120	S	25	1210,00
M 18 x 130	S	25	1310,00
M 18 x 160	S	25	1610,00
M 18 x 200	S	25	1980,00
M 20 x 30	S	25	440,00
M 20 x 35	S	25	300,00
M 20 x 40	S	25	270,00
M 20 x 45	S	25	290,00
M 20 x 50	S	25	295,00
M 20 x 55	S	25	305,00
M 20 x 60	S	25	320,00
M 20 x 65	S	25	610,00
M 20 x 70	S	25	620,00
M 20 x 75	S	25	640,00
M 20 x 80	S	25	640,00
M 20 x 90	S	25	640,00
M 20 x 100	S	25	680,00
M 20 x 110	S	25	1050,00
M 20 x 120	S	25	1060,00
M 20 x 130	S	25	1220,00
M 20 x 140	S	25	1300,00
M 20 x 150	S	25	1390,00
M 20 x 160	S	25	1490,00
M 20 x 170	S	25	1580,00
M 20 x 180	S	25	1680,00
M 20 x 190	S	25	1750,00
M 20 x 200	S	1	1830,00
M 20 x 210	S	1	2130,00
M 20 x 220	S	1	2130,00
M 20 x 240	S	1	2390,00
M 20 x 260	S	1	2650,00
M 20 x 280	S	1	3000,00
M 20 x 300	S	1	3250,00
M 22 x 50	S	25	1050,00
M 22 x 55	S	25	1230,00
M 22 x 60	S	25	1050,00
M 22 x 65	S	25	1230,00
M 22 x 70	S	25	1290,00
M 22 x 75	S	25	1360,00
M 22 x 80	S	25	1400,00
M 22 x 90	S	25	1530,00
M 22 x 100	S	10	1580,00
M 22 x 110	S	10	1780,00
M 22 x 120	S	10	1910,00
M 22 x 130	S	10	2100,00
M 22 x 140	S	10	2240,00
M 22 x 150	S	10	2360,00
M 22 x 200	S	10	3250,00
M 24 x 30	S	25	630,00
M 24 x 35	S	25	630,00
M 24 x 40	S	25	475,00
M 24 x 45	S	25	475,00
M 24 x 50	S	25	780,00
M 24 x 55	S	25	780,00
M 24 x 60	S	25	780,00
M 24 x 65	S	25	790,00
M 24 x 70	S	25	810,00
M 24 x 75	S	25	820,00
M 24 x 80	S	25	830,00
M 24 x 90	S	10	840,00
M 24 x 100	S	10	880,00
M 24 x 110	S	10	980,00

Abmessungen	VE	Stück	€/100/Obf.
M 24 x 120	S	10	1050,00
M 24 x 130	S	1	1400,00
M 24 x 140	S	1	1490,00
M 24 x 150	S	1	1580,00
M 24 x 160	S	1	1740,00
M 24 x 170	S	1	1870,00
M 24 x 180	S	1	1960,00
M 24 x 190	S	1	2040,00
M 24 x 200	S	1	2140,00
M 24 x 210	S	1	2390,00
M 24 x 220	S	1	2390,00
M 24 x 240	S	1	2800,00
M 24 x 260	S	1	3200,00
M 24 x 280	S	1	3700,00
M 24 x 300	S	1	4000,00
M 27 x 50	S	10	1050,00
M 27 x 55	S	10	1050,00
M 27 x 60	S	10	1050,00
M 27 x 65	S	10	1060,00
M 27 x 70	S	10	1090,00
M 27 x 75	S	10	1110,00
M 27 x 80	S	10	1120,00
M 27 x 90	S	10	1140,00
M 27 x 100	S	10	1190,00
M 27 x 110	S	10	1320,00
M 27 x 120	S	10	1390,00
M 27 x 130	S	1	1460,00
M 27 x 140	S	1	1610,00
M 27 x 150	S	1	1690,00
M 27 x 160	S	1	1880,00
M 27 x 180	S	1	2080,00
M 27 x 200	S	1	2250,00
M 30 x 40	S	1	1140,00
M 30 x 50	S	1	1140,00
M 30 x 55	S	1	1140,00
M 30 x 60	S	1	1200,00
M 30 x 65	S	1	1230,00
M 30 x 70	S	1	1250,00
M 30 x 75	S	1	1270,00
M 30 x 80	S	1	1290,00
M 30 x 90	S	1	1340,00
M 30 x 100	S	1	1420,00
M 30 x 110	S	1	1590,00
M 30 x 120	S	1	1690,00
M 30 x 130	S	1	1780,00
M 30 x 140	S	1	1930,00
M 30 x 150	S	1	2040,00
M 30 x 160	S	1	2280,00
M 30 x 170	S	1	3350,00
M 30 x 180	S	1	3200,00
M 30 x 190	S	1	3650,00
M 30 x 200	S	1	3450,00
M 33 x 100	S	1	3900,00
M 33 x 160	S	1	4750,00
M 33 x 200	S	1	5700,00
M 36 x 40	S	1	2040,00
M 36 x 50	S	1	2040,00
M 36 x 55	S	1	2040,00
M 36 x 60	S	1	2040,00
M 36 x 65	S	1	2040,00
M 36 x 70	S	1	2080,00
M 36 x 75	S	1	2130,00
M 36 x 80	S	1	2170,00
M 36 x 90	S	1	2250,00
M 36 x 100	S	1	2350,00
M 36 x 110	S	1	2600,00
M 36 x 120	S	1	2750,00
M 36 x 130	S	1	2900,00
M 36 x 140	S	1	3150,00
M 36 x 150	S	1	3250,00
M 36 x 160	S	1	3650,00
M 36 x 170	S	1	4550,00
M 36 x 180	S	1	3950,00
M 36 x 190	S	1	4950,00
M 36 x 200	S	1	4250,00

Abmessungen	VE	Stück	€/100/Obf.
M 42 x 100	S	1	5900,00
M 42 x 110	S	1	6600,00
M 42 x 130	S	1	7300,00
M 42 x 200	S	1	10800,00

DIN	00933.110
933	10.9 galvanisch verzinkt



Sechskantschrauben mit Gewinde bis Kopf

getempert

Achtung! Warneinblender zu Wasserstoffversprödung beachten.

Maße → TI-15 Anziehmomente → TI-244
 Werkstoffeigensch. → TI-232 Normumstellung → TI-6
 Korrosionsschutz → TI-228

Rostfrei → S. 490
 Messing, Kunststoff → S. 625

DIN 933 → wird ersetzt durch ISO 4017

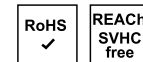

M 6 x 10	S	500	24,40 gal Zn
M 6 x 12	S	500	15,90 gal Zn
M 6 x 16	S	500	14,20 gal Zn
M 6 x 20	S	500	15,30 gal Zn
M 6 x 22	S	500	16,10 gal Zn
M 6 x 25	S	500	16,20 gal Zn
M 6 x 30	S	500	19,30 gal Zn
M 6 x 35	S	500	22,10 gal Zn
M 6 x 40	S	500	24,10 gal Zn
M 6 x 45	S	200	81,00 gal Zn
M 6 x 50	S	200	97,00 gal Zn
M 6 x 55	S	200	112,00 gal Zn
M 6 x 60	S	200	127,00 gal Zn
M 8 x 12	S	200	28,00 gal Zn
M 8 x 16	S	200	21,40 gal Zn
M 8 x 18	S	200	22,70 gal Zn
M 8 x 20	S	200	23,30 gal Zn
M 8 x 22	S	200	26,50 gal Zn
M 8 x 25	S	200	27,00 gal Zn
M 8 x 30	S	200	28,00 gal Zn
M 8 x 35	S	200	32,50 gal Zn
M 8 x 40	S	200	35,00 gal Zn
M 8 x 45	S	200	49,50 gal Zn
M 8 x 50	S	200	53,00 gal Zn
M 8 x 55	S	200	66,00 gal Zn
M 8 x 60	S	200	68,00 gal Zn
M 8 x 70	S	200	152,00 gal Zn
M 8 x 75	S	200	184,00 gal Zn
M 8 x 80	S	200	182,00 gal Zn
M 8 x 100	S	100	340,00 gal Zn
M 10 x 12	S	200	56,00 gal Zn
M 10 x 16	S	200	43,00 gal Zn
M 10 x 18	S	200	42,50 gal Zn
M 10 x 20	S	200	39,50 gal Zn
M 10 x 25	S	200	42,50 gal Zn
M 10 x 30	S	200	45,50 gal Zn
M 10 x 35	S	100	48,00 gal Zn
M 10 x 40	S	100	52,00 gal Zn
M 10 x 45	S	100	61,00 gal Zn
M 10 x 50	S	100	67,00 gal Zn
M 10 x 55	S	100	98,00 gal Zn
M 10 x 60	S	100	102,00 gal Zn

Abmessungen	VE	Stück	€/100/0bf.	Abmessungen	VE	Stück	€/100/0bf.	Abmessungen	VE	Stück	€/100/0bf.
M 10 x 70	S	100	216,00 gal Zn	M 20 x 35	S	25	285,00 gal Zn	M 30 x 190	S	1	4200,00 gal Zn
M 10 x 75	S	100	247,00 gal Zn	M 20 x 40	S	25	345,00 gal Zn	M 30 x 200	S	1	4050,00 gal Zn
M 10 x 80	S	100	247,00 gal Zn	M 20 x 45	S	25	365,00 gal Zn	M 36 x 40	S	1	2290,00 gal Zn
M 10 x 90	S	100	360,00 gal Zn	M 20 x 50	S	25	375,00 gal Zn	M 36 x 50	S	1	2290,00 gal Zn
M 10 x 100	S	100	445,00 gal Zn	M 20 x 55	S	25	385,00 gal Zn	M 36 x 60	S	1	2290,00 gal Zn
M 10 x 110	S	50	510,00 gal Zn	M 20 x 60	S	25	410,00 gal Zn	M 36 x 70	S	1	2340,00 gal Zn
M 12 x 20	S	100	69,00 gal Zn	M 20 x 65	S	25	710,00 gal Zn	M 36 x 80	S	1	2440,00 gal Zn
M 12 x 25	S	100	66,00 gal Zn	M 20 x 70	S	25	720,00 gal Zn	M 36 x 90	S	1	2550,00 gal Zn
M 12 x 30	S	100	70,00 gal Zn	M 20 x 75	S	25	750,00 gal Zn	M 36 x 100	S	1	2650,00 gal Zn
M 12 x 35	S	100	75,00 gal Zn	M 20 x 80	S	25	750,00 gal Zn	M 36 x 110	S	1	2850,00 gal Zn
M 12 x 40	S	100	80,00 gal Zn	M 20 x 90	S	25	760,00 gal Zn	M 36 x 120	S	1	3000,00 gal Zn
M 12 x 45	S	100	88,00 gal Zn	M 20 x 100	S	25	810,00 gal Zn	M 36 x 130	S	1	3150,00 gal Zn
M 12 x 50	S	100	93,00 gal Zn	M 20 x 110	S	25	1200,00 gal Zn	M 36 x 140	S	1	3450,00 gal Zn
M 12 x 55	S	100	120,00 gal Zn	M 20 x 120	S	25	1210,00 gal Zn	M 36 x 150	S	1	3550,00 gal Zn
M 12 x 60	S	100	132,00 gal Zn	M 20 x 130	S	25	1380,00 gal Zn	M 36 x 160	S	1	3950,00 gal Zn
M 12 x 65	S	50	200,00 gal Zn	M 20 x 140	S	25	1470,00 gal Zn	M 36 x 170	S	1	4850,00 gal Zn
M 12 x 70	S	50	246,00 gal Zn	M 20 x 150	S	25	1570,00 gal Zn	M 36 x 180	S	1	4250,00 gal Zn
M 12 x 75	S	50	270,00 gal Zn	M 20 x 160	S	25	1680,00 gal Zn	M 36 x 190	S	1	5300,00 gal Zn
M 12 x 80	S	50	310,00 gal Zn	M 20 x 170	S	25	1780,00 gal Zn	M 36 x 200	S	1	4600,00 gal Zn
M 12 x 90	S	50	425,00 gal Zn	M 20 x 180	S	25	1890,00 gal Zn				
M 12 x 100	S	50	510,00 gal Zn	M 20 x 190	S	25	1970,00 gal Zn				
M 12 x 110	S	50	570,00 gal Zn	M 20 x 200	S	25	2060,00 gal Zn				
M 12 x 120	S	50	630,00 gal Zn	M 20 x 210	S	1	2370,00 gal Zn				
M 12 x 130	S	50	770,00 gal Zn	M 20 x 220	S	1	2380,00 gal Zn				
M 12 x 140	S	50	880,00 gal Zn	M 20 x 240	S	1	2700,00 gal Zn				
M 12 x 150	S	50	930,00 gal Zn	M 20 x 260	S	1	2950,00 gal Zn				
M 12 x 160	S	25	970,00 gal Zn	M 24 x 30	S	25	730,00 gal Zn				
M 12 x 180	S	25	1090,00 gal Zn	M 24 x 40	S	25	590,00 gal Zn				
M 12 x 200	S	25	1270,00 gal Zn	M 24 x 45	S	25	600,00 gal Zn				
M 14 x 30	S	100	125,00 gal Zn	M 24 x 50	S	25	900,00 gal Zn				
M 14 x 35	S	100	129,00 gal Zn	M 24 x 55	S	25	910,00 gal Zn				
M 14 x 40	S	100	136,00 gal Zn	M 24 x 60	S	25	910,00 gal Zn				
M 14 x 45	S	50	141,00 gal Zn	M 24 x 65	S	25	940,00 gal Zn				
M 14 x 50	S	50	151,00 gal Zn	M 24 x 70	S	25	970,00 gal Zn				
M 14 x 60	S	50	181,00 gal Zn	M 24 x 75	S	25	990,00 gal Zn				
M 14 x 65	S	50	295,00 gal Zn	M 24 x 80	S	25	990,00 gal Zn				
M 14 x 70	S	50	295,00 gal Zn	M 24 x 90	S	10	1010,00 gal Zn				
M 14 x 80	S	50	395,00 gal Zn	M 24 x 100	S	10	1070,00 gal Zn				
M 14 x 90	S	50	550,00 gal Zn	M 24 x 110	S	10	1190,00 gal Zn				
M 16 x 20	S	50	208,00 gal Zn	M 24 x 120	S	10	1270,00 gal Zn				
M 16 x 25	S	50	142,00 gal Zn	M 24 x 130	S	1	1640,00 gal Zn				
M 16 x 30	S	50	146,00 gal Zn	M 24 x 140	S	1	1750,00 gal Zn				
M 16 x 35	S	50	151,00 gal Zn	M 24 x 150	S	1	1850,00 gal Zn				
M 16 x 40	S	50	161,00 gal Zn	M 24 x 160	S	1	2030,00 gal Zn				
M 16 x 45	S	50	166,00 gal Zn	M 24 x 170	S	1	2170,00 gal Zn				
M 16 x 50	S	50	182,00 gal Zn	M 24 x 180	S	1	2280,00 gal Zn				
M 16 x 55	S	50	197,00 gal Zn	M 24 x 190	S	1	2370,00 gal Zn				
M 16 x 60	S	50	201,00 gal Zn	M 24 x 200	S	1	2490,00 gal Zn				
M 16 x 65	S	25	365,00 gal Zn	M 27 x 60	S	10	1250,00 gal Zn				
M 16 x 70	S	25	365,00 gal Zn	M 27 x 70	S	10	1310,00 gal Zn				
M 16 x 75	S	25	385,00 gal Zn	M 27 x 80	S	10	1350,00 gal Zn				
M 16 x 80	S	25	390,00 gal Zn	M 27 x 90	S	10	1400,00 gal Zn				
M 16 x 90	S	25	540,00 gal Zn	M 27 x 100	S	10	1460,00 gal Zn				
M 16 x 100	S	25	670,00 gal Zn	M 27 x 110	S	10	1610,00 gal Zn				
M 16 x 110	S	25	750,00 gal Zn	M 27 x 120	S	10	1690,00 gal Zn				
M 16 x 120	S	25	820,00 gal Zn	M 27 x 130	S	1	1790,00 gal Zn				
M 16 x 140	S	25	970,00 gal Zn	M 27 x 140	S	1	1950,00 gal Zn				
M 16 x 150	S	25	1020,00 gal Zn	M 30 x 40	S	1	1350,00 gal Zn				
M 16 x 160	S	25	1080,00 gal Zn	M 30 x 50	S	1	1380,00 gal Zn				
M 16 x 170	S	25	1130,00 gal Zn	M 30 x 55	S	1	1460,00 gal Zn				
M 16 x 180	S	25	1190,00 gal Zn	M 30 x 60	S	1	1460,00 gal Zn				
M 16 x 190	S	25	1290,00 gal Zn	M 30 x 65	S	1	1490,00 gal Zn				
M 16 x 200	S	25	1390,00 gal Zn	M 30 x 70	S	1	1540,00 gal Zn				
M 16 x 220	S	1	1550,00 gal Zn	M 30 x 75	S	1	1580,00 gal Zn				
M 16 x 240	S	1	1900,00 gal Zn	M 30 x 80	S	1	1600,00 gal Zn				
M 16 x 260	S	1	2070,00 gal Zn	M 30 x 90	S	1	1670,00 gal Zn				
M 16 x 280	S	1	2240,00 gal Zn	M 30 x 100	S	1	1770,00 gal Zn				
M 16 x 300	S	1	2410,00 gal Zn	M 30 x 110	S	1	1600,00 gal Zn				
M 18 x 40	S	50	330,00 gal Zn	M 30 x 120	S	1	2080,00 gal Zn				
M 18 x 45	S	50	350,00 gal Zn	M 30 x 130	S	1	2200,00 gal Zn				
M 18 x 50	S	50	355,00 gal Zn	M 30 x 140	S	1	2370,00 gal Zn				
M 18 x 55	S	25	370,00 gal Zn	M 30 x 150	S	1	1290,00 gal Zn				
M 18 x 60	S	25	390,00 gal Zn	M 30 x 160	S	1	2800,00 gal Zn				
M 18 x 70	S	25	900,00 gal Zn	M 30 x 170	S	1	3850,00 gal Zn				
M 20 x 30	S	25	510,00 gal Zn	M 30 x 180	S	1	3700,00 gal Zn				

Wichtiger Hinweis!



Bei galvanischen Überzügen auf hochfesten und federharten Teilen ($\geq 1000 \text{ N/mm}^2$ oder $\geq 320 \text{ HV}$) ist die Gefahr einer Wasserstoffversprödung (Sprüdrückgefahr) nicht mit Sicherheit auszuschließen (ISO 4042). Durch eine rechtzeitig eingeleitete thermische Nachbehandlung (Tempern) kann die Gefahr eines wasserstoffinduzierten Sprüdrückes im Regelfall verringert werden. Da aber ein Restrisiko nicht mit Sicherheit auszuschließen ist, erfolgen galvanische Überzüge auf derartigen Teilen nur auf ausdrücklichen Wunsch und auf Risiko des Auftraggebers.

DIN	00933.354
933	10.9
	f1Zn/TL480h

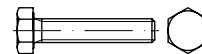

Sechskantschrauben mit Gewinde bis Kopf

TL = Schmierstoff im Topcoat mit $\mu = 0,09 - 0,14$, Korrosionsbeständigkeit NSS: 480h RR, Chrom(VI)-frei

Achtung! Gegenüber galv. verzinkt geänderte Anziehdrehmomente.

Maße → **TI-15** Anziehdrehmomente → **TI-24.5**
 Werkstoffeigensch. → **TI-232** Normumstellung → **TI-6**
 Korrosionsschutz → **TI-230**

Rostfrei → **S. 490**
 Messing, Kunststoff → **S. 625**

DIN 933 → wird ersetzt durch ISO 4017

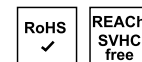

M 6 x 10	S	500	28,50 f1Zn
M 6 x 12	S	500	18,30 f1Zn
M 6 x 16	S	500	16,40 f1Zn
M 6 x 20	S	500	17,60 f1Zn
M 6 x 22	S	500	18,50 f1Zn
M 6 x 25	S	500	18,60 f1Zn
M 6 x 30	S	500	22,30 f1Zn

Abmessungen	VE	Stück	€/100/Obf.
M 12 x 50	S	100	365,00
M 12 x 60	S	100	395,00
M 14 x 35	S	100	280,00
M 14 x 40	S	100	440,00
M 14 x 50	S	50	630,00
M 16 x 30	S	50	315,00
M 16 x 35	S	50	340,00
M 16 x 40	S	50	360,00
M 16 x 45	S	50	385,00
M 16 x 50	S	50	395,00
M 16 x 60	S	50	495,00
M 16 x 70	S	25	520,00
M 16 x 80	S	25	560,00
M 16 x 90	S	25	610,00
M 16 x 100	S	25	670,00
M 20 x 40	S	25	395,00
M 20 x 45	S	25	480,00
M 20 x 50	S	25	560,00
M 20 x 55	S	25	630,00
M 20 x 60	S	25	680,00
M 20 x 70	S	25	730,00
M 20 x 80	S	25	770,00
M 20 x 90	S	25	790,00
M 20 x 100	S	25	880,00
M 24 x 60	S	25	1200,00
M 24 x 70	S	25	1260,00
M 24 x 80	S	25	1430,00
M 24 x 90	S	10	1470,00
M 24 x 100	S	10	1900,00

DIN 00934.300

934

1.7218* (KG)
25CrMo4

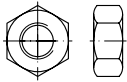

Sechskantmuttern mit Prüfbeschg. EN 10204/3.1 (3.1.B)

(Preise gelten zzgl. APZ-Kosten)
*Alternativ 1.7258 (24CrMo5)

Maße → **TI-62** Anziehmomente → **TI-245**
Werkstoffeigensch. → **TI-240** Normumstellung → **TI-7**

weitere Abmessungen als ISO 4032 verfügbar

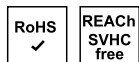

M 10	S	1	161,00
M 12	S	1	170,00



- ✓ Große Artikelvielfalt
- ✓ Verlässliche Qualität
- ✓ Hohe Lieferbereitschaft

Abmessungen VE Stück €/100/Obf.
DIN 00934.301

934

6 AU

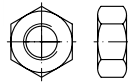

Sechskantmuttern

Maße → **TI-62** Normumstellung → **TI-7**
Werkstoffeigensch. → **TI-233** REACH → **TI-262**

Rostfrei → **S. 495**
Messing, Kupfer, Aluminium, Titan → **S. 626**

DIN 934 → wird ersetzt durch ISO 4032



M 1	K	100	226,00
M 1,2	K	100	148,00
M 1,4	K	100	153,00
M 1,6	K	100	102,00
M 1,7	K	100	99,00
M 2	S	1000	27,00
M 2	K	100	35,00
M 2,3	S	1000	17,70
M 2,5	S	1000	17,70
M 2,5	K	100	35,00
M 2,6	S	1000	29,00
M 2,6	K	100	35,00
M 3	S	1000	29,00
M 3	K	100	33,00
M 3,5	S	1000	30,50
M 3,5	K	100	34,00
M 4	S	1000	19,70
M 4	K	100	34,50
M 5	S	1000	26,00
M 5	K	100	43,00
M 6	S	1000	33,00
M 6	K	100	59,00
M 7	K	100	71,00
M 8	S	1000	64,00
M 8	K	100	89,00
M 10	S	500	106,00
M 10	K	100	138,00
M 12	S	250	151,00
M 12	K	100	184,00
M 14	S	250	226,00
M 14	K	100	265,00
M 16	S	100	335,00
M 18	S	50	510,00
M 20	S	50	630,00
M 22	S	50	760,00
M 24	S	25	1090,00
M 27	S	25	1750,00
M 30	S	10	2550,00
M 36	S	10	4300,00
M 39	S	1	5400,00
M 42	S	1	7100,00
M 45	S	1	8700,00
M 48	S	1	10400,00
M 52	S	1	12600,00
M 56	S	1	17200,00
M 60	S	1	20600,00
M 64	S	1	33900,00
M 68	S	1	38800,00

Abmessungen VE Stück €/100/Obf.
DIN 00934.305

934

6 AU

Fein

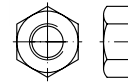

Sechskantmuttern mit metrischem Feingewinde

Maße → **TI-62** Normumstellung → **TI-7**
Werkstoffeigensch. → **TI-233** REACH → **TI-262**

DIN 934 Feingew. → wird ersetzt durch ISO 8673



M 8 x 1	S	100	101,00
M 10 x 1	S	100	163,00
M 10 x 1,25	S	100	163,00
M 12 x 1	S	100	211,00
M 12 x 1,25	S	100	211,00
M 12 x 1,5	S	100	211,00
M 14 x 1,5	S	100	305,00
M 16 x 1,5	S	100	390,00
M 18 x 1,5	S	50	590,00
M 18 x 2	S	50	590,00
M 20 x 1,5	S	50	740,00
M 20 x 2	S	50	740,00
M 22 x 1,5	S	25	990,00
M 22 x 2	S	25	990,00
M 24 x 1,5	S	25	1290,00
M 24 x 2	S	25	1290,00
M 26 x 1,5	S	25	2060,00
M 27 x 1,5	S	25	2060,00
M 27 x 2	S	25	2060,00
M 28 x 1,5	S	10	3000,00
M 30 x 1,5	S	10	3000,00
M 30 x 2	S	10	3000,00
M 32 x 1,5	S	10	4200,00
M 33 x 1,5	S	10	4200,00
M 33 x 2	S	10	4200,00
M 35 x 1,5	S	1	5000,00
M 36 x 1,5	S	1	5000,00
M 36 x 3	S	1	5000,00
M 38 x 1,5	S	1	6300,00
M 39 x 1,5	S	1	6300,00
M 39 x 3	S	1	6300,00
M 40 x 1,5	S	1	8400,00
M 42 x 1,5	S	1	8400,00
M 42 x 3	S	1	8400,00
M 45 x 1,5	S	1	10400,00
M 45 x 3	S	1	10400,00
M 48 x 1,5	S	1	12400,00
M 48 x 3	S	1	12400,00
M 50 x 1,5	S	1	3850,00
M 52 x 1,5	S	1	12300,00
M 52 x 3	S	1	15300,00
M 56 x 2	S	1	20600,00
M 56 x 4	S	1	20600,00
M 58 x 2	S	1	22200,00
M 60 x 2	S	1	24700,00
M 60 x 4	S	1	24700,00
M 64 x 2	S	1	40700,00
M 64 x 4	S	1	40700,00
M 68 x 2	S	1	10200,00
M 68 x 4	S	1	10200,00
M 72 x 2	S	1	12000,00
M 72 x 4	S	1	48000,00
M 72 x 6	S	1	45500,00
M 76 x 2	S	1	12600,00

Abmessungen	VE	Stück	€/100/Obf.
M 76 x 4	S	1	12600,00
M 76 x 6	S	1	48500,00
M 80 x 2	S	1	57200,00
M 80 x 4	S	1	57200,00
M 80 x 6	S	1	54300,00
M 85 x 2	S	1	16400,00
M 85 x 4	S	1	16400,00
M 85 x 6	S	1	15700,00
M 90 x 2	S	1	19400,00
M 90 x 4	S	1	19400,00
M 90 x 6	S	1	74100,00
M 95 x 2	S	1	26500,00
M 95 x 4	S	1	26500,00
M 95 x 6	S	1	25300,00
M 100 x 2	S	1	27900,00
M 100 x 4	S	1	111400,00
M 100 x 6	S	1	106000,00
M 110 x 4	S	1	37800,00
M 120 x 4	S	1	44000,00

DIN	00934.304
934	6 AU Links (≤ M 8 = 6/8)

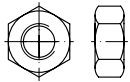

Sechskantmutter mit metrischem Linksgewinde

Maße → **TI-62** Normumstellung → **TI-7**
 Werkstoffeigensch. → **TI-233** REACH → **TI-262**

DIN 934 → wird ersetzt durch ISO 4032



M 4 -LH	S	100	119,00
M 5 -LH	S	100	119,00
M 6 -LH	S	100	119,00
M 8 -LH	S	100	124,00
M 10 -LH	S	100	187,00
M 12 -LH	S	100	230,00
M 14 -LH	S	50	385,00
M 16 -LH	S	50	495,00
M 18 -LH	S	50	700,00
M 20 -LH	S	50	930,00
M 22 -LH	S	25	1130,00
M 24 -LH	S	25	1460,00
M 27 -LH	S	10	2280,00
M 30 -LH	S	10	2950,00
M 36 -LH	S	5	5100,00
M 42 -LH	S	1	9100,00
M 48 -LH	S	1	14300,00

Abmessungen	VE	Stück	€/100/Obf.
DIN	00934.307		
934	6 AU Links-Fein		
	(≤ M 8 = 6/8)		

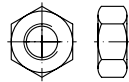

Sechskantmutter mit metrischem Links-Feingewinde

Maße → **TI-62** Normumstellung → **TI-7**
 Werkstoffeigensch. → **TI-233** REACH → **TI-262**

DIN 934 Feingew. → wird ersetzt durch ISO 8673



M 8 x 1 -LH	S	100	146,00
M 10 x 1 -LH	S	100	216,00
M 12 x 1,5 -LH	S	100	275,00
M 14 x 1,5 -LH	S	50	455,00
M 16 x 1,5 -LH	S	50	590,00
M 18 x 1,5 -LH	S	50	830,00
M 20 x 1,5 -LH	S	50	1100,00
M 22 x 1,5 -LH	S	25	1340,00
M 24 x 1,5 -LH	S	25	1700,00
M 24 x 2 -LH	S	25	1700,00
M 30 x 1,5 -LH	S	10	3400,00
M 30 x 2 -LH	S	10	3400,00

DIN	00934.306
934	6 AU Ww-BSW

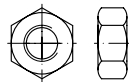

Sechskantmutter mit zölligem Whitworth-Regelgewinde

Maße → **TI-62** REACH → **TI-262**
 Werkstoffeigensch. → **TI-233**



Gewinde Ø

WW 1/4	S	100	64,00
WW 5/16	S	100	81,00
WW 3/8	S	100	129,00
WW 1/2	S	100	247,00
WW 5/8	S	50	470,00
WW 3/4	S	50	730,00
WW 7/8	S	25	1020,00
WW 1	S	25	1650,00
WW 1 1/8	S	10	2330,00
WW 1 1/4	S	10	3350,00
WW 1 1/2	S	1	5100,00
WW 1 3/4	S	1	8300,00
WW 2	S	1	12100,00

Abmessungen	VE	Stück	€/100/Obf.
DIN	00934.800		
934	8*		

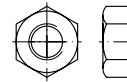

Sechskantmutter

*≤ M 5: Festigkeitsklasse = 6

Maße → **TI-62** Anziehmomente → **TI-244**
 Werkstoffeigensch. → **TI-233** Normumstellung → **TI-7**

Rostfrei → **S. 495**

Messing, Kupfer, Aluminium, Titan → **S. 626**

DIN 934 → wird ersetzt durch ISO 4032



M 2,5	S	1000	2,60
M 2,5	K	100	5,40
M 3	S	1000	1,70
M 3	K	100	4,45
M 4	S	1000	1,90
M 4	K	100	4,75
M 5	S	1000	2,45
M 5	K	100	5,30
M 6	S	1000	2,90
M 6	K	100	5,40
M 7	S	1000	4,70
M 7	K	100	7,20
M 8	S	1000	4,60
M 8	K	100	6,70
M 10	S	500	9,40
M 10	K	100	12,50
M 12	S	500	13,50
M 12	K	100	17,10
M 14	S	250	18,70
M 14	K	100	23,90
M 16	S	200	27,00
M 16	K	50	31,50
M 18	S	100	41,00
M 20	S	100	47,50
M 20	K	25	52,00
M 22	S	50	88,00
M 24	S	50	84,00
M 27	S	25	152,00
M 30	S	25	190,00
M 33	S	10	255,00
M 36	S	10	380,00
M 39	S	5	600,00
M 42	S	5	820,00
M 45	S	1	1050,00
M 48	S	1	1540,00
M 52	S	1	1810,00
M 56	S	1	3450,00
M 60	S	1	3950,00
M 64	S	1	4850,00

Abmessungen	VE Stück	€/100/Obf.
DIN	00934.810	
934	8*	galvanisch verzinkt

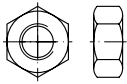

Sechskantmuttern

*≤ M 5: Festigkeitsklasse = 6

Maße → [TI-62](#) Anziehmomente → [TI-244](#)
 Werkstoffeigensch. → [TI-233](#) Normumstellung → [TI-7](#)
 Korrosionsschutz → [TI-228](#)

Rostfrei → [S. 495](#)
 Messing, Kupfer, Aluminium, Titan → [S. 626](#)

DIN 934 → wird ersetzt durch ISO 4032



M 2	S 1000	2,60 gal Zn
M 2	K 100	5,50 gal Zn
M 2,5	S 1000	2,70 gal Zn
M 2,5	K 100	5,50 gal Zn
M 3	S 1000	1,75 gal Zn
M 3	K 100	4,60 gal Zn
M 4	S 1000	2,15 gal Zn
M 4	K 100	4,95 gal Zn
M 5	S 1000	2,75 gal Zn
M 5	K 100	5,60 gal Zn
M 6	S 1000	3,45 gal Zn
M 6	K 100	6,00 gal Zn
M 7	S 1000	5,30 gal Zn
M 7	K 100	7,80 gal Zn
M 8	S 1000	5,50 gal Zn
M 8	K 100	7,70 gal Zn
M 10	S 500	11,40 gal Zn
M 10	K 100	14,70 gal Zn
M 12	S 500	16,40 gal Zn
M 12	K 100	20,30 gal Zn
M 14	S 250	22,90 gal Zn
M 14	K 100	28,50 gal Zn
M 16	S 200	33,00 gal Zn
M 16	K 50	38,50 gal Zn
M 18	S 100	48,50 gal Zn
M 20	S 100	58,00 gal Zn
M 20	K 25	74,00 gal Zn
M 22	S 50	84,00 gal Zn
M 24	S 50	99,00 gal Zn
M 27	S 50	180,00 gal Zn
M 30	S 25	227,00 gal Zn
M 33	S 1	300,00 gal Zn
M 36	S 1	420,00 gal Zn
M 39	S 1	680,00 gal Zn
M 42	S 1	910,00 gal Zn
M 45	S 1	1150,00 gal Zn
M 48	S 1	1720,00 gal Zn
M 52	S 1	2010,00 gal Zn
M 56	S 1	3800,00 gal Zn
M 60	S 1	5100,00 gal Zn
M 64	S 1	5300,00 gal Zn
M 68	S 1	6700,00 gal Zn

Abmessungen	VE Stück	€/100/Obf.
Artikel	82934.810	
82934	Sortiment	DIN 934
	6/8 galv. verz.	



Sechskantmuttern-Sortiment DIN 934

Inhalt: 12 gängige Abmessungen
 M 3 - M 24, ca. 645 Stück
 (Metall-Koffer)

Wunschsortiment auf Anfrage



DIN 934 8	S 1	9000,00
-----------	-----	---------

Artikel	82935.810	
82935	Sortiment	DIN 934 R/F
	6/8 galv. verz.	



Muttern-Sortiment, Regel-/Feingewinde

Inhalt: 8 Abmessungen RG M 4 - M 16
 4 Abmessungen FG M 10 x 1 - M 16 x 1,5,
 ca. 640 Stück, (Metall-Koffer)

Wunschsortierung auf Anfrage



DIN 934 8	S 1	10800,00
-----------	-----	----------

DIN	00934.337	
934	8*	galv. verz. 8 DiSP**

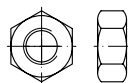

Sechskantmuttern

*≤ M 5: Festigkeitsklasse = 6,
 **< M 6 Mindestschichtdicke 5µm,
 Korrosionsbeständigkeit NSS: 72h WR, 120h RR

Maße → [TI-62](#) Anziehmomente → [TI-244](#)
 Werkstoffeigensch. → [TI-233](#) Normumstellung → [TI-7](#)
 Korrosionsschutz → [TI-228](#)

Rostfrei → [S. 495](#)
 Messing, Kupfer, Aluminium, Titan → [S. 626](#)

DIN 934 → wird ersetzt durch ISO 4032



M 2,5	S 1000	3,55 gal ZnDi
M 3	S 1000	2,30 gal ZnDi

Abmessungen	VE Stück	€/100/Obf.
M 3	K 100	6,00 gal ZnDi
M 4	S 1000	2,85 gal ZnDi
M 4	K 100	6,70 gal ZnDi
M 5	S 1000	3,60 gal ZnDi
M 5	K 100	7,80 gal ZnDi
M 6	S 1000	4,70 gal ZnDi
M 6	K 100	9,10 gal ZnDi
M 8	S 1000	7,50 gal ZnDi
M 8	K 100	11,90 gal ZnDi
M 10	S 500	15,40 gal ZnDi
M 10	K 100	23,40 gal ZnDi
M 12	S 500	22,20 gal ZnDi
M 12	K 100	32,50 gal ZnDi
M 14	S 100	39,00 gal ZnDi
M 16	S 200	45,00 gal ZnDi
M 16	K 50	62,00 gal ZnDi
M 20	S 100	78,00 gal ZnDi
M 20	K 25	120,00 gal ZnDi
M 24	S 50	130,00 gal ZnDi
M 30	S 25	315,00 gal ZnDi
M 36	S 10	520,00 gal ZnDi

DIN	00934.428	
934	8	galv. verz. 8 DiSP + SL*

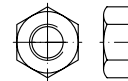

Sechskantmuttern

* SL = Sealer and Lubrication
 (Versiegelung und Schmierung mit $\mu = 0,12 - 0,18$),
 Korrosionsbeständigkeit NSS: 120h WR, 264h RR

Maße → [TI-62](#) Anziehmomente → [TI-244](#)
 Werkstoffeigensch. → [TI-233](#) Normumstellung → [TI-7](#)
 Korrosionsschutz → [TI-228](#)

Rostfrei → [S. 495](#)
 Messing, Kupfer, Aluminium, Titan → [S. 626](#)

DIN 934 → wird ersetzt durch ISO 4032
 weitere Abmessungen als ISO 4032 vorrätig

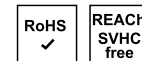

M 10	S 500	17,70 gal ZnDi
M 12	S 500	28,20 gal ZnDi
M 14	S 100	37,50 gal ZnDi

Abmessungen	VE Stück	€/100/Obf.
DIN	00934.820	
934	8	feuerverzinkt

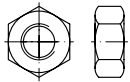

Sechskantmuttern

Gewindetoleranz 6H

Achtung! Warneinblender zu Feuerverzinkung beachten.

Maße → **TI-62** Anziehmomente → **TI-244**
 Werkstoffeigensch. → **TI-233** Normumstellung → **TI-7**
 Korrosionsschutz → **TI-231**

Rostfrei → **S. 495**
 Messing, Kupfer, Aluminium, Titan → **S. 626**

DIN 934 → wird ersetzt durch ISO 4032



M 6	S	1000	6,30 tzn
M 6	K	100	9,60 tzn
M 8	S	1000	11,50 tzn
M 8	K	100	15,00 tzn
M 10	S	500	20,30 tzn
M 10	K	100	26,00 tzn
M 12	S	500	28,00 tzn
M 12	K	100	34,00 tzn
M 14	S	250	48,00 tzn
M 16	S	200	54,00 tzn
M 16	K	50	60,00 tzn
M 18	S	50	103,00 tzn
M 20	S	100	96,00 tzn
M 20	K	25	106,00 tzn
M 22	S	50	181,00 tzn
M 24	S	50	160,00 tzn
M 27	S	25	295,00 tzn
M 30	S	25	365,00 tzn
M 33	S	10	495,00 tzn
M 36	S	10	630,00 tzn
M 39	S	5	1140,00 tzn
M 42	S	5	1580,00 tzn
M 45	S	1	2050,00 tzn
M 48	S	1	2410,00 tzn
M 52	S	1	3650,00 tzn
M 56	S	1	5600,00 tzn
M 64	S	1	7200,00 tzn

Abmessungen	VE Stück	€/100/Obf.
DIN	00934.830	
934	8*	galvanisch vernickelt

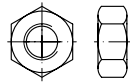

Sechskantmuttern

* ≤ M 5: Festigkeitsklasse = 6

Maße → **TI-62** Anziehmomente → **TI-244**
 Werkstoffeigensch. → **TI-233** Normumstellung → **TI-7**
 Korrosionsschutz → **TI-228**

Rostfrei → **S. 495**
 Messing, Kupfer, Aluminium, Titan → **S. 626**

DIN 934 → wird ersetzt durch ISO 4032



M 3	S	1000	2,25 gal Ni
M 4	S	1000	2,75 gal Ni
M 5	S	1000	3,65 gal Ni
M 6	S	1000	4,85 gal Ni
M 8	S	1000	9,50 gal Ni
M 10	S	500	19,40 gal Ni

Abmessungen	VE Stück	€/100/Obf.
DIN	00934.835	
934	8	schwarz* Fein

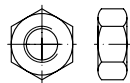

Sechskantmuttern mit metrischem Feingewinde

* ≤ M 22 x 1,5 = grau-schwarz

Maße → **TI-62** Anziehmomente → **TI-244**
 Werkstoffeigensch. → **TI-233** Normumstellung → **TI-7**

DIN 934 Feingew. → wird ersetzt durch ISO 8673



M 8	x 1	S	100	15,30 schwarz
M 10	x 1	S	100	23,50 schwarz
M 12	x 1	S	100	63,00 schwarz
M 12	x 1,25	S	100	33,50 schwarz
M 12	x 1,5	S	100	30,50 schwarz
M 14	x 1,5	S	100	53,00 schwarz
M 16	x 1,5	S	100	66,00 schwarz
M 18	x 1,5	S	100	92,00 schwarz
M 18	x 2	S	100	101,00 schwarz
M 20	x 1,5	S	50	107,00 schwarz
M 20	x 2	S	50	107,00 schwarz
M 22	x 1,5	S	50	113,00 schwarz
M 22	x 2	S	50	113,00 schwarz
M 24	x 1,5	S	50	136,00 schwarz
M 24	x 2	S	50	136,00 schwarz
M 27	x 1,5	S	50	233,00 schwarz
M 27	x 2	S	50	233,00 schwarz
M 30	x 1,5	S	1	315,00 schwarz
M 30	x 2	S	1	315,00 schwarz
M 33	x 2	S	1	380,00 schwarz
M 36	x 1,5	S	1	790,00 schwarz
M 36	x 2	S	1	790,00 schwarz

Abmessungen	VE Stück	€/100/Obf.		
M 36	x 3	S	1	790,00 schwarz
M 39	x 3	S	1	950,00 schwarz
M 42	x 1,5	S	1	1360,00 schwarz
M 42	x 3	S	1	1260,00 schwarz
M 45	x 3	S	1	1320,00 schwarz
M 48	x 1,5	S	1	3000,00 schwarz
M 48	x 3	S	1	1820,00 schwarz
M 52	x 3	S	1	2850,00 schwarz
M 56	x 4	S	1	3900,00 schwarz
M 60	x 4	S	1	5200,00 schwarz
M 64	x 4	S	1	6100,00 schwarz
M 68	x 4	S	1	7900,00 schwarz
M 72	x 4	S	1	9400,00 schwarz
M 72	x 6	S	1	8300,00 schwarz
M 80	x 4	S	1	13800,00 schwarz
M 80	x 6	S	1	11500,00 schwarz
M 100	x 6	S	1	25200,00 schwarz

Abmessungen	VE Stück	€/100/Obf.
DIN	00934.815	
934	8	galvanisch verzinkt Fein

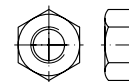

Sechskantmuttern mit metrischem Feingewinde

Maße → **TI-62** Anziehmomente → **TI-244**
 Werkstoffeigensch. → **TI-233** Normumstellung → **TI-7**
 Korrosionsschutz → **TI-228**

DIN 934 Feingew. → wird ersetzt durch ISO 8673

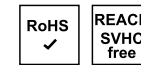

M 8	x 1	S	1000	9,70 gal Zn
M 8	x 1	K	100	12,80 gal Zn
M 10	x 1	S	500	17,10 gal Zn
M 10	x 1	K	100	20,40 gal Zn
M 10	x 1,25	S	500	21,20 gal Zn
M 10	x 1,25	K	100	25,50 gal Zn
M 12	x 1	S	500	31,50 gal Zn
M 12	x 1,25	S	100	29,50 gal Zn
M 12	x 1,5	S	500	23,40 gal Zn
M 12	x 1,5	K	100	26,50 gal Zn
M 14	x 1,25	S	100	97,00 gal Zn
M 14	x 1,5	S	250	41,50 gal Zn
M 14	x 1,5	K	100	44,50 gal Zn
M 16	x 1,5	S	100	57,00 gal Zn
M 18	x 1,5	S	100	82,00 gal Zn
M 18	x 2	S	100	86,00 gal Zn
M 20	x 1,5	S	50	95,00 gal Zn
M 20	x 2	S	50	101,00 gal Zn
M 22	x 1,5	S	50	121,00 gal Zn
M 22	x 2	S	50	121,00 gal Zn
M 24	x 1,5	S	50	153,00 gal Zn
M 24	x 2	S	50	153,00 gal Zn
M 27	x 1,5	S	50	365,00 gal Zn
M 27	x 2	S	50	365,00 gal Zn
M 30	x 1,5	S	1	345,00 gal Zn
M 30	x 2	S	1	345,00 gal Zn
M 33	x 2	S	1	550,00 gal Zn
M 36	x 1,5	S	1	840,00 gal Zn
M 36	x 2	S	1	840,00 gal Zn
M 36	x 3	S	1	840,00 gal Zn
M 39	x 3	S	1	1340,00 gal Zn
M 42	x 3	S	1	1340,00 gal Zn
M 45	x 3	S	1	2180,00 gal Zn
M 48	x 1,5	S	1	3050,00 gal Zn
M 48	x 2	S	1	3650,00 gal Zn

Achtung!

Feuerverzinkte Schrauben-/Muttern-Garnituren dürfen nur miteinander verschraubt werden, wenn Gewindenspiel/-Toleranzen dieser Garnituren entsprechend ISO 10684 passend aufeinander abgestimmt sind.

Die Verwendung mit anderen Schrauben-/Muttern-Ausführungen kann zu Verschraubungsproblemen und/oder zum Versagen der Verbindung führen.

Abmessungen	VE	Stück	€/100/Obf.
M 48 x 3	S	1	1990,00 gal Zn
M 52 x 3	S	1	4250,00 gal Zn
M 72 x 6	S	1	7700,00 gal Zn

DIN	00934.804
-----	-----------

934

8

Links

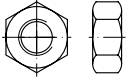

Sechskantmuttern mit metrischem Linksgewinde

Maße → [TI-62](#) Anziehmomente → [TI-244](#)
 Werkstoffeigensch. → [TI-233](#) Normumstellung → [TI-7](#)

DIN 934 → wird ersetzt durch ISO 4032



M 6 -LH	S	100	9,20
M 8 -LH	S	100	11,50
M 10 -LH	S	100	18,80
M 12 -LH	S	100	28,00
M 16 -LH	S	50	63,00
M 20 -LH	S	50	91,00
M 24 -LH	S	50	207,00
M 30 -LH	S	25	345,00

DIN	00934.814
-----	-----------

934

8

galvanisch verzinkt Links

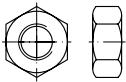

Sechskantmuttern mit metrischem Linksgewinde

Maße → [TI-62](#) Anziehmomente → [TI-244](#)
 Werkstoffeigensch. → [TI-233](#) Normumstellung → [TI-7](#)
 Korrosionsschutz → [TI-228](#)

DIN 934 → wird ersetzt durch ISO 4032

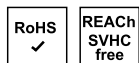

M 4 -LH	S	100	8,40 gal Zn
M 5 -LH	S	100	8,40 gal Zn
M 6 -LH	S	100	10,20 gal Zn
M 8 -LH	S	100	12,80 gal Zn
M 10 -LH	S	100	21,00 gal Zn
M 12 -LH	S	100	31,50 gal Zn
M 16 -LH	S	50	72,00 gal Zn
M 20 -LH	S	50	102,00 gal Zn
M 24 -LH	S	50	230,00 gal Zn
M 30 -LH	S	25	390,00 gal Zn
M 36 -LH	S	1	1150,00 gal Zn
M 39 -LH	S	1	2120,00 gal Zn
M 42 -LH	S	1	2700,00 gal Zn
M 48 -LH	S	1	4250,00 gal Zn

Abmessungen	VE	Stück	€/100/Obf.
-------------	----	-------	------------

934

10

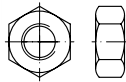

Sechskantmuttern

Maße → [TI-62](#) Anziehmomente → [TI-244](#)
 Werkstoffeigensch. → [TI-233](#) Normumstellung → [TI-7](#)

Rostfrei → [S. 495](#)
 Messing, Kupfer, Aluminium, Titan → [S. 626](#)

DIN 934 → wird ersetzt durch ISO 4032

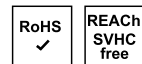

M 4	S	1000	6,20
M 4	K	100	8,80
M 5	S	1000	6,20
M 5	K	100	8,80
M 6	S	1000	6,90
M 6	K	100	9,50
M 8	S	1000	9,50
M 8	K	100	12,10
M 10	S	500	17,20
M 10	K	100	21,30
M 12	S	500	27,50
M 12	K	100	33,00
M 14	S	100	44,50
M 16	S	100	54,00
M 18	S	100	79,00
M 20	S	50	84,00
M 22	S	50	124,00
M 24	S	50	137,00
M 27	S	50	190,00
M 30	S	10	295,00
M 33	S	10	390,00
M 36	S	10	510,00
M 39	S	1	860,00
M 42	S	1	1310,00
M 45	S	1	1610,00
M 48	S	1	1870,00
M 52	S	1	3700,00

DIN	00934.110
-----	-----------

934

10

galvanisch verzinkt

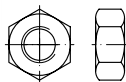

Sechskantmuttern

Maße → [TI-62](#) Anziehmomente → [TI-244](#)
 Werkstoffeigensch. → [TI-233](#) Normumstellung → [TI-7](#)
 Korrosionsschutz → [TI-228](#)

Rostfrei → [S. 495](#)
 Messing, Kupfer, Aluminium, Titan → [S. 626](#)

DIN 934 → wird ersetzt durch ISO 4032

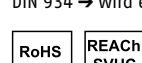

M 4	S	1000	6,80 gal Zn
M 4	K	100	9,40 gal Zn

Abmessungen	VE	Stück	€/100/Obf.
-------------	----	-------	------------

M 5	S	1000	6,80 gal Zn
M 5	K	100	9,40 gal Zn
M 6	S	1000	7,60 gal Zn
M 6	K	100	10,20 gal Zn
M 8	S	1000	10,60 gal Zn
M 8	K	100	13,40 gal Zn
M 10	S	500	19,80 gal Zn
M 10	K	100	24,20 gal Zn
M 12	S	500	31,50 gal Zn
M 12	K	100	38,00 gal Zn
M 14	S	100	51,00 gal Zn
M 16	S	100	62,00 gal Zn
M 18	S	100	87,00 gal Zn
M 20	S	50	97,00 gal Zn
M 22	S	50	134,00 gal Zn
M 24	S	50	163,00 gal Zn
M 27	S	50	200,00 gal Zn
M 30	S	10	345,00 gal Zn
M 33	S	10	500,00 gal Zn
M 36	S	10	620,00 gal Zn
M 39	S	1	990,00 gal Zn
M 42	S	5	1470,00 gal Zn
M 48	S	1	1470,00 gal Zn
M 52	S	1	3900,00 gal Zn

DIN 934

Muttern mit weiteren Oberflächenbeschichtungen

Muttern der Festigkeitsklasse 10 mit Feuerverzinkung und Zinklamellenbeschichtung

→ ISO 4032

DIN	00934.105
-----	-----------

934

10

Fein

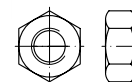

Sechskantmuttern mit metrischem Feingewinde

Maße → [TI-62](#) Anziehmomente → [TI-244](#)
 Werkstoffeigensch. → [TI-233](#) Normumstellung → [TI-7](#)

DIN 934 Feingew. → wird ersetzt durch ISO 8673

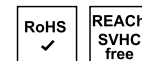

M 8	x	1	S	100	16,40
M 10	x	1	S	100	26,00
M 12	x	1,5	S	100	41,50
M 14	x	1,5	S	100	56,00
M 16	x	1,5	S	100	79,00
M 18	x	1,5	S	100	103,00
M 18	x	2	S	100	103,00
M 20	x	1,5	S	50	121,00
M 20	x	2	S	50	121,00
M 22	x	1,5	S	25	172,00
M 22	x	2	S	25	172,00
M 24	x	1,5	S	25	192,00
M 24	x	2	S	25	192,00

Abmessungen	VE	Stück	€/100/Obf.
M 30 x 1,5	S	10	425,00
M 30 x 2	S	10	425,00
M 36 x 3	S	1	590,00
M 42 x 3	S	1	1430,00
M 48 x 3	S	1	2650,00

DIN	00934.115	
934	10	Fein
galvanisch verzinkt		

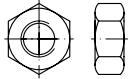

Sechskantmuttern mit metrischem Feingewinde

Maße → **TI-62** Anziehungsmomente → **TI-244**
 Werkstoffeigensch. → **TI-233** Normumstellung → **TI-7**
 Korrosionsschutz → **TI-228**

DIN 934 Feingew. → wird ersetzt durch ISO 8673

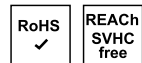

M 8 x 1	S	100	25,50 gal Zn
M 10 x 1	S	100	35,50 gal Zn
M 12 x 1,5	S	100	51,00 gal Zn
M 14 x 1,5	S	100	62,00 gal Zn
M 16 x 1,5	S	100	97,00 gal Zn
M 18 x 1,5	S	100	121,00 gal Zn
M 18 x 2	S	100	121,00 gal Zn
M 20 x 1,5	S	50	148,00 gal Zn
M 20 x 2	S	25	148,00 gal Zn
M 24 x 1,5	S	50	230,00 gal Zn
M 24 x 2	S	25	230,00 gal Zn
M 30 x 1,5	S	10	485,00 gal Zn
M 30 x 2	S	10	485,00 gal Zn
M 36 x 3	S	1	660,00 gal Zn
M 42 x 3	S	1	1580,00 gal Zn
M 48 x 3	S	1	2750,00 gal Zn

DIN	00934.200
-----	-----------

934 12

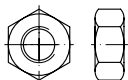

Sechskantmuttern

Maße → **TI-62** Anziehungsmomente → **TI-244**
 Werkstoffeigensch. → **TI-233** Normumstellung → **TI-7**

Rostfrei → **S. 495**
 Messing, Kupfer, Aluminium, Titan → **S. 626**

DIN 934 → wird ersetzt durch ISO 4032

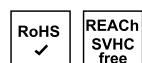

M 6	S	100	16,50
M 8	S	100	23,20
M 10	S	100	41,50
M 12	S	100	59,00
M 16	S	100	86,00
M 20	S	50	172,00
M 24	S	25	305,00
M 27	S	25	570,00

Abmessungen	VE	Stück	€/100/Obf.
M 30	S	10	860,00
M 36	S	10	1250,00
M 42	S	1	2300,00

DIN	00935.300
-----	-----------

935-1 6/6 AU

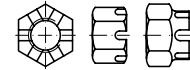

Kronenmuttern

Maße → **TI-67** REACH → **TI-262**
 Werkstoffeigensch. → **TI-233**

Rostfrei → **S. 497**



M 4	K	100	320,00
M 5	K	100	78,00
M 6	S	500	53,00
M 6	K	100	59,00
M 8	S	500	53,00
M 8	K	100	60,00
M 10 SW 17	S	500	56,00
M 10 SW 17	K	100	66,00
M 12 SW 19	S	500	88,00
M 12 SW 19	K	100	97,00
M 14 SW 22	K	50	135,00
M 16	S	250	136,00
M 16	K	50	154,00
M 18	K	25	207,00
M 20	K	25	246,00
M 22 SW 32	S	25	315,00
M 24	S	25	410,00
M 27	S	10	610,00
M 30	S	10	770,00
M 33	S	5	1030,00
M 36	S	1	1360,00
M 39	S	1	1700,00
M 42	S	1	2270,00
M 45	S	1	2750,00
M 48	S	1	3800,00
M 52	S	1	4400,00
M 56	S	1	6500,00
M 60	S	1	7400,00
M 64	S	1	9100,00

Abmessungen	VE	Stück	€/100/Obf.
DIN	00935.305		

935-1 6/6 AU Fein

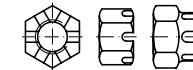

Kronenmuttern mit metrischem Feingewinde

Maße → **TI-67** REACH → **TI-262**
 Werkstoffeigensch. → **TI-233**



M 8 x 1	S	100	69,00
M 10 x 1 SW 17	S	100	77,00
M 10 x 1,25 SW 17	S	100	77,00
M 12 x 1,25 SW 19	S	100	114,00
M 12 x 1,5 SW 19	S	100	114,00
M 14 x 1,5 SW 22	S	50	157,00
M 16 x 1,5	S	50	181,00
M 18 x 1,5	S	25	242,00
M 20 x 1,5	S	25	290,00
M 20 x 2	S	25	290,00
M 22 x 1,5 SW 32	S	25	370,00
M 22 x 2 SW 32	S	25	740,00
M 24 x 1,5	S	25	480,00
M 24 x 2	S	25	480,00
M 27 x 1,5	S	10	740,00
M 27 x 2	S	10	740,00
M 28 x 1,5	S	10	920,00
M 30 x 1,5	S	1	920,00
M 30 x 2	S	1	920,00
M 32 x 1,5	S	1	1230,00
M 33 x 1,5	S	1	1230,00
M 33 x 2	S	1	1230,00
M 36 x 1,5	S	1	1630,00
M 36 x 3	S	1	1630,00
M 38 x 1,5	S	1	2030,00
M 39 x 3	S	1	2030,00
M 40 x 1,5	S	1	2750,00
M 42 x 1,5	S	1	2750,00
M 42 x 3	S	1	2750,00
M 45 x 1,5	S	1	3350,00
M 45 x 3	S	1	3350,00
M 48 x 1,5	S	1	4450,00
M 48 x 3	S	1	4450,00
M 52 x 3	S	1	5300,00
M 56 x 2	S	1	7800,00
M 56 x 4	S	1	7800,00
M 64 x 2	S	1	10800,00
M 64 x 4	S	1	10800,00
M 68 x 2	S	1	18400,00
M 72 x 4	S	1	20100,00
M 72 x 6	S	1	19200,00
M 76 x 4	S	1	34000,00
M 80 x 4	S	1	27400,00
M 80 x 6	S	1	26200,00

Abmessungen VE Stück €/100/Obf.
 DIN 00935.800

935-1⁸

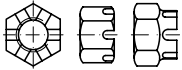

Kronenmuttern

Maße → [TI-67](#) Werkstoffeigensch. → [TI-233](#)
 Rostfrei → [S. 497](#)

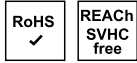

M 12 SW 19	S 100	76,00
M 16	S 50	91,00
M 20	S 25	164,00
M 24	S 25	232,00
M 30	S 10	600,00
M 36	S 1	1430,00
M 39	S 1	1660,00
M 42	S 1	1810,00
M 48	S 1	3450,00

DIN 00935.810

935-1⁸ galvanisch verzinkt

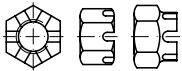

Kronenmuttern

Maße → [TI-67](#) Korrosionsschutz → [TI-228](#)
 Werkstoffeigensch. → [TI-233](#)
 Rostfrei → [S. 497](#)

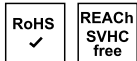

M 8	S 100	69,00 gal Zn
M 10 SW 17	S 100	76,00 gal Zn
M 12 SW 19	S 100	91,00 gal Zn
M 14 SW 21	S 50	242,00 gal Zn
M 16	S 50	106,00 gal Zn
M 20	S 25	167,00 gal Zn
M 24	S 25	242,00 gal Zn
M 30	S 10	620,00 gal Zn
M 36	S 1	1820,00 gal Zn
M 39	S 1	2420,00 gal Zn
M 42	S 1	2700,00 gal Zn
M 48	S 1	4500,00 gal Zn

Abmessungen VE Stück €/100/Obf.
 DIN 00935.100

935-1¹⁰

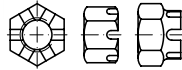

Kronenmuttern

Maße → [TI-67](#) Werkstoffeigensch. → [TI-233](#)
 Rostfrei → [S. 497](#)

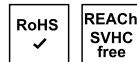

M 12 SW 19	S 100	136,00
M 16	S 50	167,00
M 20	S 25	265,00
M 24	S 25	610,00

DIN 00936.000

936^{14 H}

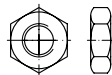

Sechskantmuttern, niedrige Form

Maße → [TI-63](#) Normumstellung → [TI-7](#)
 Werkstoffeigensch. → [TI-233](#) REACH → [TI-262](#)

Rostfrei → [S. 497](#)
 Messing → [S. 627](#)
 Muttern nach ISO → ISO 4035 (DIN 439)



M 33	S 10	720,00
M 36	S 10	760,00
M 39	S 10	920,00
M 42	S 1	1180,00
M 48	S 1	1800,00
M 52	S 1	2070,00

Abmessungen VE Stück €/100/Obf.
 DIN 00936.800

936^{17 H}

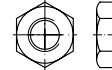

Sechskantmuttern, niedrige Form

Maße → [TI-63](#) Normumstellung → [TI-7](#)
 Werkstoffeigensch. → [TI-233](#) REACH → [TI-262](#)

Rostfrei → [S. 497](#)
 Messing → [S. 627](#)

Muttern nach ISO → ISO 4035 (DIN 439)



M 8	S 1000	7,40
M 8	K 100	11,40
M 10	S 500	14,10
M 10	K 100	19,00
M 12	S 500	20,00
M 12	K 100	25,00
M 14	S 100	42,00
M 16	S 100	48,00
M 18	S 100	84,00
M 20	S 50	103,00
M 22	S 50	147,00
M 24	S 50	174,00
M 27	S 25	240,00
M 30	S 25	325,00
M 36	S 10	415,00

DIN 00936.810

936^{17 H} galvanisch verzinkt

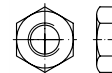

Sechskantmuttern, niedrige Form

Maße → [TI-63](#) Normumstellung → [TI-7](#)
 Werkstoffeigensch. → [TI-233](#) REACH → [TI-262](#)
 Korrosionsschutz → [TI-228](#)

Rostfrei → [S. 497](#)
 Messing → [S. 627](#)

Muttern nach ISO → ISO 4035 (DIN 439)



M 8	S 1000	8,40 gal Zn
M 8	K 100	12,40 gal Zn
M 10	S 500	16,00 gal Zn
M 10	K 100	21,10 gal Zn
M 12	S 500	22,70 gal Zn
M 12	K 100	28,00 gal Zn
M 14	S 100	46,00 gal Zn
M 16	S 100	53,00 gal Zn
M 18	S 100	91,00 gal Zn
M 20	S 50	112,00 gal Zn
M 22	S 50	158,00 gal Zn

Abmessungen	VE	Stück	€/100/Obf.
M 24	S	50	190,00 gal Zn
M 27	S	25	260,00 gal Zn
M 30	S	25	345,00 gal Zn
M 36	S	10	440,00 gal Zn

DIN	00936.352
936	17 H flZn/TL480h

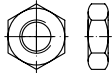

Sechskantmuttern, niedrige Form

TL = Schmierstoff im Topcoat mit $\mu = 0,09 - 0,14$, Korrosionsbeständigkeit NSS: 480h RR, Chrom(VI)-frei

Achtung! Gegenüber galv. verzinkt geänderte Anziehdrehmomente.

Maße → **TI-63** Normumstellung → **TI-7**
 Werkstoffeigensch. → **TI-233** REACH → **TI-262**
 Korrosionsschutz → **TI-230**
 Rostfrei → **S. 497**
 Messing → **S. 627**

Muttern nach ISO → ISO 4035 (DIN 439)



M 8	S	1000	10,90 flZn
M 10	S	500	21,00 flZn
M 12	S	500	30,00 flZn
M 16	S	100	69,00 flZn
M 20	S	50	146,00 flZn
M 24	S	50	249,00 flZn

DIN	00936.005
936	14 H Fein

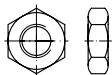

Sechskantmuttern, niedrige Form, mit metrischem Feingewinde

Maße → **TI-63** Normumstellung → **TI-7**
 Werkstoffeigensch. → **TI-233** REACH → **TI-262**
 Rostfrei → **S. 498**
 Messing → **S. 627**

Muttern nach ISO → ISO 8675 (DIN 439)



M 8	x 1	S	100	24,90
M 10	x 1	S	100	38,50
M 10	x 1,25	S	100	38,50
M 12	x 1	S	100	51,00
M 12	x 1,25	S	100	51,00
M 12	x 1,5	S	100	51,00
M 14	x 1,5	S	100	68,00
M 16	x 1,5	S	50	94,00
M 18	x 1,5	S	50	121,00
M 20	x 1,5	S	50	146,00
M 20	x 2	S	50	146,00
M 22	x 1,5	S	50	172,00

Abmessungen	VE	Stück	€/100/Obf.
M 24 x 1,5	S	25	235,00
M 24 x 2	S	25	235,00
M 26 x 1,5	S	25	395,00
M 27 x 1,5	S	25	395,00
M 27 x 2	S	25	395,00
M 28 x 1,5	S	25	530,00
M 30 x 1,5	S	25	530,00
M 30 x 2	S	25	530,00
M 32 x 1,5	S	1	730,00
M 33 x 1,5	S	1	730,00
M 33 x 2	S	1	730,00
M 35 x 1,5	S	1	780,00
M 36 x 1,5	S	1	780,00
M 36 x 2	S	1	780,00
M 36 x 3	S	1	780,00
M 38 x 1,5	S	1	1310,00
M 39 x 3	S	1	1110,00
M 40 x 1,5	S	1	1410,00
M 42 x 1,5	S	1	1410,00
M 42 x 3	S	1	1410,00
M 45 x 1,5	S	1	1670,00
M 45 x 3	S	1	1670,00
M 48 x 1,5	S	1	2150,00
M 48 x 3	S	1	2150,00
M 50 x 1,5	S	1	2500,00
M 52 x 3	S	1	2500,00

DIN	00936.004
936	14 H Links

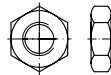

Sechskantmuttern, niedrige Form, mit metrischem Linksgewinde

Maße → **TI-63** Normumstellung → **TI-7**
 Werkstoffeigensch. → **TI-233** REACH → **TI-262**

Muttern nach ISO → ISO 4035 (DIN 439)



M 8 -LH	S	100	30,50
M 10 -LH	S	100	47,00
M 12 -LH	S	100	57,00
M 14 -LH	S	100	84,00
M 16 -LH	S	50	107,00
M 20 -LH	S	50	175,00
M 24 -LH	S	25	275,00
M 30 -LH	S	10	495,00

Abmessungen	VE	Stück	€/100/Obf.
DIN	00936.014		
936	14 H	Links	galvanisch verzinkt

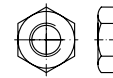

Sechskantmuttern, niedrige Form, mit metrischem Linksgewinde

Maße → **TI-63** Normumstellung → **TI-7**
 Werkstoffeigensch. → **TI-233** REACH → **TI-262**
 Korrosionsschutz → **TI-228**

Muttern nach ISO → ISO 4035 (DIN 439)



M 10 -LH	S	100	121,00 gal Zn
M 12 -LH	S	100	146,00 gal Zn
M 16 -LH	S	50	182,00 gal Zn
M 20 -LH	S	50	242,00 gal Zn
M 24 -LH	S	25	460,00 gal Zn
M 27 -LH	S	25	550,00 gal Zn
M 30 -LH	S	10	730,00 gal Zn

DIN	00936.006
936	14 H Links-Fein

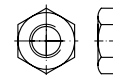

Sechskantmuttern, niedrige Form, mit metrischem Links-Feingewinde

Maße → **TI-63** Normumstellung → **TI-7**
 Werkstoffeigensch. → **TI-233** REACH → **TI-262**

Muttern nach ISO → ISO 8675 (DIN 439)



M 8	x 1 -LH	S	100	36,00
M 10	x 1 -LH	S	100	108,00
M 12	x 1,5 -LH	S	100	67,00
M 14	x 1,5 -LH	S	100	99,00
M 16	x 1,5 -LH	S	50	126,00
M 18	x 1,5 -LH	S	50	195,00
M 20	x 1,5 -LH	S	50	207,00
M 22	x 1,5 -LH	S	25	265,00
M 24	x 1,5 -LH	S	25	330,00
M 24	x 2 -LH	S	25	330,00
M 27	x 2 -LH	S	25	480,00
M 30	x 1,5 -LH	S	10	590,00

Abmessungen	VE Stück	€/100/Obf.
DIN	00936.805	

936

17 H

Fein

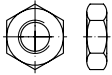

Sechskantmutter, niedrige Form, mit metrischem Feingewinde

Maße → [TI-63](#) Normumstellung → [TI-7](#)
 Werkstoffeigensch. → [TI-233](#) REACH → [TI-262](#)

Rostfrei → [S. 498](#)
 Messing → [S. 627](#)

Muttern nach ISO → ISO 8675 (DIN 439)



M 8	x 1	S	100	13,40
M 10	x 1	S	100	19,00
M 12	x 1,5	S	100	28,00
M 14	x 1,5	S	100	44,00
M 16	x 1,5	S	100	51,00
M 18	x 1,5	S	100	85,00
M 20	x 1,5	S	50	107,00
M 22	x 1,5	S	50	147,00
M 24	x 1,5	S	50	174,00
M 24	x 2	S	50	192,00
M 30	x 1,5	S	25	385,00
M 30	x 2	S	25	390,00
M 36	x 1,5	S	10	415,00

DIN	00936.815
936	17 H Fein
	galvanisch verzinkt

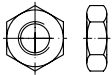

Sechskantmutter, niedrige Form, mit metrischem Feingewinde

Maße → [TI-63](#) Normumstellung → [TI-7](#)
 Werkstoffeigensch. → [TI-233](#) REACH → [TI-262](#)
 Korrosionsschutz → [TI-228](#)

Rostfrei → [S. 498](#)
 Messing → [S. 627](#)

Muttern nach ISO → ISO 8675 (DIN 439)



M 8	x 1	S	100	14,30 gal Zn
M 10	x 1	S	100	21,10 gal Zn
M 12	x 1,5	S	100	31,00 gal Zn
M 14	x 1,5	S	100	48,00 gal Zn
M 16	x 1,5	S	100	56,00 gal Zn
M 18	x 1,5	S	100	94,00 gal Zn
M 20	x 1,5	S	50	115,00 gal Zn
M 22	x 1,5	S	50	157,00 gal Zn
M 24	x 1,5	S	50	187,00 gal Zn
M 24	x 2	S	50	205,00 gal Zn
M 27	x 1,5	S	25	300,00 gal Zn
M 27	x 2	S	25	310,00 gal Zn
M 30	x 1,5	S	25	415,00 gal Zn

Abmessungen	VE Stück	€/100/Obf.
M 30 x 2	S 25	460,00 gal Zn
M 33 x 1,5	S 25	840,00 gal Zn
M 36 x 1,5	S 10	1120,00 gal Zn

DIN	00936.100
-----	-----------

936

22 H

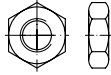

Sechskantmutter, niedrige Form

Maße → [TI-63](#) Normumstellung → [TI-7](#)
 Werkstoffeigensch. → [TI-233](#) REACH → [TI-262](#)

Rostfrei → [S. 497](#)
 Messing → [S. 627](#)

Muttern nach ISO → ISO 4035 (DIN 439)



M 8	S	100	17,60
M 10	S	100	28,00
M 12	S	100	39,50
M 14	S	100	57,00
M 16	S	100	78,00
M 20	S	50	157,00
M 24	S	50	255,00

DIN	00936.105
-----	-----------

936

22 H

Fein

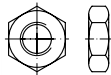

Sechskantmutter, niedrige Form, mit metrischem Feingewinde

Maße → [TI-63](#) Normumstellung → [TI-7](#)
 Werkstoffeigensch. → [TI-233](#) REACH → [TI-262](#)

Rostfrei → [S. 498](#)
 Messing → [S. 627](#)

Muttern nach ISO → ISO 8675 (DIN 439)



M 14	x 1,5	S	100	63,00
M 16	x 1,5	S	100	82,00
M 18	x 1,5	S	100	131,00
M 20	x 1,5	S	50	170,00
M 22	x 1,5	S	50	216,00
M 24	x 1,5	S	50	285,00

Abmessungen	VE Stück	€/100/Obf.
~DIN	00937.800	

937

17 H

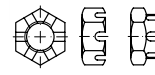

Kronenmutter, niedrige Form

Maße → [TI-67](#) REACH → [TI-262](#)
 Werkstoffeigensch. → [TI-233](#)

ISO-Schlüsselweiten → DIN 979



M 6	S	100	57,00
M 8	S	100	59,00
M 10	S	100	62,00
M 12	S	100	88,00
M 14	S	50	126,00
M 16	S	50	131,00
M 18	S	50	154,00
M 20	S	50	192,00
M 24	S	25	325,00
M 27	S	10	590,00
M 30	S	10	610,00

~DIN	00937.805
------	-----------

937

17 H

Fein

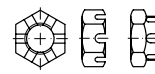

Kronenmutter, niedrige Form, mit metrischem Feingewinde

Maße → [TI-67](#) REACH → [TI-262](#)
 Werkstoffeigensch. → [TI-233](#)

ISO-Schlüsselweiten → DIN 979



M 8	x 1	S	100	68,00
M 10	x 1	S	100	73,00
M 12	x 1,5	S	100	103,00
M 14	x 1,5	S	50	147,00
M 16	x 1,5	S	50	153,00
M 18	x 1,5	S	50	181,00
M 20	x 1,5	S	25	246,00
M 22	x 1,5	S	25	305,00
M 24	x 1,5	S	25	385,00
M 24	x 2	S	25	385,00
M 26	x 1,5	S	25	620,00
M 27	x 1,5	S	25	680,00
M 27	x 2	S	25	680,00
M 28	x 1,5	S	10	740,00
M 30	x 1,5	S	10	740,00
M 30	x 2	S	10	740,00
M 32	x 1,5	S	1	960,00
M 33	x 1,5	S	1	960,00
M 35	x 1,5	S	1	1110,00
M 36	x 1,5	S	1	1110,00
M 36	x 3	S	1	1110,00
M 39	x 1,5	S	1	1460,00

Abmessungen	VE	Stück	€/100/Obf.
M 39 x 3	S	1	1460,00
M 40 x 1,5	S	1	1930,00
M 42 x 1,5	S	1	1930,00
M 42 x 3	S	1	1930,00
M 48 x 1,5	S	1	3300,00
M 48 x 3	S	1	3300,00
M 52 x 3	S	1	3950,00

DIN 00938.504

938 5.6 AD W7

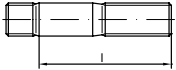

Stiftschrauben, Einschraubende ≈ 1 d

für Druckbehälterbau nach AD-Regelwerk, Fabrikat mit Verzicht auf ein Abnahmeprüfzeugnis

Maße → TI-18 Anziehmomente → TI-244
Werkstoffeigensch. → TI-232

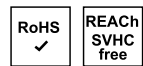

M 8 x 20	S	100	160,00
M 8 x 25	S	100	167,00
M 8 x 30	S	100	186,00
M 8 x 40	S	100	199,00
M 10 x 25	S	100	113,00
M 10 x 30	S	100	128,00
M 10 x 35	S	100	138,00
M 10 x 40	S	100	146,00
M 10 x 45	S	100	160,00
M 10 x 50	S	100	199,00
M 10 x 60	S	100	217,00
M 12 x 25	S	100	154,00
M 12 x 30	S	100	165,00
M 12 x 35	S	100	172,00
M 12 x 40	S	100	183,00
M 12 x 45	S	50	199,00
M 12 x 50	S	50	217,00
M 12 x 55	S	50	233,00
M 12 x 60	S	50	230,00
M 12 x 65	S	50	241,00
M 12 x 70	S	50	385,00
M 12 x 80	S	50	415,00
M 16 x 30	S	50	183,00
M 16 x 35	S	50	199,00
M 16 x 40	S	50	206,00
M 16 x 45	S	50	217,00
M 16 x 50	S	50	230,00
M 16 x 55	S	50	241,00
M 16 x 60	S	25	270,00
M 16 x 65	S	25	270,00
M 16 x 70	S	25	275,00
M 16 x 80	S	25	325,00
M 16 x 90	S	25	360,00
M 16 x 100	S	25	385,00
M 16 x 110	S	25	790,00
M 16 x 120	S	25	830,00
M 16 x 140	S	25	950,00
M 20 x 40	S	25	540,00
M 20 x 45	S	25	570,00
M 20 x 50	S	25	610,00
M 20 x 60	S	25	630,00
M 20 x 70	S	25	670,00
M 20 x 80	S	10	910,00
M 20 x 90	S	10	970,00
M 24 x 50	S	10	1130,00

Abmessungen	VE	Stück	€/100/Obf.
M 24 x 55	S	10	1200,00
M 24 x 60	S	10	1280,00
M 24 x 65	S	10	1350,00
M 24 x 70	S	10	1430,00
M 24 x 80	S	10	1530,00

DIN 00938.514

938 5.6 AD W7 galvanisch verzinkt

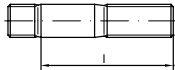

Stiftschrauben, Einschraubende ≈ 1 d

für Druckbehälterbau nach AD-Regelwerk, Fabrikat mit Verzicht auf ein Abnahmeprüfzeugnis

Maße → TI-18 Korrosionsschutz → TI-228
Werkstoffeigensch. → TI-232 Anziehmomente → TI-244



M 10 x 20	S	100	218,00 gal Zn
M 10 x 25	S	100	125,00 gal Zn
M 10 x 30	S	100	143,00 gal Zn
M 10 x 35	S	100	157,00 gal Zn
M 10 x 40	S	100	170,00 gal Zn
M 10 x 45	S	100	197,00 gal Zn
M 10 x 50	S	100	241,00 gal Zn
M 10 x 60	S	100	255,00 gal Zn
M 12 x 25	S	100	172,00 gal Zn
M 12 x 30	S	100	184,00 gal Zn
M 12 x 35	S	100	192,00 gal Zn
M 12 x 40	S	100	206,00 gal Zn
M 12 x 45	S	50	223,00 gal Zn
M 12 x 50	S	50	255,00 gal Zn
M 12 x 60	S	50	270,00 gal Zn
M 12 x 65	S	50	295,00 gal Zn
M 12 x 70	S	50	425,00 gal Zn
M 16 x 30	S	50	215,00 gal Zn
M 16 x 35	S	50	230,00 gal Zn
M 16 x 40	S	50	236,00 gal Zn
M 16 x 45	S	50	255,00 gal Zn
M 16 x 50	S	50	265,00 gal Zn
M 16 x 60	S	25	315,00 gal Zn
M 16 x 65	S	25	320,00 gal Zn
M 16 x 70	S	25	325,00 gal Zn
M 16 x 75	S	25	370,00 gal Zn
M 16 x 80	S	25	380,00 gal Zn
M 16 x 90	S	25	415,00 gal Zn
M 16 x 100	S	25	445,00 gal Zn
M 16 x 110	S	25	850,00 gal Zn
M 16 x 120	S	25	890,00 gal Zn
M 20 x 40	S	25	600,00 gal Zn
M 20 x 45	S	25	630,00 gal Zn
M 20 x 50	S	25	670,00 gal Zn
M 20 x 60	S	25	720,00 gal Zn
M 20 x 70	S	25	760,00 gal Zn
M 20 x 80	S	10	1010,00 gal Zn
M 20 x 90	S	10	1070,00 gal Zn
M 24 x 50	S	10	1240,00 gal Zn
M 24 x 55	S	10	1310,00 gal Zn
M 24 x 60	S	10	1390,00 gal Zn
M 24 x 65	S	10	1460,00 gal Zn
M 24 x 70	S	10	1550,00 gal Zn
M 24 x 80	S	10	1640,00 gal Zn

Abmessungen	VE	Stück	€/100/Obf.
DIN 00938.500			

938 5.8

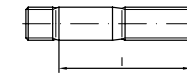

Stiftschrauben, Einschraubende ≈ 1 d

Maße → TI-18 REACH → TI-262
Werkstoffeigensch. → TI-232

Rostfrei → S. 498



M 5 x 16	S	100	73,00
M 5 x 20	S	100	73,00
M 5 x 25	S	100	74,00
M 5 x 30	S	100	77,00
M 5 x 35	S	100	79,00
M 5 x 50	S	100	85,00
M 6 x 16	S	100	41,50
M 6 x 18	S	100	46,00
M 6 x 20	S	100	48,00
M 6 x 25	S	100	67,00
M 6 x 30	S	100	52,00
M 6 x 35	S	100	54,00
M 6 x 40	S	100	58,00
M 6 x 45	S	100	59,00
M 6 x 50	S	100	62,00
M 6 x 60	S	100	66,00
M 6 x 70	S	100	77,00
M 8 x 16	S	100	58,00
M 8 x 20	S	100	36,00
M 8 x 22	S	100	41,50
M 8 x 25	S	100	39,50
M 8 x 30	S	100	43,00
M 8 x 35	S	100	44,00
M 8 x 40	S	100	52,00
M 8 x 45	S	100	53,00
M 8 x 50	S	100	49,50
M 8 x 55	S	100	54,00
M 8 x 60	S	100	56,00
M 8 x 80	S	100	143,00
M 8 x 90	S	100	155,00
M 8 x 100	S	100	172,00
M 10 x 20	S	100	79,00
M 10 x 25	S	100	47,00
M 10 x 30	S	100	52,00
M 10 x 35	S	100	62,00
M 10 x 40	S	100	66,00
M 10 x 45	S	100	67,00
M 10 x 50	S	100	69,00
M 10 x 55	S	100	73,00
M 10 x 60	S	100	78,00
M 10 x 65	S	50	125,00
M 10 x 70	S	50	130,00
M 10 x 80	S	50	192,00
M 10 x 90	S	50	204,00
M 10 x 110	S	50	315,00
M 12 x 20	S	100	88,00
M 12 x 25	S	100	61,00
M 12 x 30	S	100	63,00
M 12 x 35	S	100	66,00
M 12 x 40	S	100	68,00
M 12 x 45	S	50	72,00
M 12 x 50	S	50	74,00
M 12 x 55	S	50	94,00
M 12 x 60	S	50	96,00

Abmessungen	VE	Stück	€/100/Obf.
M 12 x 65	S	50	128,00
M 12 x 70	S	50	130,00
M 12 x 75	S	50	134,00
M 12 x 80	S	50	137,00
M 12 x 85	S	50	249,00
M 12 x 90	S	50	260,00
M 12 x 100	S	25	275,00
M 12 x 110	S	25	340,00
M 12 x 120	S	25	370,00
M 14 x 30	S	50	235,00
M 14 x 35	S	50	206,00
M 14 x 40	S	50	221,00
M 14 x 45	S	50	233,00
M 14 x 50	S	50	246,00
M 14 x 60	S	25	275,00
M 16 x 25	S	50	167,00
M 16 x 30	S	50	108,00
M 16 x 35	S	50	112,00
M 16 x 40	S	50	118,00
M 16 x 45	S	50	124,00
M 16 x 50	S	50	132,00
M 16 x 55	S	50	137,00
M 16 x 60	S	25	146,00
M 16 x 65	S	25	189,00
M 16 x 70	S	25	195,00
M 16 x 75	S	25	204,00
M 16 x 80	S	25	211,00
M 16 x 90	S	25	315,00
M 16 x 100	S	25	340,00
M 16 x 110	S	25	660,00
M 16 x 120	S	25	690,00
M 16 x 130	S	25	720,00
M 16 x 140	S	25	720,00
M 16 x 160	S	10	760,00
M 20 x 35	S	25	285,00
M 20 x 40	S	25	240,00
M 20 x 45	S	25	255,00
M 20 x 50	S	25	270,00
M 20 x 55	S	25	285,00
M 20 x 60	S	25	295,00
M 20 x 65	S	25	335,00
M 20 x 70	S	25	345,00
M 20 x 75	S	25	365,00
M 20 x 80	S	10	380,00
M 20 x 85	S	10	475,00
M 20 x 90	S	10	485,00
M 20 x 100	S	10	530,00
M 20 x 110	S	10	720,00
M 20 x 120	S	10	730,00
M 20 x 130	S	10	760,00
M 20 x 140	S	10	820,00
M 20 x 150	S	10	850,00
M 20 x 180	S	10	920,00
M 24 x 50	S	10	410,00
M 24 x 55	S	10	425,00
M 24 x 60	S	10	445,00
M 24 x 65	S	10	470,00
M 24 x 70	S	10	480,00
M 24 x 75	S	10	510,00
M 24 x 80	S	10	530,00
M 24 x 90	S	10	570,00
M 24 x 100	S	10	610,00
M 24 x 120	S	10	730,00
M 24 x 180	S	10	2120,00
M 30 x 65	S	10	1070,00
M 30 x 70	S	10	1080,00
M 30 x 80	S	5	1130,00
M 30 x 90	S	1	1170,00
M 30 x 100	S	1	1260,00
M 30 x 110	S	1	1300,00

Abmessungen	VE	Stück	€/100/Obf.
DIN 00938.510			
938			5.8
			galvanisch verzinkt

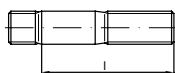

Stiftschrauben, Einschraubende ≈ 1 d

Maße → **TI-18** Korrosionsschutz → **TI-228**
 Werkstoffeigensch. → **TI-232** REACH → **TI-262**
 Rostfrei → **S. 498**



M 8 x 20	S	100	39,50 gal Zn
M 8 x 25	S	100	44,50 gal Zn
M 8 x 30	S	100	49,50 gal Zn
M 8 x 40	S	100	60,00 gal Zn
M 10 x 20	S	100	97,00 gal Zn
M 10 x 25	S	100	57,00 gal Zn
M 10 x 30	S	100	66,00 gal Zn
M 10 x 35	S	100	76,00 gal Zn
M 10 x 40	S	100	79,00 gal Zn
M 10 x 50	S	100	88,00 gal Zn
M 12 x 25	S	100	77,00 gal Zn
M 12 x 30	S	100	82,00 gal Zn
M 12 x 35	S	100	85,00 gal Zn
M 12 x 40	S	100	91,00 gal Zn
M 12 x 50	S	50	101,00 gal Zn
M 16 x 35	S	50	143,00 gal Zn
M 16 x 40	S	50	154,00 gal Zn
M 16 x 45	S	50	165,00 gal Zn
M 16 x 50	S	50	175,00 gal Zn
M 16 x 55	S	50	184,00 gal Zn
M 16 x 60	S	25	195,00 gal Zn
M 20 x 50	S	25	335,00 gal Zn
M 20 x 55	S	25	345,00 gal Zn
M 20 x 60	S	25	370,00 gal Zn
M 20 x 65	S	25	410,00 gal Zn
M 20 x 70	S	25	425,00 gal Zn
M 20 x 80	S	10	470,00 gal Zn

Abmessungen	VE	Stück	€/100/Obf.
DIN 00938.800			
938			8.8

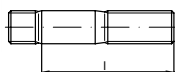

Stiftschrauben, Einschraubende ≈ 1 d

Maße → **TI-18** Anziehmomente → **TI-244**
 Werkstoffeigensch. → **TI-232**
 Rostfrei → **S. 498**



M 8 x 20	S	50	56,00
M 8 x 25	S	50	61,00
M 8 x 30	S	50	66,00
M 8 x 35	S	50	67,00
M 8 x 40	S	50	72,00

Abmessungen	VE	Stück	€/100/Obf.
M 8 x 45	S	50	73,00
M 8 x 50	S	50	74,00
M 8 x 55	S	50	76,00
M 8 x 60	S	50	78,00
M 8 x 65	S	50	79,00
M 8 x 70	S	50	83,00
M 8 x 80	S	50	91,00
M 10 x 20	S	50	165,00
M 10 x 25	S	50	67,00
M 10 x 30	S	50	69,00
M 10 x 35	S	50	72,00
M 10 x 40	S	50	78,00
M 10 x 45	S	50	82,00
M 10 x 50	S	50	84,00
M 10 x 55	S	50	86,00
M 10 x 60	S	50	89,00
M 10 x 65	S	50	255,00
M 10 x 70	S	50	260,00
M 10 x 75	S	50	265,00
M 10 x 80	S	25	270,00
M 10 x 100	S	25	370,00
M 12 x 25	S	50	89,00
M 12 x 30	S	50	95,00
M 12 x 35	S	50	99,00
M 12 x 40	S	50	105,00
M 12 x 45	S	50	108,00
M 12 x 50	S	50	112,00
M 12 x 55	S	25	120,00
M 12 x 60	S	25	124,00
M 12 x 65	S	25	128,00
M 12 x 70	S	25	131,00
M 12 x 75	S	25	135,00
M 12 x 80	S	25	138,00
M 12 x 85	S	25	385,00
M 12 x 90	S	25	395,00
M 12 x 100	S	10	420,00
M 16 x 30	S	25	385,00
M 16 x 35	S	25	211,00
M 16 x 40	S	25	224,00
M 16 x 45	S	25	250,00
M 16 x 50	S	25	260,00
M 16 x 55	S	25	270,00
M 16 x 60	S	10	315,00
M 16 x 65	S	10	330,00
M 16 x 70	S	10	335,00
M 16 x 75	S	10	540,00
M 16 x 80	S	10	590,00
M 16 x 85	S	10	590,00
M 16 x 90	S	10	610,00
M 16 x 100	S	10	720,00
M 16 x 120	S	10	820,00
M 16 x 140	S	10	910,00
M 20 x 35	S	10	680,00
M 20 x 40	S	10	720,00
M 20 x 45	S	10	720,00
M 20 x 50	S	10	730,00
M 20 x 55	S	10	730,00
M 20 x 60	S	10	760,00
M 20 x 65	S	10	790,00
M 20 x 70	S	10	840,00
M 20 x 75	S	10	880,00
M 20 x 80	S	10	910,00
M 20 x 85	S	10	950,00
M 20 x 90	S	10	990,00
M 20 x 100	S	10	1080,00
M 20 x 110	S	10	1130,00
M 20 x 120	S	10	1210,00
M 20 x 130	S	10	1280,00
M 20 x 140	S	1	1350,00
M 24 x 50	S	10	1030,00
M 24 x 55	S	10	1070,00
M 24 x 60	S	10	1110,00
M 24 x 65	S	10	1140,00
M 24 x 70	S	10	1200,00
M 24 x 75	S	1	1230,00

Abmessungen	VE	Stück	€/100/Obf.
M 24 x 80	S	1	1280,00
M 24 x 85	S	1	1320,00
M 24 x 90	S	1	1360,00
M 24 x 100	S	1	1440,00
M 24 x 110	S	1	1570,00
M 24 x 120	S	1	1670,00
M 24 x 130	S	1	1770,00
M 24 x 150	S	1	1940,00

DIN 00938.810
938 8.8
 galvanisch verzinkt

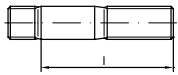

Stiftschrauben, Einschraubende ≈ 1 d

Maße → TI-18 Korrosionsschutz → TI-228
 Werkstoffeigensch. → TI-232 Anziehmomente → TI-244
 Rostfrei → S. 498

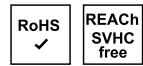

M 8 x 20	S	50	61,00 gal Zn
M 8 x 25	S	50	67,00 gal Zn
M 8 x 30	S	50	99,00 gal Zn
M 8 x 40	S	50	135,00 gal Zn
M 10 x 20	S	50	176,00 gal Zn
M 10 x 25	S	50	78,00 gal Zn
M 10 x 30	S	50	85,00 gal Zn
M 10 x 35	S	50	126,00 gal Zn
M 10 x 40	S	50	144,00 gal Zn
M 10 x 45	S	50	148,00 gal Zn
M 10 x 50	S	50	151,00 gal Zn
M 10 x 60	S	50	155,00 gal Zn
M 10 x 70	S	50	325,00 gal Zn
M 12 x 25	S	50	106,00 gal Zn
M 12 x 30	S	50	114,00 gal Zn
M 12 x 35	S	50	120,00 gal Zn
M 12 x 40	S	50	128,00 gal Zn
M 12 x 50	S	50	201,00 gal Zn
M 12 x 55	S	25	210,00 gal Zn
M 12 x 60	S	25	213,00 gal Zn
M 16 x 30	S	25	420,00 gal Zn
M 16 x 35	S	25	255,00 gal Zn
M 16 x 40	S	25	270,00 gal Zn
M 16 x 45	S	25	305,00 gal Zn
M 16 x 50	S	25	315,00 gal Zn
M 16 x 55	S	25	345,00 gal Zn
M 16 x 60	S	10	385,00 gal Zn
M 16 x 65	S	10	395,00 gal Zn
M 16 x 70	S	10	415,00 gal Zn
M 20 x 40	S	10	780,00 gal Zn
M 20 x 45	S	10	780,00 gal Zn
M 20 x 50	S	10	790,00 gal Zn
M 20 x 55	S	10	820,00 gal Zn
M 20 x 60	S	10	840,00 gal Zn
M 20 x 65	S	10	880,00 gal Zn
M 20 x 70	S	10	920,00 gal Zn
M 20 x 80	S	10	990,00 gal Zn
M 20 x 90	S	10	1060,00 gal Zn
M 20 x 100	S	10	1150,00 gal Zn
M 24 x 60	S	10	1210,00 gal Zn
M 24 x 65	S	10	1250,00 gal Zn
M 24 x 70	S	10	1320,00 gal Zn
M 24 x 75	S	1	1340,00 gal Zn
M 24 x 80	S	1	1380,00 gal Zn
M 24 x 90	S	1	1470,00 gal Zn

Abmessungen	VE	Stück	€/100/Obf.
M 24 x 100	S	1	1550,00 gal Zn
M 24 x 110	S	1	1670,00 gal Zn
M 24 x 120	S	1	1780,00 gal Zn
M 24 x 130	S	1	1880,00 gal Zn
M 24 x 140	S	1	1970,00 gal Zn
M 24 x 150	S	1	2060,00 gal Zn

DIN 00939.504

939 5.6 AD W7

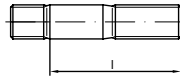

Stiftschrauben, Einschraubende ≈ 1,25 d

für Druckbehälterbau nach AD-Regelwerk,
 Fabrikat mit Verzicht auf ein Abnahmeprüfzeugnis

Maße → TI-18 Anziehmomente → TI-244
 Werkstoffeigensch. → TI-232



M 12 x 30	S	100	182,00
M 12 x 35	S	100	190,00
M 12 x 40	S	100	201,00
M 12 x 50	S	100	239,00
M 16 x 35	S	50	220,00
M 16 x 40	S	50	227,00
M 16 x 50	S	50	255,00
M 16 x 60	S	25	285,00
M 16 x 70	S	25	325,00
M 20 x 45	S	25	630,00

DIN 00939.500

939 5.8

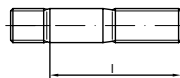

Stiftschrauben, Einschraubende ≈ 1,25 d

Maße → TI-18 REACH → TI-262
 Werkstoffeigensch. → TI-232

Rostfrei → S. 499



M 5 x 16	S	100	74,00
M 5 x 20	S	100	76,00
M 5 x 40	S	100	83,00
M 6 x 16	S	100	34,50
M 6 x 18	S	100	34,50
M 6 x 20	S	100	36,00
M 6 x 25	S	100	38,00
M 6 x 28	S	100	85,00
M 6 x 30	S	100	43,00
M 6 x 35	S	100	48,50
M 6 x 40	S	100	51,00
M 6 x 45	S	100	53,00
M 6 x 50	S	100	54,00
M 6 x 60	S	100	66,00

Abmessungen	VE	Stück	€/100/Obf.
M 6 x 80	S	100	106,00
M 8 x 16	S	100	53,00
M 8 x 18	S	100	106,00
M 8 x 20	S	100	31,00
M 8 x 22	S	100	32,50
M 8 x 25	S	100	37,00
M 8 x 30	S	100	44,00
M 8 x 35	S	100	46,00
M 8 x 40	S	100	47,50
M 8 x 45	S	100	48,50
M 8 x 50	S	100	51,00
M 8 x 55	S	100	56,00
M 8 x 60	S	100	53,00
M 8 x 65	S	100	59,00
M 8 x 70	S	100	61,00
M 8 x 80	S	100	97,00
M 8 x 90	S	100	155,00
M 8 x 100	S	100	165,00
M 10 x 20	S	100	46,00
M 10 x 22	S	100	48,00
M 10 x 25	S	100	38,00
M 10 x 30	S	100	39,00
M 10 x 35	S	100	41,50
M 10 x 40	S	100	42,50
M 10 x 45	S	100	58,00
M 10 x 50	S	100	60,00
M 10 x 55	S	100	67,00
M 10 x 60	S	100	69,00
M 10 x 65	S	50	72,00
M 10 x 70	S	50	76,00
M 10 x 75	S	50	77,00
M 10 x 80	S	50	94,00
M 10 x 90	S	50	101,00
M 10 x 100	S	50	108,00
M 10 x 110	S	50	305,00
M 10 x 120	S	50	345,00
M 10 x 130	S	50	365,00
M 10 x 140	S	50	540,00
M 10 x 160	S	50	630,00
M 10 x 190	S	50	690,00
M 12 x 20	S	100	128,00
M 12 x 25	S	100	54,00
M 12 x 28	S	100	79,00
M 12 x 30	S	100	57,00
M 12 x 35	S	100	59,00
M 12 x 40	S	100	79,00
M 12 x 45	S	50	83,00
M 12 x 50	S	50	85,00
M 12 x 55	S	50	95,00
M 12 x 60	S	50	97,00
M 12 x 65	S	50	94,00
M 12 x 70	S	50	103,00
M 12 x 75	S	50	107,00
M 12 x 80	S	50	103,00
M 12 x 85	S	50	204,00
M 12 x 90	S	50	118,00
M 12 x 95	S	50	224,00
M 12 x 100	S	25	125,00
M 12 x 105	S	25	345,00
M 12 x 110	S	25	370,00
M 12 x 120	S	25	385,00
M 12 x 130	S	25	395,00
M 12 x 140	S	25	630,00
M 12 x 150	S	25	660,00
M 12 x 200	S	25	780,00
M 14 x 30	S	50	204,00
M 14 x 35	S	50	217,00
M 14 x 40	S	50	232,00
M 16 x 25	S	50	181,00
M 16 x 30	S	50	123,00
M 16 x 35	S	50	124,00
M 16 x 40	S	50	132,00
M 16 x 45	S	50	138,00
M 16 x 50	S	50	148,00
M 16 x 55	S	50	186,00

Abmessungen	VE	Stück	€/100/Obf.
M 16 x 60	S	25	195,00
M 16 x 65	S	25	204,00
M 16 x 70	S	25	246,00
M 16 x 75	S	25	255,00
M 16 x 80	S	25	265,00
M 16 x 85	S	25	360,00
M 16 x 90	S	25	285,00
M 16 x 100	S	25	305,00
M 16 x 105	S	25	670,00
M 16 x 110	S	25	660,00
M 16 x 120	S	25	680,00
M 16 x 130	S	25	760,00
M 16 x 140	S	25	760,00
M 16 x 150	S	25	770,00
M 16 x 160	S	10	790,00
M 16 x 180	S	10	840,00
M 16 x 190	S	10	850,00
M 16 x 200	S	10	860,00
M 20 x 30	S	25	300,00
M 20 x 40	S	25	285,00
M 20 x 45	S	25	242,00
M 20 x 50	S	25	255,00
M 20 x 55	S	25	270,00
M 20 x 60	S	25	285,00
M 20 x 65	S	25	335,00
M 20 x 70	S	25	345,00
M 20 x 75	S	25	365,00
M 20 x 80	S	10	380,00
M 20 x 85	S	10	395,00
M 20 x 90	S	10	480,00
M 20 x 95	S	10	510,00
M 20 x 100	S	10	530,00
M 20 x 110	S	10	760,00
M 20 x 120	S	10	770,00
M 20 x 130	S	10	770,00
M 20 x 140	S	10	830,00
M 20 x 150	S	10	880,00
M 20 x 160	S	10	890,00
M 20 x 180	S	10	940,00
M 24 x 50	S	10	480,00
M 24 x 55	S	10	425,00
M 24 x 60	S	10	445,00
M 24 x 65	S	10	470,00
M 24 x 70	S	10	580,00
M 24 x 75	S	10	510,00
M 24 x 80	S	10	530,00
M 24 x 85	S	10	540,00
M 24 x 90	S	10	570,00
M 24 x 100	S	10	610,00
M 24 x 110	S	10	690,00
M 24 x 120	S	10	740,00
M 24 x 130	S	10	790,00
M 24 x 160	S	10	1020,00
M 24 x 170	S	10	1060,00
M 24 x 180	S	10	1080,00
M 24 x 200	S	10	2350,00
M 27 x 65	S	10	830,00
M 27 x 70	S	10	840,00
M 27 x 80	S	10	940,00
M 27 x 100	S	10	990,00
M 27 x 110	S	10	2040,00
M 30 x 65	S	10	1120,00
M 30 x 70	S	10	1140,00
M 30 x 80	S	1	1170,00
M 30 x 90	S	1	1200,00
M 30 x 100	S	1	1300,00
M 30 x 120	S	1	1430,00
M 30 x 130	S	1	1480,00
M 30 x 140	S	1	1580,00
M 30 x 150	S	1	1610,00
M 30 x 180	S	1	1900,00
M 30 x 200	S	1	2110,00

Abmessungen	VE	Stück	€/100/Obf.
DIN	00939.510		
939	5.8 galvanisch verzinkt		

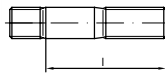

Stiftschrauben, Einschraubende ≈ 1,25 d

Maße → **TI-18** Korrosionsschutz → **TI-228**
 Werkstoffeigensch. → **TI-232** REACH → **TI-262**
 Rostfrei → **S. 499**



M 8 x 20	S	100	41,50 gal Zn
M 8 x 25	S	100	43,00 gal Zn
M 8 x 30	S	100	45,00 gal Zn
M 10 x 25	S	100	47,00 gal Zn
M 10 x 30	S	100	48,50 gal Zn
M 10 x 35	S	100	53,00 gal Zn
M 10 x 40	S	100	56,00 gal Zn
M 12 x 30	S	100	73,00 gal Zn
M 12 x 35	S	100	77,00 gal Zn
M 12 x 40	S	100	97,00 gal Zn
M 12 x 45	S	50	101,00 gal Zn
M 12 x 50	S	50	103,00 gal Zn
M 16 x 35	S	50	163,00 gal Zn
M 16 x 40	S	50	175,00 gal Zn
M 16 x 45	S	50	186,00 gal Zn
M 16 x 50	S	50	200,00 gal Zn
M 16 x 60	S	25	255,00 gal Zn
M 16 x 90	S	25	345,00 gal Zn
M 20 x 45	S	25	315,00 gal Zn
M 20 x 50	S	25	335,00 gal Zn
M 20 x 60	S	25	380,00 gal Zn
M 20 x 70	S	25	430,00 gal Zn
M 20 x 80	S	25	475,00 gal Zn

DIN	00939.800		
939	8.8		

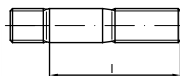

Stiftschrauben, Einschraubende ≈ 1,25 d

Maße → **TI-18** Anziehmomente → **TI-244**
 Werkstoffeigensch. → **TI-232**
 Rostfrei → **S. 499**



M 6 x 16	S	100	46,00
M 6 x 20	S	100	47,50
M 6 x 25	S	100	48,00
M 6 x 30	S	100	51,00
M 6 x 35	S	100	53,00
M 8 x 16	S	50	54,00
M 8 x 20	S	50	56,00
M 8 x 25	S	50	57,00
M 8 x 30	S	50	62,00

Abmessungen	VE	Stück	€/100/Obf.
M 8 x 35	S	50	63,00
M 8 x 40	S	50	66,00
M 8 x 45	S	50	67,00
M 8 x 50	S	50	69,00
M 8 x 55	S	50	72,00
M 8 x 60	S	50	73,00
M 8 x 65	S	50	76,00
M 8 x 70	S	50	77,00
M 8 x 80	S	50	82,00
M 8 x 90	S	50	85,00
M 10 x 20	S	50	68,00
M 10 x 25	S	50	69,00
M 10 x 30	S	50	73,00
M 10 x 35	S	50	78,00
M 10 x 40	S	50	82,00
M 10 x 45	S	50	84,00
M 10 x 50	S	50	86,00
M 10 x 55	S	50	89,00
M 10 x 60	S	50	94,00
M 10 x 65	S	50	245,00
M 10 x 70	S	50	265,00
M 10 x 75	S	50	270,00
M 10 x 80	S	25	275,00
M 10 x 90	S	25	330,00
M 10 x 100	S	25	370,00
M 10 x 110	S	25	420,00
M 10 x 120	S	25	440,00
M 12 x 25	S	50	153,00
M 12 x 30	S	50	121,00
M 12 x 35	S	50	99,00
M 12 x 40	S	50	105,00
M 12 x 45	S	50	108,00
M 12 x 50	S	50	112,00
M 12 x 55	S	25	120,00
M 12 x 60	S	25	124,00
M 12 x 65	S	25	126,00
M 12 x 70	S	25	131,00
M 12 x 75	S	25	360,00
M 12 x 80	S	25	345,00
M 12 x 85	S	25	365,00
M 12 x 90	S	25	380,00
M 12 x 100	S	10	415,00
M 12 x 110	S	25	440,00
M 12 x 120	S	25	460,00
M 12 x 130	S	25	495,00
M 12 x 140	S	25	580,00
M 16 x 30	S	25	234,00
M 16 x 35	S	25	255,00
M 16 x 40	S	25	270,00
M 16 x 45	S	25	295,00
M 16 x 50	S	25	310,00
M 16 x 55	S	25	330,00
M 16 x 60	S	10	385,00
M 16 x 65	S	10	395,00
M 16 x 70	S	10	410,00
M 16 x 75	S	10	425,00
M 16 x 80	S	10	430,00
M 16 x 85	S	10	1020,00
M 16 x 90	S	10	455,00
M 16 x 95	S	10	1030,00
M 16 x 100	S	10	460,00
M 16 x 110	S	10	740,00
M 16 x 120	S	10	780,00
M 16 x 130	S	10	840,00
M 16 x 140	S	10	890,00
M 20 x 40	S	10	660,00
M 20 x 45	S	10	620,00
M 20 x 50	S	10	680,00
M 20 x 55	S	10	690,00
M 20 x 60	S	10	740,00
M 20 x 65	S	10	780,00
M 20 x 70	S	10	830,00
M 20 x 75	S	10	850,00
M 20 x 80	S	10	880,00
M 20 x 85	S	10	940,00

Abmessungen	VE	Stück	€/100/Obf.
M 20 x 90	S	10	960,00
M 20 x 100	S	10	1060,00
M 20 x 110	S	10	1070,00
M 20 x 120	S	10	1150,00
M 20 x 130	S	10	1230,00
M 20 x 140	S	1	1300,00
M 20 x 150	S	1	1360,00
M 24 x 50	S	10	1030,00
M 24 x 55	S	10	1070,00
M 24 x 60	S	10	1110,00
M 24 x 65	S	10	1150,00
M 24 x 70	S	1	1200,00
M 24 x 75	S	1	1230,00
M 24 x 80	S	1	1260,00
M 24 x 90	S	1	1380,00
M 24 x 100	S	1	1510,00
M 24 x 110	S	1	1640,00
M 24 x 120	S	1	1660,00
M 24 x 130	S	1	1760,00
M 24 x 140	S	1	1870,00
M 24 x 150	S	1	2010,00

DIN	00939.810
939	8.8
	galvanisch verzinkt

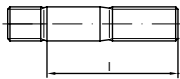

Stiftschrauben, Einschraubende ≈ 1,25 d

Maße → **TI-18** Korrosionsschutz → **TI-228**
 Werkstoffeigensch. → **TI-232** Anziehmomente → **TI-244**

Rostfrei → **S. 499**

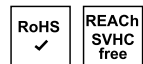

M 6 x 16	S	100	53,00 gal Zn
M 6 x 20	S	100	54,00 gal Zn
M 6 x 25	S	100	54,00 gal Zn
M 6 x 30	S	100	57,00 gal Zn
M 8 x 16	S	50	62,00 gal Zn
M 8 x 20	S	50	62,00 gal Zn
M 8 x 25	S	50	63,00 gal Zn
M 8 x 30	S	50	69,00 gal Zn
M 8 x 35	S	50	71,00 gal Zn
M 8 x 40	S	50	74,00 gal Zn
M 8 x 45	S	50	80,00 gal Zn
M 8 x 50	S	50	86,00 gal Zn
M 8 x 55	S	50	82,00 gal Zn
M 8 x 60	S	50	84,00 gal Zn
M 8 x 70	S	50	86,00 gal Zn
M 8 x 80	S	50	146,00 gal Zn
M 8 x 90	S	50	157,00 gal Zn
M 10 x 20	S	50	77,00 gal Zn
M 10 x 25	S	50	82,00 gal Zn
M 10 x 30	S	50	85,00 gal Zn
M 10 x 35	S	50	92,00 gal Zn
M 10 x 40	S	50	97,00 gal Zn
M 10 x 45	S	50	102,00 gal Zn
M 10 x 50	S	50	105,00 gal Zn
M 10 x 55	S	50	107,00 gal Zn
M 10 x 60	S	50	112,00 gal Zn
M 10 x 65	S	50	265,00 gal Zn
M 10 x 80	S	25	295,00 gal Zn
M 10 x 90	S	25	355,00 gal Zn
M 10 x 100	S	25	395,00 gal Zn
M 10 x 110	S	25	450,00 gal Zn
M 10 x 120	S	25	465,00 gal Zn

Abmessungen	VE	Stück	€/100/Obf.
M 12 x 25	S	50	170,00 gal Zn
M 12 x 30	S	50	141,00 gal Zn
M 12 x 35	S	50	120,00 gal Zn
M 12 x 40	S	50	130,00 gal Zn
M 12 x 45	S	50	135,00 gal Zn
M 12 x 50	S	50	141,00 gal Zn
M 12 x 55	S	25	147,00 gal Zn
M 12 x 60	S	25	153,00 gal Zn
M 12 x 70	S	25	165,00 gal Zn
M 12 x 75	S	25	390,00 gal Zn
M 12 x 80	S	25	415,00 gal Zn
M 12 x 90	S	25	445,00 gal Zn
M 12 x 100	S	10	480,00 gal Zn
M 12 x 110	S	25	510,00 gal Zn
M 12 x 120	S	25	530,00 gal Zn
M 16 x 30	S	25	295,00 gal Zn
M 16 x 35	S	25	310,00 gal Zn
M 16 x 40	S	25	330,00 gal Zn
M 16 x 45	S	25	360,00 gal Zn
M 16 x 50	S	25	385,00 gal Zn
M 16 x 55	S	25	410,00 gal Zn
M 16 x 60	S	10	460,00 gal Zn
M 16 x 70	S	10	495,00 gal Zn
M 16 x 80	S	10	540,00 gal Zn
M 16 x 90	S	10	560,00 gal Zn
M 16 x 100	S	10	590,00 gal Zn
M 16 x 110	S	10	860,00 gal Zn
M 16 x 120	S	10	900,00 gal Zn
M 20 x 40	S	10	1010,00 gal Zn
M 20 x 45	S	10	970,00 gal Zn
M 20 x 50	S	10	1030,00 gal Zn
M 20 x 55	S	10	1060,00 gal Zn
M 20 x 60	S	10	1060,00 gal Zn
M 20 x 70	S	10	1070,00 gal Zn
M 20 x 80	S	10	1070,00 gal Zn
M 20 x 90	S	10	1110,00 gal Zn
M 20 x 100	S	10	1410,00 gal Zn
M 20 x 110	S	10	1420,00 gal Zn
M 20 x 120	S	10	1510,00 gal Zn
M 20 x 130	S	10	1580,00 gal Zn
M 24 x 50	S	10	1140,00 gal Zn
M 24 x 60	S	10	1210,00 gal Zn
M 24 x 70	S	1	1310,00 gal Zn
M 24 x 80	S	1	1370,00 gal Zn
M 24 x 90	S	1	1510,00 gal Zn
M 24 x 100	S	1	1610,00 gal Zn
M 24 x 110	S	1	1750,00 gal Zn
M 24 x 120	S	1	1890,00 gal Zn
M 24 x 130	S	1	1990,00 gal Zn
M 24 x 140	S	1	2110,00 gal Zn
M 24 x 150	S	1	2260,00 gal Zn
M 30 x 90	S	1	6000,00 gal Zn
M 30 x 100	S	1	6100,00 gal Zn

Abmessungen	VE	Stück	€/100/Obf.
DIN		00939.100	

939 **10.9**

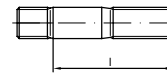

Stiftschrauben, Einschraubende ≈ 1,25 d

Maße → **TI-18** Anziehmomente → **TI-244**
 Werkstoffeigensch. → **TI-232**

Rostfrei → **S. 499**

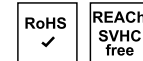

M 10 x 25	S	50	207,00
M 10 x 30	S	50	218,00
M 10 x 35	S	50	233,00
M 10 x 40	S	50	244,00
M 10 x 45	S	50	255,00
M 10 x 50	S	50	260,00
M 10 x 55	S	100	178,00
M 10 x 65	S	50	740,00
M 10 x 70	S	50	790,00
M 10 x 80	S	50	830,00
M 10 x 100	S	25	1110,00
M 12 x 25	S	50	180,00
M 12 x 30	S	50	365,00
M 12 x 35	S	50	98,00
M 12 x 40	S	50	85,00
M 12 x 45	S	50	325,00
M 12 x 50	S	50	335,00
M 12 x 60	S	25	375,00
M 12 x 65	S	25	360,00
M 12 x 70	S	25	395,00
M 12 x 80	S	25	1040,00
M 16 x 35	S	25	1140,00
M 16 x 40	S	25	810,00
M 16 x 45	S	25	880,00
M 16 x 50	S	25	930,00
M 16 x 60	S	10	1150,00
M 16 x 65	S	10	1180,00
M 16 x 70	S	10	1220,00
M 16 x 80	S	10	1290,00
M 16 x 90	S	10	1370,00
M 16 x 100	S	10	1380,00
M 16 x 110	S	10	2220,00
M 16 x 120	S	10	2330,00
M 16 x 125	S	10	2410,00
M 16 x 130	S	10	2550,00
M 16 x 140	S	10	2650,00
M 16 x 150	S	10	2800,00
M 16 x 160	S	10	2950,00
M 16 x 180	S	10	3150,00
M 16 x 190	S	10	3250,00
M 16 x 200	S	10	3400,00
M 20 x 50	S	10	2040,00
M 20 x 55	S	10	2070,00
M 20 x 60	S	10	2220,00
M 20 x 65	S	10	2330,00
M 20 x 80	S	10	2650,00
M 20 x 90	S	10	2900,00
M 20 x 100	S	10	3200,00
M 20 x 110	S	10	3200,00
M 20 x 120	S	10	3450,00
M 20 x 140	S	10	3900,00
M 20 x 150	S	1	4100,00
M 20 x 160	S	1	4250,00
M 20 x 200	S	1	4450,00

Abmessungen	VE	Stück	€/100/Obf.
M 20 x 220	S	1	4650,00
M 20 x 250	S	1	4800,00
M 20 x 270	S	1	5400,00
M 20 x 280	S	1	5000,00
M 20 x 290	S	1	5600,00

DIN 00960.800

960

8.8



Sechskantschrauben mit Schaft, mit metrischem Feingewinde

kurze Abm. z. T. Gewinde bis Kopf

Maße → TI-15 Anziehmomente → TI-244
 Werkstoffeigensch. → TI-232 Normumstellung → TI-6

DIN 960 → wird ersetzt durch ISO 8765

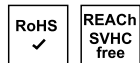

M 8 x 1 x 30	S	200	25,50
M 8 x 1 x 35	S	200	28,50
M 8 x 1 x 40	S	200	32,00
M 8 x 1 x 45	S	200	35,50
M 8 x 1 x 50	S	200	42,00
M 8 x 1 x 60	S	200	48,50
M 8 x 1 x 70	S	200	56,00
M 8 x 1 x 80	S	200	62,00
M 10 x 1 x 35	S	100	45,50
M 10 x 1,25 x 35	S	100	48,50
M 10 x 1 x 40	S	200	50,00
M 10 x 1,25 x 40	S	100	53,00
M 10 x 1 x 45	S	100	55,00
M 10 x 1,25 x 45	S	100	55,00
M 10 x 1 x 50	S	200	59,00
M 10 x 1,25 x 50	S	100	59,00
M 10 x 1,25 x 55	S	100	63,00
M 10 x 1 x 60	S	100	63,00
M 10 x 1,25 x 60	S	100	64,00
M 10 x 1 x 65	S	100	70,00
M 10 x 1 x 70	S	100	70,00
M 10 x 1,25 x 70	S	100	70,00
M 10 x 1 x 80	S	100	79,00
M 10 x 1,25 x 80	S	100	78,00
M 10 x 1 x 90	S	100	88,00
M 10 x 1,25 x 90	S	100	90,00
M 10 x 1 x 100	S	100	97,00
M 10 x 1,25 x 100	S	100	104,00
M 10 x 1,25 x 110	S	50	143,00
M 10 x 1,25 x 120	S	50	158,00
M 10 x 1,25 x 130	S	50	200,00
M 12 x 1,25 x 35	S	100	78,00
M 12 x 1,5 x 35	S	100	69,00
M 12 x 1,25 x 40	S	100	80,00
M 12 x 1,5 x 40	S	100	72,00
M 12 x 1,25 x 45	S	100	82,00
M 12 x 1,5 x 45	S	100	74,00
M 12 x 1,25 x 50	S	100	84,00
M 12 x 1,5 x 50	S	100	74,00
M 12 x 1,25 x 60	S	100	93,00
M 12 x 1,5 x 60	S	100	92,00
M 12 x 1,25 x 65	S	50	97,00
M 12 x 1,5 x 65	S	50	101,00
M 12 x 1,25 x 70	S	50	101,00
M 12 x 1,5 x 70	S	50	101,00
M 12 x 1,5 x 75	S	50	112,00
M 12 x 1,25 x 80	S	50	112,00

Abmessungen	VE	Stück	€/100/Obf.
M 12 x 1,5 x 80	S	50	108,00
M 12 x 1,25 x 90	S	50	130,00
M 12 x 1,5 x 90	S	50	126,00
M 12 x 1,25 x 100	S	50	142,00
M 12 x 1,5 x 100	S	50	137,00
M 12 x 1,25 x 110	S	50	192,00
M 12 x 1,5 x 110	S	50	157,00
M 12 x 1,25 x 120	S	50	210,00
M 12 x 1,5 x 120	S	50	176,00
M 12 x 1,25 x 130	S	50	233,00
M 12 x 1,5 x 130	S	50	226,00
M 12 x 1,5 x 140	S	50	260,00
M 14 x 1,5 x 50	S	50	143,00
M 14 x 1,5 x 55	S	50	153,00
M 14 x 1,5 x 60	S	50	153,00
M 14 x 1,5 x 65	S	50	167,00
M 14 x 1,5 x 70	S	50	167,00
M 14 x 1,5 x 75	S	50	192,00
M 14 x 1,5 x 80	S	50	192,00
M 14 x 1,5 x 90	S	50	215,00
M 14 x 1,5 x 100	S	50	240,00
M 14 x 1,5 x 110	S	50	285,00
M 14 x 1,5 x 120	S	50	325,00
M 14 x 1,5 x 130	S	50	370,00
M 14 x 1,5 x 140	S	25	410,00
M 16 x 1,5 x 50	S	50	152,00
M 16 x 1,5 x 55	S	50	163,00
M 16 x 1,5 x 60	S	50	174,00
M 16 x 1,5 x 65	S	25	204,00
M 16 x 1,5 x 70	S	25	204,00
M 16 x 1,5 x 75	S	25	209,00
M 16 x 1,5 x 80	S	25	209,00
M 16 x 1,5 x 85	S	25	232,00
M 16 x 1,5 x 90	S	25	232,00
M 16 x 1,5 x 100	S	25	255,00
M 16 x 1,5 x 110	S	25	330,00
M 16 x 1,5 x 120	S	25	330,00
M 16 x 1,5 x 130	S	25	410,00
M 16 x 1,5 x 140	S	25	445,00
M 16 x 1,5 x 150	S	25	450,00
M 16 x 1,5 x 160	S	25	670,00
M 18 x 1,5 x 60	S	25	440,00
M 18 x 1,5 x 65	S	25	440,00
M 18 x 1,5 x 70	S	25	395,00
M 18 x 1,5 x 75	S	25	400,00
M 18 x 1,5 x 80	S	25	410,00
M 18 x 1,5 x 90	S	25	450,00
M 18 x 1,5 x 100	S	25	480,00
M 18 x 1,5 x 120	S	25	560,00
M 18 x 1,5 x 140	S	25	630,00
M 18 x 1,5 x 150	S	25	670,00
M 20 x 1,5 x 60	S	25	425,00
M 20 x 2 x 60	S	25	710,00
M 20 x 1,5 x 65	S	25	460,00
M 20 x 2 x 65	S	25	720,00
M 20 x 1,5 x 70	S	25	405,00
M 20 x 2 x 70	S	25	740,00
M 20 x 1,5 x 75	S	25	415,00
M 20 x 1,5 x 80	S	25	415,00
M 20 x 2 x 80	S	25	750,00
M 20 x 1,5 x 85	S	25	430,00
M 20 x 1,5 x 90	S	25	450,00
M 20 x 1,5 x 100	S	25	485,00
M 20 x 2 x 100	S	25	830,00
M 20 x 1,5 x 110	S	25	540,00
M 20 x 1,5 x 120	S	25	580,00
M 20 x 2 x 120	S	25	990,00
M 20 x 1,5 x 130	S	25	650,00
M 20 x 1,5 x 140	S	25	710,00
M 20 x 1,5 x 150	S	25	720,00
M 20 x 1,5 x 160	S	10	1400,00
M 20 x 1,5 x 170	S	10	1440,00
M 20 x 1,5 x 180	S	10	1480,00
M 20 x 1,5 x 200	S	10	1690,00
M 24 x 1,5 x 70	S	25	420,00

Abmessungen	VE	Stück	€/100/Obf.
M 24 x 2 x 70	S	25	600,00
M 24 x 1,5 x 80	S	25	455,00
M 24 x 2 x 80	S	25	650,00
M 24 x 1,5 x 90	S	25	495,00
M 24 x 2 x 90	S	25	495,00
M 24 x 1,5 x 100	S	10	540,00
M 24 x 2 x 100	S	10	750,00
M 24 x 1,5 x 110	S	10	580,00
M 24 x 2 x 110	S	10	800,00
M 24 x 1,5 x 120	S	10	620,00
M 24 x 2 x 120	S	10	860,00
M 24 x 1,5 x 130	S	10	650,00
M 24 x 2 x 130	S	10	1030,00
M 24 x 1,5 x 140	S	10	690,00
M 24 x 2 x 140	S	10	1120,00
M 24 x 1,5 x 150	S	10	730,00
M 24 x 2 x 150	S	10	1140,00
M 30 x 2 x 90	S	1	1460,00
M 30 x 2 x 100	S	1	1550,00
M 30 x 2 x 110	S	1	1650,00
M 30 x 2 x 120	S	1	1750,00
M 30 x 2 x 130	S	1	1840,00
M 30 x 2 x 140	S	1	1950,00
M 30 x 2 x 150	S	1	2050,00
M 30 x 2 x 160	S	1	2190,00
M 36 x 3 x 110	S	1	2550,00
M 36 x 3 x 120	S	1	2700,00
M 36 x 3 x 130	S	1	2800,00
M 36 x 3 x 140	S	1	2950,00
M 36 x 3 x 150	S	1	3100,00
M 36 x 3 x 160	S	1	3300,00
M 42 x 3 x 140	S	1	4450,00
M 42 x 3 x 160	S	1	4850,00
M 42 x 3 x 180	S	1	5300,00
M 42 x 3 x 200	S	1	5800,00

DIN 00960.810

960

8.8 galvanisch verzinkt

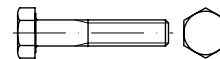

Sechskantschrauben mit Schaft, mit metrischem Feingewinde

kurze Abm. z. T. Gewinde bis Kopf

Maße → TI-15 Anziehmomente → TI-244
 Werkstoffeigensch. → TI-232 Normumstellung → TI-6
 Korrosionsschutz → TI-228

DIN 960 → wird ersetzt durch ISO 8765

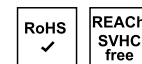

M 12 x 1,5 x 45	S	100	98,00 gal Zn
M 12 x 1,25 x 50	S	100	102,00 gal Zn
M 12 x 1,5 x 50	S	100	102,00 gal Zn
M 12 x 1,25 x 60	S	100	113,00 gal Zn
M 12 x 1,5 x 60	S	100	113,00 gal Zn
M 12 x 1,5 x 65	S	50	123,00 gal Zn
M 12 x 1,25 x 70	S	50	125,00 gal Zn
M 12 x 1,5 x 70	S	50	125,00 gal Zn
M 12 x 1,25 x 80	S	50	140,00 gal Zn
M 12 x 1,5 x 80	S	50	140,00 gal Zn
M 12 x 1,25 x 90	S	50	158,00 gal Zn
M 12 x 1,5 x 90	S	50	158,00 gal Zn
M 12 x 1,25 x 100	S	50	176,00 gal Zn
M 12 x 1,5 x 100	S	50	174,00 gal Zn
M 12 x 1,25 x 110	S	50	226,00 gal Zn
M 12 x 1,5 x 110	S	50	226,00 gal Zn

Abmessungen	VE	Stück	€/100/Obf.
M 12 x 1,25 x 120 S 50	249,00	gal Zn	
M 12 x 1,5 x 120 S 50	249,00	gal Zn	
M 12 x 1,25 x 130 S 50	275,00	gal Zn	
M 12 x 1,5 x 130 S 50	275,00	gal Zn	
M 12 x 1,5 x 140 S 50	305,00	gal Zn	
M 14 x 1,5 x 50 S 50	170,00	gal Zn	
M 14 x 1,5 x 60 S 50	182,00	gal Zn	
M 14 x 1,5 x 65 S 50	198,00	gal Zn	
M 14 x 1,5 x 70 S 50	200,00	gal Zn	
M 14 x 1,5 x 75 S 50	226,00	gal Zn	
M 14 x 1,5 x 80 S 50	227,00	gal Zn	
M 14 x 1,5 x 90 S 50	255,00	gal Zn	
M 14 x 1,5 x 100 S 50	285,00	gal Zn	
M 16 x 1,5 x 55 S 50	200,00	gal Zn	
M 16 x 1,5 x 60 S 50	212,00	gal Zn	
M 16 x 1,5 x 65 S 25	249,00	gal Zn	
M 16 x 1,5 x 70 S 25	255,00	gal Zn	
M 16 x 1,5 x 75 S 25	255,00	gal Zn	
M 16 x 1,5 x 80 S 25	265,00	gal Zn	
M 16 x 1,5 x 85 S 25	285,00	gal Zn	
M 16 x 1,5 x 90 S 25	290,00	gal Zn	
M 16 x 1,5 x 100 S 25	315,00	gal Zn	
M 16 x 1,5 x 110 S 25	395,00	gal Zn	
M 16 x 1,5 x 120 S 25	400,00	gal Zn	
M 16 x 1,5 x 130 S 25	485,00	gal Zn	
M 16 x 1,5 x 140 S 25	530,00	gal Zn	
M 16 x 1,5 x 150 S 25	540,00	gal Zn	
M 16 x 1,5 x 160 S 25	760,00	gal Zn	
M 20 x 1,5 x 65 S 25	475,00	gal Zn	
M 20 x 1,5 x 70 S 25	480,00	gal Zn	
M 20 x 1,5 x 75 S 25	495,00	gal Zn	
M 20 x 1,5 x 80 S 25	495,00	gal Zn	
M 20 x 1,5 x 90 S 25	540,00	gal Zn	
M 20 x 1,5 x 100 S 25	580,00	gal Zn	
M 20 x 1,5 x 110 S 25	650,00	gal Zn	
M 20 x 1,5 x 120 S 25	690,00	gal Zn	
M 20 x 1,5 x 140 S 25	830,00	gal Zn	
M 20 x 1,5 x 150 S 25	860,00	gal Zn	
M 20 x 1,5 x 160 S 10	1540,00	gal Zn	
M 20 x 1,5 x 180 S 10	1640,00	gal Zn	
M 20 x 1,5 x 200 S 10	1880,00	gal Zn	
M 24 x 2 x 80 S 25	840,00	gal Zn	
M 24 x 2 x 90 S 25	910,00	gal Zn	
M 24 x 2 x 100 S 10	970,00	gal Zn	
M 24 x 2 x 120 S 10	1110,00	gal Zn	
M 24 x 2 x 130 S 10	1290,00	gal Zn	
M 24 x 2 x 140 S 10	1410,00	gal Zn	
M 24 x 2 x 150 S 10	1530,00	gal Zn	
M 24 x 2 x 160 S 10	1690,00	gal Zn	
M 24 x 2 x 170 S 10	1820,00	gal Zn	

Abmessungen	VE	Stück	€/100/Obf.
DIN 00960.100			

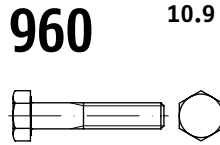

Sechskantschrauben mit Schaft, mit metrischem Feingewinde

kurze Abm. z. T. Gewinde bis Kopf

Maße → TI-15 Anziehmomente → TI-244
 Werkstoffeigensch. → TI-232 Normumstellung → TI-6

DIN 960 → wird ersetzt durch ISO 8765



M 8 x 1 x 30 S 200	31,50
M 8 x 1 x 35 S 200	37,50
M 8 x 1 x 40 S 200	40,00
M 8 x 1 x 45 S 200	44,50
M 8 x 1 x 50 S 200	48,50
M 8 x 1 x 60 S 200	57,00
M 8 x 1 x 70 S 200	66,00
M 8 x 1 x 80 S 200	74,00
M 10 x 1 x 35 S 100	67,00
M 10 x 1,25 x 35 S 100	109,00
M 10 x 1 x 40 S 100	69,00
M 10 x 1,25 x 40 S 100	112,00
M 10 x 1 x 45 S 100	116,00
M 10 x 1,25 x 45 S 100	116,00
M 10 x 1 x 50 S 100	74,00
M 10 x 1,25 x 50 S 100	75,00
M 10 x 1 x 55 S 100	76,00
M 10 x 1,25 x 55 S 100	77,00
M 10 x 1 x 60 S 100	79,00
M 10 x 1,25 x 60 S 100	79,00
M 10 x 1 x 70 S 100	124,00
M 10 x 1,25 x 70 S 100	124,00
M 10 x 1 x 80 S 100	144,00
M 10 x 1,25 x 80 S 100	144,00
M 10 x 1 x 90 S 100	163,00
M 10 x 1,25 x 90 S 100	163,00
M 10 x 1 x 100 S 100	200,00
M 10 x 1,25 x 100 S 100	200,00
M 10 x 1,25 x 110 S 100	216,00
M 12 x 1,25 x 35 S 100	78,00
M 12 x 1,5 x 35 S 100	83,00
M 12 x 1,25 x 40 S 100	86,00
M 12 x 1,5 x 40 S 100	89,00
M 12 x 1,25 x 45 S 100	97,00
M 12 x 1,5 x 45 S 100	97,00
M 12 x 1,25 x 50 S 100	105,00
M 12 x 1,5 x 50 S 100	104,00
M 12 x 1,5 x 55 S 100	107,00
M 12 x 1,25 x 60 S 100	114,00
M 12 x 1,5 x 60 S 100	114,00
M 12 x 1,25 x 65 S 50	103,00
M 12 x 1,5 x 65 S 50	116,00
M 12 x 1,25 x 70 S 50	123,00
M 12 x 1,5 x 70 S 50	123,00
M 12 x 1,5 x 75 S 50	143,00
M 12 x 1,25 x 80 S 50	91,00
M 12 x 1,5 x 80 S 50	144,00
M 12 x 1,25 x 90 S 50	300,00
M 12 x 1,5 x 90 S 50	211,00
M 12 x 1,25 x 100 S 50	233,00
M 12 x 1,5 x 100 S 50	233,00
M 12 x 1,25 x 110 S 50	265,00
M 12 x 1,5 x 110 S 50	265,00

M 12 x 1,25 x 120 S 50	295,00
M 12 x 1,5 x 120 S 25	295,00
M 12 x 1,25 x 130 S 50	305,00
M 12 x 1,5 x 130 S 50	305,00
M 12 x 1,5 x 140 S 50	325,00
M 14 x 1,5 x 50 S 50	144,00
M 14 x 1,5 x 55 S 50	152,00
M 14 x 1,5 x 60 S 50	157,00
M 14 x 1,5 x 65 S 50	183,00
M 14 x 1,5 x 70 S 50	183,00
M 14 x 1,5 x 75 S 50	201,00
M 14 x 1,5 x 80 S 50	201,00
M 14 x 1,5 x 90 S 50	295,00
M 14 x 1,5 x 100 S 25	305,00
M 14 x 1,5 x 110 S 25	340,00
M 14 x 1,5 x 120 S 25	370,00
M 14 x 1,5 x 130 S 25	410,00
M 14 x 1,5 x 140 S 25	425,00
M 14 x 1,5 x 160 S 25	470,00
M 16 x 1,5 x 50 S 25	204,00
M 16 x 1,5 x 55 S 50	212,00
M 16 x 1,5 x 60 S 50	227,00
M 16 x 1,5 x 65 S 25	246,00
M 16 x 1,5 x 70 S 25	260,00
M 16 x 1,5 x 75 S 25	285,00
M 16 x 1,5 x 80 S 25	285,00
M 16 x 1,5 x 85 S 25	285,00
M 16 x 1,5 x 90 S 25	285,00
M 16 x 1,5 x 100 S 25	305,00
M 16 x 1,5 x 110 S 25	390,00
M 16 x 1,5 x 115 S 25	405,00
M 16 x 1,5 x 120 S 25	405,00
M 16 x 1,5 x 130 S 25	445,00
M 16 x 1,5 x 140 S 25	470,00
M 16 x 1,5 x 150 S 25	495,00
M 16 x 1,5 x 160 S 25	550,00
M 18 x 1,5 x 60 S 25	510,00
M 18 x 1,5 x 65 S 25	510,00
M 18 x 1,5 x 70 S 25	510,00
M 18 x 1,5 x 75 S 25	510,00
M 18 x 1,5 x 80 S 25	510,00
M 18 x 1,5 x 90 S 25	590,00
M 18 x 1,5 x 100 S 25	620,00
M 18 x 1,5 x 120 S 10	720,00
M 18 x 1,5 x 140 S 10	830,00
M 18 x 1,5 x 150 S 10	960,00
M 20 x 1,5 x 60 S 25	510,00
M 20 x 2 x 60 S 25	510,00
M 20 x 1,5 x 65 S 25	510,00
M 20 x 2 x 65 S 25	510,00
M 20 x 1,5 x 70 S 25	510,00
M 20 x 2 x 70 S 25	510,00
M 20 x 1,5 x 75 S 25	570,00
M 20 x 1,5 x 80 S 25	560,00
M 20 x 2 x 80 S 25	560,00
M 20 x 1,5 x 85 S 25	640,00
M 20 x 1,5 x 90 S 25	620,00
M 20 x 1,5 x 100 S 25	650,00
M 20 x 1,5 x 110 S 10	670,00
M 20 x 1,5 x 120 S 10	700,00
M 20 x 2 x 120 S 10	700,00
M 20 x 1,5 x 130 S 10	840,00
M 20 x 1,5 x 140 S 10	930,00
M 20 x 1,5 x 150 S 10	1520,00
M 20 x 1,5 x 160 S 10	1660,00
M 20 x 1,5 x 170 S 10	1800,00
M 20 x 1,5 x 180 S 10	1840,00
M 20 x 1,5 x 200 S 10	2340,00
M 22 x 1,5 x 70 S 25	810,00
M 22 x 2 x 70 S 25	1070,00
M 22 x 1,5 x 80 S 25	820,00
M 22 x 1,5 x 90 S 10	900,00
M 22 x 1,5 x 100 S 10	930,00
M 22 x 1,5 x 110 S 10	1010,00
M 22 x 1,5 x 120 S 10	1080,00

Abmessungen	VE	Stück	€/100/Obf.
M 22 x 1,5 x 130 S 10	1120,00		
M 22 x 1,5 x 140 S 10	1130,00		
M 24 x 1,5 x 70 S 25	740,00		
M 24 x 2 x 70 S 25	1290,00		
M 24 x 1,5 x 80 S 25	820,00		
M 24 x 2 x 80 S 25	1550,00		
M 24 x 1,5 x 90 S 10	900,00		
M 24 x 2 x 90 S 25	1800,00		
M 24 x 1,5 x 100 S 10	930,00		
M 24 x 2 x 100 S 10	1850,00		
M 24 x 1,5 x 110 S 10	1010,00		
M 24 x 2 x 110 S 10	1970,00		
M 24 x 1,5 x 120 S 10	1250,00		
M 24 x 2 x 120 S 10	2130,00		
M 24 x 1,5 x 130 S 10	2240,00		
M 24 x 2 x 130 S 10	2240,00		
M 24 x 1,5 x 140 S 10	2750,00		
M 24 x 2 x 150 S 10	3250,00		
M 30 x 2 x 90 S 1	2160,00		
M 30 x 2 x 100 S 1	2300,00		
M 30 x 2 x 110 S 1	2490,00		
M 30 x 2 x 120 S 1	2700,00		
M 30 x 2 x 130 S 1	2850,00		
M 30 x 2 x 140 S 1	3050,00		
M 30 x 2 x 150 S 1	3250,00		
M 30 x 2 x 160 S 1	3450,00		
M 36 x 3 x 110 S 1	2950,00		
M 36 x 3 x 120 S 1	3250,00		
M 36 x 3 x 130 S 1	3500,00		
M 36 x 3 x 140 S 1	3800,00		
M 36 x 3 x 150 S 1	4100,00		
M 36 x 3 x 160 S 1	4350,00		
M 42 x 3 x 140 S 1	4450,00		
M 42 x 3 x 160 S 1	5100,00		
M 42 x 3 x 180 S 1	5800,00		
M 42 x 3 x 200 S 1	6400,00		

DIN	00960.110
960	10.9
	galvanisch verzinkt

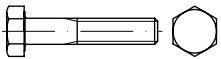

Sechskantschrauben mit Schaft, mit metrischem Feingewinde

kurze Abm. z. T. Gewinde bis Kopf getempert

Achtung! Warneinblender zu Wasserstoffversprödung beachten.

Maße → [TI-15](#) Anziehmomente → [TI-244](#)
 Werkstoffeigensch. → [TI-232](#) Normumstellung → [TI-6](#)
 Korrosionsschutz → [TI-228](#)

DIN 960 → wird ersetzt durch ISO 8765



M 10 x 1 x 45 S 100	134,00 gal Zn
M 12 x 1,5 x 45 S 100	122,00 gal Zn
M 12 x 1,5 x 50 S 100	136,00 gal Zn
M 12 x 1,5 x 60 S 100	148,00 gal Zn
M 12 x 1,5 x 65 S 50	149,00 gal Zn
M 12 x 1,5 x 70 S 50	167,00 gal Zn
M 14 x 1,5 x 50 S 50	205,00 gal Zn
M 14 x 1,5 x 55 S 50	210,00 gal Zn
M 14 x 1,5 x 60 S 50	216,00 gal Zn
M 14 x 1,5 x 65 S 50	229,00 gal Zn
M 14 x 1,5 x 70 S 50	250,00 gal Zn
M 14 x 1,5 x 75 S 25	255,00 gal Zn

Abmessungen	VE	Stück	€/100/Obf.
M 14 x 1,5 x 80 S 50	270,00 gal Zn		
M 14 x 1,5 x 90 S 50	350,00 gal Zn		
M 14 x 1,5 x 100 S 50	370,00 gal Zn		
M 14 x 1,5 x 110 S 25	410,00 gal Zn		
M 16 x 1,5 x 60 S 50	285,00 gal Zn		
M 16 x 1,5 x 70 S 25	155,00 gal Zn		
M 16 x 1,5 x 75 S 25	350,00 gal Zn		
M 16 x 1,5 x 80 S 25	360,00 gal Zn		
M 16 x 1,5 x 90 S 25	375,00 gal Zn		
M 16 x 1,5 x 100 S 25	400,00 gal Zn		
M 16 x 1,5 x 110 S 25	500,00 gal Zn		
M 16 x 1,5 x 120 S 25	510,00 gal Zn		
M 16 x 1,5 x 130 S 25	560,00 gal Zn		
M 20 x 1,5 x 80 S 25	690,00 gal Zn		
M 20 x 1,5 x 90 S 25	770,00 gal Zn		
M 20 x 1,5 x 100 S 25	800,00 gal Zn		
M 20 x 1,5 x 120 S 10	880,00 gal Zn		

Wichtiger Hinweis!

Bei galvanischen Überzügen auf hochfesten und federharten Teilen ($\geq 1000 \text{ N/mm}^2$ oder $\geq 320 \text{ HV}$) ist die Gefahr einer Wasserstoffversprödung (Sprödbruchgefahr) nicht mit Sicherheit auszuschließen (ISO 4042). Durch eine rechtzeitig eingeleitete thermische Nachbehandlung (Tempern) kann die Gefahr eines wasserstoffinduzierten Sprödbruchs im Regelfall verringert werden. Da aber ein Restrisiko nicht mit Sicherheit auszuschließen ist, erfolgen galvanische Überzüge auf derartigen Teilen nur auf ausdrücklichen Wunsch und auf Risiko des Auftraggebers.



DIN	00961.800
961	8.8

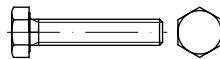

Sechskantschrauben mit Gewinde bis Kopf, mit metrischem Feingewinde

Maße → [TI-15](#) Anziehmomente → [TI-244](#)
 Werkstoffeigensch. → [TI-232](#) Normumstellung → [TI-6](#)

DIN 961 → wird ersetzt durch ISO 8676



M 8 x 1 x 20 S 200	19,40
M 8 x 1 x 25 S 200	22,90
M 8 x 1 x 30 S 200	24,20
M 8 x 1 x 35 S 200	26,50
M 8 x 1 x 40 S 200	28,50
M 8 x 1 x 45 S 200	32,50
M 8 x 1 x 50 S 200	35,00
M 8 x 1 x 60 S 100	62,00
M 8 x 1 x 70 S 100	81,00
M 8 x 1 x 80 S 100	97,00
M 8 x 1 x 90 S 50	130,00
M 8 x 1 x 100 S 50	147,00
M 10 x 1 x 16 S 200	36,00
M 10 x 1,25 x 16 S 200	36,00
M 10 x 1 x 20 S 200	34,00

Abmessungen	VE	Stück	€/100/Obf.
M 10 x 1,25 x 20 S 200	34,00		
M 10 x 1 x 25 S 200	36,00		
M 10 x 1,25 x 25 S 200	36,50		
M 10 x 1 x 30 S 200	38,50		
M 10 x 1,25 x 30 S 200	39,00		
M 10 x 1 x 35 S 100	40,50		
M 10 x 1,25 x 35 S 100	43,00		
M 10 x 1 x 40 S 100	45,00		
M 10 x 1,25 x 40 S 100	47,50		
M 10 x 1 x 45 S 100	50,00		
M 10 x 1,25 x 45 S 100	51,00		
M 10 x 1 x 50 S 100	54,00		
M 10 x 1,25 x 50 S 100	55,00		
M 10 x 1,25 x 55 S 100	59,00		
M 10 x 1 x 60 S 100	98,00		
M 10 x 1,25 x 60 S 100	61,00		
M 10 x 1 x 70 S 100	136,00		
M 10 x 1,25 x 70 S 100	65,00		
M 10 x 1 x 80 S 100	147,00		
M 10 x 1,25 x 80 S 100	68,00		
M 10 x 1 x 90 S 50	182,00		
M 10 x 1,25 x 90 S 50	71,00		
M 10 x 1 x 100 S 50	194,00		
M 10 x 1,25 x 100 S 50	74,00		
M 12 x 1,25 x 20 S 100	56,00		
M 12 x 1,5 x 20 S 100	54,00		
M 12 x 1,25 x 25 S 100	56,00		
M 12 x 1,5 x 25 S 100	54,00		
M 12 x 1,25 x 30 S 100	57,00		
M 12 x 1,5 x 30 S 100	55,00		
M 12 x 1,25 x 35 S 100	60,00		
M 12 x 1,5 x 35 S 100	59,00		
M 12 x 1,25 x 40 S 100	66,00		
M 12 x 1,5 x 40 S 100	63,00		
M 12 x 1,25 x 45 S 100	73,00		
M 12 x 1,5 x 45 S 100	69,00		
M 12 x 1,25 x 50 S 100	76,00		
M 12 x 1,5 x 50 S 100	74,00		
M 12 x 1,5 x 55 S 100	94,00		
M 12 x 1,25 x 60 S 100	114,00		
M 12 x 1,5 x 60 S 100	113,00		
M 12 x 1,25 x 65 S 50	215,00		
M 12 x 1,5 x 65 S 50	134,00		
M 12 x 1,25 x 70 S 50	152,00		
M 12 x 1,5 x 70 S 50	154,00		
M 12 x 1,5 x 75 S 50	170,00		
M 12 x 1,25 x 80 S 50	184,00		
M 12 x 1,5 x 80 S 50	184,00		
M 12 x 1,25 x 90 S 50	217,00		
M 12 x 1,5 x 90 S 50	234,00		
M 12 x 1,25 x 100 S 50	285,00		
M 12 x 1,5 x 100 S 50	285,00		
M 12 x 1,25 x 110 S 50	285,00		
M 12 x 1,5 x 110 S 50	340,00		
M 12 x 1,25 x 120 S 50	315,00		
M 12 x 1,5 x 120 S 50	390,00		
M 12 x 1,25 x 130 S 50	355,00		
M 12 x 1,5 x 130 S 50	440,00		
M 12 x 1,5 x 140 S 50	485,00		
M 14 x 1,5 x 20 S 100	101,00		
M 14 x 1,5 x 25 S 100	101,00		
M 14 x 1,5 x 30 S 100	101,00		
M 14 x 1,5 x 35 S 100	111,00		
M 14 x 1,5 x 40 S 100	123,00		
M 14 x 1,5 x 45 S 50	126,00		
M 14 x 1,5 x 50 S 50	134,00		
M 14 x 1,5 x 55 S 50	154,00		
M 14 x 1,5 x 60 S 50	154,00		
M 14 x 1,5 x 65 S 50	175,00		
M 14 x 1,5 x 70 S 50	195,00		
M 14 x 1,5 x 75 S 50	234,00		
M 14 x 1,5 x 80 S 50	275,00		
M 14 x 1,5 x 90 S 50	330,00		
M 14 x 1,5 x 100 S 50	400,00		
M 14 x 1,5 x 110 S 50	470,00		

Abmessungen	VE	Stück	€/100/Obf.
M 14 x 1,5 x 120 S 50		50	540,00
M 14 x 1,5 x 130 S 50		50	610,00
M 14 x 1,5 x 140 S 50		50	680,00
M 16 x 1,5 x 20 S 50		50	140,00
M 16 x 1,5 x 25 S 100		100	123,00
M 16 x 1,5 x 30 S 50		50	123,00
M 16 x 1,5 x 35 S 50		50	128,00
M 16 x 1,5 x 40 S 50		50	128,00
M 16 x 1,5 x 45 S 50		50	144,00
M 16 x 1,5 x 50 S 50		50	146,00
M 16 x 1,5 x 55 S 50		50	165,00
M 16 x 1,5 x 60 S 50		50	165,00
M 16 x 1,5 x 65 S 50		50	192,00
M 16 x 1,5 x 70 S 50		50	209,00
M 16 x 1,5 x 75 S 25		25	255,00
M 16 x 1,5 x 80 S 25		25	295,00
M 16 x 1,5 x 85 S 25		25	370,00
M 16 x 1,5 x 90 S 25		25	450,00
M 16 x 1,5 x 100 S 25		25	490,00
M 16 x 1,5 x 110 S 25		25	530,00
M 16 x 1,5 x 120 S 25		25	570,00
M 16 x 1,5 x 130 S 25		25	610,00
M 16 x 1,5 x 140 S 25		25	650,00
M 16 x 1,5 x 150 S 25		25	690,00
M 18 x 1,5 x 30 S 50		50	305,00
M 18 x 1,5 x 35 S 50		50	310,00
M 18 x 1,5 x 40 S 50		50	310,00
M 18 x 1,5 x 45 S 50		50	315,00
M 18 x 1,5 x 50 S 50		50	320,00
M 18 x 1,5 x 55 S 25		25	345,00
M 18 x 1,5 x 60 S 25		25	345,00
M 18 x 1,5 x 65 S 25		25	360,00
M 18 x 1,5 x 70 S 25		25	375,00
M 18 x 1,5 x 75 S 25		25	400,00
M 18 x 1,5 x 80 S 25		25	425,00
M 18 x 1,5 x 90 S 25		25	580,00
M 18 x 1,5 x 100 S 25		25	730,00
M 18 x 1,5 x 120 S 25		25	1030,00
M 18 x 1,5 x 140 S 25		25	1320,00
M 18 x 1,5 x 150 S 25		25	1480,00
M 20 x 1,5 x 30 S 25		25	290,00
M 20 x 1,5 x 35 S 25		25	290,00
M 20 x 1,5 x 40 S 25		25	290,00
M 20 x 1,5 x 45 S 25		25	290,00
M 20 x 1,5 x 50 S 25		25	300,00
M 20 x 2 x 50 S 25		25	410,00
M 20 x 1,5 x 55 S 25		25	325,00
M 20 x 2 x 55 S 25		25	530,00
M 20 x 1,5 x 60 S 25		25	325,00
M 20 x 2 x 60 S 25		25	530,00
M 20 x 1,5 x 65 S 25		25	360,00
M 20 x 2 x 65 S 25		25	590,00
M 20 x 1,5 x 70 S 25		25	350,00
M 20 x 2 x 70 S 25		25	660,00
M 20 x 1,5 x 75 S 25		25	385,00
M 20 x 1,5 x 80 S 25		25	405,00
M 20 x 2 x 80 S 25		25	770,00
M 20 x 1,5 x 85 S 25		25	470,00
M 20 x 1,5 x 90 S 25		25	530,00
M 20 x 1,5 x 100 S 25		25	650,00
M 20 x 2 x 100 S 25		25	1010,00
M 20 x 1,5 x 110 S 25		25	780,00
M 20 x 1,5 x 120 S 25		25	910,00
M 20 x 2 x 120 S 25		25	1240,00
M 20 x 1,5 x 130 S 25		25	1050,00
M 20 x 1,5 x 140 S 25		25	1180,00
M 20 x 1,5 x 150 S 25		25	1340,00
M 22 x 1,5 x 50 S 25		25	660,00
M 22 x 1,5 x 60 S 25		25	700,00
M 22 x 1,5 x 70 S 25		25	770,00
M 24 x 1,5 x 50 S 25		25	690,00
M 24 x 2 x 50 S 25		25	690,00
M 24 x 1,5 x 55 S 25		25	910,00
M 24 x 1,5 x 60 S 25		25	990,00
M 24 x 2 x 60 S 25		25	990,00

Abmessungen	VE	Stück	€/100/Obf.
M 24 x 1,5 x 70 S 25		25	1090,00
M 24 x 2 x 70 S 25		25	1090,00
M 24 x 1,5 x 80 S 25		25	1170,00
M 24 x 2 x 80 S 25		25	1170,00
M 24 x 1,5 x 90 S 10		10	1220,00
M 24 x 2 x 90 S 10		10	1220,00
M 24 x 1,5 x 100 S 10		10	1310,00
M 24 x 2 x 100 S 10		10	1310,00
M 24 x 1,5 x 110 S 10		10	1400,00
M 24 x 2 x 110 S 10		10	1400,00
M 24 x 1,5 x 120 S 10		10	1470,00
M 24 x 2 x 120 S 10		10	1470,00
M 24 x 1,5 x 130 S 1		1	1550,00
M 24 x 2 x 130 S 1		1	1550,00
M 24 x 1,5 x 140 S 1		1	1640,00
M 24 x 2 x 140 S 1		1	1640,00
M 24 x 1,5 x 150 S 1		1	1720,00
M 30 x 2 x 60 S 1		1	1310,00
M 30 x 2 x 70 S 1		1	1430,00
M 30 x 2 x 80 S 1		1	1540,00
M 30 x 2 x 90 S 1		1	1630,00
M 30 x 2 x 100 S 1		1	1750,00
M 30 x 2 x 110 S 1		1	1870,00
M 30 x 2 x 120 S 1		1	1990,00
M 30 x 2 x 130 S 1		1	2130,00
M 30 x 2 x 140 S 1		1	2270,00
M 30 x 2 x 150 S 1		1	2390,00
M 30 x 2 x 160 S 1		1	2550,00
M 36 x 3 x 80 S 1		1	2390,00
M 36 x 3 x 90 S 1		1	2600,00
M 36 x 3 x 100 S 1		1	2750,00
M 36 x 3 x 110 S 1		1	2900,00
M 36 x 3 x 120 S 1		1	3050,00
M 36 x 3 x 130 S 1		1	4150,00
M 36 x 3 x 140 S 1		1	3450,00
M 36 x 3 x 150 S 1		1	3700,00
M 36 x 3 x 160 S 1		1	3950,00
M 42 x 3 x 140 S 1		1	5400,00
M 42 x 3 x 160 S 1		1	5900,00
M 42 x 3 x 180 S 1		1	6400,00
M 42 x 3 x 200 S 1		1	6900,00

Abmessungen	VE	Stück	€/100/Obf.
M 10 x 1,25 x 45 S 100		100	63,00 gal Zn
M 10 x 1 x 50 S 100		100	67,00 gal Zn
M 10 x 1,25 x 50 S 100		100	67,00 gal Zn
M 12 x 1,25 x 20 S 100		100	66,00 gal Zn
M 12 x 1,5 x 20 S 100		100	65,00 gal Zn
M 12 x 1,25 x 25 S 100		100	67,00 gal Zn
M 12 x 1,5 x 25 S 100		100	65,00 gal Zn
M 12 x 1,25 x 30 S 100		100	67,00 gal Zn
M 12 x 1,5 x 30 S 100		100	66,00 gal Zn
M 12 x 1,25 x 35 S 100		100	72,00 gal Zn
M 12 x 1,5 x 35 S 100		100	72,00 gal Zn
M 12 x 1,25 x 40 S 100		100	80,00 gal Zn
M 12 x 1,5 x 40 S 100		100	75,00 gal Zn
M 12 x 1,25 x 45 S 100		100	88,00 gal Zn
M 12 x 1,5 x 45 S 100		100	86,00 gal Zn
M 12 x 1,5 x 50 S 100		100	92,00 gal Zn
M 12 x 1,5 x 55 S 100		100	131,00 gal Zn
M 12 x 1,5 x 60 S 100		100	132,00 gal Zn
M 12 x 1,25 x 65 S 50		50	236,00 gal Zn
M 12 x 1,25 x 70 S 50		50	174,00 gal Zn
M 12 x 1,5 x 80 S 50		50	209,00 gal Zn
M 14 x 1,5 x 25 S 100		100	117,00 gal Zn
M 14 x 1,5 x 30 S 100		100	123,00 gal Zn
M 14 x 1,5 x 35 S 100		100	138,00 gal Zn
M 14 x 1,5 x 40 S 100		100	144,00 gal Zn
M 14 x 1,5 x 45 S 50		50	148,00 gal Zn
M 14 x 1,5 x 50 S 50		50	158,00 gal Zn
M 14 x 1,5 x 60 S 50		50	182,00 gal Zn
M 14 x 1,5 x 70 S 50		50	227,00 gal Zn
M 14 x 1,5 x 80 S 50		50	310,00 gal Zn
M 14 x 1,5 x 90 S 50		50	440,00 gal Zn
M 14 x 1,5 x 100 S 50		50	445,00 gal Zn
M 16 x 1,5 x 30 S 50		50	146,00 gal Zn
M 16 x 1,5 x 35 S 50		50	154,00 gal Zn
M 16 x 1,5 x 40 S 50		50	153,00 gal Zn
M 16 x 1,5 x 45 S 50		50	172,00 gal Zn
M 16 x 1,5 x 50 S 50		50	175,00 gal Zn
M 16 x 1,5 x 60 S 50		50	194,00 gal Zn
M 16 x 1,5 x 70 S 50		50	249,00 gal Zn
M 16 x 1,5 x 80 S 25		25	295,00 gal Zn
M 16 x 1,5 x 90 S 25		25	500,00 gal Zn
M 16 x 1,5 x 100 S 25		25	540,00 gal Zn
M 18 x 1,5 x 40 S 50		50	355,00 gal Zn
M 18 x 1,5 x 50 S 50		50	365,00 gal Zn
M 18 x 1,5 x 55 S 25		25	390,00 gal Zn
M 18 x 1,5 x 60 S 25		25	365,00 gal Zn
M 18 x 1,5 x 70 S 25		25	425,00 gal Zn
M 18 x 1,5 x 80 S 25		25	485,00 gal Zn
M 20 x 1,5 x 30 S 50		50	330,00 gal Zn
M 20 x 1,5 x 35 S 50		50	335,00 gal Zn
M 20 x 1,5 x 40 S 50		50	340,00 gal Zn
M 20 x 1,5 x 45 S 50		50	345,00 gal Zn
M 20 x 1,5 x 50 S 25		25	375,00 gal Zn
M 20 x 1,5 x 55 S 25		25	380,00 gal Zn
M 20 x 1,5 x 60 S 25		25	410,00 gal Zn
M 20 x 1,5 x 70 S 25		25	440,00 gal Zn
M 20 x 1,5 x 80 S 25		25	500,00 gal Zn
M 20 x 1,5 x 90 S 25		25	610,00 gal Zn
M 20 x 1,5 x 100 S 25		25	740,00 gal Zn
M 20 x 1,5 x 110 S 10		10	850,00 gal Zn
M 24 x 1,5 x 50 S 25		25	820,00 gal Zn
M 24 x 1,5 x 60 S 25		25	1130,00 gal Zn
M 24 x 1,5 x 80 S 25		25	1340,00 gal Zn
M 24 x 1,5 x 90 S 25		25	1400,00 gal Zn
M 24 x 1,5 x 100 S 25		25	1520,00 gal Zn

DIN	00961.810
961	8.8
	galvanisch verzinkt

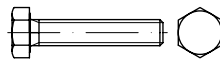

Sechskantschrauben mit Gewinde bis Kopf, mit metrischem Feingewinde

Maße → TI-15 Anziehmomente → TI-244
 Werkstoffeigensch. → TI-232 Normumstellung → TI-6
 Korrosionsschutz → TI-228

DIN 961 → wird ersetzt durch ISO 8676



M 8 x 1 x 20 S 200		200	29,00 gal Zn
M 10 x 1 x 16 S 200		200	42,50 gal Zn
M 10 x 1 x 20 S 200		200	42,50 gal Zn
M 10 x 1,25 x 20 S 200		200	42,50 gal Zn
M 10 x 1 x 25 S 200		200	43,50 gal Zn
M 10 x 1,25 x 25 S 200		200	43,00 gal Zn
M 10 x 1 x 30 S 200		200	47,00 gal Zn
M 10 x 1,25 x 30 S 200		200	46,50 gal Zn
M 10 x 1,25 x 35 S 100		100	52,00 gal Zn
M 10 x 1 x 40 S 100		100	59,00 gal Zn
M 10 x 1,25 x 40 S 100		100	59,00 gal Zn

Abmessungen VE Stück €/100/Obf.
 DIN 00961.100

961 10.9



Sechskantschrauben mit Gewinde bis Kopf, mit metrischem Feingewinde

Maße → TI-15 Anziehmomente → TI-244
 Werkstoffeigensch. → TI-232 Normumstellung → TI-6

DIN 961 → wird ersetzt durch ISO 8676

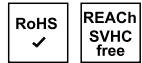

Abmessungen	VE	Stück	€/100/Obf.
M 8 x 1 x 20 S 200	200		29,00
M 8 x 1 x 25 S 200	200		30,50
M 8 x 1 x 30 S 200	200		31,50
M 8 x 1 x 35 S 200	200		37,50
M 8 x 1 x 40 S 200	200		40,00
M 8 x 1 x 45 S 200	200		44,50
M 8 x 1 x 50 S 200	200		48,50
M 8 x 1 x 60 S 200	200		57,00
M 8 x 1 x 70 S 200	200		66,00
M 8 x 1 x 80 S 200	200		62,00
M 8 x 1 x 80 S 200	200		42,00
M 10 x 1,25 x 16 S 200	200		97,00
M 10 x 1 x 20 S 200	200		45,00
M 10 x 1,25 x 20 S 200	200		102,00
M 10 x 1 x 25 S 200	200		47,50
M 10 x 1,25 x 25 S 200	200		107,00
M 10 x 1 x 30 S 200	200		50,00
M 10 x 1,25 x 30 S 200	200		110,00
M 10 x 1 x 35 S 100	100		54,00
M 10 x 1,25 x 35 S 100	100		115,00
M 10 x 1 x 40 S 100	100		57,00
M 10 x 1,25 x 40 S 100	100		124,00
M 10 x 1 x 45 S 100	100		81,00
M 10 x 1,25 x 45 S 100	100		140,00
M 10 x 1 x 50 S 100	100		103,00
M 10 x 1,25 x 50 S 100	100		158,00
M 10 x 1,25 x 55 S 100	100		176,00
M 10 x 1 x 60 S 100	100		137,00
M 10 x 1,25 x 60 S 100	100		212,00
M 10 x 1 x 70 S 100	100		171,00
M 10 x 1,25 x 70 S 100	100		249,00
M 10 x 1 x 80 S 100	100		205,00
M 10 x 1,25 x 80 S 100	100		285,00
M 10 x 1 x 90 S 100	100		239,00
M 10 x 1,25 x 90 S 100	100		325,00
M 10 x 1 x 100 S 100	100		275,00
M 10 x 1,25 x 100 S 100	100		360,00
M 12 x 1,25 x 20 S 100	100		84,00
M 12 x 1,5 x 20 S 100	100		82,00
M 12 x 1,25 x 25 S 100	100		78,00
M 12 x 1,5 x 25 S 100	100		76,00
M 12 x 1,25 x 30 S 100	100		81,00
M 12 x 1,5 x 30 S 100	100		82,00
M 12 x 1,25 x 35 S 100	100		86,00
M 12 x 1,5 x 35 S 100	100		85,00
M 12 x 1,25 x 40 S 100	100		90,00
M 12 x 1,5 x 40 S 100	100		90,00
M 12 x 1,25 x 45 S 100	100		103,00
M 12 x 1,5 x 45 S 100	100		100,00
M 12 x 1,25 x 50 S 100	100		107,00
M 12 x 1,5 x 50 S 100	100		107,00
M 12 x 1,5 x 55 S 100	100		98,00
M 12 x 1,25 x 60 S 100	100		117,00

Abmessungen	VE	Stück	€/100/Obf.
M 12 x 1,5 x 60 S 100	100		116,00
M 12 x 1,25 x 65 S 50	50		125,00
M 12 x 1,5 x 65 S 50	50		129,00
M 12 x 1,25 x 70 S 50	50		131,00
M 12 x 1,5 x 70 S 50	50		140,00
M 12 x 1,5 x 75 S 50	50		152,00
M 12 x 1,25 x 80 S 50	50		146,00
M 12 x 1,5 x 80 S 50	50		163,00
M 12 x 1,25 x 90 S 50	50		160,00
M 12 x 1,5 x 90 S 50	50		175,00
M 12 x 1,25 x 100 S 50	50		174,00
M 12 x 1,5 x 100 S 50	50		188,00
M 12 x 1,25 x 110 S 50	50		188,00
M 12 x 1,5 x 110 S 50	50		199,00
M 12 x 1,25 x 120 S 50	50		203,00
M 12 x 1,5 x 120 S 50	50		210,00
M 12 x 1,25 x 130 S 50	50		216,00
M 12 x 1,5 x 130 S 50	50		223,00
M 12 x 1,5 x 140 S 50	50		236,00
M 14 x 1,5 x 25 S 100	100		153,00
M 14 x 1,5 x 30 S 100	100		138,00
M 14 x 1,5 x 35 S 100	100		144,00
M 14 x 1,5 x 40 S 100	100		148,00
M 14 x 1,5 x 45 S 50	50		154,00
M 14 x 1,5 x 50 S 50	50		160,00
M 14 x 1,5 x 55 S 50	50		209,00
M 14 x 1,5 x 60 S 50	50		209,00
M 14 x 1,5 x 65 S 50	50		335,00
M 14 x 1,5 x 70 S 50	50		450,00
M 14 x 1,5 x 75 S 50	50		485,00
M 14 x 1,5 x 80 S 50	50		520,00
M 14 x 1,5 x 90 S 50	50		590,00
M 14 x 1,5 x 100 S 50	50		660,00
M 14 x 1,5 x 110 S 50	50		730,00
M 14 x 1,5 x 120 S 50	50		2600,00
M 14 x 1,5 x 130 S 50	50		860,00
M 14 x 1,5 x 140 S 50	50		940,00
M 16 x 1,5 x 25 S 50	50		161,00
M 16 x 1,5 x 30 S 50	50		164,00
M 16 x 1,5 x 35 S 50	50		165,00
M 16 x 1,5 x 40 S 50	50		174,00
M 16 x 1,5 x 45 S 50	50		182,00
M 16 x 1,5 x 50 S 50	50		192,00
M 16 x 1,5 x 55 S 50	50		212,00
M 16 x 1,5 x 60 S 50	50		212,00
M 16 x 1,5 x 65 S 50	50		300,00
M 16 x 1,5 x 70 S 50	50		300,00
M 16 x 1,5 x 75 S 25	25		365,00
M 16 x 1,5 x 80 S 25	25		430,00
M 16 x 1,5 x 85 S 25	25		455,00
M 16 x 1,5 x 90 S 25	25		470,00
M 16 x 1,5 x 100 S 25	25		510,00
M 16 x 1,5 x 110 S 25	25		540,00
M 16 x 1,5 x 120 S 25	25		570,00
M 16 x 1,5 x 130 S 25	25		600,00
M 16 x 1,5 x 140 S 25	25		650,00
M 16 x 1,5 x 150 S 25	25		670,00
M 18 x 1,5 x 30 S 50	50		470,00
M 18 x 1,5 x 35 S 50	50		480,00
M 18 x 1,5 x 40 S 50	50		485,00
M 18 x 1,5 x 45 S 50	50		510,00
M 18 x 1,5 x 50 S 50	50		530,00
M 18 x 1,5 x 55 S 25	25		570,00
M 18 x 1,5 x 60 S 25	25		570,00
M 18 x 1,5 x 65 S 25	25		330,00
M 18 x 1,5 x 70 S 25	25		650,00
M 18 x 1,5 x 75 S 25	25		680,00
M 18 x 1,5 x 80 S 25	25		750,00
M 18 x 1,5 x 90 S 25	25		820,00
M 18 x 1,5 x 100 S 25	25		880,00
M 18 x 1,5 x 120 S 25	25		960,00
M 18 x 1,5 x 140 S 25	25		1030,00
M 18 x 1,5 x 150 S 25	25		1120,00
M 20 x 1,5 x 30 S 50	50		395,00
M 20 x 1,5 x 35 S 50	50		400,00

Abmessungen	VE	Stück	€/100/Obf.
M 20 x 1,5 x 40 S 50	50		410,00
M 20 x 1,5 x 45 S 25	25		435,00
M 20 x 1,5 x 50 S 25	25		445,00
M 20 x 2 x 50 S 50	50		670,00
M 20 x 1,5 x 55 S 25	25		460,00
M 20 x 2 x 55 S 25	25		690,00
M 20 x 1,5 x 60 S 25	25		485,00
M 20 x 2 x 60 S 25	25		415,00
M 20 x 1,5 x 65 S 25	25		610,00
M 20 x 2 x 65 S 25	25		520,00
M 20 x 1,5 x 70 S 25	25		640,00
M 20 x 2 x 70 S 25	25		960,00
M 20 x 1,5 x 75 S 25	25		690,00
M 20 x 1,5 x 80 S 25	25		760,00
M 20 x 2 x 80 S 25	25		1140,00
M 20 x 1,5 x 85 S 25	25		780,00
M 20 x 1,5 x 90 S 25	25		810,00
M 20 x 1,5 x 100 S 25	25		890,00
M 20 x 2 x 100 S 25	25		1340,00
M 20 x 1,5 x 110 S 25	25		305,00
M 20 x 1,5 x 120 S 25	25		960,00
M 20 x 2 x 120 S 25	25		1440,00
M 20 x 1,5 x 130 S 25	25		1420,00
M 20 x 1,5 x 140 S 25	25		1900,00
M 20 x 1,5 x 150 S 25	25		2650,00
M 24 x 1,5 x 50 S 25	25		850,00
M 24 x 2 x 50 S 25	25		1000,00
M 24 x 1,5 x 55 S 25	25		880,00
M 24 x 1,5 x 60 S 25	25		910,00
M 24 x 2 x 60 S 25	25		1150,00
M 24 x 1,5 x 70 S 25	25		970,00
M 24 x 2 x 70 S 25	25		1310,00
M 24 x 1,5 x 80 S 25	25		1060,00
M 24 x 2 x 80 S 25	25		1460,00
M 24 x 1,5 x 90 S 10	10		1150,00
M 24 x 2 x 90 S 10	10		1610,00
M 24 x 1,5 x 100 S 10	10		1280,00
M 24 x 2 x 100 S 10	10		1760,00
M 24 x 1,5 x 110 S 10	10		1460,00
M 24 x 2 x 110 S 10	10		1920,00
M 24 x 1,5 x 120 S 10	10		1640,00
M 24 x 2 x 120 S 10	10		2060,00
M 24 x 1,5 x 130 S 10	10		1880,00
M 24 x 2 x 130 S 10	10		2220,00
M 24 x 1,5 x 140 S 10	10		2120,00
M 24 x 2 x 150 S 10	10		2360,00
M 30 x 2 x 60 S 1	1		1580,00
M 30 x 2 x 70 S 1	1		1710,00
M 30 x 2 x 80 S 1	1		1850,00
M 30 x 2 x 90 S 1	1		1960,00
M 30 x 2 x 100 S 1	1		2090,00
M 30 x 2 x 110 S 1	1		2250,00
M 30 x 2 x 120 S 1	1		2380,00
M 30 x 2 x 130 S 1	1		2550,00
M 30 x 2 x 140 S 1	1		2750,00
M 30 x 2 x 150 S 1	1		2900,00
M 30 x 2 x 160 S 1	1		3050,00
M 36 x 3 x 80 S 1	1		2900,00
M 36 x 3 x 90 S 1	1		3100,00
M 36 x 3 x 100 S 1	1		3300,00
M 36 x 3 x 110 S 1	1		3450,00
M 36 x 3 x 120 S 1	1		3650,00
M 36 x 3 x 130 S 1	1		3950,00
M 36 x 3 x 140 S 1	1		4150,00
M 36 x 3 x 150 S 1	1		4450,00
M 36 x 3 x 160 S 1	1		4750,00
M 36 x 3 x 140 S 1	1		5800,00
M 36 x 3 x 160 S 1	1		6700,00
M 36 x 3 x 180 S 1	1		7600,00
M 36 x 3 x 200 S 1	1		8400,00

Abmessungen	VE Stück	€/100/Obf.
DIN	00961.110	
961	10.9	galvanisch verzinkt

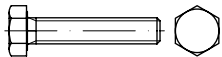

Sechskantschrauben mit Gewinde bis Kopf, mit metrischem Feingewinde
getempert

Achtung! Warneinblender zu Wasserstoffversprödung beachten.

Maße → **TI-15** Anziehungsmomente → **TI-244**
Werkstoffeigensch. → **TI-232** Normumstellung → **TI-6**
Korrosionsschutz → **TI-228**

DIN 961 → wird ersetzt durch ISO 8676



M 8	x 1	x 20	S 200	63,00 gal Zn
M 8	x 1	x 25	S 200	66,00 gal Zn
M 8	x 1	x 30	S 200	67,00 gal Zn
M 8	x 1	x 35	S 200	70,00 gal Zn
M 10	x 1	x 20	S 200	58,00 gal Zn
M 10	x 1	x 30	S 200	61,00 gal Zn
M 10	x 1,25	x 30	S 200	124,00 gal Zn
M 10	x 1	x 35	S 100	66,00 gal Zn
M 10	x 1	x 40	S 100	74,00 gal Zn
M 10	x 1	x 45	S 100	81,00 gal Zn
M 12	x 1,5	x 30	S 100	100,00 gal Zn
M 12	x 1,25	x 35	S 200	104,00 gal Zn
M 12	x 1,5	x 35	S 100	104,00 gal Zn
M 12	x 1,25	x 40	S 100	110,00 gal Zn
M 12	x 1,5	x 40	S 100	110,00 gal Zn
M 12	x 1,5	x 45	S 100	131,00 gal Zn
M 12	x 1,5	x 50	S 100	142,00 gal Zn
M 12	x 1,5	x 55	S 100	155,00 gal Zn
M 12	x 1,5	x 60	S 100	170,00 gal Zn
M 12	x 1,5	x 70	S 100	194,00 gal Zn
M 12	x 1,5	x 80	S 100	242,00 gal Zn
M 14	x 1,5	x 25	S 100	176,00 gal Zn
M 14	x 1,5	x 30	S 100	177,00 gal Zn
M 14	x 1,5	x 35	S 100	177,00 gal Zn
M 14	x 1,5	x 40	S 100	184,00 gal Zn
M 14	x 1,5	x 45	S 50	203,00 gal Zn
M 14	x 1,5	x 50	S 50	211,00 gal Zn
M 14	x 1,5	x 55	S 50	275,00 gal Zn
M 14	x 1,5	x 60	S 50	249,00 gal Zn
M 14	x 1,5	x 65	S 50	495,00 gal Zn

Wichtiger Hinweis!

Bei galvanischen Überzügen auf hochfesten und federharten Teilen ($\geq 1000 \text{ N/mm}^2$ oder $\geq 320 \text{ HV}$) ist die Gefahr einer Wasserstoffversprödung (Sprödbruchgefahr) nicht mit Sicherheit auszuschließen (ISO 4042). Durch eine rechtzeitig eingeleitete thermische Nachbehandlung (Tempern) kann die Gefahr eines wasserstoffinduzierten Sprödbruches im Regelfall verringert werden. Da aber ein Restrisiko nicht mit Sicherheit auszuschließen ist, erfolgen galvanische Überzüge auf derartigen Teilen nur auf ausdrücklichen Wunsch und auf Risiko des Auftraggebers.

Abmessungen	VE Stück	€/100/Obf.		
M 14	x 1,5	x 70	S 50	495,00 gal Zn
M 14	x 1,5	x 80	S 50	570,00 gal Zn
M 16	x 1,5	x 25	S 50	199,00 gal Zn
M 16	x 1,5	x 30	S 50	199,00 gal Zn
M 16	x 1,5	x 35	S 50	201,00 gal Zn
M 16	x 1,5	x 40	S 50	216,00 gal Zn
M 16	x 1,5	x 45	S 50	227,00 gal Zn
M 16	x 1,5	x 50	S 50	239,00 gal Zn
M 16	x 1,5	x 55	S 50	270,00 gal Zn
M 16	x 1,5	x 60	S 50	275,00 gal Zn
M 16	x 1,5	x 70	S 25	370,00 gal Zn
M 16	x 1,5	x 80	S 25	495,00 gal Zn
M 16	x 1,5	x 90	S 25	550,00 gal Zn
M 20	x 1,5	x 40	S 50	485,00 gal Zn
M 20	x 1,5	x 45	S 25	520,00 gal Zn
M 20	x 1,5	x 50	S 25	550,00 gal Zn
M 20	x 1,5	x 55	S 25	570,00 gal Zn
M 20	x 1,5	x 60	S 25	600,00 gal Zn

Abmessungen	VE Stück	€/100/Obf.
DIN	00963.004	
963	Stahl	blank gedreht



Senkschrauben mit Schlitz

Maße → **TI-27** Normumstellung → **TI-11**
Werkstoffeigensch. → **TI-232** REACH → **TI-262**

Rostfrei → **S. 500**
Messing → **S. 627**

DIN 963 → wird ersetzt durch ISO 2009



M 1,4	x 3	S 100	31,50 gedreht
M 1,4	x 5	S 100	33,50 gedreht
M 1,4	x 6	S 100	34,00 gedreht
M 1,4	x 8	S 100	35,50 gedreht
M 1,4	x 10	S 100	39,50 gedreht
M 1,6	x 3	S 100	29,00 gedreht
M 1,6	x 4	S 100	29,50 gedreht
M 1,6	x 5	S 100	30,50 gedreht
M 1,6	x 6	S 100	33,00 gedreht
M 1,6	x 8	S 100	35,50 gedreht
M 1,6	x 10	S 100	39,50 gedreht
M 1,6	x 12	S 100	42,50 gedreht
M 1,6	x 16	S 100	48,00 gedreht

Abmessungen	VE Stück	€/100/Obf.
DIN	00963.400	
963	4.8	

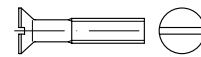

Senkschrauben mit Schlitz

Maße → **TI-27** Normumstellung → **TI-11**
Werkstoffeigensch. → **TI-232** REACH → **TI-262**

Rostfrei → **S. 500**
Messing, Kunststoff → **S. 627**

DIN 963 → wird ersetzt durch ISO 2009



M 2	x 4	S 2000	5,90
M 2	x 5	S 2000	4,10
M 2	x 6	S 2000	2,85
M 2	x 8	S 2000	3,40
M 2	x 10	S 2000	2,70
M 2	x 12	S 2000	3,25
M 2	x 16	S 2000	4,60
M 2	x 20	S 2000	5,00
M 2,5	x 4	S 2000	5,40
M 2,5	x 5	S 2000	4,70
M 2,5	x 6	S 2000	2,85
M 2,5	x 8	S 2000	2,85
M 2,5	x 10	S 2000	3,00
M 2,5	x 12	S 2000	3,15
M 2,5	x 16	S 2000	3,65
M 3	x 4	S 2000	6,30
M 3	x 5	S 2000	4,60
M 3	x 6	S 2000	2,75
M 3	x 8	S 2000	1,35
M 3	x 10	S 2000	1,40
M 3	x 12	S 2000	1,40
M 3	x 16	S 2000	1,65
M 3	x 20	S 2000	2,00
M 3	x 25	S 2000	2,40
M 3	x 30	S 2000	2,80
M 3	x 40	S 1000	5,30
M 4	x 5	S 2000	7,70
M 4	x 6	S 2000	4,20
M 4	x 8	S 2000	1,95
M 4	x 10	S 2000	1,90
M 4	x 12	S 2000	1,95
M 4	x 16	S 2000	2,30
M 4	x 18	S 2000	3,45
M 4	x 20	S 2000	2,70
M 4	x 22	S 1000	4,45
M 4	x 25	S 1000	3,10
M 4	x 30	S 1000	3,70
M 4	x 35	S 1000	4,30
M 4	x 40	S 1000	5,00
M 4	x 45	S 1000	7,70
M 4	x 50	S 1000	7,90
M 5	x 6	S 2000	20,30
M 5	x 8	S 2000	7,90
M 5	x 10	S 2000	3,15
M 5	x 12	S 1000	3,15
M 5	x 16	S 1000	3,60
M 5	x 20	S 1000	3,90
M 5	x 25	S 1000	4,15
M 5	x 30	S 1000	5,50
M 5	x 35	S 500	6,20
M 5	x 40	S 500	6,70
M 5	x 45	S 500	7,80
M 5	x 50	S 500	8,90

Abmessungen	VE	Stück	€/100/Obf.
M 6 x 10	S	1000	10,10
M 6 x 12	S	1000	4,55
M 6 x 16	S	1000	5,10
M 6 x 20	S	1000	5,60
M 6 x 25	S	500	6,30
M 6 x 30	S	500	7,30
M 6 x 35	S	500	8,50
M 6 x 40	S	500	9,50
M 6 x 45	S	500	11,10
M 6 x 50	S	200	12,60
M 6 x 55	S	200	16,80
M 6 x 60	S	200	15,00
M 6 x 65	S	200	19,20
M 6 x 70	S	200	19,20
M 6 x 80	S	200	27,00
M 6 x 100	S	200	36,50
M 8 x 10	S	500	45,50
M 8 x 12	S	500	40,00
M 8 x 16	S	500	11,70
M 8 x 18	S	500	19,20
M 8 x 20	S	500	12,90
M 8 x 25	S	500	13,60
M 8 x 30	S	200	15,50
M 8 x 35	S	200	17,50
M 8 x 40	S	200	24,50
M 8 x 45	S	200	26,00
M 8 x 50	S	200	27,00
M 8 x 55	S	200	40,00
M 8 x 60	S	200	36,00
M 8 x 70	S	200	41,00
M 8 x 80	S	100	46,00
M 8 x 100	S	100	66,00
M 10 x 16	S	200	28,00
M 10 x 20	S	200	22,20
M 10 x 25	S	200	24,00
M 10 x 30	S	200	26,00
M 10 x 35	S	200	28,50
M 10 x 40	S	200	30,00
M 10 x 45	S	100	34,50
M 10 x 50	S	100	39,50
M 10 x 55	S	100	88,00
M 10 x 60	S	100	48,00
M 10 x 70	S	100	60,00
M 10 x 80	S	100	74,00
M 10 x 90	S	100	82,00
M 10 x 100	S	100	91,00
M 12 x 20	S	200	265,00
M 12 x 25	S	200	245,00
M 12 x 30	S	200	204,00
M 12 x 35	S	100	215,00
M 12 x 40	S	100	222,00
M 12 x 45	S	100	241,00
M 12 x 50	S	100	265,00
M 12 x 60	S	50	380,00
M 12 x 70	S	50	445,00
M 12 x 80	S	50	495,00
M 12 x 90	S	50	540,00
M 16 x 30	S	50	380,00
M 16 x 35	S	50	395,00
M 16 x 40	S	50	420,00
M 16 x 45	S	50	430,00
M 16 x 50	S	50	455,00
M 16 x 55	S	50	530,00
M 16 x 60	S	50	485,00
M 16 x 70	S	25	580,00
M 16 x 80	S	25	750,00
M 16 x 90	S	25	850,00
M 20 x 35	S	25	1600,00
M 20 x 40	S	25	1660,00
M 20 x 50	S	25	1750,00
M 20 x 60	S	25	1950,00
M 20 x 70	S	25	2060,00
M 20 x 80	S	25	2180,00

Abmessungen	VE	Stück	€/100/Obf.
M 2 x 4	S	2000	6,60 gal Zn
M 2 x 4	K	200	9,50 gal Zn
M 2 x 5	S	2000	4,40 gal Zn
M 2 x 5	K	200	7,30 gal Zn
M 2 x 6	S	2000	3,30 gal Zn
M 2 x 6	K	200	6,20 gal Zn
M 2 x 8	S	2000	2,85 gal Zn
M 2 x 8	K	200	5,70 gal Zn
M 2 x 10	S	2000	2,90 gal Zn
M 2 x 10	K	200	5,90 gal Zn
M 2 x 12	S	2000	3,55 gal Zn
M 2 x 12	K	200	6,50 gal Zn
M 2 x 16	S	2000	5,30 gal Zn
M 2 x 16	K	200	8,20 gal Zn
M 2 x 20	S	2000	5,60 gal Zn
M 2 x 20	K	200	8,50 gal Zn
M 2,5 x 4	S	2000	4,80 gal Zn
M 2,5 x 4	K	200	9,10 gal Zn
M 2,5 x 5	S	2000	5,30 gal Zn
M 2,5 x 5	K	200	8,20 gal Zn
M 2,5 x 6	S	2000	2,70 gal Zn
M 2,5 x 6	K	200	5,60 gal Zn
M 2,5 x 8	S	2000	3,30 gal Zn
M 2,5 x 8	K	200	6,20 gal Zn
M 2,5 x 10	S	2000	3,30 gal Zn
M 2,5 x 10	K	200	6,20 gal Zn
M 2,5 x 12	S	2000	3,55 gal Zn
M 2,5 x 12	K	200	6,50 gal Zn
M 2,5 x 16	S	2000	4,00 gal Zn
M 2,5 x 16	K	200	6,90 gal Zn
M 2,5 x 20	S	2000	4,85 gal Zn
M 2,5 x 20	K	200	7,80 gal Zn
M 2,5 x 25	K	200	8,80 gal Zn
M 2,5 x 30	K	200	12,90 gal Zn
M 3 x 4	S	2000	7,10 gal Zn
M 3 x 4	K	200	10,00 gal Zn
M 3 x 5	S	2000	5,10 gal Zn
M 3 x 5	K	200	8,20 gal Zn
M 3 x 6	S	2000	3,00 gal Zn
M 3 x 6	K	200	5,90 gal Zn
M 3 x 8	S	2000	1,50 gal Zn
M 3 x 8	K	200	4,45 gal Zn
M 3 x 10	S	2000	1,55 gal Zn
M 3 x 10	K	200	4,45 gal Zn
M 3 x 12	S	2000	1,55 gal Zn
M 3 x 12	K	200	4,55 gal Zn
M 3 x 14	S	2000	1,70 gal Zn
M 3 x 14	K	200	4,60 gal Zn
M 3 x 16	S	2000	1,85 gal Zn
M 3 x 16	K	200	4,75 gal Zn
M 3 x 18	S	2000	3,35 gal Zn
M 3 x 18	K	200	6,30 gal Zn

DIN 963 4.8 galvanisch verzinkt

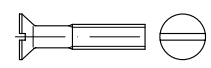

Senkschrauben mit Schlitz

Maße → TI-27 Normumstellung → TI-11
 Werkstoffeigensch. → TI-232 REACH → TI-262
 Korrosionsschutz → TI-228
 Rostfrei → S. 500
 Messing, Kunststoff → S. 627
 DIN 963 → wird ersetzt durch ISO 2009



Abmessungen	VE	Stück	€/100/Obf.
M 3 x 20	S	2000	2,25 gal Zn
M 3 x 20	K	200	5,20 gal Zn
M 3 x 25	S	2000	2,70 gal Zn
M 3 x 25	K	200	5,60 gal Zn
M 3 x 30	S	2000	3,10 gal Zn
M 3 x 30	K	200	3,10 gal Zn
M 3 x 35	S	2000	5,30 gal Zn
M 3 x 35	K	200	8,20 gal Zn
M 3 x 40	K	200	8,80 gal Zn
M 3 x 45	K	200	12,60 gal Zn
M 3 x 50	K	200	13,80 gal Zn
M 3 x 55	S	1000	21,20 gal Zn
M 3 x 60	K	200	20,50 gal Zn
M 4 x 5	S	2000	8,40 gal Zn
M 4 x 5	K	200	11,30 gal Zn
M 4 x 6	S	2000	4,60 gal Zn
M 4 x 6	K	200	7,70 gal Zn
M 4 x 8	S	2000	2,20 gal Zn
M 4 x 8	K	200	5,10 gal Zn
M 4 x 10	S	2000	2,15 gal Zn
M 4 x 10	K	200	5,00 gal Zn
M 4 x 12	S	2000	2,20 gal Zn
M 4 x 12	K	200	5,10 gal Zn
M 4 x 16	S	2000	2,50 gal Zn
M 4 x 16	K	200	5,40 gal Zn
M 4 x 18	K	200	6,80 gal Zn
M 4 x 20	S	2000	2,90 gal Zn
M 4 x 20	K	200	5,90 gal Zn
M 4 x 22	S	1000	4,95 gal Zn
M 4 x 22	K	200	7,90 gal Zn
M 4 x 25	S	1000	3,40 gal Zn
M 4 x 25	K	200	6,30 gal Zn
M 4 x 30	S	1000	4,15 gal Zn
M 4 x 30	K	200	7,20 gal Zn
M 4 x 35	S	1000	4,80 gal Zn
M 4 x 35	K	200	7,80 gal Zn
M 4 x 40	S	1000	5,50 gal Zn
M 4 x 40	K	200	8,50 gal Zn
M 4 x 45	S	1000	8,40 gal Zn
M 4 x 45	K	200	11,30 gal Zn
M 4 x 50	S	1000	8,80 gal Zn
M 4 x 50	K	200	11,70 gal Zn
M 4 x 55	K	200	17,10 gal Zn
M 4 x 60	S	500	13,10 gal Zn
M 4 x 60	K	200	16,00 gal Zn
M 4 x 65	S	200	25,50 gal Zn
M 4 x 70	K	100	27,00 gal Zn
M 4 x 80	K	100	34,00 gal Zn
M 4 x 90	K	100	56,00 gal Zn
M 4 x 100	K	100	60,00 gal Zn
M 5 x 6	S	2000	22,20 gal Zn
M 5 x 6	K	200	25,50 gal Zn
M 5 x 8	S	2000	8,80 gal Zn
M 5 x 8	K	200	11,70 gal Zn
M 5 x 10	S	2000	3,45 gal Zn
M 5 x 10	K	200	6,50 gal Zn
M 5 x 12	S	1000	3,45 gal Zn
M 5 x 12	K	200	6,50 gal Zn
M 5 x 14	S	1000	8,50 gal Zn
M 5 x 16	S	1000	3,90 gal Zn
M 5 x 16	K	200	6,80 gal Zn
M 5 x 18	K	200	8,60 gal Zn
M 5 x 20	S	1000	4,25 gal Zn
M 5 x 20	K	200	7,30 gal Zn
M 5 x 22	K	200	10,50 gal Zn
M 5 x 25	S	1000	4,55 gal Zn
M 5 x 25	K	200	7,60 gal Zn
M 5 x 30	S	1000	6,20 gal Zn
M 5 x 30	K	200	9,10 gal Zn
M 5 x 35	S	500	6,80 gal Zn
M 5 x 35	K	200	9,70 gal Zn
M 5 x 40	S	500	7,30 gal Zn
M 5 x 40	K	200	10,30 gal Zn
M 5 x 45	S	500	8,60 gal Zn
M 5 x 45	K	200	11,50 gal Zn

Abmessungen	VE	Stück	€/100/Obf.
M 5 x 50	S	500	9,90 gal Zn
M 5 x 50	K	200	12,80 gal Zn
M 5 x 55	K	200	21,00 gal Zn
M 5 x 60	K	200	21,50 gal Zn
M 5 x 70	S	200	22,40 gal Zn
M 5 x 70	K	100	28,50 gal Zn
M 5 x 80	S	200	25,50 gal Zn
M 5 x 80	K	100	31,00 gal Zn
M 5 x 90	K	100	59,00 gal Zn
M 5 x 100	K	100	65,00 gal Zn
M 6 x 8	S	1000	14,70 gal Zn
M 6 x 8	K	200	17,60 gal Zn
M 6 x 10	S	1000	11,20 gal Zn
M 6 x 10	K	200	14,10 gal Zn
M 6 x 12	S	1000	5,00 gal Zn
M 6 x 12	K	200	7,90 gal Zn
M 6 x 14	S	1000	8,60 gal Zn
M 6 x 16	S	1000	5,70 gal Zn
M 6 x 16	K	200	8,60 gal Zn
M 6 x 18	K	200	12,00 gal Zn
M 6 x 20	S	1000	6,20 gal Zn
M 6 x 20	K	200	9,10 gal Zn
M 6 x 22	K	200	14,10 gal Zn
M 6 x 25	S	500	7,10 gal Zn
M 6 x 25	K	200	10,00 gal Zn
M 6 x 30	S	500	8,20 gal Zn
M 6 x 30	K	200	11,10 gal Zn
M 6 x 35	S	500	9,40 gal Zn
M 6 x 35	K	200	12,30 gal Zn
M 6 x 40	S	500	10,50 gal Zn
M 6 x 40	K	200	13,40 gal Zn
M 6 x 45	S	500	12,30 gal Zn
M 6 x 45	K	200	18,10 gal Zn
M 6 x 50	K	200	19,70 gal Zn
M 6 x 55	K	100	21,30 gal Zn
M 6 x 60	S	200	16,60 gal Zn
M 6 x 60	K	100	22,40 gal Zn
M 6 x 70	S	200	21,00 gal Zn
M 6 x 70	K	100	33,00 gal Zn
M 6 x 80	S	200	30,00 gal Zn
M 6 x 80	K	100	41,50 gal Zn
M 6 x 90	S	200	37,00 gal Zn
M 6 x 90	K	100	48,50 gal Zn
M 6 x 100	S	200	40,00 gal Zn
M 6 x 100	K	100	52,00 gal Zn
M 8 x 10	K	100	54,00 gal Zn
M 8 x 12	S	500	44,50 gal Zn
M 8 x 12	K	100	47,00 gal Zn
M 8 x 16	S	500	13,00 gal Zn
M 8 x 16	K	100	15,90 gal Zn
M 8 x 18	S	500	21,00 gal Zn
M 8 x 20	S	500	14,20 gal Zn
M 8 x 20	K	100	17,10 gal Zn
M 8 x 25	S	500	15,00 gal Zn
M 8 x 25	K	100	21,00 gal Zn
M 8 x 30	S	200	17,10 gal Zn
M 8 x 30	K	100	22,90 gal Zn
M 8 x 35	S	200	19,30 gal Zn
M 8 x 35	K	100	25,50 gal Zn
M 8 x 40	K	100	30,00 gal Zn
M 8 x 45	K	100	31,50 gal Zn
M 8 x 50	K	100	33,00 gal Zn
M 8 x 55	K	100	47,00 gal Zn
M 8 x 60	K	100	42,50 gal Zn
M 8 x 70	K	100	47,50 gal Zn
M 8 x 80	K	100	54,00 gal Zn
M 8 x 90	K	100	73,00 gal Zn
M 8 x 100	K	100	76,00 gal Zn
M 10 x 16	K	100	34,00 gal Zn
M 10 x 18	K	100	41,50 gal Zn
M 10 x 20	K	100	27,50 gal Zn
M 10 x 25	K	100	29,00 gal Zn
M 10 x 30	K	100	31,50 gal Zn
M 10 x 35	K	100	34,00 gal Zn
M 10 x 40	K	100	36,00 gal Zn

Abmessungen	VE	Stück	€/100/Obf.
M 10 x 45	K	100	46,00 gal Zn
M 10 x 50	K	100	41,50 gal Zn
M 10 x 55	K	100	62,00 gal Zn
M 10 x 60	K	100	48,00 gal Zn
M 10 x 70	K	100	63,00 gal Zn
M 10 x 80	K	100	69,00 gal Zn
M 10 x 90	K	100	92,00 gal Zn
M 10 x 100	K	100	103,00 gal Zn
M 12 x 20	K	100	295,00 gal Zn
M 12 x 25	K	100	275,00 gal Zn
M 12 x 30	K	100	227,00 gal Zn
M 12 x 35	K	100	239,00 gal Zn
M 12 x 40	K	100	249,00 gal Zn
M 12 x 45	K	100	270,00 gal Zn
M 12 x 50	K	100	295,00 gal Zn
M 12 x 55	K	50	395,00 gal Zn
M 12 x 60	K	50	425,00 gal Zn
M 12 x 70	K	50	500,00 gal Zn
M 12 x 80	K	50	550,00 gal Zn
M 12 x 90	K	50	600,00 gal Zn
M 12 x 100	K	50	660,00 gal Zn
M 16 x 30	K	50	420,00 gal Zn
M 16 x 35	K	50	430,00 gal Zn
M 16 x 40	K	50	460,00 gal Zn
M 16 x 45	K	50	475,00 gal Zn
M 16 x 50	K	50	500,00 gal Zn
M 16 x 55	K	50	590,00 gal Zn
M 16 x 60	K	50	540,00 gal Zn
M 16 x 70	K	25	620,00 gal Zn
M 16 x 80	K	25	660,00 gal Zn
M 16 x 90	K	25	720,00 gal Zn
M 20 x 40	K	25	1810,00 gal Zn
M 20 x 45	K	25	1840,00 gal Zn
M 20 x 50	K	25	1920,00 gal Zn
M 20 x 60	K	25	2110,00 gal Zn
M 20 x 70	K	25	2180,00 gal Zn

DIN 00964.400

964 4.8

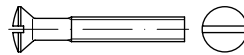

Linsensschrauben mit Schlitz

Maße → TI-39 Normumstellung → TI-11
 Werkstoffeigensch. → TI-232 REACH → TI-262

Rostfrei → S. 502
 Messing → S. 628

DIN 964 → wird ersetzt durch ISO 2010



M 2,5 x 6	S	2000	3,35
M 2,5 x 8	S	2000	3,35
M 4 x 8	S	2000	2,00
M 4 x 10	S	2000	1,95
M 4 x 12	S	2000	2,00
M 4 x 16	S	2000	2,40
M 4 x 20	S	2000	2,80
M 5 x 25	S	1000	4,80
M 5 x 30	S	1000	6,80
M 5 x 35	S	500	6,50

Abmessungen VE Stück €/100/Obf.

DIN 00964.410

964 4.8
galvanisch verzinkt



Linsensschrauben mit Schlitz

Maße → TI-39 Normumstellung → TI-11
 Werkstoffeigensch. → TI-232 REACH → TI-262
 Korrosionsschutz → TI-228

Rostfrei → S. 502
 Messing → S. 628

DIN 964 → wird ersetzt durch ISO 2010



M 3 x 5	K	200	9,40 gal Zn
M 3 x 6	K	200	7,40 gal Zn
M 3 x 8	S	2000	2,15 gal Zn
M 3 x 8	K	200	5,00 gal Zn
M 3 x 10	S	2000	1,70 gal Zn
M 3 x 10	K	200	4,60 gal Zn
M 3 x 12	K	200	4,95 gal Zn
M 3 x 16	K	200	5,50 gal Zn
M 3 x 20	S	2000	3,10 gal Zn
M 3 x 20	K	200	6,00 gal Zn
M 3 x 25	S	2000	3,65 gal Zn
M 3 x 25	K	200	6,60 gal Zn
M 3 x 30	K	200	7,30 gal Zn
M 3 x 35	K	200	9,10 gal Zn
M 3 x 40	K	200	9,90 gal Zn
M 4 x 8	S	2000	2,25 gal Zn
M 4 x 8	K	200	5,30 gal Zn
M 4 x 10	S	2000	2,20 gal Zn
M 4 x 10	K	200	5,10 gal Zn
M 4 x 12	S	2000	2,25 gal Zn
M 4 x 12	K	200	5,30 gal Zn
M 4 x 16	S	2000	2,70 gal Zn
M 4 x 16	K	200	5,60 gal Zn
M 4 x 20	S	2000	3,15 gal Zn
M 4 x 20	K	200	6,10 gal Zn
M 4 x 25	K	200	6,70 gal Zn
M 4 x 30	K	200	7,40 gal Zn
M 4 x 35	K	200	8,20 gal Zn
M 4 x 40	K	200	10,10 gal Zn
M 4 x 45	K	200	11,50 gal Zn
M 4 x 50	K	200	12,30 gal Zn
M 4 x 60	K	200	14,70 gal Zn
M 4 x 70	K	100	23,90 gal Zn
M 4 x 80	K	100	31,50 gal Zn
M 5 x 8	K	200	9,90 gal Zn
M 5 x 10	S	2000	4,20 gal Zn
M 5 x 10	K	200	7,20 gal Zn
M 5 x 12	K	200	6,70 gal Zn
M 5 x 16	S	1000	4,15 gal Zn
M 5 x 16	K	200	7,10 gal Zn
M 5 x 20	K	200	7,60 gal Zn
M 5 x 25	K	200	8,20 gal Zn
M 5 x 30	S	1000	7,40 gal Zn
M 5 x 30	K	200	10,30 gal Zn
M 5 x 35	K	200	10,20 gal Zn
M 5 x 40	S	500	7,90 gal Zn
M 5 x 40	K	200	10,80 gal Zn
M 5 x 45	K	200	14,10 gal Zn
M 5 x 50	K	200	13,60 gal Zn
M 5 x 60	K	200	22,20 gal Zn
M 5 x 80	K	100	29,00 gal Zn
M 6 x 8	K	200	19,30 gal Zn

Abmessungen	VE	Stück	€/100/Obf.
M 6 x 10	K	200	14,20 gal Zn
M 6 x 12	K	200	9,40 gal Zn
M 6 x 16	S	1000	6,20 gal Zn
M 6 x 16	K	200	9,10 gal Zn
M 6 x 20	S	1000	6,70 gal Zn
M 6 x 20	K	200	9,60 gal Zn
M 6 x 25	S	500	7,70 gal Zn
M 6 x 25	K	200	10,60 gal Zn
M 6 x 30	K	200	11,70 gal Zn
M 6 x 35	K	200	13,10 gal Zn
M 6 x 40	K	200	14,20 gal Zn
M 6 x 45	K	200	19,00 gal Zn
M 6 x 50	K	200	23,90 gal Zn
M 6 x 55	K	200	27,00 gal Zn
M 6 x 60	K	100	27,00 gal Zn
M 6 x 70	K	100	38,50 gal Zn
M 6 x 80	K	100	44,00 gal Zn
M 8 x 16	K	100	20,90 gal Zn
M 8 x 20	K	100	20,10 gal Zn
M 8 x 25	K	100	25,00 gal Zn
M 8 x 30	K	100	28,00 gal Zn
M 8 x 35	K	100	33,00 gal Zn
M 8 x 40	K	100	44,50 gal Zn
M 8 x 45	K	100	41,50 gal Zn
M 8 x 50	K	100	42,50 gal Zn
M 8 x 60	K	100	43,00 gal Zn
M 10 x 20	K	100	42,00 gal Zn
M 10 x 25	K	100	43,00 gal Zn
M 10 x 30	K	100	45,00 gal Zn
M 10 x 35	K	100	54,00 gal Zn
M 10 x 40	K	100	57,00 gal Zn
M 10 x 50	K	100	63,00 gal Zn

DIN 00965.404

965 4.8 H



Senkschrauben mit Phillips-Kreuzschlitz H

Maße → **TI-39** Normumstellung → **TI-11**
 Werkstoffeigensch. → **TI-232** REACH → **TI-262**

Rostfrei → **S. 503**

DIN 965 → wird ersetzt durch ISO 7046



M 2,5 x 6-H	S	2000	4,55
M 2,5 x 8-H	S	2000	4,60
M 3 x 5-H	S	2000	5,40
M 3 x 6-H	S	2000	3,70
M 3 x 8-H	S	2000	1,95
M 3 x 10-H	S	2000	2,15
M 3 x 12-H	S	2000	2,20
M 3 x 16-H	S	2000	2,75
M 3 x 20-H	S	2000	2,80
M 3 x 25-H	S	2000	3,95
M 4 x 6-H	S	2000	5,20
M 4 x 8-H	S	2000	2,80
M 4 x 10-H	S	2000	2,85
M 4 x 12-H	S	2000	3,10
M 4 x 16-H	S	2000	3,35
M 4 x 20-H	S	2000	3,65
M 4 x 25-H	S	1000	4,15
M 4 x 30-H	S	1000	5,40
M 5 x 8-H	S	2000	7,30

Abmessungen	VE	Stück	€/100/Obf.
M 5 x 10-H	S	2000	3,90
M 5 x 12-H	S	1000	4,10
M 5 x 16-H	S	1000	4,40
M 5 x 20-H	S	1000	5,00
M 5 x 25-H	S	1000	5,60
M 5 x 40-H	S	500	8,40
M 6 x 10-H	S	1000	9,70
M 6 x 12-H	S	1000	5,70
M 6 x 16-H	S	1000	6,50
M 6 x 20-H	S	1000	7,20
M 6 x 25-H	S	500	8,20
M 6 x 30-H	S	200	9,10
M 6 x 35-H	S	500	10,70
M 8 x 16-H	S	500	14,90
M 8 x 20-H	S	500	15,50
M 8 x 25-H	S	200	17,10
M 8 x 30-H	S	200	19,50

DIN 00965.414

965 4.8 H galvanisch verzinkt



Senkschrauben mit Phillips-Kreuzschlitz H

Maße → **TI-39** Normumstellung → **TI-11**
 Werkstoffeigensch. → **TI-232** REACH → **TI-262**
 Korrosionsschutz → **TI-228**

Rostfrei → **S. 503**

DIN 965 → wird ersetzt durch ISO 7046



M 2 x 5-H	S	2000	4,60 gal Zn
M 2 x 6-H	S	2000	4,60 gal Zn
M 2 x 6-H	K	200	7,60 gal Zn
M 2 x 8-H	S	2000	4,60 gal Zn
M 2 x 8-H	K	200	7,60 gal Zn
M 2 x 10-H	S	2000	4,75 gal Zn
M 2 x 10-H	K	200	7,70 gal Zn
M 2 x 12-H	S	2000	4,85 gal Zn
M 2 x 12-H	K	200	7,80 gal Zn
M 2 x 16-H	S	2000	5,00 gal Zn
M 2 x 16-H	K	200	7,90 gal Zn
M 2 x 20-H	S	2000	5,30 gal Zn
M 2 x 20-H	K	200	8,20 gal Zn
M 2,5 x 4-H	S	2000	11,10 gal Zn
M 2,5 x 4-H	K	200	14,00 gal Zn
M 2,5 x 5-H	S	2000	6,70 gal Zn
M 2,5 x 5-H	K	200	9,60 gal Zn
M 2,5 x 6-H	S	2000	5,00 gal Zn
M 2,5 x 6-H	K	200	8,00 gal Zn
M 2,5 x 8-H	S	2000	4,60 gal Zn
M 2,5 x 8-H	K	200	8,00 gal Zn
M 2,5 x 10-H	S	2000	5,20 gal Zn
M 2,5 x 10-H	K	200	8,20 gal Zn
M 2,5 x 12-H	S	2000	5,30 gal Zn
M 2,5 x 12-H	K	200	8,30 gal Zn
M 2,5 x 16-H	S	2000	5,80 gal Zn
M 2,5 x 16-H	K	200	8,80 gal Zn
M 2,5 x 20-H	S	2000	8,30 gal Zn
M 2,5 x 20-H	K	200	11,20 gal Zn
M 3 x 4-H	S	2000	5,10 gal Zn
M 3 x 4-H	K	200	7,70 gal Zn
M 3 x 5-H	S	2000	5,90 gal Zn
M 3 x 5-H	K	200	8,80 gal Zn
M 3 x 6-H	S	2000	4,15 gal Zn

Abmessungen	VE	Stück	€/100/Obf.
M 3 x 6-H	K	200	7,10 gal Zn
M 3 x 8-H	S	2000	2,20 gal Zn
M 3 x 8-H	K	200	5,20 gal Zn
M 3 x 10-H	S	2000	2,30 gal Zn
M 3 x 10-H	K	200	5,30 gal Zn
M 3 x 12-H	S	2000	2,40 gal Zn
M 3 x 12-H	K	200	5,40 gal Zn
M 3 x 14-H	S	2000	2,80 gal Zn
M 3 x 14-H	K	200	5,80 gal Zn
M 3 x 16-H	S	2000	3,00 gal Zn
M 3 x 16-H	K	200	6,00 gal Zn
M 3 x 18-H	S	2000	3,40 gal Zn
M 3 x 18-H	K	200	6,30 gal Zn
M 3 x 20-H	S	2000	3,15 gal Zn
M 3 x 20-H	K	200	6,10 gal Zn
M 3 x 22-H	S	2000	3,65 gal Zn
M 3 x 22-H	K	200	6,60 gal Zn
M 3 x 25-H	S	2000	4,40 gal Zn
M 3 x 25-H	K	200	7,30 gal Zn
M 3 x 30-H	S	2000	5,40 gal Zn
M 3 x 30-H	K	200	8,60 gal Zn
M 3 x 35-H	S	2000	7,90 gal Zn
M 3 x 40-H	S	1000	9,10 gal Zn
M 3 x 45-H	S	1000	10,30 gal Zn
M 3 x 50-H	S	1000	11,30 gal Zn
M 4 x 5-H	S	2000	5,70 gal Zn
M 4 x 5-H	K	200	8,60 gal Zn
M 4 x 6-H	S	2000	5,70 gal Zn
M 4 x 6-H	K	200	8,60 gal Zn
M 4 x 8-H	S	2000	6,10 gal Zn
M 4 x 8-H	K	200	3,10 gal Zn
M 4 x 8-H	K	200	6,10 gal Zn
M 4 x 10-H	S	2000	3,25 gal Zn
M 4 x 10-H	K	200	6,20 gal Zn
M 4 x 12-H	S	2000	3,35 gal Zn
M 4 x 12-H	K	200	6,30 gal Zn
M 4 x 14-H	S	2000	3,65 gal Zn
M 4 x 14-H	K	200	6,70 gal Zn
M 4 x 16-H	S	2000	3,70 gal Zn
M 4 x 16-H	K	200	6,70 gal Zn
M 4 x 16-H	K	200	4,45 gal Zn
M 4 x 18-H	S	2000	4,45 gal Zn
M 4 x 20-H	S	2000	3,95 gal Zn
M 4 x 20-H	K	200	6,90 gal Zn
M 4 x 25-H	S	1000	4,55 gal Zn
M 4 x 25-H	K	200	7,60 gal Zn
M 4 x 28-H	S	1000	12,80 gal Zn
M 4 x 30-H	S	1000	5,90 gal Zn
M 4 x 30-H	K	200	8,90 gal Zn
M 4 x 35-H	S	1000	7,40 gal Zn
M 4 x 35-H	K	200	10,50 gal Zn
M 4 x 40-H	S	1000	8,60 gal Zn
M 4 x 40-H	K	200	11,50 gal Zn
M 4 x 45-H	S	1000	10,60 gal Zn
M 4 x 45-H	K	200	13,40 gal Zn
M 4 x 50-H	S	1000	12,60 gal Zn
M 4 x 50-H	K	200	15,70 gal Zn
M 4 x 60-H	S	500	18,00 gal Zn
M 4 x 60-H	K	200	21,00 gal Zn
M 4 x 70-H	S	500	24,10 gal Zn
M 4 x 80-H	S	500	31,00 gal Zn
M 4 x 90-H	S	200	83,00 gal Zn
M 5 x 6-H	S	2000	8,20 gal Zn
M 5 x 6-H	K	200	11,50 gal Zn
M 5 x 8-H	S	2000	8,20 gal Zn
M 5 x 8-H	K	200	11,10 gal Zn
M 5 x 10-H	S	2000	4,25 gal Zn
M 5 x 10-H	K	200	7,20 gal Zn
M 5 x 12-H	S	1000	4,40 gal Zn
M 5 x 12-H	K	200	7,30 gal Zn
M 5 x 14-H	S	1000	7,90 gal Zn
M 5 x 14-H	K	200	10,90 gal Zn
M 5 x 16-H	S	1000	4,85 gal Zn
M 5 x 16-H	K	200	7,90 gal Zn
M 5 x 20-H	S	1000	5,50 gal Zn
M 5 x 20-H	K	200	8,50 gal Zn
M 5 x 25-H	S	1000	6,20 gal Zn

Abmessungen	VE	Stück	€/100/Obf.
M 5 x 25 -H	K	200	9,10 gal Zn
M 5 x 30 -H	S	1000	7,80 gal Zn
M 5 x 30 -H	K	200	10,80 gal Zn
M 5 x 35 -H	S	500	8,60 gal Zn
M 5 x 35 -H	K	200	11,70 gal Zn
M 5 x 40 -H	S	500	9,40 gal Zn
M 5 x 40 -H	K	200	12,30 gal Zn
M 5 x 45 -H	S	500	10,90 gal Zn
M 5 x 45 -H	K	200	13,80 gal Zn
M 5 x 50 -H	S	500	15,20 gal Zn
M 5 x 50 -H	K	200	18,10 gal Zn
M 5 x 55 -H	S	200	35,50 gal Zn
M 5 x 60 -H	S	200	19,30 gal Zn
M 5 x 70 -H	S	200	23,40 gal Zn
M 5 x 80 -H	S	200	36,00 gal Zn
M 5 x 90 -H	S	100	51,00 gal Zn
M 6 x 8 -H	S	1000	9,10 gal Zn
M 6 x 8 -H	K	200	12,00 gal Zn
M 6 x 10 -H	S	1000	10,80 gal Zn
M 6 x 10 -H	K	200	13,70 gal Zn
M 6 x 12 -H	S	1000	6,30 gal Zn
M 6 x 12 -H	K	200	9,20 gal Zn
M 6 x 14 -H	S	1000	8,60 gal Zn
M 6 x 16 -H	S	1000	7,20 gal Zn
M 6 x 16 -H	K	200	10,20 gal Zn
M 6 x 18 -H	S	1000	14,60 gal Zn
M 6 x 18 -H	K	200	18,20 gal Zn
M 6 x 20 -H	S	1000	7,90 gal Zn
M 6 x 20 -H	K	200	10,80 gal Zn
M 6 x 25 -H	S	500	8,90 gal Zn
M 6 x 25 -H	K	200	11,80 gal Zn
M 6 x 30 -H	S	500	10,20 gal Zn
M 6 x 30 -H	K	200	13,10 gal Zn
M 6 x 35 -H	S	500	11,80 gal Zn
M 6 x 35 -H	K	200	14,70 gal Zn
M 6 x 40 -H	S	500	13,20 gal Zn
M 6 x 40 -H	K	200	16,10 gal Zn
M 6 x 45 -H	S	200	15,50 gal Zn
M 6 x 50 -H	S	200	17,60 gal Zn
M 6 x 55 -H	S	200	26,00 gal Zn
M 6 x 60 -H	S	200	21,10 gal Zn
M 6 x 70 -H	S	200	26,50 gal Zn
M 6 x 80 -H	S	200	39,50 gal Zn
M 8 x 12 -H	S	500	44,50 gal Zn
M 8 x 16 -H	S	500	16,60 gal Zn
M 8 x 16 -H	K	200	19,50 gal Zn
M 8 x 20 -H	S	500	17,10 gal Zn
M 8 x 20 -H	K	200	20,10 gal Zn
M 8 x 25 -H	S	200	19,00 gal Zn
M 8 x 30 -H	S	200	21,60 gal Zn
M 8 x 35 -H	S	200	26,00 gal Zn
M 8 x 40 -H	S	100	30,50 gal Zn
M 8 x 45 -H	S	100	33,00 gal Zn
M 8 x 50 -H	S	100	34,00 gal Zn
M 8 x 55 -H	S	100	44,00 gal Zn
M 8 x 60 -H	S	100	39,00 gal Zn
M 8 x 70 -H	S	100	47,00 gal Zn
M 8 x 80 -H	S	100	57,00 gal Zn
M 8 x 90 -H	S	100	68,00 gal Zn
M 8 x 100 -H	S	100	78,00 gal Zn
M 10 x 16 -H	S	100	66,00 gal Zn
M 10 x 20 -H	S	100	38,50 gal Zn
M 10 x 25 -H	S	100	40,00 gal Zn
M 10 x 30 -H	S	100	44,00 gal Zn
M 10 x 40 -H	S	100	50,00 gal Zn
M 10 x 45 -H	S	100	54,00 gal Zn
M 10 x 50 -H	S	100	57,00 gal Zn
M 10 x 60 -H	S	100	72,00 gal Zn

Abmessungen	VE	Stück	€/100/Obf.
-------------	----	-------	------------

DIN	00965.301		
965	4.8	Z	
galvanisch verzinkt			



Senkschrauben mit Pozidriv-Kreuzschlitz Z

Maße → **TI-39** Normumstellung → **TI-11**
 Werkstoffeigensch. → **TI-232** REACH → **TI-262**
 Korrosionsschutz → **TI-228**

Rostfrei → **S. 504**
 DIN 965 → wird ersetzt durch ISO 7046



M 2,5 x 4 -Z	S	2000	11,10 gal Zn
M 2,5 x 5 -Z	S	2000	6,70 gal Zn
M 2,5 x 6 -Z	S	2000	5,00 gal Zn
M 2,5 x 8 -Z	S	2000	4,60 gal Zn
M 2,5 x 10 -Z	S	2000	5,20 gal Zn
M 2,5 x 12 -Z	S	2000	5,30 gal Zn
M 3 x 4 -Z	S	2000	5,70 gal Zn
M 3 x 5 -Z	S	2000	6,20 gal Zn
M 3 x 6 -Z	S	2000	4,15 gal Zn
M 3 x 8 -Z	S	2000	2,20 gal Zn
M 3 x 10 -Z	S	2000	2,30 gal Zn
M 3 x 12 -Z	S	2000	2,40 gal Zn
M 3 x 16 -Z	S	2000	3,00 gal Zn
M 3 x 20 -Z	S	2000	3,15 gal Zn
M 3 x 25 -Z	S	2000	4,40 gal Zn
M 4 x 6 -Z	S	2000	5,70 gal Zn
M 4 x 8 -Z	S	2000	3,10 gal Zn
M 4 x 10 -Z	S	2000	3,25 gal Zn
M 4 x 12 -Z	S	2000	3,35 gal Zn
M 4 x 16 -Z	S	2000	3,70 gal Zn
M 4 x 20 -Z	S	2000	3,95 gal Zn
M 4 x 25 -Z	S	1000	4,55 gal Zn
M 4 x 30 -Z	S	1000	5,90 gal Zn
M 4 x 35 -Z	S	1000	7,40 gal Zn
M 4 x 40 -Z	S	1000	8,60 gal Zn
M 4 x 45 -Z	S	500	10,60 gal Zn
M 4 x 50 -Z	S	500	12,60 gal Zn
M 5 x 8 -Z	S	2000	8,20 gal Zn
M 5 x 10 -Z	S	2000	4,25 gal Zn
M 5 x 12 -Z	S	1000	4,40 gal Zn
M 5 x 16 -Z	S	1000	4,85 gal Zn
M 5 x 20 -Z	S	1000	5,50 gal Zn
M 5 x 25 -Z	S	1000	6,20 gal Zn
M 5 x 30 -Z	S	1000	7,80 gal Zn
M 5 x 35 -Z	S	500	8,60 gal Zn
M 5 x 40 -Z	S	500	9,40 gal Zn
M 5 x 45 -Z	S	500	10,90 gal Zn
M 5 x 50 -Z	S	500	15,20 gal Zn
M 5 x 60 -Z	S	200	19,30 gal Zn
M 5 x 70 -Z	S	200	23,40 gal Zn
M 5 x 80 -Z	S	200	36,00 gal Zn
M 6 x 10 -Z	S	1000	10,80 gal Zn
M 6 x 12 -Z	S	1000	6,30 gal Zn
M 6 x 16 -Z	S	1000	7,20 gal Zn
M 6 x 20 -Z	S	1000	7,90 gal Zn
M 6 x 25 -Z	S	500	8,90 gal Zn
M 6 x 30 -Z	S	500	9,00 gal Zn
M 6 x 35 -Z	S	500	11,80 gal Zn
M 6 x 40 -Z	S	500	13,20 gal Zn
M 6 x 45 -Z	S	200	15,50 gal Zn
M 6 x 50 -Z	S	200	17,60 gal Zn
M 6 x 60 -Z	S	200	21,10 gal Zn

Abmessungen	VE	Stück	€/100/Obf.
-------------	----	-------	------------

~DIN	00965.415		
965	4.8	ISR	
galvanisch verzinkt			



Senkschrauben, ISR = Innensechsrund

~ ISO 14581

Maße → **TI-39** Korrosionsschutz → **TI-228**
 Werkstoffeigensch. → **TI-232** REACH → **TI-262**

Rostfrei → **S. 505**



M 3 x 4 -T10	S	2000	7,60 gal Zn
M 3 x 5 -T10	S	2000	7,60 gal Zn
M 3 x 6 -T10	S	2000	5,00 gal Zn
M 3 x 8 -T10	S	2000	2,65 gal Zn
M 3 x 10 -T10	S	2000	2,80 gal Zn
M 3 x 12 -T10	S	2000	2,85 gal Zn
M 3 x 16 -T10	S	2000	3,60 gal Zn
M 3 x 20 -T10	S	2000	3,80 gal Zn
M 3 x 25 -T10	S	2000	4,00 gal Zn
M 4 x 6 -T20	S	2000	6,90 gal Zn
M 4 x 8 -T20	S	2000	3,75 gal Zn
M 4 x 10 -T20	S	2000	3,90 gal Zn
M 4 x 12 -T20	S	2000	4,00 gal Zn
M 4 x 16 -T20	S	2000	4,45 gal Zn
M 4 x 20 -T20	S	2000	4,75 gal Zn
M 4 x 25 -T20	S	1000	5,50 gal Zn
M 4 x 30 -T20	S	1000	7,10 gal Zn
M 4 x 35 -T20	S	1000	8,90 gal Zn
M 4 x 40 -T20	S	1000	10,30 gal Zn
M 5 x 8 -T25	S	2000	9,80 gal Zn
M 5 x 10 -T25	S	2000	5,10 gal Zn
M 5 x 12 -T25	S	1000	5,30 gal Zn
M 5 x 16 -T25	S	1000	5,90 gal Zn
M 5 x 20 -T25	S	1000	6,60 gal Zn
M 5 x 25 -T25	S	1000	7,40 gal Zn
M 5 x 30 -T25	S	1000	9,40 gal Zn
M 5 x 35 -T25	S	500	10,40 gal Zn
M 5 x 40 -T25	S	500	11,20 gal Zn
M 5 x 45 -T25	S	500	13,10 gal Zn
M 5 x 50 -T25	S	500	18,20 gal Zn
M 6 x 10 -T30	S	1000	13,00 gal Zn
M 6 x 12 -T30	S	1000	7,60 gal Zn
M 6 x 16 -T30	S	1000	8,60 gal Zn
M 6 x 20 -T30	S	1000	9,50 gal Zn
M 6 x 25 -T30	S	500	10,60 gal Zn
M 6 x 30 -T30	S	500	12,10 gal Zn
M 6 x 35 -T30	S	500	14,10 gal Zn
M 6 x 40 -T30	S	500	15,80 gal Zn
M 6 x 50 -T30	S	200	21,10 gal Zn
M 6 x 60 -T30	S	200	25,50 gal Zn

Abmessungen	VE Stück	€/100/Obf.
DIN	00966.414	
966	4.8	H
galvanisch verzinkt		



Linsensenschrauben mit Phillips-Kreuzschlitz H

Maße → **TI-39** Normumstellung → **TI-11**
 Werkstoffeigensch. → **TI-232** REACH → **TI-262**
 Korrosionsschutz → **TI-228**

Rostfrei → **S. 506**

DIN 966 → wird ersetzt durch ISO 7047



M 2,5 x 5 -H	S 2000	8,40 gal Zn
M 2,5 x 6 -H	S 2000	6,00 gal Zn
M 2,5 x 6 -H	K 200	8,90 gal Zn
M 2,5 x 8 -H	S 2000	6,20 gal Zn
M 2,5 x 8 -H	K 200	9,10 gal Zn
M 2,5 x 10 -H	S 2000	6,20 gal Zn
M 2,5 x 10 -H	K 200	9,10 gal Zn
M 3 x 5 -H	S 2000	6,00 gal Zn
M 3 x 5 -H	K 200	8,90 gal Zn
M 3 x 6 -H	S 2000	4,55 gal Zn
M 3 x 6 -H	K 200	7,60 gal Zn
M 3 x 8 -H	S 2000	2,40 gal Zn
M 3 x 8 -H	K 200	5,30 gal Zn
M 3 x 10 -H	S 2000	2,45 gal Zn
M 3 x 10 -H	K 200	5,40 gal Zn
M 3 x 12 -H	S 2000	3,00 gal Zn
M 3 x 12 -H	K 200	5,90 gal Zn
M 3 x 16 -H	S 2000	3,70 gal Zn
M 3 x 16 -H	K 200	6,60 gal Zn
M 3 x 20 -H	S 2000	3,90 gal Zn
M 3 x 20 -H	K 200	6,80 gal Zn
M 3 x 25 -H	S 2000	5,00 gal Zn
M 3 x 25 -H	K 200	8,90 gal Zn
M 3 x 30 -H	S 2000	6,30 gal Zn
M 3 x 30 -H	K 200	9,20 gal Zn
M 3 x 35 -H	S 2000	9,20 gal Zn
M 3 x 40 -H	S 1000	10,50 gal Zn
M 4 x 6 -H	S 2000	6,70 gal Zn
M 4 x 6 -H	K 200	9,60 gal Zn
M 4 x 8 -H	S 2000	3,30 gal Zn
M 4 x 8 -H	K 200	6,20 gal Zn
M 4 x 10 -H	S 2000	3,40 gal Zn
M 4 x 10 -H	K 200	6,30 gal Zn
M 4 x 12 -H	S 2000	3,60 gal Zn
M 4 x 12 -H	K 200	6,50 gal Zn
M 4 x 16 -H	S 2000	3,95 gal Zn
M 4 x 16 -H	K 200	6,90 gal Zn
M 4 x 20 -H	S 2000	4,25 gal Zn
M 4 x 20 -H	K 200	7,20 gal Zn
M 4 x 25 -H	S 1000	4,85 gal Zn
M 4 x 25 -H	K 200	7,80 gal Zn
M 4 x 30 -H	S 1000	6,80 gal Zn
M 4 x 30 -H	K 200	9,70 gal Zn
M 4 x 35 -H	S 1000	8,60 gal Zn
M 4 x 35 -H	K 200	11,50 gal Zn
M 4 x 40 -H	S 1000	9,90 gal Zn
M 4 x 40 -H	K 200	12,80 gal Zn
M 4 x 45 -H	S 1000	11,40 gal Zn
M 4 x 45 -H	K 200	14,30 gal Zn
M 4 x 50 -H	S 1000	15,80 gal Zn
M 4 x 50 -H	K 200	18,70 gal Zn
M 4 x 60 -H	S 500	22,70 gal Zn

M 5 x 8 -H	S 2000	9,40 gal Zn
M 5 x 8 -H	K 200	12,30 gal Zn
M 5 x 10 -H	S 2000	4,60 gal Zn
M 5 x 10 -H	K 200	7,60 gal Zn
M 5 x 12 -H	S 1000	4,70 gal Zn
M 5 x 12 -H	K 200	7,60 gal Zn
M 5 x 16 -H	S 1000	5,30 gal Zn
M 5 x 16 -H	K 200	8,20 gal Zn
M 5 x 20 -H	S 1000	6,70 gal Zn
M 5 x 20 -H	K 200	9,60 gal Zn
M 5 x 25 -H	S 1000	6,70 gal Zn
M 5 x 25 -H	K 200	9,60 gal Zn
M 5 x 30 -H	S 1000	8,50 gal Zn
M 5 x 30 -H	K 200	11,40 gal Zn
M 5 x 35 -H	S 500	9,40 gal Zn
M 5 x 40 -H	S 500	10,10 gal Zn
M 5 x 45 -H	S 500	12,60 gal Zn
M 5 x 50 -H	S 500	16,50 gal Zn
M 5 x 60 -H	S 200	22,40 gal Zn
M 5 x 70 -H	S 200	33,00 gal Zn
M 5 x 80 -H	S 200	42,00 gal Zn
M 6 x 10 -H	S 1000	11,50 gal Zn
M 6 x 10 -H	K 200	14,40 gal Zn
M 6 x 12 -H	S 1000	6,90 gal Zn
M 6 x 12 -H	K 200	9,90 gal Zn
M 6 x 16 -H	S 1000	7,80 gal Zn
M 6 x 16 -H	K 200	10,70 gal Zn
M 6 x 20 -H	S 1000	8,60 gal Zn
M 6 x 20 -H	K 200	11,50 gal Zn
M 6 x 25 -H	S 500	9,70 gal Zn
M 6 x 30 -H	S 500	11,10 gal Zn
M 6 x 35 -H	S 500	12,80 gal Zn
M 6 x 40 -H	S 500	14,30 gal Zn
M 6 x 45 -H	S 500	17,80 gal Zn
M 6 x 50 -H	S 200	18,90 gal Zn
M 6 x 60 -H	S 200	23,80 gal Zn
M 6 x 70 -H	S 200	33,00 gal Zn
M 6 x 80 -H	S 200	47,00 gal Zn
M 8 x 16 -H	S 500	31,50 gal Zn
M 8 x 20 -H	S 500	19,40 gal Zn
M 8 x 25 -H	S 200	23,40 gal Zn
M 8 x 30 -H	S 200	26,50 gal Zn
M 8 x 35 -H	S 200	30,00 gal Zn
M 8 x 40 -H	S 100	38,00 gal Zn
M 8 x 45 -H	S 100	40,00 gal Zn
M 8 x 50 -H	S 100	41,50 gal Zn
M 8 x 60 -H	S 100	48,50 gal Zn
M 8 x 70 -H	S 100	60,00 gal Zn
M 8 x 80 -H	S 100	72,00 gal Zn

~DIN	00975.000
------	-----------

975* Stahl



Gewindestangen, Länge 1000 mm

(*entsprechend DIN 976-1, Form A)

Rostfrei → **S. 507**
 Messing, Kunststoff → **S. 630**

Farbkennzeichnung (als Ersatz für Stempelung)
 → Infoeinblender



M 2	S 1	1660,00
M 2,5	S 1	620,00
M 3	S 1	154,00

M 3,5	S 1	670,00
M 4	S 1	112,00
M 5	S 1	125,00
M 6	S 1	137,00
M 8	S 1	217,00
M 10	S 1	345,00
M 12	S 1	495,00
M 14	S 1	680,00
M 16	S 1	860,00
M 18	S 1	1150,00
M 20	S 1	1380,00
M 22	S 1	1720,00
M 24	S 1	1970,00
M 27	S 1	2650,00
M 30	S 1	3450,00
M 33	S 1	5300,00
M 36	S 1	6300,00
M 39	S 1	8200,00
M 42	S 1	10300,00
M 45	S 1	12100,00
M 48	S 1	14800,00
M 52	S 1	17500,00
M 56	S 1	21100,00

Farb-Kennzeichnung für Gewindestangen



Fkl./Werkstoff	Farbe	~RAL-Nr.
St/4..6/4..8/5..8/MS/Kst.	ohne	-
5.6	braun	8015
5.8	blau	5010
8.8	gelb	1023
10.9	weiß	1013
12.9	schwarz	9017

Farbe anstatt Stempelung nach DIN 976-1

~DIN	00975.010
------	-----------

975* Stahl galvanisch verzinkt



Gewindestangen, Länge 1000 mm

(*entsprechend DIN 976-1, Form A)

Korrosionsschutz → **TI-228**

Rostfrei → **S. 507**
 Messing, Kunststoff → **S. 630**

Farbkennzeichnung (als Ersatz für Stempelung)
 → Infoeinblender

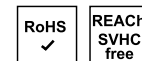

M 2	S 1	1840,00 gal Zn
M 2,5	S 1	670,00 gal Zn
M 3	S 1	211,00 gal Zn
M 3,5	S 1	960,00 gal Zn
M 4	S 1	160,00 gal Zn
M 5	S 1	172,00 gal Zn
M 6	S 1	203,00 gal Zn
M 7	S 1	2400,00 gal Zn
M 8	S 1	310,00 gal Zn

Abmessungen	VE	Stück	€/100/Obf.
M 10	S	1	445,00 gal Zn
M 12	S	1	630,00 gal Zn
M 14	S	1	920,00 gal Zn
M 16	S	1	1170,00 gal Zn
M 18	S	1	1460,00 gal Zn
M 20	S	1	1800,00 gal Zn
M 22	S	1	2200,00 gal Zn
M 24	S	1	2460,00 gal Zn
M 27	S	1	3450,00 gal Zn
M 30	S	1	4250,00 gal Zn
M 33	S	1	6800,00 gal Zn
M 36	S	1	7800,00 gal Zn
M 39	S	1	10300,00 gal Zn
M 42	S	1	11500,00 gal Zn
M 45	S	1	15700,00 gal Zn
M 48	S	1	18100,00 gal Zn

~DIN	00975.016
975*	Stahl 2000 galvanisch verzinkt



Gewindestangen, Länge 2000 mm

(*entsprechend DIN 976-1, Form A)

Korrosionsschutz → TI-228

Rostfrei → S. 507

Farbkennzeichnung (als Ersatz für Stempelung) → Infoeinblender

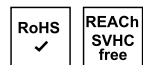

M 6	x 2000	S	1	415,00 gal Zn
M 8	x 2000	S	1	620,00 gal Zn
M 10	x 2000	S	1	890,00 gal Zn
M 12	x 2000	S	1	1260,00 gal Zn
M 14	x 2000	S	1	1830,00 gal Zn
M 16	x 2000	S	1	2320,00 gal Zn
M 18	x 2000	S	1	2950,00 gal Zn
M 20	x 2000	S	1	3650,00 gal Zn
M 22	x 2000	S	1	4450,00 gal Zn
M 24	x 2000	S	1	4950,00 gal Zn
M 27	x 2000	S	1	6900,00 gal Zn
M 30	x 2000	S	1	8500,00 gal Zn
M 36	x 2000	S	1	29000,00 gal Zn

Abmessungen	VE	Stück	€/100/Obf.
~DIN	00975.030		
975*	Stahl		galv. verz. 8 DiSP



Gewindestangen, Länge 1000 mm

(*entsprechend DIN 976-1, Form A)

Korrosionsschutz → TI-228

Rostfrei → S. 507

Messing, Kunststoff → S. 630

Farbkennzeichnung (als Ersatz für Stempelung) → Infoeinblender



M 6	S	1	920,00 gal ZnDi
M 8	S	1	1410,00 gal ZnDi
M 10	S	1	2020,00 gal ZnDi
M 12	S	1	2900,00 gal ZnDi
M 16	S	1	5300,00 gal ZnDi
M 20	S	1	8300,00 gal ZnDi

~DIN	00975.005
975*	Stahl Fein



Gewindestangen, Länge 1000 mm, mit metrischem Feingewinde

(*entsprechend DIN 976-1, Form A)

Farbkennzeichnung (als Ersatz für Stempelung) → Infoeinblender



M 8	x 1	S	1	1670,00
M 10	x 1	S	1	1840,00
M 12	x 1,5	S	1	2000,00
M 14	x 1,5	S	1	2160,00
M 16	x 1,5	S	1	3000,00
M 18	x 1,5	S	1	3950,00
M 20	x 1,5	S	1	4100,00
M 24	x 1,5	S	1	7600,00
M 24	x 2	S	1	10800,00
M 30	x 1,5	S	1	12300,00
M 30	x 2	S	1	14700,00
M 36	x 1,5	S	1	23500,00

Abmessungen	VE	Stück	€/100/Obf.
~DIN	00975.015		
975*	Stahl		Fein galvanisch verzinkt

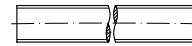

Gewindestangen, Länge 1000 mm, mit metrischem Feingewinde

(*entsprechend DIN 976-1, Form A)

Korrosionsschutz → TI-228

Rostfrei → S. 507

Messing, Kunststoff → S. 630

Farbkennzeichnung (als Ersatz für Stempelung) → Infoeinblender

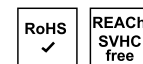

M 12	x 1,5	S	1	2260,00 gal Zn
M 14	x 1,5	S	1	2360,00 gal Zn
M 16	x 1,5	S	1	3400,00 gal Zn
M 18	x 1,5	S	1	4250,00 gal Zn
M 20	x 1,5	S	1	4700,00 gal Zn
M 24	x 1,5	S	1	8200,00 gal Zn
M 24	x 2	S	1	12000,00 gal Zn

Farb-Kennzeichnung für Gewindestangen



Fkl./Werkstoff	Farbe	~RAL-Nr.
St/4..6/4..8/5..8/MS/Kst.	ohne	-
5.6	braun	8015
5.8	blau	5010
8.8	gelb	1023
10..9	weiß	1013
12.9	schwarz	9017

Farbe anstatt Stempelung nach DIN 976-1

Abmessungen	VE Stück	€/100/Obf.
~DIN	00975.004	
975*	Stahl	Links



Gewindestangen, Länge 1000 mm, mit metrischem Linksgewinde

(*entsprechend DIN 976-1, Form A)

Rostfrei → S. 508

Farbkennzeichnung (als Ersatz für Stempelung) → Infoeinblender

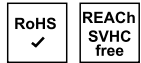

M 8 -LH	S	1	530,00
M 10 -LH	S	1	600,00
M 12 -LH	S	1	1020,00
M 14 -LH	S	1	1310,00
M 16 -LH	S	1	1920,00
M 18 -LH	S	1	2800,00
M 20 -LH	S	1	2950,00
M 24 -LH	S	1	4550,00
M 30 -LH	S	1	6700,00

~DIN	00975.014
975*	Stahl Links galvanisch verzinkt



Gewindestangen, Länge 1000 mm, mit metrischem Linksgewinde

(*entsprechend DIN 976-1, Form A)

Korrosionsschutz → TI-228

Rostfrei → S. 508

Farbkennzeichnung (als Ersatz für Stempelung) → Infoeinblender



M 10 -LH	S	1	1150,00 gal Zn
M 12 -LH	S	1	1830,00 gal Zn
M 16 -LH	S	1	3400,00 gal Zn
M 20 -LH	S	1	5300,00 gal Zn
M 24 -LH	S	1	7200,00 gal Zn

Abmessungen	VE Stück	€/100/Obf.
~DIN	00975.007	
975	Stahl	BSW



Gewindestangen, Länge 1000 mm, mit Whitworth-Regelgewinde

Farbkennzeichnung (als Ersatz für Stempelung) → Infoeinblender



Gewinde Ø

WW 1/2	S	1	690,00
WW 5/8	S	1	1510,00
WW 3/4	S	1	2100,00
WW 7/8	S	1	2650,00
WW 1	S	1	3250,00

~DIN	00975.500
975*	5.6



Gewindestangen, Länge 1000 mm

(*entsprechend DIN 976-1, Form A)

Werkstoffeigensch. → TI-232 Anziehmomente → TI-244

Rostfrei → S. 507

Messing, Kunststoff → S. 630

Farbkennzeichnung (als Ersatz für Stempelung) → Infoeinblender



M 8	S	1	1840,00
M 10	S	1	2100,00
M 12	S	1	2700,00
M 16	S	1	3600,00
M 20	S	1	7200,00
M 24	S	1	10700,00
M 30	S	1	17700,00
M 36	S	1	27900,00

Abmessungen	VE Stück	€/100/Obf.
~DIN	00975.510	
975*	5.6	galvanisch verzinkt



Gewindestangen, Länge 1000 mm

(*entsprechend DIN 976-1, Form A)

Werkstoffeigensch. → TI-232 Anziehmomente → TI-244
Korrosionsschutz → TI-228

Rostfrei → S. 507

Messing, Kunststoff → S. 630

Farbkennzeichnung (als Ersatz für Stempelung) → Infoeinblender

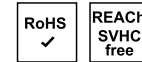

M 8	S	1	2110,00 gal Zn
M 10	S	1	2490,00 gal Zn
M 12	S	1	3300,00 gal Zn
M 16	S	1	4600,00 gal Zn
M 20	S	1	8600,00 gal Zn
M 24	S	1	13200,00 gal Zn
M 27	S	1	17800,00 gal Zn
M 30	S	1	22700,00 gal Zn
M 33	S	1	27600,00 gal Zn
M 36	S	1	32600,00 gal Zn
M 39	S	1	38000,00 gal Zn

~DIN	00975.800
975*	8.8



Gewindestangen, Länge 1000 mm

(*entsprechend DIN 976-1, Form A)

Werkstoffeigensch. → TI-232 Anziehmomente → TI-244

Rostfrei → S. 507

Messing, Kunststoff → S. 630

Farbkennzeichnung (als Ersatz für Stempelung) → Infoeinblender

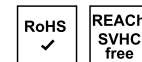

M 4	S	1	2420,00
M 5	S	1	840,00
M 6	S	1	840,00
M 8	S	1	1170,00
M 10	S	1	1540,00
M 12	S	1	1890,00
M 14	S	1	2550,00
M 16	S	1	3100,00
M 18	S	1	4750,00
M 20	S	1	5100,00
M 22	S	1	6300,00
M 24	S	1	7600,00
M 27	S	1	10600,00
M 30	S	1	12100,00
M 33	S	1	21100,00

Abmessungen	VE	Stück	€/100/Obf.
M 36	S	1	28000,00
M 39	S	1	31900,00
M 42	S	1	37000,00
M 48	S	1	43000,00
M 52	S	1	49100,00
M 56	S	1	55100,00
M 60	S	1	62400,00

~DIN	00975.810
975*	8.8
	galvanisch verzinkt



Gewindestangen, Länge 1000 mm

(*entsprechend DIN 976-1, Form A)

Werkstoffeigensch. → **TI-232** Anziehmomente → **TI-244**
Korrosionsschutz → **TI-228**

Rostfrei → **S. 507**
Messing, Kunststoff → **S. 630**

Farbkennzeichnung (als Ersatz für Stempelung)
→ Infoeinblender

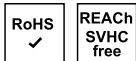

M 4	S	1	2550,00 gal Zn
M 5	S	1	1050,00 gal Zn
M 6	S	1	1150,00 gal Zn
M 8	S	1	1370,00 gal Zn
M 10	S	1	1830,00 gal Zn
M 12	S	1	2160,00 gal Zn
M 14	S	1	2950,00 gal Zn
M 16	S	1	3600,00 gal Zn
M 18	S	1	5400,00 gal Zn
M 20	S	1	6100,00 gal Zn
M 22	S	1	7600,00 gal Zn
M 24	S	1	8600,00 gal Zn
M 27	S	1	12800,00 gal Zn
M 30	S	1	15100,00 gal Zn
M 33	S	1	25300,00 gal Zn
M 36	S	1	31400,00 gal Zn
M 42	S	1	40100,00 gal Zn
M 48	S	1	52600,00 gal Zn

~DIN	00975.816	
975*	8.8	2000
	galvanisch verzinkt	



Gewindestangen, Länge 2000 mm

(*entsprechend DIN 976-1, Form A)

Werkstoffeigensch. → **TI-232** Anziehmomente → **TI-244**
Korrosionsschutz → **TI-228**

Rostfrei → **S. 507**

Farbkennzeichnung (als Ersatz für Stempelung)
→ Infoeinblender



Abmessungen	VE	Stück	€/100/Obf.
M 6 x 2000	S	1	3150,00 gal Zn
M 8 x 2000	S	1	3150,00 gal Zn
M 10 x 2000	S	1	3800,00 gal Zn
M 12 x 2000	S	1	4400,00 gal Zn
M 16 x 2000	S	1	7200,00 gal Zn
M 20 x 2000	S	1	12100,00 gal Zn
M 24 x 2000	S	1	17400,00 gal Zn
M 27 x 2000	S	1	24300,00 gal Zn
M 30 x 2000	S	1	29800,00 gal Zn
M 36 x 2000	S	1	63300,00 gal Zn
M 42 x 2000	S	1	80900,00 gal Zn

~DIN	00975.820
975*	8.8
	feuerverzinkt

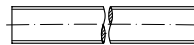

Gewindestangen, Länge 1000 mm

Gewindetoleranz 6 h (6az + tZn = U)
(*entsprechend DIN 976-1, Form A)

Werkstoffeigensch. → **TI-232** Anziehmomente → **TI-244**
Korrosionsschutz → **TI-231**

Rostfrei → **S. 507**
Messing, Kunststoff → **S. 630**

Farbkennzeichnung (als Ersatz für Stempelung)
→ Infoeinblender



M 10	S	1	2900,00 tZn
M 12	S	1	3850,00 tZn
M 16	S	1	5900,00 tZn
M 20	S	1	8800,00 tZn
M 24	S	1	12800,00 tZn
M 27	S	1	15300,00 tZn
M 30	S	1	19900,00 tZn
M 33	S	1	27400,00 tZn
M 36	S	1	40900,00 tZn
M 39	S	1	50000,00 tZn
M 42	S	1	59500,00 tZn

Achtung!

Feuerverzinkte Schrauben-/Muttern-Garnituren dürfen nur miteinander verschraubt werden, wenn Gewindenspiel/-Toleranzen dieser Garnituren entsprechend ISO 10684 passend aufeinander abgestimmt sind. Die Verwendung mit anderen Schrauben-/Muttern-Ausführungen kann zu Verschraubungsproblemen und/oder zum Versagen der Verbindung führen.



Abmessungen	VE	Stück	€/100/Obf.
~DIN	00975.826		
975*	8.8	2000	
	feuerverzinkt		



Gewindestangen, Länge 2000 mm

(*entsprechend DIN 976-1, Form A)

Werkstoffeigensch. → **TI-232** Anziehmomente → **TI-244**
Korrosionsschutz → **TI-231**

Rostfrei → **S. 507**

Farbkennzeichnung (als Ersatz für Stempelung)
→ Infoeinblender

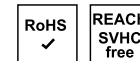

M 12 x 2000	S	1	7700,00 tZn
M 16 x 2000	S	1	11700,00 tZn
M 24 x 2000	S	1	25500,00 tZn
M 30 x 2000	S	1	39700,00 tZn
M 36 x 2000	S	1	81800,00 tZn
M 42 x 2000	S	1	118900,00 tZn

Farb-Kennzeichnung für Gewindestangen



Fkl./Werkstoff	Farbe	~ RAL-Nr.
St/4, 6/4, 8/5, 8/MS/Kst.	ohne	-
5.6	braun	8015
5.8	blau	5010
8.8	gelb	1023
10.9	weiß	1013
12.9	schwarz	9017

Farbe anstatt Stempelung nach DIN 976-1

~DIN	00975.805	
975*	8.8	Fein

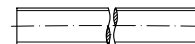

Gewindestangen, Länge 1000 mm, mit metrischem Feingewinde

(*entsprechend DIN 976-1, Form A)

Werkstoffeigensch. → **TI-232** Anziehmomente → **TI-244**

Farbkennzeichnung (als Ersatz für Stempelung)
→ Infoeinblender

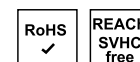

M 12 x 1,5	S	1	23400,00
M 14 x 1,5	S	1	24600,00
M 16 x 1,5	S	1	7700,00
M 20 x 1,5	S	1	8600,00
M 24 x 1,5	S	1	15800,00

Abmessungen	VE	Stück	€/100/Obf.
M 27 x 1,5	S	1	22900,00
M 30 x 1,5	S	1	30200,00
M 30 x 2	S	1	30200,00

~DIN	00975.804
------	-----------

975* **8.8** **Links**

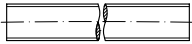

Gewindestangen, Länge 1000 mm, mit metrischem Linksgewinde

(*entsprechend DIN 976-1, Form A)

Werkstoffeigensch. → TI-232 Anziehmomente → TI-244

Rostfrei → S. 508

Farbkennzeichnung (als Ersatz für Stempelung) → Infoeinblender

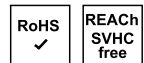

M 10 -LH	S	1	1810,00
M 12 -LH	S	1	2360,00
M 16 -LH	S	1	5100,00
M 20 -LH	S	1	8600,00
M 24 -LH	S	1	12000,00
M 30 -LH	S	1	19000,00

~DIN	00975.814
------	-----------

975* **8.8** **Links**
galvanisch verzinkt



Gewindestangen, Länge 1000 mm, mit metrischem Linksgewinde

(*entsprechend DIN 976-1, Form A)

Werkstoffeigensch. → TI-232 Anziehmomente → TI-244

Korrosionsschutz → TI-228

Rostfrei → S. 508

Farbkennzeichnung (als Ersatz für Stempelung) → Infoeinblender



M 6 -LH	S	1	2300,00 gal Zn
M 8 -LH	S	1	2430,00 gal Zn
M 10 -LH	S	1	2750,00 gal Zn
M 12 -LH	S	1	3550,00 gal Zn
M 16 -LH	S	1	7700,00 gal Zn
M 20 -LH	S	1	12900,00 gal Zn
M 24 -LH	S	1	18000,00 gal Zn
M 27 -LH	S	1	21600,00 gal Zn
M 30 -LH	S	1	28500,00 gal Zn
M 36 -LH	S	1	36100,00 gal Zn

Abmessungen	VE	Stück	€/100/Obf.
~DIN	00975.100		

975* **10.9**



Gewindestangen, Länge 1000 mm

(*entsprechend DIN 976-1, Form A)

Werkstoffeigensch. → TI-232 Anziehmomente → TI-244

Rostfrei → S. 507

Messing, Kunststoff → S. 630

Farbkennzeichnung (als Ersatz für Stempelung) → Infoeinblender

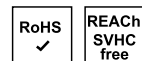

M 5	S	1	4200,00
M 6	S	1	6300,00
M 8	S	1	7900,00
M 10	S	1	8500,00
M 12	S	1	10200,00
M 14	S	1	11500,00
M 16	S	1	12400,00
M 18	S	1	15300,00
M 20	S	1	18100,00
M 22	S	1	21500,00
M 24	S	1	25800,00
M 27	S	1	27900,00
M 30	S	1	32200,00
M 36	S	1	43100,00
M 42	S	1	54000,00
M 48	S	1	64900,00

~DIN	00975.110
------	-----------

975* **10.9**
galvanisch verzinkt



Gewindestangen, Länge 1000 mm

(*entsprechend DIN 976-1, Form A)

Achtung! Warneinblender zu Wasserstoffversprödung beachten.

Werkstoffeigensch. → TI-232 Anziehmomente → TI-244

Korrosionsschutz → TI-228

Rostfrei → S. 507

Messing, Kunststoff → S. 630

Farbkennzeichnung (als Ersatz für Stempelung) → Infoeinblender

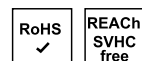

M 5	S	1	10500,00 gal Zn
M 6	S	1	11300,00 gal Zn
M 8	S	1	14600,00 gal Zn
M 10	S	1	14700,00 gal Zn
M 12	S	1	15100,00 gal Zn
M 16	S	1	16700,00 gal Zn
M 20	S	1	21200,00 gal Zn

Abmessungen	VE	Stück	€/100/Obf.
M 24	S	1	22200,00 gal Zn
M 27	S	1	36500,00 gal Zn
M 30	S	1	36500,00 gal Zn
M 36	S	1	47400,00 gal Zn
M 42	S	1	41300,00 gal Zn

Wichtiger Hinweis!



Bei galvanischen Überzügen auf hochfesten und federharten Teilen ($\geq 1000 \text{ N/mm}^2$ oder $\geq 320 \text{ HV}$) ist die Gefahr einer Wasserstoffversprödung (Sprüdruchgefahr) nicht mit Sicherheit auszuschließen (ISO 4042). Durch eine rechtzeitig eingeleitete thermische Nachbehandlung (Tempern) kann die Gefahr eines wasserstoffinduzierten Sprüdruchens im Regelfall verringert werden. Da aber ein Restrisiko nicht mit Sicherheit auszuschließen ist, erfolgen galvanische Überzüge auf derartigen Teilen nur auf ausdrücklichen Wunsch und auf Risiko des Auftraggebers.

~DIN	00975.120
------	-----------

975* **10.9**
feuerverzinkt



Gewindestangen, Länge 1000 mm

Gewindetoleranz 6 h (6az + tZn = U) (*entsprechend DIN 976-1, Form A)

Werkstoffeigensch. → TI-232 Anziehmomente → TI-244

Korrosionsschutz → TI-231

Rostfrei → S. 507

Messing, Kunststoff → S. 630

Farbkennzeichnung (als Ersatz für Stempelung) → Infoeinblender



M 12	S	1	19900,00 tZn
M 16	S	1	21600,00 tZn
M 20	S	1	26100,00 tZn
M 24	S	1	27000,00 tZn
M 27	S	1	30300,00 tZn
M 30	S	1	33900,00 tZn
M 36	S	1	37600,00 tZn

Achtung!



Feuerverzinkte Schrauben-/Mutter-Garnituren dürfen nur miteinander verschraubt werden, wenn Gewindespalt-Toleranzen dieser Garnituren entsprechend ISO 10684 passend aufeinander abgestimmt sind. Die Verwendung mit anderen Schrauben-/Mutter-Ausführungen kann zu Verschraubungsproblemen und/oder zum Versagen der Verbindung führen.

Abmessungen	VE Stück	€/100/Obf.
~DIN	00975.200	
975*	12.9	



Gewindestangen, Länge 1000 mm

(*entsprechend DIN 976-1, Form A)

Werkstoffeigensch. → **TI-232** Anziehmomente → **TI-244**

Rostfrei → **S. 507**

Messing, Kunststoff → **S. 630**

Farbkennzeichnung (als Ersatz für Stempelung)
→ Infoeinblender

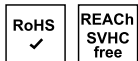

M 6	S	1	60600,00
M 8	S	1	60600,00
M 10	S	1	65600,00
M 12	S	1	70200,00
M 16	S	1	74200,00
M 20	S	1	84500,00
M 24	S	1	96900,00
M 30	S	1	111100,00

Farb-Kennzeichnung für Gewindestangen



Fkl./Werkstoff	Farbe	~ RAL-Nr.
St/4.6/4.8/5.8/MS/Kst.	ohne	-
5.6	braun	8015
5.8	blau	5010
8.8	gelb	1023
10.9	weiß	1013
12.9	schwarz	9017

Farbe anstatt Stempelung nach DIN 976-1

Abmessungen	VE Stück	€/100/Obf.
~DIN	00975.006	
975	Stahl	Trapez



Gewindestangen, Länge 1000 mm, mit normalen Trapezgewinde*

*nach DIN 103

Gewindeenden nach DIN 78-Ko/ISO 4753-RL

Rundmuffen TR → Artikel 88089

Werkstoffeigensch. → **TI-232**

Rostfrei → **S. 508**

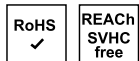

TR 12	x	3	S	1	2900,00
TR 14	x	4	S	1	3150,00
TR 16	x	4	S	1	4150,00
TR 18	x	4	S	1	4300,00
TR 20	x	4	S	1	4850,00
TR 22	x	5	S	1	6300,00
TR 24	x	5	S	1	7300,00
TR 26	x	5	S	1	7900,00
TR 28	x	5	S	1	8600,00
TR 30	x	6	S	1	10300,00
TR 32	x	6	S	1	13100,00
TR 36	x	6	S	1	20700,00
TR 40	x	7	S	1	21700,00
TR 44	x	7	S	1	31500,00

DIN	00976.012
976-1	Stahl galvanisch verzinkt Form B

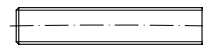

Gewindebolzen, B = mit Kegelschrauben

Werkstoffeigensch. → **TI-232** Korrosionsschutz → **TI-228**



BM 6	x	40	S	100	151,00 gal Zn
BM 6	x	50	S	100	153,00 gal Zn
BM 6	x	60	S	100	154,00 gal Zn
BM 6	x	70	S	100	157,00 gal Zn
BM 6	x	80	S	100	160,00 gal Zn
BM 6	x	90	S	100	183,00 gal Zn
BM 6	x	100	S	100	184,00 gal Zn
BM 8	x	30	S	100	153,00 gal Zn
BM 8	x	40	S	100	157,00 gal Zn
BM 8	x	50	S	100	161,00 gal Zn
BM 8	x	60	S	100	164,00 gal Zn
BM 8	x	70	S	100	167,00 gal Zn
BM 8	x	80	S	100	172,00 gal Zn
BM 8	x	90	S	100	203,00 gal Zn
BM 8	x	100	S	100	226,00 gal Zn
BM 8	x	120	S	50	241,00 gal Zn
BM 8	x	130	S	50	245,00 gal Zn

Abmessungen	VE Stück	€/100/Obf.			
BM 8	x	150	S	50	270,00 gal Zn
BM 10	x	30	S	100	170,00 gal Zn
BM 10	x	35	S	100	176,00 gal Zn
BM 10	x	40	S	100	174,00 gal Zn
BM 10	x	45	S	100	176,00 gal Zn
BM 10	x	50	S	100	180,00 gal Zn
BM 10	x	60	S	100	206,00 gal Zn
BM 10	x	70	S	100	213,00 gal Zn
BM 10	x	75	S	100	216,00 gal Zn
BM 10	x	80	S	100	217,00 gal Zn
BM 10	x	90	S	100	226,00 gal Zn
BM 10	x	100	S	100	230,00 gal Zn
BM 10	x	120	S	100	244,00 gal Zn
BM 10	x	130	S	100	255,00 gal Zn
BM 10	x	140	S	100	260,00 gal Zn
BM 10	x	150	S	100	265,00 gal Zn
BM 10	x	180	S	25	300,00 gal Zn
BM 10	x	190	S	25	305,00 gal Zn
BM 10	x	200	S	10	315,00 gal Zn
BM 10	x	250	S	10	395,00 gal Zn
BM 10	x	300	S	10	475,00 gal Zn
BM 10	x	350	S	10	560,00 gal Zn
BM 10	x	400	S	10	630,00 gal Zn
BM 10	x	450	S	10	710,00 gal Zn
BM 10	x	500	S	10	790,00 gal Zn
BM 12	x	50	S	100	217,00 gal Zn
BM 12	x	60	S	100	226,00 gal Zn
BM 12	x	70	S	50	250,00 gal Zn
BM 12	x	80	S	50	270,00 gal Zn
BM 12	x	90	S	50	270,00 gal Zn
BM 12	x	100	S	50	275,00 gal Zn
BM 12	x	110	S	50	275,00 gal Zn
BM 12	x	120	S	50	280,00 gal Zn
BM 12	x	130	S	50	280,00 gal Zn
BM 12	x	150	S	50	285,00 gal Zn
BM 12	x	160	S	25	300,00 gal Zn
BM 12	x	200	S	25	305,00 gal Zn
BM 12	x	250	S	10	410,00 gal Zn
BM 12	x	300	S	10	175,00 gal Zn
BM 12	x	350	S	10	580,00 gal Zn
BM 12	x	400	S	10	670,00 gal Zn
BM 12	x	450	S	10	730,00 gal Zn
BM 12	x	500	S	10	820,00 gal Zn
BM 16	x	60	S	25	345,00 gal Zn
BM 16	x	70	S	25	365,00 gal Zn
BM 16	x	80	S	25	385,00 gal Zn
BM 16	x	90	S	25	390,00 gal Zn
BM 16	x	100	S	25	420,00 gal Zn
BM 16	x	120	S	25	445,00 gal Zn
BM 16	x	150	S	10	510,00 gal Zn
BM 16	x	200	S	10	620,00 gal Zn
BM 16	x	300	S	10	910,00 gal Zn
BM 16	x	350	S	5	1060,00 gal Zn
BM 16	x	400	S	5	1210,00 gal Zn
BM 16	x	450	S	5	1370,00 gal Zn
BM 16	x	500	S	5	1520,00 gal Zn

Abmessungen	VE Stück	€/100/Obf.
DIN 00976.829		
976-1	8.8	Form A
	feuerverzinkt	

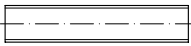

Gewindebolzen, A = ohne Kegelkuppen, Gewindestange 2 Meter

Werkstoffeigensch. → TI-232 Anziehmomente → TI-244
Korrosionsschutz → TI-228

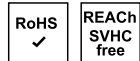

AM 12	x 2000	S	1	7700,00 tZn
AM 16	x 2000	S	1	11700,00 tZn
AM 20	x 2000	S	1	17500,00 tZn
AM 24	x 2000	S	1	25500,00 tZn
AM 30	x 2000	S	1	39700,00 tZn
AM 36	x 2000	S	1	81800,00 tZn
AM 42	x 2000	S	1	118900,00 tZn

Abmessungen	VE Stück	€/100/Obf.
DIN 00979.400		
979	04	

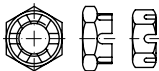

Niedrige Kronenmuttern

Maße → TI-68 REACH → TI-262
Werkstoffeigensch. → TI-233

Ersatz für DIN 937 mit Schlüsselweiten und Höhe nach ISO-Maßen



M 16	S	50	131,00
M 20	S	50	193,00
M 24	S	25	330,00
M 30	S	10	610,00

Abmessungen	VE Stück	€/100/Obf.
DIN 00979.405		
979	04	Fein

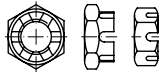

Niedrige Kronenmuttern, mit metrischem Feingewinde

Maße → TI-68 REACH → TI-262
Werkstoffeigensch. → TI-233

Ersatz für DIN 937 mit Schlüsselweiten und Höhe nach ISO-Maßen



M 16	x 1,5	S	50	153,00
M 18	x 1,5	S	50	182,00
M 20	x 1,5	S	25	249,00
M 24	x 2	S	25	390,00
M 30	x 2	S	10	740,00
M 36	x 3	S	1	1120,00
M 42	x 3	S	1	1950,00
M 48	x 3	S	1	3300,00
M 52	x 3	S	1	4100,00

Abmessungen	VE Stück	€/100/Obf.
DIN 00980.815		
980	8	Form V
	galvanisch verzinkt	

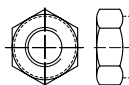

Sechskantmuttern mit Klemmteil, V = Ganzmetallmuttern, einteilig

Maße → TI-9 Korrosionsschutz → TI-228
Werkstoffeigensch. → TI-233 Normumstellung → TI-9

Rostfrei → S. 510

DIN 980 → wird ersetzt durch ISO 7042

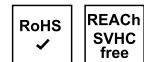

VM 4	S	100	10,10 gal Zn
VM 5	S	1000	8,30 gal Zn
VM 5	K	100	11,80 gal Zn
VM 6	S	1000	8,50 gal Zn
VM 6	K	100	12,10 gal Zn
VM 8	S	500	13,10 gal Zn
VM 8	K	100	16,40 gal Zn
VM 10	S	500	21,70 gal Zn
VM 10	K	100	27,00 gal Zn
VM 12	S	250	34,00 gal Zn
VM 12	K	100	39,00 gal Zn
VM 14	S	100	59,00 gal Zn
VM 16	S	100	67,00 gal Zn
VM 18	S	50	126,00 gal Zn
VM 20	S	50	131,00 gal Zn
VM 22	S	25	223,00 gal Zn
VM 24	S	25	230,00 gal Zn
VM 27	S	25	510,00 gal Zn

Abmessungen	VE Stück	€/100/Obf.
VM 30	S	10 600,00 gal Zn
VM 33	S	10 1150,00 gal Zn
VM 36	S	10 1210,00 gal Zn

Abmessungen	VE Stück	€/100/Obf.
DIN 00980.428		
980	8	Form V
	galv. verz. 8 DISP + SL*	

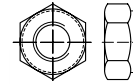

Sechskantmuttern mit Klemmteil, V = Ganzmetallmuttern, einteilig

* SL = Sealer and Lubrication (Versiegelung und Schmierung mit $\mu = 0,12 - 0,18$), Korrosionsbeständigkeit NSS: 120h WR, 264h RR

Maße → TI-9 Korrosionsschutz → TI-228
Werkstoffeigensch. → TI-233 Normumstellung → TI-9

Rostfrei → S. 510

DIN 980 → wird ersetzt durch ISO 7042

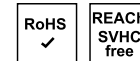

VM 5	S	1000	9,90 gal ZnDi
VM 6	S	1000	10,20 gal ZnDi
VM 8	S	500	15,90 gal ZnDi
VM 10	S	500	26,50 gal ZnDi
VM 12	S	250	41,50 gal ZnDi
VM 14	S	100	84,00 gal ZnDi
VM 16	S	100	82,00 gal ZnDi
VM 20	S	50	157,00 gal ZnDi

Abmessungen	VE Stück	€/100/Obf.
DIN 00980.353		
980	8	Form V
	fiZn/TL480h	

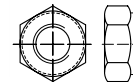

Sechskantmuttern mit Klemmteil, V = Ganzmetallmuttern, einteilig

TL = Schmierstoff im Topcoat mit $\mu = 0,09 - 0,14$, Korrosionsbeständigkeit NSS: 480h RR, Chrom(VI)-frei

Achtung! Gegenüber galv. verzinkt geänderte Anziehdrehmomente.

Maße → TI-9 Korrosionsschutz → TI-230
Werkstoffeigensch. → TI-233 Normumstellung → TI-9

Rostfrei → S. 510

DIN 980 → wird ersetzt durch ISO 7042

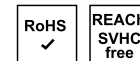

VM 6	S	1000	11,10 fiZn
VM 8	S	500	17,10 fiZn
VM 10	S	500	30,00 fiZn
VM 12	S	250	46,00 fiZn
VM 16	S	100	88,00 fiZn
VM 20	S	50	171,00 fiZn
VM 24	S	25	310,00 fiZn

Abmessungen	VE Stück	€/100/Obf.
DIN	00980.826	
980	8	Form V
	feuerverzinkt	

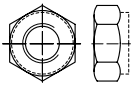

Sechskantmuttern mit Klemmteil, V = Ganzmetallmutter, einteilig

Maße → **TI-9** Korrosionsschutz → **TI-231**
 Werkstoffeigensch. → **TI-233** Normumstellung → **TI-9**
 Rostfrei → **S. 510**
 DIN 980 → wird ersetzt durch ISO 7042



VM 5	S	100	177,00 tZn
VM 6	S	100	71,00 tZn
VM 8	S	100	83,00 tZn
VM 10	S	100	105,00 tZn
VM 12	S	100	125,00 tZn
VM 16	S	100	219,00 tZn
VM 20	S	50	680,00 tZn
VM 24	S	25	940,00 tZn

DIN	00980.818
980	8 Form V-Fein
	galvanisch verzinkt

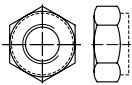

Sechskantmuttern mit Klemmteil, mit metrischem Feingewinde, V = Ganzmetallmutter, einteilig

Maße → **TI-9** Korrosionsschutz → **TI-228**
 Werkstoffeigensch. → **TI-233** Normumstellung → **TI-9**
 Rostfrei → **S. 510**
 DIN 980 Feingew. → wird ersetzt durch ISO 10513



VM 8	x	1	S	100	30,00 gal Zn
VM 10	x	1	S	100	34,50 gal Zn
VM 12	x	1,5	S	100	42,00 gal Zn
VM 14	x	1,5	S	100	60,00 gal Zn
VM 16	x	1,5	S	100	79,00 gal Zn
VM 18	x	1,5	S	50	136,00 gal Zn
VM 20	x	1,5	S	50	131,00 gal Zn
VM 22	x	1,5	S	50	229,00 gal Zn
VM 24	x	1,5	S	25	239,00 gal Zn
VM 24	x	2	S	25	239,00 gal Zn
VM 30	x	2	S	10	620,00 gal Zn

Abmessungen	VE Stück	€/100/Obf.
DIN	00980.114	
980	10	Form V
	galvanisch verzinkt	

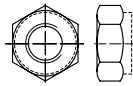

Sechskantmuttern mit Klemmteil, V = Ganzmetallmutter, einteilig

Maße → **TI-9** Korrosionsschutz → **TI-228**
 Werkstoffeigensch. → **TI-233** Normumstellung → **TI-9**
 Rostfrei → **S. 510**
 DIN 980 → wird ersetzt durch ISO 7042

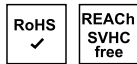

VM 6	S	1000	18,20 gal Zn
VM 8	S	100	27,50 gal Zn
VM 10	S	100	46,00 gal Zn
VM 12	S	100	59,00 gal Zn
VM 14	S	100	84,00 gal Zn
VM 16	S	50	103,00 gal Zn
VM 18	S	50	157,00 gal Zn
VM 20	S	50	190,00 gal Zn
VM 22	S	25	270,00 gal Zn
VM 24	S	25	290,00 gal Zn
VM 27	S	10	830,00 gal Zn
VM 30	S	10	590,00 gal Zn
VM 36	S	10	3050,00 gal Zn

DIN	00980.135
980	10 Form V
	fIZn/TL 480h

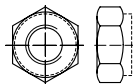

Sechskantmuttern mit Klemmteil, V = Ganzmetallmutter, einteilig

TL = Schmierstoff im Topcoat mit $\mu = 0,09 - 0,14$, Korrosionsbeständigkeit NSS: 480h RR, Chrom(VI)-frei

Achtung! Gegenüber galv. verzinkt geänderte Anziehdrehmomente.

Maße → **TI-9** Korrosionsschutz → **TI-230**
 Werkstoffeigensch. → **TI-233** Normumstellung → **TI-9**

Rostfrei → **S. 510**
 DIN 980 → wird ersetzt durch ISO 7042

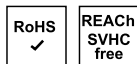

VM 8	S	500	79,00 fIZn
VM 10	S	500	109,00 fIZn
VM 12	S	250	121,00 fIZn
VM 16	S	50	146,00 fIZn
VM 18	S	50	182,00 fIZn
VM 20	S	50	218,00 fIZn
VM 24	S	25	400,00 fIZn

Abmessungen	VE Stück	€/100/Obf.
DIN	00980.118	
980	10	Form V-Fein
	galvanisch verzinkt	

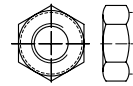

Sechskantmuttern mit Klemmteil, mit metrischem Feingewinde, V = Ganzmetallmutter einteilig

Maße → **TI-9** Korrosionsschutz → **TI-228**
 Werkstoffeigensch. → **TI-233** Normumstellung → **TI-9**
 DIN 980 Feingew. → wird ersetzt durch ISO 10513

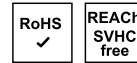

VM 8	x	1	S	100	34,00 gal Zn
VM 10	x	1	S	100	54,00 gal Zn
VM 10	x	1,25	S	100	53,00 gal Zn
VM 12	x	1,25	S	100	65,00 gal Zn
VM 12	x	1,5	S	100	65,00 gal Zn
VM 14	x	1,5	S	100	92,00 gal Zn
VM 16	x	1,5	S	50	112,00 gal Zn
VM 18	x	1,5	S	50	170,00 gal Zn
VM 20	x	1,5	S	50	197,00 gal Zn
VM 22	x	1,5	S	25	315,00 gal Zn
VM 24	x	1,5	S	25	315,00 gal Zn
VM 24	x	2	S	25	315,00 gal Zn

~DIN	88105.030
980	Stahl Artikel 88105
	galvanisch verkupfert

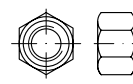

„THERMAG“-Muttern, Sechskantmuttern mit Klemmteil, V = Ganzmetallmutter, einteilig

Maße → **TI-9** Korrosionsschutz → **TI-228**
 Werkstoffeigensch. → **TI-233** Normumstellung → **TI-9**

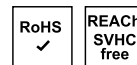

M 8 SW 12	S	100	59,00 gal Cu
M 8 SW 13	S	100	89,00 gal Cu
M 10 SW 14	S	100	102,00 gal Cu
M 10 SW 17	S	100	114,00 gal Cu
M 12 SW 17	S	100	204,00 gal Cu
M 12 SW 19	S	100	226,00 gal Cu

Abmessungen VE Stück €/100/Obf.

Artikel	84032.810
84032	8 Biloc galvanisch verzinkt

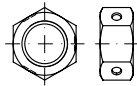

Sechskantmuttern mit Klemmteil Ganzmetallmuttern

- drei Quetschungen mittig auf Schlüsselfläche
- beidseitig aufschraubbar
- für automatische Zuführungen geeignet
- Maße wie ISO 4032

Maße → **TI-62**

Korrosionsschutz → **TI-228**



M 5	S 1000	21,80 gal Zn
M 6	S 1000	25,50 gal Zn
M 8	S 1000	31,50 gal Zn
M 10	S 500	33,50 gal Zn
M 12	S 500	59,00 gal Zn
M 16	S 200	152,00 gal Zn
M 20	S 100	275,00 gal Zn

Artikel	84032.110
84032	10 Biloc galvanisch verzinkt

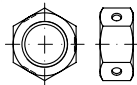

Sechskantmuttern mit Klemmteil Ganzmetallmuttern

- drei Quetschungen mittig auf Schlüsselfläche
- beidseitig aufschraubbar
- für automatische Zuführungen geeignet
- Maße wie ISO 4032

Maße → **TI-62**

Korrosionsschutz → **TI-228**



M 5	S 1000	27,00 gal Zn
M 6	S 1000	34,00 gal Zn
M 8	S 1000	44,00 gal Zn
M 10	S 500	51,00 gal Zn
M 12	S 500	88,00 gal Zn
M 16	S 100	212,00 gal Zn
M 20	S 50	385,00 gal Zn

Abmessungen VE Stück €/100/Obf.

DIN	00981.000
981	Stahl



Nutmuttern für Wälzlager

Muttersicherungsblech → DIN 5406

Maße → **TI-73**

REACH → **TI-262**



Typ/Nr./ Gewinde-Nennmaß x Steigung

KM 0 M 10	x 0,75	S 10	560,00
KM 1 M 12	x 1	S 10	590,00
KM 2 M 15	x 1	S 10	600,00
KM 3 M 17	x 1	S 10	650,00
KM 4 M 20	x 1	S 10	670,00
KM 5 M 25	x 1,5	S 10	680,00
KM 6 M 30	x 1,5	S 10	770,00
KM 7 M 35	x 1,5	S 1	1010,00
KM 8 M 40	x 1,5	S 1	1150,00
KM 9 M 45	x 1,5	S 1	1340,00
KM10 M 50	x 1,5	S 1	1570,00
KM11 M 55	x 2	S 1	1700,00
KM12 M 60	x 2	S 1	1820,00
KM13 M 65	x 2	S 1	2170,00
KM14 M 70	x 2	S 1	2550,00
KM15 M 75	x 2	S 1	3100,00
KM16 M 80	x 2	S 1	3600,00
KM17 M 85	x 2	S 1	4250,00
KM18 M 90	x 2	S 1	5100,00
KM19 M 95	x 2	S 1	5600,00
KM20 M100	x 2	S 1	6200,00
KM22 M110	x 2	S 1	8300,00
KM23 M115	x 2	S 1	12400,00
KM24 M120	x 2	S 1	12500,00
KM25 M125	x 2	S 1	13600,00
KM26 M130	x 2	S 1	15300,00
KM27 M135	x 2	S 1	19500,00
KM28 M140	x 2	S 1	19000,00
KM29 M145	x 2	S 1	23400,00
KM30 M150	x 2	S 1	21500,00
KM31 M155	x 3	S 1	21800,00
KM32 M160	x 3	S 1	25300,00
KM34 M170	x 3	S 1	25700,00

Abmessungen VE Stück €/100/Obf.

DIN	00982.810
982	8 (≤ M 4 = 6 - 8) galvanisch verzinkt

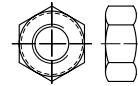

Sechskantmuttern mit Klemmteil, mit nichtmetallischem Einsatz, hohe Form

für Temperatur-Einsatz von -50 bis +120 °C

Maße → **TI-9**

Korrosionsschutz → **TI-228**

Werkstoffeigensch. → **TI-233**

Normumstellung → **TI-9**

m. wärmestab. Ring → ISO 7040 **S. 325**

Rostfrei → **S. 511**

DIN 982 → wird ersetzt durch ISO 7040



M 4	S 1000	15,40 gal Zn
M 4	K 100	20,00 gal Zn
M 5	S 1000	15,40 gal Zn
M 5	K 100	20,00 gal Zn
M 6	S 1000	15,80 gal Zn
M 6	K 100	20,50 gal Zn
M 8	S 1000	21,60 gal Zn
M 8	K 100	26,50 gal Zn
M 10	S 500	36,50 gal Zn
M 10	K 100	41,50 gal Zn
M 12	S 500	48,00 gal Zn
M 12	K 100	53,00 gal Zn
M 14	S 100	83,00 gal Zn
M 16	S 200	111,00 gal Zn
M 16	K 50	118,00 gal Zn
M 18	S 50	182,00 gal Zn
M 20	S 50	227,00 gal Zn
M 24	S 25	360,00 gal Zn
M 27	S 25	970,00 gal Zn
M 30	S 25	1150,00 gal Zn

DIN	00982.110
982	10 galvanisch verzinkt

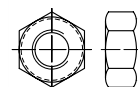

Sechskantmuttern mit Klemmteil, mit nichtmetallischem Einsatz, hohe Form

für Temperatur-Einsatz von -50 bis +120 °C

Maße → **TI-9**

Korrosionsschutz → **TI-228**

Werkstoffeigensch. → **TI-233**

Normumstellung → **TI-9**

Rostfrei → **S. 511**

DIN 982 → wird ersetzt durch ISO 7040



M 10	S 100	77,00 gal Zn
M 12	S 100	111,00 gal Zn

Abmessungen	VE	Stück	€/100/Obf.
M 16	S	50	197,00 gal Zn
M 20	S	50	360,00 gal Zn
M 24	S	25	480,00 gal Zn

DIN	00982.115
982	10 galvanisch verzinkt Fein

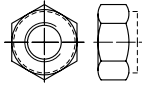

Sechskantmuttern mit Klemmteil, mit nichtmetallischem Einsatz, hohe Form, mit metr. Feingewinde
für Temperatur-Einsatz von -50 bis +120 °C

Maße → **TI-9** Korrosionsschutz → **TI-228**
Werkstoffeigensch. → **TI-233** Normumstellung → **TI-9**

DIN 982 Feingew. → wird ersetzt durch ISO 10512



M 10	x 1	S	100	84,00 gal Zn
M 12	x 1,5	S	100	120,00 gal Zn
M 14	x 1,5	S	100	161,00 gal Zn
M 16	x 1,5	S	50	216,00 gal Zn
M 20	x 1,5	S	50	390,00 gal Zn
M 24	x 2	S	25	570,00 gal Zn

DIN	00983.000	481
-----	-----------	-----

983 **Federstahl**

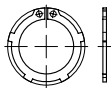

Sicherungsringe mit Lappen, (Haltringe) für Wellen

Maße → **TI-98**



Für Wellen-Nenn Ø x Ringdicke

20	x 1,2	S	1000	25,50
25	x 1,2	S	500	36,50
30	x 1,5	S	250	47,50
35	x 1,5	S	250	60,00
40	x 1,75	S	100	95,00
45	x 1,75	S	100	102,00
50	x 2	S	100	125,00

Abmessungen	VE	Stück	€/100/Obf.
DIN	00985.810		
985	8 (≤ M 5 = 6 - 8) galvanisch verzinkt		

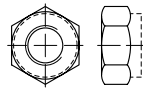

Sechskantmuttern mit Klemmteil, mit nichtmetallischem Einsatz, niedrige Form

für Temperatur-Einsatz von -50 bis +120 °C

Maße → **TI-9** Korrosionsschutz → **TI-228**
Werkstoffeigensch. → **TI-233** Normumstellung → **TI-9**

Rostfrei → **S. 512**
Messing → **S. 630**

DIN 985 → wird ersetzt durch ISO 10511



M 2,5	S	1000	6,90 gal Zn
M 3	S	1000	7,40 gal Zn
M 3	K	100	11,40 gal Zn
M 4	S	1000	7,40 gal Zn
M 4	K	100	11,40 gal Zn
M 5	S	1000	7,40 gal Zn
M 5	K	100	11,40 gal Zn
M 6	S	1000	8,60 gal Zn
M 6	K	100	12,50 gal Zn
M 7	K	100	21,60 gal Zn
M 8	S	500	13,40 gal Zn
M 8	K	100	17,40 gal Zn
M 10	S	500	26,00 gal Zn
M 10	K	100	31,00 gal Zn
M 12	S	250	36,50 gal Zn
M 12	K	100	41,50 gal Zn
M 14	S	100	61,00 gal Zn
M 16	S	100	73,00 gal Zn
M 18	S	50	117,00 gal Zn
M 20	S	50	141,00 gal Zn
M 22	S	25	216,00 gal Zn
M 24	S	25	260,00 gal Zn
M 27	S	25	430,00 gal Zn
M 30	S	10	540,00 gal Zn
M 33	S	10	850,00 gal Zn
M 36	S	10	1010,00 gal Zn
M 39	S	1	2300,00 gal Zn
M 42	S	1	2550,00 gal Zn
M 45	S	1	3100,00 gal Zn
M 48	S	1	4100,00 gal Zn

Abmessungen	VE	Stück	€/100/Obf.
Artikel	82985.010		
82985	Sortiment	DIN 985 R/F	6/8 galvanisch verz.



Klemmteil-Muttern-Sortiment DIN 985

Inhalt: 8 Abmessungen RG M 4-M 16
4 Abmessungen FG M 10 x 1 - M 16 x 1,5,
ca. 540 Stück, Metall-Koffer

Wunschsortiment auf Anfrage



DIN 985	S	1	13700,00
---------	---	---	----------

DIN	00985.850
985	8 (≤ M 5 = 6) galv. verz. 8 DiSP*

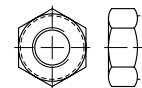

Sechskantmuttern mit Klemmteil, mit nichtmetallischem Einsatz, niedrige Form

für Temperatur-Einsatz von -50 bis +120 °C,
* < M 6 Mindestschichtdicke 5µm,
Korrosionsbeständigkeit NSS: 72h WR, 120h RR

Maße → **TI-9** Korrosionsschutz → **TI-228**
Werkstoffeigensch. → **TI-233** Normumstellung → **TI-9**

Rostfrei → **S. 512**
Messing → **S. 630**

DIN 985 → wird ersetzt durch ISO 10511



M 3	S	1000	10,30 gal ZnDi
M 4	S	1000	10,50 gal ZnDi
M 4	K	100	15,70 gal ZnDi
M 5	S	1000	10,50 gal ZnDi
M 5	K	100	15,70 gal ZnDi
M 6	S	1000	13,80 gal ZnDi
M 6	K	100	17,00 gal ZnDi
M 8	S	1000	20,90 gal ZnDi
M 8	K	100	24,10 gal ZnDi
M 10	S	500	36,50 gal ZnDi
M 10	K	100	39,50 gal ZnDi
M 12	S	250	51,00 gal ZnDi
M 14	S	100	88,00 gal ZnDi
M 16	S	100	103,00 gal ZnDi
M 20	S	50	198,00 gal ZnDi
M 24	S	25	365,00 gal ZnDi

Abmessungen	VE Stück	€/100/Obf.
DIN	00985.428	
985	8	galv. verz. 8 DiSP* + SL**

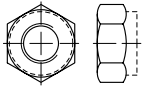

Sechskantmutter mit Klemmteil, mit nichtmetallischem Einsatz, niedrige Form

für Temperatur-Einsatz von -50 bis +120 °C,
 * < M 6 Mindestschichtdicke 5µm,
 ** SL = Sealer and Lubrication
 (Versiegelung und Schmierung mit $\mu = 0,12 - 0,18$),
 Korrosionsbeständigkeit NSS: 120h WR, 264h RR

Maße → [TI-9](#) Korrosionsschutz → [TI-228](#)
 Werkstoffeigensch. → [TI-233](#) Normumstellung → [TI-9](#)

Rostfrei → [S. 512](#)
 Messing → [S. 630](#)

DIN 985 → wird ersetzt durch ISO 10511



M 3	S 1000	9,90 gal ZnDi
M 4	S 1000	10,10 gal ZnDi
M 5	S 1000	10,10 gal ZnDi
M 6	S 1000	13,30 gal ZnDi
M 8	S 500	19,90 gal ZnDi
M 10	S 500	35,00 gal ZnDi
M 12	S 250	49,00 gal ZnDi
M 14	S 100	83,00 gal ZnDi
M 16	S 100	99,00 gal ZnDi
M 20	S 50	189,00 gal ZnDi
M 24	S 25	350,00 gal ZnDi

Abmessungen	VE Stück	€/100/Obf.
DIN	00985.353	
985	8	flZn/TL480h

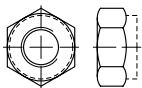

Sechskantmutter mit Klemmteil, mit nichtmetallischem Einsatz, niedrige Form

für Temperatur-Einsatz von -50 bis +150 °C,
 TL = Schmierstoff im Topcoat mit $\mu = 0,09 - 0,14$,
 Korrosionsbeständigkeit NSS: 480h RR,
 Chrom(VI)-frei

Maße → [TI-9](#) Korrosionsschutz → [TI-230](#)
 Werkstoffeigensch. → [TI-233](#) Normumstellung → [TI-9](#)

Rostfrei → [S. 512](#)
 Messing → [S. 630](#)

DIN 985 → wird ersetzt durch ISO 10511



M 6	S 1000	11,50 flZn
M 8	S 500	17,60 flZn
M 10	S 500	31,00 flZn
M 12	S 250	48,00 flZn
M 14	S 100	71,00 flZn
M 16	S 50	90,00 flZn

Abmessungen	VE Stück	€/100/Obf.
M 20	S 50	176,00 flZn
M 24	S 25	315,00 flZn
M 30	S 25	670,00 flZn
M 33	S 25	1030,00 flZn
M 36	S 25	1210,00 flZn

Abmessungen	VE Stück	€/100/Obf.
DIN	00985.815	
985	8 (≤ M 5 = 6 - 8)	Fein galvanisch verzinkt

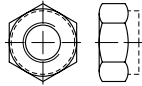

Sechskantmutter mit Klemmteil, mit nichtmetallischem Einsatz, niedrige Form, mit metr. Feingewinde

für Temperatur-Einsatz von -50 bis +120 °C

Maße → [TI-9](#) Korrosionsschutz → [TI-228](#)
 Werkstoffeigensch. → [TI-233](#) Normumstellung → [TI-9](#)

DIN 985 Feingew. → wird ersetzt durch ISO 10512



M 8	x 1	S 500	26,00 gal Zn
M 8	x 1	K 100	30,50 gal Zn
M 10	x 1	S 500	44,50 gal Zn
M 10	x 1	K 100	48,50 gal Zn
M 10	x 1,25	S 500	44,50 gal Zn
M 10	x 1,25	K 100	48,50 gal Zn
M 12	x 1	S 250	59,00 gal Zn
M 12	x 1	K 100	63,00 gal Zn
M 12	x 1,25	S 250	59,00 gal Zn
M 12	x 1,25	K 100	63,00 gal Zn
M 12	x 1,5	S 250	59,00 gal Zn
M 12	x 1,5	K 100	63,00 gal Zn
M 14	x 1,5	S 100	86,00 gal Zn
M 16	x 1,5	S 100	103,00 gal Zn
M 18	x 1,5	S 50	172,00 gal Zn
M 18	x 2	S 50	172,00 gal Zn
M 20	x 1,5	S 50	207,00 gal Zn
M 20	x 2	S 25	212,00 gal Zn
M 22	x 1,5	S 25	285,00 gal Zn
M 22	x 2	S 25	285,00 gal Zn
M 24	x 1,5	S 25	335,00 gal Zn
M 24	x 2	S 25	335,00 gal Zn
M 27	x 2	S 10	680,00 gal Zn
M 30	x 1,5	S 10	770,00 gal Zn
M 30	x 2	S 10	770,00 gal Zn
M 33	x 2	S 1	1200,00 gal Zn
M 36	x 3	S 1	1430,00 gal Zn
M 39	x 3	S 1	2750,00 gal Zn
M 42	x 3	S 1	3100,00 gal Zn
M 45	x 3	S 1	3800,00 gal Zn
M 48	x 3	S 1	4800,00 gal Zn

Abmessungen	VE Stück	€/100/Obf.
DIN	00985.110	
985	10	galvanisch verzinkt

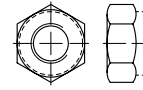

Sechskantmutter mit Klemmteil, mit nichtmetallischem Einsatz, niedrige Form

für Temperatur-Einsatz von -50 bis +120 °C

Maße → [TI-9](#) Korrosionsschutz → [TI-228](#)
 Werkstoffeigensch. → [TI-233](#) Normumstellung → [TI-9](#)

Rostfrei → [S. 512](#)
 Messing → [S. 630](#)

DIN 985 → wird ersetzt durch ISO 10511



M 5	S 1000	20,60 gal Zn
M 6	S 1000	22,90 gal Zn
M 6	K 100	26,00 gal Zn
M 8	S 500	30,50 gal Zn
M 8	K 100	33,50 gal Zn
M 10	S 500	51,00 gal Zn
M 10	K 100	54,00 gal Zn
M 12	S 250	73,00 gal Zn
M 12	K 100	76,00 gal Zn
M 14	S 50	114,00 gal Zn
M 16	S 50	151,00 gal Zn
M 18	S 50	205,00 gal Zn
M 20	S 50	234,00 gal Zn
M 22	S 25	315,00 gal Zn
M 24	S 25	395,00 gal Zn
M 27	S 25	630,00 gal Zn
M 30	S 1	990,00 gal Zn
M 36	S 1	2120,00 gal Zn
M 39	S 1	3000,00 gal Zn

Abmessungen	VE Stück	€/100/Obf.
DIN	00985.115	
985	10	Fein galvanisch verzinkt

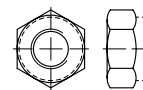

Sechskantmutter mit Klemmteil, mit nichtmetallischem Einsatz, niedrige Form, mit metr. Feingewinde

für Temperatur-Einsatz von -50 bis +120 °C

Maße → [TI-9](#) Korrosionsschutz → [TI-228](#)
 Werkstoffeigensch. → [TI-233](#) Normumstellung → [TI-9](#)

DIN 985 Feingew. → wird ersetzt durch ISO 10512



M 8	x 1	S 100	34,00 gal Zn
M 10	x 1	S 100	57,00 gal Zn
M 10	x 1,25	S 100	57,00 gal Zn
M 12	x 1	S 100	78,00 gal Zn
M 12	x 1,25	S 100	78,00 gal Zn

Abmessungen	VE	Stück	€/100/Obf.
M 12 x 1,5	S	100	78,00 gal Zn
M 14 x 1,5	S	50	126,00 gal Zn
M 16 x 1,5	S	50	157,00 gal Zn
M 18 x 1,5	S	50	205,00 gal Zn
M 20 x 1,5	S	50	245,00 gal Zn
M 20 x 2	S	50	245,00 gal Zn
M 22 x 1,5	S	25	315,00 gal Zn
M 24 x 1,5	S	25	395,00 gal Zn
M 24 x 2	S	25	395,00 gal Zn
M 30 x 2	S	10	1820,00 gal Zn
M 36 x 3	S	10	2420,00 gal Zn

DIN	00986.310
986	6 galvanisch verzinkt

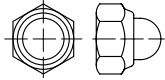

Sechskant-Hutmuttern mit Klemmteil, mit nichtmetallischem Einsatz

für Temperatur-Einsatz von -50 bis +120 °C

Maße → **TI-68** Korrosionsschutz → **TI-228**
 Werkstoffeigensch. → **TI-233** REACH → **TI-262**
 Rostfrei → **S. 512**

M 4	S	100	77,00 gal Zn
M 5	S	1000	74,00 gal Zn
M 5	K	100	77,00 gal Zn
M 6	S	1000	53,00 gal Zn
M 6	K	100	57,00 gal Zn
M 8	S	500	78,00 gal Zn
M 8	K	100	82,00 gal Zn
M 10 SW 17	S	500	126,00 gal Zn
M 10 SW 17	K	100	130,00 gal Zn
M 12 SW 19	S	250	181,00 gal Zn
M 12 SW 19	K	50	187,00 gal Zn
M 16	S	50	234,00 gal Zn

DIN	00988.000
988	Stahl



Passscheiben

Federstahl → **S. 204**
 Rostfrei → **S. 513**

RoHS	REACH SVHC free
✓	

Loch Ø x Außen Ø x Dicke

3	x	6	x	0,1	S	5000	7,70
3	x	6	x	0,2	S	5000	8,20
3	x	6	x	0,3	S	5000	8,60
3	x	6	x	0,5	S	5000	9,50
4	x	8	x	0,1	S	5000	8,40
4	x	8	x	0,2	S	5000	8,60
4	x	8	x	0,3	S	5000	9,50
4	x	8	x	0,5	S	5000	9,50
5	x	10	x	0,1	S	5000	9,40
5	x	10	x	0,2	S	2500	8,80

Abmessungen	VE	Stück	€/100/Obf.				
5	x	10	x	0,25	S	2500	9,40
5	x	10	x	0,3	S	2500	9,60
5	x	10	x	0,5	S	2500	9,40
5	x	10	x	1	S	2500	10,70
6	x	12	x	0,1	S	5000	9,10
6	x	12	x	0,2	S	2500	9,60
6	x	12	x	0,25	S	2500	9,50
6	x	12	x	0,3	S	2500	10,10
6	x	12	x	0,5	S	2500	9,40
6	x	12	x	1	S	2000	11,20
7	x	13	x	0,3	S	2000	12,50
7	x	13	x	0,5	S	2000	13,40
7	x	13	x	1	S	1000	13,60
8	x	12	x	0,5	S	5000	29,50
8	x	14	x	0,1	S	5000	9,40
8	x	14	x	0,2	S	2000	8,90
8	x	14	x	0,25	S	2000	14,20
8	x	14	x	0,3	S	2000	8,60
8	x	14	x	0,5	S	2000	9,50
8	x	14	x	1	S	1000	11,30
9	x	15	x	0,1	S	5000	9,60
9	x	15	x	0,2	S	2000	10,20
9	x	15	x	0,5	S	2000	10,60
9	x	15	x	1	S	1000	11,80
9	x	15	x	1,2	S	1000	13,00
10	x	16	x	0,1	S	5000	10,10
10	x	16	x	0,2	S	2000	10,50
10	x	16	x	0,25	S	2000	11,10
10	x	16	x	0,3	S	2000	11,80
10	x	16	x	0,5	S	2000	10,60
10	x	16	x	1	S	1000	12,40
10	x	16	x	1,5	S	500	17,70
11	x	17	x	1	S	1000	11,70
12	x	18	x	0,1	S	5000	10,50
12	x	18	x	0,2	S	2000	11,10
12	x	18	x	0,25	S	2000	11,90
12	x	18	x	0,3	S	2000	23,40
12	x	18	x	0,5	S	1000	13,10
12	x	18	x	1	S	1000	13,70
12	x	18	x	2	S	1000	19,40
13	x	19	x	0,1	S	5000	11,80
13	x	19	x	0,5	S	1000	12,60
13	x	19	x	1	S	1000	16,10
14	x	20	x	0,1	S	5000	11,30
14	x	20	x	0,2	S	2000	12,30
14	x	20	x	0,25	S	2000	13,80
14	x	20	x	0,5	S	1000	11,90
14	x	20	x	1	S	1000	15,70
15	x	21	x	0,1	S	2000	11,40
15	x	21	x	0,15	S	2000	14,30
15	x	21	x	0,2	S	2000	16,10
15	x	21	x	0,3	S	2000	15,20
15	x	21	x	0,5	S	1000	13,20
15	x	21	x	1	S	1000	17,50
15	x	21	x	2	S	1000	21,10
15	x	22	x	0,5	S	1000	9,70
15	x	22	x	1	S	1000	17,20
16	x	22	x	0,1	S	2000	12,40
16	x	22	x	0,2	S	2000	12,80
16	x	22	x	0,25	S	2000	13,80
16	x	22	x	0,5	S	1000	12,90
16	x	22	x	1	S	1000	17,00
17	x	24	x	0,1	S	2000	13,40
17	x	24	x	0,15	S	2000	15,20
17	x	24	x	0,2	S	2000	17,40
17	x	24	x	0,3	S	1000	17,00
17	x	24	x	0,5	S	1000	18,20
17	x	24	x	1	S	1000	20,00
17	x	24	x	2	S	1000	20,50
18	x	25	x	0,1	S	2000	12,50
18	x	25	x	0,2	S	2000	13,40
18	x	25	x	0,25	S	2000	14,80
18	x	25	x	0,3	S	1000	14,70
18	x	25	x	0,5	S	1000	15,70
18	x	25	x	1	S	1000	19,70

Abmessungen	VE	Stück	€/100/Obf.				
20	x	28	x	0,1	S	2000	13,70
20	x	28	x	0,15	S	1000	14,60
20	x	28	x	0,2	S	1000	15,50
20	x	28	x	0,25	S	1000	20,70
20	x	28	x	0,3	S	1000	16,60
20	x	28	x	0,5	S	1000	15,20
20	x	28	x	1	S	1000	19,70
20	x	28	x	1,5	S	1000	52,00
20	x	30	x	0,5	S	1000	57,00
20	x	32	x	0,1	S	1000	19,40
20	x	32	x	0,5	S	1000	20,60
20	x	32	x	1	S	1000	21,80
22	x	30	x	0,1	S	2000	16,50
22	x	30	x	0,2	S	1000	20,00
22	x	30	x	0,5	S	1000	19,80
22	x	30	x	1	S	1000	29,50
22	x	30	x	1,5	S	1000	51,00
22	x	32	x	0,1	S	1000	13,70
22	x	32	x	0,2	S	1000	15,20
22	x	32	x	0,3	S	1000	17,70
22	x	32	x	0,5	S	1000	18,70
22	x	32	x	1	S	500	27,50
25	x	35	x	0,1	S	1000	13,10
25	x	35	x	0,15	S	1000	15,20
25	x	35	x	0,2	S	1000	16,00
25	x	35	x	0,25	S	1000	16,70
25	x	35	x	0,3	S	1000	17,20
25	x	35	x	0,5	S	1000	18,70
25	x	35	x	1	S	500	27,00
25	x	35	x	1,5	S	500	67,00
25	x	35	x	2	S	500	76,00
25	x	36	x	0,5	S	500	23,40
25	x	36	x	1	S	500	37,00
26	x	37	x	0,1	S	1000	14,40
26	x	37	x	0,2	S	1000	16,60
26	x	37	x	0,25	S	1000	18,80
26	x	37	x	0,5	S	500	18,80
26	x	37	x	1	S	500	31,00
28	x	40	x	0,1	S	1000	14,20
28	x	40	x	0,2	S	1000	15,00
28	x	40	x	0,25	S	1000	19,40
28	x	40	x	0,3	S	1000	18,70
28	x	40	x	0,5	S	500	22,30
28	x	40	x	1	S	500	36,00
30	x	40	x	1	S	1000	73,00
30	x	42	x	0,1	S	1000	16,50
30	x	42	x	0,15	S	1000	17,80
30	x	42	x	0,2	S	1000	19,30
30	x	42	x	0,25	S	1000	22,00
30	x	42	x	0,3	S	1000	22,60
30	x	42	x	0,5	S	500	24,60
30	x	42	x	1	S	500	34,00
30	x	42	x	1,5	S	250	72,00
30	x	42	x	2	S	200	101,00
32	x	45	x	0,1	S	1000	16,60
32	x	45	x	0,25	S	1000	22,40
32	x	45	x	0,3	S	1000	26,50
32	x	45	x	0,5	S	500	29,50
32	x	45	x	1	S	250	41,00
32	x	45	x	1,5	S	250	53,00
32	x	45	x	2	S	200	130,00
35	x	45	x	0,1	S	1000	17,10
35	x	45	x	0,15	S	1000	20,90
35	x	45	x	0,2	S	1000	23,20
35	x	45	x	0,3	S	1000	23,60
35	x	45	x	0,5	S	500	26,50
35	x	45	x	1	S	250	37,00
35	x	45	x	1,5	S	250	84,00
35	x	45	x	2	S	200	112,00
36	x	45	x	1	S	250	41,50
37	x	47	x	0,1	S	1000	15,30
37	x	47	x	0,15	S	1000	17,80
37	x	47	x	0,2	S	1000	20,40
37	x	47	x	0,25	S	1000	33,00
37	x	47	x	0,3	S	1000	22,90

Abmessungen	VE	Stück	€/100/Obf.
37 x 47 x 0,5 S 500			26,50
37 x 47 x 1 S 250			37,00
37 x 47 x 2 S 200			148,00
40 x 50 x 0,1 S 500			16,60
40 x 50 x 0,15 S 500			19,80
40 x 50 x 0,2 S 500			25,00
40 x 50 x 0,3 S 250			28,50
40 x 50 x 0,5 S 100			28,50
40 x 50 x 1 S 100			46,00
40 x 50 x 1,5 S 100			126,00
40 x 50 x 2 S 100			143,00
42 x 52 x 0,1 S 500			17,40
42 x 52 x 0,2 S 500			16,40
42 x 52 x 0,3 S 250			27,50
42 x 52 x 0,5 S 100			36,00
42 x 52 x 1 S 100			51,00
42 x 52 x 2 S 100			177,00
45 x 55 x 0,1 S 500			21,10
45 x 55 x 0,15 S 500			22,60
45 x 55 x 0,2 S 500			24,00
45 x 55 x 0,3 S 250			30,50
45 x 55 x 0,5 S 200			33,50
45 x 55 x 1 S 100			51,00
45 x 55 x 2 S 100			148,00
48 x 60 x 0,5 S 200			46,00
48 x 60 x 1 S 100			67,00
50 x 62 x 0,1 S 500			20,70
50 x 62 x 0,15 S 500			24,00
50 x 62 x 0,2 S 500			27,50
50 x 62 x 0,3 S 250			37,00
50 x 62 x 0,5 S 100			42,00
50 x 62 x 1 S 100			62,00
50 x 62 x 1,5 S 100			74,00
50 x 62 x 2 S 100			175,00
52 x 65 x 0,1 S 500			31,50
52 x 65 x 0,5 S 100			51,00
52 x 65 x 1 S 100			91,00
52 x 65 x 2 S 100			240,00
52 x 65 x 3,0 S 100			370,00
55 x 68 x 0,1 S 500			33,00
55 x 68 x 0,15 S 500			45,50
55 x 68 x 0,2 S 500			59,00
55 x 68 x 0,3 S 250			17,00
55 x 68 x 0,5 S 100			69,00
55 x 68 x 1 S 100			82,00
55 x 68 x 2 S 100			97,00
56 x 72 x 0,1 S 500			39,50
56 x 72 x 0,15 S 500			45,00
56 x 72 x 0,2 S 500			51,00
56 x 72 x 0,3 S 250			59,00
56 x 72 x 0,5 S 200			66,00
56 x 72 x 1 S 100			106,00
56 x 72 x 1,5 S 100			115,00
56 x 72 x 2 S 100			340,00
60 x 75 x 0,1 S 500			42,00
60 x 75 x 0,15 S 500			47,50
60 x 75 x 0,2 S 500			54,00
60 x 75 x 0,3 S 250			72,00
60 x 75 x 0,5 S 100			72,00
60 x 75 x 1 S 100			95,00
60 x 75 x 1,5 S 100			128,00
60 x 75 x 2 S 100			340,00
63 x 80 x 0,1 S 500			43,00
63 x 80 x 0,15 S 500			46,00
63 x 80 x 0,2 S 500			51,00
63 x 80 x 0,3 S 250			66,00
63 x 80 x 0,5 S 100			78,00
63 x 80 x 1 S 100			112,00
63 x 80 x 2 S 100			205,00
65 x 85 x 0,1 S 500			51,00
65 x 85 x 0,15 S 500			57,00
65 x 85 x 0,2 S 500			63,00
65 x 85 x 0,3 S 250			30,50
65 x 85 x 0,5 S 200			85,00
65 x 85 x 2 S 100			194,00

Abmessungen	VE	Stück	€/100/Obf.
70 x 90 x 0,1 S 500			59,00
70 x 90 x 0,15 S 500			61,00
70 x 90 x 0,2 S 500			63,00
70 x 90 x 0,3 S 250			86,00
70 x 90 x 0,5 S 200			83,00
70 x 90 x 1 S 100			132,00
70 x 90 x 1,5 S 100			206,00
70 x 90 x 2 S 50			295,00
75 x 95 x 0,1 S 500			69,00
75 x 95 x 0,3 S 250			76,00
75 x 95 x 0,5 S 100			79,00
75 x 95 x 1 S 100			183,00
80 x 100 x 0,1 S 100			73,00
80 x 100 x 0,15 S 100			77,00
80 x 100 x 0,2 S 100			82,00
80 x 100 x 0,3 S 100			79,00
80 x 100 x 0,5 S 100			86,00
80 x 100 x 1 S 100			212,00
80 x 100 x 2 S 100			485,00
90 x 110 x 0,1 S 100			85,00
90 x 110 x 0,3 S 100			100,00
90 x 110 x 0,5 S 100			126,00
90 x 110 x 1 S 100			205,00
90 x 110 x 2 S 100			620,00
100 x 120 x 0,1 S 100			103,00
100 x 120 x 0,5 S 100			115,00
100 x 120 x 1 S 100			234,00
100 x 120 x 2 S 100			211,00
110 x 140 x 0,1 S 100			134,00
110 x 140 x 0,3 S 100			255,00
110 x 140 x 1 S 100			325,00
130 x 150 x 0,5 S 100			146,00

DIN 00988.004

988 Federstahl



Stützscheiben

Stahl → S. 203
Rostfrei → S. 513



Loch Ø x Außen Ø x Dicke

3 x 6 x 1 S 5000			11,10
4 x 8 x 1 S 2000			10,80
6 x 12 x 1,2 S 2000			14,80
8 x 14 x 1,2 S 1000			16,70
10 x 16 x 1,2 S 1000			18,00
12 x 18 x 1,2 S 1000			23,60
14 x 20 x 1,5 S 1000			28,50
15 x 21 x 1,5 S 1000			29,50
15 x 22 x 1,5 S 1000			33,00
16 x 22 x 1,5 S 1000			26,00
17 x 24 x 1,5 S 1000			27,50
18 x 25 x 1,5 S 500			29,50
20 x 28 x 2 S 500			57,00
22 x 30 x 2 S 500			62,00
22 x 32 x 2 S 250			67,00
25 x 35 x 2 S 250			72,00
25 x 36 x 2 S 250			92,00
26 x 37 x 2 S 250			92,00
28 x 40 x 2 S 250			99,00
30 x 42 x 2,5 S 100			99,00
35 x 45 x 2,5 S 100			160,00
37 x 47 x 2,5 S 100			181,00
40 x 50 x 2,5 S 100			167,00

Abmessungen	VE	Stück	€/100/Obf.
42 x 52 x 2,5 S 100			172,00
45 x 55 x 3 S 100			177,00
45 x 56 x 3 S 100			183,00
50 x 62 x 3 S 100			220,00
50 x 63 x 3 S 100			220,00
55 x 68 x 3 S 100			335,00
56 x 72 x 3 S 100			355,00
60 x 75 x 3 S 100			315,00
63 x 80 x 3 S 100			355,00
65 x 85 x 3,5 S 50			690,00
70 x 90 x 3,5 S 50			495,00
75 x 95 x 3,5 S 50			720,00
80 x 100 x 3,5 S 50			760,00
85 x 105 x 3,5 S 50			770,00
90 x 110 x 3,5 S 50			730,00
100 x 120 x 3,5 S 50			1170,00
100 x 125 x 3,5 S 50			1340,00
110 x 140 x 3,5 S 50			1580,00
130 x 160 x 3,5 S 50			2000,00

DIN 01052.015

1052 Temperguss galv. verzinkt

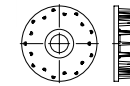

Holzverbinder, Dorne einseitig

(= Einpressdübel Typ D-System Geka
~DIN EN 912 Typ C11)

Korrosionsschutz → TI-228

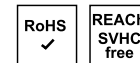

Außen Ø x Loch Ø x für Schrauben · ÜH-Fabrikate

50 x 13 x M12 S 50			128,00 gal Zn
65 x 17 x M16 S 50			285,00 gal Zn
80 x 21 x M20 S 50			315,00 gal Zn
95 x 25 x M24 S 50			415,00 gal Zn
115 x 25 x M24 S 50			680,00 gal Zn

DIN 01052.024

1052 Stahlblech feuerverzinkt



Holzverbinder, Dorne einseitig

(= Einpressdübel Typ C-System Bulldog
~DIN EN 912 Typ C2)

Korrosionsschutz → TI-231

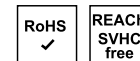

Außen Ø x für Schrauben · ÜH-Fabrikate

48 M12 S 300			94,00 tZn
62 M12 S 150			151,00 tZn
75 M16 S 100			197,00 tZn
95 M16 S 50			365,00 tZn

Abmessungen	VE Stück	€/100/Obf.
DIN	01052.016	
1052	Temperguss	galv. verzinkt

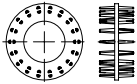

Holzverbinder, Dorne zweiseitig

(= Einpressdübel Typ D-System Geka
~DIN EN 912 Typ C10)

Korrosionsschutz → **TI-228**



Außen Ø x Loch Ø x für Schrauben · ÜH-Fabrikate

50	x	29	x	M12	S	50	126,00 gal Zn
65	x	35	x	M16	S	50	224,00 gal Zn
80	x	50	x	M20	S	25	305,00 gal Zn
95	x	64	x	M24	S	25	445,00 gal Zn
115	x	84	x	M24	S	25	570,00 gal Zn

DIN	01052.025
1052	Stahlblech
	feuerverzinkt

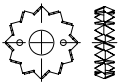

Holzverbinder, Dorne zweiseitig

(= Einpressdübel Typ C-System Bulldog
~DIN EN 912 Typ C1)

Korrosionsschutz → **TI-231**

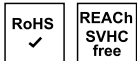

Außen Ø x für Schrauben · ÜH-Fabrikate

48 M 12-M 16	S	200	101,00 tZn
62 M 12-M 20	S	100	174,00 tZn
75 M 16-M 24	S	100	224,00 tZn

DIN	01052.004
1052	Stahl

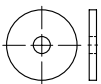

Scheiben für Holzverbinder, starke, runde Ausführung

Maße → **TI-85**

Rostfrei → **S. 513**

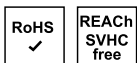

Loch Ø x Außen Ø x Dicke · ÜH-Fabrikate

14	x	58	x	6	S	50	72,00
18	x	68	x	6	S	50	96,00
23	x	80	x	8	S	50	220,00
25	x	92	x	8	S	25	410,00
27	x	105	x	8	S	25	485,00

Abmessungen	VE Stück	€/100/Obf.
DIN	01052.014	
1052	Stahl	galvanisch verzinkt



Scheiben für Holzverbinder, starke, runde Ausführung

Maße → **TI-85**

Korrosionsschutz → **TI-228**

Rostfrei → **S. 513**

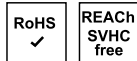

Loch Ø x Außen Ø x Dicke · ÜH-Fabrikate

14	x	58	x	6	S	50	111,00 gal Zn
18	x	68	x	6	S	50	147,00 gal Zn
23	x	80	x	8	S	50	300,00 gal Zn
25	x	92	x	8	S	25	540,00 gal Zn
27	x	105	x	8	S	25	650,00 gal Zn

DIN	01052.026
1052	Stahl
	feuerverzinkt



Scheiben für Holzverbinder, starke, runde Ausführung

Maße → **TI-85**

Korrosionsschutz → **TI-231**

Rostfrei → **S. 513**



Loch Ø x Außen Ø x Dicke · ÜH-Fabrikate

14	x	58	x	6	S	50	153,00 tZn
18	x	68	x	6	S	50	206,00 tZn
23	x	80	x	8	S	50	390,00 tZn
25	x	92	x	8	S	25	690,00 tZn
27	x	105	x	8	S	25	830,00 tZn

Abmessungen	VE Stück	€/100/Obf.
ISO	01207.004	
1207	Stahl	blank gedreht



Zylinderschrauben mit Schlitz

Maße → **TI-37**

REACH → **TI-262**

Normumstellung → **TI-11**

Rostfrei → **S. 513**

Messing/Kunststoff → **S. 630**

ISO 1207 → ersetzt DIN 84 (austauschbar)



M 1	x	2	S	100	26,50 gedreht
M 1	x	3	S	100	28,00 gedreht
M 1	x	5	S	100	28,00 gedreht
M 1	x	6	S	100	28,50 gedreht
M 1	x	8	S	100	29,50 gedreht
M 1	x	10	S	100	34,00 gedreht
M 1,2	x	2	S	100	26,50 gedreht
M 1,2	x	3	S	100	26,50 gedreht
M 1,2	x	4	S	100	29,00 gedreht
M 1,2	x	6	S	100	29,00 gedreht
M 1,2	x	8	S	100	29,50 gedreht
M 1,2	x	10	S	100	32,00 gedreht
M 1,4	x	2	S	100	26,00 gedreht
M 1,4	x	3	S	100	26,00 gedreht
M 1,4	x	4	S	100	27,50 gedreht
M 1,4	x	5	S	100	28,00 gedreht
M 1,4	x	6	S	100	25,50 gedreht
M 1,4	x	8	S	100	30,50 gedreht
M 1,4	x	10	S	100	32,00 gedreht
M 1,4	x	16	S	100	39,50 gedreht
M 1,6	x	3	S	100	23,40 gedreht
M 1,6	x	4	S	100	24,70 gedreht
M 1,6	x	5	S	100	25,50 gedreht
M 1,6	x	6	S	100	26,50 gedreht
M 1,6	x	8	S	100	30,50 gedreht
M 1,6	x	10	S	100	31,50 gedreht
M 1,6	x	16	S	100	42,50 gedreht

ISO	01207.400
1207	4.8

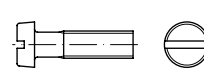

Zylinderschrauben mit Schlitz

Maße → **TI-37**

Normumstellung → **TI-11**

Werkstoffeigensch. → **TI-232**

REACH → **TI-262**

Rostfrei → **S. 513**

Messing/Kunststoff → **S. 630**

ISO 1207 → ersetzt DIN 84 (austauschbar)



M 2	x	3	S	2000	4,55
M 2	x	4	S	2000	3,65
M 2	x	5	S	2000	3,60

Abmessungen	VE	Stück	€/100/Obf.	Abmessungen	VE	Stück	€/100/Obf.	Abmessungen	VE	Stück	€/100/Obf.
M 2 x 6	S	2000	3,15	M 6 x 16	S	1000	5,90	M 2 x 18	K	200	8,00 gal Zn
M 2 x 8	S	2000	3,25	M 6 x 20	S	1000	6,70	M 2 x 20	S	2000	5,50 gal Zn
M 2 x 10	S	2000	3,35	M 6 x 25	S	500	7,30	M 2 x 20	K	200	8,50 gal Zn
M 2 x 12	S	2000	3,45	M 6 x 30	S	500	8,30	M 2 x 30	S	2000	10,80 gal Zn
M 2 x 16	S	2000	3,90	M 6 x 35	S	500	9,10	M 2 x 30	K	200	14,60 gal Zn
M 2 x 20	S	2000	5,00	M 6 x 40	S	500	10,10	M 2,5 x 3	K	200	12,60 gal Zn
M 2,5 x 4	S	2000	5,10	M 6 x 45	S	500	13,60	M 2,5 x 4	S	2000	5,60 gal Zn
M 2,5 x 5	S	2000	4,80	M 6 x 50	S	200	15,50	M 2,5 x 4	K	200	8,60 gal Zn
M 2,5 x 6	S	2000	3,00	M 6 x 55	S	200	17,70	M 2,5 x 5	S	2000	5,30 gal Zn
M 2,5 x 8	S	2000	3,10	M 6 x 60	S	200	21,30	M 2,5 x 5	K	200	8,20 gal Zn
M 2,5 x 10	S	2000	3,30	M 6 x 65	S	200	23,30	M 2,5 x 6	S	2000	3,30 gal Zn
M 2,5 x 12	S	2000	3,60	M 6 x 70	S	200	24,50	M 2,5 x 6	K	200	6,30 gal Zn
M 2,5 x 16	S	2000	4,15	M 6 x 75	S	200	36,00	M 2,5 x 8	S	2000	3,35 gal Zn
M 2,5 x 18	S	2000	4,65	M 6 x 80	S	200	40,00	M 2,5 x 8	K	200	6,20 gal Zn
M 2,5 x 20	S	2000	4,85	M 6 x 100	S	200	45,50	M 2,5 x 10	S	2000	3,60 gal Zn
M 2,5 x 25	S	2000	5,50	M 8 x 10	S	500	36,50	M 2,5 x 10	K	200	5,90 gal Zn
M 2,5 x 30	S	2000	7,20	M 8 x 12	S	500	14,30	M 2,5 x 12	S	2000	3,85 gal Zn
M 3 x 3	S	2000	8,80	M 8 x 16	S	500	14,80	M 2,5 x 12	K	200	6,00 gal Zn
M 3 x 4	S	2000	5,30	M 8 x 20	S	500	15,20	M 2,5 x 16	S	2000	4,45 gal Zn
M 3 x 5	S	2000	5,10	M 8 x 25	S	500	15,70	M 2,5 x 16	K	200	7,40 gal Zn
M 3 x 6	S	2000	1,35	M 8 x 30	S	200	21,70	M 2,5 x 18	K	200	8,20 gal Zn
M 3 x 8	S	2000	1,40	M 8 x 35	S	200	22,50	M 2,5 x 20	S	2000	5,40 gal Zn
M 3 x 10	S	2000	1,45	M 8 x 40	S	200	23,60	M 2,5 x 20	K	200	8,40 gal Zn
M 3 x 12	S	2000	1,55	M 8 x 45	S	200	31,00	M 2,5 x 25	S	2000	6,20 gal Zn
M 3 x 16	S	2000	1,75	M 8 x 50	S	200	35,00	M 2,5 x 25	K	200	9,10 gal Zn
M 3 x 18	S	2000	3,30	M 8 x 55	S	200	41,00	M 2,5 x 30	S	2000	8,00 gal Zn
M 3 x 20	S	2000	3,60	M 8 x 60	S	200	45,00	M 2,5 x 30	K	200	10,90 gal Zn
M 3 x 22	S	2000	4,10	M 8 x 70	S	200	50,00	M 3 x 3	S	2000	9,70 gal Zn
M 3 x 25	S	2000	4,30	M 10 x 12	S	200	92,00	M 3 x 3	K	200	12,60 gal Zn
M 3 x 30	S	2000	4,55	M 10 x 16	S	200	31,00	M 3 x 4	S	2000	5,90 gal Zn
M 3 x 35	S	2000	4,85	M 10 x 20	S	200	28,50	M 3 x 4	K	200	8,80 gal Zn
M 3 x 40	S	1000	5,40	M 10 x 25	S	200	35,00	M 3 x 5	S	2000	5,60 gal Zn
M 3 x 45	S	1000	7,80	M 10 x 30	S	200	36,50	M 3 x 5	K	200	8,60 gal Zn
M 3 x 50	S	1000	8,80	M 10 x 40	S	200	38,00	M 3 x 6	S	2000	1,50 gal Zn
M 4 x 4	S	2000	9,60	M 10 x 45	S	100	45,50	M 3 x 6	K	200	4,40 gal Zn
M 4 x 5	S	2000	6,50					M 3 x 8	S	2000	1,55 gal Zn
M 4 x 6	S	2000	2,15					M 3 x 8	K	200	4,45 gal Zn
M 4 x 8	S	2000	2,20					M 3 x 10	S	2000	1,60 gal Zn
M 4 x 10	S	2000	2,25					M 3 x 10	K	200	4,55 gal Zn
M 4 x 12	S	2000	2,30					M 3 x 12	S	2000	1,70 gal Zn
M 4 x 16	S	2000	2,75					M 3 x 12	K	200	4,60 gal Zn
M 4 x 20	S	2000	3,10					M 3 x 14	S	2000	2,80 gal Zn
M 4 x 22	S	1000	3,40					M 3 x 14	K	200	5,70 gal Zn
M 4 x 25	S	1000	3,60					M 3 x 16	S	2000	3,10 gal Zn
M 4 x 30	S	1000	4,20					M 3 x 16	K	200	6,10 gal Zn
M 4 x 35	S	1000	4,80					M 3 x 18	S	2000	3,65 gal Zn
M 4 x 40	S	1000	5,30					M 3 x 18	K	200	6,70 gal Zn
M 4 x 45	S	1000	6,70					M 3 x 20	S	2000	4,00 gal Zn
M 4 x 50	S	1000	8,20					M 3 x 20	K	200	7,10 gal Zn
M 4 x 55	S	500	12,30					M 3 x 22	S	2000	4,45 gal Zn
M 4 x 60	S	500	13,50					M 3 x 22	K	200	7,40 gal Zn
M 4 x 65	S	500	15,00					M 3 x 25	S	2000	4,90 gal Zn
M 4 x 70	S	500	21,10					M 3 x 25	K	200	7,60 gal Zn
M 5 x 6	S	2000	9,60					M 3 x 28	S	2000	5,10 gal Zn
M 5 x 8	S	2000	3,25					M 3 x 28	K	200	7,80 gal Zn
M 5 x 10	S	2000	3,40					M 3 x 30	S	2000	5,30 gal Zn
M 5 x 12	S	1000	3,65					M 3 x 30	K	200	8,00 gal Zn
M 5 x 16	S	1000	4,15					M 3 x 35	S	2000	5,40 gal Zn
M 5 x 18	S	1000	5,70					M 3 x 35	K	200	8,30 gal Zn
M 5 x 20	S	1000	6,20					M 3 x 40	S	1000	5,90 gal Zn
M 5 x 22	S	1000	7,30					M 3 x 40	K	200	8,90 gal Zn
M 5 x 25	S	1000	7,70					M 3 x 45	S	1000	8,60 gal Zn
M 5 x 30	S	1000	8,00					M 3 x 45	K	200	11,50 gal Zn
M 5 x 35	S	500	8,20					M 3 x 50	S	1000	9,60 gal Zn
M 5 x 40	S	500	9,20					M 3 x 50	K	200	12,60 gal Zn
M 5 x 45	S	500	9,70					M 3 x 55	S	200	17,00 gal Zn
M 5 x 50	S	500	10,20					M 3 x 60	K	200	17,00 gal Zn
M 5 x 55	S	500	13,50					M 3,5 x 5	K	200	11,10 gal Zn
M 5 x 60	S	200	13,90					M 3,5 x 6	S	2000	5,50 gal Zn
M 5 x 70	S	200	15,00					M 3,5 x 6	K	200	8,50 gal Zn
M 5 x 75	S	200	27,50					M 3,5 x 8	K	200	6,70 gal Zn
M 5 x 80	S	200	32,00					M 3,5 x 10	S	2000	3,90 gal Zn
M 6 x 8	S	1000	6,50					M 3,5 x 10	K	200	6,80 gal Zn
M 6 x 10	S	1000	5,30					M 3,5 x 12	S	2000	3,95 gal Zn
M 6 x 12	S	1000	5,40					M 3,5 x 12	K	200	6,90 gal Zn

ISO 01207.410
1207 4.8
 galvanisch verzinkt



Zylinderschrauben mit Schlitz

Maße → TI-37 Normumstellung → TI-11
 Werkstoffeigensch. → TI-232 REACH → TI-262
 Korrosionsschutz → TI-228
 Rostfrei → S. 513
 Messing/Kunststoff → S. 630
 ISO 1207 → ersetzt DIN 84 (austauschbar)



M 2 x 3	S	2000	5,00 gal Zn
M 2 x 3	K	200	8,00 gal Zn
M 2 x 4	S	2000	4,10 gal Zn
M 2 x 4	K	200	6,90 gal Zn
M 2 x 5	S	2000	3,90 gal Zn
M 2 x 5	K	200	6,80 gal Zn
M 2 x 6	S	2000	3,45 gal Zn
M 2 x 6	K	200	6,50 gal Zn
M 2 x 8	S	2000	3,50 gal Zn
M 2 x 8	K	200	6,40 gal Zn
M 2 x 10	S	2000	3,10 gal Zn
M 2 x 10	K	200	6,00 gal Zn
M 2 x 12	S	2000	3,85 gal Zn
M 2 x 12	K	200	6,80 gal Zn
M 2 x 16	S	2000	4,10 gal Zn
M 2 x 16	K	200	7,10 gal Zn

Abmessungen	VE	Stück	€/100/Obf.	Abmessungen	VE	Stück	€/100/Obf.	Abmessungen	VE	Stück	€/100/Obf.
M 3,5 x 16	S	2000	4,80 gal Zn	M 5 x 25	S	1000	8,50 gal Zn	M 8 x 45	K	100	36,50 gal Zn
M 3,5 x 16	K	200	7,80 gal Zn	M 5 x 25	K	200	11,30 gal Zn	M 8 x 50	K	100	39,50 gal Zn
M 3,5 x 18	K	200	8,10 gal Zn	M 5 x 30	S	1000	8,70 gal Zn	M 8 x 55	K	100	44,00 gal Zn
M 3,5 x 20	S	2000	5,40 gal Zn	M 5 x 30	K	200	11,50 gal Zn	M 8 x 60	K	100	46,00 gal Zn
M 3,5 x 20	K	200	8,40 gal Zn	M 5 x 35	S	500	9,00 gal Zn	M 8 x 70	K	100	48,00 gal Zn
M 3,5 x 25	K	200	8,90 gal Zn	M 5 x 35	K	200	11,90 gal Zn	M 8 x 80	K	100	63,00 gal Zn
M 3,5 x 30	K	200	10,50 gal Zn	M 5 x 40	S	500	9,80 gal Zn	M 8 x 90	K	100	69,00 gal Zn
M 3,5 x 35	K	200	12,10 gal Zn	M 5 x 40	K	200	12,40 gal Zn	M 8 x 100	K	100	80,00 gal Zn
M 3,5 x 40	K	200	13,00 gal Zn	M 5 x 45	S	500	10,70 gal Zn	M 10 x 12	K	100	98,00 gal Zn
M 3,5 x 45	K	200	16,00 gal Zn	M 5 x 45	K	200	13,60 gal Zn	M 10 x 16	K	100	36,50 gal Zn
M 3,5 x 50	K	200	19,30 gal Zn	M 5 x 50	S	500	12,10 gal Zn	M 10 x 20	K	100	34,50 gal Zn
M 4 x 4	S	2000	10,60 gal Zn	M 5 x 50	K	200	14,50 gal Zn	M 10 x 25	K	100	36,00 gal Zn
M 4 x 4	K	200	13,40 gal Zn	M 5 x 55	S	500	14,30 gal Zn	M 10 x 30	K	100	42,50 gal Zn
M 4 x 5	S	2000	7,20 gal Zn	M 5 x 55	K	200	16,10 gal Zn	M 10 x 35	K	100	47,50 gal Zn
M 4 x 5	K	200	10,20 gal Zn	M 5 x 60	K	200	19,30 gal Zn	M 10 x 40	K	100	49,00 gal Zn
M 4 x 6	S	2000	2,30 gal Zn	M 5 x 65	K	100	22,00 gal Zn	M 10 x 50	K	100	53,00 gal Zn
M 4 x 6	K	200	5,30 gal Zn	M 5 x 70	S	200	16,00 gal Zn	M 10 x 60	K	100	60,00 gal Zn
M 4 x 8	S	2000	2,30 gal Zn	M 5 x 70	K	100	25,00 gal Zn	M 10 x 70	K	100	73,00 gal Zn
M 4 x 8	K	200	5,30 gal Zn	M 5 x 80	S	200	26,00 gal Zn	M 10 x 80	K	50	86,00 gal Zn
M 4 x 10	S	2000	2,45 gal Zn	M 5 x 80	K	100	31,50 gal Zn	M 10 x 100	K	50	118,00 gal Zn
M 4 x 10	K	200	5,40 gal Zn	M 5 x 90	S	200	49,50 gal Zn				
M 4 x 12	S	2000	2,50 gal Zn	M 5 x 90	K	100	55,00 gal Zn				
M 4 x 12	K	200	5,80 gal Zn	M 5 x 100	S	200	56,00 gal Zn				
M 4 x 14	S	2000	3,75 gal Zn	M 5 x 100	K	100	67,00 gal Zn				
M 4 x 14	K	200	6,70 gal Zn	M 6 x 6	S	1000	21,00 gal Zn				
M 4 x 16	S	2000	4,00 gal Zn	M 6 x 6	K	200	23,90 gal Zn				
M 4 x 16	K	200	7,00 gal Zn	M 6 x 8	S	1000	7,20 gal Zn				
M 4 x 18	S	2000	4,40 gal Zn	M 6 x 8	K	200	10,10 gal Zn				
M 4 x 18	K	200	7,30 gal Zn	M 6 x 10	S	1000	48,00 gal Zn				
M 4 x 20	S	2000	5,00 gal Zn	M 6 x 10	K	200	8,80 gal Zn				
M 4 x 20	K	200	7,60 gal Zn	M 6 x 12	S	1000	5,90 gal Zn				
M 4 x 22	S	1000	5,40 gal Zn	M 6 x 12	K	200	8,90 gal Zn				
M 4 x 22	K	200	7,90 gal Zn	M 6 x 14	S	1000	7,20 gal Zn				
M 4 x 25	S	1000	5,80 gal Zn	M 6 x 14	K	200	9,10 gal Zn				
M 4 x 25	K	200	8,00 gal Zn	M 6 x 16	S	1000	8,20 gal Zn				
M 4 x 28	S	1000	6,20 gal Zn	M 6 x 16	K	200	9,50 gal Zn				
M 4 x 28	K	200	8,20 gal Zn	M 6 x 18	S	1000	8,60 gal Zn				
M 4 x 30	S	1000	6,60 gal Zn	M 6 x 18	K	200	9,80 gal Zn				
M 4 x 30	K	200	8,40 gal Zn	M 6 x 20	S	1000	9,00 gal Zn				
M 4 x 35	S	1000	6,80 gal Zn	M 6 x 20	K	200	10,50 gal Zn				
M 4 x 35	K	200	8,60 gal Zn	M 6 x 22	K	200	11,20 gal Zn				
M 4 x 40	S	1000	36,50 gal Zn	M 6 x 25	S	500	9,40 gal Zn				
M 4 x 40	K	200	8,80 gal Zn	M 6 x 25	K	200	11,40 gal Zn				
M 4 x 45	S	1000	7,30 gal Zn	M 6 x 30	S	500	9,80 gal Zn				
M 4 x 45	K	200	10,30 gal Zn	M 6 x 30	K	200	12,10 gal Zn				
M 4 x 50	S	1000	8,90 gal Zn	M 6 x 35	S	500	10,20 gal Zn				
M 4 x 50	K	200	11,80 gal Zn	M 6 x 35	K	200	12,40 gal Zn				
M 4 x 55	S	500	13,50 gal Zn	M 6 x 40	S	500	11,20 gal Zn				
M 4 x 55	K	200	12,90 gal Zn	M 6 x 40	K	200	14,10 gal Zn				
M 4 x 60	S	500	18,00 gal Zn	M 6 x 45	S	500	15,00 gal Zn				
M 4 x 60	K	200	14,00 gal Zn	M 6 x 45	K	200	20,90 gal Zn				
M 4 x 65	K	100	20,10 gal Zn	M 6 x 50	K	200	22,10 gal Zn				
M 4 x 70	S	500	23,00 gal Zn	M 6 x 55	K	100	25,50 gal Zn				
M 4 x 70	K	100	29,00 gal Zn	M 6 x 60	S	200	17,60 gal Zn				
M 4 x 80	K	100	33,50 gal Zn	M 6 x 60	K	100	28,00 gal Zn				
M 4 x 90	K	100	50,00 gal Zn	M 6 x 65	S	200	21,00 gal Zn				
M 4 x 100	K	100	54,00 gal Zn	M 6 x 70	S	200	27,00 gal Zn				
M 5 x 6	S	2000	10,70 gal Zn	M 6 x 70	K	100	39,00 gal Zn				
M 5 x 6	K	200	13,60 gal Zn	M 6 x 80	K	100	41,50 gal Zn				
M 5 x 8	S	2000	3,60 gal Zn	M 6 x 90	K	100	58,00 gal Zn				
M 5 x 8	K	200	6,50 gal Zn	M 6 x 100	S	200	50,00 gal Zn				
M 5 x 10	S	1000	36,50 gal Zn	M 6 x 100	K	100	62,00 gal Zn				
M 5 x 10	K	200	6,70 gal Zn	M 8 x 10	K	100	40,00 gal Zn				
M 5 x 12	S	1000	38,00 gal Zn	M 8 x 12	K	100	18,80 gal Zn				
M 5 x 12	K	200	6,90 gal Zn	M 8 x 16	S	500	16,50 gal Zn				
M 5 x 14	S	1000	6,00 gal Zn	M 8 x 16	K	100	19,30 gal Zn				
M 5 x 14	K	200	9,00 gal Zn	M 8 x 18	K	100	20,10 gal Zn				
M 5 x 16	S	1000	38,50 gal Zn	M 8 x 20	S	500	17,00 gal Zn				
M 5 x 16	K	200	9,10 gal Zn	M 8 x 20	K	100	21,10 gal Zn				
M 5 x 18	S	1000	6,30 gal Zn	M 8 x 25	S	500	17,50 gal Zn				
M 5 x 18	K	200	9,20 gal Zn	M 8 x 25	K	100	22,10 gal Zn				
M 5 x 20	S	1000	7,10 gal Zn	M 8 x 30	S	200	18,10 gal Zn				
M 5 x 20	K	200	10,10 gal Zn	M 8 x 30	K	100	23,90 gal Zn				
M 5 x 22	S	1000	8,20 gal Zn	M 8 x 35	K	100	29,50 gal Zn				
M 5 x 22	K	200	11,10 gal Zn	M 8 x 40	K	100	31,00 gal Zn				

ISO 01207.430
1207 4.8
 galvanisch vernickelt

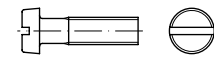

Zylinderschrauben mit Schlitz

Maße → **TI-37** Normumstellung → **TI-11**
 Werkstoffeigensch. → **TI-232** REACH → **TI-262**
 Korrosionsschutz → **TI-228**

Rostfrei → **S. 513**
 Messing/Kunststoff → **S. 630**

ISO 1207 → ersetzt DIN 84 (austauschbar)



M 3 x 6	S	2000	2,50 gal Ni
M 3 x 8	S	2000	2,60 gal Ni
M 3 x 10	S	2000	2,75 gal Ni
M 3 x 12	S	2000	2,90 gal Ni
M 3 x 16	S	2000	3,40 gal Ni
M 4 x 8	S	2000	4,10 gal Ni
M 4 x 10	S	2000	4,25 gal Ni
M 4 x 12	S	2000	4,95 gal Ni
M 4 x 16	S	2000	5,30 gal Ni
M 5 x 8	S	2000	6,20 gal Ni
M 5 x 10	S	2000	6,70 gal Ni
M 5 x 12	S	1000	6,90 gal Ni
M 5 x 16	S	1000	7,90 gal Ni

i

- ✓ Große Artikelvielfalt
- ✓ Verlässliche Qualität
- ✓ Hohe Lieferbereitschaft

Abmessungen	VE Stück	€/100/Obf.
ISO	01234.010	
<h1 style="font-size: 2em; margin: 0;">1234</h1> <p style="margin: 0;">Stahl galvanisch verzinkt</p>		

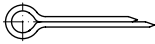

Splinte

Maße → **TI-22** Normumstellung → **TI-10**
 Korrosionsschutz → **TI-228**

Rostfrei → **S. 516**
 Kupfer → **S. 632**

ISO 1234 → ersetzt DIN 94 (austauschbar)

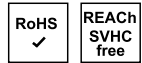

Nenn Ø = Bohrungs Ø x Länge

1	x	6	S	1000	1,70 gal Zn
1	x	8	S	1000	1,75 gal Zn
1	x	10	S	1000	1,80 gal Zn
1	x	12	S	1000	1,90 gal Zn
1	x	16	S	1000	2,00 gal Zn
1	x	18	S	1000	2,10 gal Zn
1	x	20	S	1000	2,20 gal Zn
1	x	22	S	1000	2,30 gal Zn
1	x	25	S	1000	2,45 gal Zn
1	x	32	S	1000	3,00 gal Zn
1	x	40	S	1000	3,75 gal Zn
1,2	x	8	S	1000	1,85 gal Zn
1,2	x	10	S	1000	1,90 gal Zn
1,2	x	12	S	1000	1,95 gal Zn
1,2	x	14	S	1000	2,00 gal Zn
1,2	x	16	S	1000	2,05 gal Zn
1,2	x	20	S	1000	2,10 gal Zn
1,2	x	25	S	1000	2,50 gal Zn
1,2	x	32	S	1000	3,00 gal Zn
1,2	x	36	S	1000	3,60 gal Zn
1,2	x	40	S	1000	3,75 gal Zn
1,6	x	8	S	1000	2,20 gal Zn
1,6	x	10	S	1000	2,25 gal Zn
1,6	x	12	S	1000	2,30 gal Zn
1,6	x	14	S	1000	2,35 gal Zn
1,6	x	16	S	1000	2,40 gal Zn
1,6	x	18	S	1000	2,45 gal Zn
1,6	x	20	S	1000	2,50 gal Zn
1,6	x	22	S	1000	2,60 gal Zn
1,6	x	25	S	1000	2,70 gal Zn
1,6	x	28	S	1000	2,75 gal Zn
1,6	x	32	S	1000	3,10 gal Zn
1,6	x	36	S	1000	3,60 gal Zn
1,6	x	40	S	1000	3,85 gal Zn
1,6	x	50	S	1000	5,30 gal Zn
2	x	8	S	1000	2,80 gal Zn
2	x	10	S	1000	2,85 gal Zn
2	x	12	S	1000	2,90 gal Zn
2	x	14	S	1000	2,95 gal Zn
2	x	16	S	1000	3,00 gal Zn
2	x	18	S	1000	3,05 gal Zn
2	x	20	S	1000	3,10 gal Zn
2	x	22	S	1000	3,20 gal Zn
2	x	25	S	1000	3,30 gal Zn
2	x	28	S	1000	3,40 gal Zn
2	x	32	S	1000	3,60 gal Zn
2	x	36	S	1000	3,85 gal Zn
2	x	40	S	1000	4,15 gal Zn
2	x	45	S	1000	5,40 gal Zn
2	x	50	S	1000	5,70 gal Zn
2,5	x	10	S	500	3,35 gal Zn
2,5	x	12	S	500	3,40 gal Zn
2,5	x	14	S	500	3,45 gal Zn

2,5	x	16	S	500	3,50 gal Zn
2,5	x	18	S	500	3,55 gal Zn
2,5	x	20	S	500	3,60 gal Zn
2,5	x	22	S	500	3,75 gal Zn
2,5	x	25	S	500	3,95 gal Zn
2,5	x	28	S	500	4,25 gal Zn
2,5	x	32	S	500	4,45 gal Zn
2,5	x	36	S	500	4,75 gal Zn
2,5	x	40	S	500	5,10 gal Zn
2,5	x	45	S	500	5,50 gal Zn
2,5	x	50	S	500	5,80 gal Zn
2,5	x	56	S	500	7,80 gal Zn
2,5	x	63	S	500	8,80 gal Zn
3,2	x	10	S	500	4,15 gal Zn
3,2	x	12	S	500	4,20 gal Zn
3,2	x	14	S	500	4,25 gal Zn
3,2	x	16	S	500	4,30 gal Zn
3,2	x	18	S	500	4,35 gal Zn
3,2	x	20	S	500	4,45 gal Zn
3,2	x	22	S	500	4,60 gal Zn
3,2	x	25	S	500	4,95 gal Zn
3,2	x	28	S	500	5,30 gal Zn
3,2	x	32	S	500	5,60 gal Zn
3,2	x	36	S	500	6,00 gal Zn
3,2	x	40	S	500	6,50 gal Zn
3,2	x	45	S	500	7,20 gal Zn
3,2	x	50	S	500	7,70 gal Zn
3,2	x	56	S	500	8,20 gal Zn
3,2	x	63	S	500	9,20 gal Zn
3,2	x	71	S	500	10,30 gal Zn
4	x	15	S	500	5,90 gal Zn
4	x	18	S	500	6,00 gal Zn
4	x	20	S	500	6,20 gal Zn
4	x	22	S	500	6,50 gal Zn
4	x	25	S	500	6,80 gal Zn
4	x	28	S	500	7,30 gal Zn
4	x	32	S	500	7,90 gal Zn
4	x	36	S	500	8,40 gal Zn
4	x	40	S	500	9,10 gal Zn
4	x	45	S	500	9,70 gal Zn
4	x	50	S	500	10,60 gal Zn
4	x	56	S	500	11,40 gal Zn
4	x	63	S	500	12,50 gal Zn
4	x	71	S	500	13,70 gal Zn
4	x	80	S	500	15,30 gal Zn
4	x	90	S	500	26,00 gal Zn
4	x	100	S	500	29,00 gal Zn
4	x	112	S	250	33,50 gal Zn
4	x	125	S	250	37,50 gal Zn
5	x	20	S	250	9,10 gal Zn
5	x	22	S	250	9,40 gal Zn
5	x	25	S	250	9,70 gal Zn
5	x	28	S	250	11,10 gal Zn
5	x	32	S	250	12,30 gal Zn
5	x	36	S	250	13,40 gal Zn
5	x	40	S	250	14,30 gal Zn
5	x	45	S	250	15,50 gal Zn
5	x	50	S	250	16,60 gal Zn
5	x	56	S	250	18,20 gal Zn
5	x	63	S	250	20,30 gal Zn
5	x	71	S	250	22,30 gal Zn
5	x	80	S	250	24,10 gal Zn
5	x	90	S	250	27,00 gal Zn
5	x	100	S	250	30,00 gal Zn
5	x	112	S	250	51,00 gal Zn
5	x	125	S	250	58,00 gal Zn
5	x	210	S	50	850,00 gal Zn
5,5	x	50	S	250	24,60 gal Zn
6,3	x	25	S	250	18,30 gal Zn
6,3	x	32	S	250	18,40 gal Zn
6,3	x	36	S	250	20,10 gal Zn
6,3	x	40	S	250	21,30 gal Zn
6,3	x	45	S	250	23,00 gal Zn
6,3	x	50	S	250	25,00 gal Zn
6,3	x	56	S	250	28,00 gal Zn

6,3	x	63	S	250	31,50 gal Zn
6,3	x	71	S	250	34,00 gal Zn
6,3	x	80	S	250	38,00 gal Zn
6,3	x	90	S	250	42,00 gal Zn
6,3	x	100	S	250	47,00 gal Zn
6,3	x	112	S	250	53,00 gal Zn
6,3	x	125	S	250	60,00 gal Zn
6,3	x	140	S	250	112,00 gal Zn
8	x	40	S	100	46,00 gal Zn
8	x	45	S	100	48,50 gal Zn
8	x	50	S	100	52,00 gal Zn
8	x	56	S	100	57,00 gal Zn
8	x	63	S	100	60,00 gal Zn
8	x	71	S	100	65,00 gal Zn
8	x	80	S	100	72,00 gal Zn
8	x	90	S	100	77,00 gal Zn
8	x	100	S	100	83,00 gal Zn
8	x	112	S	100	92,00 gal Zn
8	x	125	S	100	106,00 gal Zn
8	x	140	S	100	118,00 gal Zn
10	x	50	S	100	85,00 gal Zn
10	x	63	S	100	91,00 gal Zn
10	x	71	S	100	103,00 gal Zn
10	x	80	S	100	114,00 gal Zn
10	x	90	S	100	124,00 gal Zn
10	x	100	S	100	137,00 gal Zn
10	x	112	S	100	146,00 gal Zn
10	x	125	S	100	160,00 gal Zn
10	x	140	S	100	176,00 gal Zn
10	x	160	S	100	220,00 gal Zn
10	x	180	S	100	305,00 gal Zn
10	x	200	S	100	330,00 gal Zn
13	x	71	S	25	234,00 gal Zn
13	x	80	S	25	235,00 gal Zn
13	x	90	S	25	236,00 gal Zn
13	x	100	S	25	255,00 gal Zn
13	x	112	S	25	280,00 gal Zn
13	x	125	S	25	305,00 gal Zn
13	x	140	S	25	335,00 gal Zn
13	x	160	S	25	1010,00 gal Zn
13	x	180	S	25	1050,00 gal Zn
13	x	200	S	25	1170,00 gal Zn
13	x	250	S	25	2200,00 gal Zn
16	x	125	S	25	2440,00 gal Zn
16	x	140	S	25	2460,00 gal Zn
16	x	160	S	25	2550,00 gal Zn
16	x	180	S	25	2650,00 gal Zn
16	x	200	S	25	2750,00 gal Zn
16	x	250	S	25	2850,00 gal Zn

DIN	01440.000
<h1 style="font-size: 2em; margin: 0;">1440</h1> <p style="margin: 0;">Stahl</p>	

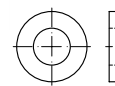

Scheiben für Bolzen, Produktklasse A (m)

Maße → **TI-85** Normumstellung → **TI-10**

Rostfrei → **S. 516**

DIN 1440 → wird ersetzt durch ISO 8738



Innen Ø min. = Bolzen Ø x Außen Ø x Dicke

3	x	6	x	0,8	S	1000	2,80
4	x	8	x	0,8	S	1000	2,80
4	x	8	x	0,8	K	250	3,90

Abmessungen	VE	Stück	€/100/Obf.
5 x 10 x 0,8 S	1000	3,25	
5 x 10 x 0,8 K	250	4,40	
6 x 12 x 1,6 S	1000	4,80	
6 x 12 x 1,6 K	100	7,90	
7 x 14 x 1,6 S	1000	6,80	
7 x 14 x 1,6 K	100	9,70	
8 x 16 x 2 S	1000	9,10	
8 x 16 x 2 K	100	12,10	
10 x 20 x 2,5 S	1000	11,70	
10 x 20 x 2,5 K	100	16,30	
12 x 25 x 3 S	500	17,20	
12 x 25 x 3 K	100	22,20	
13 x 25 x 3 S	500	17,20	
13 x 25 x 3 K	100	25,50	
14 x 28 x 3 S	500	21,00	
14 x 28 x 3 K	100	26,00	
16 x 28 x 3 S	500	21,00	
16 x 28 x 3 K	100	26,00	
18 x 30 x 4 S	200	34,50	
18 x 30 x 4 K	100	39,50	
20 x 32 x 4 S	200	41,50	
20 x 32 x 4 K	100	46,00	
22 x 34 x 4 S	200	47,50	
22 x 34 x 4 K	100	53,00	
23 x 36 x 4 S	200	49,50	
23 x 36 x 4 K	100	54,00	
25 x 40 x 4 S	200	67,00	
25 x 40 x 4 K	100	73,00	
26 x 40 x 5 S	100	95,00	
28 x 42 x 5 S	100	105,00	
30 x 45 x 5 S	100	125,00	
32 x 50 x 5 S	100	163,00	
33 x 50 x 5 S	100	152,00	
35 x 52 x 6 S	100	193,00	
36 x 52 x 6 S	100	193,00	
40 x 58 x 6 S	50	223,00	
45 x 62 x 7 S	50	270,00	
50 x 68 x 8 S	50	415,00	
55 x 75 x 9 S	10	880,00	
60 x 80 x 9 S	10	1010,00	
65 x 90 x 9 S	1	2200,00	
70 x 95 x 10 S	1	2800,00	
75 x 100 x 10 S	1	3350,00	
80 x 110 x 12 S	1	5100,00	
90 x 115 x 12 S	1	5100,00	
100 x 125 x 14 S	1	6600,00	

DIN 01440.010
1440 Stahl galvanisch verzinkt

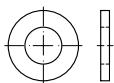

Scheiben für Bolzen, Produktklasse A (m)

Maße → TI-85 Normumstellung → TI-10
Korrosionsschutz → TI-228

Rostfrei → S. 516

DIN 1440 → wird ersetzt durch ISO 8738



Innen Ø min. = Bolzen Ø x Außen Ø x Dicke

3 x 6 x 0,8 S	1000	2,85 gal Zn
3 x 6 x 0,8 K	250	3,95 gal Zn
4 x 8 x 0,8 S	1000	2,85 gal Zn
4 x 8 x 0,8 K	250	3,95 gal Zn
5 x 10 x 0,8 S	1000	3,35 gal Zn

Abmessungen	VE	Stück	€/100/Obf.
5 x 10 x 0,8 K	250	4,55 gal Zn	
6 x 12 x 1,6 S	1000	5,30 gal Zn	
6 x 12 x 1,6 K	100	8,40 gal Zn	
7 x 14 x 1,6 S	1000	7,40 gal Zn	
7 x 14 x 1,6 K	100	10,50 gal Zn	
8 x 16 x 2 S	1000	9,90 gal Zn	
8 x 16 x 2 K	100	12,90 gal Zn	
10 x 20 x 2,5 S	1000	13,50 gal Zn	
10 x 20 x 2,5 K	100	18,20 gal Zn	
12 x 25 x 3 S	500	21,00 gal Zn	
12 x 25 x 3 K	100	26,00 gal Zn	
13 x 25 x 3 S	500	20,60 gal Zn	
13 x 25 x 3 K	100	26,00 gal Zn	
14 x 28 x 3 S	500	25,50 gal Zn	
14 x 28 x 3 K	100	30,50 gal Zn	
16 x 28 x 3 S	500	25,00 gal Zn	
16 x 28 x 3 K	100	30,00 gal Zn	
18 x 30 x 4 S	200	41,00 gal Zn	
18 x 30 x 4 K	100	46,00 gal Zn	
20 x 32 x 4 S	200	47,50 gal Zn	
20 x 32 x 4 K	100	53,00 gal Zn	
22 x 34 x 4 S	200	54,00 gal Zn	
22 x 34 x 4 K	100	59,00 gal Zn	
23 x 36 x 4 S	200	57,00 gal Zn	
25 x 40 x 4 S	200	77,00 gal Zn	
25 x 40 x 4 K	100	83,00 gal Zn	
26 x 40 x 5 S	100	107,00 gal Zn	
28 x 42 x 5 S	100	115,00 gal Zn	
30 x 45 x 5 S	100	141,00 gal Zn	
32 x 50 x 5 S	100	164,00 gal Zn	
33 x 50 x 5 S	100	164,00 gal Zn	
35 x 52 x 6 S	100	207,00 gal Zn	
36 x 52 x 6 S	100	206,00 gal Zn	
40 x 58 x 6 S	50	242,00 gal Zn	
45 x 62 x 7 S	50	295,00 gal Zn	
50 x 68 x 8 S	50	440,00 gal Zn	
55 x 75 x 9 S	10	920,00 gal Zn	
60 x 80 x 9 S	10	1050,00 gal Zn	
65 x 90 x 9 S	1	2240,00 gal Zn	
70 x 95 x 10 S	1	2850,00 gal Zn	
80 x 110 x 12 S	1	5200,00 gal Zn	
100 x 125 x 14 S	1	6700,00 gal Zn	

DIN 01441.000
1441 Stahl



Scheiben für Bolzen, Produktklasse C (g)

Maße → TI-85



Innen Ø x Außen Ø x Dicke

5,5 x 10 x 0,8 K	250	6,00
7 x 12 x 1,6 K	250	7,20
8 x 14 x 1,6 S	1000	4,80
8 x 14 x 1,6 K	250	7,40
9 x 16 x 2 S	1000	5,30
9 x 16 x 2 K	250	8,60
11 x 20 x 2,5 S	500	8,40
11 x 20 x 2,5 K	250	12,60
13 x 25 x 3 S	500	12,60
13 x 25 x 3 K	100	23,30
15 x 28 x 3 S	500	15,30
15 x 28 x 3 K	100	26,00
17 x 28 x 3 S	500	16,60

Abmessungen	VE	Stück	€/100/Obf.
17 x 28 x 3 K	100	27,50	
19 x 30 x 4 S	200	22,60	
19 x 30 x 4 K	100	34,00	
21 x 32 x 4 S	200	27,00	
21 x 32 x 4 K	100	38,50	
23 x 34 x 4 S	200	31,00	
23 x 34 x 4 K	100	42,50	
24 x 36 x 4 S	200	34,00	
25 x 38 x 4 S	200	42,00	
25 x 38 x 4 K	100	56,00	
26 x 40 x 4 S	200	48,00	
26 x 40 x 4 K	100	62,00	
27 x 40 x 5 S	100	59,00	
28 x 40 x 5 S	100	61,00	
29 x 42 x 5 S	100	66,00	
31 x 45 x 5 S	100	76,00	
34 x 50 x 5 S	100	97,00	
37 x 52 x 6 S	100	117,00	
41 x 58 x 6 S	50	155,00	
46 x 62 x 7 S	50	199,00	
51 x 68 x 8 S	50	285,00	
56 x 75 x 9 S	10	630,00	
62 x 80 x 9 S	10	830,00	
72 x 95 x 10 S	10	1350,00	
78 x 100 x 10 S	10	1970,00	
82 x 110 x 12 S	1	2220,00	
86 x 110 x 12 S	1	2300,00	
92 x 115 x 12 S	1	2400,00	
102 x 125 x 14 S	1	3350,00	

DIN 01441.010
1441 Stahl galvanisch verzinkt

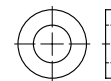

Scheiben für Bolzen, Produktklasse C (g)

Maße → TI-85

Korrosionsschutz → TI-228

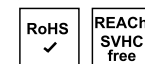

Innen Ø x Außen Ø x Dicke

5,5 x 10 x 0,8 S	1000	2,75 gal Zn
5,5 x 10 x 0,8 K	250	6,20 gal Zn
7 x 12 x 1,6 S	1000	3,45 gal Zn
7 x 12 x 1,6 K	250	6,80 gal Zn
8 x 14 x 1,6 S	1000	4,60 gal Zn
8 x 14 x 1,6 K	250	7,90 gal Zn
9 x 16 x 2 S	1000	6,30 gal Zn
9 x 16 x 2 K	250	9,60 gal Zn
11 x 20 x 2,5 S	500	10,30 gal Zn
11 x 20 x 2,5 K	250	14,60 gal Zn
13 x 25 x 3 S	500	16,40 gal Zn
13 x 25 x 3 K	100	27,00 gal Zn
14 x 25 x 3 K	100	27,50 gal Zn
15 x 28 x 3 S	500	19,80 gal Zn
15 x 28 x 3 K	100	30,50 gal Zn
17 x 28 x 3 S	500	20,70 gal Zn
17 x 28 x 3 K	100	31,50 gal Zn
19 x 30 x 4 S	200	29,00 gal Zn
19 x 30 x 4 K	100	41,00 gal Zn
21 x 32 x 4 S	200	33,50 gal Zn
21 x 32 x 4 K	100	45,50 gal Zn
23 x 34 x 4 S	200	38,00 gal Zn
23 x 34 x 4 K	100	49,50 gal Zn
24 x 36 x 4 S	200	42,50 gal Zn
25 x 38 x 4 S	200	51,00 gal Zn
25 x 38 x 4 K	100	65,00 gal Zn

Abmessungen	VE	Stück	€/100/Obf.
26 x 40 x 4 S 200	59,00	gal Zn	
26 x 40 x 4 K 100	73,00	gal Zn	
28 x 40 x 5 S 100	73,00	gal Zn	
29 x 42 x 5 S 100	79,00	gal Zn	
31 x 45 x 5 S 100	91,00	gal Zn	
34 x 50 x 5 S 100	117,00	gal Zn	
37 x 52 x 6 S 100	141,00	gal Zn	
41 x 58 x 6 S 50	183,00	gal Zn	
46 x 62 x 7 S 50	230,00	gal Zn	
51 x 68 x 8 S 50	330,00	gal Zn	
56 x 75 x 9 S 10	690,00	gal Zn	
62 x 80 x 9 S 10	890,00	gal Zn	
68 x 90 x 9 S 10	1200,00	gal Zn	
72 x 95 x 10 S 10	1460,00	gal Zn	
78 x 100 x 10 S 10	1580,00	gal Zn	
82 x 110 x 12 S 1	2400,00	gal Zn	
92 x 115 x 12 S 1	2550,00	gal Zn	
102 x 125 x 14 S 1	3600,00	gal Zn	

DIN	01444.014
1444	Stahl Form B galvanisch verzinkt

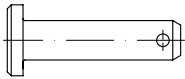

Bolzen mit Kopf, B = mit Splintloch mit Toleranzfeld h11 für Bolzen Ø

Maße → **TI-122** Normumstellung → **TI-10**
 Korrosionsschutz → **TI-228** REACH → **TI-262**
 DIN 1444 → wird ersetzt durch ISO 2341 (austauschbar)



Bolzen Ø x Länge ges. x Länge bis Mitte Splintloch

B 8 x 20/16,5 S 100	1320,00	gal Zn
B 8 x 24/20,5 S 100	1340,00	gal Zn
B 8 x 25/21,5 S 100	1340,00	gal Zn
B 8 x 30/26,5 S 100	1350,00	gal Zn
B 8 x 35/31,5 S 100	1360,00	gal Zn
B 8 x 50/46,5 S 100	1380,00	gal Zn
B 10 x 25/20,5 S 10	1920,00	gal Zn
B 10 x 30/25,5 S 10	1930,00	gal Zn
B 10 x 35/30,5 S 10	1950,00	gal Zn
B 10 x 40/35,5 S 10	1970,00	gal Zn
B 10 x 45/40,5 S 10	2000,00	gal Zn
B 10 x 50/45,5 S 10	2030,00	gal Zn
B 10 x 60/55,5 S 10	2040,00	gal Zn
B 10 x 70/65,5 S 10	2060,00	gal Zn
B 12 x 30/24,5 S 10	1920,00	gal Zn
B 12 x 35/29,5 S 10	1930,00	gal Zn
B 12 x 40/34,5 S 10	1950,00	gal Zn
B 12 x 45/39,5 S 10	1970,00	gal Zn
B 12 x 50/44,5 S 10	2000,00	gal Zn
B 12 x 60/54,5 S 10	2040,00	gal Zn
B 16 x 40/34 S 1	2100,00	gal Zn
B 16 x 45/39 S 1	2130,00	gal Zn
B 16 x 50/44 S 1	2160,00	gal Zn
B 16 x 55/49 S 1	2200,00	gal Zn
B 16 x 60/54 S 1	2230,00	gal Zn
B 16 x 65/59 S 1	2260,00	gal Zn
B 18 x 65/58 S 1	2290,00	gal Zn
B 20 x 40/32 S 1	2240,00	gal Zn
B 20 x 50/42 S 1	2300,00	gal Zn
B 20 x 55/47 S 1	2360,00	gal Zn
B 20 x 60/52 S 1	2450,00	gal Zn
B 20 x 65/57 S 1	2550,00	gal Zn

Abmessungen	VE	Stück	€/100/Obf.
DIN 01471.000			
1471			Stahl

Kegelkerbstifte

Maße → **TI-119** REACH → **TI-262**
 Normumstellung → **TI-10**
 Rostfrei → **S. 517**
 DIN 1471 → wird ersetzt durch ISO 8744

1,5 x 6 S 250	8,90
1,5 x 8 S 250	8,90
1,5 x 16 S 250	9,60
2 x 6 S 250	9,60
2 x 8 S 250	9,60
2 x 10 S 250	9,60
2 x 12 S 250	9,90
2 x 16 S 250	9,90
2 x 20 S 250	11,10
2 x 24 S 250	11,90
2 x 30 S 250	11,90
2,5 x 6 S 250	11,10
2,5 x 12 S 250	11,20
2,5 x 16 S 250	11,20
2,5 x 20 S 250	11,40
2,5 x 30 S 250	11,80
3 x 6 S 250	11,20
3 x 8 S 250	11,20
3 x 10 S 250	11,20
3 x 12 S 250	11,50
3 x 14 S 250	11,50
3 x 16 S 250	11,50
3 x 18 S 250	11,50
3 x 20 S 250	12,30
3 x 24 S 250	12,30
3 x 26 S 250	12,60
3 x 30 S 100	14,40
3 x 40 S 100	15,30
4 x 6 S 100	14,20
4 x 8 S 100	14,20
4 x 10 S 100	14,20
4 x 12 S 100	14,30
4 x 14 S 100	14,30
4 x 16 S 100	14,30
4 x 18 S 100	14,30
4 x 20 S 100	14,40
4 x 22 S 100	14,40
4 x 24 S 100	14,80
4 x 26 S 100	15,20
4 x 28 S 100	15,20
4 x 30 S 100	15,20
4 x 32 S 100	15,30
4 x 36 S 100	16,10
4 x 40 S 100	16,50
4 x 50 S 100	19,00
4 x 60 S 100	72,00
5 x 8 S 100	16,10
5 x 10 S 100	16,10
5 x 12 S 100	16,10
5 x 14 S 100	16,10
5 x 16 S 100	16,10
5 x 18 S 100	17,10
5 x 20 S 100	17,10
5 x 24 S 100	17,60

Abmessungen	VE	Stück	€/100/Obf.
5 x 26 S 100	18,30		
5 x 30 S 100	18,70		
5 x 32 S 100	19,20		
5 x 36 S 100	19,80		
5 x 40 S 100	20,70		
5 x 45 S 100	22,10		
5 x 50 S 100	23,00		
5 x 60 S 100	44,50		
6 x 10 S 100	21,20		
6 x 12 S 100	21,20		
6 x 16 S 100	21,50		
6 x 20 S 100	21,60		
6 x 22 S 100	22,00		
6 x 24 S 100	22,10		
6 x 26 S 100	22,70		
6 x 28 S 100	22,70		
6 x 30 S 100	23,00		
6 x 32 S 100	23,60		
6 x 36 S 100	26,00		
6 x 40 S 100	26,50		
6 x 45 S 100	29,00		
6 x 50 S 100	30,00		
6 x 55 S 100	31,50		
6 x 60 S 100	34,00		
6 x 70 S 100	92,00		
6 x 80 S 100	96,00		
8 x 12 S 100	31,50		
8 x 16 S 100	32,50		
8 x 20 S 100	32,50		
8 x 24 S 100	33,50		
8 x 26 S 100	33,50		
8 x 28 S 100	33,50		
8 x 30 S 100	34,50		
8 x 32 S 100	36,00		
8 x 36 S 100	38,50		
8 x 40 S 100	39,50		
8 x 45 S 100	44,00		
8 x 50 S 100	47,00		
8 x 55 S 100	49,50		
8 x 60 S 100	53,00		
8 x 70 S 100	60,00		
8 x 80 S 100	120,00		
8 x 100 S 25	160,00		
10 x 20 S 25	216,00		
10 x 30 S 25	229,00		
10 x 32 S 25	230,00		
10 x 36 S 25	235,00		
10 x 40 S 25	239,00		
10 x 45 S 25	245,00		
10 x 50 S 25	250,00		
10 x 60 S 25	265,00		
10 x 70 S 25	275,00		
10 x 80 S 25	285,00		
10 x 90 S 25	300,00		
10 x 100 S 25	300,00		
12 x 26 S 25	249,00		
12 x 60 S 25	300,00		
12 x 70 S 25	315,00		
12 x 90 S 25	345,00		
12 x 100 S 25	365,00		

Abmessungen VE Stück €/100/Obf.

DIN 01472.000

1472

Stahl

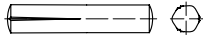

Passkerbstifte

Maße → **TI-118** REACH → **TI-262**

Normumstellung → **TI-10**

Rostfrei → **S. 517**

DIN 1472 → wird ersetzt durch ISO 8745



1,5	x	6	S	250	8,90
1,5	x	8	S	250	8,90
1,5	x	10	S	250	8,90
1,5	x	12	S	250	9,10
1,5	x	16	S	250	9,10
2	x	6	S	250	9,60
2	x	8	S	250	9,60
2	x	10	S	250	9,60
2	x	12	S	250	9,90
2	x	14	S	250	9,90
2	x	16	S	250	9,90
2	x	20	S	250	11,10
2	x	30	S	250	11,90
2,5	x	6	S	250	11,10
2,5	x	8	S	250	11,10
2,5	x	10	S	250	11,10
2,5	x	12	S	250	11,20
2,5	x	16	S	250	11,20
2,5	x	18	S	250	11,20
2,5	x	20	S	250	11,40
3	x	6	S	250	11,20
3	x	8	S	250	11,20
3	x	10	S	250	11,20
3	x	12	S	250	11,50
3	x	14	S	250	11,50
3	x	16	S	250	11,50
3	x	18	S	250	11,50
3	x	20	S	250	12,30
3	x	22	S	250	12,30
3	x	24	S	250	12,30
3	x	26	S	250	12,60
3	x	28	S	100	14,40
3	x	30	S	100	14,40
3	x	32	S	100	14,80
3	x	40	S	100	15,30
4	x	6	S	100	14,20
4	x	8	S	100	14,20
4	x	10	S	100	14,20
4	x	12	S	100	14,30
4	x	14	S	100	14,30
4	x	16	S	100	14,30
4	x	18	S	100	14,30
4	x	20	S	100	14,40
4	x	22	S	100	14,40
4	x	24	S	100	14,80
4	x	26	S	100	15,20
4	x	28	S	100	15,20
4	x	30	S	100	15,20
4	x	32	S	100	15,30
4	x	36	S	100	16,10
4	x	40	S	100	16,50
4	x	50	S	100	19,00
4	x	60	S	100	36,00
5	x	8	S	100	16,10

Abmessungen VE Stück €/100/Obf.

5 x 10 S 100 16,10

5	x	10	S	100	16,10
5	x	12	S	100	16,10
5	x	14	S	100	16,10
5	x	16	S	100	16,10
5	x	18	S	100	17,10
5	x	20	S	100	17,10
5	x	22	S	100	17,20
5	x	24	S	100	17,60
5	x	26	S	100	18,30
5	x	28	S	100	18,30
5	x	30	S	100	18,70
5	x	32	S	100	19,20
5	x	36	S	100	19,80
5	x	40	S	100	20,70
5	x	50	S	100	23,00
5	x	60	S	100	44,50
6	x	10	S	100	21,20
6	x	12	S	100	21,20
6	x	14	S	100	21,20
6	x	16	S	100	21,50
6	x	18	S	100	21,60
6	x	20	S	100	21,60
6	x	22	S	100	22,00
6	x	24	S	100	22,10
6	x	26	S	100	22,70
6	x	28	S	100	22,70
6	x	30	S	100	23,00
6	x	32	S	100	23,60
6	x	36	S	100	26,00
6	x	40	S	100	26,50
6	x	45	S	100	29,00
6	x	50	S	100	30,00
6	x	60	S	100	34,00
6	x	80	S	100	96,00
8	x	12	S	100	31,50
8	x	14	S	100	31,50
8	x	16	S	100	32,50
8	x	18	S	100	32,50
8	x	20	S	100	32,50
8	x	22	S	100	33,50
8	x	24	S	100	33,50
8	x	26	S	100	33,50
8	x	28	S	100	33,50
8	x	30	S	100	34,50
8	x	32	S	100	36,00
8	x	36	S	100	38,50
8	x	40	S	100	39,50
8	x	45	S	100	44,00
8	x	50	S	100	47,00
8	x	55	S	100	49,50
8	x	60	S	100	53,00
8	x	70	S	100	60,00
8	x	80	S	100	92,00
8	x	100	S	25	160,00
10	x	16	S	25	213,00
10	x	20	S	25	216,00
10	x	24	S	25	222,00
10	x	26	S	25	224,00
10	x	30	S	25	229,00
10	x	32	S	25	230,00
10	x	36	S	25	235,00
10	x	40	S	25	239,00
10	x	45	S	25	245,00
10	x	50	S	25	250,00
10	x	55	S	25	255,00
10	x	60	S	25	265,00
10	x	70	S	25	275,00
10	x	80	S	25	285,00
10	x	90	S	25	300,00
12	x	20	S	25	239,00
12	x	30	S	25	255,00
12	x	32	S	25	260,00
12	x	36	S	25	265,00
12	x	40	S	25	270,00
12	x	45	S	25	275,00

Abmessungen VE Stück €/100/Obf.

12 x 50 S 25 285,00

12	x	50	S	25	285,00
12	x	55	S	25	295,00
12	x	60	S	25	300,00
12	x	70	S	25	315,00
12	x	80	S	25	335,00

DIN 01473.000

1473

Stahl



Zylinderkerbstifte

Maße → **TI-119** REACH → **TI-262**

Normumstellung → **TI-10**

Rostfrei → **S. 517**

DIN 1473 → wird ersetzt durch ISO 8740



1,5	x	6	S	250	8,90
1,5	x	8	S	250	8,90
1,5	x	10	S	250	8,90
1,5	x	12	S	250	9,10
1,5	x	16	S	250	9,10
1,5	x	20	S	250	9,10
2	x	4	S	250	9,60
2	x	6	S	250	9,60
2	x	8	S	250	9,60
2	x	10	S	250	9,60
2	x	12	S	250	9,90
2	x	14	S	250	9,90
2	x	16	S	250	9,90
2	x	18	S	250	9,90
2	x	20	S	250	11,10
2	x	24	S	250	11,90
2	x	30	S	250	11,90
2,5	x	6	S	250	11,10
2,5	x	8	S	250	11,10
2,5	x	10	S	250	11,10
2,5	x	12	S	250	11,20
2,5	x	14	S	250	11,20
2,5	x	16	S	250	11,20
2,5	x	20	S	250	11,40
2,5	x	24	S	250	11,40
2,5	x	30	S	250	11,80
3	x	6	S	250	11,20
3	x	8	S	250	11,20
3	x	10	S	250	11,20
3	x	12	S	250	11,50
3	x	14	S	250	11,50
3	x	16	S	250	11,50
3	x	20	S	250	12,30
3	x	22	S	250	12,30
3	x	24	S	250	12,30
3	x	26	S	250	12,60
3	x	28	S	100	14,40
3	x	30	S	100	14,40
3	x	32	S	100	14,80
3	x	40	S	100	15,30
4	x	6	S	100	14,20
4	x	8	S	100	14,20
4	x	10	S	100	14,20
4	x	12	S	100	14,30
4	x	14	S	100	14,30
4	x	16	S	100	14,30
4	x	18	S	100	14,30
4	x	20	S	100	14,40
4	x	22	S	100	14,40
4	x	24	S	100	14,80
4	x	26	S	100	15,20
4	x	28	S	100	15,20
4	x	30	S	100	15,20
4	x	32	S	100	15,30
4	x	36	S	100	16,10
4	x	40	S	100	16,50
4	x	50	S	100	19,00
4	x	60	S	100	36,00
4	x	16	S	100	14,30
4	x	16	S	100	14,30

Abmessungen	VE	Stück	€/100/Obf.	Abmessungen	VE	Stück	€/100/Obf.	Abmessungen	VE	Stück	€/100/Obf.
4 x 18	S	100	14,30	10 x 24	S	25	222,00	4 x 24	S	100	14,80
4 x 20	S	100	14,40	10 x 26	S	25	224,00	4 x 30	S	100	15,20
4 x 22	S	100	14,40	10 x 30	S	25	229,00	4 x 40	S	100	16,50
4 x 24	S	100	14,80	10 x 32	S	25	230,00	5 x 10	S	100	16,10
4 x 26	S	100	15,20	10 x 36	S	25	235,00	5 x 12	S	100	16,10
4 x 28	S	100	15,20	10 x 40	S	25	239,00	5 x 14	S	100	16,10
4 x 30	S	100	15,20	10 x 45	S	25	245,00	5 x 16	S	100	16,10
4 x 32	S	100	15,30	10 x 50	S	25	250,00	5 x 20	S	100	17,10
4 x 36	S	100	16,10	10 x 60	S	25	265,00	5 x 24	S	100	17,60
4 x 40	S	100	16,50	10 x 65	S	25	265,00	5 x 28	S	100	18,30
4 x 45	S	100	18,30	10 x 70	S	25	275,00	5 x 36	S	100	19,80
4 x 50	S	100	19,00	10 x 80	S	25	285,00	5 x 40	S	100	20,70
4 x 60	S	100	36,00	10 x 90	S	25	300,00	6 x 12	S	100	21,20
5 x 8	S	100	16,10	10 x 100	S	25	300,00	6 x 14	S	100	21,20
5 x 10	S	100	16,10	10 x 120	S	25	370,00	6 x 16	S	100	21,50
5 x 12	S	100	16,10	12 x 20	S	25	239,00	6 x 18	S	100	21,60
5 x 14	S	100	16,10	12 x 24	S	25	245,00	6 x 20	S	100	21,60
5 x 16	S	100	16,10	12 x 26	S	25	249,00	6 x 22	S	100	22,00
5 x 18	S	100	17,10	12 x 28	S	25	255,00	6 x 24	S	100	22,10
5 x 20	S	100	17,10	12 x 30	S	25	255,00	6 x 26	S	100	22,70
5 x 22	S	100	17,20	12 x 32	S	25	260,00	6 x 28	S	100	22,70
5 x 24	S	100	17,60	12 x 36	S	25	265,00	6 x 30	S	100	23,00
5 x 26	S	100	18,30	12 x 40	S	25	270,00	6 x 32	S	100	23,60
5 x 28	S	100	18,30	12 x 45	S	25	275,00	6 x 40	S	100	26,50
5 x 30	S	100	18,70	12 x 50	S	25	285,00	6 x 60	S	100	34,00
5 x 32	S	100	19,20	12 x 55	S	25	295,00	6 x 70	S	100	92,00
5 x 36	S	100	19,80	12 x 60	S	25	300,00	8 x 16	S	100	32,50
5 x 40	S	100	20,70	12 x 70	S	25	315,00	8 x 20	S	100	32,50
5 x 45	S	100	22,10	12 x 80	S	25	335,00	8 x 24	S	100	33,50
5 x 50	S	100	23,00	12 x 90	S	25	345,00	8 x 26	S	100	33,50
5 x 55	S	100	42,50	12 x 100	S	25	365,00	8 x 30	S	100	34,50
5 x 60	S	100	44,50	12 x 120	S	25	430,00	8 x 32	S	100	36,00
6 x 10	S	100	21,20					8 x 40	S	100	39,50
6 x 12	S	100	21,20					8 x 45	S	100	44,00
6 x 14	S	100	21,20					8 x 50	S	100	47,00
6 x 16	S	100	21,50					10 x 20	S	25	216,00
6 x 18	S	100	21,60					10 x 24	S	25	222,00
6 x 20	S	100	21,60					10 x 25	S	25	224,00
6 x 22	S	100	22,00					10 x 30	S	25	229,00
6 x 24	S	100	22,10					10 x 36	S	25	235,00
6 x 26	S	100	22,70					10 x 40	S	25	239,00
6 x 28	S	100	22,70					10 x 45	S	25	245,00
6 x 30	S	100	23,00					10 x 60	S	25	265,00
6 x 32	S	100	23,60					12 x 32	S	25	260,00
6 x 36	S	100	26,00					12 x 40	S	25	270,00
6 x 40	S	100	26,50					12 x 50	S	25	285,00
6 x 45	S	100	29,00					12 x 55	S	25	295,00
6 x 50	S	100	30,00								
6 x 55	S	100	31,50								
6 x 60	S	100	34,00								
6 x 65	S	100	89,00								
6 x 70	S	100	92,00								
6 x 80	S	100	96,00								
8 x 12	S	100	31,50								
8 x 14	S	100	31,50								
8 x 16	S	100	32,50								
8 x 20	S	100	32,50								
8 x 22	S	100	33,50								
8 x 24	S	100	33,50								
8 x 26	S	100	33,50								
8 x 28	S	100	33,50								
8 x 30	S	100	34,50								
8 x 32	S	100	36,00								
8 x 36	S	100	38,50								
8 x 40	S	100	39,50								
8 x 45	S	100	44,00								
8 x 50	S	100	47,00								
8 x 55	S	100	49,50								
8 x 60	S	100	53,00								
8 x 70	S	100	60,00								
8 x 80	S	100	92,00								
8 x 90	S	25	146,00								
8 x 100	S	25	160,00								
10 x 16	S	25	213,00								
10 x 20	S	25	216,00								

DIN 01474.000

1474 Stahl

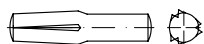

Steckerbstifte

Maße → TI-118 REACH → TI-262

Normumstellung → TI-10

DIN 1474 → wird ersetzt durch ISO 8741



1,5 x 6	S	250	8,90
2 x 6	S	250	9,60
2 x 8	S	250	9,60
2 x 10	S	250	9,60
2 x 12	S	250	9,90
2 x 16	S	250	9,90
2 x 20	S	250	11,10
2,5 x 10	S	250	11,10
2,5 x 12	S	250	11,20
2,5 x 16	S	250	11,20
3 x 8	S	250	11,20
3 x 10	S	250	11,20
3 x 12	S	250	11,50
3 x 16	S	250	11,50
3 x 20	S	250	12,30
3 x 30	S	100	14,40
4 x 8	S	100	14,20
4 x 10	S	100	14,20
4 x 12	S	100	14,30
4 x 16	S	100	14,30
4 x 18	S	100	14,30
4 x 20	S	100	14,40

DIN 01475.000

1475 Stahl



Knebelkerbstifte

Maße → TI-119 REACH → TI-262

Normumstellung → TI-10

DIN 1475 → wird ersetzt durch ISO 8742



1,5 x 8	S	250	8,90
2 x 10	S	250	9,60
2 x 12	S	250	9,90
2 x 24	S	250	11,90
2,5 x 12	S	250	11,20
2,5 x 16	S	250	11,20
3 x 6	S	250	11,20

Abmessungen	VE	Stück	€/100/Obf.
3 x 10	S	250	11,20
3 x 12	S	250	11,50
3 x 14	S	250	11,50
3 x 16	S	250	11,50
3 x 20	S	250	12,30
3 x 28	S	100	14,40
3 x 30	S	100	14,40
3 x 40	S	100	15,30
4 x 10	S	100	14,20
4 x 12	S	100	14,30
4 x 14	S	100	14,30
4 x 16	S	100	14,30
4 x 18	S	100	14,30
4 x 20	S	100	14,40
4 x 22	S	100	14,40
4 x 24	S	100	14,80
4 x 26	S	100	15,20
4 x 28	S	100	15,20
4 x 30	S	100	15,20
4 x 32	S	100	15,30
4 x 36	S	100	16,10
4 x 40	S	100	16,50
4 x 50	S	100	19,00
4 x 60	S	100	36,00
5 x 12	S	100	16,10
5 x 20	S	100	17,10
5 x 22	S	100	17,20
5 x 24	S	100	17,60
5 x 30	S	100	18,70
5 x 36	S	100	19,80
5 x 40	S	100	20,70
5 x 50	S	100	23,00
5 x 60	S	100	44,50
6 x 10	S	100	21,20
6 x 20	S	100	21,60
6 x 24	S	100	22,10
6 x 26	S	100	22,70
6 x 28	S	100	22,70
6 x 30	S	100	23,00
6 x 32	S	100	23,60
6 x 36	S	100	26,00
6 x 40	S	100	26,50
6 x 50	S	100	30,00
6 x 60	S	100	34,00
6 x 70	S	100	92,00
8 x 16	S	100	32,50
8 x 24	S	100	33,50
8 x 30	S	100	34,50
8 x 32	S	100	36,00
8 x 36	S	100	38,50
8 x 40	S	100	39,50
8 x 50	S	100	47,00
8 x 55	S	100	49,50
8 x 60	S	100	53,00
8 x 80	S	100	92,00
8 x 100	S	25	160,00
10 x 36	S	25	235,00
10 x 45	S	25	245,00
10 x 50	S	25	250,00
10 x 55	S	25	255,00
10 x 60	S	25	265,00
10 x 70	S	25	275,00
10 x 80	S	25	285,00
12 x 40	S	25	270,00
12 x 45	S	25	275,00
12 x 50	S	25	285,00
12 x 60	S	25	300,00
12 x 100	S	25	365,00

Abmessungen	VE	Stück	€/100/Obf.
DIN	01476.000		

1476 Stahl

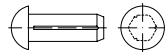

Halbrundkerbnägel

Maße → **TI-120** REACH → **TI-262**
 Normumstellung → **TI-10**
 Rostfrei → **S. 518**
 Messing, Aluminium → **S. 632**

DIN 1476 → wird ersetzt durch ISO 8746 (austauschbar)



1,4 x 3	K	500	4,25
1,4 x 4	K	500	4,25
1,4 x 5	K	500	6,50
1,4 x 6	K	500	4,75
1,6 x 3	K	500	4,40
1,6 x 4	K	500	4,40
1,6 x 6	K	500	4,55
2 x 3	S	5000	3,40
2 x 3	K	500	4,40
2 x 4	S	5000	3,40
2 x 4	K	500	4,40
2 x 5	S	5000	3,40
2 x 5	K	500	4,40
2 x 6	S	5000	4,55
2 x 6	K	500	4,55
2 x 8	S	5000	3,45
2 x 8	K	500	4,55
2 x 10	K	500	4,70
2,3 x 4	K	500	4,55
2,3 x 5	K	500	4,55
2,3 x 6	K	500	4,55
2,3 x 8	K	500	4,70
2,3 x 10	K	500	4,85
2,5 x 3	K	500	4,70
2,5 x 4	K	500	4,70
2,5 x 5	K	500	4,70
2,5 x 6	S	5000	3,65
2,5 x 6	K	500	4,70
2,5 x 7	K	500	4,85
2,5 x 8	K	500	4,85
2,5 x 10	K	500	5,00
3 x 4	S	5000	3,95
3 x 4	K	500	5,00
3 x 5	S	5000	3,95
3 x 5	K	500	5,00
3 x 6	S	5000	3,95
3 x 6	K	500	5,00
3 x 7	K	500	5,20
3 x 8	S	5000	4,20
3 x 8	K	500	5,20
3 x 10	S	5000	4,20
3 x 10	K	500	5,20
3 x 12	S	2000	4,60
3 x 12	K	500	5,50
3 x 15	S	2000	4,60
3 x 15	K	500	5,50
3 x 18	K	500	6,60
4 x 6	S	2000	5,70
4 x 6	K	500	6,60
4 x 8	S	2000	5,70
4 x 8	K	500	6,60
4 x 10	S	2000	5,80

Abmessungen	VE	Stück	€/100/Obf.
4 x 10	K	500	6,70
4 x 12	K	500	7,20
4 x 15	S	2000	6,60
4 x 15	K	500	7,60
4 x 20	K	500	15,80
5 x 8	K	250	9,20
5 x 10	S	1000	8,30
5 x 10	K	250	9,60
5 x 12	S	1000	9,10
5 x 12	K	250	10,50
5 x 15	S	1000	9,70
5 x 15	K	250	10,80
5 x 18	K	250	11,10
5 x 20	K	250	11,70
5 x 25	K	250	12,30
6 x 8	K	250	11,80
6 x 10	K	250	12,10
6 x 12	K	250	13,20
6 x 15	K	250	14,40
6 x 20	K	250	15,70
6 x 25	K	250	17,00
6 x 30	K	250	19,40

DIN	01477.000	
-----	-----------	--

1477 Stahl

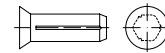

Senkkerbnägel

Maße → **TI-120** REACH → **TI-262**
 Normumstellung → **TI-10**

DIN 1477 → wird ersetzt durch ISO 8747 (austauschbar)



2 x 6	K	500	5,00
2 x 8	K	500	5,00
2 x 10	K	500	5,30
3 x 6	K	500	5,60
3 x 8	K	500	5,70
3 x 10	K	500	5,70
3 x 12	K	500	6,20
3 x 18	K	500	7,30
4 x 10	K	500	7,60
4 x 12	K	500	7,80
4 x 15	K	500	8,50
5 x 10	K	250	10,70
5 x 15	K	250	12,10
5 x 20	K	250	12,90
6 x 15	K	250	16,10
6 x 20	K	250	17,50

Abmessungen	VE Stück	€/100/Obf.
DIN	01478.010	
1478	Stahl	SP
	galvanisch verzinkt	

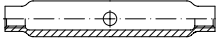

Spannschlossmuttern aus Stahlrohr, geschlossene Form

Maße → **TI-81**

Korrosionsschutz → **TI-228**

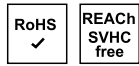

SP M 6	S	10	950,00 gal Zn
SP M 8	S	10	990,00 gal Zn
SP M 10	S	1	1260,00 gal Zn
SP M 12	S	1	1470,00 gal Zn
SP M 16	S	1	2130,00 gal Zn
SP M 20	S	1	3300,00 gal Zn
SP M 24	S	1	5100,00 gal Zn
SP M 30	S	1	5900,00 gal Zn
SP M 36	S	1	9400,00 gal Zn

DIN	01478.310
1478	Stahl
	galvanisch verzinkt
	SP

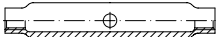

Spannschlossmuttern aus Stahlrohr, geschlossene Form

Stahl = L235

Maße → **TI-81**

Korrosionsschutz → **TI-228**

zulässige Tragfähigkeit → **TI-Maßseiten**

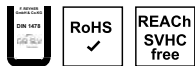

SP M 6	S	10	1280,00 gal Zn
SP M 8	S	10	1330,00 gal Zn
SP M 10	S	1	1700,00 gal Zn
SP M 12	S	1	1980,00 gal Zn
SP M 16	S	1	2900,00 gal Zn
SP M 20	S	1	4450,00 gal Zn
SP M 24	S	1	6800,00 gal Zn
SP M 30	S	1	7900,00 gal Zn
SP M 36	S	1	12600,00 gal Zn

Abmessungen	VE Stück	€/100/Obf.
DIN	01478.014	
1478	Stahl	SP-AE
	galvanisch verzinkt	

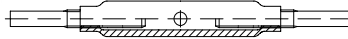

Spannschlösser aus Stahlrohr, geschlossene Form, AE = mit 2 Anschweißenden nach DIN 34828

Maße → **TI-81**

Korrosionsschutz → **TI-228**

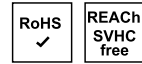

SP-AE M 8	S	1	1310,00 gal Zn
SP-AE M 10	S	1	1670,00 gal Zn
SP-AE M 12	S	1	2070,00 gal Zn
SP-AE M 16	S	1	3300,00 gal Zn
SP-AE M 20	S	1	5100,00 gal Zn
SP-AE M 24	S	1	7800,00 gal Zn
SP-AE M 30	S	1	10800,00 gal Zn
SP-AE M 36	S	1	17200,00 gal Zn

DIN	01479.010
1479	Stahl
	galvanisch verzinkt



Sechskant-Spannschlossmuttern

Verbindungs-muffen → Artikel 88087/88088

Maße → **TI-81**

REACH → **TI-262**

Korrosionsschutz → **TI-228**

ISO-Schlüsselweiten für M 10, M 12, M 14, M 22 auf Anfrage



M 6	S	25	270,00 gal Zn
M 8	S	25	395,00 gal Zn
M 10	S	10	570,00 gal Zn
M 12	S	10	740,00 gal Zn
M 16	S	1	1660,00 gal Zn
M 20	S	1	2850,00 gal Zn
M 24	S	1	4400,00 gal Zn
M 30	S	1	6900,00 gal Zn
M 36	S	1	21000,00 gal Zn

Abmessungen	VE Stück	€/100/Obf.
DIN	01479.310	
1479	Stahl	
	galvanisch verzinkt	

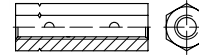

Sechskant-Spannschlossmuttern

Stahl = L235

Maße → **TI-81**

REACH → **TI-262**

Korrosionsschutz → **TI-228**

- ISO-Schlüsselweiten für M10, M12, M14 M22 auf Anfrage
- Zulässige Tragfähigkeit → **TI-Maßseiten**



M 6	S	25	365,00 gal Zn
M 8	S	25	540,00 gal Zn
M 10 SW 17	S	10	770,00 gal Zn
M 12 SW 19	S	10	1000,00 gal Zn
M 16	S	1	2240,00 gal Zn
M 20	S	1	3850,00 gal Zn
M 24	S	1	5900,00 gal Zn
M 30	S	1	9400,00 gal Zn

ISO	91479.013
1479	Stahl gehärtet
	galvanisch verzinkt
	Form C



Sechskant-Blehschrauben, C = mit Spitze

Maße → **TI-46**

Montage → **TI-251**

Korrosionsschutz → **TI-228**

Normumstellung → **TI-11**

Rostfrei → **S. 518**

Ausführung mit Bund = DIN 6928 auf Anfrage

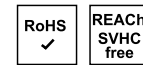

C 2,9 x 6,5	S	2000	5,40 gal Zn
C 2,9 x 9,5	S	2000	5,00 gal Zn
C 2,9 x 13	S	2000	5,30 gal Zn
C 2,9 x 16	S	2000	6,30 gal Zn
C 2,9 x 19	S	2000	6,50 gal Zn
C 3,5 x 6,5	S	1000	5,80 gal Zn
C 3,5 x 9,5	S	1000	3,35 gal Zn
C 3,5 x 13	S	1000	3,95 gal Zn
C 3,5 x 16	S	1000	4,20 gal Zn
C 3,5 x 19	S	1000	4,60 gal Zn
C 3,5 x 22	S	1000	4,95 gal Zn
C 3,5 x 25	S	1000	5,20 gal Zn
C 3,9 x 6,5	S	1000	6,50 gal Zn
C 3,9 x 9,5	S	1000	5,00 gal Zn
C 3,9 x 13	S	1000	5,30 gal Zn
C 3,9 x 16	S	1000	6,80 gal Zn
C 3,9 x 19	S	1000	4,95 gal Zn
C 3,9 x 22	S	500	5,70 gal Zn
C 3,9 x 25	S	500	6,20 gal Zn
C 3,9 x 32	S	500	9,10 gal Zn

Abmessungen	VE	Stück	€/100/Obf.
C 4,2 x 9,5	S	1000	5,40 gal Zn
C 4,2 x 13	S	1000	5,70 gal Zn
C 4,2 x 16	S	1000	6,90 gal Zn
C 4,2 x 19	S	500	7,20 gal Zn
C 4,2 x 22	S	500	7,70 gal Zn
C 4,2 x 25	S	500	8,90 gal Zn
C 4,2 x 32	S	500	9,10 gal Zn
C 4,2 x 38	S	500	10,60 gal Zn
C 4,2 x 45	S	500	15,50 gal Zn
C 4,2 x 50	S	500	20,40 gal Zn
C 4,8 x 9,5	S	500	7,20 gal Zn
C 4,8 x 13	S	500	5,90 gal Zn
C 4,8 x 16	S	500	7,20 gal Zn
C 4,8 x 19	S	500	7,60 gal Zn
C 4,8 x 22	S	500	10,90 gal Zn
C 4,8 x 25	S	500	11,30 gal Zn
C 4,8 x 32	S	250	14,30 gal Zn
C 4,8 x 38	S	250	16,50 gal Zn
C 4,8 x 45	S	250	29,50 gal Zn
C 4,8 x 50	S	250	33,50 gal Zn
C 5,5 x 13	S	500	9,10 gal Zn
C 5,5 x 16	S	500	9,90 gal Zn
C 5,5 x 19	S	500	10,60 gal Zn
C 5,5 x 22	S	500	12,10 gal Zn
C 5,5 x 25	S	250	15,00 gal Zn
C 5,5 x 32	S	250	16,60 gal Zn
C 5,5 x 38	S	250	18,60 gal Zn
C 5,5 x 45	S	250	36,50 gal Zn
C 5,5 x 50	S	250	42,50 gal Zn
C 5,5 x 60	S	250	53,00 gal Zn
C 6,3 x 13	S	250	10,60 gal Zn
C 6,3 x 16	S	250	10,90 gal Zn
C 6,3 x 19	S	250	12,10 gal Zn
C 6,3 x 22	S	250	13,00 gal Zn
C 6,3 x 25	S	250	15,80 gal Zn
C 6,3 x 32	S	250	18,00 gal Zn
C 6,3 x 38	S	250	19,70 gal Zn
C 6,3 x 45	S	250	28,00 gal Zn
C 6,3 x 50	S	250	32,50 gal Zn
C 6,3 x 60	S	250	94,00 gal Zn
C 6,3 x 70	S	250	115,00 gal Zn
C 6,3 x 80	S	250	143,00 gal Zn
C 8 x 16	S	250	29,00 gal Zn
C 8 x 19	S	250	29,50 gal Zn
C 8 x 22	S	250	41,00 gal Zn
C 8 x 25	S	250	39,50 gal Zn
C 8 x 32	S	250	43,00 gal Zn
C 8 x 38	S	250	44,00 gal Zn
C 8 x 45	S	250	60,00 gal Zn
C 8 x 50	S	250	66,00 gal Zn
C 8 x 60	S	200	84,00 gal Zn
C 8 x 80	S	200	119,00 gal Zn

Abmessungen	VE	Stück	€/100/Obf.
ISO		91479.015	
1479		Stahl gehärtet	Form F
		galvanisch verzinkt	

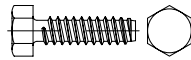

Sechskant-Blechsrauben, F = mit Zapfen

Maße → **TI-46** Montage → **TI-251**
 Korrosionsschutz → **TI-228** Normumstellung → **TI-11**
 Ausführung mit Bund = DIN 6928 auf Anfrage

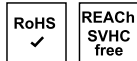

4,2 x 9,5 -F	S	500	9,70 gal Zn
4,2 x 13 -F	S	500	10,00 gal Zn
4,2 x 16 -F	S	500	10,00 gal Zn
4,2 x 19 -F	S	500	10,00 gal Zn
4,2 x 25 -F	S	500	10,30 gal Zn
4,8 x 9,5 -F	S	500	9,70 gal Zn
4,8 x 13 -F	S	500	8,50 gal Zn
4,8 x 16 -F	S	500	9,70 gal Zn
4,8 x 19 -F	S	250	10,00 gal Zn
4,8 x 22 -F	S	250	10,20 gal Zn
4,8 x 25 -F	S	500	10,30 gal Zn
6,3 x 16 -F	S	250	15,40 gal Zn
6,3 x 19 -F	S	250	17,00 gal Zn
6,3 x 22 -F	S	250	20,40 gal Zn
6,3 x 25 -F	S	250	21,70 gal Zn

DIN	01480.010	
1480	Stahl	SP
	galvanisch verzinkt	

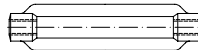

Spannschlossmuttern, geschmiedet, offene Form

Stahl = S235JR
 Maße → **TI-82** Korrosionsschutz → **TI-228**

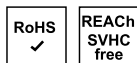

Innengewinde (R/L) X Gesamtlänge			
SP M 10 / 125	S	1	660,00 gal Zn
SP M 12 / 125	S	1	760,00 gal Zn
SP M 16 / 170	S	1	1250,00 gal Zn
SP M 20 / 200	S	1	2130,00 gal Zn
SP M 24 / 255	S	1	3900,00 gal Zn

Abmessungen	VE	Stück	€/100/Obf.
DIN		01480.310	
1480		Stahl	SP
		galvanisch verzinkt	

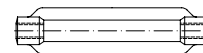

Spannschlossmuttern, geschmiedet, offene Form

Stahl = S235JR
 Maße → **TI-82** Korrosionsschutz → **TI-228**
 zulässige Tragfähigkeit → TI-Maßseiten

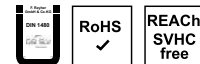

Innengewinde (R/L) X Gesamtlänge			
SP M 10 / 125	S	1	890,00 gal Zn
SP M 12 / 125	S	1	1020,00 gal Zn
SP M 16 / 170	S	1	1690,00 gal Zn
SP M 20 / 200	S	1	2900,00 gal Zn
SP M 24 / 255	S	1	5300,00 gal Zn

DIN	01480.020	
1480	Stahl	SP
	feuerverzinkt	

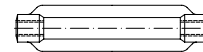

Spannschlossmuttern, geschmiedet, offene Form

Stahl = S235JR
 Gewindetoleranz 6H
 Maße → **TI-82** Korrosionsschutz → **TI-231**

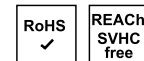

Innengewinde (R/L) X Gesamtlänge			
SP M 12 / 125	S	1	1510,00 tZn
SP M 16 / 170	S	1	2070,00 tZn
SP M 20 / 200	S	1	3550,00 tZn
SP M 24 / 255	S	1	6200,00 tZn

Abmessungen	VE Stück	€/100/Obf.
DIN	01480.320	
1480	Stahl	SP
	feuerverzinkt	

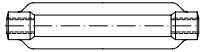

Spannschlossmuttern, geschmiedet, offene Form

Stahl = S235JR
Gewindetoleranz 6H

Maße → **TI-82** Korrosionsschutz → **TI-231**
zulässige Tragfähigkeit → **TI-Maßseiten**

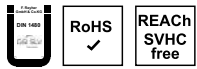

Innengewinde (R/L) X Gesamtlänge

SP M 12 / 125	S	1	2030,00 tZn
SP M 16 / 170	S	1	2800,00 tZn
SP M 20 / 200	S	1	4750,00 tZn
SP M 24 / 255	S	1	8400,00 tZn

DIN	01480.014
1480	Stahl SP-AE
	galvanisch verzinkt



Spannschlösser, geschmiedet, offene Form, AE = mit 2 Anschweißenden nach DIN 34828

Stahl = S235JR

Maße → **TI-82** Korrosionsschutz → **TI-228**
Rostfrei → **S. 518**

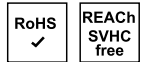

SP-AE M 6	S	1	780,00 gal Zn
SP-AE M 8	S	1	860,00 gal Zn
SP-AE M 10	S	1	1110,00 gal Zn
SP-AE M 12	S	1	1300,00 gal Zn
SP-AE M 14	S	1	1580,00 gal Zn
SP-AE M 16	S	1	2230,00 gal Zn
SP-AE M 20	S	1	3650,00 gal Zn
SP-AE M 22	S	1	4800,00 gal Zn
SP-AE M 24	S	1	6900,00 gal Zn
SP-AE M 27	S	1	8600,00 gal Zn
SP-AE M 30	S	1	9200,00 gal Zn
SP-AE M 36	S	1	17700,00 gal Zn
SP-AE M 42	S	1	28800,00 gal Zn
SP-AE M 48	S	1	45800,00 gal Zn

Abmessungen	VE Stück	€/100/Obf.
DIN	01480.311	
1480	Stahl	SP-AE
	galvanisch verzinkt	



Spannschlösser, geschmiedet, offene Form, AE = mit 2 Anschweißenden nach DIN 34828

Stahl = S235JR

Maße → **TI-82** Korrosionsschutz → **TI-228**
zulässige Tragfähigkeit → **TI-Maßseiten**

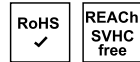

SP-AE M 6	S	1	1050,00 gal Zn
SP-AE M 8	S	1	1160,00 gal Zn
SP-AE M 10	S	1	1490,00 gal Zn
SP-AE M 12	S	1	1750,00 gal Zn
SP-AE M 16	S	1	3050,00 gal Zn
SP-AE M 20	S	1	4950,00 gal Zn
SP-AE M 24	S	1	9400,00 gal Zn
SP-AE M 30	S	1	12500,00 gal Zn
SP-AE M 36	S	1	23900,00 gal Zn

DIN	01480.016
1480	Stahl SP-RR
	galvanisch verzinkt



Spannschlösser, geschmiedet, offene Form RR = mit 2 Ringösen

Stahl = S235JR

Maße → **TI-82** Korrosionsschutz → **TI-228**
Rostfrei → **S. 519**

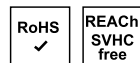

SP-RR M 6	S	1	960,00 gal Zn
SP-RR M 8	S	1	1060,00 gal Zn
SP-RR M 10	S	1	1310,00 gal Zn
SP-RR M 12	S	1	1550,00 gal Zn
SP-RR M 14	S	1	1800,00 gal Zn
SP-RR M 16	S	1	2460,00 gal Zn
SP-RR M 20	S	1	4200,00 gal Zn
SP-RR M 24	S	1	8300,00 gal Zn

Abmessungen	VE Stück	€/100/Obf.
DIN	01480.015	
1480	Stahl	SP-RH
	galvanisch verzinkt	



Spannschlösser geschmiedet, offene Form, RH = mit Ringöse und Haken

Stahl = S235JR

Maße → **TI-82** Korrosionsschutz → **TI-228**

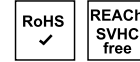

SP-RH M 6	S	1	960,00 gal Zn
SP-RH M 8	S	1	1060,00 gal Zn
SP-RH M 10	S	1	1310,00 gal Zn
SP-RH M 12	S	1	1550,00 gal Zn
SP-RH M 14	S	1	1800,00 gal Zn
SP-RH M 16	S	1	2460,00 gal Zn
SP-RH M 20	S	1	4200,00 gal Zn
SP-RH M 24	S	1	8300,00 gal Zn

DIN	01480.018
1480	Stahl SP-HH
	galvanisch verzinkt



Spannschlösser geschmiedet, offene Form, HH = mit 2 Haken

Stahl = S235JR

Maße → **TI-82** Korrosionsschutz → **TI-228**

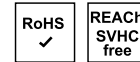

SP HH M 6	S	1	960,00 gal Zn
SP HH M 8	S	1	1060,00 gal Zn
SP HH M 10	S	1	1310,00 gal Zn
SP HH M 12	S	1	1550,00 gal Zn
SP HH M 16	S	1	2460,00 gal Zn
SP HH M 20	S	1	4200,00 gal Zn

Abmessungen	VE Stück	€/100/Obf.
DIN	01480.301	
1480	Stahl	SP-BS
	galvanisch verzinkt	

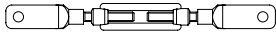

Spannschlösser geschmiedet, offene Form, BS = mit 2 Blattschrauben

Stahl = S235JR

Maße → **TI-82**

Korrosionsschutz → **TI-228**



SP BS M 12	S	1	2120,00 gal Zn
SP BS M 16	S	1	6700,00 gal Zn
SP BS M 20	S	1	11500,00 gal Zn
SP BS M 24	S	1	16400,00 gal Zn

Abmessungen	VE Stück	€/100/Obf.
DIN	01480.315	
1480	Stahl	SP-BS-S
	galvanisch verzinkt	

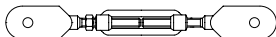

Spannschlösser geschmiedet, offene Form, BS = mit 2 Blattschrauben S = schwere Ausführung

CE nach EN 1090-2

Maße → **TI-82**

Korrosionsschutz → **TI-228**

Zulässige Tragfähigkeit → TI-Maßseiten

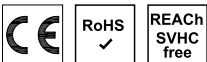

SP BS-S M 12	S	1	3050,00 gal Zn
SP BS-S M 16	S	1	9100,00 gal Zn
SP BS-S M 20	S	1	15700,00 gal Zn
SP BS-S M 24	S	1	22400,00 gal Zn
SP BS-S M 27	S	1	32700,00 gal Zn
SP BS-S M 30	S	1	36200,00 gal Zn
SP BS-S M 36	S	1	67800,00 gal Zn

Abmessungen	VE Stück	€/100/Obf.
DIN	01480.325	
1480	Stahl	SP-BS-S
	feuerverzinkt	



Spannschlösser geschmiedet, offene Form, BS = mit 2 Blattschrauben S = schwere Ausführung

CE nach EN 1090-2

Maße → **TI-82**

Korrosionsschutz → **TI-231**

Zulässige Tragfähigkeit → TI-Maßseiten

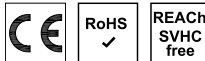

SP BS-S M 12	S	1	3350,00 tZn
SP BS-S M 16	S	1	9900,00 tZn
SP BS-S M 20	S	1	17000,00 tZn
SP BS-S M 24	S	1	23100,00 tZn
SP BS-S M 27	S	1	35200,00 tZn
SP BS-S M 30	S	1	39000,00 tZn
SP BS-S M 36	S	1	71600,00 tZn

Abmessungen	VE Stück	€/100/Obf.
DIN	01481.000	
1481	Federstahl	



Spannstifte (Spannhülsen), schwere Ausführung

Maße → **TI-121**

Normumstellung → **TI-10**

Rostfrei → **S. 519**

DIN 1481 → wird ersetzt durch ISO 8752

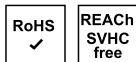

1	x	4	K 200	10,10
1	x	5	K 200	10,50
1	x	6	K 200	10,50
1	x	8	K 200	10,60
1	x	10	K 200	10,70
1	x	12	K 200	10,70
1	x	14	K 200	11,10
1	x	16	K 200	11,40
1	x	20	K 200	8,50
1,5	x	4	K 200	8,60
1,5	x	5	S 1000	7,80
1,5	x	5	K 200	8,60
1,5	x	6	S 1000	7,90
1,5	x	6	K 200	8,80
1,5	x	8	S 1000	8,30
1,5	x	8	K 200	9,10
1,5	x	10	S 1000	8,40
1,5	x	10	K 200	9,10
1,5	x	12	S 1000	8,40
1,5	x	12	K 200	9,20

Abmessungen	VE Stück	€/100/Obf.		
1,5	x	14	S 1000	8,50
1,5	x	14	K 200	9,40
1,5	x	16	K 200	9,60
1,5	x	18	K 200	10,50
1,5	x	20	K 200	10,70
2	x	4	S 1000	7,80
2	x	4	K 200	8,60
2	x	5	S 1000	8,40
2	x	5	K 200	9,20
2	x	6	S 1000	8,50
2	x	6	K 200	9,40
2	x	8	S 1000	8,80
2	x	8	K 200	9,50
2	x	10	S 1000	8,80
2	x	10	K 200	9,60
2	x	12	S 1000	8,80
2	x	12	K 200	9,60
2	x	14	S 1000	8,90
2	x	14	K 200	9,70
2	x	16	S 1000	8,90
2	x	16	K 200	9,90
2	x	18	S 1000	8,90
2	x	18	K 200	9,90
2	x	20	S 1000	9,90
2	x	20	K 200	10,60
2	x	22	K 200	10,80
2	x	24	S 1000	10,30
2	x	24	K 200	11,20
2	x	26	S 1000	10,80
2	x	26	K 200	11,70
2	x	28	K 200	12,40
2	x	30	S 1000	11,90
2	x	30	K 200	12,90
2,5	x	4	S 1000	8,80
2,5	x	4	K 200	9,60
2,5	x	5	S 1000	8,90
2,5	x	5	K 200	9,70
2,5	x	6	S 1000	9,00
2,5	x	6	K 200	9,90
2,5	x	8	S 1000	9,20
2,5	x	8	K 200	10,10
2,5	x	10	S 1000	9,50
2,5	x	10	K 200	10,30
2,5	x	12	S 1000	9,50
2,5	x	12	K 200	10,30
2,5	x	14	S 1000	9,60
2,5	x	14	K 200	10,50
2,5	x	16	S 1000	9,90
2,5	x	16	K 200	10,70
2,5	x	18	S 1000	10,00
2,5	x	18	K 200	10,70
2,5	x	20	S 1000	10,10
2,5	x	20	K 200	10,80
2,5	x	22	K 200	11,10
2,5	x	24	K 200	11,70
2,5	x	26	K 200	12,30
2,5	x	28	K 200	12,90
2,5	x	30	S 1000	13,00
2,5	x	30	K 200	13,70
3	x	4	K 200	7,80
3	x	5	S 1000	6,20
3	x	5	K 200	7,80
3	x	6	S 1000	6,50
3	x	6	K 200	8,20
3	x	8	S 1000	6,50
3	x	8	K 200	8,20
3	x	10	S 1000	6,60
3	x	10	K 200	8,30
3	x	12	S 1000	6,60
3	x	12	K 200	8,30
3	x	14	S 1000	6,70
3	x	14	K 200	8,40
3	x	16	S 1000	6,90
3	x	16	K 200	8,60
3	x	18	S 1000	7,20

Abmessungen	VE	Stück	€/100/Obf.	Abmessungen	VE	Stück	€/100/Obf.	Abmessungen	VE	Stück	€/100/Obf.
3 x 18	K	200	8,80	4 x 40	K	200	14,30	6 x 14	K	100	14,10
3 x 20	S	1000	7,40	4 x 45	S	500	15,00	6 x 16	S	500	12,50
3 x 20	K	200	9,10	4 x 45	K	100	16,40	6 x 16	K	100	14,80
3 x 22	S	1000	5,90	4 x 50	S	500	15,40	6 x 18	S	500	13,20
3 x 22	K	200	7,60	4 x 50	K	100	17,70	6 x 18	K	100	15,70
3 x 24	S	1000	7,70	4 x 55	S	500	22,30	6 x 20	S	500	14,30
3 x 24	K	200	9,40	4 x 55	K	100	24,70	6 x 20	K	100	16,70
3 x 26	S	1000	7,80	4 x 60	S	500	22,20	6 x 22	S	500	15,30
3 x 26	K	200	9,50	4 x 60	K	100	24,50	6 x 22	K	100	17,60
3 x 28	S	1000	8,40	4,5 x 10	K	100	11,80	6 x 24	S	500	16,10
3 x 28	K	200	10,10	4,5 x 12	K	100	12,40	6 x 24	K	100	18,60
3 x 30	S	1000	8,80	4,5 x 20	S	500	12,10	6 x 26	S	500	17,40
3 x 30	K	200	10,50	4,5 x 20	K	100	14,40	6 x 26	K	100	19,70
3 x 32	S	1000	9,10	4,5 x 22	K	100	14,70	6 x 28	S	500	18,40
3 x 32	K	100	12,50	4,5 x 24	K	100	15,30	6 x 28	K	100	20,70
3 x 36	S	1000	10,30	4,5 x 26	K	100	15,80	6 x 30	K	100	21,70
3 x 36	K	100	13,70	4,5 x 28	K	100	16,40	6 x 32	S	500	20,50
3 x 40	S	1000	11,10	4,5 x 30	S	500	14,40	6 x 32	K	100	22,90
3 x 40	K	100	14,30	4,5 x 30	K	100	16,70	6 x 36	S	500	21,60
3 x 50	S	1000	14,20	4,5 x 32	K	100	17,20	6 x 36	K	100	24,10
3 x 50	K	100	17,50	4,5 x 36	K	100	18,30	6 x 40	S	250	22,90
3,5 x 4	K	200	9,10	4,5 x 40	S	500	17,00	6 x 40	K	100	25,50
3,5 x 5	K	200	9,10	4,5 x 40	K	100	19,30	6 x 45	S	250	26,00
3,5 x 6	K	200	9,20	4,5 x 45	K	100	20,70	6 x 45	K	100	28,50
3,5 x 8	K	200	9,50	4,5 x 50	K	100	22,00	6 x 50	S	250	27,50
3,5 x 10	K	200	9,50	5 x 5	K	100	11,70	6 x 50	K	100	30,50
3,5 x 12	K	200	9,70	5 x 6	S	500	9,50	6 x 55	S	250	30,00
3,5 x 14	K	200	10,10	5 x 6	K	100	11,80	6 x 55	K	100	33,00
3,5 x 16	S	1000	8,60	5 x 8	S	500	9,50	6 x 60	S	250	33,00
3,5 x 16	K	200	10,10	5 x 8	K	100	11,80	6 x 60	K	100	36,00
3,5 x 18	K	200	10,30	5 x 10	S	500	9,50	6 x 65	K	100	38,50
3,5 x 20	S	1000	9,10	5 x 10	K	100	11,80	6 x 70	S	250	39,00
3,5 x 20	K	200	10,60	5 x 12	S	500	10,10	6 x 70	K	100	42,00
3,5 x 22	K	200	10,60	5 x 12	K	100	12,40	6 x 75	K	100	44,50
3,5 x 24	K	200	10,70	5 x 14	S	500	10,50	6 x 80	S	250	45,50
3,5 x 26	K	200	11,40	5 x 14	K	100	12,80	6 x 80	K	100	48,00
3,5 x 28	K	200	12,10	5 x 16	S	500	11,10	6 x 85	K	100	54,00
3,5 x 30	K	200	12,60	5 x 16	K	100	13,40	6 x 90	K	50	63,00
3,5 x 32	K	100	14,40	5 x 18	S	500	11,70	6 x 100	K	50	73,00
3,5 x 36	K	100	14,80	5 x 18	K	100	14,10	7 x 10	K	100	21,00
3,5 x 40	K	100	16,10	5 x 20	S	500	11,90	7 x 16	K	100	21,50
4 x 4	S	500	7,60	5 x 20	K	100	14,30	7 x 20	K	100	23,90
4 x 4	K	200	8,90	5 x 22	S	500	12,90	7 x 24	K	100	27,00
4 x 5	K	200	9,10	5 x 22	K	100	15,30	7 x 30	K	100	33,00
4 x 6	S	500	7,80	5 x 24	S	500	12,90	7 x 32	K	100	34,50
4 x 6	K	200	9,20	5 x 24	K	100	15,30	7 x 36	K	100	37,00
4 x 8	S	500	7,90	5 x 26	S	500	13,50	7 x 40	K	100	39,50
4 x 8	K	200	8,80	5 x 26	K	100	15,80	7 x 45	K	100	42,50
4 x 10	S	500	8,20	5 x 28	S	500	14,10	7 x 50	K	100	46,00
4 x 10	K	200	9,40	5 x 28	K	100	16,40	7 x 55	K	100	52,00
4 x 12	S	500	8,30	5 x 30	S	500	14,40	7 x 60	K	50	60,00
4 x 12	K	200	9,60	5 x 30	K	100	16,70	7 x 65	K	50	66,00
4 x 14	S	500	8,50	5 x 32	S	500	14,80	7 x 70	K	50	69,00
4 x 14	K	200	9,90	5 x 32	K	100	18,40	7 x 75	K	50	79,00
4 x 16	S	500	8,60	5 x 36	S	500	16,00	7 x 80	K	50	88,00
4 x 16	K	200	10,10	5 x 36	K	100	18,30	7 x 90	K	50	96,00
4 x 18	S	500	8,80	5 x 40	S	500	17,00	7 x 100	K	50	111,00
4 x 18	K	200	10,10	5 x 40	K	100	19,30	9 x 40	K	100	59,00
4 x 20	S	500	8,90	5 x 45	S	500	18,40	9 x 50	K	100	74,00
4 x 20	K	200	10,20	5 x 45	K	100	20,70	9 x 60	K	50	88,00
4 x 22	S	500	9,20	5 x 50	S	250	19,40	9 x 70	K	50	106,00
4 x 22	K	200	10,60	5 x 50	K	100	22,00	9 x 80	K	50	118,00
4 x 24	S	500	9,40	5 x 55	K	100	24,50	9 x 90	K	50	134,00
4 x 24	K	200	10,70	5 x 60	S	250	23,90	10 x 10	K	100	77,00
4 x 26	S	500	9,50	5 x 60	K	100	26,50	10 x 12	K	100	77,00
4 x 26	K	200	10,80	5 x 65	K	100	28,50	10 x 14	S	500	27,00
4 x 28	S	500	10,20	5 x 70	S	250	29,00	10 x 14	K	100	29,50
4 x 28	K	200	11,50	5 x 70	K	100	31,50	10 x 16	S	500	27,00
4 x 30	S	500	10,80	5 x 75	K	100	34,50	10 x 16	K	100	29,50
4 x 30	K	200	11,90	5 x 80	K	100	38,50	10 x 18	K	100	34,50
4 x 32	S	500	11,30	6 x 10	S	500	11,20	10 x 20	S	500	31,50
4 x 32	K	200	12,50	6 x 10	K	100	13,50	10 x 20	K	100	34,50
4 x 36	S	500	11,80	6 x 12	S	500	11,40	10 x 22	K	100	37,00
4 x 36	K	200	13,10	6 x 12	K	100	13,70	10 x 24	S	500	37,00
4 x 40	S	500	12,90	6 x 14	S	500	11,70	10 x 24	K	100	39,50

Abmessungen	VE	Stück	€/100/Obf.	Abmessungen	VE	Stück	€/100/Obf.	Abmessungen	VE	Stück	€/100/Obf.
10 x 26	S	500	39,00	13 x 26	S	25	165,00	16 x 160	S	10	1360,00
10 x 26	K	100	42,00	13 x 28	S	25	166,00	16 x 180	S	10	1530,00
10 x 28	S	500	41,50	13 x 30	S	25	174,00	16 x 200	S	10	1700,00
10 x 28	K	100	44,50	13 x 32	S	25	176,00	18 x 24	S	25	229,00
10 x 30	S	500	44,50	13 x 36	S	25	181,00	18 x 30	S	25	240,00
10 x 30	K	100	47,00	13 x 40	S	25	184,00	18 x 36	S	25	246,00
10 x 32	S	500	49,50	13 x 45	S	25	187,00	18 x 40	S	25	250,00
10 x 32	K	100	52,00	13 x 50	S	25	193,00	18 x 45	S	25	255,00
10 x 36	S	250	53,00	13 x 55	S	25	200,00	18 x 50	S	25	260,00
10 x 36	K	100	56,00	13 x 60	S	25	207,00	18 x 55	S	25	275,00
10 x 40	S	250	57,00	13 x 65	S	25	220,00	18 x 60	S	25	300,00
10 x 40	K	100	59,00	13 x 70	S	25	229,00	18 x 65	S	25	335,00
10 x 45	S	250	63,00	13 x 75	S	25	236,00	18 x 70	S	25	360,00
10 x 45	K	100	66,00	13 x 80	S	25	275,00	18 x 75	S	25	390,00
10 x 50	S	250	69,00	13 x 85	S	25	360,00	18 x 80	S	25	415,00
10 x 50	K	100	73,00	13 x 90	S	25	455,00	18 x 90	S	10	650,00
10 x 55	S	250	76,00	13 x 95	S	25	540,00	18 x 100	S	10	820,00
10 x 55	K	100	77,00	13 x 100	S	10	620,00	18 x 120	S	10	1150,00
10 x 60	S	200	84,00	13 x 120	S	10	850,00	18 x 140	S	10	1360,00
10 x 60	K	50	88,00	13 x 130	S	10	990,00	18 x 160	S	10	1540,00
10 x 65	S	200	94,00	13 x 140	S	10	990,00	20 x 20	S	25	246,00
10 x 65	K	50	97,00	13 x 160	S	10	1140,00	20 x 30	S	25	295,00
10 x 70	S	100	101,00	13 x 180	S	10	1320,00	20 x 32	S	25	300,00
10 x 70	K	50	106,00	14 x 12	S	25	315,00	20 x 36	S	25	310,00
10 x 75	S	100	107,00	14 x 18	S	25	295,00	20 x 40	S	25	330,00
10 x 75	K	50	112,00	14 x 20	S	25	183,00	20 x 45	S	25	360,00
10 x 80	S	100	113,00	14 x 24	S	25	190,00	20 x 50	S	25	380,00
10 x 80	K	50	118,00	14 x 28	S	25	201,00	20 x 55	S	25	410,00
10 x 85	S	100	119,00	14 x 30	S	25	205,00	20 x 60	S	25	425,00
10 x 85	K	50	124,00	14 x 32	S	25	207,00	20 x 65	S	25	455,00
10 x 90	S	100	128,00	14 x 36	S	25	212,00	20 x 70	S	25	480,00
10 x 90	K	50	134,00	14 x 40	S	25	215,00	20 x 75	S	25	510,00
10 x 95	K	50	141,00	14 x 45	S	25	220,00	20 x 80	S	25	540,00
10 x 100	S	100	144,00	14 x 50	S	25	226,00	20 x 85	S	10	660,00
10 x 100	K	50	151,00	14 x 55	S	25	230,00	20 x 90	S	10	740,00
10 x 110	K	50	590,00	14 x 60	S	25	236,00	20 x 100	S	10	910,00
10 x 120	S	50	590,00	14 x 65	S	25	255,00	20 x 120	S	10	1320,00
10 x 120	K	25	590,00	14 x 70	S	25	260,00	20 x 130	S	10	1540,00
10 x 140	S	50	750,00	14 x 75	S	25	265,00	20 x 140	S	10	1540,00
10 x 140	K	25	760,00	14 x 80	S	25	285,00	20 x 160	S	10	1760,00
10 x 160	S	50	810,00	14 x 85	S	25	460,00	20 x 180	S	10	2290,00
10 x 160	K	25	820,00	14 x 90	S	25	540,00	20 x 200	S	10	2850,00
12 x 10	S	25	310,00	14 x 100	S	10	720,00	21 x 16	S	25	680,00
12 x 12	S	25	300,00	14 x 120	S	10	940,00	21 x 20	S	25	370,00
12 x 14	S	25	290,00	14 x 140	S	10	1110,00	21 x 24	S	25	410,00
12 x 16	S	25	280,00	14 x 160	S	10	1250,00	21 x 26	S	25	420,00
12 x 18	S	25	270,00	14 x 200	S	10	1470,00	21 x 30	S	25	455,00
12 x 20	S	25	144,00	16 x 10	S	25	360,00	21 x 32	S	25	460,00
12 x 22	S	25	148,00	16 x 16	S	25	315,00	21 x 36	S	25	485,00
12 x 24	S	25	153,00	16 x 18	S	25	310,00	21 x 40	S	25	520,00
12 x 26	S	25	155,00	16 x 20	S	25	210,00	21 x 45	S	25	530,00
12 x 28	S	25	160,00	16 x 22	S	25	213,00	21 x 50	S	25	560,00
12 x 30	S	25	153,00	16 x 24	S	25	217,00	21 x 55	S	25	590,00
12 x 32	S	25	180,00	16 x 26	S	25	222,00	21 x 60	S	25	610,00
12 x 36	S	25	170,00	16 x 28	S	25	224,00	21 x 65	S	10	650,00
12 x 40	S	25	176,00	16 x 30	S	25	232,00	21 x 70	S	10	670,00
12 x 45	S	25	181,00	16 x 32	S	25	235,00	21 x 75	S	10	690,00
12 x 50	S	25	184,00	16 x 36	S	25	240,00	21 x 80	S	10	730,00
12 x 55	S	25	193,00	16 x 40	S	25	244,00	21 x 85	S	10	790,00
12 x 60	S	25	200,00	16 x 45	S	25	246,00	21 x 90	S	10	880,00
12 x 65	S	25	212,00	16 x 50	S	25	255,00	21 x 95	S	10	960,00
12 x 70	S	25	220,00	16 x 55	S	25	255,00	21 x 100	S	10	970,00
12 x 75	S	25	229,00	16 x 60	S	25	265,00	21 x 120	S	10	1360,00
12 x 80	S	25	234,00	16 x 65	S	25	275,00	21 x 130	S	10	2400,00
12 x 85	S	25	330,00	16 x 70	S	25	305,00	21 x 140	S	10	1540,00
12 x 90	S	25	415,00	16 x 75	S	25	330,00	21 x 200	S	10	3200,00
12 x 95	S	25	485,00	16 x 80	S	25	345,00	25 x 32	S	10	1180,00
12 x 100	S	25	570,00	16 x 85	S	25	510,00	25 x 36	S	10	1200,00
12 x 120	S	10	720,00	16 x 90	S	25	600,00	25 x 40	S	10	1210,00
12 x 130	S	10	840,00	16 x 100	S	10	760,00	25 x 50	S	10	1280,00
12 x 140	S	10	840,00	16 x 110	S	10	1020,00	25 x 55	S	10	1300,00
12 x 160	S	10	960,00	16 x 120	S	10	1020,00	25 x 60	S	10	1320,00
12 x 180	S	10	1070,00	16 x 130	S	10	1180,00	25 x 65	S	10	1360,00
13 x 20	S	25	153,00	16 x 140	S	10	1180,00	25 x 70	S	10	1410,00
13 x 24	S	25	160,00	16 x 150	S	10	1360,00	25 x 80	S	10	1480,00

Abmessungen	VE	Stück	€/100/Obf.
25 x 85	S	10	1670,00
25 x 90	S	10	1890,00
25 x 100	S	10	2270,00
25 x 120	S	1	2550,00
25 x 140	S	1	2800,00
25 x 160	S	1	3050,00
25 x 200	S	1	4150,00
28 x 26	S	10	1260,00
28 x 28	S	10	1380,00
28 x 30	S	10	1340,00
28 x 32	S	10	1360,00
28 x 36	S	10	1410,00
28 x 40	S	10	1430,00
28 x 45	S	10	1480,00
28 x 50	S	10	1530,00
28 x 55	S	10	1570,00
28 x 60	S	10	1630,00
28 x 65	S	10	1750,00
28 x 70	S	10	1870,00
28 x 75	S	10	1990,00
28 x 80	S	10	2110,00
28 x 90	S	10	2650,00
28 x 100	S	1	3250,00
28 x 120	S	1	3600,00
28 x 140	S	1	3950,00
28 x 160	S	1	4300,00
28 x 200	S	1	5700,00
30 x 30	S	10	1510,00
30 x 32	S	10	1520,00
30 x 36	S	10	1580,00
30 x 40	S	10	1640,00
30 x 50	S	10	1770,00
30 x 60	S	10	2040,00
30 x 65	S	10	2060,00
30 x 70	S	10	2220,00
30 x 80	S	10	2550,00
30 x 90	S	1	3100,00
30 x 100	S	1	3700,00
30 x 120	S	1	4300,00
30 x 140	S	1	4950,00
30 x 160	S	1	5600,00
30 x 180	S	1	6300,00
30 x 200	S	1	6900,00
35 x 50	S	1	2070,00
35 x 60	S	1	2270,00
35 x 80	S	1	3900,00
35 x 90	S	1	4400,00
35 x 100	S	1	4850,00
40 x 50	S	1	2400,00
40 x 55	S	1	2650,00
40 x 60	S	1	2650,00
40 x 70	S	1	2950,00
40 x 80	S	1	3250,00
40 x 90	S	1	3600,00
40 x 100	S	1	3950,00

Abmessungen	VE	Stück	€/100/Obf.
Artikel	82481.000		
82481	Sortiment	DIN 1481	
	Federstahl		

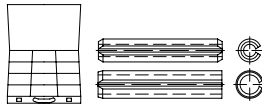

Spannstifte-Sortiment DIN 1481

Inhalt: 12 gängige Abmessungen
von 1,5 x 10 – 8 x 80, ca. 710 Stück
(Metall-Koffer)

Wunschsortiment auf Anfrage

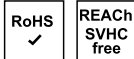

DIN 1481	S	1	8900,00
----------	---	---	---------

DIN	01498.004
-----	-----------

1498 Federstahl Form EG

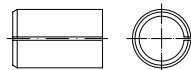

Einspannbuchsen für Lagerungen, EG = ohne Aussenkung, mit geradem Schlitz

Maße → TI-120



Innen Ø x Außen Ø x Länge

EG 16/20 x 20	S	1	5900,00
EG 20/26 x 20	S	1	5900,00
EG 25/32 x 20	S	1	5900,00
EG 25/32 x 28	S	1	5900,00
EG 25/32 x 30	S	1	5900,00
EG 28/35 x 25	S	1	5900,00
EG 30/38 x 25	S	1	6000,00
EG 40/50 x 25	S	1	6000,00
EG 40/50 x 30	S	1	6100,00
EG 40/50 x 40	S	1	6100,00
EG 50/60 x 50	S	1	6400,00

Abmessungen	VE	Stück	€/100/Obf.
ISO	01580.400		
1580	4.8		

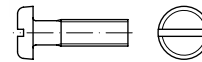

Flachkopfschrauben mit Schlitz

Maße → TI-37 Normumstellung → TI-11
Werkstoffeigensch. → TI-232 REACH → TI-262

Rostfrei → S. 520
Messing, Kunststoff → S. 633

ISO 1580 → ersetzt DIN 85 (austauschbar)



M 3 x 5	S	2000	6,20
M 3 x 6	S	2000	3,25
M 3 x 8	S	2000	1,40
M 3 x 10	S	2000	1,90
M 3 x 12	S	2000	2,15
M 3 x 16	S	2000	2,30
M 3 x 25	S	2000	3,35
M 4 x 6	S	2000	4,95
M 4 x 8	S	2000	2,40
M 4 x 10	S	2000	2,45
M 4 x 12	S	2000	2,50
M 4 x 16	S	2000	2,85
M 4 x 20	S	2000	3,30
M 4 x 25	S	1000	4,80
M 4 x 30	S	1000	5,30
M 4 x 35	S	1000	6,60
M 4 x 40	S	1000	7,20
M 5 x 8	S	2000	3,65
M 5 x 10	S	2000	3,70
M 5 x 12	S	1000	3,90
M 5 x 16	S	1000	4,45
M 5 x 20	S	1000	4,85
M 5 x 35	S	500	11,30
M 5 x 40	S	500	10,60
M 5 x 50	S	500	11,90
M 6 x 8	S	1000	13,20
M 6 x 10	S	1000	5,60
M 6 x 12	S	1000	5,80
M 6 x 16	S	1000	6,50
M 6 x 20	S	1000	9,80
M 6 x 25	S	500	8,00
M 6 x 30	S	500	8,90
M 6 x 35	S	500	10,00
M 6 x 50	S	200	22,30



- ✓ Große Artikelvielfalt
- ✓ Verlässliche Qualität
- ✓ Hohe Lieferbereitschaft



Wir versorgen Sie mit
Verbindungselementen
und Befestigungstechnik!

Abmessungen	VE Stück	€/100/Obf.
ISO	01580.410	
1580	4.8	galvanisch verzinkt

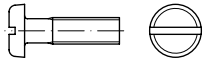

Flachkopfschrauben mit Schlitz

Maße → **TI-37** Normumstellung → **TI-11**
 Werkstoffeigensch. → **TI-232** REACH → **TI-262**
 Korrosionsschutz → **TI-228**
 Rostfrei → **S. 520**
 Messing, Kunststoff → **S. 633**
 ISO 1580 → ersetzt DIN 85 (austauschbar)



M 3	x	4	S	2000	7,20 gal Zn
M 3	x	4	K	200	10,20 gal Zn
M 3	x	5	S	2000	6,80 gal Zn
M 3	x	5	K	200	9,70 gal Zn
M 3	x	6	S	2000	3,15 gal Zn
M 3	x	6	K	200	6,50 gal Zn
M 3	x	8	S	2000	1,55 gal Zn
M 3	x	8	K	200	4,55 gal Zn
M 3	x	10	S	2000	1,70 gal Zn
M 3	x	10	K	200	5,00 gal Zn
M 3	x	12	S	2000	1,95 gal Zn
M 3	x	12	K	200	5,30 gal Zn
M 3	x	16	S	2000	2,15 gal Zn
M 3	x	16	K	200	5,40 gal Zn
M 3	x	20	S	2000	2,90 gal Zn
M 3	x	20	K	200	6,30 gal Zn
M 3	x	25	S	2000	3,35 gal Zn
M 3	x	25	K	200	6,70 gal Zn
M 3	x	30	K	200	7,70 gal Zn
M 3	x	35	K	200	9,10 gal Zn
M 3	x	40	K	200	9,90 gal Zn
M 3	x	45	K	200	13,70 gal Zn
M 3	x	50	K	200	15,50 gal Zn
M 3	x	60	K	200	19,30 gal Zn
M 4	x	5	S	2000	10,50 gal Zn
M 4	x	5	K	200	14,00 gal Zn
M 4	x	6	S	2000	4,85 gal Zn
M 4	x	6	K	200	8,40 gal Zn
M 4	x	8	S	2000	2,50 gal Zn
M 4	x	8	K	200	5,50 gal Zn
M 4	x	10	S	2000	2,60 gal Zn
M 4	x	10	K	200	5,60 gal Zn
M 4	x	12	S	2000	2,70 gal Zn
M 4	x	12	K	200	5,70 gal Zn
M 4	x	16	S	2000	3,15 gal Zn
M 4	x	16	K	200	6,20 gal Zn
M 4	x	20	S	2000	3,45 gal Zn
M 4	x	20	K	200	6,70 gal Zn
M 4	x	25	S	1000	4,20 gal Zn
M 4	x	25	K	200	8,30 gal Zn
M 4	x	30	S	1000	5,40 gal Zn
M 4	x	30	K	200	8,80 gal Zn
M 4	x	35	K	200	9,90 gal Zn
M 4	x	40	K	200	10,30 gal Zn
M 4	x	45	K	200	13,60 gal Zn
M 4	x	50	K	200	14,30 gal Zn
M 4	x	60	K	200	19,30 gal Zn
M 5	x	6	S	2000	12,80 gal Zn
M 5	x	6	K	200	17,70 gal Zn
M 5	x	8	S	2000	3,90 gal Zn
M 5	x	8	K	200	6,90 gal Zn
M 5	x	10	S	2000	4,10 gal Zn

Abmessungen	VE Stück	€/100/Obf.			
M 5	x	10	K	200	7,10 gal Zn
M 5	x	12	S	1000	4,20 gal Zn
M 5	x	12	K	200	7,30 gal Zn
M 5	x	16	S	1000	4,85 gal Zn
M 5	x	16	K	200	7,90 gal Zn
M 5	x	20	S	1000	5,30 gal Zn
M 5	x	20	K	200	8,40 gal Zn
M 5	x	25	S	1000	5,80 gal Zn
M 5	x	25	K	200	8,80 gal Zn
M 5	x	30	S	1000	6,90 gal Zn
M 5	x	30	K	200	9,90 gal Zn
M 5	x	35	S	2000	8,00 gal Zn
M 5	x	35	K	200	10,90 gal Zn
M 5	x	40	S	2000	10,50 gal Zn
M 5	x	40	K	200	13,50 gal Zn
M 5	x	45	S	500	11,60 gal Zn
M 5	x	45	K	200	14,60 gal Zn
M 5	x	50	K	200	16,10 gal Zn
M 5	x	60	K	200	22,00 gal Zn
M 6	x	8	S	1000	14,10 gal Zn
M 6	x	8	K	200	17,60 gal Zn
M 6	x	10	S	1000	6,10 gal Zn
M 6	x	10	K	200	9,10 gal Zn
M 6	x	12	S	1000	6,30 gal Zn
M 6	x	12	K	200	9,40 gal Zn
M 6	x	16	S	1000	6,90 gal Zn
M 6	x	16	K	200	10,10 gal Zn
M 6	x	20	S	1000	7,80 gal Zn
M 6	x	20	K	200	10,70 gal Zn
M 6	x	25	S	500	8,80 gal Zn
M 6	x	25	K	200	11,80 gal Zn
M 6	x	30	S	500	9,60 gal Zn
M 6	x	30	K	200	12,80 gal Zn
M 6	x	35	K	200	14,00 gal Zn
M 6	x	40	K	200	17,40 gal Zn
M 6	x	45	K	200	19,30 gal Zn
M 6	x	50	K	200	21,00 gal Zn
M 6	x	55	K	100	34,00 gal Zn
M 6	x	60	K	100	36,00 gal Zn
M 8	x	10	K	100	44,00 gal Zn
M 8	x	12	K	100	22,40 gal Zn
M 8	x	16	K	100	23,30 gal Zn
M 8	x	20	K	100	24,50 gal Zn
M 8	x	25	K	100	27,50 gal Zn
M 8	x	30	K	100	28,00 gal Zn
M 8	x	40	K	100	28,50 gal Zn
M 8	x	50	K	100	39,50 gal Zn

Abmessungen	VE Stück	€/100/Obf.
DIN	01587.300	
1587	6	galvanisch verzinkt

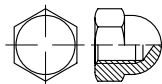

Sechskant-Hutmutter, hohe Form

ab M 12 mit Rille oder entsprechender Einschraubtiefe t min.

Maße → **TI-63** REACH → **TI-262**
 Werkstoffeigensch. → **TI-233**
 Rostfrei → **S. 521**
 Messing, Kunststoff → **S. 633**



M 3	S	1000	17,00
M 3	K	100	22,40
M 4	S	1000	17,00
M 4	K	100	22,40

Abmessungen	VE Stück	€/100/Obf.	
M 5	S	1000	18,30
M 5	K	100	23,90
M 6	S	1000	25,50
M 6	K	100	31,00
M 8	S	500	42,00
M 8	K	100	48,50
M 10 SW 17	S	500	66,00
M 10 SW 17	K	100	74,00
M 12 SW 19	S	200	120,00
M 12 SW 19	K	50	135,00
M 14 SW 22	S	50	194,00
M 16	S	50	206,00
M 18	S	25	335,00
M 20	S	25	345,00
M 22 SW 32	S	10	650,00
M 24	S	10	690,00
M 30	S	10	2320,00

Abmessungen	VE Stück	€/100/Obf.
DIN	01587.310	
1587	6	galvanisch verzinkt

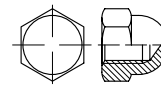

Sechskant-Hutmutter, hohe Form

ab M 12 mit Rille oder entsprechender Einschraubtiefe t min.

Maße → **TI-63** Korrosionsschutz → **TI-228**
 Werkstoffeigensch. → **TI-233** REACH → **TI-262**
 Rostfrei → **S. 521**
 Messing, Kunststoff → **S. 633**



M 3	S	100	22,70 gal Zn
M 4	S	1000	17,40 gal Zn
M 4	K	100	23,00 gal Zn
M 5	S	1000	19,20 gal Zn
M 5	K	100	24,60 gal Zn
M 6	S	1000	26,50 gal Zn
M 6	K	100	33,00 gal Zn
M 8	S	500	45,50 gal Zn
M 8	K	100	53,00 gal Zn
M 10 SW 17	S	500	73,00 gal Zn
M 10 SW 17	K	100	82,00 gal Zn
M 12 SW 19	S	200	130,00 gal Zn
M 12 SW 19	K	50	144,00 gal Zn
M 14 SW 22	S	50	207,00 gal Zn
M 16	S	25	224,00 gal Zn
M 18	S	25	370,00 gal Zn
M 20	S	25	385,00 gal Zn
M 24	S	10	770,00 gal Zn
M 30	S	10	2450,00 gal Zn

Abmessungen VE Stück €/100/Obf.

DIN	01587.330
-----	-----------

1587 ⁶ galvanisch verchromt

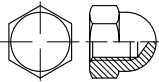

Sechskant-Hutmuttern, hohe Form

ab M 12 mit Rille oder entsprechender Einschraubtiefe t min.

Maße → TI-63 REACH → TI-262
Werkstoffeigensch. → TI-233

Rostfrei → S. 521
Messing, Kunststoff → S. 633



M 3	S	100	43,00 gal Cr
M 4	S	100	41,50 gal Cr
M 5	S	100	47,00 gal Cr
M 6	S	100	57,00 gal Cr
M 8	S	50	95,00 gal Cr
M 10 SW 17	S	50	166,00 gal Cr
M 12 SW 19	S	25	265,00 gal Cr
M 16	S	25	420,00 gal Cr
M 20	S	10	780,00 gal Cr

DIN	01587.305
-----	-----------

1587 ⁶ **Fein**

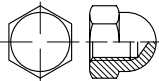

Sechskant-Hutmuttern, hohe Form, mit metrischem Feingewinde

ab M 12 mit Rille oder entsprechender Einschraubtiefe t min.

Maße → TI-63 REACH → TI-262
Werkstoffeigensch. → TI-233



M 8	x 1	S	100	57,00
M 10	x 1	S	100	86,00
M 12	x 1,5 SW 19	S	50	158,00
M 14	x 1,5 SW 22	S	25	246,00
M 16	x 1,5	S	25	265,00
M 18	x 1,5	S	25	395,00
M 20	x 1,5	S	25	420,00
M 24	x 2	S	10	820,00

Abmessungen VE Stück €/100/Obf.

EN	01661.800
----	-----------

1661 ⁸

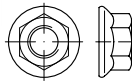

Sechskantmuttern mit Flansch

Maße → TI-64 Anziehmomente → TI-244
Werkstoffeigensch. → TI-233 Normumstellung → TI-7

Rostfrei → S. 521

EN 1661 → ersetzt DIN 6923

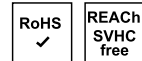

M 4	S	1000	9,10
M 5	S	1000	10,30
M 6	S	1000	13,40
M 8	S	1000	19,40
M 10	S	500	36,50
M 12	S	250	51,00
M 16	S	50	158,00
M 20	S	50	270,00

EN	01661.810
----	-----------

1661 ⁸ galvanisch verzinkt

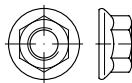

Sechskantmuttern mit Flansch

Maße → TI-64 Anziehmomente → TI-244
Werkstoffeigensch. → TI-233 Normumstellung → TI-7
Korrosionsschutz → TI-228

Rostfrei → S. 521

EN 1661 → ersetzt DIN 6923



M 4	S	1000	12,50 gal Zn
M 5	S	1000	14,30 gal Zn
M 6	S	1000	15,80 gal Zn
M 8	S	1000	22,70 gal Zn
M 10	S	500	41,50 gal Zn
M 12	S	250	57,00 gal Zn
M 16	S	50	177,00 gal Zn
M 20	S	50	295,00 gal Zn

Abmessungen VE Stück €/100/Obf.

EN	01661.100
----	-----------

1661 ¹⁰

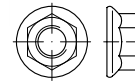

Sechskantmuttern mit Flansch

Maße → TI-64 Anziehmomente → TI-244
Werkstoffeigensch. → TI-233 Normumstellung → TI-7

Rostfrei → S. 521

EN 1661 → ersetzt DIN 6923

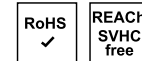

M 5	S	1000	11,50
M 6	S	1000	16,40
M 8	S	1000	36,00
M 10	S	500	60,00
M 12	S	250	92,00
M 16	S	50	218,00
M 20	S	50	485,00

EN	01661.110
----	-----------

1661 ¹⁰ galvanisch verzinkt

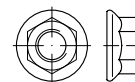

Sechskantmuttern mit Flansch

Maße → TI-64 Anziehmomente → TI-244
Werkstoffeigensch. → TI-233 Normumstellung → TI-7
Korrosionsschutz → TI-228

Rostfrei → S. 521

EN 1661 → ersetzt DIN 6923

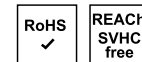

M 5	S	1000	13,40 gal Zn
M 6	S	1000	18,20 gal Zn
M 8	S	1000	39,00 gal Zn
M 10	S	500	66,00 gal Zn
M 12	S	250	100,00 gal Zn
M 16	S	50	230,00 gal Zn
M 20	S	50	530,00 gal Zn

Abmessungen	VE Stück	€/100/Obf.
EN	01663.810	
1663	8	galvanisch verzinkt

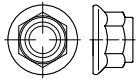

Sechskantmutter mit Klemmteil und Flansch, mit nichtmetallischem Einsatz

für Temperatur-Einsatz von -50 bis +120 °C

Maße → **TI-69** Korrosionsschutz → **TI-228**
 Werkstoffeigensch. → **TI-233** Normumstellung → **TI-9**

EN 1663 → ersetzt DIN 6926



M 5	S 100	14,60 gal Zn
M 6	S 100	18,10 gal Zn
M 8	S 100	22,20 gal Zn
M 16	S 100	84,00 gal Zn

EN	01664.810
1664	8
galvanisch verzinkt	

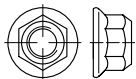

Sechskantmutter mit Klemmteil und Flansch (Ganzmetallmutter)

Maße → **TI-69** Korrosionsschutz → **TI-228**
 Werkstoffeigensch. → **TI-233** Normumstellung → **TI-9**

EN 1664 → ersetzt DIN 6927

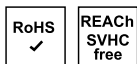

M 5	S 100	14,60 gal Zn
M 6	S 100	18,10 gal Zn
M 8	S 100	22,20 gal Zn
M 10	S 100	26,00 gal Zn
M 12	S 100	36,50 gal Zn
M 16	S 100	84,00 gal Zn

Abmessungen	VE Stück	€/100/Obf.
EN	01665.800	
1665	8.8	

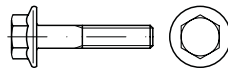

Sechskantschrauben mit Flansch, schwere Reihe

Maße → **TI-17** Anziehmomente → **TI-244**
 Werkstoffeigensch. → **TI-232** Normumstellung → **TI-6**

Rostfrei → **S. 521**

EN 1665 → ersetzt DIN 6921

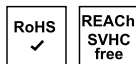

M 6	x 12	S 500	28,00
M 6	x 16	S 500	18,80
M 6	x 20	S 500	18,10
M 6	x 25	S 500	18,10
M 6	x 30	S 500	20,30
M 8	x 12	S 200	57,00
M 8	x 16	S 200	51,00
M 8	x 20	S 200	36,00
M 8	x 25	S 200	36,50
M 8	x 30	S 200	39,50
M 8	x 35	S 200	43,00
M 8	x 40	S 200	46,00
M 8	x 50	S 200	53,00
M 10	x 16	S 200	83,00
M 10	x 20	S 200	51,00
M 10	x 25	S 200	54,00
M 10	x 30	S 200	57,00
M 10	x 35	S 100	63,00
M 10	x 40	S 100	68,00
M 10	x 45	S 100	76,00
M 10	x 50	S 100	80,00
M 10	x 60	S 100	89,00
M 12	x 20	S 100	153,00
M 12	x 25	S 100	142,00
M 12	x 30	S 100	153,00
M 12	x 35	S 100	167,00
M 12	x 40	S 100	174,00
M 12	x 45	S 100	190,00
M 12	x 50	S 100	201,00
M 12	x 60	S 100	227,00
M 12	x 70	S 50	260,00
M 12	x 80	S 50	290,00
M 12	x 90	S 50	330,00
M 12	x 100	S 50	355,00
M 16	x 30	S 50	233,00
M 16	x 35	S 50	249,00
M 16	x 40	S 50	265,00
M 16	x 45	S 50	280,00
M 16	x 50	S 50	295,00
M 16	x 60	S 50	345,00
M 16	x 65	S 25	365,00
M 16	x 70	S 25	365,00

Abmessungen	VE Stück	€/100/Obf.
EN	01665.810	
1665	8.8	galvanisch verzinkt

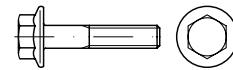

Sechskantschrauben mit Flansch, schwere Reihe

Maße → **TI-17** Anziehmomente → **TI-244**
 Werkstoffeigensch. → **TI-232** Normumstellung → **TI-6**
 Korrosionsschutz → **TI-228**

Rostfrei → **S. 521**

EN 1665 → ersetzt DIN 6921

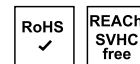

M 6	x 12	S 500	30,50 gal Zn
M 6	x 16	S 500	21,10 gal Zn
M 6	x 20	S 500	21,10 gal Zn
M 6	x 25	S 500	22,40 gal Zn
M 8	x 12	S 200	62,00 gal Zn
M 8	x 16	S 200	56,00 gal Zn
M 8	x 20	S 200	41,00 gal Zn
M 8	x 25	S 200	42,50 gal Zn
M 8	x 30	S 200	45,50 gal Zn
M 8	x 35	S 200	49,50 gal Zn
M 8	x 40	S 200	50,00 gal Zn
M 8	x 50	S 200	61,00 gal Zn
M 8	x 60	S 200	69,00 gal Zn
M 10	x 20	S 200	59,00 gal Zn
M 10	x 25	S 200	56,00 gal Zn
M 10	x 30	S 200	74,00 gal Zn
M 12	x 20	S 100	165,00 gal Zn
M 12	x 25	S 100	155,00 gal Zn
M 12	x 30	S 100	166,00 gal Zn
M 12	x 35	S 100	181,00 gal Zn
M 12	x 40	S 100	188,00 gal Zn
M 12	x 45	S 100	206,00 gal Zn
M 12	x 50	S 100	218,00 gal Zn
M 12	x 60	S 100	245,00 gal Zn
M 12	x 70	S 50	280,00 gal Zn
M 12	x 80	S 50	310,00 gal Zn
M 12	x 90	S 50	355,00 gal Zn
M 16	x 30	S 50	260,00 gal Zn
M 16	x 35	S 50	275,00 gal Zn
M 16	x 40	S 50	290,00 gal Zn
M 16	x 50	S 50	315,00 gal Zn
M 16	x 60	S 50	380,00 gal Zn
M 16	x 70	S 25	425,00 gal Zn

Abmessungen	VE Stück	€/100/Obf.
EN	01665.100	

1665 10.9

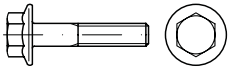

Sechskantschrauben mit Flansch, schwere Reihe

Maße → TI-17 Anziehmomente → TI-244
 Werkstoffeigensch. → TI-232 Normumstellung → TI-6

Rostfrei → S. 521

EN 1665 → ersetzt DIN 6921

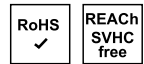

M 5	x	10	S	500	28,50
M 5	x	12	S	500	29,50
M 5	x	16	S	500	30,50
M 5	x	20	S	500	31,00
M 6	x	12	S	500	36,00
M 6	x	16	S	500	23,30
M 6	x	20	S	500	24,00
M 6	x	25	S	500	24,90
M 6	x	30	S	500	26,00
M 8	x	10	S	200	56,00
M 8	x	12	S	200	55,00
M 8	x	16	S	200	53,00
M 8	x	20	S	200	44,50
M 8	x	25	S	200	46,00
M 8	x	30	S	200	49,50
M 8	x	35	S	200	54,00
M 8	x	40	S	200	57,00
M 8	x	50	S	200	66,00
M 10	x	16	S	200	92,00
M 10	x	20	S	200	63,00
M 10	x	25	S	200	68,00
M 10	x	30	S	200	73,00
M 10	x	35	S	100	80,00
M 10	x	40	S	100	85,00
M 10	x	50	S	100	101,00
M 10	x	60	S	100	113,00
M 12	x	25	S	100	136,00
M 12	x	30	S	100	141,00
M 12	x	35	S	100	146,00
M 12	x	40	S	100	153,00
M 12	x	45	S	100	189,00
M 12	x	50	S	100	189,00
M 12	x	60	S	100	226,00
M 12	x	70	S	50	295,00
M 12	x	80	S	50	360,00
M 16	x	30	S	50	330,00
M 16	x	35	S	50	345,00
M 16	x	40	S	50	365,00
M 16	x	50	S	50	410,00
M 16	x	60	S	50	480,00
M 16	x	70	S	25	560,00

Abmessungen	VE Stück	€/100/Obf.
EN	01665.110	

1665 10.9 galvanisch verzinkt



Sechskantschrauben mit Flansch, schwere Reihe

getempert

Achtung! Warneinblender zu Wasserstoffversprödung beachten.

Maße → TI-17 Anziehmomente → TI-244
 Werkstoffeigensch. → TI-232 Normumstellung → TI-6
 Korrosionsschutz → TI-228

Rostfrei → S. 521

EN 1665 → ersetzt DIN 6921



M 5	x	10	S	500	37,00 gal Zn
M 5	x	12	S	500	38,00 gal Zn
M 5	x	16	S	500	40,00 gal Zn
M 5	x	20	S	500	40,00 gal Zn
M 6	x	12	S	500	45,50 gal Zn
M 6	x	16	S	500	33,00 gal Zn
M 6	x	20	S	500	34,00 gal Zn
M 6	x	25	S	500	34,50 gal Zn
M 6	x	30	S	500	35,50 gal Zn
M 8	x	10	S	200	66,00 gal Zn
M 8	x	16	S	200	66,00 gal Zn
M 8	x	20	S	200	57,00 gal Zn
M 8	x	25	S	200	59,00 gal Zn
M 8	x	30	S	200	62,00 gal Zn
M 8	x	35	S	200	69,00 gal Zn
M 8	x	40	S	200	69,00 gal Zn
M 8	x	50	S	200	78,00 gal Zn
M 10	x	16	S	200	108,00 gal Zn
M 10	x	20	S	200	82,00 gal Zn
M 10	x	25	S	200	88,00 gal Zn
M 10	x	30	S	200	91,00 gal Zn
M 10	x	40	S	200	103,00 gal Zn
M 10	x	50	S	100	120,00 gal Zn
M 10	x	60	S	100	134,00 gal Zn
M 12	x	25	S	100	160,00 gal Zn
M 12	x	30	S	100	165,00 gal Zn
M 12	x	35	S	100	176,00 gal Zn
M 12	x	40	S	100	183,00 gal Zn

Wichtiger Hinweis!

Bei galvanischen Überzügen auf hochfesten und federharten Teilen ($\geq 1000 \text{ N/mm}^2$ oder $\geq 320 \text{ HV}$) ist die Gefahr einer Wasserstoffversprödung (Sprödbruchgefahr) nicht mit Sicherheit auszuschließen (ISO 4042). Durch eine rechtzeitig eingeleitete thermische Nachbehandlung (Tempern) kann die Gefahr eines wasserstoffinduzierten Sprödbruchs im Regelfall verringert werden. Da aber ein Restrisiko nicht mit Sicherheit auszuschließen ist, erfolgen galvanische Überzüge auf derartigen Teilen nur auf ausdrücklichen Wunsch und auf Risiko des Auftraggebers.



Abmessungen	VE Stück	€/100/Obf.
M 12 x 45	S 100	226,00 gal Zn
M 12 x 50	S 100	226,00 gal Zn
M 12 x 60	S 100	265,00 gal Zn
M 12 x 70	S 50	395,00 gal Zn
M 12 x 80	S 50	395,00 gal Zn
M 16 x 35	S 50	390,00 gal Zn
M 16 x 40	S 50	410,00 gal Zn
M 16 x 50	S 50	450,00 gal Zn
M 16 x 60	S 50	530,00 gal Zn
M 16 x 70	S 25	560,00 gal Zn

DIN	01804.(*)
-----	-----------

1804 04 AU/14 H* Ausf. w



Nutmuttern, w = ungehärtet, ungeschliffen

(* < M16 = 04 AU = 400; ≥ M 16 = 14 H = 000)

Maße → TI-74 REACH → TI-262
 Werkstoffeigensch. → TI-233

Rostfrei → S. 522



M 8	x	1	S	10	590,00
M 10	x	1	S	10	630,00
M 12	x	1,5	S	10	660,00
M 14	x	1,5	S	10	730,00
M 16	x	1,5	S	10	760,00
M 18	x	1,5	S	10	790,00
M 20	x	1,5	S	10	830,00
M 22	x	1,5	S	10	890,00
M 24	x	1,5	S	10	950,00
M 26	x	1,5	S	10	1120,00
M 28	x	1,5	S	10	1280,00
M 30	x	1,5	S	10	1280,00
M 32	x	1,5	S	1	1480,00
M 35	x	1,5	S	1	1580,00
M 38	x	1,5	S	1	1700,00
M 40	x	1,5	S	1	1890,00
M 42	x	1,5	S	1	1890,00
M 45	x	1,5	S	1	2100,00
M 48	x	1,5	S	1	2600,00
M 50	x	1,5	S	1	2600,00
M 52	x	1,5	S	1	2950,00
M 55	x	1,5	S	1	2950,00
M 58	x	1,5	S	1	4100,00
M 60	x	1,5	S	1	4100,00
M 62	x	1,5	S	1	4600,00
M 65	x	1,5	S	1	4600,00
M 68	x	1,5	S	1	4700,00
M 70	x	1,5	S	1	4750,00
M 72	x	1,5	S	1	5600,00
M 75	x	1,5	S	1	5600,00
M 80	x	2	S	1	6300,00
M 85	x	2	S	1	7200,00
M 90	x	2	S	1	7900,00
M 95	x	2	S	1	7900,00
M 100	x	2	S	1	9400,00
M 110	x	2	S	1	10300,00
M 120	x	2	S	1	11500,00

Abmessungen	VE Stück	€/100/Obf.
DIN	01816.(*)	
1816	04 AU/14 H*	Ausf. w

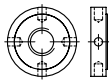

Kreuzlochmutter
w = ungehärtet, ungeschliffen
 (* < M16 = 04 AU = 400: ≥ M16 = 14 H = 000)

Maße → **TI-75** REACH → **TI-262**
 Werkstoffeigensch. → **TI-233**



M 12	x	1,5	S	10	660,00
M 16	x	1,5	S	10	760,00
M 18	x	1,5	S	10	790,00
M 20	x	1,5	S	10	830,00
M 22	x	1,5	S	10	890,00
M 24	x	1,5	S	10	950,00
M 26	x	1,5	S	10	1120,00
M 28	x	1,5	S	10	1280,00
M 30	x	1,5	S	10	1280,00
M 35	x	1,5	S	1	1580,00
M 40	x	1,5	S	1	1890,00
M 42	x	1,5	S	1	1890,00
M 45	x	1,5	S	1	2100,00
M 48	x	1,5	S	1	2600,00
M 50	x	1,5	S	1	2600,00
M 55	x	1,5	S	1	2950,00
M 60	x	1,5	S	1	4100,00
M 70	x	1,5	S	1	4750,00
M 75	x	1,5	S	1	5600,00
M 80	x	2	S	1	6300,00

ISO	02009.004
2009	Stahl blank gedreht

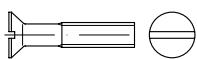

Senkschrauben mit Schlitz
 Maße → **TI-27** Normumstellung → **TI-11**
 Werkstoffeigensch. → **TI-232** REACH → **TI-262**
 Rostfrei → **S. 522**
 Messing, Kunststoff → **S. 634**
 ISO 2009 → ersetzt DIN 963



M 1,4	x	3	S	100	31,50 gedreht
M 1,4	x	5	S	100	33,50 gedreht
M 1,4	x	6	S	100	34,00 gedreht
M 1,4	x	8	S	100	35,50 gedreht
M 1,4	x	10	S	100	39,50 gedreht
M 1,6	x	3	S	100	29,00 gedreht
M 1,6	x	4	S	100	29,50 gedreht
M 1,6	x	5	S	100	30,50 gedreht
M 1,6	x	6	S	100	33,00 gedreht
M 1,6	x	8	S	100	35,50 gedreht
M 1,6	x	10	S	100	39,50 gedreht

Abmessungen	VE Stück	€/100/Obf.
M 1,6 x 12	S 100	42,50 gedreht
M 1,6 x 16	S 100	48,00 gedreht

ISO	02009.400
2009	4.8

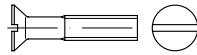

Senkschrauben mit Schlitz
 Maße → **TI-27** Normumstellung → **TI-11**
 Werkstoffeigensch. → **TI-232** REACH → **TI-262**
 Rostfrei → **S. 522**
 Messing, Kunststoff → **S. 634**
 ISO 2009 → ersetzt DIN 963



M 2	x	4	S	2000	5,90
M 2	x	5	S	2000	4,10
M 2	x	6	S	2000	2,85
M 2	x	8	S	2000	3,40
M 2	x	10	S	2000	2,70
M 2	x	12	S	2000	3,25
M 2	x	16	S	2000	4,60
M 2	x	20	S	2000	5,00
M 2,5	x	4	S	2000	5,40
M 2,5	x	5	S	2000	4,70
M 2,5	x	6	S	2000	2,85
M 2,5	x	8	S	2000	2,85
M 2,5	x	10	S	2000	3,00
M 2,5	x	12	S	2000	3,15
M 2,5	x	16	S	2000	3,65
M 3	x	4	S	2000	6,30
M 3	x	5	S	2000	4,60
M 3	x	6	S	2000	2,75
M 3	x	8	S	2000	1,35
M 3	x	10	S	2000	1,40
M 3	x	12	S	2000	1,40
M 3	x	16	S	2000	1,65
M 3	x	20	S	2000	2,00
M 3	x	25	S	2000	2,40
M 3	x	30	S	2000	2,80
M 3	x	40	S	1000	5,30
M 4	x	5	S	2000	7,70
M 4	x	6	S	2000	4,20
M 4	x	8	S	2000	1,95
M 4	x	10	S	2000	1,90
M 4	x	12	S	2000	1,95
M 4	x	16	S	2000	2,30
M 4	x	18	S	2000	3,45
M 4	x	20	S	2000	2,70
M 4	x	22	S	1000	4,45
M 4	x	25	S	1000	3,10
M 4	x	30	S	1000	3,70
M 4	x	35	S	1000	4,30
M 4	x	40	S	1000	5,00
M 4	x	45	S	1000	7,70
M 4	x	50	S	1000	7,90
M 4	x	60	S	500	11,80
M 5	x	6	S	2000	20,30
M 5	x	8	S	2000	7,90
M 5	x	10	S	2000	3,15
M 5	x	12	S	1000	3,15
M 5	x	16	S	1000	3,60
M 5	x	20	S	1000	3,90
M 5	x	25	S	1000	4,15
M 5	x	30	S	1000	5,50

M 5	x	35	S	500	6,20
M 5	x	40	S	500	6,70
M 5	x	45	S	500	7,80
M 5	x	50	S	500	8,90
M 6	x	10	S	1000	10,10
M 6	x	12	S	1000	4,55
M 6	x	16	S	1000	5,10
M 6	x	20	S	1000	5,60
M 6	x	25	S	500	6,30
M 6	x	30	S	500	7,30
M 6	x	35	S	500	8,50
M 6	x	40	S	500	9,50
M 6	x	45	S	500	11,10
M 6	x	50	S	200	12,60
M 6	x	55	S	200	16,80
M 6	x	60	S	200	15,00
M 6	x	65	S	200	19,20
M 6	x	70	S	200	19,20
M 6	x	80	S	200	27,00
M 6	x	100	S	200	36,50
M 8	x	10	S	500	45,50
M 8	x	12	S	500	40,00
M 8	x	16	S	500	11,70
M 8	x	18	S	500	19,20
M 8	x	20	S	500	12,90
M 8	x	25	S	500	13,60
M 8	x	30	S	200	15,50
M 8	x	35	S	200	17,50
M 8	x	40	S	200	24,50
M 8	x	45	S	200	26,00
M 8	x	50	S	200	27,00
M 8	x	55	S	200	40,00
M 8	x	60	S	200	36,00
M 8	x	70	S	200	41,00
M 8	x	80	S	100	46,00
M 8	x	100	S	100	66,00
M 10	x	16	S	200	28,00
M 10	x	20	S	200	22,20
M 10	x	25	S	200	24,00
M 10	x	30	S	200	26,00
M 10	x	35	S	200	28,50
M 10	x	40	S	200	30,00
M 10	x	45	S	100	34,50
M 10	x	50	S	100	39,50
M 10	x	55	S	100	88,00
M 10	x	60	S	100	48,00
M 10	x	70	S	100	60,00
M 10	x	80	S	100	74,00
M 10	x	90	S	100	82,00
M 10	x	100	S	100	91,00
M 12	x	20	S	200	265,00
M 12	x	25	S	200	245,00
M 12	x	30	S	200	204,00
M 12	x	35	S	100	215,00
M 12	x	40	S	100	222,00
M 12	x	45	S	100	241,00
M 12	x	50	S	100	265,00
M 12	x	60	S	50	380,00
M 12	x	70	S	50	445,00
M 12	x	80	S	50	495,00
M 12	x	90	S	50	540,00
M 16	x	30	S	50	380,00
M 16	x	35	S	50	395,00
M 16	x	40	S	50	420,00
M 16	x	45	S	50	430,00
M 16	x	50	S	50	455,00
M 16	x	55	S	50	530,00
M 16	x	60	S	50	485,00
M 16	x	70	S	25	580,00
M 16	x	80	S	25	750,00
M 16	x	90	S	25	850,00
M 20	x	35	S	25	1600,00
M 20	x	40	S	25	1660,00
M 20	x	50	S	25	1750,00
M 20	x	60	S	25	1950,00

Abmessungen	VE	Stück	€/100/Obf.
M 20 x 70	S	25	2060,00
M 20 x 80	S	25	2180,00

ISO	02009.410
2009	4.8 galvanisch verzinkt

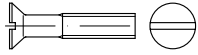

Senkschrauben mit Schlitz

Maße → **TI-27** Normumstellung → **TI-11**
 Werkstoffeigensch. → **TI-232** REACH → **TI-262**
 Korrosionsschutz → **TI-228**

Rostfrei → **S. 522**
 Messing, Kunststoff → **S. 634**

ISO 2009 → ersetzt DIN 963



M 2 x 4	S	2000	6,60 gal Zn
M 2 x 4	K	200	9,50 gal Zn
M 2 x 5	S	2000	4,40 gal Zn
M 2 x 5	K	200	7,30 gal Zn
M 2 x 6	S	2000	3,30 gal Zn
M 2 x 6	K	200	6,20 gal Zn
M 2 x 8	S	2000	2,85 gal Zn
M 2 x 8	K	200	5,70 gal Zn
M 2 x 10	S	2000	2,90 gal Zn
M 2 x 10	K	200	5,90 gal Zn
M 2 x 12	S	2000	3,55 gal Zn
M 2 x 12	K	200	6,50 gal Zn
M 2 x 16	S	2000	5,30 gal Zn
M 2 x 16	K	200	8,20 gal Zn
M 2 x 20	S	2000	5,60 gal Zn
M 2 x 20	K	200	8,50 gal Zn
M 2,5 x 4	S	2000	4,80 gal Zn
M 2,5 x 4	K	200	9,10 gal Zn
M 2,5 x 5	S	2000	5,30 gal Zn
M 2,5 x 5	K	200	8,20 gal Zn
M 2,5 x 6	S	2000	2,70 gal Zn
M 2,5 x 6	K	200	5,60 gal Zn
M 2,5 x 8	S	2000	3,30 gal Zn
M 2,5 x 8	K	200	6,20 gal Zn
M 2,5 x 10	S	2000	3,30 gal Zn
M 2,5 x 10	K	200	6,20 gal Zn
M 2,5 x 12	S	2000	3,55 gal Zn
M 2,5 x 12	K	200	6,50 gal Zn
M 2,5 x 16	S	2000	4,00 gal Zn
M 2,5 x 16	K	200	6,90 gal Zn
M 2,5 x 20	S	2000	4,85 gal Zn
M 2,5 x 20	K	200	7,80 gal Zn
M 2,5 x 25	K	200	8,80 gal Zn
M 2,5 x 30	K	200	12,90 gal Zn
M 3 x 4	S	2000	7,10 gal Zn
M 3 x 4	K	200	10,00 gal Zn
M 3 x 5	S	2000	5,10 gal Zn
M 3 x 5	K	200	8,20 gal Zn
M 3 x 6	S	1000	17,80 gal Zn
M 3 x 6	K	200	5,90 gal Zn
M 3 x 8	S	2000	1,50 gal Zn
M 3 x 8	K	200	4,45 gal Zn
M 3 x 10	S	1000	11,80 gal Zn
M 3 x 10	K	200	4,45 gal Zn
M 3 x 12	S	2000	1,55 gal Zn
M 3 x 12	K	200	4,55 gal Zn
M 3 x 14	S	2000	1,70 gal Zn
M 3 x 14	K	200	4,60 gal Zn
M 3 x 16	S	2000	1,85 gal Zn

Abmessungen	VE	Stück	€/100/Obf.
M 3 x 16	K	200	4,75 gal Zn
M 3 x 18	S	2000	3,35 gal Zn
M 3 x 18	K	200	6,30 gal Zn
M 3 x 20	S	2000	2,25 gal Zn
M 3 x 20	K	200	5,20 gal Zn
M 3 x 25	S	2000	2,70 gal Zn
M 3 x 25	K	200	5,60 gal Zn
M 3 x 30	S	2000	3,10 gal Zn
M 3 x 30	K	200	3,10 gal Zn
M 3 x 35	S	2000	5,30 gal Zn
M 3 x 35	K	200	8,20 gal Zn
M 3 x 40	K	200	8,80 gal Zn
M 3 x 45	K	200	12,60 gal Zn
M 3 x 50	K	200	13,80 gal Zn
M 3 x 55	S	1000	21,20 gal Zn
M 3 x 60	K	200	20,50 gal Zn
M 4 x 5	S	2000	8,40 gal Zn
M 4 x 5	K	200	11,30 gal Zn
M 4 x 6	S	2000	4,60 gal Zn
M 4 x 6	K	200	7,70 gal Zn
M 4 x 8	S	2000	2,20 gal Zn
M 4 x 8	K	200	5,10 gal Zn
M 4 x 10	S	2000	2,15 gal Zn
M 4 x 10	K	200	5,00 gal Zn
M 4 x 12	S	2000	2,20 gal Zn
M 4 x 12	K	200	5,10 gal Zn
M 4 x 16	S	2000	2,50 gal Zn
M 4 x 16	K	200	5,40 gal Zn
M 4 x 18	K	200	6,80 gal Zn
M 4 x 20	S	2000	2,90 gal Zn
M 4 x 20	K	200	5,90 gal Zn
M 4 x 22	S	1000	4,95 gal Zn
M 4 x 22	K	200	7,90 gal Zn
M 4 x 25	S	1000	3,40 gal Zn
M 4 x 25	K	200	6,30 gal Zn
M 4 x 30	S	1000	4,15 gal Zn
M 4 x 30	K	200	7,20 gal Zn
M 4 x 35	S	1000	4,80 gal Zn
M 4 x 35	K	200	7,80 gal Zn
M 4 x 40	S	1000	5,50 gal Zn
M 4 x 40	K	200	8,50 gal Zn
M 4 x 45	S	1000	8,40 gal Zn
M 4 x 45	K	200	11,30 gal Zn
M 4 x 50	S	1000	8,80 gal Zn
M 4 x 50	K	200	11,70 gal Zn
M 4 x 55	K	200	17,10 gal Zn
M 4 x 60	S	500	13,10 gal Zn
M 4 x 60	K	200	16,00 gal Zn
M 4 x 65	S	200	25,50 gal Zn
M 4 x 70	K	100	27,00 gal Zn
M 4 x 80	K	100	34,00 gal Zn
M 4 x 90	K	100	56,00 gal Zn
M 4 x 100	K	100	60,00 gal Zn
M 5 x 6	S	2000	22,20 gal Zn
M 5 x 6	K	200	25,50 gal Zn
M 5 x 8	S	2000	8,80 gal Zn
M 5 x 8	K	200	11,70 gal Zn
M 5 x 10	S	2000	3,45 gal Zn
M 5 x 10	K	200	6,50 gal Zn
M 5 x 12	S	1000	3,45 gal Zn
M 5 x 12	K	200	6,50 gal Zn
M 5 x 14	S	1000	8,50 gal Zn
M 5 x 16	S	1000	3,90 gal Zn
M 5 x 16	K	200	6,80 gal Zn
M 5 x 18	K	200	8,60 gal Zn
M 5 x 20	S	1000	4,25 gal Zn
M 5 x 20	K	200	7,30 gal Zn
M 5 x 22	K	200	10,50 gal Zn
M 5 x 25	S	1000	4,55 gal Zn
M 5 x 25	K	200	7,60 gal Zn
M 5 x 30	S	1000	6,20 gal Zn
M 5 x 30	K	200	9,10 gal Zn
M 5 x 35	S	500	6,80 gal Zn
M 5 x 35	K	200	9,70 gal Zn
M 5 x 40	S	500	7,30 gal Zn

Abmessungen	VE	Stück	€/100/Obf.
M 5 x 40	K	200	10,30 gal Zn
M 5 x 45	S	500	8,60 gal Zn
M 5 x 45	K	200	11,50 gal Zn
M 5 x 50	S	500	9,90 gal Zn
M 5 x 50	K	200	12,80 gal Zn
M 5 x 55	K	200	21,00 gal Zn
M 5 x 60	K	200	21,50 gal Zn
M 5 x 70	S	200	22,40 gal Zn
M 5 x 70	K	100	28,50 gal Zn
M 5 x 80	S	200	25,50 gal Zn
M 5 x 80	K	100	31,00 gal Zn
M 5 x 90	K	100	59,00 gal Zn
M 5 x 100	K	100	65,00 gal Zn
M 6 x 8	S	1000	14,70 gal Zn
M 6 x 8	K	200	17,60 gal Zn
M 6 x 10	S	1000	45,00 gal Zn
M 6 x 10	K	200	14,10 gal Zn
M 6 x 12	S	1000	5,00 gal Zn
M 6 x 12	K	200	7,90 gal Zn
M 6 x 14	S	1000	8,60 gal Zn
M 6 x 16	S	1000	5,70 gal Zn
M 6 x 16	K	200	8,60 gal Zn
M 6 x 18	K	200	12,00 gal Zn
M 6 x 20	S	1000	6,20 gal Zn
M 6 x 20	K	200	9,10 gal Zn
M 6 x 22	K	200	14,10 gal Zn
M 6 x 25	S	500	7,10 gal Zn
M 6 x 25	K	200	10,00 gal Zn
M 6 x 30	S	500	8,20 gal Zn
M 6 x 30	K	200	11,10 gal Zn
M 6 x 35	S	500	9,40 gal Zn
M 6 x 35	K	200	12,30 gal Zn
M 6 x 40	S	500	10,50 gal Zn
M 6 x 40	K	200	13,40 gal Zn
M 6 x 45	S	500	12,30 gal Zn
M 6 x 45	K	200	18,10 gal Zn
M 6 x 50	K	200	19,70 gal Zn
M 6 x 55	K	100	21,30 gal Zn
M 6 x 60	S	200	16,60 gal Zn
M 6 x 60	K	100	22,40 gal Zn
M 6 x 70	S	200	21,00 gal Zn
M 6 x 70	K	100	33,00 gal Zn
M 6 x 80	S	200	30,00 gal Zn
M 6 x 80	K	100	41,50 gal Zn
M 6 x 90	S	200	37,00 gal Zn
M 6 x 90	K	100	48,50 gal Zn
M 6 x 100	S	200	40,00 gal Zn
M 6 x 100	K	100	52,00 gal Zn
M 8 x 10	K	100	54,00 gal Zn
M 8 x 12	S	500	44,50 gal Zn
M 8 x 12	K	100	47,00 gal Zn
M 8 x 16	S	500	13,00 gal Zn
M 8 x 16	K	100	15,90 gal Zn
M 8 x 18	S	500	21,00 gal Zn
M 8 x 20	S	500	14,20 gal Zn
M 8 x 20	K	100	17,10 gal Zn
M 8 x 25	S	500	15,00 gal Zn
M 8 x 25	K	100	21,00 gal Zn
M 8 x 30	S	200	17,10 gal Zn
M 8 x 30	K	100	22,90 gal Zn
M 8 x 35	S	200	19,30 gal Zn
M 8 x 35	K	100	25,50 gal Zn
M 8 x 40	K	100	30,00 gal Zn
M 8 x 45	K	100	31,50 gal Zn
M 8 x 50	K	100	33,00 gal Zn
M 8 x 55	K	100	47,00 gal Zn
M 8 x 60	K	100	42,50 gal Zn
M 8 x 70	K	100	47,50 gal Zn
M 8 x 80	K	100	54,00 gal Zn
M 8 x 90	K	100	73,00 gal Zn
M 8 x 100	K	100	76,00 gal Zn
M 10 x 16	K	100	34,00 gal Zn
M 10 x 18	K	100	41,50 gal Zn
M 10 x 20	K	100	27,50 gal Zn
M 10 x 25	K	100	29,00 gal Zn

Abmessungen	VE	Stück	€/100/Obf.
M 10 x 30	K	100	31,50 gal Zn
M 10 x 35	K	100	34,00 gal Zn
M 10 x 40	K	100	36,00 gal Zn
M 10 x 45	K	100	46,00 gal Zn
M 10 x 50	K	100	41,50 gal Zn
M 10 x 55	K	100	62,00 gal Zn
M 10 x 60	K	100	48,00 gal Zn
M 10 x 70	K	100	63,00 gal Zn
M 10 x 80	K	100	69,00 gal Zn
M 10 x 90	K	100	92,00 gal Zn
M 10 x 100	K	100	103,00 gal Zn
M 12 x 20	K	100	295,00 gal Zn
M 12 x 25	K	100	275,00 gal Zn
M 12 x 30	K	100	227,00 gal Zn
M 12 x 35	K	100	239,00 gal Zn
M 12 x 40	K	100	249,00 gal Zn
M 12 x 45	K	100	270,00 gal Zn
M 12 x 50	K	100	295,00 gal Zn
M 12 x 55	K	50	395,00 gal Zn
M 12 x 60	K	50	425,00 gal Zn
M 12 x 70	K	50	500,00 gal Zn
M 12 x 80	K	50	550,00 gal Zn
M 12 x 90	K	50	600,00 gal Zn
M 12 x 100	K	50	660,00 gal Zn
M 16 x 30	K	50	420,00 gal Zn
M 16 x 35	K	50	430,00 gal Zn
M 16 x 40	K	50	460,00 gal Zn
M 16 x 45	K	50	475,00 gal Zn
M 16 x 50	K	50	500,00 gal Zn
M 16 x 55	K	50	590,00 gal Zn
M 16 x 60	K	50	540,00 gal Zn
M 16 x 70	K	25	620,00 gal Zn
M 16 x 80	K	25	660,00 gal Zn
M 16 x 90	K	25	720,00 gal Zn
M 20 x 40	K	25	1810,00 gal Zn
M 20 x 45	K	25	1840,00 gal Zn
M 20 x 50	K	25	1920,00 gal Zn
M 20 x 60	K	25	2110,00 gal Zn
M 20 x 70	K	25	2180,00 gal Zn

ISO 02010.400

2010 4.8

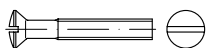

Linsensenschrauben mit Schlitz

Maße → TI-39 Normumstellung → TI-11
 Werkstoffeigensch. → TI-232 REACH → TI-262

Rostfrei → S. 524
 Messing → S. 635

ISO 2010 → ersetzt DIN 964



M 2,5 x 6	S	2000	3,35
M 2,5 x 8	S	2000	3,35
M 4 x 8	S	2000	2,00
M 4 x 10	S	2000	1,95
M 4 x 12	S	2000	2,00
M 4 x 16	S	2000	2,40
M 4 x 20	S	2000	2,80
M 5 x 25	S	1000	4,80
M 5 x 30	S	1000	6,80
M 5 x 35	S	500	6,50

Abmessungen VE Stück €/100/Obf.

ISO 02010.410

2010 4.8
galvanisch verzinkt



Linsensenschrauben mit Schlitz

Maße → TI-39 Normumstellung → TI-11
 Werkstoffeigensch. → TI-232 REACH → TI-262
 Korrosionsschutz → TI-228

Rostfrei → S. 524
 Messing → S. 635

ISO 2010 → ersetzt DIN 964



M 3 x 5	K	200	9,40 gal Zn
M 3 x 6	K	200	7,40 gal Zn
M 3 x 8	S	2000	2,15 gal Zn
M 3 x 8	K	200	5,00 gal Zn
M 3 x 10	S	2000	1,70 gal Zn
M 3 x 10	K	200	4,60 gal Zn
M 3 x 12	K	200	4,95 gal Zn
M 3 x 16	K	200	5,50 gal Zn
M 3 x 20	S	2000	3,10 gal Zn
M 3 x 20	K	200	6,00 gal Zn
M 3 x 25	S	2000	3,65 gal Zn
M 3 x 25	K	200	6,60 gal Zn
M 3 x 30	K	200	7,30 gal Zn
M 3 x 35	K	200	9,10 gal Zn
M 3 x 40	K	200	9,90 gal Zn
M 4 x 8	S	2000	2,25 gal Zn
M 4 x 8	K	200	5,30 gal Zn
M 4 x 10	S	2000	2,20 gal Zn
M 4 x 10	K	200	5,10 gal Zn
M 4 x 12	S	2000	2,25 gal Zn
M 4 x 12	K	200	5,30 gal Zn
M 4 x 16	S	2000	2,70 gal Zn
M 4 x 16	K	200	5,60 gal Zn
M 4 x 20	S	2000	3,15 gal Zn
M 4 x 20	K	200	6,10 gal Zn
M 4 x 25	K	200	6,70 gal Zn
M 4 x 30	K	200	7,40 gal Zn
M 4 x 35	K	200	8,20 gal Zn
M 4 x 40	K	200	10,10 gal Zn
M 4 x 45	K	200	11,50 gal Zn
M 4 x 50	K	200	12,30 gal Zn
M 4 x 60	K	200	14,70 gal Zn
M 4 x 70	K	100	23,90 gal Zn
M 4 x 80	K	100	31,50 gal Zn
M 5 x 8	K	200	9,90 gal Zn
M 5 x 10	S	2000	4,20 gal Zn
M 5 x 10	K	200	7,20 gal Zn
M 5 x 12	K	200	6,70 gal Zn
M 5 x 16	S	1000	4,15 gal Zn
M 5 x 16	K	200	7,10 gal Zn
M 5 x 20	K	200	7,60 gal Zn
M 5 x 25	K	200	8,20 gal Zn
M 5 x 30	S	1000	7,40 gal Zn
M 5 x 30	K	200	10,30 gal Zn
M 5 x 35	K	200	10,20 gal Zn
M 5 x 40	S	500	7,90 gal Zn
M 5 x 40	K	200	10,80 gal Zn
M 5 x 45	K	200	14,10 gal Zn
M 5 x 50	K	200	13,60 gal Zn
M 5 x 60	K	200	22,20 gal Zn
M 5 x 80	K	100	29,00 gal Zn
M 6 x 8	K	200	19,30 gal Zn

Abmessungen VE Stück €/100/Obf.

M 6 x 10	K	200	14,20 gal Zn
M 6 x 12	K	200	9,40 gal Zn
M 6 x 16	S	1000	6,20 gal Zn
M 6 x 16	K	200	9,10 gal Zn
M 6 x 20	S	1000	6,70 gal Zn
M 6 x 20	K	200	9,60 gal Zn
M 6 x 25	S	500	7,70 gal Zn
M 6 x 25	K	200	10,60 gal Zn
M 6 x 30	K	200	11,70 gal Zn
M 6 x 35	K	200	13,10 gal Zn
M 6 x 40	K	200	14,20 gal Zn
M 6 x 45	K	200	19,00 gal Zn
M 6 x 50	K	200	23,90 gal Zn
M 6 x 55	K	200	27,00 gal Zn
M 6 x 60	K	100	27,00 gal Zn
M 6 x 70	K	100	38,50 gal Zn
M 6 x 80	K	100	44,00 gal Zn
M 8 x 16	K	100	20,90 gal Zn
M 8 x 20	K	100	20,10 gal Zn
M 8 x 25	K	100	25,00 gal Zn
M 8 x 30	K	100	28,00 gal Zn
M 8 x 35	K	100	33,00 gal Zn
M 8 x 40	K	100	44,50 gal Zn
M 8 x 45	K	100	41,50 gal Zn
M 8 x 50	K	100	42,50 gal Zn
M 8 x 60	K	100	43,00 gal Zn
M 10 x 20	K	100	42,00 gal Zn
M 10 x 25	K	100	43,00 gal Zn
M 10 x 30	K	100	45,00 gal Zn
M 10 x 35	K	100	54,00 gal Zn
M 10 x 40	K	100	57,00 gal Zn
M 10 x 50	K	100	63,00 gal Zn

DIN 02093.000

2093 Federstahl

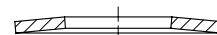

Tellerfedern

Produktinformation → TI-141

Rostfrei → S. 525

DIN 2093 → wird ersetzt durch ISO 16983



Außen Ø x Innen Ø x Dicke

8 x 3,2 x 0,3	S	200	12,90
8 x 3,2 x 0,4	S	200	13,20
8 x 3,2 x 0,5	S	200	13,60
8 x 4,2 x 0,2	S	200	11,10
8 x 4,2 x 0,3	S	200	12,90
8 x 4,2 x 0,4	S	200	13,20
10 x 3,2 x 0,3	S	200	13,70
10 x 3,2 x 0,4	S	200	14,20
10 x 3,2 x 0,5	S	200	14,30
10 x 4,2 x 0,4	S	200	14,20
10 x 4,2 x 0,5	S	200	14,30
10 x 4,2 x 0,6	S	200	14,30
10 x 5,2 x 0,25	S	200	13,60
10 x 5,2 x 0,4	S	200	14,20
10 x 5,2 x 0,5	S	200	14,30
12 x 4,2 x 0,4	S	200	15,40
12 x 4,2 x 0,5	S	200	15,50
12 x 4,2 x 0,6	S	200	15,70
12 x 5,2 x 0,5	S	200	15,50
12 x 5,2 x 0,6	S	200	15,70
12 x 6,2 x 0,5	S	200	15,50

Abmessungen	VE	Stück	€/100/bf.	Abmessungen	VE	Stück	€/100/bf.	Abmessungen	VE	Stück	€/100/bf.			
12	x	6,2 x 0,6	S 200	15,70	34	x	12,3 x 1,25	S 100	73,00	80	x	36,0 x 3,0	S 100	570,00
12,5	x	6,2 x 0,35	S 200	15,30	34	x	12,3 x 1,5	S 100	83,00	80	x	41,0 x 3,0	S 100	570,00
12,5	x	6,2 x 0,5	S 200	15,50	34	x	14,3 x 1,25	S 100	73,00	80	x	41,0 x 4,0	S 50	840,00
12,5	x	6,2 x 0,7	S 200	16,30	34	x	14,3 x 1,5	S 100	83,00	80	x	41,0 x 5,0	S 50	1010,00
14	x	7,2 x 0,35	S 200	16,00	34	x	16,3 x 1,5	S 100	83,00	90	x	46,0 x 2,5	S 10	670,00
14	x	7,2 x 0,5	S 200	16,10	34	x	16,3 x 2,0	S 100	91,00	90	x	46,0 x 3,5	S 10	790,00
14	x	7,2 x 0,8	S 200	17,50	35,5	x	18,3 x 0,9	S 100	36,50	90	x	46,0 x 5,0	S 10	1180,00
15	x	5,2 x 0,4	S 200	16,10	35,5	x	18,3 x 1,25	S 100	72,00	100	x	41,0 x 4,0	S 10	1180,00
15	x	5,2 x 0,5	S 200	16,60	35,5	x	18,3 x 2,0	S 100	99,00	100	x	41,0 x 5,0	S 10	1480,00
15	x	5,2 x 0,6	S 200	17,00	40	x	14,3 x 1,25	S 100	102,00	100	x	51,0 x 2,7	S 10	850,00
15	x	5,2 x 0,7	S 200	17,10	40	x	14,3 x 1,5	S 100	111,00	100	x	51,0 x 3,5	S 10	950,00
15	x	6,2 x 0,5	S 200	16,60	40	x	14,3 x 1,75	S 100	115,00	100	x	51,0 x 4,0	S 10	1180,00
15	x	6,2 x 0,6	S 200	17,00	40	x	14,3 x 2,0	S 100	117,00	100	x	51,0 x 5,0	S 10	1480,00
15	x	6,2 x 0,7	S 200	17,10	40	x	16,3 x 1,5	S 100	111,00	100	x	51,0 x 6,0	S 1	1900,00
15	x	8,2 x 0,7	S 200	17,10	40	x	16,3 x 1,75	S 100	115,00	100	x	51,0 x 7,0	S 1	2700,00
15	x	8,2 x 0,8	S 200	17,70	40	x	16,3 x 2,0	S 100	117,00	112	x	57,0 x 3,0	S 1	1320,00
16	x	8,2 x 0,4	S 200	16,60	40	x	18,3 x 2,0	S 100	117,00	112	x	57,0 x 4,0	S 1	1520,00
16	x	8,2 x 0,6	S 200	17,20	40	x	20,4 x 1,0	S 100	53,00	112	x	57,0 x 6,0	S 1	2100,00
16	x	8,2 x 0,9	S 200	18,70	40	x	20,4 x 1,5	S 100	111,00	125	x	51,0 x 4,0	S 1	1800,00
18	x	6,2 x 0,4	S 200	17,40	40	x	20,4 x 2,0	S 100	117,00	125	x	51,0 x 5,0	S 1	2070,00
18	x	6,2 x 0,5	S 200	17,60	40	x	20,4 x 2,25	S 100	130,00	125	x	51,0 x 6,0	S 1	2900,00
18	x	6,2 x 0,6	S 200	18,00	40	x	20,4 x 2,5	S 100	141,00	125	x	61,0 x 5,0	S 1	2070,00
18	x	6,2 x 0,7	S 200	18,10	45	x	22,4 x 1,25	S 200	136,00	125	x	61,0 x 6,0	S 1	2900,00
18	x	6,2 x 0,8	S 200	18,70	45	x	22,4 x 1,75	S 200	152,00	125	x	61,0 x 8,0	S 1	4100,00
18	x	8,2 x 0,7	S 200	18,10	45	x	22,4 x 2,5	S 200	166,00	125	x	64,0 x 3,5	S 1	1540,00
18	x	8,2 x 0,8	S 200	18,70	46,5	x	30,5 x 0,6	S 100	128,00	125	x	64,0 x 5,0	S 1	2070,00
18	x	8,2 x 1,0	S 200	20,60	48	x	16,3 x 1,5	S 100	147,00	125	x	64,0 x 6,0	S 1	2900,00
18	x	9,2 x 0,45	S 200	17,40	50	x	18,4 x 1,25	S 100	144,00	125	x	64,0 x 7,0	S 1	3800,00
18	x	9,2 x 0,7	S 200	18,10	50	x	18,4 x 1,5	S 100	151,00	125	x	64,0 x 8,0	S 1	4100,00
18	x	9,2 x 1,0	S 200	20,60	50	x	18,4 x 2,0	S 100	181,00	125	x	71,0 x 6,0	S 1	2900,00
20	x	8,2 x 0,5	S 200	18,60	50	x	18,4 x 2,5	S 100	210,00	125	x	71,0 x 8,0	S 1	4100,00
20	x	8,2 x 0,6	S 200	18,80	50	x	18,4 x 3,0	S 100	244,00	125	x	71,0 x 10,0	S 1	4700,00
20	x	8,2 x 0,7	S 200	19,30	50	x	20,4 x 2,0	S 100	181,00	140	x	72,0 x 3,8	S 1	2270,00
20	x	8,2 x 0,8	S 200	19,70	50	x	20,4 x 2,5	S 100	210,00	140	x	72,0 x 5,0	S 1	2950,00
20	x	8,2 x 0,9	S 200	20,00	50	x	22,4 x 2,0	S 100	181,00	140	x	72,0 x 8,0	S 1	5100,00
20	x	8,2 x 1,0	S 200	22,10	50	x	22,4 x 2,5	S 100	210,00	150	x	61,0 x 5,0	S 1	3250,00
20	x	10,2 x 0,4	S 200	18,20	50	x	25,4 x 1,25	S 100	144,00	150	x	61,0 x 6,0	S 1	4300,00
20	x	10,2 x 0,5	S 200	18,60	50	x	25,4 x 1,5	S 100	135,00	150	x	61,0 x 7,0	S 1	5200,00
20	x	10,2 x 0,8	S 200	19,70	50	x	25,4 x 2,0	S 100	181,00	150	x	71,0 x 6,0	S 1	4300,00
20	x	10,2 x 0,9	S 200	20,00	50	x	25,4 x 2,25	S 100	194,00	150	x	71,0 x 8,0	S 1	5800,00
20	x	10,2 x 1,0	S 200	22,10	50	x	25,4 x 2,5	S 100	210,00	150	x	81,0 x 8,0	S 1	5800,00
20	x	10,2 x 1,1	S 200	23,20	50	x	25,4 x 3,0	S 100	244,00	150	x	81,0 x 10,0	S 1	6500,00
22,5	x	11,2 x 0,6	S 200	19,40	56	x	28,5 x 1,5	S 100	183,00	160	x	82,0 x 4,3	S 1	3950,00
22,5	x	11,2 x 0,8	S 200	21,20	56	x	28,5 x 2,0	S 100	212,00	160	x	82,0 x 6,0	S 1	4750,00
22,5	x	11,2 x 1,25	S 200	52,00	56	x	28,5 x 2,5	S 100	260,00	160	x	82,0 x 10,0	S 5	6800,00
23	x	8,2 x 0,7	S 200	20,00	56	x	28,5 x 3,0	S 100	300,00	160	x	82,0 x 11,0	S 1	6800,00
23	x	8,2 x 0,8	S 200	21,60	60	x	20,5 x 2,0	S 100	241,00	180	x	92,0 x 4,8	S 1	5400,00
23	x	8,2 x 0,9	S 200	22,10	60	x	20,5 x 2,5	S 100	280,00	180	x	92,0 x 6,0	S 1	5700,00
23	x	10,2 x 0,9	S 200	22,10	60	x	20,5 x 3,0	S 100	330,00	180	x	92,0 x 10,0	S 1	8600,00
23	x	10,2 x 1,0	S 200	26,00	60	x	25,5 x 2,5	S 100	280,00	180	x	92,0 x 13,0	S 1	10500,00
23	x	12,2 x 1,0	S 200	26,00	60	x	25,5 x 3,0	S 100	330,00	200	x	82,0 x 8,0	S 1	9400,00
23	x	12,2 x 1,25	S 200	52,00	60	x	30,5 x 2,5	S 100	280,00	200	x	82,0 x 10,0	S 1	10500,00
23	x	12,2 x 1,5	S 200	56,00	60	x	30,5 x 2,75	S 100	305,00	200	x	82,0 x 12,0	S 1	11800,00
25	x	12,2 x 0,7	S 200	22,10	60	x	30,5 x 3,0	S 100	330,00	200	x	92,0 x 10,0	S 1	10500,00
25	x	12,2 x 0,9	S 200	24,00	60	x	30,5 x 3,5	S 100	370,00	200	x	92,0 x 12,0	S 1	11800,00
25	x	12,2 x 1,25	S 200	51,00	63	x	31,0 x 1,8	S 100	275,00	200	x	92,0 x 14,0	S 1	12800,00
25	x	12,2 x 1,5	S 200	59,00	63	x	31,0 x 2,5	S 100	295,00	200	x	102 x 5,5	S 1	7700,00
28	x	10,2 x 0,8	S 200	27,50	63	x	31,0 x 3,0	S 100	365,00	200	x	102 x 8,0	S 1	9400,00
28	x	10,2 x 1,0	S 200	29,00	63	x	31,0 x 3,5	S 100	395,00	200	x	102 x 10,0	S 1	10500,00
28	x	10,2 x 1,25	S 200	60,00	70	x	24,5 x 3,0	S 100	470,00	200	x	102 x 12,0	S 1	11800,00
28	x	10,2 x 1,5	S 200	65,00	70	x	24,5 x 3,5	S 100	540,00	200	x	102 x 14,0	S 1	12800,00
28	x	12,2 x 1,0	S 200	29,00	70	x	25,5 x 2,0	S 100	370,00	200	x	112 x 12,0	S 1	11800,00
28	x	12,2 x 1,25	S 200	60,00	70	x	30,5 x 2,5	S 100	395,00	200	x	112 x 14,0	S 1	12800,00
28	x	12,2 x 1,5	S 200	65,00	70	x	30,5 x 3,0	S 100	460,00	200	x	112 x 16,0	S 1	13800,00
28	x	14,2 x 0,8	S 200	27,50	70	x	35,5 x 3,0	S 100	460,00	225	x	112 x 6,5	S 1	11700,00
28	x	14,2 x 1,0	S 200	29,00	70	x	35,5 x 3,5	S 100	540,00	225	x	112 x 8,0	S 1	12000,00
28	x	14,2 x 1,25	S 200	60,00	70	x	35,5 x 4,0	S 100	670,00	225	x	112 x 12,0	S 1	15200,00
28	x	14,2 x 1,5	S 200	65,00	70	x	40,5 x 4,0	S 100	670,00	250	x	127 x 10,0	S 1	16700,00
31,5	x	16,3 x 0,8	S 100	31,00	70	x	40,5 x 5,0	S 100	840,00	250	x	127 x 14,0	S 1	20100,00
31,5	x	16,3 x 1,25	S 100	67,00	71	x	36,0 x 2,0	S 100	380,00					
31,5	x	16,3 x 1,5	S 100	72,00	71	x	36,0 x 2,5	S 100	420,00					
31,5	x	16,3 x 1,75	S 100	77,00	71	x	36,0 x 4,0	S 100	680,00					
31,5	x	16,3 x 2,0	S 100	85,00	80	x	30,5 x 2,5	S 100	510,00					
31,7	x	20,4 x 0,4	S 100	89,00	80	x	31,0 x 3,0	S 100	570,00					
34	x	12,3 x 1,0	S 100	34,00	80	x	31,0 x 4,0	S 100	840,00					

Abmessungen	VE Stück	€/100/Obf.
ISO 02338.000		
2338	Stahl	m6

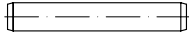

Zylinderstifte, Toleranzfeld m6

entspricht EN 22338

Maße → **TI-116** REACH → **TI-262**
 Normumstellung → **TI-10**

Rostfrei → **S. 525**

ISO 2338 → ersetzt DIN 7





∅ - Tol. x Länge (mit Kuppen)

1 m6 x 3	S 1000	9,40
1 m6 x 4	S 1000	9,40
1 m6 x 5	S 1000	9,40
1 m6 x 6	S 1000	9,40
1 m6 x 8	S 1000	9,40
1 m6 x 10	S 1000	9,40
1 m6 x 12	S 1000	9,50
1,5 m6 x 3	S 1000	9,40
1,5 m6 x 4	S 1000	9,40
1,5 m6 x 5	S 1000	9,40
1,5 m6 x 6	S 1000	9,40
1,5 m6 x 8	S 1000	9,50
1,5 m6 x 10	S 1000	9,50
1,5 m6 x 12	S 1000	9,70
1,5 m6 x 14	S 1000	9,70
1,5 m6 x 16	S 1000	10,10
1,5 m6 x 18	S 1000	10,20
1,5 m6 x 20	S 1000	10,50
2 m6 x 4	S 1000	9,10
2 m6 x 5	S 1000	9,50
2 m6 x 6	S 1000	9,70
2 m6 x 8	S 1000	9,70
2 m6 x 10	S 1000	9,70
2 m6 x 12	S 1000	10,10
2 m6 x 14	S 1000	10,10
2 m6 x 16	S 1000	10,20
2 m6 x 18	S 1000	10,50
2 m6 x 20	S 1000	11,10
2 m6 x 24	S 1000	11,70
2 m6 x 28	S 1000	13,10
2 m6 x 30	S 1000	13,40
2,5 m6 x 5	S 1000	9,70
2,5 m6 x 6	S 1000	9,70
2,5 m6 x 8	S 1000	10,10
2,5 m6 x 10	S 1000	10,10
2,5 m6 x 12	S 1000	10,20
2,5 m6 x 14	S 1000	10,50
2,5 m6 x 16	S 1000	10,70
2,5 m6 x 18	S 1000	11,10
2,5 m6 x 20	S 1000	11,30
2,5 m6 x 24	S 1000	11,80
2,5 m6 x 28	S 1000	13,10
2,5 m6 x 30	S 1000	13,50
2,5 m6 x 32	S 1000	13,60
3 m6 x 5	S 1000	6,70
3 m6 x 6	S 1000	6,70
3 m6 x 8	S 1000	6,80
3 m6 x 10	S 1000	7,20
3 m6 x 12	S 1000	7,60
3 m6 x 14	S 1000	7,80
3 m6 x 16	S 1000	7,90
3 m6 x 18	S 1000	10,20

3 m6 x 20	S 1000	10,60
3 m6 x 24	S 1000	12,10
3 m6 x 28	S 1000	13,10
3 m6 x 30	S 1000	13,40
3 m6 x 32	S 1000	13,60
3 m6 x 36	S 500	18,40
3 m6 x 40	S 500	20,10
3 m6 x 45	S 500	26,00
3 m6 x 50	S 500	27,50
4 m6 x 5	S 1000	10,80
4 m6 x 6	S 1000	10,80
4 m6 x 8	S 1000	11,30
4 m6 x 10	S 1000	11,70
4 m6 x 12	S 1000	12,10
4 m6 x 14	S 1000	12,80
4 m6 x 16	S 1000	13,40
4 m6 x 18	S 1000	13,80
4 m6 x 20	S 1000	14,70
4 m6 x 24	S 1000	15,80
4 m6 x 26	S 1000	16,10
4 m6 x 28	S 1000	16,40
4 m6 x 30	S 1000	17,00
4 m6 x 32	S 500	17,50
4 m6 x 36	S 500	18,40
4 m6 x 40	S 500	20,40
4 m6 x 45	S 500	26,00
4 m6 x 50	S 500	27,50
5 m6 x 5	S 500	23,40
5 m6 x 6	S 500	11,70
5 m6 x 8	S 500	12,10
5 m6 x 10	S 500	13,50
5 m6 x 12	S 500	14,10
5 m6 x 14	S 500	15,00
5 m6 x 16	S 500	15,40
5 m6 x 18	S 500	16,00
5 m6 x 20	S 500	17,10
5 m6 x 22	S 500	17,60
5 m6 x 24	S 500	18,00
5 m6 x 28	S 500	19,20
5 m6 x 30	S 500	20,60
5 m6 x 32	S 500	21,20
5 m6 x 36	S 500	21,60
5 m6 x 40	S 500	24,20
5 m6 x 45	S 500	26,00
5 m6 x 50	S 500	27,50
5 m6 x 55	S 500	36,50
5 m6 x 60	S 500	41,00
6 m6 x 6	S 500	14,10
6 m6 x 8	S 500	14,70
6 m6 x 10	S 500	15,70
6 m6 x 12	S 500	17,00
6 m6 x 14	S 500	18,00
6 m6 x 16	S 500	18,80
6 m6 x 18	S 500	19,80
6 m6 x 20	S 500	20,40
6 m6 x 22	S 500	20,90
6 m6 x 24	S 500	22,40
6 m6 x 26	S 500	22,80
6 m6 x 28	S 500	23,00
6 m6 x 30	S 500	24,20
6 m6 x 32	S 500	25,50
6 m6 x 36	S 500	27,50
6 m6 x 40	S 500	29,50
6 m6 x 45	S 500	32,50
6 m6 x 50	S 500	34,00
6 m6 x 55	S 500	36,50
6 m6 x 60	S 200	41,00
6 m6 x 70	S 200	77,00
6 m6 x 80	S 200	89,00
6 m6 x 90	S 200	153,00
6 m6 x 100	S 200	177,00
8 m6 x 8	S 500	21,30
8 m6 x 10	S 500	22,40
8 m6 x 12	S 500	22,90
8 m6 x 14	S 500	25,00

8 m6 x 16	S 500	26,50
8 m6 x 18	S 500	29,50
8 m6 x 20	S 500	30,50
8 m6 x 22	S 500	41,50
8 m6 x 24	S 500	32,50
8 m6 x 26	S 500	39,00
8 m6 x 28	S 500	41,00
8 m6 x 30	S 500	44,00
8 m6 x 32	S 500	45,50
8 m6 x 36	S 200	47,00
8 m6 x 40	S 200	52,00
8 m6 x 45	S 200	56,00
8 m6 x 50	S 200	59,00
8 m6 x 55	S 200	63,00
8 m6 x 60	S 200	68,00
8 m6 x 70	S 200	77,00
8 m6 x 80	S 200	89,00
8 m6 x 90	S 200	153,00
8 m6 x 100	S 200	195,00
10 m6 x 10	S 200	36,50
10 m6 x 12	S 200	38,00
10 m6 x 14	S 200	39,50
10 m6 x 16	S 200	42,50
10 m6 x 18	S 200	44,50
10 m6 x 20	S 200	47,00
10 m6 x 24	S 200	52,00
10 m6 x 28	S 200	57,00
10 m6 x 30	S 200	59,00
10 m6 x 32	S 200	62,00
10 m6 x 36	S 200	67,00
10 m6 x 40	S 200	74,00
10 m6 x 45	S 200	78,00
10 m6 x 50	S 200	85,00
10 m6 x 55	S 200	91,00
10 m6 x 60	S 200	97,00
10 m6 x 65	S 50	113,00
10 m6 x 70	S 50	113,00
10 m6 x 80	S 50	131,00
10 m6 x 90	S 50	153,00
10 m6 x 100	S 50	177,00
10 m6 x 120	S 50	223,00
12 m6 x 12	S 200	59,00
12 m6 x 14	S 200	59,00
12 m6 x 16	S 200	60,00
12 m6 x 18	S 200	62,00
12 m6 x 20	S 200	66,00
12 m6 x 24	S 200	69,00
12 m6 x 28	S 200	82,00
12 m6 x 30	S 200	86,00
12 m6 x 32	S 200	94,00
12 m6 x 36	S 200	103,00
12 m6 x 40	S 200	111,00
12 m6 x 45	S 100	128,00
12 m6 x 50	S 100	137,00
12 m6 x 55	S 100	147,00
12 m6 x 60	S 100	154,00
12 m6 x 70	S 100	167,00
12 m6 x 80	S 100	183,00
12 m6 x 90	S 100	200,00
12 m6 x 100	S 100	224,00
12 m6 x 120	S 100	255,00
13 m6 x 14	S 50	91,00
13 m6 x 16	S 50	91,00
13 m6 x 18	S 50	91,00
13 m6 x 20	S 50	91,00
13 m6 x 24	S 50	106,00
13 m6 x 28	S 50	115,00
13 m6 x 30	S 50	125,00
13 m6 x 32	S 50	134,00
13 m6 x 36	S 50	141,00
13 m6 x 40	S 50	155,00
13 m6 x 45	S 25	175,00
13 m6 x 50	S 25	193,00
13 m6 x 55	S 25	201,00
13 m6 x 60	S 25	220,00

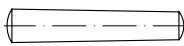
Abmessungen	VE	Stück	€/100/Obf.
13 m6 x 70	S	25	244,00
13 m6 x 80	S	25	285,00
13 m6 x 90	S	25	315,00
13 m6 x 100	S	25	335,00
13 m6 x 120	S	25	360,00
14 m6 x 20	S	25	99,00
14 m6 x 24	S	25	115,00
14 m6 x 28	S	25	121,00
14 m6 x 30	S	25	134,00
14 m6 x 32	S	25	143,00
14 m6 x 36	S	25	152,00
14 m6 x 40	S	25	165,00
14 m6 x 45	S	25	175,00
14 m6 x 50	S	25	200,00
14 m6 x 55	S	25	205,00
14 m6 x 60	S	25	220,00
14 m6 x 70	S	25	255,00
14 m6 x 80	S	25	285,00
14 m6 x 90	S	25	315,00
14 m6 x 100	S	25	335,00
14 m6 x 120	S	25	360,00
16 m6 x 20	S	25	135,00
16 m6 x 24	S	25	153,00
16 m6 x 28	S	25	165,00
16 m6 x 30	S	25	176,00
16 m6 x 32	S	25	187,00
16 m6 x 36	S	25	201,00
16 m6 x 40	S	25	217,00
16 m6 x 45	S	25	239,00
16 m6 x 50	S	25	255,00
16 m6 x 55	S	25	265,00
16 m6 x 60	S	25	295,00
16 m6 x 70	S	25	335,00
16 m6 x 80	S	25	380,00
16 m6 x 90	S	25	415,00
16 m6 x 100	S	25	455,00
16 m6 x 120	S	25	540,00
20 m6 x 24	S	25	275,00
20 m6 x 28	S	25	275,00
20 m6 x 30	S	25	300,00
20 m6 x 32	S	25	310,00
20 m6 x 36	S	25	335,00
20 m6 x 40	S	25	360,00
20 m6 x 45	S	25	385,00
20 m6 x 50	S	25	415,00
20 m6 x 55	S	25	430,00
20 m6 x 60	S	25	470,00
20 m6 x 70	S	25	510,00
20 m6 x 80	S	25	540,00
20 m6 x 90	S	25	620,00
20 m6 x 100	S	25	680,00
20 m6 x 120	S	25	790,00
25 m6 x 40	S	10	1070,00
25 m6 x 45	S	10	1070,00
25 m6 x 50	S	10	1150,00
25 m6 x 55	S	10	1410,00
25 m6 x 60	S	10	1410,00
25 m6 x 70	S	10	1580,00
25 m6 x 80	S	10	1800,00
25 m6 x 90	S	10	1930,00
25 m6 x 100	S	10	2100,00
25 m6 x 120	S	10	2440,00
30 m6 x 40	S	10	1930,00
30 m6 x 45	S	10	2160,00
30 m6 x 50	S	10	2160,00
30 m6 x 55	S	10	2440,00
30 m6 x 60	S	10	2440,00
30 m6 x 70	S	10	2650,00
30 m6 x 80	S	10	2800,00
30 m6 x 90	S	10	3150,00
30 m6 x 100	S	10	3600,00
30 m6 x 120	S	10	4250,00

Abmessungen	VE	Stück	€/100/Obf.
ISO 2339		02339.002	
2339		Stahl	Form B
			
Kegelstifte, Kegel 1:50, B = gedreht			
Maße → TI-117		REACH → TI-262	
Normumstellung → TI-10			
Rostfrei → S. 527			
ISO 2339 → ersetzt DIN 1			
			
Ø x Länge (mit Kuppen)			
B 1 x 12	S	200	12,10
B 1 x 14	S	200	12,40
B 1 x 16	S	200	13,10
B 1 x 18	S	200	13,40
B 1,5 x 10	S	200	17,10
B 1,5 x 12	S	200	18,20
B 1,5 x 14	S	200	18,60
B 1,5 x 16	S	200	19,70
B 1,5 x 18	S	200	20,10
B 1,5 x 20	S	200	13,70
B 1,5 x 22	S	100	15,50
B 1,5 x 24	S	100	15,80
B 1,5 x 26	S	100	16,60
B 1,5 x 28	S	100	17,40
B 1,5 x 30	S	100	17,70
B 2 x 10	S	100	12,40
B 2 x 12	S	100	13,10
B 2 x 14	S	100	13,40
B 2 x 16	S	100	31,50
B 2 x 18	S	100	14,30
B 2 x 20	S	100	14,70
B 2 x 22	S	100	15,50
B 2 x 24	S	100	15,80
B 2 x 26	S	100	16,40
B 2 x 28	S	100	17,40
B 2 x 30	S	100	17,70
B 2 x 32	S	100	18,40
B 2 x 36	S	100	19,50
B 2 x 40	S	100	20,60
B 2 x 45	S	100	22,30
B 2 x 50	S	100	24,00
B 2,5 x 10	S	100	14,10
B 2,5 x 12	S	100	14,20
B 2,5 x 14	S	100	15,20
B 2,5 x 16	S	100	15,40
B 2,5 x 18	S	100	16,50
B 2,5 x 20	S	100	17,00
B 2,5 x 22	S	100	17,20
B 2,5 x 24	S	100	26,50
B 2,5 x 26	S	100	19,00
B 2,5 x 28	S	100	19,80
B 2,5 x 30	S	100	20,40
B 2,5 x 32	S	100	22,00
B 2,5 x 36	S	100	23,30
B 2,5 x 40	S	100	25,00
B 2,5 x 45	S	100	26,00
B 2,5 x 50	S	100	26,50
B 2,5 x 55	S	100	37,00
B 2,5 x 60	S	100	38,50
B 3 x 10	S	100	14,20
B 3 x 12	S	100	14,60
B 3 x 14	S	100	15,40

Abmessungen	VE	Stück	€/100/Obf.
B 3 x 16	S	100	24,20
B 3 x 18	S	100	17,00
B 3 x 20	S	100	17,50
B 3 x 22	S	100	18,60
B 3 x 24	S	100	19,00
B 3 x 26	S	100	20,70
B 3 x 28	S	100	21,50
B 3 x 30	S	100	22,20
B 3 x 32	S	100	23,30
B 3 x 36	S	100	24,40
B 3 x 40	S	100	26,00
B 3 x 45	S	100	29,00
B 3 x 50	S	100	31,50
B 3 x 55	S	100	38,50
B 3 x 60	S	100	39,50
B 4 x 10	S	100	16,10
B 4 x 12	S	100	16,70
B 4 x 14	S	100	17,50
B 4 x 16	S	100	18,70
B 4 x 18	S	100	19,40
B 4 x 20	S	100	20,10
B 4 x 22	S	100	21,70
B 4 x 24	S	100	23,20
B 4 x 26	S	100	23,60
B 4 x 28	S	100	24,60
B 4 x 30	S	100	26,50
B 4 x 32	S	100	27,50
B 4 x 36	S	100	29,50
B 4 x 40	S	100	31,50
B 4 x 45	S	100	36,00
B 4 x 50	S	100	39,00
B 4 x 55	S	100	43,00
B 4 x 60	S	100	69,00
B 4 x 70	S	100	56,00
B 4 x 80	S	100	59,00
B 4 x 90	S	100	72,00
B 4 x 100	S	100	79,00
B 5 x 14	S	100	18,30
B 5 x 16	S	100	19,40
B 5 x 18	S	100	20,60
B 5 x 20	S	100	22,00
B 5 x 22	S	100	23,30
B 5 x 24	S	100	24,60
B 5 x 26	S	100	26,50
B 5 x 28	S	100	27,50
B 5 x 30	S	100	29,50
B 5 x 32	S	100	31,50
B 5 x 36	S	100	34,00
B 5 x 40	S	100	38,00
B 5 x 45	S	100	41,00
B 5 x 50	S	100	44,50
B 5 x 55	S	100	48,50
B 5 x 60	S	100	56,00
B 5 x 65	S	50	62,00
B 5 x 70	S	50	66,00
B 5 x 80	S	50	72,00
B 5 x 90	S	50	78,00
B 5 x 100	S	50	86,00
B 6 x 20	S	100	40,00
B 6 x 22	S	100	28,00
B 6 x 24	S	100	31,00
B 6 x 26	S	100	33,00
B 6 x 28	S	100	36,00
B 6 x 30	S	100	38,50
B 6 x 32	S	100	41,00
B 6 x 36	S	100	43,00
B 6 x 40	S	100	46,00
B 6 x 45	S	100	49,50
B 6 x 50	S	100	54,00
B 6 x 55	S	50	62,00
B 6 x 60	S	50	68,00
B 6 x 70	S	50	78,00
B 6 x 80	S	50	86,00
B 6 x 90	S	50	97,00
B 6 x 100	S	50	112,00

Abmessungen	VE	Stück	€/100/Obf.	Abmessungen	VE	Stück	€/100/Obf.	Abmessungen	VE	Stück	€/100/Obf.
B 6 x 110	S	50	192,00	B 10 x 90	S	25	223,00	B 20 x 80	S	10	1210,00
B 6 x 120	S	50	207,00	B 10 x 100	S	25	255,00	B 20 x 90	S	10	1250,00
B 6 x 130	S	50	275,00	B 10 x 110	S	25	275,00	B 20 x 100	S	10	1470,00
B 6,5 x 20	S	100	37,00	B 10 x 120	S	25	295,00	B 20 x 110	S	1	1580,00
B 6,5 x 22	S	100	41,50	B 10 x 130	S	25	345,00	B 20 x 120	S	1	1670,00
B 6,5 x 24	S	100	44,00	B 10 x 140	S	25	345,00	B 20 x 130	S	1	1900,00
B 6,5 x 26	S	100	47,50	B 10 x 150	S	25	385,00	B 20 x 140	S	1	2050,00
B 6,5 x 28	S	100	51,00	B 12 x 30	S	25	121,00	B 20 x 150	S	1	2300,00
B 6,5 x 30	S	100	53,00	B 12 x 32	S	25	121,00	B 20 x 165	S	1	2550,00
B 6,5 x 32	S	100	57,00	B 12 x 36	S	25	121,00				
B 6,5 x 36	S	100	59,00	B 12 x 40	S	25	142,00				
B 6,5 x 40	S	100	63,00	B 12 x 45	S	25	160,00				
B 6,5 x 45	S	100	69,00	B 12 x 50	S	25	165,00				
B 6,5 x 50	S	100	77,00	B 12 x 55	S	25	182,00				
B 6,5 x 55	S	50	88,00	B 12 x 60	S	25	197,00				
B 6,5 x 60	S	50	96,00	B 12 x 70	S	25	230,00				
B 6,5 x 70	S	50	108,00	B 12 x 80	S	25	255,00				
B 6,5 x 80	S	50	123,00	B 12 x 90	S	25	275,00				
B 6,5 x 90	S	50	136,00	B 12 x 100	S	25	325,00				
B 6,5 x 100	S	50	163,00	B 12 x 110	S	10	385,00				
B 6,5 x 110	S	50	215,00	B 12 x 120	S	10	455,00				
B 6,5 x 120	S	50	234,00	B 12 x 130	S	10	540,00				
B 6,5 x 130	S	50	310,00	B 12 x 140	S	10	540,00				
B 7 x 24	S	50	63,00	B 12 x 150	S	10	610,00				
B 7 x 26	S	50	72,00	B 13 x 30	S	25	167,00				
B 7 x 28	S	50	78,00	B 13 x 32	S	25	167,00				
B 7 x 30	S	50	82,00	B 13 x 36	S	25	186,00				
B 7 x 32	S	50	85,00	B 13 x 40	S	25	206,00				
B 7 x 36	S	50	92,00	B 13 x 45	S	25	221,00				
B 7 x 40	S	50	99,00	B 13 x 50	S	25	239,00				
B 7 x 45	S	50	106,00	B 13 x 55	S	25	255,00				
B 7 x 50	S	50	120,00	B 13 x 60	S	25	315,00				
B 7 x 55	S	50	134,00	B 13 x 70	S	25	345,00				
B 7 x 60	S	50	147,00	B 13 x 80	S	25	390,00				
B 7 x 70	S	50	172,00	B 13 x 90	S	25	430,00				
B 7 x 80	S	50	189,00	B 13 x 100	S	10	510,00				
B 7 x 90	S	50	230,00	B 13 x 110	S	10	540,00				
B 7 x 100	S	50	275,00	B 13 x 120	S	10	660,00				
B 7 x 110	S	50	305,00	B 13 x 130	S	10	690,00				
B 7 x 120	S	50	335,00	B 13 x 140	S	10	690,00				
B 7 x 130	S	50	370,00	B 13 x 150	S	10	204,00				
B 7 x 140	S	50	425,00	B 14 x 40	S	25	229,00				
B 7 x 150	S	50	495,00	B 14 x 45	S	25	245,00				
B 8 x 24	S	50	47,50	B 14 x 50	S	25	265,00				
B 8 x 26	S	50	51,00	B 14 x 55	S	25	285,00				
B 8 x 28	S	50	54,00	B 14 x 60	S	25	330,00				
B 8 x 30	S	50	57,00	B 14 x 70	S	25	370,00				
B 8 x 32	S	50	61,00	B 14 x 80	S	25	420,00				
B 8 x 36	S	50	65,00	B 14 x 90	S	25	495,00				
B 8 x 40	S	50	67,00	B 14 x 100	S	10	570,00				
B 8 x 45	S	50	68,00	B 14 x 110	S	10	620,00				
B 8 x 50	S	50	84,00	B 14 x 120	S	10	730,00				
B 8 x 55	S	50	95,00	B 14 x 130	S	10	770,00				
B 8 x 60	S	50	103,00	B 14 x 140	S	10	890,00				
B 8 x 70	S	50	177,00	B 14 x 150	S	10	290,00				
B 8 x 80	S	50	130,00	B 16 x 40	S	10	315,00				
B 8 x 90	S	50	157,00	B 16 x 45	S	10	335,00				
B 8 x 100	S	50	184,00	B 16 x 50	S	10	360,00				
B 8 x 110	S	50	205,00	B 16 x 55	S	10	380,00				
B 8 x 120	S	50	224,00	B 16 x 60	S	10	440,00				
B 8 x 130	S	50	295,00	B 16 x 70	S	10	480,00				
B 8 x 140	S	50	315,00	B 16 x 80	S	10	530,00				
B 8 x 150	S	50	385,00	B 16 x 90	S	10	600,00				
B 10 x 28	S	50	84,00	B 16 x 100	S	10	660,00				
B 10 x 30	S	50	91,00	B 16 x 110	S	10	720,00				
B 10 x 32	S	50	95,00	B 16 x 120	S	10	840,00				
B 10 x 36	S	50	96,00	B 16 x 130	S	10	890,00				
B 10 x 40	S	50	111,00	B 16 x 140	S	1	1060,00				
B 10 x 45	S	50	118,00	B 16 x 150	S	1	1580,00				
B 10 x 50	S	50	123,00	B 16 x 165	S	1	1580,00				
B 10 x 55	S	25	151,00	B 20 x 50	S	10	940,00				
B 10 x 60	S	25	164,00	B 20 x 55	S	10	1030,00				
B 10 x 65	S	25	192,00	B 20 x 60	S	10	1060,00				
B 10 x 70	S	25	189,00	B 20 x 70	S	10	1150,00				
B 10 x 80	S	25	210,00								

ISO	02341.012
2341	Stahl Form B galvanisch verzinkt

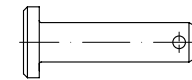

Bolzen mit Kopf, B = mit Splintloch, Bolzen Ø mit Toleranzfeld h11
entspricht EN 22341

Maße → **TI-122** Normumstellung → **TI-10**
Korrosionsschutz → **TI-228** REACH → **TI-262**

ISO 2341 → ersetzt DIN 1444 (austauschbar)



Bolzen Ø x Länge ges. x Länge bis Mitte Splintloch

B 8 x 20 x 16,5	S	100	1320,00 gal Zn
B 8 x 30 x 24	S	100	1340,00 gal Zn
B 8 x 25 x 21,5	S	100	1340,00 gal Zn
B 8 x 30 x 26,5	S	100	1350,00 gal Zn
B 8 x 35 x 31,5	S	100	1360,00 gal Zn
B 8 x 50 x 45,5	S	100	1380,00 gal Zn
B 10 x 25 x 20,5	S	10	1920,00 gal Zn
B 10 x 30 x 25,5	S	10	1930,00 gal Zn
B 10 x 35 x 30,5	S	10	1950,00 gal Zn
B 10 x 40 x 33	S	10	1970,00 gal Zn
B 10 x 45 x 40,5	S	10	2000,00 gal Zn
B 10 x 50 x 45,5	S	10	2030,00 gal Zn
B 10 x 60 x 56	S	10	2040,00 gal Zn
B 10 x 70 x 65,5	S	10	2060,00 gal Zn
B 12 x 30 x 24,5	S	10	1920,00 gal Zn
B 12 x 35 x 29,5	S	10	1930,00 gal Zn
B 12 x 40 x 36	S	10	1950,00 gal Zn
B 12 x 45 x 39,5	S	10	1970,00 gal Zn
B 12 x 50 x 44,5	S	10	2000,00 gal Zn
B 12 x 60 x 54,5	S	10	2040,00 gal Zn
B 16 x 40 x 34	S	1	2100,00 gal Zn
B 16 x 45 x 39	S	1	2130,00 gal Zn
B 16 x 50 x 44	S	1	2160,00 gal Zn
B 16 x 55 x 49	S	1	2200,00 gal Zn
B 16 x 60 x 54	S	1	2230,00 gal Zn
B 16 x 65 x 59	S	1	2260,00 gal Zn
B 18 x 65 x 58	S	1	2290,00 gal Zn
B 20 x 40 x 32	S	1	2240,00 gal Zn
B 20 x 50 x 42	S	1	2300,00 gal Zn
B 20 x 55 x 47	S	1	2360,00 gal Zn
B 20 x 60 x 52	S	1	2450,00 gal Zn
B 20 x 65 x 57	S	1	2550,00 gal Zn

Abmessungen	VE Stück	€/100/Obf.
ISO	02342.000	

2342

14 H

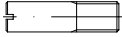

Schaftschrauben mit Kegelpuppe und Schlitz

Maße → **TI-19** Normumstellung → **TI-6**
 Werkstoffeigensch. → **TI-232** REACH → **TI-262**

Rostfrei → **S. 527**

ISO 2342 → ersetzt DIN 427 (austauschbar)



M 3	x	6	S	100	18,80
M 3	x	8	S	100	28,00
M 3	x	10	S	100	14,40
M 3	x	12	S	100	19,00
M 4	x	8	S	100	24,80
M 4	x	10	S	100	15,20
M 4	x	12	S	100	16,40
M 4	x	16	S	100	20,40
M 4	x	20	S	100	23,60
M 4	x	25	S	100	26,50
M 5	x	10	S	100	28,00
M 5	x	12	S	100	23,20
M 5	x	16	S	100	23,00
M 5	x	18	S	100	23,80
M 5	x	20	S	100	23,80
M 5	x	25	S	100	31,50
M 5	x	30	S	100	36,00
M 5	x	35	S	100	53,00
M 5	x	40	S	100	72,00
M 6	x	12	S	100	21,20
M 6	x	16	S	100	23,60
M 6	x	18	S	100	26,00
M 6	x	20	S	100	26,00
M 6	x	25	S	100	29,50
M 6	x	30	S	100	40,50
M 6	x	35	S	100	76,00
M 6	x	40	S	100	114,00
M 6	x	45	S	100	118,00
M 6	x	50	S	100	124,00
M 8	x	16	S	100	29,00
M 8	x	18	S	100	34,50
M 8	x	20	S	100	34,50
M 8	x	25	S	100	37,50
M 8	x	30	S	100	46,00
M 8	x	35	S	100	54,00
M 8	x	40	S	100	72,00
M 8	x	45	S	100	136,00
M 8	x	50	S	100	114,00
M 8	x	60	S	100	156,00
M 10	x	20	S	50	84,00
M 10	x	25	S	50	91,00
M 10	x	30	S	50	97,00
M 10	x	35	S	50	106,00
M 10	x	40	S	50	112,00
M 10	x	45	S	50	138,00
M 10	x	50	S	50	146,00
M 12	x	20	S	50	210,00
M 12	x	25	S	50	224,00
M 12	x	30	S	50	260,00
M 12	x	35	S	50	285,00
M 12	x	40	S	50	330,00
M 12	x	50	S	50	410,00

Abmessungen	VE Stück	€/100/Obf.
ISO	02342.010	

2342

14 H
galvanisch verzinkt

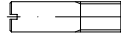

Schaftschrauben mit Kegelpuppe und Schlitz

Maße → **TI-19** Normumstellung → **TI-6**
 Werkstoffeigensch. → **TI-232** REACH → **TI-262**
 Korrosionsschutz → **TI-228**

Rostfrei → **S. 527**

ISO 2342 → ersetzt DIN 427 (austauschbar)



M 3	x	6	S	100	43,00 gal Zn
M 3	x	8	S	100	43,50 gal Zn
M 3	x	10	S	100	43,50 gal Zn
M 3	x	12	S	100	48,00 gal Zn
M 3	x	16	S	100	49,50 gal Zn
M 4	x	8	S	100	44,00 gal Zn
M 4	x	10	S	100	44,50 gal Zn
M 4	x	12	S	100	45,50 gal Zn
M 4	x	16	S	100	49,50 gal Zn
M 4	x	20	S	100	53,00 gal Zn
M 4	x	25	S	100	56,00 gal Zn
M 4	x	30	S	100	71,00 gal Zn
M 5	x	10	S	100	47,50 gal Zn
M 5	x	12	S	100	48,50 gal Zn
M 5	x	16	S	100	53,00 gal Zn
M 5	x	20	S	100	53,00 gal Zn
M 5	x	25	S	100	61,00 gal Zn
M 5	x	30	S	100	65,00 gal Zn
M 5	x	40	S	100	102,00 gal Zn
M 6	x	12	S	100	51,00 gal Zn
M 6	x	16	S	100	53,00 gal Zn
M 6	x	20	S	100	55,00 gal Zn
M 6	x	25	S	100	59,00 gal Zn
M 6	x	30	S	100	70,00 gal Zn
M 6	x	50	S	100	154,00 gal Zn
M 8	x	16	S	100	58,00 gal Zn
M 8	x	20	S	100	64,00 gal Zn
M 8	x	25	S	100	67,00 gal Zn
M 8	x	30	S	100	76,00 gal Zn
M 8	x	35	S	100	82,00 gal Zn
M 8	x	40	S	100	102,00 gal Zn
M 10	x	20	S	50	114,00 gal Zn
M 10	x	25	S	50	120,00 gal Zn
M 10	x	30	S	50	126,00 gal Zn
M 10	x	35	S	50	134,00 gal Zn
M 10	x	40	S	50	142,00 gal Zn
M 10	x	50	S	50	176,00 gal Zn

Abmessungen	VE Stück	€/100/Obf.
DIN	02510.304	

2510

Mu 1.7709 Form L
AD W7

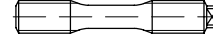

Schraubenbolzen mit Dehnschaft, L = mit langem Gewinde, Mu = mit 2 Muttern aus Wst. 1.7218

Bolzen mit Abnahmeprüfzeugnis 3.2,
 Muttern mit Abnahmeprüfzeugnis 3.1,
 TÜV-anerkannte Fabrikate,
 Preise zzgl. APZ-Kosten

Maße → **TI-18** Anziehmomente → **TI-245**
 Werkstoffeigensch. → **TI-240**

1.7709 = 21CrMoV 5-7 = GA
 1.7218 = 25CrMo4 = KG



LM 12	x	65	S	1	1230,00
LM 12	x	70	S	1	1240,00
LM 12	x	75	S	1	1280,00
LM 12	x	80	S	1	1300,00
LM 12	x	85	S	1	1340,00
LM 12	x	90	S	1	1350,00
LM 12	x	100	S	1	1410,00
LM 12	x	110	S	1	1470,00
LM 16	x	75	S	1	1660,00
LM 16	x	80	S	1	1660,00
LM 16	x	85	S	1	1720,00
LM 16	x	90	S	1	1740,00
LM 16	x	95	S	1	1810,00
LM 16	x	100	S	1	1820,00
LM 16	x	110	S	1	1940,00
LM 16	x	120	S	1	1990,00
LM 16	x	130	S	1	2050,00
LM 16	x	140	S	1	2130,00
LM 16	x	150	S	1	2230,00
LM 20	x	80	S	1	2400,00
LM 20	x	85	S	1	2420,00
LM 20	x	95	S	1	2460,00
LM 20	x	100	S	1	2500,00
LM 20	x	105	S	1	2550,00
LM 20	x	110	S	1	2600,00
LM 20	x	115	S	1	2650,00
LM 20	x	120	S	1	2650,00
LM 20	x	130	S	1	2800,00
LM 20	x	140	S	1	2900,00
LM 20	x	150	S	1	3150,00
LM 20	x	160	S	1	3150,00
LM 20	x	170	S	1	3350,00
LM 20	x	180	S	1	3400,00
LM 22	x	140	S	1	5400,00
LM 24	x	95	S	1	3400,00
LM 24	x	100	S	1	3450,00
LM 24	x	110	S	1	3450,00
LM 24	x	115	S	1	3650,00
LM 24	x	120	S	1	3700,00
LM 24	x	125	S	1	3800,00
LM 24	x	130	S	1	3800,00
LM 24	x	140	S	1	3900,00
LM 24	x	145	S	1	3900,00
LM 24	x	150	S	1	4100,00
LM 24	x	160	S	1	4200,00
LM 24	x	170	S	1	5600,00
LM 24	x	180	S	1	5700,00
LM 24	x	200	S	1	6700,00

Abmessungen	VE	Stück	€/100/Obf.
LM 27 x 110	S	1	4950,00
LM 27 x 120	S	1	5100,00
LM 27 x 130	S	1	5100,00
LM 27 x 140	S	1	5100,00
LM 27 x 150	S	1	5300,00
LM 27 x 160	S	1	5600,00
LM 27 x 190	S	1	7300,00
LM 27 x 205	S	1	8300,00
LM 27 x 210	S	1	8500,00
LM 27 x 220	S	1	8500,00
LM 30 x 140	S	1	6500,00
LM 30 x 150	S	1	6600,00
LM 30 x 160	S	1	6800,00
LM 30 x 170	S	1	7900,00
LM 30 x 180	S	1	8200,00
LM 30 x 200	S	1	8800,00
LM 30 x 220	S	1	8500,00
LM 30 x 235	S	1	9400,00
LM 33 x 160	S	1	8800,00
LM 33 x 180	S	1	9100,00
LM 33 x 200	S	1	9100,00
LM 33 x 235	S	1	11300,00
LM 33 x 240	S	1	11300,00
LM 33 x 260	S	1	11500,00
LM 39 x 220	S	1	16000,00
LM 39 x 240	S	1	16600,00

DIN	02510.305	1.7218	Form NF
		AD W7	

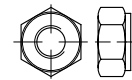

Sechskantmuttern für Schraubenbolzen, NF = Regelform

mit Abnahmeprüfzeugnis 3.1, TÜV- anerkannte Fabrikate, Preise zzgl. APZ-Kosten

Maße → **TI-18** Anziehungsmomente → **TI-245**
 Werkstoffeigensch. → **TI-240**

1.7218 = 25CrMo4 = KG
 Alternativ 1.7258 = 24CrMo5 = G



NF M 12	S	1	189,00
NF M 14	S	1	305,00
NF M 16	S	1	204,00
NF M 20	S	1	345,00
NF M 24	S	1	445,00
NF M 27	S	1	630,00
NF M 30	S	1	820,00
NF M 33	S	1	970,00
NF M 36	S	1	1340,00
NF M 39	S	1	2170,00
NF M 42	S	1	2390,00
NF M 45	S	1	3000,00
NF M 48	S	1	4200,00

Abmessungen	ISO	02936.200
	2936	Stahl vergütet geschwärzt

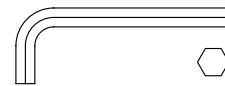

Winkelschraubendreher für Innensechskantschrauben (Sechskant-Stiftschlüssel)

ISO 2936 → ersetzt DIN 911

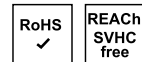

SW 0,7	S	100	94,00
SW 0,7	K	10	134,00
SW 0,9	S	100	88,00
SW 0,9	K	10	138,00
SW 1,3	S	100	62,00
SW 1,3	K	10	103,00
SW 1,5	S	100	36,50
SW 1,5	K	10	66,00
SW 2	S	100	38,50
SW 2	K	10	79,00
SW 2,5	S	100	44,00
SW 2,5	K	10	85,00
SW 3	S	100	51,00
SW 3	K	10	103,00
SW 4	S	100	57,00
SW 4	K	10	105,00
SW 5	S	100	69,00
SW 5	K	10	121,00
SW 6	S	50	95,00
SW 6	K	10	146,00
SW 7	S	10	152,00
SW 8	S	10	161,00
SW 10	S	10	233,00
SW 12	S	5	385,00
SW 14	S	5	540,00
SW 17	S	5	960,00
SW 19	S	5	1370,00
SW 22	S	1	3550,00
SW 27	S	1	5000,00

ISO	02936.210
2936	Stahl vergütet galvanisch verzinkt

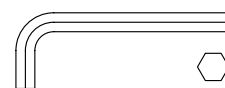

Winkelschraubendreher für Innensechskantschrauben (Sechskant-Stiftschlüssel)

ISO 2936 → ersetzt DIN 911



SW 4	S	100	68,00 gal Zn
SW 5	S	100	83,00 gal Zn
SW 6	S	50	109,00 gal Zn

Abmessungen	DIN	03016.014
	3016	Stahl (W1) Form D1 galvanisch verzinkt

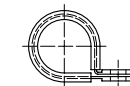

Halierungsschellen, Form D 1, mit Gummiprofil

Maße → **TI-130**

Korrosionsschutz → **TI-228**

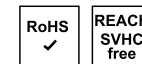

Nenn ∅ x Bandbreite

5	x	12 - W1	S	100	270,00 W1 Zn
5	x	15 - W1	S	100	128,00 W1 Zn
6	x	9 - W1	S	100	206,00 W1 Zn
6	x	15 - W1	S	100	118,00 W1 Zn
8	x	15 - W1	S	100	118,00 W1 Zn
10	x	15 - W1	S	100	118,00 W1 Zn
10	x	20 - W1	S	50	176,00 W1 Zn
12	x	15 - W1	S	50	118,00 W1 Zn
12	x	20 - W1	S	50	176,00 W1 Zn
13	x	15 - W1	S	100	118,00 W1 Zn
13	x	20 - W1	S	50	176,00 W1 Zn
14	x	15 - W1	S	100	118,00 W1 Zn
14	x	20 - W1	S	50	176,00 W1 Zn
15	x	15 - W1	S	100	118,00 W1 Zn
15	x	20 - W1	S	50	176,00 W1 Zn
16	x	15 - W1	S	100	118,00 W1 Zn
16	x	20 - W1	S	50	176,00 W1 Zn
18	x	15 - W1	S	100	118,00 W1 Zn
18	x	20 - W1	S	50	176,00 W1 Zn
19	x	15 - W1	S	100	118,00 W1 Zn
19	x	20 - W1	S	50	176,00 W1 Zn
20	x	15 - W1	S	100	118,00 W1 Zn
20	x	20 - W1	S	50	176,00 W1 Zn
21	x	15 - W1	S	100	136,00 W1 Zn
22	x	15 - W1	S	100	136,00 W1 Zn
22	x	20 - W1	S	50	217,00 W1 Zn
23	x	15 - W1	S	100	136,00 W1 Zn
23	x	20 - W1	S	50	217,00 W1 Zn
24	x	20 - W1	S	50	217,00 W1 Zn
25	x	15 - W1	S	100	136,00 W1 Zn
25	x	20 - W1	S	50	217,00 W1 Zn
26	x	15 - W1	S	100	136,00 W1 Zn
28	x	15 - W1	S	100	136,00 W1 Zn
28	x	20 - W1	S	50	217,00 W1 Zn
30	x	15 - W1	S	100	136,00 W1 Zn
30	x	20 - W1	S	50	217,00 W1 Zn
32	x	15 - W1	S	100	167,00 W1 Zn
32	x	20 - W1	S	50	265,00 W1 Zn
34	x	15 - W1	S	100	167,00 W1 Zn
34	x	20 - W1	S	50	265,00 W1 Zn
35	x	15 - W1	S	100	167,00 W1 Zn
35	x	20 - W1	S	50	265,00 W1 Zn
36	x	20 - W1	S	50	265,00 W1 Zn
38	x	20 - W1	S	50	265,00 W1 Zn
40	x	20 - W1	S	50	265,00 W1 Zn

Abmessungen	VE Stück	€/100/Obf.
DIN	03017.011	
3017	Stahl (W1)	Form A
	galvanisch verzinkt	

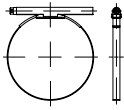

Schlauchschellen, A = mit Schneckenantrieb

Maße → [TI-131](#) Korrosionsschutz → [TI-228](#)

Rostfrei → [S. 528](#)

Antrieb:
Längsschlitz, Sechskant und Kreuzschlitz (H2)

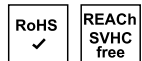

Spannbereich/Bandbreite x SW

8- 12/ 9	C7	S	100	79,00 Zn
10- 16/ 9	C7	S	100	79,00 Zn
12- 22/ 9	C7	S	100	84,00 Zn
16- 27/ 9	C7	S	100	86,00 Zn
16- 27/12	C7	S	50	111,00 Zn
20- 32/ 9	C7	S	100	86,00 Zn
20- 32/12	C7	S	50	113,00 Zn
25- 40/ 9	C7	S	100	96,00 Zn
25- 40/12	C7	S	50	120,00 Zn
30- 45/ 9	C7	S	100	101,00 Zn
30- 45/12	C7	S	50	123,00 Zn
35- 50/ 9	C7	S	50	102,00 Zn
35- 50/12	C7	S	50	124,00 Zn
40- 60/ 9	C7	S	50	107,00 Zn
40- 60/12	C7	S	25	146,00 Zn
50- 70/ 9	C7	S	50	108,00 Zn
50- 70/12	C7	S	25	152,00 Zn
60- 80/ 9	C7	S	25	118,00 Zn
60- 80/12	C7	S	25	166,00 Zn
70- 90/ 9	C7	S	25	137,00 Zn
70- 90/12	C7	S	25	174,00 Zn
80-100/ 9	C7	S	25	142,00 Zn
80-100/12	C7	S	1	180,00 Zn
90-110/ 9	C7	S	25	148,00 Zn
90-110/12	C7	S	1	183,00 Zn
100-120/12	C7	S	1	194,00 Zn
110-130/12	C7	S	1	203,00 Zn
120-140/12	C7	S	1	205,00 Zn
130-150/12	C7	S	1	213,00 Zn
140-160/12	C7	S	1	229,00 Zn
150-170/12	C7	S	1	239,00 Zn
160-180/12	C7	S	1	246,00 Zn
170-190/12	C7	S	1	255,00 Zn

Abmessungen	VE Stück	€/100/Obf.
DIN	03017.013	
3017	Stahl (W1)	Form C1
	galvanisch verzinkt	

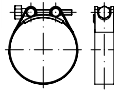

Schlauchschellen, C1 = mit Rundbolzen, einteilig

Spannschraube mit Sechskant

Maße → [TI-131](#) Korrosionsschutz → [TI-228](#)

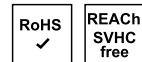

Spannbereich von - bis/Bandbreite

17- 19/18	S	50	920,00 Zn
19- 21/18	S	50	940,00 Zn
21- 23/18	S	50	940,00 Zn
23- 25/18	S	50	950,00 Zn
25- 27/18	S	50	960,00 Zn
27- 29/18	S	50	960,00 Zn
29- 31/18	S	50	970,00 Zn
31- 34/18	S	50	990,00 Zn
34- 37/18	S	50	1000,00 Zn
37- 40/18	S	50	1000,00 Zn
40- 43/18	S	50	1010,00 Zn
43- 47/20	S	50	1020,00 Zn
47- 51/20	S	50	1020,00 Zn
51- 55/20	S	50	1030,00 Zn
55- 59/20	S	50	1050,00 Zn
59- 63/20	S	50	1050,00 Zn
63- 68/20	S	50	1060,00 Zn
68- 73/25	S	25	1280,00 Zn
73- 79/25	S	25	1300,00 Zn
79- 85/25	S	25	1340,00 Zn
85- 91/25	S	25	1350,00 Zn
91- 97/25	S	25	1380,00 Zn
97-104/25	S	25	1410,00 Zn
104-112/25	S	25	1440,00 Zn
112-121/25	S	25	1480,00 Zn
121-130/25	S	25	1530,00 Zn
130-140/30	S	10	2550,00 Zn
140-150/30	S	10	2600,00 Zn
150-162/30	S	10	2650,00 Zn
162-174/30	S	10	2800,00 Zn
174-187/30	S	10	2900,00 Zn
187-200/30	S	10	2900,00 Zn
200-213/30	S	10	3150,00 Zn
213-226/30	S	5	3250,00 Zn
226-239/30	S	10	3300,00 Zn
239-252/30	S	10	3350,00 Zn

Abmessungen	VE Stück	€/100/Obf.
DIN	03404.510	
3404	5.8	MF
	galvanisch verzinkt	



Flachschmiernippel, mit rundem Kopf, Sechskant-Antrieb MF = mit metrischem Feingewinde

Maße → [TI-25](#) REACH → [TI-262](#)

Korrosionsschutz → [TI-228](#)

Messing → [S. 636](#)

Kegel-Schmiernippel → DIN 71412



Gewinde M x Steigung - Schlüsselweite SW

M 6	x 1	SW 11	S	100	275,00 gal Zn
M 6	x 1	SW 17	S	100	275,00 gal Zn
M 8	x 1	SW 11	S	100	249,00 gal Zn
M 8	x 1	SW 17	S	100	249,00 gal Zn
M 10	x 1	SW 17	S	100	249,00 gal Zn
M 16	x 1,5	SW 22	S	25	770,00 gal Zn

DIN	03404.514
3404	5.8
	galvanisch verzinkt
	G



Flachschmiernippel, mit rundem Kopf, Sechskant-Antrieb, G = mit zölligem Rohrgewinde

Maße → [TI-25](#) REACH → [TI-262](#)

Korrosionsschutz → [TI-228](#)

Kegel-Schmiernippel → DIN 71412



Rohrgewinde G - Schlüsselweite SW

G 1/4-16	SW 17	S	50	255,00 gal Zn
G 1/4-22	SW 22	S	25	730,00 gal Zn
G 3/8-22	SW 22	S	25	730,00 gal Zn



- ✓ Große Artikelvielfalt
- ✓ Verlässliche Qualität
- ✓ Hohe Lieferbereitschaft

Abmessungen	VE Stück	€/100/Obf.
DIN	03405.011	
3405	Stahl	Form A
	galvanisch verzinkt	



Trichter-Schmiernippel

Maße → **TI-25** REACH → **TI-262**
 Korrosionsschutz → **TI-228**



AM 6	x	1	S	100	105,00 gal Zn
AM 8	x	1	S	100	113,00 gal Zn

DIN	03567.001
3567	Stahl
	grundiert
	Form A

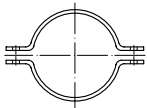

Rohrschellen, A = gleichschenkelig

Maße → **TI-132**
 A 5 → **S. 528**
 Preise gelten für Rohrschellen-Hälften

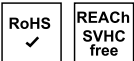

Innen Ø für Rohr-Nennweite					
A 22 / NW 15	S	100			163,00
A 27 / NW 20	S	100			171,00
A 34 / NW 25	S	50			176,00
A 43 / NW 32	S	50			190,00
A 49 / NW 40	S	50			226,00
A 61 / NW 50	S	50			345,00
A 77 / NW 65	S	50			395,00
A 89 / NW 80	S	20			430,00
A 115 / NW 100	S	20			890,00
A 140 / NW 125	S	10			1010,00
A 169 / NW 150	S	10			1120,00
A 220 / NW 200	S	1			1350,00

Abmessungen	VE Stück	€/100/Obf.
DIN	03567.021	
3567	Stahl	Form A
	feuerverzinkt	

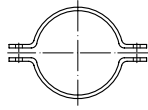

Rohrschellen, A = gleichschenkelig

Maße → **TI-132** Korrosionsschutz → **TI-231**
 A 5 → **S. 528**
 Preise gelten für Rohrschellen-Hälften

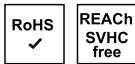

Innen Ø für Rohr-Nennweite					
A 22 / NW 15	S	50			184,00 tZn
A 27 / NW 20	S	50			200,00 tZn
A 34 / NW 25	S	50			206,00 tZn
A 43 / NW 32	S	50			226,00 tZn
A 45 / NW 40	S	50			229,00 tZn
A 49 / NW 40	S	50			265,00 tZn
A 57 / NW 50	S	50			440,00 tZn
A 61 / NW 50	S	50			455,00 tZn
A 77 / NW 65	S	50			520,00 tZn
A 89 / NW 80	S	20			590,00 tZn
A 108 / NW 100	S	10			1250,00 tZn
A 115 / NW 100	S	10			1280,00 tZn
A 140 / NW 125	S	10			1480,00 tZn
A 169 / NW 150	S	10			1650,00 tZn
A 220 / NW 200	S	1			1990,00 tZn
A 273 / NW 250	S	1			3450,00 tZn
A 305 / NW 300	S	1			3750,00 tZn

DIN	03568.020
3568	Stahl
	feuerverzinkt

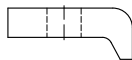

Klemmplatten für Rohrleitungs-Aufhängungen an Doppel-T-Trägern

Weitere Klemmelemente → LINDAPTER-Programm (orange Seiten)
 Maße → **TI-132** Produktinformation → **TI-156**
 Korrosionsschutz → **TI-231**

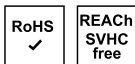

Breite b / Klemmhöhe h = für Schrauben M					
60 / 10 - M 16	S	1			1610,00 tZn
60 / 12 - M 16	S	1			1660,00 tZn
60 / 14 - M 16	S	1			1700,00 tZn
60 / 16 - M 16	S	1			1740,00 tZn
60 / 18 - M 16	S	1			1800,00 tZn
60 / 20 - M 16	S	1			1870,00 tZn

Abmessungen	VE Stück	€/100/Obf.
DIN	03570.011	
3570	Stahl	Form A
	galvanisch verzinkt	

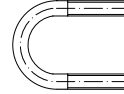

Rundstahlbügel, ohne Muttern, A = zweiseitiges Befestigungsgewinde

Muttern → DIN 934 / ISO 4032
 Maße → **TI-130** Korrosionsschutz → **TI-228**
 Rostfrei → **S. 528**
 Bügel-Höhe für Plattendicke 10 mm



Nominalweite / ~ Rohr-Außen Ø					
A 23 / NW 15	S	100			204,00 gal Zn
A 30 / NW 20	S	100			211,00 gal Zn
A 38 / NW 25	S	100			233,00 gal Zn
A 46 / NW 32	S	100			260,00 gal Zn
A 52 / NW 40	S	100			290,00 gal Zn
A 64 / NW 50	S	50			480,00 gal Zn
A 82 / NW 65	S	50			570,00 gal Zn
A 94 / NW 80	S	50			730,00 gal Zn
A 120 / NW 100	S	10			1020,00 gal Zn
A 148 / NW 125	S	10			1070,00 gal Zn
A 176 / NW 150	S	10			1240,00 gal Zn
A 228 / NW 200	S	5			2550,00 gal Zn
A 282 / NW 250	S	5			3100,00 gal Zn
A 332 / NW 300	S	1			3700,00 gal Zn

DIN	03570.021
3570	Stahl
	feuerverzinkt
	Form A

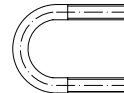

Rundstahlbügel, ohne Muttern, A = zweiseitiges Befestigungsgewinde

Gewindetoleranz 6h (6az + tZn = U)
 Muttern → DIN 934 / ISO 4032
 Maße → **TI-130** Korrosionsschutz → **TI-231**
 Rostfrei → **S. 528**
 Bügel-Höhe für Plattendicke 10 mm



Nominalweite / ~ Rohr-Außen Ø					
A 30 / NW 20	S	100			310,00 tZn
A 38 / NW 25	S	100			340,00 tZn
A 46 / NW 32	S	100			390,00 tZn
A 52 / NW 40	S	100			420,00 tZn
A 64 / NW 50	S	50			690,00 tZn
A 82 / NW 65	S	50			790,00 tZn
A 94 / NW 80	S	50			950,00 tZn
A 120 / NW 100	S	10			1520,00 tZn
A 148 / NW 125	S	10			1640,00 tZn
A 176 / NW 150	S	10			1810,00 tZn
A 228 / NW 200	S	5			4550,00 tZn
A 332 / NW 300	S	1			5600,00 tZn

Abmessungen	VE Stück	€/100/Obf.
ISO	04014.504	

4014

5.6

AD W7

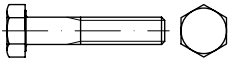

Sechskantschrauben mit Schaft

kurze Abmessungen z. T. Gewinde bis Kopf,
M 6 – M 39 für Druckbehälterbau
nach AD-Regelwerk,
Fabrikate mit Verzicht eines Abnahmeprüfzeugnis,
*M 10/12 = RAZ 3210 übrige Ø = RAZ 400

Maße → TI-15 Anziehmomente → TI-244
Werkstoffeigensch. → TI-232 Normumstellung → TI-6

Rostfrei → S. 529

ISO 4014 → ersetzt DIN 931

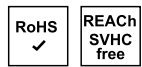

M 6	x	30	S	500	28,50
M 6	x	35	S	200	28,50
M 6	x	40	S	200	30,00
M 6	x	45	S	200	32,00
M 6	x	50	S	200	35,50
M 6	x	55	S	200	46,00
M 6	x	60	S	200	48,00
M 6	x	70	S	200	59,00
M 8	x	35	S	200	42,50
M 8	x	40	S	200	44,50
M 8	x	45	S	200	46,00
M 8	x	50	S	200	48,00
M 8	x	55	S	200	59,00
M 8	x	60	S	200	62,00
M 8	x	80	S	200	85,00
M 8	x	90	S	100	138,00
M 8	x	100	S	100	192,00
M 10	x	45	S	100	59,00
M 10	x	50	S	100	60,00
M 10	x	55	S	100	92,00
M 10	x	60	S	100	111,00
M 10	x	65	S	100	125,00
M 10	x	70	S	100	132,00
M 10	x	80	S	100	135,00
M 10	x	90	S	100	164,00
M 10	x	100	S	100	177,00
M 10	x	110	S	50	265,00
M 12	x	50	S	100	91,00
M 12	x	55	S	100	96,00
M 12	x	60	S	100	102,00
M 12	x	65	S	50	115,00
M 12	x	70	S	50	115,00
M 12	x	75	S	50	134,00
M 12	x	80	S	50	134,00
M 12	x	85	S	50	183,00
M 12	x	90	S	50	147,00
M 12	x	100	S	50	160,00
M 12	x	110	S	50	265,00
M 12	x	120	S	50	350,00
M 12	x	130	S	50	380,00
M 12	x	140	S	50	880,00
M 12	x	150	S	50	930,00
M 12	x	160	S	25	1060,00
M 16	x	65	S	25	200,00
M 16	x	70	S	25	209,00
M 16	x	75	S	25	229,00
M 16	x	80	S	25	229,00
M 16	x	85	S	25	300,00
M 16	x	90	S	25	242,00

Abmessungen	VE Stück	€/100/Obf.
-------------	----------	------------

M 16	x	95	S	25	295,00
M 16	x	100	S	25	265,00
M 16	x	110	S	25	295,00
M 16	x	120	S	25	310,00
M 16	x	130	S	25	355,00
M 16	x	140	S	25	395,00
M 16	x	150	S	25	450,00
M 16	x	160	S	25	610,00
M 16	x	180	S	1	1250,00
M 16	x	200	S	1	1320,00
M 20	x	80	S	25	375,00
M 20	x	85	S	25	460,00
M 20	x	90	S	25	420,00
M 20	x	95	S	25	480,00
M 20	x	100	S	25	440,00
M 20	x	110	S	25	480,00
M 20	x	120	S	25	520,00
M 20	x	130	S	25	610,00
M 20	x	140	S	25	660,00
M 20	x	150	S	25	740,00
M 20	x	160	S	10	790,00
M 20	x	170	S	10	1110,00
M 20	x	180	S	10	1110,00
M 20	x	190	S	1	1550,00
M 20	x	200	S	1	1550,00
M 20	x	210	S	1	1770,00
M 20	x	220	S	1	2090,00
M 20	x	240	S	1	2600,00
M 20	x	250	S	1	2700,00
M 20	x	260	S	1	2900,00
M 20	x	280	S	1	3150,00
M 22	x	100	S	10	1730,00
M 24	x	90	S	10	730,00
M 24	x	95	S	10	850,00
M 24	x	100	S	10	770,00
M 24	x	110	S	10	850,00
M 24	x	120	S	10	870,00
M 24	x	130	S	10	970,00
M 24	x	140	S	10	1020,00
M 24	x	150	S	10	1070,00
M 24	x	160	S	10	1130,00
M 24	x	170	S	1	1220,00
M 24	x	180	S	1	1220,00
M 24	x	190	S	1	1600,00
M 24	x	200	S	1	1600,00
M 24	x	210	S	1	2750,00
M 24	x	220	S	1	2850,00
M 24	x	230	S	1	3000,00
M 24	x	240	S	1	3100,00
M 24	x	260	S	1	3550,00
M 24	x	280	S	1	3850,00
M 24	x	300	S	1	4050,00
M 27	x	100	S	1	1170,00
M 27	x	110	S	1	1220,00
M 27	x	120	S	1	1250,00
M 27	x	130	S	1	1320,00
M 27	x	140	S	1	1370,00
M 27	x	150	S	1	1430,00
M 27	x	160	S	1	1470,00
M 27	x	170	S	1	1670,00
M 27	x	180	S	1	1530,00
M 27	x	190	S	1	1670,00
M 27	x	200	S	1	1670,00
M 27	x	220	S	1	2700,00
M 27	x	230	S	1	3000,00
M 27	x	240	S	1	3200,00
M 27	x	260	S	1	3550,00
M 27	x	280	S	1	3950,00
M 30	x	110	S	1	1690,00
M 30	x	120	S	1	1750,00
M 30	x	130	S	1	1810,00
M 30	x	140	S	1	1850,00
M 30	x	150	S	1	1930,00
M 30	x	160	S	1	2010,00
M 30	x	170	S	1	2160,00

Abmessungen	VE Stück	€/100/Obf.
-------------	----------	------------

M 30	x	180	S	1	2160,00
M 30	x	190	S	1	2290,00
M 30	x	200	S	1	2290,00
M 30	x	210	S	1	2430,00
M 30	x	220	S	1	2430,00
M 30	x	230	S	1	2600,00
M 30	x	240	S	1	2600,00
M 30	x	250	S	1	2750,00
M 30	x	260	S	1	2750,00
M 30	x	280	S	1	2900,00
M 30	x	300	S	1	3050,00
M 30	x	320	S	1	4450,00
M 33	x	130	S	1	2230,00
M 33	x	140	S	1	2330,00
M 33	x	150	S	1	2420,00
M 33	x	160	S	1	2750,00
M 33	x	165	S	1	3350,00
M 33	x	170	S	1	2800,00
M 33	x	180	S	1	2800,00
M 33	x	190	S	1	2900,00
M 33	x	200	S	1	2900,00
M 33	x	210	S	1	3000,00
M 33	x	220	S	1	3000,00
M 36	x	120	S	1	2600,00
M 36	x	140	S	1	2950,00
M 36	x	150	S	1	3050,00
M 36	x	160	S	1	3250,00
M 36	x	165	S	1	3350,00
M 36	x	170	S	1	3350,00
M 36	x	180	S	1	3350,00
M 36	x	200	S	1	3600,00
M 36	x	220	S	1	3750,00
M 36	x	240	S	1	4150,00
M 36	x	260	S	1	4250,00
M 36	x	300	S	1	4600,00
M 39	x	150	S	1	5800,00
M 39	x	160	S	1	6100,00
M 39	x	180	S	1	6600,00

ISO	04014.514
4014	5.6 AD W7
	galvanisch verzinkt

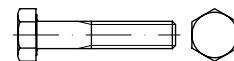

Sechskantschrauben mit Schaft

kurze Abmessungen z. T. Gewinde bis Kopf,
M 6 – M 39 für Druckbehälterbau
nach AD-Regelwerk,
Fabrikate mit Verzicht eines Abnahmeprüfzeugnis,
*M 10/12 = RAZ 3210 übrige Ø = RAZ 400

Maße → TI-15 Anziehmomente → TI-244
Werkstoffeigensch. → TI-232 Normumstellung → TI-6
Korrosionsschutz → TI-228

Rostfrei → S. 529

ISO 4014 → ersetzt DIN 931

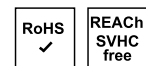

M 10	x	45	S	100	75,00 gal Zn
M 10	x	50	S	100	78,00 gal Zn
M 10	x	55	S	100	111,00 gal Zn
M 10	x	60	S	100	132,00 gal Zn
M 10	x	65	S	100	147,00 gal Zn
M 10	x	70	S	100	155,00 gal Zn
M 10	x	80	S	100	161,00 gal Zn
M 10	x	90	S	100	193,00 gal Zn
M 10	x	100	S	100	209,00 gal Zn

Abmessungen	VE	Stück	€/100/Obf.
M 10 x 110	S	50	300,00 gal Zn
M 12 x 50	S	100	109,00 gal Zn
M 12 x 55	S	100	115,00 gal Zn
M 12 x 60	S	100	123,00 gal Zn
M 12 x 65	S	50	136,00 gal Zn
M 12 x 70	S	50	137,00 gal Zn
M 12 x 75	S	50	158,00 gal Zn
M 12 x 80	S	50	160,00 gal Zn
M 12 x 85	S	50	230,00 gal Zn
M 12 x 90	S	50	175,00 gal Zn
M 12 x 100	S	50	190,00 gal Zn
M 12 x 110	S	50	335,00 gal Zn
M 12 x 120	S	50	430,00 gal Zn
M 12 x 130	S	50	890,00 gal Zn
M 12 x 140	S	50	960,00 gal Zn
M 12 x 150	S	50	1020,00 gal Zn
M 12 x 160	S	25	1160,00 gal Zn
M 16 x 65	S	25	240,00 gal Zn
M 16 x 70	S	25	255,00 gal Zn
M 16 x 75	S	25	275,00 gal Zn
M 16 x 80	S	25	275,00 gal Zn
M 16 x 85	S	25	350,00 gal Zn
M 16 x 90	S	25	295,00 gal Zn
M 16 x 95	S	25	350,00 gal Zn
M 16 x 100	S	25	325,00 gal Zn
M 16 x 110	S	25	355,00 gal Zn
M 16 x 120	S	25	375,00 gal Zn
M 16 x 130	S	25	425,00 gal Zn
M 16 x 140	S	25	470,00 gal Zn
M 16 x 150	S	25	530,00 gal Zn
M 16 x 160	S	25	700,00 gal Zn
M 16 x 180	S	1	1480,00 gal Zn
M 20 x 80	S	25	450,00 gal Zn
M 20 x 85	S	25	540,00 gal Zn
M 20 x 90	S	25	500,00 gal Zn
M 20 x 100	S	25	530,00 gal Zn
M 20 x 110	S	25	580,00 gal Zn
M 20 x 120	S	25	620,00 gal Zn
M 20 x 130	S	25	720,00 gal Zn
M 20 x 140	S	25	780,00 gal Zn
M 20 x 150	S	25	870,00 gal Zn
M 20 x 160	S	10	920,00 gal Zn
M 20 x 170	S	10	1250,00 gal Zn
M 20 x 180	S	10	1260,00 gal Zn
M 20 x 190	S	1	1730,00 gal Zn
M 20 x 200	S	1	1740,00 gal Zn
M 20 x 220	S	1	2300,00 gal Zn
M 20 x 240	S	1	2850,00 gal Zn
M 24 x 90	S	10	860,00 gal Zn
M 24 x 100	S	10	910,00 gal Zn
M 24 x 110	S	10	1000,00 gal Zn
M 24 x 120	S	10	1030,00 gal Zn
M 24 x 130	S	10	1140,00 gal Zn
M 24 x 140	S	10	1200,00 gal Zn
M 24 x 150	S	10	1260,00 gal Zn
M 24 x 160	S	10	1330,00 gal Zn
M 24 x 170	S	1	1430,00 gal Zn
M 24 x 180	S	1	1440,00 gal Zn
M 24 x 190	S	1	1830,00 gal Zn
M 24 x 200	S	1	1840,00 gal Zn
M 24 x 220	S	1	3350,00 gal Zn
M 24 x 240	S	1	3600,00 gal Zn
M 27 x 100	S	1	1350,00 gal Zn
M 27 x 110	S	1	1420,00 gal Zn
M 27 x 120	S	1	1460,00 gal Zn
M 27 x 130	S	1	1540,00 gal Zn
M 27 x 140	S	1	1600,00 gal Zn
M 27 x 150	S	1	1670,00 gal Zn
M 27 x 160	S	1	1710,00 gal Zn
M 27 x 170	S	1	1950,00 gal Zn
M 27 x 180	S	1	1820,00 gal Zn
M 27 x 190	S	1	2120,00 gal Zn
M 27 x 200	S	1	2180,00 gal Zn
M 27 x 220	S	1	3100,00 gal Zn
M 27 x 230	S	1	3450,00 gal Zn

Abmessungen	VE	Stück	€/100/Obf.
M 27 x 240	S	1	3650,00 gal Zn
M 27 x 260	S	1	4450,00 gal Zn
M 30 x 110	S	1	1930,00 gal Zn
M 30 x 120	S	1	2010,00 gal Zn
M 30 x 130	S	1	2090,00 gal Zn
M 30 x 140	S	1	2150,00 gal Zn
M 30 x 150	S	1	2250,00 gal Zn
M 30 x 160	S	1	2340,00 gal Zn
M 30 x 180	S	1	2600,00 gal Zn
M 30 x 190	S	1	2750,00 gal Zn
M 30 x 200	S	1	2800,00 gal Zn
M 30 x 210	S	1	2950,00 gal Zn
M 30 x 220	S	1	2950,00 gal Zn
M 30 x 230	S	1	3250,00 gal Zn
M 30 x 240	S	1	3150,00 gal Zn
M 30 x 250	S	1	3550,00 gal Zn
M 30 x 260	S	1	3350,00 gal Zn
M 33 x 130	S	1	2600,00 gal Zn
M 33 x 140	S	1	3000,00 gal Zn
M 33 x 150	S	1	3100,00 gal Zn
M 33 x 160	S	1	3400,00 gal Zn
M 33 x 170	S	1	3550,00 gal Zn
M 33 x 180	S	1	3650,00 gal Zn
M 33 x 190	S	1	3800,00 gal Zn
M 36 x 120	S	1	3300,00 gal Zn
M 36 x 130	S	1	3650,00 gal Zn
M 36 x 140	S	1	3500,00 gal Zn
M 36 x 150	S	1	3850,00 gal Zn
M 36 x 160	S	1	4000,00 gal Zn
M 36 x 165	S	1	4150,00 gal Zn
M 36 x 170	S	1	4200,00 gal Zn
M 36 x 180	S	1	4300,00 gal Zn
M 36 x 200	S	1	4600,00 gal Zn
M 36 x 220	S	1	4850,00 gal Zn

Abmessungen	VE	Stück	€/100/Obf.
M 16 x 80	S	25	425,00 tZn
M 16 x 85	S	25	470,00 tZn
M 16 x 90	S	25	450,00 tZn
M 16 x 100	S	25	475,00 tZn
M 16 x 110	S	25	520,00 tZn
M 16 x 120	S	25	550,00 tZn
M 16 x 130	S	25	540,00 tZn
M 16 x 140	S	25	570,00 tZn
M 16 x 150	S	25	650,00 tZn
M 16 x 160	S	25	820,00 tZn
M 16 x 170	S	25	1110,00 tZn
M 16 x 180	S	25	1110,00 tZn
M 16 x 190	S	25	1420,00 tZn
M 16 x 200	S	25	1420,00 tZn
M 20 x 80	S	25	700,00 tZn
M 20 x 90	S	25	760,00 tZn
M 20 x 100	S	25	760,00 tZn
M 20 x 110	S	25	790,00 tZn
M 20 x 120	S	25	810,00 tZn
M 20 x 130	S	25	980,00 tZn
M 20 x 140	S	25	980,00 tZn
M 20 x 150	S	25	1120,00 tZn
M 20 x 160	S	10	1130,00 tZn
M 20 x 170	S	10	1310,00 tZn
M 20 x 180	S	10	1380,00 tZn
M 20 x 200	S	10	1730,00 tZn
M 24 x 90	S	10	1270,00 tZn
M 24 x 100	S	10	1330,00 tZn
M 24 x 110	S	10	1400,00 tZn
M 24 x 120	S	10	1470,00 tZn
M 24 x 130	S	10	1640,00 tZn
M 24 x 140	S	10	1760,00 tZn
M 24 x 150	S	10	2010,00 tZn
M 24 x 160	S	10	2120,00 tZn
M 24 x 170	S	10	2410,00 tZn
M 24 x 180	S	10	2550,00 tZn
M 24 x 200	S	10	3000,00 tZn

ISO	04014.524
4014	Mu 5.6
	AD W7
	feuerverzinkt

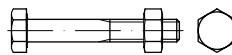

Sechskantschrauben mit Schaft, Mu = mit Sechskantmutter ISO 4032/5-2

kurze Abmessungen z. T. Gewinde bis Kopf
 M 6 - M 39 für Druckbehälterbau
 nach AD-Regelwerk
 Fabrikate mit Verzicht eines Abnahmeprüfzeugnis

Achtung! Warneinblender zu Feuerverzinkung beachten.

Maße → **TI-15** Anziehmomente → **TI-244**
 Werkstoffeigensch. → **TI-232** Normumstellung → **TI-6**
 Korrosionsschutz → **TI-231**

Rostfrei → **S. 529**

ISO 4014 → ersetzt DIN 931



M 12 x 50	S	100	175,00 tZn
M 12 x 55	S	100	183,00 tZn
M 12 x 60	S	100	194,00 tZn
M 12 x 65	S	50	200,00 tZn
M 12 x 70	S	50	190,00 tZn
M 12 x 80	S	50	212,00 tZn
M 12 x 90	S	50	241,00 tZn
M 12 x 100	S	50	275,00 tZn
M 16 x 65	S	25	380,00 tZn
M 16 x 70	S	25	390,00 tZn
M 16 x 75	S	25	420,00 tZn

Achtung!

Feuerverzinkte Schrauben-/Mutter-Garnituren dürfen nur miteinander verschraubt werden, wenn Gewindenspiel/-Toleranzen dieser Garnituren entsprechend ISO 10684 passend aufeinander abgestimmt sind.
 Die Verwendung mit anderen Schrauben-/Mutter-Ausführungen kann zu Verschraubungsproblemen und/oder zum Versagen der Verbindung führen.



Abmessungen VE Stück €/100/Obf.

ISO	04014.352
-----	-----------

4014

1.7218 +QT (25CrMo4)

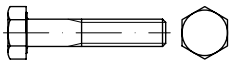

Sechskantschrauben mit Schaft

Zugelassen für den Einsatz nach
Druckgeräterichtlinie → APZ 3.1 auf Anfrage

Maße → **TI-15** Anziehmomente → **TI-245**
Werkstoffeigensch. → **TI-240** Normumstellung → **TI-6**

ISO 4014 → ersetzt DIN 931

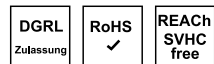

M 12	x	55	S	100	167,00
M 12	x	60	S	100	180,00
M 12	x	65	S	50	200,00
M 12	x	70	S	50	200,00
M 12	x	75	S	50	234,00
M 12	x	80	S	50	234,00
M 12	x	85	S	50	325,00
M 12	x	90	S	50	260,00
M 12	x	100	S	50	280,00
M 12	x	110	S	50	465,00
M 12	x	120	S	50	620,00
M 12	x	140	S	50	1520,00
M 12	x	150	S	50	1620,00
M 12	x	160	S	25	1850,00
M 16	x	65	S	25	350,00
M 16	x	70	S	25	365,00
M 16	x	75	S	25	405,00
M 16	x	80	S	25	405,00
M 16	x	85	S	25	530,00
M 16	x	90	S	25	425,00
M 16	x	95	S	25	520,00
M 16	x	100	S	25	465,00
M 16	x	110	S	25	520,00
M 16	x	120	S	25	550,00
M 16	x	130	S	25	620,00
M 16	x	140	S	25	690,00
M 16	x	150	S	25	790,00
M 16	x	160	S	25	1070,00
M 16	x	180	S	1	2190,00
M 16	x	200	S	1	2420,00
M 20	x	80	S	25	660,00
M 20	x	85	S	25	810,00
M 20	x	90	S	25	730,00
M 20	x	95	S	25	840,00
M 20	x	100	S	25	770,00
M 20	x	110	S	25	840,00
M 20	x	120	S	25	900,00
M 20	x	130	S	25	1060,00
M 20	x	140	S	25	1150,00
M 20	x	150	S	25	1290,00
M 20	x	160	S	10	1380,00
M 20	x	170	S	10	1940,00
M 20	x	180	S	10	1940,00
M 20	x	190	S	1	2700,00
M 20	x	200	S	1	2700,00
M 20	x	210	S	1	3100,00
M 20	x	220	S	1	3700,00
M 20	x	230	S	1	4100,00
M 20	x	240	S	1	4550,00
M 20	x	250	S	1	4750,00
M 20	x	260	S	1	5100,00
M 20	x	280	S	1	5500,00
M 24	x	90	S	10	1280,00

Abmessungen VE Stück €/100/Obf.

M 24	x	95	S	10	1480,00
M 24	x	100	S	10	1350,00
M 24	x	110	S	10	1480,00
M 24	x	120	S	10	1520,00
M 24	x	130	S	10	1690,00
M 24	x	140	S	10	1780,00
M 24	x	150	S	10	1870,00
M 24	x	160	S	10	1980,00
M 24	x	170	S	1	2140,00
M 24	x	180	S	1	2140,00
M 24	x	190	S	1	2800,00
M 24	x	200	S	1	2800,00
M 24	x	210	S	1	4800,00
M 24	x	220	S	1	5000,00
M 24	x	230	S	1	5200,00
M 24	x	240	S	1	5400,00
M 24	x	260	S	1	6300,00
M 24	x	280	S	1	6700,00
M 24	x	300	S	1	7100,00
M 27	x	110	S	1	2130,00
M 27	x	120	S	1	2190,00
M 27	x	130	S	1	2310,00
M 27	x	140	S	1	2390,00
M 27	x	150	S	1	2500,00
M 27	x	160	S	1	2600,00
M 27	x	170	S	1	2950,00
M 27	x	180	S	1	2700,00
M 27	x	190	S	1	2950,00
M 27	x	200	S	1	2950,00
M 27	x	220	S	1	4700,00
M 27	x	230	S	1	5300,00
M 27	x	240	S	1	5600,00
M 27	x	260	S	1	6200,00
M 27	x	280	S	1	6900,00
M 30	x	110	S	1	3050,00
M 30	x	120	S	1	3100,00
M 30	x	130	S	1	3200,00
M 30	x	140	S	1	3250,00
M 30	x	150	S	1	3400,00
M 30	x	160	S	1	3550,00
M 30	x	170	S	1	3800,00
M 30	x	180	S	1	3800,00
M 30	x	190	S	1	4000,00
M 30	x	200	S	1	4000,00
M 30	x	210	S	1	4250,00
M 30	x	220	S	1	4250,00
M 30	x	230	S	1	4500,00
M 30	x	240	S	1	4500,00
M 30	x	250	S	1	4750,00
M 30	x	260	S	1	4750,00
M 30	x	280	S	1	5000,00
M 30	x	300	S	1	5300,00
M 30	x	320	S	1	7600,00
M 33	x	130	S	1	3950,00
M 33	x	140	S	1	4100,00
M 33	x	150	S	1	4250,00
M 33	x	160	S	1	4800,00
M 33	x	165	S	1	5900,00
M 33	x	170	S	1	4950,00
M 33	x	180	S	1	4950,00
M 33	x	190	S	1	5100,00
M 33	x	200	S	1	5100,00
M 33	x	210	S	1	5300,00
M 33	x	220	S	1	5300,00
M 36	x	120	S	1	4500,00
M 36	x	140	S	1	5200,00
M 36	x	150	S	1	5300,00
M 36	x	160	S	1	5700,00
M 36	x	170	S	1	5900,00
M 36	x	180	S	1	5900,00
M 36	x	200	S	1	6300,00
M 36	x	220	S	1	6500,00
M 36	x	240	S	1	7200,00
M 36	x	260	S	1	7400,00
M 36	x	300	S	1	8000,00

Abmessungen VE Stück €/100/Obf.

M 39	x	150	S	1	10000,00
M 39	x	160	S	1	10700,00
M 39	x	180	S	1	11500,00

ISO	04014.355
-----	-----------

4014

1.7218 +QT (25CrMo4)
galvanisch verzinkt

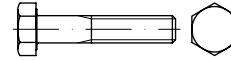

Sechskantschrauben mit Schaft

Zugelassen für den Einsatz nach
Druckgeräterichtlinie → APZ 3.1 auf Anfrage

Maße → **TI-15** Anziehmomente → **TI-245**
Werkstoffeigensch. → **TI-240** Normumstellung → **TI-6**
Korrosionsschutz → **TI-228**

ISO 4014 → ersetzt DIN 931

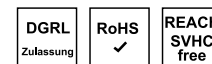

M 12	x	55	S	100	200,00 gal Zn
M 12	x	60	S	100	215,00 gal Zn
M 12	x	65	S	50	238,00 gal Zn
M 12	x	70	S	50	240,00 gal Zn
M 12	x	75	S	50	280,00 gal Zn
M 12	x	80	S	50	280,00 gal Zn
M 12	x	85	S	50	405,00 gal Zn
M 12	x	90	S	50	305,00 gal Zn
M 12	x	100	S	50	335,00 gal Zn
M 12	x	110	S	50	590,00 gal Zn
M 12	x	120	S	50	750,00 gal Zn
M 12	x	130	S	50	1560,00 gal Zn
M 12	x	140	S	50	1680,00 gal Zn
M 12	x	150	S	50	1790,00 gal Zn
M 12	x	160	S	25	2030,00 gal Zn
M 16	x	65	S	25	420,00 gal Zn
M 16	x	70	S	25	440,00 gal Zn
M 16	x	75	S	25	480,00 gal Zn
M 16	x	80	S	25	485,00 gal Zn
M 16	x	85	S	25	610,00 gal Zn
M 16	x	90	S	25	520,00 gal Zn
M 16	x	95	S	25	610,00 gal Zn
M 16	x	100	S	25	570,00 gal Zn
M 16	x	110	S	25	630,00 gal Zn
M 16	x	120	S	25	660,00 gal Zn
M 16	x	130	S	25	740,00 gal Zn
M 16	x	140	S	25	830,00 gal Zn
M 16	x	150	S	25	930,00 gal Zn
M 16	x	160	S	25	1210,00 gal Zn
M 16	x	180	S	1	2600,00 gal Zn
M 20	x	80	S	25	790,00 gal Zn
M 20	x	85	S	25	950,00 gal Zn
M 20	x	90	S	25	880,00 gal Zn
M 20	x	100	S	25	930,00 gal Zn
M 20	x	110	S	25	1010,00 gal Zn
M 20	x	120	S	25	1090,00 gal Zn
M 20	x	130	S	25	1250,00 gal Zn
M 20	x	140	S	25	1360,00 gal Zn
M 20	x	150	S	25	1510,00 gal Zn
M 20	x	160	S	10	1610,00 gal Zn
M 20	x	170	S	10	2190,00 gal Zn
M 20	x	180	S	10	2200,00 gal Zn
M 20	x	190	S	1	3050,00 gal Zn
M 20	x	200	S	1	3050,00 gal Zn
M 20	x	220	S	1	4050,00 gal Zn
M 20	x	240	S	1	4950,00 gal Zn
M 24	x	90	S	10	1500,00 gal Zn
M 24	x	100	S	10	1590,00 gal Zn

Abmessungen	VE	Stück	€/100/Obf.
M 24 x 110	S	10	1740,00 gal Zn
M 24 x 120	S	10	1800,00 gal Zn
M 24 x 130	S	10	1980,00 gal Zn
M 24 x 140	S	10	2100,00 gal Zn
M 24 x 150	S	10	2200,00 gal Zn
M 24 x 160	S	10	2330,00 gal Zn
M 24 x 170	S	1	2500,00 gal Zn
M 24 x 180	S	1	2550,00 gal Zn
M 24 x 190	S	1	3200,00 gal Zn
M 24 x 200	S	1	3250,00 gal Zn
M 24 x 220	S	1	5800,00 gal Zn
M 24 x 240	S	1	6300,00 gal Zn
M 27 x 110	S	1	2470,00 gal Zn
M 27 x 120	S	1	2550,00 gal Zn
M 27 x 130	S	1	2700,00 gal Zn
M 27 x 140	S	1	2800,00 gal Zn
M 27 x 150	S	1	2950,00 gal Zn
M 27 x 160	S	1	3000,00 gal Zn
M 27 x 170	S	1	3450,00 gal Zn
M 27 x 180	S	1	3200,00 gal Zn
M 27 x 190	S	1	3750,00 gal Zn
M 27 x 200	S	1	3850,00 gal Zn
M 27 x 220	S	1	5500,00 gal Zn
M 27 x 230	S	1	6000,00 gal Zn
M 27 x 240	S	1	6400,00 gal Zn
M 27 x 260	S	1	7800,00 gal Zn
M 30 x 130	S	1	3650,00 gal Zn
M 30 x 140	S	1	3800,00 gal Zn
M 30 x 150	S	1	3950,00 gal Zn
M 30 x 160	S	1	4100,00 gal Zn
M 30 x 180	S	1	4550,00 gal Zn
M 30 x 190	S	1	4800,00 gal Zn
M 30 x 200	S	1	4850,00 gal Zn
M 30 x 210	S	1	5200,00 gal Zn
M 30 x 220	S	1	5200,00 gal Zn
M 30 x 230	S	1	5700,00 gal Zn
M 30 x 240	S	1	5500,00 gal Zn
M 30 x 250	S	1	6200,00 gal Zn
M 30 x 260	S	1	5800,00 gal Zn
M 33 x 130	S	1	4550,00 gal Zn
M 33 x 140	S	1	5200,00 gal Zn
M 33 x 150	S	1	5500,00 gal Zn
M 33 x 160	S	1	6000,00 gal Zn
M 33 x 170	S	1	6200,00 gal Zn
M 33 x 180	S	1	6400,00 gal Zn
M 33 x 190	S	1	6600,00 gal Zn
M 36 x 120	S	1	5800,00 gal Zn
M 36 x 130	S	1	6400,00 gal Zn
M 36 x 140	S	1	6100,00 gal Zn
M 36 x 150	S	1	6700,00 gal Zn
M 36 x 160	S	1	7000,00 gal Zn
M 36 x 165	S	1	7200,00 gal Zn
M 36 x 170	S	1	7400,00 gal Zn
M 36 x 180	S	1	7600,00 gal Zn
M 36 x 200	S	1	8100,00 gal Zn
M 36 x 220	S	1	8500,00 gal Zn

Abmessungen	VE	Stück	€/100/Obf.
ISO		04014.800	

4014 8.8

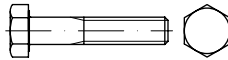

Sechskantschrauben mit Schaft

kurze Abmessungen z. T. Gewinde bis Kopf,
 *M 10/12/14/22 = RAZ 3220 übrige Ø = RAZ 401

Maße → TI-15 Anziehmomente → TI-244
 Werkstoffeigensch. → TI-232 Normumstellung → TI-6
 Rostfrei → S. 529
 Messing → S. 636

ISO 4014 → ersetzt DIN 931

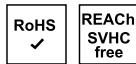

M 3 x 30	S	500	14,30
M 3 x 30	K	100	17,90
M 3 x 35	S	500	14,60
M 3 x 35	K	100	18,30
M 3 x 40	S	500	15,30
M 3 x 40	K	100	19,00
M 4 x 25	S	500	12,30
M 4 x 25	K	100	16,00
M 4 x 30	S	500	12,30
M 4 x 30	K	100	16,00
M 4 x 35	S	500	13,70
M 4 x 40	S	500	14,60
M 4 x 40	K	100	18,10
M 4 x 45	S	500	14,80
M 4 x 50	S	500	16,40
M 4 x 50	K	100	20,10
M 4 x 55	S	200	52,00
M 4 x 60	S	200	58,00
M 4 x 65	S	200	75,00
M 4 x 70	S	200	75,00
M 4 x 75	S	200	94,00
M 4 x 80	S	200	103,00
M 4 x 100	S	200	315,00
M 5 x 25	S	500	12,30
M 5 x 30	S	500	12,30
M 5 x 30	K	100	16,00
M 5 x 35	S	200	13,70
M 5 x 40	S	200	14,60
M 5 x 45	S	200	14,80
M 5 x 50	S	200	16,40
M 5 x 55	S	200	17,50
M 5 x 60	S	200	18,90
M 5 x 65	S	200	25,50
M 5 x 70	S	200	26,00
M 5 x 75	S	200	33,00
M 5 x 80	S	200	31,50
M 5 x 85	S	200	70,00
M 5 x 90	S	200	75,00
M 5 x 95	S	200	82,00
M 5 x 100	S	200	86,00
M 5 x 110	S	200	123,00
M 5 x 120	S	200	143,00
M 5 x 130	S	200	255,00
M 6 x 30	S	500	6,60
M 6 x 30	K	100	10,20
M 6 x 35	S	200	7,40
M 6 x 40	S	200	8,30
M 6 x 45	S	200	9,20
M 6 x 50	S	200	11,10
M 6 x 55	S	200	14,10
M 6 x 60	S	200	15,00

Abmessungen	VE	Stück	€/100/Obf.
M 6 x 65	S	200	23,90
M 6 x 70	S	200	23,90
M 6 x 75	S	200	26,00
M 6 x 80	S	200	32,50
M 6 x 85	S	100	43,50
M 6 x 90	S	100	44,00
M 6 x 95	S	100	55,00
M 6 x 100	S	100	56,00
M 6 x 105	S	100	141,00
M 6 x 110	S	100	56,00
M 6 x 115	S	100	158,00
M 6 x 120	S	100	70,00
M 6 x 125	S	100	165,00
M 6 x 130	S	100	91,00
M 6 x 135	S	100	183,00
M 6 x 140	S	100	105,00
M 6 x 145	S	100	215,00
M 6 x 150	S	100	290,00
M 6 x 160	S	100	290,00
M 6 x 170	S	100	310,00
M 6 x 180	S	100	345,00
M 6 x 200	S	100	440,00
M 7 x 30	S	500	21,90
M 7 x 35	S	200	21,90
M 7 x 40	S	200	24,10
M 7 x 45	S	200	26,50
M 7 x 50	S	200	28,50
M 7 x 55	S	200	31,00
M 7 x 60	S	200	39,50
M 7 x 80	S	200	44,00
M 8 x 35	S	200	11,40
M 8 x 40	S	200	12,80
M 8 x 45	S	200	14,50
M 8 x 50	S	200	15,30
M 8 x 55	S	200	15,70
M 8 x 60	S	200	16,60
M 8 x 65	S	200	18,90
M 8 x 70	S	200	19,20
M 8 x 75	S	200	24,20
M 8 x 80	S	200	25,50
M 8 x 85	S	100	40,00
M 8 x 90	S	100	41,50
M 8 x 95	S	100	46,50
M 8 x 100	S	100	58,00
M 8 x 105	S	100	94,00
M 8 x 110	S	100	67,00
M 8 x 115	S	100	125,00
M 8 x 120	S	100	80,00
M 8 x 125	S	100	136,00
M 8 x 130	S	100	87,00
M 8 x 135	S	100	183,00
M 8 x 140	S	100	98,00
M 8 x 145	S	100	204,00
M 8 x 150	S	100	128,00
M 8 x 160	S	100	135,00
M 8 x 170	S	100	147,00
M 8 x 180	S	100	176,00
M 8 x 190	S	100	204,00
M 8 x 200	S	100	217,00
M 8 x 210	S	100	255,00
M 8 x 220	S	100	330,00
M 8 x 230	S	100	385,00
M 8 x 240	S	100	385,00
M 8 x 250	S	100	465,00
M 8 x 260	S	100	465,00
M 8 x 280	S	100	550,00
M 8 x 300	S	100	600,00
M 10 x 40	S	100	21,20
M 10 x 45	S	100	22,10
M 10 x 50	S	100	23,10
M 10 x 55	S	100	25,50
M 10 x 60	S	100	26,00
M 10 x 65	S	100	28,00
M 10 x 70	S	100	29,00
M 10 x 75	S	100	31,50

Abmessungen	VE	Stück	€/100/Obf.	Abmessungen	VE	Stück	€/100/Obf.	Abmessungen	VE	Stück	€/100/Obf.
M 10 x 80	S	100	33,50	M 12 x 400	S	25	1910,00	M 16 x 370	S	1	2170,00
M 10 x 85	S	100	42,50	M 12 x 420	S	25	2370,00	M 16 x 380	S	1	1970,00
M 10 x 90	S	100	42,50	M 12 x 440	S	25	2650,00	M 16 x 390	S	1	2460,00
M 10 x 95	S	100	49,00	M 12 x 460	S	25	3150,00	M 16 x 400	S	1	2240,00
M 10 x 100	S	100	49,00	M 12 x 480	S	25	3450,00	M 16 x 410	S	1	2750,00
M 10 x 105	S	50	110,00	M 12 x 500	S	25	3800,00	M 16 x 420	S	1	2550,00
M 10 x 110	S	50	75,00	M 14 x 50	S	100	88,00	M 16 x 430	S	1	3150,00
M 10 x 115	S	50	162,00	M 14 x 55	S	50	94,00	M 16 x 440	S	1	2900,00
M 10 x 120	S	50	85,00	M 14 x 60	S	50	94,00	M 16 x 450	S	1	3250,00
M 10 x 125	S	50	176,00	M 14 x 65	S	50	103,00	M 16 x 460	S	1	3600,00
M 10 x 130	S	50	96,00	M 14 x 70	S	50	103,00	M 16 x 480	S	1	3950,00
M 10 x 135	S	50	212,00	M 14 x 75	S	50	129,00	M 16 x 500	S	1	4300,00
M 10 x 140	S	50	142,00	M 14 x 80	S	50	134,00	M 18 x 65	S	25	265,00
M 10 x 145	S	50	275,00	M 14 x 85	S	50	151,00	M 18 x 70	S	25	275,00
M 10 x 150	S	50	171,00	M 14 x 90	S	50	151,00	M 18 x 75	S	25	285,00
M 10 x 160	S	50	213,00	M 14 x 95	S	50	170,00	M 18 x 80	S	25	285,00
M 10 x 170	S	50	213,00	M 14 x 100	S	50	170,00	M 18 x 85	S	25	310,00
M 10 x 180	S	50	236,00	M 14 x 110	S	50	195,00	M 18 x 90	S	25	310,00
M 10 x 190	S	50	300,00	M 14 x 120	S	50	223,00	M 18 x 95	S	25	335,00
M 10 x 200	S	50	300,00	M 14 x 130	S	50	255,00	M 18 x 100	S	25	335,00
M 10 x 210	S	50	310,00	M 14 x 140	S	25	280,00	M 18 x 110	S	25	385,00
M 10 x 220	S	50	600,00	M 14 x 150	S	25	305,00	M 18 x 120	S	25	385,00
M 10 x 230	S	50	810,00	M 14 x 160	S	25	345,00	M 18 x 130	S	25	420,00
M 10 x 240	S	50	650,00	M 14 x 170	S	25	395,00	M 18 x 140	S	25	520,00
M 10 x 250	S	50	880,00	M 14 x 180	S	25	395,00	M 18 x 150	S	25	520,00
M 10 x 260	S	50	700,00	M 14 x 190	S	25	470,00	M 18 x 160	S	25	580,00
M 10 x 270	S	50	940,00	M 14 x 200	S	25	470,00	M 18 x 170	S	25	790,00
M 10 x 280	S	50	750,00	M 14 x 210	S	25	610,00	M 18 x 180	S	25	790,00
M 10 x 290	S	50	1110,00	M 14 x 220	S	25	610,00	M 18 x 190	S	1	1110,00
M 10 x 300	S	50	790,00	M 14 x 230	S	25	670,00	M 18 x 200	S	1	1110,00
M 10 x 320	S	50	940,00	M 14 x 240	S	25	670,00	M 18 x 210	S	1	1290,00
M 10 x 340	S	50	1080,00	M 14 x 250	S	25	940,00	M 18 x 220	S	1	1290,00
M 10 x 360	S	50	1140,00	M 14 x 260	S	25	940,00	M 18 x 230	S	1	1440,00
M 10 x 380	S	50	1820,00	M 14 x 270	S	25	990,00	M 18 x 240	S	1	1440,00
M 12 x 45	S	100	33,00	M 14 x 280	S	25	990,00	M 18 x 250	S	1	1580,00
M 12 x 50	S	100	34,00	M 14 x 290	S	25	1060,00	M 18 x 260	S	1	1580,00
M 12 x 55	S	100	35,00	M 14 x 300	S	25	1060,00	M 18 x 270	S	1	1800,00
M 12 x 60	S	100	37,50	M 14 x 310	S	25	1360,00	M 18 x 280	S	1	1800,00
M 12 x 65	S	50	40,50	M 14 x 320	S	25	1620,00	M 18 x 290	S	1	2060,00
M 12 x 70	S	50	41,00	M 16 x 55	S	50	62,00	M 18 x 300	S	1	2060,00
M 12 x 75	S	50	44,00	M 16 x 60	S	50	64,00	M 20 x 60	S	25	118,00
M 12 x 80	S	50	56,00	M 16 x 65	S	25	70,00	M 20 x 65	S	25	121,00
M 12 x 85	S	50	61,00	M 16 x 70	S	25	74,00	M 20 x 70	S	25	124,00
M 12 x 90	S	50	53,00	M 16 x 75	S	25	78,00	M 20 x 75	S	25	129,00
M 12 x 95	S	50	66,00	M 16 x 80	S	25	82,00	M 20 x 80	S	25	140,00
M 12 x 100	S	50	66,00	M 16 x 85	S	25	103,00	M 20 x 85	S	25	152,00
M 12 x 105	S	50	183,00	M 16 x 90	S	25	90,00	M 20 x 90	S	25	152,00
M 12 x 110	S	50	99,00	M 16 x 95	S	25	111,00	M 20 x 95	S	25	182,00
M 12 x 115	S	50	190,00	M 16 x 100	S	25	111,00	M 20 x 100	S	25	182,00
M 12 x 120	S	50	107,00	M 16 x 110	S	25	167,00	M 20 x 110	S	25	285,00
M 12 x 130	S	50	120,00	M 16 x 120	S	25	186,00	M 20 x 120	S	25	295,00
M 12 x 140	S	50	175,00	M 16 x 130	S	25	199,00	M 20 x 130	S	25	300,00
M 12 x 150	S	50	200,00	M 16 x 140	S	25	270,00	M 20 x 140	S	25	410,00
M 12 x 160	S	25	265,00	M 16 x 150	S	25	305,00	M 20 x 150	S	25	455,00
M 12 x 170	S	25	300,00	M 16 x 160	S	25	345,00	M 20 x 160	S	10	520,00
M 12 x 180	S	25	335,00	M 16 x 170	S	25	425,00	M 20 x 170	S	10	660,00
M 12 x 190	S	25	355,00	M 16 x 180	S	25	425,00	M 20 x 180	S	10	660,00
M 12 x 200	S	25	390,00	M 16 x 190	S	25	500,00	M 20 x 190	S	1	1030,00
M 12 x 210	S	25	440,00	M 16 x 200	S	25	500,00	M 20 x 200	S	1	1030,00
M 12 x 220	S	25	440,00	M 16 x 210	S	25	650,00	M 20 x 210	S	1	1290,00
M 12 x 230	S	25	610,00	M 16 x 220	S	25	650,00	M 20 x 220	S	1	1290,00
M 12 x 240	S	25	610,00	M 16 x 230	S	25	730,00	M 20 x 230	S	1	1440,00
M 12 x 250	S	25	670,00	M 16 x 240	S	25	730,00	M 20 x 240	S	1	1440,00
M 12 x 260	S	25	670,00	M 16 x 250	S	25	820,00	M 20 x 250	S	1	1580,00
M 12 x 270	S	25	730,00	M 16 x 260	S	25	820,00	M 20 x 260	S	1	1580,00
M 12 x 280	S	25	730,00	M 16 x 270	S	25	1130,00	M 20 x 270	S	1	1800,00
M 12 x 290	S	25	800,00	M 16 x 280	S	1	1130,00	M 20 x 280	S	1	1800,00
M 12 x 300	S	25	800,00	M 16 x 290	S	1	1270,00	M 20 x 290	S	1	2060,00
M 12 x 310	S	25	1250,00	M 16 x 300	S	1	1270,00	M 20 x 300	S	1	2060,00
M 12 x 320	S	25	1150,00	M 16 x 310	S	1	1480,00	M 20 x 310	S	1	2190,00
M 12 x 330	S	25	1450,00	M 16 x 320	S	1	1350,00	M 20 x 320	S	1	2190,00
M 12 x 340	S	25	1260,00	M 16 x 330	S	1	1580,00	M 20 x 330	S	1	2340,00
M 12 x 350	S	25	1530,00	M 16 x 340	S	1	1440,00	M 20 x 340	S	1	2340,00
M 12 x 360	S	25	1420,00	M 16 x 350	S	1	1780,00	M 20 x 350	S	1	2490,00
M 12 x 380	S	25	1530,00	M 16 x 360	S	1	1610,00	M 20 x 360	S	1	2490,00

Abmessungen	VE	Stück	€/100/Obf.	Abmessungen	VE	Stück	€/100/Obf.	Abmessungen	VE	Stück	€/100/Obf.
M 20 x 370	S	1	2700,00	M 24 x 430	S	1	3850,00	M 30 x 370	S	1	4400,00
M 20 x 380	S	1	2700,00	M 24 x 440	S	1	3850,00	M 30 x 380	S	1	4400,00
M 20 x 390	S	1	2800,00	M 24 x 450	S	1	4100,00	M 30 x 390	S	1	4800,00
M 20 x 400	S	1	2800,00	M 24 x 460	S	1	4100,00	M 30 x 400	S	1	4800,00
M 20 x 410	S	1	2900,00	M 24 x 480	S	1	4350,00	M 30 x 420	S	1	5000,00
M 20 x 420	S	1	2900,00	M 24 x 500	S	1	4600,00	M 30 x 440	S	1	5900,00
M 20 x 430	S	1	3600,00	M 24 x 560	S	1	9800,00	M 30 x 450	S	1	6700,00
M 20 x 440	S	1	3600,00	M 24 x 600	S	1	10300,00	M 30 x 460	S	1	6700,00
M 20 x 450	S	1	3600,00	M 24 x 640	S	1	10700,00	M 30 x 480	S	1	7900,00
M 20 x 460	S	1	3600,00	M 27 x 75	S	10	600,00	M 30 x 500	S	1	8500,00
M 20 x 480	S	1	3650,00	M 27 x 80	S	10	600,00	M 30 x 520	S	1	14600,00
M 20 x 500	S	1	3700,00	M 27 x 85	S	10	750,00	M 30 x 560	S	1	15400,00
M 22 x 70	S	25	510,00	M 27 x 90	S	10	750,00	M 30 x 580	S	1	15700,00
M 22 x 75	S	25	530,00	M 27 x 100	S	10	890,00	M 30 x 600	S	1	16100,00
M 22 x 80	S	25	530,00	M 27 x 110	S	1	1030,00	M 33 x 90	S	1	1790,00
M 22 x 90	S	25	550,00	M 27 x 120	S	1	1030,00	M 33 x 100	S	1	1790,00
M 22 x 100	S	10	600,00	M 27 x 130	S	1	1110,00	M 33 x 110	S	1	1900,00
M 22 x 110	S	10	640,00	M 27 x 140	S	1	1110,00	M 33 x 120	S	1	1990,00
M 22 x 120	S	10	690,00	M 27 x 150	S	1	1140,00	M 33 x 130	S	1	2080,00
M 22 x 130	S	10	730,00	M 27 x 160	S	1	1140,00	M 33 x 140	S	1	2180,00
M 22 x 140	S	10	730,00	M 27 x 170	S	1	1200,00	M 33 x 150	S	1	2260,00
M 22 x 150	S	10	870,00	M 27 x 180	S	1	1200,00	M 33 x 160	S	1	2700,00
M 22 x 160	S	10	980,00	M 27 x 190	S	1	1430,00	M 33 x 170	S	1	2750,00
M 22 x 170	S	10	1220,00	M 27 x 200	S	1	1430,00	M 33 x 180	S	1	2750,00
M 22 x 180	S	10	1220,00	M 27 x 210	S	1	2110,00	M 33 x 190	S	1	2850,00
M 22 x 190	S	10	1550,00	M 27 x 220	S	1	2110,00	M 33 x 200	S	1	2850,00
M 22 x 200	S	10	1550,00	M 27 x 230	S	1	2280,00	M 33 x 210	S	1	2950,00
M 22 x 210	S	10	1740,00	M 27 x 240	S	1	2280,00	M 33 x 220	S	1	2950,00
M 22 x 220	S	10	1740,00	M 27 x 250	S	1	2460,00	M 33 x 230	S	1	3100,00
M 22 x 230	S	1	1940,00	M 27 x 260	S	1	2460,00	M 33 x 240	S	1	3100,00
M 22 x 240	S	1	1940,00	M 27 x 270	S	1	2650,00	M 33 x 250	S	1	3650,00
M 22 x 250	S	1	2380,00	M 27 x 280	S	1	2650,00	M 33 x 260	S	1	3650,00
M 22 x 260	S	1	2380,00	M 27 x 290	S	1	3050,00	M 33 x 270	S	1	3800,00
M 22 x 270	S	1	2700,00	M 27 x 300	S	1	3050,00	M 33 x 280	S	1	3800,00
M 22 x 280	S	1	2700,00	M 27 x 320	S	1	3850,00	M 33 x 300	S	1	4000,00
M 22 x 300	S	1	2950,00	M 27 x 340	S	1	4250,00	M 33 x 400	S	1	12400,00
M 22 x 320	S	1	3550,00	M 27 x 360	S	1	4650,00	M 36 x 100	S	1	2260,00
M 24 x 75	S	25	220,00	M 27 x 380	S	1	5000,00	M 36 x 110	S	1	2260,00
M 24 x 80	S	25	220,00	M 27 x 400	S	1	5300,00	M 36 x 120	S	1	2380,00
M 24 x 85	S	10	290,00	M 27 x 420	S	1	5700,00	M 36 x 130	S	1	2550,00
M 24 x 90	S	10	270,00	M 27 x 440	S	1	6000,00	M 36 x 140	S	1	2650,00
M 24 x 95	S	10	295,00	M 27 x 460	S	1	6300,00	M 36 x 150	S	1	2750,00
M 24 x 100	S	10	295,00	M 27 x 480	S	1	6700,00	M 36 x 160	S	1	3100,00
M 24 x 110	S	10	445,00	M 27 x 500	S	1	7100,00	M 36 x 170	S	1	3300,00
M 24 x 120	S	10	475,00	M 27 x 520	S	1	9800,00	M 36 x 180	S	1	3300,00
M 24 x 130	S	10	485,00	M 27 x 540	S	1	10600,00	M 36 x 190	S	1	3450,00
M 24 x 140	S	10	670,00	M 27 x 560	S	1	11300,00	M 36 x 200	S	1	3450,00
M 24 x 150	S	10	730,00	M 30 x 80	S	1	1570,00	M 36 x 210	S	1	3600,00
M 24 x 160	S	10	810,00	M 30 x 90	S	1	1570,00	M 36 x 220	S	1	3600,00
M 24 x 170	S	1	1030,00	M 30 x 100	S	1	1570,00	M 36 x 230	S	1	3950,00
M 24 x 180	S	1	1030,00	M 30 x 110	S	1	1860,00	M 36 x 240	S	1	3950,00
M 24 x 190	S	1	1460,00	M 30 x 120	S	1	1860,00	M 36 x 250	S	1	4200,00
M 24 x 200	S	1	1460,00	M 30 x 130	S	1	2060,00	M 36 x 260	S	1	4200,00
M 24 x 210	S	1	1730,00	M 30 x 140	S	1	2060,00	M 36 x 270	S	1	4400,00
M 24 x 220	S	1	1870,00	M 30 x 150	S	1	2140,00	M 36 x 280	S	1	4400,00
M 24 x 230	S	1	1920,00	M 30 x 160	S	1	2140,00	M 36 x 290	S	1	4600,00
M 24 x 240	S	1	2010,00	M 30 x 170	S	1	2360,00	M 36 x 300	S	1	4600,00
M 24 x 250	S	1	2070,00	M 30 x 180	S	1	2360,00	M 36 x 310	S	1	5300,00
M 24 x 260	S	1	2070,00	M 30 x 190	S	1	2550,00	M 36 x 320	S	1	5300,00
M 24 x 270	S	1	2440,00	M 30 x 200	S	1	2550,00	M 36 x 330	S	1	5500,00
M 24 x 280	S	1	2440,00	M 30 x 210	S	1	2600,00	M 36 x 340	S	1	5500,00
M 24 x 290	S	1	2700,00	M 30 x 220	S	1	2600,00	M 36 x 350	S	1	5700,00
M 24 x 300	S	1	2700,00	M 30 x 240	S	1	2800,00	M 36 x 360	S	1	5700,00
M 24 x 310	S	1	2750,00	M 30 x 250	S	1	3100,00	M 36 x 380	S	1	5900,00
M 24 x 320	S	1	2750,00	M 30 x 260	S	1	3100,00	M 36 x 400	S	1	5900,00
M 24 x 330	S	1	2800,00	M 30 x 270	S	1	3100,00	M 36 x 420	S	1	6000,00
M 24 x 340	S	1	2800,00	M 30 x 280	S	1	3100,00	M 36 x 440	S	1	6400,00
M 24 x 350	S	1	2900,00	M 30 x 290	S	1	3250,00	M 36 x 460	S	1	6900,00
M 24 x 360	S	1	2900,00	M 30 x 300	S	1	3250,00	M 36 x 480	S	1	7200,00
M 24 x 370	S	1	3100,00	M 30 x 310	S	1	3750,00	M 36 x 500	S	1	7500,00
M 24 x 380	S	1	3100,00	M 30 x 320	S	1	3750,00	M 36 x 540	S	1	18000,00
M 24 x 390	S	1	3350,00	M 30 x 330	S	1	3850,00	M 36 x 580	S	1	18500,00
M 24 x 400	S	1	3350,00	M 30 x 340	S	1	3850,00	M 39 x 110	S	1	3700,00
M 24 x 410	S	1	3550,00	M 30 x 350	S	1	4100,00	M 39 x 120	S	1	3700,00
M 24 x 420	S	1	3550,00	M 30 x 360	S	1	4100,00	M 39 x 130	S	1	3900,00

Abmessungen	VE	Stück	€/100/Obf.
M 39 x 140	S	1	4050,00
M 39 x 150	S	1	4300,00
M 39 x 160	S	1	4400,00
M 39 x 170	S	1	4550,00
M 39 x 180	S	1	4800,00
M 39 x 190	S	1	5100,00
M 39 x 200	S	1	5300,00
M 39 x 220	S	1	5600,00
M 39 x 240	S	1	6000,00
M 39 x 250	S	1	15400,00
M 39 x 260	S	1	15600,00
M 39 x 280	S	1	16000,00
M 39 x 300	S	1	16400,00
M 42 x 120	S	1	3900,00
M 42 x 130	S	1	4100,00
M 42 x 140	S	1	4300,00
M 42 x 150	S	1	4550,00
M 42 x 160	S	1	4650,00
M 42 x 170	S	1	4850,00
M 42 x 180	S	1	5200,00
M 42 x 190	S	1	5500,00
M 42 x 200	S	1	5500,00
M 42 x 210	S	5	5900,00
M 42 x 220	S	1	6300,00
M 42 x 240	S	1	6700,00
M 42 x 250	S	1	7200,00
M 42 x 260	S	1	7200,00
M 42 x 280	S	1	8100,00
M 42 x 300	S	1	8500,00
M 42 x 320	S	1	9300,00
M 42 x 340	S	1	9900,00
M 42 x 360	S	1	10800,00
M 42 x 380	S	1	11600,00
M 42 x 400	S	1	12200,00
M 42 x 420	S	1	13100,00
M 45 x 120	S	1	5200,00
M 45 x 130	S	1	5500,00
M 45 x 140	S	1	5700,00
M 45 x 150	S	1	5900,00
M 45 x 160	S	1	6300,00
M 45 x 170	S	1	6500,00
M 45 x 180	S	1	6800,00
M 45 x 190	S	1	7100,00
M 45 x 200	S	1	7400,00
M 45 x 220	S	1	17100,00
M 48 x 130	S	1	6600,00
M 48 x 140	S	1	6900,00
M 48 x 150	S	1	7400,00
M 48 x 160	S	1	7700,00
M 48 x 170	S	1	7900,00
M 48 x 180	S	1	7900,00
M 48 x 190	S	1	8400,00
M 48 x 200	S	1	8400,00
M 48 x 220	S	1	8800,00
M 48 x 240	S	1	9300,00
M 48 x 250	S	1	9800,00
M 48 x 260	S	1	9800,00
M 48 x 280	S	1	10500,00
M 48 x 290	S	1	11600,00
M 48 x 300	S	1	11600,00
M 48 x 320	S	1	13100,00
M 48 x 340	S	1	13800,00
M 48 x 360	S	1	14600,00
M 48 x 380	S	1	15200,00
M 48 x 400	S	1	16000,00
M 48 x 420	S	1	21900,00
M 48 x 480	S	1	28600,00
M 52 x 150	S	1	19800,00
M 52 x 200	S	1	21800,00
M 56 x 130	S	1	11600,00
M 56 x 140	S	1	12100,00
M 56 x 150	S	1	12200,00
M 56 x 160	S	1	12800,00
M 56 x 170	S	1	13100,00
M 56 x 180	S	1	13700,00

Abmessungen	VE	Stück	€/100/Obf.
M 56 x 190	S	1	13900,00
M 56 x 200	S	1	14500,00
M 56 x 220	S	1	14500,00
M 56 x 240	S	1	15600,00
M 56 x 250	S	1	16600,00
M 56 x 260	S	1	16600,00
M 56 x 280	S	1	17700,00
M 56 x 300	S	1	18500,00
M 56 x 380	S	1	30100,00
M 64 x 300	S	1	34600,00

ISO	04014.810
4014	8.8
	galvanisch verzinkt

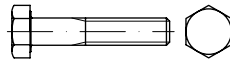

Sechskantschrauben mit Schaft

kurze Abmessungen z. T. Gewinde bis Kopf,
 *M 10/12/14/22 = RAZ 3220 übrige Ø = RAZ 401

Maße → **TI-15** Anziehmomente → **TI-244**
 Werkstoffeigensch. → **TI-232** Normumstellung → **TI-6**
 Korrosionsschutz → **TI-228**

Rostfrei → **S. 529**
 Messing → **S. 636**

ISO 4014 → ersetzt DIN 931



M 3 x 30	S	500	15,10 gal Zn
M 3 x 35	S	500	15,60 gal Zn
M 3 x 40	S	500	16,40 gal Zn
M 4 x 25	S	500	13,30 gal Zn
M 4 x 30	S	500	13,50 gal Zn
M 4 x 35	S	500	15,00 gal Zn
M 4 x 40	S	500	16,00 gal Zn
M 4 x 40	K	100	19,50 gal Zn
M 4 x 45	S	500	16,30 gal Zn
M 4 x 50	S	500	18,10 gal Zn
M 4 x 55	S	200	54,00 gal Zn
M 4 x 60	S	200	61,00 gal Zn
M 4 x 70	S	200	78,00 gal Zn
M 4 x 80	S	200	107,00 gal Zn
M 5 x 30	S	500	14,00 gal Zn
M 5 x 30	K	100	17,70 gal Zn
M 5 x 35	S	200	15,70 gal Zn
M 5 x 40	S	200	16,70 gal Zn
M 5 x 45	S	200	17,20 gal Zn
M 5 x 50	S	200	19,10 gal Zn
M 5 x 55	S	200	20,40 gal Zn
M 5 x 60	S	200	22,00 gal Zn
M 5 x 65	S	200	28,50 gal Zn
M 5 x 70	S	200	30,00 gal Zn
M 5 x 80	S	200	35,50 gal Zn
M 5 x 85	S	200	79,00 gal Zn
M 5 x 90	S	200	80,00 gal Zn
M 5 x 95	S	200	88,00 gal Zn
M 5 x 100	S	200	91,00 gal Zn
M 5 x 120	S	200	151,00 gal Zn
M 5 x 130	S	200	260,00 gal Zn
M 6 x 30	S	500	8,40 gal Zn
M 6 x 30	K	100	12,10 gal Zn
M 6 x 35	S	200	9,40 gal Zn
M 6 x 40	S	200	10,60 gal Zn
M 6 x 45	S	200	11,80 gal Zn
M 6 x 50	S	200	13,80 gal Zn
M 6 x 55	S	200	17,10 gal Zn
M 6 x 60	S	200	18,30 gal Zn

Abmessungen	VE	Stück	€/100/Obf.
M 6 x 65	S	200	28,50 gal Zn
M 6 x 70	S	200	29,00 gal Zn
M 6 x 75	S	200	31,50 gal Zn
M 6 x 80	S	200	38,50 gal Zn
M 6 x 85	S	100	49,50 gal Zn
M 6 x 90	S	100	50,00 gal Zn
M 6 x 95	S	100	62,00 gal Zn
M 6 x 100	S	100	63,00 gal Zn
M 6 x 105	S	100	151,00 gal Zn
M 6 x 110	S	100	64,00 gal Zn
M 6 x 120	S	100	78,00 gal Zn
M 6 x 130	S	100	101,00 gal Zn
M 6 x 140	S	100	116,00 gal Zn
M 6 x 150	S	100	300,00 gal Zn
M 6 x 160	S	100	305,00 gal Zn
M 6 x 170	S	100	325,00 gal Zn
M 6 x 180	S	100	360,00 gal Zn
M 6 x 190	S	100	400,00 gal Zn
M 6 x 200	S	100	460,00 gal Zn
M 7 x 40	S	200	32,50 gal Zn
M 7 x 50	S	200	35,00 gal Zn
M 7 x 60	S	200	51,00 gal Zn
M 8 x 35	S	200	15,50 gal Zn
M 8 x 40	S	200	17,50 gal Zn
M 8 x 45	S	200	19,60 gal Zn
M 8 x 50	S	200	20,90 gal Zn
M 8 x 55	S	200	21,60 gal Zn
M 8 x 60	S	200	23,00 gal Zn
M 8 x 65	S	200	26,00 gal Zn
M 8 x 70	S	200	26,50 gal Zn
M 8 x 75	S	200	32,00 gal Zn
M 8 x 80	S	200	34,00 gal Zn
M 8 x 85	S	100	52,00 gal Zn
M 8 x 90	S	100	53,00 gal Zn
M 8 x 95	S	100	59,00 gal Zn
M 8 x 100	S	100	71,00 gal Zn
M 8 x 110	S	100	82,00 gal Zn
M 8 x 115	S	100	147,00 gal Zn
M 8 x 120	S	100	95,00 gal Zn
M 8 x 125	S	100	161,00 gal Zn
M 8 x 130	S	100	104,00 gal Zn
M 8 x 135	S	100	201,00 gal Zn
M 8 x 140	S	100	116,00 gal Zn
M 8 x 145	S	100	232,00 gal Zn
M 8 x 150	S	100	147,00 gal Zn
M 8 x 160	S	100	155,00 gal Zn
M 8 x 170	S	100	174,00 gal Zn
M 8 x 180	S	100	204,00 gal Zn
M 8 x 190	S	100	233,00 gal Zn
M 8 x 200	S	100	250,00 gal Zn
M 8 x 210	S	100	290,00 gal Zn
M 8 x 220	S	100	370,00 gal Zn
M 10 x 40	S	100	29,50 gal Zn
M 10 x 45	S	100	31,00 gal Zn
M 10 x 50	S	100	32,50 gal Zn
M 10 x 55	S	100	35,50 gal Zn
M 10 x 60	S	100	36,50 gal Zn
M 10 x 65	S	100	39,50 gal Zn
M 10 x 70	S	100	40,50 gal Zn
M 10 x 75	S	100	44,50 gal Zn
M 10 x 80	S	100	45,00 gal Zn
M 10 x 85	S	100	57,00 gal Zn
M 10 x 90	S	100	58,00 gal Zn
M 10 x 95	S	100	65,00 gal Zn
M 10 x 100	S	100	65,00 gal Zn
M 10 x 105	S	50	130,00 gal Zn
M 10 x 110	S	50	98,00 gal Zn
M 10 x 115	S	50	176,00 gal Zn
M 10 x 120	S	50	110,00 gal Zn
M 10 x 130	S	50	124,00 gal Zn
M 10 x 140	S	50	171,00 gal Zn
M 10 x 150	S	50	203,00 gal Zn
M 10 x 160	S	50	246,00 gal Zn
M 10 x 170	S	50	250,00 gal Zn
M 10 x 180	S	50	275,00 gal Zn

Abmessungen	VE	Stück	€/100/Obf.	Abmessungen	VE	Stück	€/100/Obf.	Abmessungen	VE	Stück	€/100/Obf.
M 10 x 190	S	50	335,00 gal Zn	M 16 x 75	S	25	110,00 gal Zn	M 20 x 190	S	1	1190,00 gal Zn
M 10 x 200	S	50	242,00 gal Zn	M 16 x 80	S	25	116,00 gal Zn	M 20 x 200	S	1	1200,00 gal Zn
M 10 x 210	S	50	355,00 gal Zn	M 16 x 85	S	25	142,00 gal Zn	M 20 x 210	S	1	1460,00 gal Zn
M 10 x 220	S	50	650,00 gal Zn	M 16 x 90	S	25	130,00 gal Zn	M 20 x 220	S	1	1470,00 gal Zn
M 10 x 230	S	50	860,00 gal Zn	M 16 x 95	S	25	154,00 gal Zn	M 20 x 230	S	1	1620,00 gal Zn
M 10 x 240	S	50	700,00 gal Zn	M 16 x 100	S	25	155,00 gal Zn	M 20 x 240	S	1	1630,00 gal Zn
M 10 x 250	S	50	930,00 gal Zn	M 16 x 110	S	25	229,00 gal Zn	M 20 x 250	S	1	1780,00 gal Zn
M 10 x 260	S	50	760,00 gal Zn	M 16 x 120	S	25	255,00 gal Zn	M 20 x 260	S	1	1790,00 gal Zn
M 10 x 270	S	50	990,00 gal Zn	M 16 x 130	S	25	270,00 gal Zn	M 20 x 270	S	1	1870,00 gal Zn
M 10 x 280	S	50	810,00 gal Zn	M 16 x 140	S	25	345,00 gal Zn	M 20 x 280	S	1	2020,00 gal Zn
M 10 x 300	S	50	850,00 gal Zn	M 16 x 150	S	25	385,00 gal Zn	M 20 x 290	S	1	2150,00 gal Zn
M 12 x 45	S	100	45,50 gal Zn	M 16 x 160	S	25	430,00 gal Zn	M 20 x 300	S	1	2300,00 gal Zn
M 12 x 50	S	100	47,50 gal Zn	M 16 x 170	S	25	520,00 gal Zn	M 20 x 310	S	1	2490,00 gal Zn
M 12 x 55	S	100	49,50 gal Zn	M 16 x 180	S	25	520,00 gal Zn	M 20 x 320	S	1	2440,00 gal Zn
M 12 x 60	S	100	53,00 gal Zn	M 16 x 190	S	25	600,00 gal Zn	M 20 x 330	S	1	2550,00 gal Zn
M 12 x 65	S	50	57,00 gal Zn	M 16 x 200	S	25	610,00 gal Zn	M 20 x 340	S	1	2650,00 gal Zn
M 12 x 70	S	50	59,00 gal Zn	M 16 x 210	S	25	760,00 gal Zn	M 20 x 350	S	1	2850,00 gal Zn
M 12 x 75	S	50	62,00 gal Zn	M 16 x 220	S	1	760,00 gal Zn	M 20 x 360	S	1	2850,00 gal Zn
M 12 x 80	S	50	65,00 gal Zn	M 16 x 230	S	1	840,00 gal Zn	M 20 x 380	S	1	3050,00 gal Zn
M 12 x 85	S	50	81,00 gal Zn	M 16 x 240	S	1	850,00 gal Zn	M 20 x 390	S	1	3200,00 gal Zn
M 12 x 90	S	50	74,00 gal Zn	M 16 x 250	S	1	950,00 gal Zn	M 20 x 400	S	1	3200,00 gal Zn
M 12 x 95	S	50	88,00 gal Zn	M 16 x 260	S	1	950,00 gal Zn	M 20 x 420	S	1	3250,00 gal Zn
M 12 x 100	S	50	90,00 gal Zn	M 16 x 270	S	1	1260,00 gal Zn	M 20 x 430	S	1	4000,00 gal Zn
M 12 x 110	S	50	132,00 gal Zn	M 16 x 280	S	1	1270,00 gal Zn	M 20 x 440	S	1	4000,00 gal Zn
M 12 x 115	S	50	233,00 gal Zn	M 16 x 290	S	1	1410,00 gal Zn	M 20 x 450	S	1	4050,00 gal Zn
M 12 x 120	S	50	144,00 gal Zn	M 16 x 300	S	1	1420,00 gal Zn	M 20 x 460	S	1	4050,00 gal Zn
M 12 x 130	S	50	160,00 gal Zn	M 16 x 310	S	1	1670,00 gal Zn	M 20 x 480	S	1	4100,00 gal Zn
M 12 x 140	S	50	216,00 gal Zn	M 16 x 320	S	1	1590,00 gal Zn	M 20 x 500	S	1	4150,00 gal Zn
M 12 x 150	S	50	209,00 gal Zn	M 16 x 330	S	1	1780,00 gal Zn	M 22 x 70	S	25	590,00 gal Zn
M 12 x 160	S	25	460,00 gal Zn	M 16 x 340	S	1	1610,00 gal Zn	M 22 x 75	S	25	620,00 gal Zn
M 12 x 170	S	25	350,00 gal Zn	M 16 x 350	S	1	1990,00 gal Zn	M 22 x 80	S	25	620,00 gal Zn
M 12 x 180	S	25	255,00 gal Zn	M 16 x 360	S	1	1790,00 gal Zn	M 22 x 90	S	25	650,00 gal Zn
M 12 x 190	S	25	410,00 gal Zn	M 16 x 370	S	1	2390,00 gal Zn	M 22 x 100	S	10	710,00 gal Zn
M 12 x 200	S	25	445,00 gal Zn	M 16 x 380	S	1	2200,00 gal Zn	M 22 x 110	S	10	760,00 gal Zn
M 12 x 210	S	25	500,00 gal Zn	M 16 x 390	S	1	2700,00 gal Zn	M 22 x 120	S	10	820,00 gal Zn
M 12 x 220	S	25	500,00 gal Zn	M 16 x 400	S	1	2480,00 gal Zn	M 22 x 130	S	10	870,00 gal Zn
M 12 x 230	S	25	670,00 gal Zn	M 16 x 420	S	1	2800,00 gal Zn	M 22 x 140	S	10	880,00 gal Zn
M 12 x 240	S	25	680,00 gal Zn	M 16 x 430	S	1	3400,00 gal Zn	M 22 x 150	S	10	1020,00 gal Zn
M 12 x 250	S	25	760,00 gal Zn	M 16 x 440	S	1	3150,00 gal Zn	M 22 x 160	S	10	1140,00 gal Zn
M 12 x 260	S	25	740,00 gal Zn	M 18 x 65	S	25	320,00 gal Zn	M 22 x 180	S	10	1410,00 gal Zn
M 12 x 270	S	25	820,00 gal Zn	M 18 x 70	S	25	335,00 gal Zn	M 22 x 200	S	10	1740,00 gal Zn
M 12 x 280	S	25	810,00 gal Zn	M 18 x 75	S	25	345,00 gal Zn	M 22 x 240	S	1	2180,00 gal Zn
M 12 x 290	S	25	840,00 gal Zn	M 18 x 80	S	25	345,00 gal Zn	M 22 x 260	S	1	2650,00 gal Zn
M 12 x 300	S	25	880,00 gal Zn	M 18 x 90	S	25	375,00 gal Zn	M 22 x 280	S	1	2950,00 gal Zn
M 12 x 310	S	25	1360,00 gal Zn	M 18 x 95	S	25	405,00 gal Zn	M 22 x 300	S	1	3250,00 gal Zn
M 12 x 320	S	25	1260,00 gal Zn	M 18 x 100	S	25	410,00 gal Zn	M 24 x 75	S	25	305,00 gal Zn
M 12 x 330	S	1	1780,00 gal Zn	M 18 x 110	S	25	460,00 gal Zn	M 24 x 80	S	25	310,00 gal Zn
M 14 x 50	S	100	113,00 gal Zn	M 18 x 120	S	25	470,00 gal Zn	M 24 x 85	S	10	385,00 gal Zn
M 14 x 55	S	50	120,00 gal Zn	M 18 x 130	S	25	510,00 gal Zn	M 24 x 90	S	10	370,00 gal Zn
M 14 x 60	S	50	123,00 gal Zn	M 18 x 140	S	25	610,00 gal Zn	M 24 x 95	S	10	395,00 gal Zn
M 14 x 65	S	50	134,00 gal Zn	M 18 x 150	S	25	620,00 gal Zn	M 24 x 100	S	10	400,00 gal Zn
M 14 x 70	S	50	136,00 gal Zn	M 18 x 160	S	25	690,00 gal Zn	M 24 x 110	S	10	600,00 gal Zn
M 14 x 75	S	50	163,00 gal Zn	M 18 x 170	S	25	910,00 gal Zn	M 24 x 120	S	10	640,00 gal Zn
M 14 x 80	S	50	170,00 gal Zn	M 18 x 180	S	25	910,00 gal Zn	M 24 x 130	S	10	660,00 gal Zn
M 14 x 85	S	50	187,00 gal Zn	M 18 x 190	S	1	1230,00 gal Zn	M 24 x 140	S	10	850,00 gal Zn
M 14 x 90	S	50	189,00 gal Zn	M 18 x 200	S	1	1240,00 gal Zn	M 24 x 150	S	10	920,00 gal Zn
M 14 x 95	S	50	210,00 gal Zn	M 18 x 220	S	1	1460,00 gal Zn	M 24 x 160	S	10	1010,00 gal Zn
M 14 x 100	S	50	211,00 gal Zn	M 18 x 230	S	1	1620,00 gal Zn	M 24 x 170	S	1	1240,00 gal Zn
M 14 x 110	S	50	241,00 gal Zn	M 18 x 240	S	1	1630,00 gal Zn	M 24 x 180	S	1	1250,00 gal Zn
M 14 x 120	S	50	275,00 gal Zn	M 20 x 65	S	25	172,00 gal Zn	M 24 x 190	S	1	1700,00 gal Zn
M 14 x 130	S	50	310,00 gal Zn	M 20 x 70	S	25	177,00 gal Zn	M 24 x 200	S	1	1710,00 gal Zn
M 14 x 140	S	25	335,00 gal Zn	M 20 x 75	S	25	186,00 gal Zn	M 24 x 210	S	1	1980,00 gal Zn
M 14 x 150	S	25	365,00 gal Zn	M 20 x 80	S	25	193,00 gal Zn	M 24 x 220	S	1	2140,00 gal Zn
M 14 x 160	S	25	405,00 gal Zn	M 20 x 85	S	25	210,00 gal Zn	M 24 x 230	S	1	2190,00 gal Zn
M 14 x 170	S	25	460,00 gal Zn	M 20 x 90	S	25	212,00 gal Zn	M 24 x 240	S	1	2300,00 gal Zn
M 14 x 180	S	25	465,00 gal Zn	M 20 x 95	S	25	250,00 gal Zn	M 24 x 250	S	1	2420,00 gal Zn
M 14 x 190	S	25	550,00 gal Zn	M 20 x 100	S	25	255,00 gal Zn	M 24 x 260	S	1	2370,00 gal Zn
M 14 x 200	S	25	550,00 gal Zn	M 20 x 110	S	25	385,00 gal Zn	M 24 x 270	S	1	2850,00 gal Zn
M 14 x 220	S	25	690,00 gal Zn	M 20 x 120	S	25	405,00 gal Zn	M 24 x 280	S	1	2800,00 gal Zn
M 14 x 240	S	25	760,00 gal Zn	M 20 x 130	S	25	410,00 gal Zn	M 24 x 300	S	1	3050,00 gal Zn
M 16 x 50	S	50	89,00 gal Zn	M 20 x 140	S	25	530,00 gal Zn	M 24 x 310	S	1	3200,00 gal Zn
M 16 x 55	S	50	89,00 gal Zn	M 20 x 150	S	25	590,00 gal Zn	M 24 x 320	S	1	3100,00 gal Zn
M 16 x 60	S	50	92,00 gal Zn	M 20 x 160	S	10	650,00 gal Zn	M 24 x 330	S	1	3250,00 gal Zn
M 16 x 65	S	25	99,00 gal Zn	M 20 x 170	S	10	810,00 gal Zn	M 24 x 340	S	1	3200,00 gal Zn
M 16 x 70	S	25	104,00 gal Zn	M 20 x 180	S	10	810,00 gal Zn	M 24 x 350	S	1	3400,00 gal Zn

Abmessungen	VE	Stück	€/100/0bf.
M 24 x 360	S	1	3350,00 gal Zn
M 24 x 380	S	1	3550,00 gal Zn
M 24 x 390	S	1	3850,00 gal Zn
M 24 x 400	S	1	3900,00 gal Zn
M 24 x 410	S	1	4150,00 gal Zn
M 24 x 420	S	1	4150,00 gal Zn
M 24 x 430	S	1	4400,00 gal Zn
M 24 x 440	S	1	4400,00 gal Zn
M 24 x 450	S	1	4700,00 gal Zn
M 27 x 80	S	10	760,00 gal Zn
M 27 x 90	S	10	920,00 gal Zn
M 27 x 100	S	10	1070,00 gal Zn
M 27 x 110	S	1	1230,00 gal Zn
M 27 x 120	S	1	1240,00 gal Zn
M 27 x 130	S	1	1320,00 gal Zn
M 27 x 140	S	1	1340,00 gal Zn
M 27 x 150	S	1	1390,00 gal Zn
M 27 x 160	S	1	1400,00 gal Zn
M 27 x 170	S	1	1470,00 gal Zn
M 27 x 180	S	1	1480,00 gal Zn
M 27 x 190	S	1	1730,00 gal Zn
M 27 x 200	S	1	1740,00 gal Zn
M 27 x 220	S	1	2450,00 gal Zn
M 27 x 230	S	1	2550,00 gal Zn
M 27 x 240	S	1	2650,00 gal Zn
M 27 x 260	S	1	2850,00 gal Zn
M 27 x 270	S	1	3050,00 gal Zn
M 27 x 280	S	1	3100,00 gal Zn
M 27 x 300	S	1	3500,00 gal Zn
M 27 x 320	S	1	4450,00 gal Zn
M 30 x 80	S	1	1810,00 gal Zn
M 30 x 90	S	1	1780,00 gal Zn
M 30 x 100	S	1	1800,00 gal Zn
M 30 x 110	S	1	2110,00 gal Zn
M 30 x 120	S	1	2130,00 gal Zn
M 30 x 130	S	1	2340,00 gal Zn
M 30 x 140	S	1	2360,00 gal Zn
M 30 x 150	S	1	2450,00 gal Zn
M 30 x 160	S	1	2460,00 gal Zn
M 30 x 170	S	1	2700,00 gal Zn
M 30 x 180	S	1	2750,00 gal Zn
M 30 x 190	S	1	2900,00 gal Zn
M 30 x 200	S	1	2950,00 gal Zn
M 30 x 210	S	1	3050,00 gal Zn
M 30 x 220	S	1	3050,00 gal Zn
M 30 x 230	S	1	3100,00 gal Zn
M 30 x 240	S	1	3250,00 gal Zn
M 30 x 250	S	1	3500,00 gal Zn
M 30 x 260	S	1	3600,00 gal Zn
M 30 x 280	S	1	3650,00 gal Zn
M 30 x 290	S	1	3300,00 gal Zn
M 30 x 300	S	1	3800,00 gal Zn
M 30 x 310	S	1	4100,00 gal Zn
M 30 x 320	S	1	4350,00 gal Zn
M 30 x 330	S	1	4600,00 gal Zn
M 30 x 340	S	1	4600,00 gal Zn
M 30 x 350	S	1	4900,00 gal Zn
M 30 x 360	S	1	4900,00 gal Zn
M 30 x 380	S	1	5200,00 gal Zn
M 33 x 100	S	1	2080,00 gal Zn
M 33 x 110	S	1	2200,00 gal Zn
M 33 x 120	S	1	2320,00 gal Zn
M 33 x 130	S	1	2430,00 gal Zn
M 33 x 140	S	1	2550,00 gal Zn
M 33 x 150	S	1	2650,00 gal Zn
M 33 x 160	S	1	3100,00 gal Zn
M 33 x 170	S	1	3200,00 gal Zn
M 33 x 180	S	1	3200,00 gal Zn
M 33 x 190	S	1	3300,00 gal Zn
M 33 x 200	S	1	3350,00 gal Zn
M 33 x 210	S	1	3450,00 gal Zn
M 33 x 220	S	1	3450,00 gal Zn
M 33 x 240	S	1	3700,00 gal Zn
M 33 x 260	S	1	4250,00 gal Zn
M 33 x 280	S	1	4450,00 gal Zn

Abmessungen	VE	Stück	€/100/0bf.
M 33 x 300	S	1	4700,00 gal Zn
M 36 x 110	S	1	2650,00 gal Zn
M 36 x 120	S	1	2800,00 gal Zn
M 36 x 130	S	1	2950,00 gal Zn
M 36 x 140	S	1	3100,00 gal Zn
M 36 x 150	S	1	3250,00 gal Zn
M 36 x 160	S	1	3550,00 gal Zn
M 36 x 170	S	1	3800,00 gal Zn
M 36 x 180	S	1	3800,00 gal Zn
M 36 x 190	S	1	4050,00 gal Zn
M 36 x 200	S	1	4050,00 gal Zn
M 36 x 210	S	1	4250,00 gal Zn
M 36 x 220	S	1	4250,00 gal Zn
M 36 x 230	S	1	4650,00 gal Zn
M 36 x 240	S	1	4650,00 gal Zn
M 36 x 250	S	1	4900,00 gal Zn
M 36 x 260	S	1	4900,00 gal Zn
M 36 x 270	S	1	5300,00 gal Zn
M 36 x 280	S	1	5200,00 gal Zn
M 36 x 300	S	1	5400,00 gal Zn
M 36 x 320	S	1	6600,00 gal Zn
M 36 x 360	S	1	7100,00 gal Zn
M 36 x 400	S	1	7500,00 gal Zn
M 39 x 140	S	1	4650,00 gal Zn
M 39 x 150	S	1	4900,00 gal Zn
M 39 x 160	S	1	5100,00 gal Zn
M 39 x 170	S	1	5300,00 gal Zn
M 39 x 180	S	1	5600,00 gal Zn
M 39 x 190	S	1	5800,00 gal Zn
M 39 x 200	S	1	6100,00 gal Zn
M 42 x 120	S	1	4600,00 gal Zn
M 42 x 130	S	1	5000,00 gal Zn
M 42 x 140	S	1	5200,00 gal Zn
M 42 x 150	S	1	5600,00 gal Zn
M 42 x 160	S	1	5700,00 gal Zn
M 42 x 170	S	1	6000,00 gal Zn
M 42 x 180	S	1	6300,00 gal Zn
M 42 x 190	S	1	6500,00 gal Zn
M 42 x 200	S	1	6700,00 gal Zn
M 42 x 220	S	1	7400,00 gal Zn
M 42 x 240	S	1	7900,00 gal Zn
M 42 x 250	S	1	8400,00 gal Zn
M 42 x 260	S	1	8400,00 gal Zn
M 42 x 280	S	1	9300,00 gal Zn
M 48 x 140	S	1	8100,00 gal Zn
M 48 x 150	S	1	8700,00 gal Zn
M 48 x 160	S	1	9100,00 gal Zn
M 48 x 170	S	1	9400,00 gal Zn
M 48 x 180	S	1	9500,00 gal Zn
M 48 x 200	S	1	10100,00 gal Zn
M 48 x 220	S	1	10700,00 gal Zn
M 48 x 240	S	1	11400,00 gal Zn

Abmessungen	VE	Stück	€/100/0bf.
ISO			04014.870
4014			8.8
			galv. verz. 8 DisP**

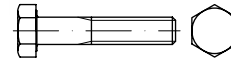

Sechskantschrauben mit Schaft

kurze Abmessungen z. T. Gewinde bis Kopf,
 *M 10/12/14/22 = RAZ 3220 übrige = RAZ 401,
 **< M 6 Mindestschichtdicke 5µm,
 Korrosionsbeständigkeit NSS: 72h WR, 120h RR

Maße → TI-15 Anziehmomente → TI-244
 Werkstoffeigensch. → TI-232 Normumstellung → TI-6
 Korrosionsschutz → TI-228

Rostfrei → S. 529
 Messing → S. 636

ISO 4014 → ersetzt DIN 931



M 5 x 40	S	200	20,90 gal ZnDi
M 5 x 45	S	200	21,60 gal ZnDi
M 5 x 50	S	200	23,90 gal ZnDi
M 6 x 30	S	500	10,50 gal ZnDi
M 6 x 35	S	200	11,80 gal ZnDi
M 6 x 40	S	200	13,30 gal ZnDi
M 6 x 45	S	200	14,80 gal ZnDi
M 6 x 50	S	200	17,30 gal ZnDi
M 6 x 55	S	200	21,40 gal ZnDi
M 6 x 60	S	200	22,90 gal ZnDi
M 6 x 65	S	200	30,50 gal ZnDi
M 6 x 70	S	200	36,50 gal ZnDi
M 6 x 75	S	200	39,50 gal ZnDi
M 6 x 80	S	200	48,00 gal ZnDi
M 6 x 90	S	100	63,00 gal ZnDi
M 6 x 100	S	100	78,00 gal ZnDi
M 6 x 110	S	100	80,00 gal ZnDi
M 6 x 120	S	100	98,00 gal ZnDi
M 8 x 35	S	200	19,40 gal ZnDi
M 8 x 40	S	200	21,80 gal ZnDi
M 8 x 45	S	200	24,50 gal ZnDi
M 8 x 50	S	200	26,50 gal ZnDi
M 8 x 55	S	200	27,00 gal ZnDi
M 8 x 60	S	200	29,00 gal ZnDi
M 8 x 65	S	200	32,50 gal ZnDi
M 8 x 70	S	200	33,50 gal ZnDi
M 8 x 75	S	200	40,00 gal ZnDi
M 8 x 80	S	200	42,00 gal ZnDi
M 8 x 85	S	100	65,00 gal ZnDi
M 8 x 90	S	100	67,00 gal ZnDi
M 8 x 100	S	100	89,00 gal ZnDi
M 8 x 110	S	100	102,00 gal ZnDi
M 8 x 120	S	100	119,00 gal ZnDi
M 8 x 130	S	100	130,00 gal ZnDi
M 8 x 140	S	50	93,00 gal ZnDi
M 8 x 150	S	100	184,00 gal ZnDi
M 10 x 40	S	100	37,00 gal ZnDi
M 10 x 45	S	100	39,00 gal ZnDi
M 10 x 50	S	100	41,00 gal ZnDi
M 10 x 55	S	100	44,50 gal ZnDi
M 10 x 60	S	100	46,00 gal ZnDi
M 10 x 65	S	100	49,50 gal ZnDi
M 10 x 70	S	100	51,00 gal ZnDi
M 10 x 75	S	100	56,00 gal ZnDi
M 10 x 80	S	100	57,00 gal ZnDi
M 10 x 85	S	100	71,00 gal ZnDi
M 10 x 90	S	100	72,00 gal ZnDi
M 10 x 95	S	100	81,00 gal ZnDi



- ✓ Große Artikelvielfalt
- ✓ Verlässliche Qualität
- ✓ Hohe Lieferbereitschaft

Abmessungen	VE	Stück	€/100/Obf.
M 16 x 280	S	25	1280,00 gal ZnDi
M 16 x 300	S	25	1540,00 gal ZnDi
M 16 x 320	S	10	1800,00 gal ZnDi
M 16 x 360	S	10	2050,00 gal ZnDi
M 16 x 480	S	10	2850,00 gal ZnDi
M 18 x 70	S	25	425,00 gal ZnDi
M 20 x 65	S	25	207,00 gal ZnDi
M 20 x 70	S	25	212,00 gal ZnDi
M 20 x 75	S	25	223,00 gal ZnDi
M 20 x 80	S	25	231,00 gal ZnDi
M 20 x 90	S	25	255,00 gal ZnDi
M 20 x 100	S	25	305,00 gal ZnDi
M 20 x 105	S	25	370,00 gal ZnDi
M 20 x 110	S	25	460,00 gal ZnDi
M 20 x 120	S	25	485,00 gal ZnDi
M 20 x 130	S	25	495,00 gal ZnDi
M 20 x 140	S	25	640,00 gal ZnDi
M 20 x 150	S	25	660,00 gal ZnDi
M 20 x 160	S	10	770,00 gal ZnDi
M 20 x 170	S	10	860,00 gal ZnDi
M 20 x 180	S	10	950,00 gal ZnDi
M 20 x 190	S	10	1460,00 gal ZnDi
M 20 x 200	S	1	1580,00 gal ZnDi
M 20 x 210	S	1	1710,00 gal ZnDi
M 20 x 220	S	1	1850,00 gal ZnDi
M 20 x 230	S	10	1930,00 gal ZnDi
M 20 x 240	S	1	1960,00 gal ZnDi
M 20 x 260	S	10	2130,00 gal ZnDi
M 20 x 280	S	10	2290,00 gal ZnDi
M 20 x 300	S	10	2600,00 gal ZnDi
M 24 x 75	S	25	365,00 gal ZnDi
M 24 x 80	S	25	375,00 gal ZnDi
M 24 x 90	S	10	440,00 gal ZnDi
M 24 x 100	S	10	480,00 gal ZnDi
M 24 x 110	S	10	710,00 gal ZnDi
M 24 x 120	S	10	770,00 gal ZnDi
M 24 x 130	S	10	790,00 gal ZnDi
M 24 x 140	S	10	1020,00 gal ZnDi
M 24 x 150	S	10	1100,00 gal ZnDi
M 24 x 180	S	1	1500,00 gal ZnDi
M 24 x 200	S	1	2050,00 gal ZnDi
M 24 x 300	S	1	4250,00 gal ZnDi
M 27 x 180	S	1	1720,00 gal ZnDi
M 30 x 170	S	1	3400,00 gal ZnDi

Abmessungen	VE	Stück	€/100/Obf.
ISO 04014.353			
4014			8.8
			flZn/TL480h



Sechskantschrauben mit Schaft

kurze Abmessungen z. T. Gewinde bis Kopf,
TL = Schmierstoff im Topcoat mit $\mu = 0,09 - 0,14$,
Korrosionsbeständigkeit NSS: 480h RR,
Chrom(VI)-frei

Achtung! Gegenüber galv. verzinkt geänderte Anziehdrehmomente.

Maße → **TI-15** Anziehdrehmomente → **TI-245**
Werkstoffeigensch. → **TI-232** Normumstellung → **TI-6**
Korrosionsschutz → **TI-230**

Rostfrei → **S. 529**
Messing → **S. 636**

ISO 4014 → ersetzt DIN 931



M 6 x 30	S	500	10,90 flZn
M 6 x 35	S	200	12,30 flZn
M 6 x 40	S	200	13,80 flZn
M 6 x 45	S	200	15,40 flZn
M 6 x 50	S	200	18,00 flZn
M 6 x 55	S	200	22,30 flZn
M 6 x 60	S	200	23,80 flZn
M 6 x 65	S	200	37,50 flZn
M 6 x 70	S	200	37,50 flZn
M 6 x 75	S	200	41,00 flZn
M 6 x 80	S	200	50,00 flZn
M 8 x 35	S	200	21,20 flZn
M 8 x 40	S	200	22,70 flZn
M 8 x 45	S	200	25,50 flZn
M 8 x 50	S	200	27,50 flZn
M 8 x 55	S	200	28,50 flZn
M 8 x 60	S	200	30,00 flZn
M 8 x 65	S	200	33,50 flZn
M 8 x 70	S	200	34,50 flZn
M 8 x 75	S	200	42,00 flZn
M 8 x 80	S	200	44,00 flZn
M 8 x 90	S	100	69,00 flZn
M 8 x 100	S	100	92,00 flZn
M 10 x 40	S	100	38,00 flZn
M 10 x 45	S	100	40,50 flZn
M 10 x 50	S	100	42,50 flZn
M 10 x 55	S	100	46,00 flZn
M 10 x 60	S	100	49,50 flZn
M 10 x 65	S	100	51,00 flZn
M 10 x 70	S	100	58,00 flZn
M 10 x 75	S	100	63,00 flZn
M 10 x 80	S	100	69,00 flZn
M 10 x 90	S	100	74,00 flZn
M 10 x 100	S	100	85,00 flZn
M 10 x 110	S	50	128,00 flZn
M 10 x 120	S	50	143,00 flZn
M 12 x 45	S	100	59,00 flZn
M 12 x 50	S	100	64,00 flZn
M 12 x 55	S	100	69,00 flZn
M 12 x 60	S	100	74,00 flZn
M 12 x 65	S	50	76,00 flZn
M 12 x 70	S	50	81,00 flZn
M 12 x 75	S	50	89,00 flZn
M 12 x 80	S	50	96,00 flZn
M 12 x 90	S	50	117,00 flZn
M 12 x 100	S	50	127,00 flZn

Abmessungen	VE	Stück	€/100/Obf.
M 12 x 110	S	50	172,00 flZn
M 12 x 120	S	50	188,00 flZn
M 16 x 55	S	50	116,00 flZn
M 16 x 60	S	50	133,00 flZn
M 16 x 65	S	25	136,00 flZn
M 16 x 70	S	25	139,00 flZn
M 16 x 75	S	25	143,00 flZn
M 16 x 80	S	25	152,00 flZn
M 16 x 90	S	25	170,00 flZn
M 16 x 100	S	25	203,00 flZn
M 16 x 110	S	25	300,00 flZn
M 16 x 120	S	25	330,00 flZn
M 16 x 130	S	25	350,00 flZn
M 16 x 140	S	25	445,00 flZn
M 20 x 65	S	25	224,00 flZn
M 20 x 70	S	25	230,00 flZn
M 20 x 75	S	25	241,00 flZn
M 20 x 80	S	25	255,00 flZn
M 20 x 90	S	25	310,00 flZn
M 20 x 100	S	25	330,00 flZn
M 20 x 110	S	25	500,00 flZn
M 20 x 120	S	25	530,00 flZn
M 20 x 130	S	25	540,00 flZn
M 20 x 140	S	25	690,00 flZn
M 20 x 150	S	25	760,00 flZn
M 20 x 160	S	10	840,00 flZn
M 20 x 170	S	10	1050,00 flZn
M 20 x 180	S	10	1060,00 flZn
M 24 x 75	S	25	395,00 flZn
M 24 x 80	S	25	530,00 flZn
M 24 x 90	S	10	560,00 flZn
M 24 x 100	S	10	770,00 flZn
M 24 x 110	S	10	800,00 flZn
M 24 x 120	S	10	830,00 flZn
M 24 x 130	S	10	850,00 flZn
M 24 x 140	S	10	1100,00 flZn
M 24 x 150	S	10	1200,00 flZn
M 24 x 160	S	10	1310,00 flZn
M 24 x 170	S	1	1610,00 flZn
M 24 x 180	S	1	1630,00 flZn

Abmessungen	VE	Stück	€/100/Obf.
ISO 04014.820			
4014			8.8
			feuerverzinkt

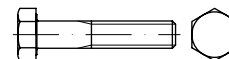

Sechskantschrauben mit Schaft

kurze Abmessungen z. T. Gewinde bis Kopf,
Gewindetoleranz 6h (6az + tZn = U),
*M 10/12/14/22 = RAZ 3230 übrige \varnothing = RAZ 403

Maße → **TI-15** Anziehdrehmomente → **TI-244**
Werkstoffeigensch. → **TI-232** Normumstellung → **TI-6**
Korrosionsschutz → **TI-231**

Rostfrei → **S. 529**
Messing → **S. 636**

ISO 4014 → ersetzt DIN 931

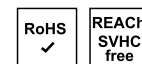

M 8 x 35	S	200	115,00 tZn
M 8 x 40	S	200	126,00 tZn
M 8 x 45	S	200	132,00 tZn
M 8 x 50	S	200	151,00 tZn
M 8 x 60	S	200	167,00 tZn
M 8 x 65	S	200	184,00 tZn
M 8 x 70	S	200	195,00 tZn
M 8 x 80	S	200	315,00 tZn



- ✓ Große Artikelvielfalt
- ✓ Verlässliche Qualität
- ✓ Hohe Lieferbereitschaft

Abmessungen	VE	Stück	€/100/Obf.
M 8 x 100	S	200	350,00 tzn
M 10 x 40	S	100	78,00 tzn
M 10 x 45	S	100	84,00 tzn
M 10 x 50	S	100	88,00 tzn
M 10 x 55	S	100	95,00 tzn
M 10 x 60	S	100	99,00 tzn
M 10 x 65	S	100	107,00 tzn
M 10 x 70	S	100	110,00 tzn
M 10 x 75	S	100	119,00 tzn
M 10 x 80	S	100	123,00 tzn
M 10 x 90	S	100	153,00 tzn
M 10 x 100	S	100	172,00 tzn
M 10 x 110	S	50	260,00 tzn
M 10 x 120	S	50	214,00 tzn
M 12 x 45	S	100	121,00 tzn
M 12 x 50	S	100	128,00 tzn
M 12 x 55	S	100	138,00 tzn
M 12 x 60	S	100	143,00 tzn
M 12 x 65	S	50	153,00 tzn
M 12 x 70	S	50	158,00 tzn
M 12 x 75	S	50	167,00 tzn
M 12 x 80	S	50	176,00 tzn
M 12 x 90	S	50	200,00 tzn
M 12 x 100	S	50	236,00 tzn
M 12 x 110	S	50	315,00 tzn
M 12 x 120	S	50	340,00 tzn
M 12 x 130	S	50	112,00 tzn
M 12 x 140	S	50	495,00 tzn
M 12 x 150	S	50	560,00 tzn
M 12 x 160	S	25	700,00 tzn
M 12 x 180	S	25	246,00 tzn
M 12 x 200	S	25	990,00 tzn
M 16 x 55	S	50	241,00 tzn
M 16 x 60	S	50	255,00 tzn
M 16 x 65	S	25	275,00 tzn
M 16 x 70	S	25	285,00 tzn
M 16 x 75	S	25	305,00 tzn
M 16 x 80	S	25	320,00 tzn
M 16 x 90	S	25	385,00 tzn
M 16 x 100	S	25	415,00 tzn
M 16 x 110	S	25	550,00 tzn
M 16 x 120	S	25	600,00 tzn
M 16 x 130	S	25	630,00 tzn
M 16 x 140	S	25	800,00 tzn
M 16 x 150	S	25	880,00 tzn
M 16 x 160	S	25	980,00 tzn
M 16 x 180	S	25	1180,00 tzn
M 16 x 190	S	25	1400,00 tzn
M 16 x 200	S	25	1360,00 tzn
M 16 x 220	S	1	1700,00 tzn
M 16 x 240	S	1	1910,00 tzn
M 16 x 260	S	1	2140,00 tzn
M 16 x 300	S	1	3150,00 tzn
M 20 x 65	S	25	470,00 tzn
M 20 x 70	S	25	480,00 tzn
M 20 x 75	S	25	510,00 tzn
M 20 x 80	S	25	530,00 tzn
M 20 x 85	S	25	1050,00 tzn
M 20 x 90	S	25	580,00 tzn
M 20 x 100	S	25	670,00 tzn
M 20 x 110	S	25	910,00 tzn
M 20 x 120	S	25	960,00 tzn
M 20 x 130	S	25	980,00 tzn
M 20 x 140	S	25	1230,00 tzn
M 20 x 150	S	25	1350,00 tzn
M 20 x 160	S	10	1490,00 tzn
M 20 x 180	S	10	1850,00 tzn
M 20 x 200	S	10	2700,00 tzn
M 20 x 210	S	1	3150,00 tzn
M 20 x 220	S	1	3250,00 tzn
M 20 x 240	S	1	3600,00 tzn
M 20 x 260	S	1	4000,00 tzn
M 20 x 300	S	1	5100,00 tzn
M 24 x 75	S	25	810,00 tzn
M 24 x 80	S	25	840,00 tzn

Abmessungen	VE	Stück	€/100/Obf.
M 24 x 85	S	10	2550,00 tzn
M 24 x 90	S	10	980,00 tzn
M 24 x 95	S	10	2550,00 tzn
M 24 x 100	S	10	1050,00 tzn
M 24 x 110	S	10	1400,00 tzn
M 24 x 120	S	10	1500,00 tzn
M 24 x 130	S	10	1550,00 tzn
M 24 x 140	S	10	1990,00 tzn
M 24 x 150	S	10	2140,00 tzn
M 24 x 160	S	10	2320,00 tzn
M 24 x 180	S	1	2850,00 tzn
M 24 x 200	S	1	3850,00 tzn
M 24 x 220	S	1	4750,00 tzn
M 24 x 240	S	1	5100,00 tzn
M 24 x 260	S	1	5300,00 tzn
M 24 x 300	S	1	6700,00 tzn
M 27 x 90	S	10	2080,00 tzn
M 27 x 100	S	10	2470,00 tzn
M 27 x 110	S	1	2900,00 tzn
M 27 x 120	S	1	3000,00 tzn
M 27 x 130	S	1	3000,00 tzn
M 27 x 140	S	1	3100,00 tzn
M 27 x 150	S	1	3150,00 tzn
M 27 x 160	S	1	3200,00 tzn
M 27 x 180	S	1	3600,00 tzn
M 27 x 200	S	1	4600,00 tzn
M 30 x 90	S	1	4000,00 tzn
M 30 x 100	S	1	4000,00 tzn
M 30 x 110	S	1	4650,00 tzn
M 30 x 120	S	1	4750,00 tzn
M 30 x 130	S	1	5200,00 tzn
M 30 x 140	S	1	5300,00 tzn
M 30 x 150	S	1	5500,00 tzn
M 30 x 160	S	1	5500,00 tzn
M 30 x 180	S	1	6100,00 tzn
M 30 x 200	S	1	6600,00 tzn
M 30 x 220	S	1	7500,00 tzn
M 30 x 240	S	1	8700,00 tzn
M 30 x 260	S	1	9800,00 tzn
M 30 x 280	S	1	10900,00 tzn
M 30 x 300	S	1	12300,00 tzn
M 33 x 120	S	1	5600,00 tzn
M 33 x 130	S	1	6000,00 tzn
M 33 x 140	S	1	6100,00 tzn
M 33 x 180	S	1	7100,00 tzn
M 33 x 200	S	1	7500,00 tzn
M 36 x 120	S	1	6200,00 tzn
M 36 x 130	S	1	6600,00 tzn
M 36 x 140	S	1	6900,00 tzn
M 36 x 150	S	1	7200,00 tzn
M 36 x 160	S	1	7900,00 tzn
M 36 x 180	S	1	8400,00 tzn
M 36 x 190	S	1	8800,00 tzn
M 36 x 200	S	1	8900,00 tzn
M 36 x 220	S	1	9200,00 tzn

Abmessungen	VE	Stück	€/100/Obf.
ISO		04014.809	
4014	8.8		AD W7
	-50 bis +300 °C		

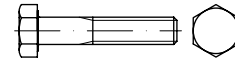

Sechskantschrauben mit Schaft, verwendbar bei -50 bis zu +300 °C

mit Abnahmeprüfzeugnis 3.1, Preise gelten zzgl. APZ-Kosten

Werkstoffe nicht geeignet für den Einsatz nach AD-Merkblatt W10

Maße → **TI-15** Anziehmomente → **TI-244**
 Werkstoffeigensch. → **TI-232** Normumstellung → **TI-6**

ISO 4014 → ersetzt DIN 931

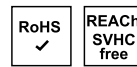

M 8 x 35	S	200	14,80
M 8 x 40	S	200	16,70
M 10 x 45	S	100	29,00
M 10 x 50	S	100	30,50
M 10 x 55	S	100	33,00
M 10 x 60	S	100	34,00
M 10 x 65	S	100	36,50
M 10 x 70	S	100	37,00
M 10 x 75	S	100	41,00
M 10 x 80	S	100	41,00
M 10 x 90	S	100	56,00
M 10 x 100	S	100	64,00
M 10 x 120	S	50	111,00
M 12 x 50	S	100	44,50
M 12 x 55	S	100	45,50
M 12 x 60	S	100	48,50
M 12 x 65	S	50	53,00
M 12 x 70	S	50	54,00
M 12 x 75	S	50	57,00
M 12 x 80	S	50	60,00
M 12 x 90	S	50	69,00
M 12 x 100	S	50	86,00
M 12 x 110	S	50	129,00
M 12 x 120	S	50	140,00
M 16 x 55	S	50	162,00
M 16 x 60	S	50	83,00
M 16 x 65	S	25	88,00
M 16 x 70	S	25	188,00
M 16 x 75	S	25	99,00
M 16 x 80	S	25	105,00
M 16 x 90	S	25	117,00
M 16 x 100	S	25	145,00
M 16 x 110	S	25	218,00
M 16 x 120	S	25	242,00
M 16 x 130	S	25	260,00
M 16 x 140	S	25	350,00
M 20 x 65	S	25	158,00
M 20 x 70	S	25	161,00
M 20 x 75	S	25	168,00
M 20 x 80	S	25	174,00
M 20 x 90	S	25	193,00
M 20 x 100	S	25	237,00
M 20 x 110	S	25	370,00
M 20 x 120	S	25	385,00
M 20 x 130	S	25	390,00
M 20 x 140	S	25	540,00
M 20 x 150	S	25	600,00
M 20 x 160	S	10	670,00
M 20 x 170	S	10	870,00

Achtung!

Feuerverzinkte Schrauben-/Muttern-Garnituren dürfen nur miteinander verschraubt werden, wenn Gewindespiel/-Toleranzen dieser Garnituren entsprechend ISO 10684 passend aufeinander abgestimmt sind.
 Die Verwendung mit anderen Schrauben-/Muttern-Ausführungen kann zu Verschraubungsproblemen und/oder zum Versagen der Verbindung führen.



Abmessungen	VE	Stück	€/100/Obf.
M 20 x 180	S	10	870,00
M 24 x 75	S	25	290,00
M 24 x 80	S	25	290,00
M 24 x 90	S	10	350,00
M 24 x 100	S	10	380,00
M 24 x 110	S	10	580,00
M 24 x 120	S	10	620,00
M 24 x 140	S	10	870,00
M 24 x 150	S	10	950,00
M 24 x 160	S	10	1050,00
M 24 x 180	S	1	1340,00
M 27 x 90	S	10	980,00
M 27 x 100	S	10	1160,00
M 27 x 110	S	1	1340,00
M 27 x 120	S	1	1340,00
M 27 x 130	S	1	1440,00
M 27 x 150	S	1	1490,00
M 27 x 160	S	1	1490,00

ISO	04014.813	
4014	Mu 8.8	SB
	galvanisch verzinkt	

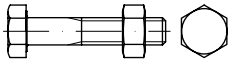

SB-Schrauben-Garnituren EN 15048, Mu = mit Sechskantmutter ISO 4032, SB = nach EN 15048

für nicht planmäßig vorgespannte Verbindungen im Stahlbau mit Abnahmeprüfzeugnis 3.1, Preise gelten zzgl. APZ-Kosten

Achtung! Nicht für den Einsatz in Stahlbauwerken in Deutschland zugelassen.

Maße → **TI-15** Anziehmomente → **TI-248**
 Werkstoffeigensch. → **TI-232** Normumstellung → **TI-6**
 Korrosionsschutz → **TI-228**

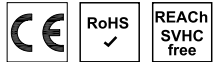

M 10 x 45	S	100	90,00 gal Zn
M 10 x 50	S	100	95,00 gal Zn
M 10 x 55	S	100	100,00 gal Zn
M 10 x 60	S	100	106,00 gal Zn
M 10 x 65	S	100	111,00 gal Zn
M 10 x 70	S	100	117,00 gal Zn
M 10 x 75	S	100	121,00 gal Zn
M 10 x 80	S	100	126,00 gal Zn
M 10 x 90	S	100	137,00 gal Zn
M 10 x 100	S	100	148,00 gal Zn
M 10 x 110	S	50	164,00 gal Zn
M 10 x 120	S	50	170,00 gal Zn
M 12 x 50	S	100	138,00 gal Zn
M 12 x 55	S	100	146,00 gal Zn
M 12 x 60	S	100	153,00 gal Zn
M 12 x 65	S	50	159,00 gal Zn
M 12 x 70	S	50	166,00 gal Zn
M 12 x 75	S	50	174,00 gal Zn
M 12 x 80	S	50	182,00 gal Zn
M 12 x 90	S	50	197,00 gal Zn
M 12 x 100	S	50	211,00 gal Zn
M 12 x 110	S	50	227,00 gal Zn
M 12 x 120	S	50	242,00 gal Zn
M 16 x 55	S	50	285,00 gal Zn
M 16 x 60	S	50	295,00 gal Zn
M 16 x 65	S	25	310,00 gal Zn
M 16 x 70	S	25	325,00 gal Zn
M 16 x 75	S	25	335,00 gal Zn

Abmessungen	VE	Stück	€/100/Obf.
M 16 x 80	S	25	350,00 gal Zn
M 16 x 90	S	25	375,00 gal Zn
M 16 x 100	S	25	400,00 gal Zn
M 16 x 110	S	25	435,00 gal Zn
M 16 x 120	S	25	460,00 gal Zn
M 16 x 130	S	25	485,00 gal Zn
M 16 x 140	S	25	510,00 gal Zn
M 16 x 150	S	25	540,00 gal Zn
M 16 x 160	S	25	570,00 gal Zn
M 20 x 65	S	25	540,00 gal Zn
M 20 x 70	S	25	570,00 gal Zn
M 20 x 75	S	25	580,00 gal Zn
M 20 x 80	S	25	610,00 gal Zn
M 20 x 90	S	25	650,00 gal Zn
M 20 x 100	S	25	690,00 gal Zn
M 20 x 110	S	25	730,00 gal Zn
M 20 x 120	S	25	770,00 gal Zn
M 20 x 130	S	25	810,00 gal Zn
M 20 x 140	S	25	850,00 gal Zn
M 20 x 150	S	25	890,00 gal Zn
M 20 x 160	S	10	940,00 gal Zn
M 20 x 170	S	10	990,00 gal Zn
M 20 x 180	S	10	1030,00 gal Zn
M 24 x 75	S	25	930,00 gal Zn
M 24 x 80	S	25	970,00 gal Zn
M 24 x 90	S	10	1030,00 gal Zn
M 24 x 100	S	10	1100,00 gal Zn
M 24 x 110	S	10	1170,00 gal Zn
M 24 x 120	S	10	1220,00 gal Zn
M 24 x 130	S	10	1270,00 gal Zn
M 24 x 140	S	10	1330,00 gal Zn
M 24 x 150	S	10	1390,00 gal Zn
M 24 x 160	S	10	1460,00 gal Zn
M 24 x 180	S	1	1580,00 gal Zn
M 27 x 90	S	10	1610,00 gal Zn
M 27 x 100	S	10	1700,00 gal Zn
M 27 x 110	S	1	1770,00 gal Zn
M 27 x 120	S	1	1860,00 gal Zn
M 27 x 130	S	1	1910,00 gal Zn
M 27 x 140	S	1	2010,00 gal Zn
M 27 x 150	S	1	2100,00 gal Zn

ISO	04014.825	
4014	Mu 8.8	SB
	feuerverzinkt	

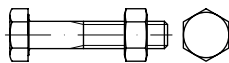

SB-Schrauben-Garnituren EN 15048, Mu = mit Sechskantmutter ISO 4032, SB = nach EN 15048

für nicht planmäßig vorgespannte Verbindungen im Stahlbau mit Abnahmeprüfzeugnis 3.1, Preise gelten zzgl. APZ-Kosten

Scheiben → ISO 7090 300HV tZn

Maße → **TI-15** Anziehmomente → **TI-248**
 Werkstoffeigensch. → **TI-232** Normumstellung → **TI-6**
 Korrosionsschutz → **TI-231**

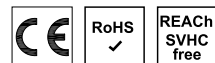

M 10 x 40	S	100	181,00 tZn
M 10 x 45	S	100	138,00 tZn
M 10 x 50	S	100	147,00 tZn
M 10 x 55	S	100	154,00 tZn
M 10 x 60	S	100	165,00 tZn
M 10 x 65	S	100	172,00 tZn

Abmessungen	VE	Stück	€/100/Obf.
M 10 x 70	S	100	178,00 tZn
M 10 x 75	S	100	189,00 tZn
M 10 x 80	S	100	199,00 tZn
M 10 x 90	S	100	245,00 tZn
M 10 x 100	S	100	265,00 tZn
M 10 x 110	S	50	345,00 tZn
M 10 x 120	S	50	385,00 tZn
M 12 x 45	S	100	290,00 tZn
M 12 x 50	S	100	226,00 tZn
M 12 x 55	S	100	240,00 tZn
M 12 x 60	S	100	249,00 tZn
M 12 x 65	S	50	265,00 tZn
M 12 x 70	S	50	275,00 tZn
M 12 x 75	S	50	285,00 tZn
M 12 x 80	S	50	300,00 tZn
M 12 x 90	S	50	325,00 tZn
M 12 x 100	S	50	395,00 tZn
M 12 x 110	S	50	490,00 tZn
M 12 x 120	S	50	540,00 tZn
M 12 x 130	S	50	495,00 tZn
M 12 x 140	S	50	510,00 tZn
M 12 x 150	S	50	540,00 tZn
M 12 x 160	S	25	560,00 tZn
M 12 x 180	S	25	600,00 tZn
M 12 x 200	S	25	660,00 tZn
M 16 x 55	S	50	475,00 tZn
M 16 x 60	S	50	495,00 tZn
M 16 x 65	S	25	520,00 tZn
M 16 x 70	S	25	540,00 tZn
M 16 x 75	S	25	570,00 tZn
M 16 x 80	S	25	580,00 tZn
M 16 x 90	S	25	690,00 tZn
M 16 x 100	S	25	740,00 tZn
M 16 x 110	S	25	940,00 tZn
M 16 x 120	S	25	950,00 tZn
M 16 x 130	S	25	990,00 tZn
M 16 x 140	S	25	1220,00 tZn
M 16 x 150	S	25	1410,00 tZn
M 16 x 160	S	25	1460,00 tZn
M 16 x 180	S	25	1010,00 tZn
M 16 x 200	S	25	1080,00 tZn
M 16 x 220	S	1	1230,00 tZn
M 16 x 240	S	1	1310,00 tZn
M 16 x 260	S	1	1610,00 tZn
M 16 x 300	S	1	1820,00 tZn
M 20 x 65	S	25	840,00 tZn
M 20 x 70	S	25	850,00 tZn
M 20 x 75	S	25	900,00 tZn
M 20 x 80	S	25	930,00 tZn
M 20 x 85	S	25	1010,00 tZn
M 20 x 90	S	25	1020,00 tZn
M 20 x 100	S	25	1080,00 tZn
M 20 x 110	S	25	1390,00 tZn
M 20 x 120	S	25	1470,00 tZn
M 20 x 130	S	25	1570,00 tZn
M 20 x 140	S	25	1920,00 tZn
M 20 x 150	S	25	2070,00 tZn
M 20 x 160	S	10	2260,00 tZn
M 20 x 170	S	10	2440,00 tZn
M 20 x 180	S	10	2700,00 tZn
M 20 x 200	S	10	1720,00 tZn
M 20 x 220	S	1	2340,00 tZn
M 20 x 240	S	1	2490,00 tZn
M 20 x 260	S	1	2950,00 tZn
M 20 x 300	S	1	3300,00 tZn
M 24 x 75	S	25	1490,00 tZn
M 24 x 80	S	25	1540,00 tZn
M 24 x 85	S	10	1600,00 tZn
M 24 x 90	S	10	1630,00 tZn
M 24 x 100	S	10	1740,00 tZn
M 24 x 110	S	10	2230,00 tZn
M 24 x 120	S	10	2390,00 tZn
M 24 x 130	S	10	2490,00 tZn
M 24 x 140	S	10	3250,00 tZn
M 24 x 150	S	10	3450,00 tZn

Abmessungen	VE	Stück	€/100/Obf.	Abmessungen	VE	Stück	€/100/Obf.	Abmessungen	VE	Stück	€/100/Obf.
M 24 x 160	S	10	3600,00 tzn	M 5 x 50	S	200	33,00	M 12 x 50	S	100	71,00
M 24 x 180	S	1	4200,00 tzn	M 5 x 55	S	200	35,00	M 12 x 55	S	100	71,00
M 24 x 200	S	1	2600,00 tzn	M 5 x 60	S	200	38,00	M 12 x 60	S	100	75,00
M 24 x 220	S	1	3950,00 tzn	M 5 x 65	S	200	51,00	M 12 x 65	S	50	78,00
M 24 x 240	S	1	4250,00 tzn	M 5 x 65	S	200	52,00	M 12 x 70	S	50	86,00
M 24 x 260	S	1	4750,00 tzn	M 5 x 75	S	200	58,00	M 12 x 75	S	50	95,00
M 24 x 300	S	1	5500,00 tzn	M 5 x 80	S	200	63,00	M 12 x 80	S	50	95,00
M 27 x 90	S	10	4150,00 tzn	M 6 x 30	S	500	14,90	M 12 x 85	S	50	108,00
M 27 x 100	S	10	4350,00 tzn	M 6 x 35	S	200	15,70	M 12 x 90	S	50	108,00
M 27 x 110	S	1	4550,00 tzn	M 6 x 40	S	200	16,70	M 12 x 95	S	50	119,00
M 27 x 120	S	1	4800,00 tzn	M 6 x 45	S	200	19,70	M 12 x 100	S	50	119,00
M 27 x 130	S	1	5000,00 tzn	M 6 x 50	S	200	22,00	M 12 x 110	S	50	142,00
M 27 x 140	S	1	5000,00 tzn	M 6 x 55	S	200	24,20	M 12 x 120	S	50	158,00
M 27 x 150	S	1	5500,00 tzn	M 6 x 60	S	200	26,50	M 12 x 130	S	50	187,00
M 27 x 160	S	1	4150,00 tzn	M 6 x 65	S	200	32,00	M 12 x 140	S	50	213,00
M 27 x 180	S	1	4450,00 tzn	M 6 x 70	S	200	32,00	M 12 x 150	S	50	236,00
M 27 x 200	S	1	4750,00 tzn	M 6 x 80	S	200	70,00	M 12 x 160	S	25	470,00
M 30 x 90	S	1	3850,00 tzn	M 6 x 90	S	200	120,00	M 12 x 170	S	25	500,00
M 30 x 100	S	1	4000,00 tzn	M 6 x 100	S	100	129,00	M 12 x 180	S	25	530,00
M 30 x 110	S	1	4200,00 tzn	M 6 x 110	S	100	138,00	M 12 x 190	S	25	550,00
M 30 x 120	S	1	4400,00 tzn	M 6 x 120	S	100	152,00	M 12 x 200	S	25	560,00
M 30 x 130	S	1	4550,00 tzn	M 6 x 130	S	100	189,00	M 12 x 210	S	25	750,00
M 30 x 140	S	1	4800,00 tzn	M 6 x 140	S	100	209,00	M 12 x 220	S	25	600,00
M 30 x 150	S	1	5000,00 tzn	M 8 x 35	S	200	27,00	M 12 x 240	S	25	650,00
M 30 x 160	S	1	5200,00 tzn	M 8 x 40	S	200	29,50	M 12 x 260	S	25	710,00
M 30 x 180	S	1	5600,00 tzn	M 8 x 45	S	200	33,00	M 12 x 280	S	25	750,00
M 30 x 200	S	1	5900,00 tzn	M 8 x 50	S	200	33,50	M 12 x 300	S	25	790,00
M 30 x 220	S	1	6300,00 tzn	M 8 x 55	S	200	33,50	M 12 x 320	S	25	940,00
M 30 x 240	S	1	6700,00 tzn	M 8 x 60	S	200	35,00	M 14 x 45	S	100	108,00
M 30 x 260	S	1	7600,00 tzn	M 8 x 65	S	200	39,50	M 14 x 50	S	100	108,00
M 30 x 280	S	1	8000,00 tzn	M 8 x 70	S	200	42,50	M 14 x 55	S	50	108,00
M 30 x 300	S	1	8400,00 tzn	M 8 x 75	S	200	54,00	M 14 x 60	S	50	112,00
M 36 x 120	S	1	6800,00 tzn	M 8 x 80	S	200	54,00	M 14 x 65	S	50	130,00
M 36 x 130	S	1	7100,00 tzn	M 8 x 90	S	100	59,00	M 14 x 70	S	50	130,00
M 36 x 140	S	1	7300,00 tzn	M 8 x 100	S	100	68,00	M 14 x 75	S	50	143,00
M 36 x 150	S	1	7700,00 tzn	M 8 x 110	S	100	83,00	M 14 x 80	S	50	143,00
M 36 x 160	S	1	8000,00 tzn	M 8 x 120	S	100	92,00	M 14 x 90	S	50	161,00
M 36 x 180	S	1	9100,00 tzn	M 8 x 130	S	100	148,00	M 14 x 100	S	50	170,00
M 36 x 190	S	1	9400,00 tzn	M 8 x 140	S	100	176,00	M 14 x 110	S	50	199,00
M 36 x 200	S	1	9700,00 tzn	M 8 x 150	S	100	199,00	M 14 x 120	S	50	226,00
M 36 x 220	S	1	10300,00 tzn	M 8 x 160	S	100	224,00	M 14 x 130	S	50	280,00
M 36 x 240	S	1	10900,00 tzn	M 8 x 170	S	100	275,00	M 14 x 140	S	25	300,00
M 36 x 260	S	1	11700,00 tzn	M 8 x 180	S	100	246,00	M 14 x 150	S	25	325,00
M 36 x 280	S	1	12300,00 tzn	M 8 x 190	S	100	320,00	M 14 x 160	S	25	630,00
M 36 x 300	S	1	12900,00 tzn	M 8 x 200	S	100	295,00	M 14 x 170	S	25	690,00
				M 8 x 220	S	100	395,00	M 14 x 180	S	25	720,00
				M 8 x 240	S	100	465,00	M 14 x 190	S	25	730,00
				M 10 x 35	S	100	42,00	M 14 x 200	S	25	760,00
				M 10 x 40	S	100	42,00	M 14 x 220	S	25	810,00
				M 10 x 45	S	100	45,00	M 16 x 55	S	50	143,00
				M 10 x 50	S	100	48,50	M 16 x 60	S	50	151,00
				M 10 x 55	S	100	50,00	M 16 x 65	S	25	166,00
				M 10 x 60	S	100	53,00	M 16 x 70	S	25	174,00
				M 10 x 65	S	100	53,00	M 16 x 75	S	25	187,00
				M 10 x 70	S	100	58,00	M 16 x 80	S	25	189,00
				M 10 x 75	S	100	64,00	M 16 x 85	S	25	195,00
				M 10 x 80	S	100	64,00	M 16 x 90	S	25	195,00
				M 10 x 90	S	100	78,00	M 16 x 95	S	25	209,00
				M 10 x 100	S	100	88,00	M 16 x 100	S	25	209,00
				M 10 x 110	S	50	110,00	M 16 x 110	S	25	255,00
				M 10 x 120	S	50	123,00	M 16 x 120	S	25	255,00
				M 10 x 130	S	50	161,00	M 16 x 130	S	25	285,00
				M 10 x 140	S	50	174,00	M 16 x 140	S	25	305,00
				M 10 x 150	S	50	197,00	M 16 x 150	S	25	540,00
				M 10 x 160	S	50	470,00	M 16 x 160	S	25	630,00
				M 10 x 170	S	50	500,00	M 16 x 170	S	25	690,00
				M 10 x 180	S	50	530,00	M 16 x 180	S	25	720,00
				M 10 x 190	S	50	550,00	M 16 x 190	S	25	730,00
				M 10 x 200	S	50	560,00	M 16 x 200	S	25	760,00
				M 10 x 210	S	25	750,00	M 16 x 210	S	25	960,00
				M 10 x 220	S	50	600,00	M 16 x 220	S	25	810,00
				M 10 x 240	S	50	650,00	M 16 x 230	S	25	1020,00
				M 10 x 260	S	50	710,00	M 16 x 240	S	25	870,00
				M 12 x 40	S	100	63,00	M 16 x 250	S	25	1100,00
				M 12 x 45	S	100	63,00	M 16 x 260	S	25	920,00
M 5 x 25	S	500	24,60								
M 5 x 30	S	500	26,00								
M 5 x 35	S	200	27,50								
M 5 x 40	S	200	29,50								
M 5 x 45	S	200	31,50								

ISO 04014.100

4014 10.9

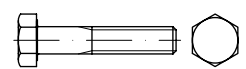

Sechskantschrauben mit Schaft

kurze Abmessungen z. T. Gewinde bis Kopf,
 *M 10/12/14/22 = RAZ 3250 übrige Ø = RAZ 405

Maße → TI-15 Anziehungsmomente → TI-244
 Werkstoffeigensch. → TI-232 Normumstellung → TI-6

Rostfrei → S. 529
 Messing → S. 636

ISO 4014 → ersetzt DIN 931

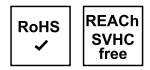

Abmessungen	VE	Stück	€/100/Obf.	Abmessungen	VE	Stück	€/100/Obf.	Abmessungen	VE	Stück	€/100/Obf.
M 16 x 270	S	25	1240,00	M 22 x 80	S	25	850,00	M 27 x 290	S	1	3950,00
M 16 x 280	S	25	1160,00	M 22 x 90	S	25	970,00	M 27 x 300	S	1	2950,00
M 16 x 290	S	1	1430,00	M 22 x 100	S	10	1030,00	M 27 x 320	S	1	3250,00
M 16 x 300	S	1	1590,00	M 22 x 110	S	10	1110,00	M 30 x 80	S	1	1420,00
M 16 x 310	S	1	1700,00	M 22 x 120	S	10	1140,00	M 30 x 90	S	1	1470,00
M 16 x 320	S	1	1680,00	M 22 x 130	S	10	1190,00	M 30 x 100	S	1	1500,00
M 16 x 330	S	1	1780,00	M 22 x 140	S	10	1240,00	M 30 x 110	S	1	1540,00
M 16 x 340	S	1	1950,00	M 22 x 150	S	10	1290,00	M 30 x 120	S	1	1660,00
M 16 x 350	S	1	2070,00	M 22 x 160	S	10	1340,00	M 30 x 130	S	1	1740,00
M 16 x 360	S	1	1930,00	M 22 x 170	S	10	1380,00	M 30 x 140	S	1	1850,00
M 16 x 380	S	1	2470,00	M 22 x 180	S	10	1420,00	M 30 x 150	S	1	1910,00
M 16 x 400	S	1	2750,00	M 22 x 200	S	10	1500,00	M 30 x 160	S	1	1990,00
M 16 x 420	S	1	3450,00	M 22 x 220	S	10	1590,00	M 30 x 170	S	1	2090,00
M 18 x 65	S	25	340,00	M 22 x 230	S	1	1880,00	M 30 x 180	S	1	2190,00
M 18 x 70	S	25	350,00	M 22 x 240	S	1	1680,00	M 30 x 190	S	1	2290,00
M 18 x 75	S	25	370,00	M 22 x 260	S	1	1760,00	M 30 x 200	S	1	2370,00
M 18 x 80	S	25	375,00	M 22 x 280	S	1	1860,00	M 30 x 210	S	1	2700,00
M 18 x 90	S	25	420,00	M 22 x 300	S	1	3000,00	M 30 x 220	S	1	2450,00
M 18 x 100	S	25	440,00	M 22 x 320	S	1	3400,00	M 30 x 230	S	1	3000,00
M 18 x 110	S	25	455,00	M 24 x 75	S	25	850,00	M 30 x 240	S	1	2700,00
M 18 x 120	S	25	470,00	M 24 x 80	S	25	850,00	M 30 x 250	S	1	3200,00
M 18 x 130	S	25	560,00	M 24 x 85	S	10	970,00	M 30 x 260	S	1	2900,00
M 18 x 140	S	25	610,00	M 24 x 90	S	10	970,00	M 30 x 270	S	1	3400,00
M 18 x 150	S	25	680,00	M 24 x 100	S	10	1080,00	M 30 x 280	S	1	3100,00
M 18 x 160	S	25	960,00	M 24 x 110	S	10	1110,00	M 30 x 290	S	1	3950,00
M 18 x 170	S	25	980,00	M 24 x 120	S	10	1140,00	M 30 x 300	S	1	3300,00
M 18 x 180	S	25	1030,00	M 24 x 130	S	10	1190,00	M 30 x 320	S	1	3800,00
M 18 x 190	S	1	1090,00	M 24 x 140	S	10	1240,00	M 30 x 330	S	1	4850,00
M 18 x 200	S	1	1110,00	M 24 x 150	S	10	1290,00	M 30 x 340	S	1	4050,00
M 18 x 220	S	1	1160,00	M 24 x 160	S	10	1340,00	M 30 x 350	S	1	5100,00
M 18 x 240	S	1	1760,00	M 24 x 170	S	1	1380,00	M 30 x 360	S	1	4400,00
M 18 x 260	S	1	1830,00	M 24 x 180	S	1	1420,00	M 30 x 380	S	1	4650,00
M 18 x 280	S	1	1950,00	M 24 x 190	S	1	1460,00	M 30 x 400	S	1	4900,00
M 18 x 300	S	1	2120,00	M 24 x 200	S	1	1500,00	M 33 x 100	S	1	1800,00
M 18 x 320	S	1	2420,00	M 24 x 210	S	1	1770,00	M 33 x 110	S	1	1910,00
M 20 x 65	S	25	340,00	M 24 x 220	S	1	1590,00	M 33 x 120	S	1	2050,00
M 20 x 70	S	25	350,00	M 24 x 230	S	1	1880,00	M 33 x 130	S	1	2160,00
M 20 x 75	S	25	370,00	M 24 x 240	S	1	1680,00	M 33 x 140	S	1	2290,00
M 20 x 80	S	25	375,00	M 24 x 250	S	1	2030,00	M 33 x 150	S	1	2420,00
M 20 x 85	S	25	420,00	M 24 x 260	S	1	1760,00	M 33 x 160	S	1	2550,00
M 20 x 90	S	25	420,00	M 24 x 270	S	1	2140,00	M 33 x 170	S	1	2700,00
M 20 x 95	S	25	440,00	M 24 x 280	S	1	1860,00	M 33 x 180	S	1	2800,00
M 20 x 100	S	25	440,00	M 24 x 290	S	1	2380,00	M 33 x 190	S	1	2950,00
M 20 x 110	S	25	455,00	M 24 x 300	S	1	1990,00	M 33 x 200	S	1	3050,00
M 20 x 120	S	25	470,00	M 24 x 310	S	1	2850,00	M 33 x 220	S	1	3200,00
M 20 x 130	S	25	560,00	M 24 x 320	S	1	2320,00	M 33 x 240	S	1	3400,00
M 20 x 140	S	25	610,00	M 24 x 330	S	1	3000,00	M 33 x 250	S	1	4750,00
M 20 x 150	S	25	680,00	M 24 x 340	S	1	2600,00	M 33 x 260	S	1	3650,00
M 20 x 160	S	10	960,00	M 24 x 350	S	1	3250,00	M 33 x 280	S	1	3900,00
M 20 x 170	S	10	980,00	M 24 x 360	S	1	2800,00	M 33 x 300	S	1	4150,00
M 20 x 180	S	10	1030,00	M 24 x 370	S	1	4350,00	M 33 x 320	S	1	4750,00
M 20 x 190	S	1	1090,00	M 24 x 380	S	1	4350,00	M 36 x 110	S	1	2280,00
M 20 x 200	S	1	1110,00	M 24 x 390	S	1	4650,00	M 36 x 120	S	1	2430,00
M 20 x 210	S	1	1350,00	M 24 x 400	S	1	4650,00	M 36 x 130	S	1	2600,00
M 20 x 220	S	1	1160,00	M 27 x 80	S	10	1200,00	M 36 x 140	S	1	2750,00
M 20 x 230	S	1	1450,00	M 27 x 90	S	10	1230,00	M 36 x 150	S	1	2900,00
M 20 x 240	S	1	1240,00	M 27 x 100	S	10	1290,00	M 36 x 160	S	1	3000,00
M 20 x 250	S	1	1580,00	M 27 x 110	S	10	1340,00	M 36 x 170	S	1	3150,00
M 20 x 260	S	1	1330,00	M 27 x 120	S	10	1400,00	M 36 x 180	S	1	3300,00
M 20 x 270	S	1	1680,00	M 27 x 130	S	10	1460,00	M 36 x 190	S	1	3450,00
M 20 x 280	S	1	1400,00	M 27 x 140	S	1	1530,00	M 36 x 200	S	1	3600,00
M 20 x 290	S	1	1950,00	M 27 x 150	S	1	1600,00	M 36 x 210	S	1	4100,00
M 20 x 300	S	1	1500,00	M 27 x 160	S	1	1690,00	M 36 x 220	S	1	3750,00
M 20 x 310	S	1	2250,00	M 27 x 170	S	1	1780,00	M 36 x 230	S	1	4400,00
M 20 x 320	S	1	1730,00	M 27 x 180	S	1	1860,00	M 36 x 240	S	1	4000,00
M 20 x 330	S	1	2380,00	M 27 x 190	S	1	1950,00	M 36 x 250	S	1	4750,00
M 20 x 340	S	1	1880,00	M 27 x 200	S	1	2040,00	M 36 x 260	S	1	4350,00
M 20 x 350	S	1	2700,00	M 27 x 210	S	1	2700,00	M 36 x 270	S	1	5100,00
M 20 x 360	S	1	2050,00	M 27 x 220	S	1	2190,00	M 36 x 280	S	1	4600,00
M 20 x 370	S	1	3350,00	M 27 x 230	S	1	3000,00	M 36 x 290	S	1	5900,00
M 20 x 380	S	1	3350,00	M 27 x 240	S	1	2380,00	M 36 x 300	S	1	4900,00
M 20 x 390	S	1	3750,00	M 27 x 250	S	1	3200,00	M 36 x 320	S	1	5600,00
M 20 x 400	S	1	3750,00	M 27 x 260	S	1	2550,00	M 36 x 340	S	1	6000,00
M 22 x 70	S	25	1170,00	M 27 x 270	S	1	3400,00	M 36 x 360	S	1	6300,00
M 22 x 75	S	25	1170,00	M 27 x 280	S	1	2750,00	M 36 x 380	S	1	6700,00

Abmessungen	VE	Stück	€/100/Obf.
M 36 x 400	S	1	7300,00
M 39 x 110	S	1	3250,00
M 39 x 120	S	1	3250,00
M 39 x 130	S	1	3450,00
M 39 x 140	S	1	3600,00
M 39 x 150	S	1	3800,00
M 39 x 160	S	1	3900,00
M 39 x 170	S	1	4050,00
M 39 x 180	S	1	4250,00
M 39 x 200	S	1	4600,00
M 39 x 220	S	1	4950,00
M 39 x 240	S	1	5300,00
M 39 x 260	S	1	5700,00
M 39 x 280	S	1	6000,00
M 39 x 300	S	1	6400,00
M 39 x 320	S	1	7100,00
M 42 x 120	S	1	3850,00
M 42 x 130	S	1	4050,00
M 42 x 140	S	1	4250,00
M 42 x 150	S	1	4450,00
M 42 x 160	S	1	4550,00
M 42 x 170	S	1	4750,00
M 42 x 180	S	1	4950,00
M 42 x 190	S	1	5200,00
M 42 x 200	S	1	5400,00
M 42 x 220	S	1	5800,00
M 42 x 240	S	1	6200,00
M 42 x 260	S	1	6600,00
M 42 x 280	S	1	7000,00
M 42 x 300	S	1	7500,00
M 42 x 320	S	1	8300,00
M 45 x 130	S	1	9700,00
M 45 x 140	S	1	10100,00
M 45 x 150	S	1	10500,00
M 45 x 160	S	1	11200,00
M 45 x 180	S	1	12000,00
M 45 x 200	S	1	13100,00
M 45 x 220	S	1	14000,00
M 45 x 240	S	1	14900,00
M 45 x 260	S	1	15900,00
M 45 x 280	S	1	16800,00
M 45 x 300	S	1	17700,00
M 45 x 320	S	1	21400,00
M 48 x 140	S	1	12200,00
M 48 x 150	S	1	13100,00
M 48 x 160	S	1	13700,00
M 48 x 180	S	1	14000,00
M 48 x 200	S	1	15700,00
M 48 x 220	S	1	16400,00
M 48 x 240	S	1	17400,00
M 48 x 260	S	1	18700,00
M 48 x 280	S	1	20500,00
M 48 x 300	S	1	23200,00
M 48 x 320	S	1	26100,00

Abmessungen	VE	Stück	€/100/Obf.
ISO 4014.110			
4014			10.9 galvanisch verzinkt

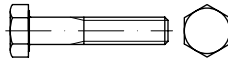

Sechskantschrauben mit Schaft

kurze Abmessungen z. T. Gewinde bis Kopf, getempert, *M 10/12/14/22 = RAZ 3250 übrige Ø = RAZ 405

Achtung! Warneinblender zu Wasserstoffversprödung beachten.

Maße → TI-15 Anziehmomente → TI-244
 Werkstoffeigensch. → TI-232 Normumstellung → TI-6
 Korrosionsschutz → TI-228
 Rostfrei → S. 529
 Messing → S. 636

ISO 4014 → ersetzt DIN 931

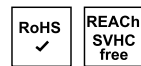

M 6 x 30	S	500	20,00 gal Zn
M 6 x 35	S	200	20,80 gal Zn
M 6 x 40	S	200	21,80 gal Zn
M 6 x 45	S	200	25,50 gal Zn
M 6 x 50	S	200	28,00 gal Zn
M 6 x 55	S	200	31,00 gal Zn
M 6 x 60	S	200	33,50 gal Zn
M 6 x 65	S	200	39,50 gal Zn
M 6 x 70	S	200	41,50 gal Zn
M 6 x 80	S	200	79,00 gal Zn
M 6 x 90	S	200	134,00 gal Zn
M 6 x 100	S	100	140,00 gal Zn
M 8 x 35	S	200	36,50 gal Zn
M 8 x 40	S	200	39,50 gal Zn
M 8 x 45	S	200	44,00 gal Zn
M 8 x 50	S	200	46,00 gal Zn
M 8 x 55	S	200	46,50 gal Zn
M 8 x 60	S	200	48,00 gal Zn
M 8 x 65	S	200	54,00 gal Zn
M 8 x 70	S	200	58,00 gal Zn
M 8 x 75	S	200	69,00 gal Zn
M 8 x 80	S	200	70,00 gal Zn
M 8 x 100	S	100	89,00 gal Zn
M 8 x 110	S	100	106,00 gal Zn
M 8 x 120	S	100	117,00 gal Zn
M 8 x 130	S	100	176,00 gal Zn
M 8 x 140	S	100	206,00 gal Zn
M 8 x 150	S	100	230,00 gal Zn
M 10 x 40	S	100	60,00 gal Zn
M 10 x 45	S	100	64,00 gal Zn
M 10 x 50	S	100	68,00 gal Zn
M 10 x 55	S	100	72,00 gal Zn
M 10 x 60	S	100	74,00 gal Zn
M 10 x 65	S	100	77,00 gal Zn
M 10 x 70	S	100	83,00 gal Zn
M 10 x 75	S	100	91,00 gal Zn
M 10 x 80	S	100	92,00 gal Zn
M 10 x 90	S	100	109,00 gal Zn
M 10 x 100	S	100	123,00 gal Zn
M 10 x 110	S	50	147,00 gal Zn
M 10 x 120	S	50	163,00 gal Zn
M 10 x 130	S	50	205,00 gal Zn
M 10 x 140	S	100	224,00 gal Zn
M 10 x 150	S	50	249,00 gal Zn
M 10 x 160	S	50	530,00 gal Zn
M 10 x 170	S	50	560,00 gal Zn
M 10 x 180	S	50	590,00 gal Zn

M 12 x 45	S	100	88,00 gal Zn
M 12 x 50	S	100	93,00 gal Zn
M 12 x 55	S	100	101,00 gal Zn
M 12 x 60	S	100	101,00 gal Zn
M 12 x 65	S	50	104,00 gal Zn
M 12 x 70	S	50	113,00 gal Zn
M 12 x 75	S	50	126,00 gal Zn
M 12 x 80	S	50	129,00 gal Zn
M 12 x 85	S	50	143,00 gal Zn
M 12 x 90	S	50	147,00 gal Zn
M 12 x 95	S	50	165,00 gal Zn
M 12 x 100	S	50	161,00 gal Zn
M 12 x 110	S	50	186,00 gal Zn
M 12 x 120	S	50	205,00 gal Zn
M 12 x 130	S	50	240,00 gal Zn
M 12 x 140	S	50	280,00 gal Zn
M 12 x 150	S	50	305,00 gal Zn
M 12 x 160	S	25	550,00 gal Zn
M 12 x 170	S	25	590,00 gal Zn
M 12 x 180	S	25	620,00 gal Zn
M 12 x 190	S	25	630,00 gal Zn
M 12 x 200	S	25	650,00 gal Zn
M 14 x 45	S	100	140,00 gal Zn
M 14 x 50	S	50	144,00 gal Zn
M 14 x 55	S	50	148,00 gal Zn
M 14 x 60	S	50	154,00 gal Zn
M 14 x 70	S	50	177,00 gal Zn
M 14 x 75	S	50	197,00 gal Zn
M 14 x 80	S	50	195,00 gal Zn
M 14 x 90	S	50	217,00 gal Zn
M 14 x 100	S	50	230,00 gal Zn
M 14 x 110	S	50	270,00 gal Zn
M 14 x 120	S	50	305,00 gal Zn
M 14 x 130	S	50	365,00 gal Zn
M 14 x 140	S	25	390,00 gal Zn
M 14 x 150	S	25	420,00 gal Zn
M 16 x 55	S	50	197,00 gal Zn
M 16 x 60	S	50	200,00 gal Zn
M 16 x 65	S	25	227,00 gal Zn
M 16 x 70	S	25	222,00 gal Zn
M 16 x 75	S	25	246,00 gal Zn
M 16 x 80	S	25	260,00 gal Zn
M 16 x 85	S	25	270,00 gal Zn
M 16 x 90	S	25	270,00 gal Zn
M 16 x 100	S	25	290,00 gal Zn
M 16 x 110	S	25	345,00 gal Zn
M 16 x 120	S	25	350,00 gal Zn
M 16 x 130	S	25	410,00 gal Zn
M 16 x 140	S	25	420,00 gal Zn
M 16 x 150	S	25	660,00 gal Zn
M 16 x 160	S	25	760,00 gal Zn
M 16 x 170	S	25	830,00 gal Zn
M 16 x 180	S	25	860,00 gal Zn
M 16 x 190	S	25	890,00 gal Zn
M 16 x 200	S	25	930,00 gal Zn
M 16 x 210	S	25	1140,00 gal Zn
M 16 x 230	S	25	1210,00 gal Zn
M 16 x 240	S	25	1060,00 gal Zn
M 16 x 250	S	25	1320,00 gal Zn
M 16 x 260	S	25	1130,00 gal Zn
M 16 x 270	S	25	1460,00 gal Zn
M 16 x 280	S	25	1400,00 gal Zn
M 18 x 65	S	25	420,00 gal Zn
M 18 x 70	S	25	445,00 gal Zn
M 18 x 80	S	25	470,00 gal Zn
M 18 x 90	S	25	530,00 gal Zn
M 18 x 100	S	25	550,00 gal Zn
M 18 x 110	S	25	590,00 gal Zn
M 18 x 120	S	25	620,00 gal Zn
M 18 x 130	S	25	690,00 gal Zn
M 18 x 140	S	25	760,00 gal Zn
M 18 x 160	S	25	1130,00 gal Zn
M 20 x 65	S	25	445,00 gal Zn
M 20 x 70	S	25	440,00 gal Zn
M 20 x 75	S	25	460,00 gal Zn

- ✓ Große Artikelvielfalt
- ✓ Verlässliche Qualität
- ✓ Hohe Lieferbereitschaft

Abmessungen	VE	Stück	€/100/Obf.
M 20 x 80	S	25	475,00 gal Zn
M 20 x 85	S	25	550,00 gal Zn
M 20 x 90	S	25	530,00 gal Zn
M 20 x 100	S	25	560,00 gal Zn
M 20 x 110	S	25	610,00 gal Zn
M 20 x 115	S	25	630,00 gal Zn
M 20 x 120	S	25	640,00 gal Zn
M 20 x 130	S	25	740,00 gal Zn
M 20 x 140	S	25	790,00 gal Zn
M 20 x 150	S	25	870,00 gal Zn
M 20 x 160	S	10	1270,00 gal Zn
M 20 x 170	S	10	1210,00 gal Zn
M 20 x 180	S	10	1360,00 gal Zn
M 20 x 200	S	10	1370,00 gal Zn
M 20 x 220	S	1	1440,00 gal Zn
M 20 x 230	S	1	1750,00 gal Zn
M 20 x 240	S	1	1540,00 gal Zn
M 20 x 250	S	1	1890,00 gal Zn
M 20 x 260	S	1	1670,00 gal Zn
M 20 x 270	S	1	2030,00 gal Zn
M 20 x 280	S	1	1760,00 gal Zn
M 20 x 290	S	1	2330,00 gal Zn
M 20 x 300	S	1	1880,00 gal Zn
M 20 x 310	S	1	2650,00 gal Zn
M 20 x 320	S	1	2130,00 gal Zn
M 20 x 340	S	1	2180,00 gal Zn
M 24 x 75	S	25	1010,00 gal Zn
M 24 x 80	S	25	1030,00 gal Zn
M 24 x 90	S	10	1170,00 gal Zn
M 24 x 100	S	10	1240,00 gal Zn
M 24 x 110	S	10	1350,00 gal Zn
M 24 x 120	S	10	1390,00 gal Zn
M 24 x 130	S	10	1450,00 gal Zn
M 24 x 140	S	10	1500,00 gal Zn
M 24 x 145	S	10	1590,00 gal Zn
M 24 x 150	S	10	1590,00 gal Zn
M 24 x 160	S	10	1660,00 gal Zn
M 24 x 170	S	1	1720,00 gal Zn
M 24 x 180	S	1	1760,00 gal Zn
M 24 x 190	S	1	1810,00 gal Zn
M 24 x 200	S	1	1880,00 gal Zn
M 24 x 220	S	1	2130,00 gal Zn
M 24 x 240	S	1	2260,00 gal Zn
M 24 x 250	S	1	2370,00 gal Zn
M 24 x 260	S	1	2380,00 gal Zn
M 24 x 270	S	1	2470,00 gal Zn
M 24 x 280	S	1	2550,00 gal Zn

Abmessungen	VE	Stück	€/100/Obf.
M 30 x 90	S	1	1810,00 gal Zn
M 30 x 100	S	1	1860,00 gal Zn
M 30 x 110	S	1	1930,00 gal Zn
M 30 x 120	S	1	2070,00 gal Zn
M 30 x 130	S	1	2180,00 gal Zn
M 30 x 140	S	1	2300,00 gal Zn
M 30 x 150	S	1	2400,00 gal Zn
M 30 x 160	S	1	2500,00 gal Zn
M 30 x 170	S	1	2650,00 gal Zn
M 30 x 180	S	1	2800,00 gal Zn
M 30 x 190	S	1	2900,00 gal Zn
M 30 x 200	S	1	3000,00 gal Zn
M 30 x 210	S	1	3350,00 gal Zn
M 30 x 220	S	1	3150,00 gal Zn
M 30 x 230	S	1	3700,00 gal Zn
M 30 x 240	S	1	3450,00 gal Zn
M 30 x 250	S	1	3950,00 gal Zn
M 30 x 260	S	1	3650,00 gal Zn
M 30 x 270	S	1	4250,00 gal Zn
M 30 x 280	S	1	3950,00 gal Zn
M 30 x 300	S	1	4200,00 gal Zn

Abmessungen	VE	Stück	€/100/Obf.
M 10 x 55	S	100	83,00 flZn
M 10 x 60	S	100	86,00 flZn
M 10 x 65	S	100	88,00 flZn
M 10 x 70	S	100	95,00 flZn
M 10 x 75	S	100	105,00 flZn
M 10 x 80	S	100	106,00 flZn
M 10 x 90	S	100	125,00 flZn
M 10 x 100	S	100	142,00 flZn
M 10 x 110	S	50	170,00 flZn
M 10 x 120	S	50	188,00 flZn
M 12 x 45	S	100	102,00 flZn
M 12 x 50	S	100	107,00 flZn
M 12 x 55	S	100	116,00 flZn
M 12 x 60	S	100	116,00 flZn
M 12 x 65	S	50	120,00 flZn
M 12 x 70	S	50	131,00 flZn
M 12 x 75	S	50	146,00 flZn
M 12 x 80	S	50	148,00 flZn
M 12 x 90	S	50	170,00 flZn
M 12 x 100	S	50	186,00 flZn
M 12 x 110	S	50	213,00 flZn
M 12 x 120	S	50	236,00 flZn
M 16 x 55	S	50	227,00 flZn
M 16 x 60	S	50	230,00 flZn
M 16 x 65	S	25	265,00 flZn
M 16 x 70	S	25	260,00 flZn
M 16 x 75	S	25	285,00 flZn
M 16 x 80	S	25	295,00 flZn
M 16 x 90	S	25	315,00 flZn
M 16 x 100	S	25	335,00 flZn
M 16 x 110	S	25	395,00 flZn
M 16 x 120	S	25	405,00 flZn
M 16 x 130	S	25	470,00 flZn
M 16 x 140	S	25	480,00 flZn
M 20 x 65	S	25	510,00 flZn
M 20 x 70	S	25	510,00 flZn
M 20 x 75	S	25	530,00 flZn
M 20 x 80	S	25	550,00 flZn
M 20 x 90	S	25	610,00 flZn
M 20 x 100	S	25	640,00 flZn
M 20 x 110	S	25	700,00 flZn
M 20 x 120	S	25	740,00 flZn
M 20 x 130	S	25	850,00 flZn
M 20 x 140	S	25	910,00 flZn
M 20 x 150	S	25	1010,00 flZn
M 20 x 160	S	10	1460,00 flZn
M 20 x 170	S	10	1390,00 flZn
M 20 x 180	S	10	1560,00 flZn
M 24 x 75	S	25	1170,00 flZn
M 24 x 80	S	25	1180,00 flZn
M 24 x 90	S	10	1340,00 flZn
M 24 x 100	S	10	1420,00 flZn
M 24 x 110	S	10	1550,00 flZn
M 24 x 120	S	10	1590,00 flZn
M 24 x 130	S	10	1670,00 flZn
M 24 x 140	S	10	1730,00 flZn
M 24 x 150	S	10	1820,00 flZn
M 24 x 160	S	10	1900,00 flZn
M 24 x 170	S	1	1980,00 flZn
M 24 x 180	S	1	2030,00 flZn
M 24 x 200	S	1	2130,00 flZn
M 24 x 230	S	1	2180,00 flZn

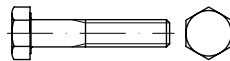
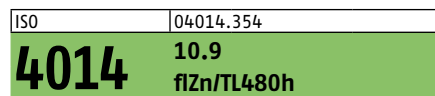

Sechskantschrauben mit Schaft

kurze Abmessungen z. T. Gewinde bis Kopf,
 TL = Schmierstoff im Topcoat mit $\mu = 0,09 - 0,14$,
 Korrosionsbeständigkeit NSS: 480h RR,
 Chrom(VI)-frei

Achtung! Gegenüber galv. verzinkt geänderte Anziehdrehmomente.

Maße → **TI-15** Anziehdrehmomente → **TI-24,5**
 Werkstoffeigensch. → **TI-232** Normumstellung → **TI-6**
 Korrosionsschutz → **TI-230**

Rostfrei → **S. 529**
 Messing → **S. 636**

ISO 4014 → ersetzt DIN 931



Wichtiger Hinweis!

Bei galvanischen Überzügen auf hochfesten und federharten Teilen ($\geq 1000 \text{ N/mm}^2$ oder $\geq 320 \text{ HV}$) ist die Gefahr einer Wasserstoffversprödung (Sprödbruchgefahr) nicht mit Sicherheit auszuschließen (ISO 4042). Durch eine rechtzeitig eingeleitete thermische Nachbehandlung (Tempern) kann die Gefahr eines wasserstoffinduzierten Sprödbruchs im Regelfall verringert werden. Da aber ein Restrisiko nicht mit Sicherheit auszuschließen ist, erfolgen galvanische Überzüge auf derartigen Teilen nur auf ausdrücklichen Wunsch und auf Risiko des Auftraggebers.

M 24 x 290	S	1	2600,00 gal Zn
M 24 x 300	S	1	2550,00 gal Zn
M 27 x 80	S	10	1440,00 gal Zn
M 27 x 90	S	10	1490,00 gal Zn
M 27 x 100	S	10	1580,00 gal Zn
M 27 x 110	S	10	1650,00 gal Zn
M 27 x 120	S	10	1740,00 gal Zn
M 27 x 130	S	10	1790,00 gal Zn
M 27 x 140	S	1	1890,00 gal Zn
M 30 x 80	S	1	1730,00 gal Zn

M 6 x 30	S	500	23,00 flZn
M 6 x 35	S	200	23,90 flZn
M 6 x 40	S	200	25,50 flZn
M 6 x 45	S	200	29,50 flZn
M 6 x 50	S	200	32,50 flZn
M 6 x 55	S	200	36,00 flZn
M 6 x 60	S	200	38,50 flZn
M 6 x 65	S	200	45,50 flZn
M 6 x 70	S	200	47,50 flZn
M 6 x 80	S	200	91,00 flZn
M 8 x 35	S	200	42,00 flZn
M 8 x 40	S	200	45,50 flZn
M 8 x 45	S	200	51,00 flZn
M 8 x 50	S	200	53,00 flZn
M 8 x 55	S	200	54,00 flZn
M 8 x 60	S	200	56,00 flZn
M 8 x 65	S	200	62,00 flZn
M 8 x 70	S	200	67,00 flZn
M 8 x 75	S	200	80,00 flZn
M 8 x 80	S	200	81,00 flZn
M 8 x 100	S	100	102,00 flZn
M 10 x 40	S	100	69,00 flZn
M 10 x 45	S	100	74,00 flZn
M 10 x 50	S	100	78,00 flZn

Abmessungen	VE Stück	€/100/Obf.
ISO 04014.133		
4014	10.9	f1ZnL480h

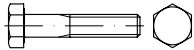

Sechskantschrauben mit Schaft

kurze Abmessungen z. T. Gewinde bis Kopf,
f1ZnL = int. Schmierstoff mit $\mu = 0,12 - 0,18$,
Korrosionsbeständigkeit NSS: 480h RR,
Chrom(VI)-frei

Maße → **TI-15** Anziehmomente → **TI-245**
Werkstoffeigensch. → **TI-232** Normumstellung → **TI-6**
Korrosionsschutz → **TI-230**

Rostfrei → **S. 529**
Messing → **S. 636**

ISO 4014 → ersetzt DIN 931



M 6	x	30	S	500	23,00 f1Zn
M 6	x	35	S	200	23,90 f1Zn
M 6	x	40	S	200	25,50 f1Zn
M 6	x	45	S	200	29,50 f1Zn
M 6	x	50	S	200	32,50 f1Zn
M 6	x	55	S	200	36,00 f1Zn
M 6	x	60	S	200	38,50 f1Zn
M 6	x	65	S	200	45,50 f1Zn
M 6	x	70	S	200	47,50 f1Zn
M 6	x	80	S	200	91,00 f1Zn
M 8	x	35	S	200	42,00 f1Zn
M 8	x	40	S	200	45,50 f1Zn
M 8	x	45	S	200	51,00 f1Zn
M 8	x	50	S	200	53,00 f1Zn
M 8	x	55	S	200	54,00 f1Zn
M 8	x	60	S	200	56,00 f1Zn
M 8	x	65	S	200	62,00 f1Zn
M 8	x	70	S	200	67,00 f1Zn
M 8	x	75	S	200	80,00 f1Zn
M 8	x	80	S	200	81,00 f1Zn
M 8	x	90	S	100	90,00 f1Zn
M 8	x	100	S	100	102,00 f1Zn
M 8	x	150	S	100	365,00 f1Zn
M 8	x	240	S	100	530,00 f1Zn
M 10	x	40	S	100	69,00 f1Zn
M 10	x	45	S	100	74,00 f1Zn
M 10	x	50	S	100	78,00 f1Zn
M 10	x	55	S	100	83,00 f1Zn
M 10	x	60	S	100	86,00 f1Zn
M 10	x	65	S	100	88,00 f1Zn
M 10	x	70	S	100	95,00 f1Zn
M 10	x	75	S	100	105,00 f1Zn
M 10	x	80	S	100	106,00 f1Zn
M 10	x	90	S	100	125,00 f1Zn
M 10	x	100	S	100	142,00 f1Zn
M 10	x	110	S	50	170,00 f1Zn
M 10	x	120	S	50	188,00 f1Zn
M 10	x	140	S	50	239,00 f1Zn
M 10	x	180	S	50	380,00 f1Zn
M 12	x	45	S	100	102,00 f1Zn
M 12	x	50	S	100	107,00 f1Zn
M 12	x	55	S	100	116,00 f1Zn
M 12	x	60	S	100	116,00 f1Zn
M 12	x	65	S	50	120,00 f1Zn
M 12	x	70	S	50	131,00 f1Zn
M 12	x	75	S	50	146,00 f1Zn
M 12	x	80	S	50	148,00 f1Zn
M 12	x	90	S	50	170,00 f1Zn

Abmessungen	VE Stück	€/100/Obf.			
M 12	x	100	S	50	186,00 f1Zn
M 12	x	110	S	50	213,00 f1Zn
M 12	x	120	S	50	236,00 f1Zn
M 12	x	130	S	50	265,00 f1Zn
M 12	x	140	S	50	300,00 f1Zn
M 12	x	150	S	50	320,00 f1Zn
M 12	x	160	S	25	360,00 f1Zn
M 12	x	170	S	25	385,00 f1Zn
M 14	x	55	S	50	132,00 f1Zn
M 14	x	60	S	50	138,00 f1Zn
M 14	x	100	S	50	221,00 f1Zn
M 16	x	55	S	50	227,00 f1Zn
M 16	x	60	S	50	230,00 f1Zn
M 16	x	65	S	25	265,00 f1Zn
M 16	x	70	S	25	260,00 f1Zn
M 16	x	75	S	25	285,00 f1Zn
M 16	x	80	S	25	295,00 f1Zn
M 16	x	90	S	25	315,00 f1Zn
M 16	x	95	S	25	320,00 f1Zn
M 16	x	100	S	25	335,00 f1Zn
M 16	x	110	S	25	395,00 f1Zn
M 16	x	120	S	25	405,00 f1Zn
M 16	x	125	S	25	435,00 f1Zn
M 16	x	130	S	25	470,00 f1Zn
M 16	x	140	S	25	480,00 f1Zn
M 16	x	150	S	25	510,00 f1Zn
M 16	x	190	S	25	550,00 f1Zn
M 16	x	200	S	25	570,00 f1Zn
M 18	x	90	S	25	335,00 f1Zn
M 18	x	100	S	25	355,00 f1Zn
M 20	x	65	S	25	510,00 f1Zn
M 20	x	70	S	25	510,00 f1Zn
M 20	x	75	S	25	530,00 f1Zn
M 20	x	80	S	25	550,00 f1Zn
M 20	x	90	S	25	610,00 f1Zn
M 20	x	95	S	25	620,00 f1Zn
M 20	x	100	S	25	640,00 f1Zn
M 20	x	105	S	25	670,00 f1Zn
M 20	x	110	S	25	700,00 f1Zn
M 20	x	120	S	25	740,00 f1Zn
M 20	x	130	S	25	850,00 f1Zn
M 20	x	140	S	25	910,00 f1Zn
M 20	x	150	S	25	1010,00 f1Zn
M 20	x	160	S	10	1460,00 f1Zn
M 20	x	170	S	10	1390,00 f1Zn
M 20	x	180	S	10	1560,00 f1Zn
M 20	x	200	S	10	2170,00 f1Zn
M 20	x	290	S	1	2600,00 f1Zn
M 20	x	340	S	1	3100,00 f1Zn
M 20	x	360	S	1	3200,00 f1Zn
M 20	x	380	S	1	3350,00 f1Zn
M 22	x	110	S	10	830,00 f1Zn
M 24	x	75	S	25	1170,00 f1Zn
M 24	x	80	S	25	1180,00 f1Zn
M 24	x	90	S	10	1340,00 f1Zn
M 24	x	100	S	10	1420,00 f1Zn
M 24	x	110	S	10	1550,00 f1Zn
M 24	x	120	S	10	1590,00 f1Zn
M 24	x	130	S	10	1670,00 f1Zn
M 24	x	135	S	10	1710,00 f1Zn
M 24	x	140	S	10	1730,00 f1Zn
M 24	x	150	S	10	1820,00 f1Zn
M 24	x	160	S	10	1900,00 f1Zn
M 24	x	170	S	1	1980,00 f1Zn
M 24	x	180	S	1	2030,00 f1Zn
M 24	x	200	S	1	2130,00 f1Zn
M 24	x	230	S	1	2180,00 f1Zn
M 24	x	240	S	1	2320,00 f1Zn
M 24	x	300	S	1	2600,00 f1Zn

Abmessungen	VE Stück	€/100/Obf.
ISO 04014.200		
4014	12.9	

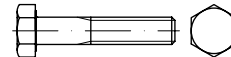

Sechskantschrauben mit Schaft

kurze Abmessungen z. T. Gewinde bis Kopf,
*M 10/12/14/22 = RAZ 3260 übrige $\varnothing =$ RAZ 406

Maße → **TI-15** Anziehmomente → **TI-244**
Werkstoffeigensch. → **TI-232** Normumstellung → **TI-6**
Rostfrei → **S. 529**
Messing → **S. 636**

ISO 4014 → ersetzt DIN 931

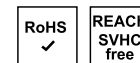

M 10	x	40	S	100	180,00
M 10	x	45	S	100	180,00
M 10	x	50	S	100	213,00
M 10	x	60	S	100	285,00
M 10	x	70	S	100	360,00
M 10	x	80	S	100	395,00
M 10	x	90	S	100	480,00
M 10	x	100	S	100	510,00
M 12	x	45	S	100	199,00
M 12	x	50	S	100	236,00
M 12	x	55	S	100	260,00
M 12	x	60	S	100	315,00
M 12	x	65	S	50	365,00
M 12	x	70	S	50	395,00
M 12	x	80	S	50	480,00
M 12	x	90	S	50	630,00
M 12	x	100	S	50	720,00
M 12	x	120	S	50	840,00
M 12	x	140	S	50	860,00
M 14	x	60	S	50	920,00
M 14	x	80	S	50	960,00
M 14	x	100	S	50	1010,00
M 16	x	55	S	50	560,00
M 16	x	60	S	50	560,00
M 16	x	70	S	25	600,00
M 16	x	80	S	25	780,00
M 16	x	90	S	25	960,00
M 16	x	100	S	25	1020,00
M 16	x	120	S	25	1150,00
M 16	x	130	S	25	1240,00
M 16	x	140	S	25	1340,00
M 16	x	150	S	25	1540,00
M 20	x	65	S	25	600,00
M 20	x	70	S	25	790,00
M 20	x	80	S	25	840,00
M 20	x	90	S	25	880,00
M 20	x	100	S	25	1030,00
M 20	x	110	S	25	1200,00
M 20	x	120	S	25	1240,00
M 20	x	130	S	25	1430,00
M 20	x	140	S	25	1510,00
M 20	x	150	S	25	1900,00
M 20	x	160	S	25	2040,00
M 24	x	80	S	25	1510,00
M 24	x	90	S	10	1580,00
M 24	x	100	S	10	1900,00
M 24	x	110	S	10	2010,00
M 24	x	120	S	10	2100,00
M 24	x	130	S	10	2360,00
M 24	x	140	S	10	2450,00
M 24	x	150	S	10	2550,00

Abmessungen	VE	Stück	€/100/Obf.
M 24 x 160	S	10	2650,00
M 24 x 180	S	10	2700,00
M 24 x 200	S	10	3000,00
M 24 x 220	S	10	3000,00
M 24 x 240	S	10	3050,00
M 30 x 90	S	5	3150,00
M 30 x 100	S	5	3300,00
M 30 x 110	S	5	3400,00
M 30 x 120	S	5	3600,00
M 30 x 130	S	5	3950,00
M 30 x 140	S	5	4200,00
M 30 x 150	S	5	4400,00
M 30 x 160	S	5	4600,00
M 30 x 180	S	5	4800,00
M 30 x 200	S	5	5600,00

ISO	04014.240
4014	12.9 f1ZnL480h

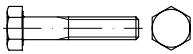

Sechskantschrauben mit Schaft

kurze Abmessungen z. T. Gewinde bis Kopf,
f1ZnL = int. Schmierstoff mit $\mu = 0,12 - 0,18$,
Korrosionsbeständigkeit NSS: 480h RR,
Chrom(VI)-frei

Maße → **TI-15** Anziehmomente → **TI-245**
Werkstoffeigensch. → **TI-232** Normumstellung → **TI-6**
Korrosionsschutz → **TI-230**
Rostfrei → **S. 529**
Messing → **S. 636**

ISO 4014 → ersetzt DIN 931

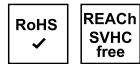

M 10 x 40	S	100	265,00 f1Zn
M 10 x 45	S	100	265,00 f1Zn
M 10 x 50	S	100	315,00 f1Zn
M 10 x 60	S	100	320,00 f1Zn
M 10 x 70	S	100	530,00 f1Zn
M 10 x 80	S	100	580,00 f1Zn
M 10 x 90	S	100	710,00 f1Zn
M 10 x 100	S	100	740,00 f1Zn
M 12 x 45	S	100	290,00 f1Zn
M 12 x 50	S	100	345,00 f1Zn
M 12 x 55	S	100	385,00 f1Zn
M 12 x 60	S	100	460,00 f1Zn
M 12 x 65	S	50	530,00 f1Zn
M 12 x 70	S	50	580,00 f1Zn
M 12 x 80	S	50	710,00 f1Zn
M 12 x 90	S	50	920,00 f1Zn
M 12 x 100	S	50	1050,00 f1Zn
M 16 x 55	S	50	820,00 f1Zn
M 16 x 60	S	50	830,00 f1Zn
M 16 x 70	S	25	880,00 f1Zn
M 16 x 80	S	25	1130,00 f1Zn
M 16 x 90	S	25	1400,00 f1Zn
M 16 x 100	S	25	1480,00 f1Zn
M 16 x 120	S	25	1670,00 f1Zn
M 20 x 65	S	25	880,00 f1Zn
M 20 x 70	S	25	1030,00 f1Zn
M 20 x 80	S	25	375,00 f1Zn
M 20 x 90	S	25	1280,00 f1Zn
M 20 x 100	S	25	1510,00 f1Zn
M 20 x 120	S	25	1800,00 f1Zn

Abmessungen	VE	Stück	€/100/Obf.
ISO	04017.(*)		
4017	5.6		AD W7

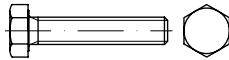

Sechskantschrauben mit Gewinde bis Kopf

M 6 - M 39 für Druckbehälterbau
nach AD-Regelwerk,
Fabrikate mit Verzicht eines Abnahmeprüfzeugnis,
*≤ M 39 = (504), > M 36 = (500),
**M 10/12/14 = RAZ 3210 übrige Ø = RAZ 400

Maße → **TI-15** Anziehmomente → **TI-244**
Werkstoffeigensch. → **TI-232** Normumstellung → **TI-6**
Rostfrei → **S. 534**
Messing → **S. 636**

ISO 4017 → ersetzt DIN 933

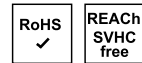

M 6 x 10	S	500	25,50
M 6 x 12	S	500	34,00
M 6 x 16	S	500	21,50
M 6 x 20	S	500	23,70
M 6 x 25	S	500	24,40
M 6 x 30	S	500	29,50
M 6 x 35	S	200	80,00
M 6 x 40	S	200	86,00
M 6 x 50	S	200	126,00
M 8 x 10	S	200	48,50
M 8 x 12	S	200	35,50
M 8 x 16	S	200	28,50
M 8 x 20	S	200	28,50
M 8 x 25	S	200	28,50
M 8 x 30	S	200	30,00
M 8 x 35	S	200	37,00
M 8 x 40	S	200	42,50
M 8 x 50	S	200	91,00
M 8 x 65	S	200	285,00
M 8 x 70	S	200	161,00
M 8 x 80	S	200	200,00
M 10 x 16	S	200	58,00
M 10 x 20	S	200	52,00
M 10 x 25	S	200	52,00
M 10 x 30	S	200	54,00
M 10 x 35	S	100	57,00
M 10 x 40	S	100	61,00
M 10 x 45	S	100	65,00
M 10 x 50	S	100	117,00
M 10 x 55	S	100	151,00
M 10 x 60	S	100	160,00
M 10 x 70	S	100	182,00
M 10 x 80	S	100	212,00
M 12 x 20	S	100	66,00
M 12 x 25	S	100	64,00
M 12 x 30	S	100	66,00
M 12 x 35	S	100	71,00
M 12 x 40	S	100	76,00
M 12 x 45	S	100	85,00
M 12 x 50	S	100	91,00
M 12 x 55	S	100	99,00
M 12 x 60	S	100	107,00
M 12 x 65	S	100	204,00
M 12 x 70	S	50	220,00
M 12 x 80	S	50	305,00
M 12 x 90	S	50	610,00
M 12 x 100	S	50	730,00

Abmessungen	VE	Stück	€/100/Obf.
M 12 x 110	S	50	1070,00
M 14 x 50	S	100	435,00
M 16 x 25	S	50	174,00
M 16 x 30	S	50	142,00
M 16 x 35	S	50	143,00
M 16 x 40	S	50	146,00
M 16 x 45	S	50	152,00
M 16 x 50	S	50	158,00
M 16 x 55	S	50	175,00
M 16 x 60	S	50	183,00
M 16 x 65	S	25	206,00
M 16 x 70	S	25	215,00
M 16 x 80	S	25	265,00
M 16 x 90	S	25	730,00
M 16 x 100	S	25	1010,00
M 16 x 110	S	25	1080,00
M 16 x 120	S	25	1150,00
M 20 x 30	S	25	315,00
M 20 x 35	S	25	315,00
M 20 x 40	S	25	280,00
M 20 x 45	S	25	295,00
M 20 x 50	S	25	300,00
M 20 x 55	S	25	315,00
M 20 x 60	S	25	330,00
M 20 x 65	S	25	340,00
M 20 x 70	S	25	355,00
M 20 x 75	S	25	395,00
M 20 x 80	S	25	510,00
M 20 x 90	S	25	690,00
M 20 x 100	S	25	730,00
M 20 x 110	S	25	880,00
M 20 x 120	S	25	1010,00
M 20 x 130	S	25	1170,00
M 20 x 140	S	25	1280,00
M 20 x 150	S	25	1460,00
M 20 x 160	S	10	1510,00
M 20 x 180	S	1	1590,00
M 20 x 200	S	1	1690,00
M 22 x 50	S	25	1060,00
M 24 x 30	S	25	790,00
M 24 x 35	S	25	790,00
M 24 x 40	S	25	790,00
M 24 x 50	S	25	540,00
M 24 x 55	S	25	570,00
M 24 x 60	S	25	570,00
M 24 x 65	S	25	620,00
M 24 x 70	S	25	660,00
M 24 x 75	S	25	720,00
M 24 x 80	S	25	720,00
M 24 x 85	S	10	920,00
M 24 x 90	S	10	920,00
M 24 x 100	S	10	1010,00
M 24 x 110	S	10	1350,00
M 24 x 120	S	10	1410,00
M 24 x 130	S	1	1750,00
M 24 x 140	S	1	1870,00
M 24 x 150	S	1	1990,00
M 24 x 160	S	1	2100,00
M 24 x 180	S	1	2300,00
M 24 x 200	S	1	2650,00
M 27 x 50	S	1	1200,00
M 27 x 60	S	1	1200,00
M 27 x 65	S	1	1200,00
M 27 x 70	S	1	1200,00
M 27 x 75	S	1	1200,00
M 27 x 80	S	1	1070,00
M 27 x 90	S	1	1130,00
M 27 x 100	S	1	1360,00
M 27 x 110	S	1	1410,00
M 27 x 120	S	1	1510,00
M 27 x 140	S	1	2330,00
M 30 x 40	S	1	1080,00
M 30 x 50	S	1	1230,00
M 30 x 55	S	1	1290,00
M 30 x 60	S	1	1310,00

Abmessungen	VE	Stück	€/100/Obf.
M 30 x 65	S	1	1380,00
M 30 x 70	S	1	1380,00
M 30 x 75	S	1	1480,00
M 30 x 80	S	1	1480,00
M 30 x 90	S	1	1550,00
M 30 x 100	S	1	1580,00
M 30 x 110	S	1	1670,00
M 30 x 120	S	1	1710,00
M 30 x 130	S	1	1820,00
M 30 x 140	S	1	1920,00
M 30 x 150	S	1	2000,00
M 30 x 180	S	1	3700,00
M 30 x 200	S	1	3950,00
M 33 x 90	S	1	2000,00
M 33 x 100	S	1	2220,00
M 33 x 110	S	1	2300,00
M 33 x 120	S	1	2330,00
M 33 x 130	S	1	2380,00
M 36 x 50	S	1	2420,00
M 36 x 55	S	1	2600,00
M 36 x 70	S	1	2130,00
M 36 x 80	S	1	2260,00
M 36 x 90	S	1	2360,00
M 36 x 100	S	1	2550,00
M 36 x 110	S	1	2650,00
M 36 x 120	S	1	2750,00
M 36 x 130	S	1	2800,00

ISO	04017.514
4017	5.6 AD W7 galvanisch verzinkt

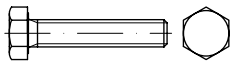

Sechskantschrauben mit Gewinde bis Kopf

für Druckbehälterbau nach AD-Regelwerk, Fabrikate mit Verzicht eines Abnahmeprüfzeugnis, *M 10/12/14 = RAZ 3210 übrige Ø = RAZ 400

Maße → TI-15 Anziehmomente → TI-244
 Werkstoffeigensch. → TI-232 Normumstellung → TI-6
 Korrosionsschutz → TI-228

Rostfrei → S. 534
 Messing → S. 636

ISO 4017 → ersetzt DIN 933



M 6 x 12	S	500	36,00 gal Zn
M 6 x 16	S	500	23,00 gal Zn
M 6 x 20	S	500	25,50 gal Zn
M 6 x 25	S	500	26,50 gal Zn
M 6 x 30	S	500	31,50 gal Zn
M 6 x 35	S	200	86,00 gal Zn
M 6 x 40	S	200	92,00 gal Zn
M 6 x 50	S	200	134,00 gal Zn
M 8 x 10	S	200	54,00 gal Zn
M 8 x 12	S	200	38,50 gal Zn
M 8 x 16	S	200	31,50 gal Zn
M 8 x 20	S	200	32,00 gal Zn
M 8 x 25	S	200	32,50 gal Zn
M 8 x 30	S	200	34,50 gal Zn
M 8 x 35	S	200	42,50 gal Zn
M 8 x 40	S	200	48,00 gal Zn
M 8 x 45	S	200	100,00 gal Zn
M 8 x 50	S	200	107,00 gal Zn
M 8 x 60	S	200	115,00 gal Zn
M 8 x 80	S	200	222,00 gal Zn

Abmessungen	VE	Stück	€/100/Obf.
M 10 x 16	S	200	64,00 gal Zn
M 10 x 20	S	200	58,00 gal Zn
M 10 x 25	S	200	59,00 gal Zn
M 10 x 30	S	200	62,00 gal Zn
M 10 x 35	S	100	66,00 gal Zn
M 10 x 40	S	100	71,00 gal Zn
M 10 x 45	S	100	75,00 gal Zn
M 10 x 50	S	100	142,00 gal Zn
M 10 x 55	S	100	175,00 gal Zn
M 10 x 60	S	100	186,00 gal Zn
M 10 x 70	S	100	211,00 gal Zn
M 10 x 80	S	100	355,00 gal Zn
M 12 x 20	S	100	76,00 gal Zn
M 12 x 25	S	100	74,00 gal Zn
M 12 x 30	S	100	78,00 gal Zn
M 12 x 35	S	100	84,00 gal Zn
M 12 x 40	S	100	90,00 gal Zn
M 12 x 45	S	100	100,00 gal Zn
M 12 x 50	S	100	107,00 gal Zn
M 12 x 55	S	100	117,00 gal Zn
M 12 x 60	S	100	125,00 gal Zn
M 12 x 65	S	50	345,00 gal Zn
M 12 x 70	S	50	265,00 gal Zn
M 12 x 80	S	50	350,00 gal Zn
M 12 x 90	S	50	660,00 gal Zn
M 12 x 100	S	50	780,00 gal Zn
M 12 x 110	S	50	870,00 gal Zn
M 14 x 50	S	100	570,00 gal Zn
M 16 x 25	S	50	195,00 gal Zn
M 16 x 30	S	50	164,00 gal Zn
M 16 x 35	S	50	167,00 gal Zn
M 16 x 40	S	50	172,00 gal Zn
M 16 x 45	S	50	182,00 gal Zn
M 16 x 50	S	50	189,00 gal Zn
M 16 x 55	S	50	209,00 gal Zn
M 16 x 60	S	50	217,00 gal Zn
M 16 x 65	S	25	244,00 gal Zn
M 16 x 70	S	25	255,00 gal Zn
M 16 x 80	S	25	310,00 gal Zn
M 16 x 90	S	25	860,00 gal Zn
M 16 x 100	S	25	1140,00 gal Zn
M 16 x 110	S	25	1240,00 gal Zn
M 16 x 120	S	25	1320,00 gal Zn
M 20 x 35	S	25	360,00 gal Zn
M 20 x 40	S	25	330,00 gal Zn
M 20 x 45	S	25	345,00 gal Zn
M 20 x 50	S	25	355,00 gal Zn
M 20 x 55	S	25	370,00 gal Zn
M 20 x 60	S	25	385,00 gal Zn
M 20 x 65	S	25	400,00 gal Zn
M 20 x 70	S	25	420,00 gal Zn
M 20 x 75	S	25	450,00 gal Zn
M 20 x 80	S	25	580,00 gal Zn
M 20 x 90	S	25	760,00 gal Zn
M 20 x 100	S	25	810,00 gal Zn
M 20 x 130	S	25	1340,00 gal Zn
M 20 x 140	S	25	1460,00 gal Zn
M 20 x 150	S	25	1640,00 gal Zn
M 20 x 160	S	10	1700,00 gal Zn
M 20 x 180	S	1	1820,00 gal Zn
M 20 x 200	S	1	1940,00 gal Zn
M 24 x 40	S	25	910,00 gal Zn
M 24 x 50	S	25	620,00 gal Zn
M 24 x 55	S	25	660,00 gal Zn
M 24 x 60	S	25	660,00 gal Zn
M 24 x 65	S	25	710,00 gal Zn
M 24 x 70	S	25	750,00 gal Zn
M 24 x 75	S	25	820,00 gal Zn
M 24 x 80	S	25	820,00 gal Zn
M 24 x 85	S	10	1050,00 gal Zn
M 24 x 90	S	10	1040,00 gal Zn
M 24 x 100	S	10	1150,00 gal Zn
M 24 x 110	S	10	1580,00 gal Zn
M 24 x 120	S	10	1640,00 gal Zn
M 24 x 130	S	1	2000,00 gal Zn

Abmessungen	VE	Stück	€/100/Obf.
M 24 x 150	S	1	2270,00 gal Zn
M 24 x 160	S	1	2390,00 gal Zn
M 24 x 180	S	1	2650,00 gal Zn
M 24 x 220	S	1	2950,00 gal Zn
M 27 x 60	S	1	1340,00 gal Zn
M 27 x 65	S	1	1360,00 gal Zn
M 27 x 70	S	1	1360,00 gal Zn
M 27 x 75	S	1	1430,00 gal Zn
M 27 x 80	S	1	1210,00 gal Zn
M 27 x 90	S	1	1310,00 gal Zn
M 27 x 95	S	1	1550,00 gal Zn
M 27 x 100	S	1	1400,00 gal Zn
M 27 x 110	S	1	1700,00 gal Zn
M 27 x 120	S	1	1820,00 gal Zn
M 27 x 140	S	1	2700,00 gal Zn
M 30 x 60	S	1	1520,00 gal Zn
M 30 x 65	S	1	1550,00 gal Zn
M 30 x 70	S	1	1600,00 gal Zn
M 30 x 75	S	1	1740,00 gal Zn
M 30 x 80	S	1	1800,00 gal Zn
M 30 x 90	S	1	1830,00 gal Zn
M 30 x 100	S	1	1830,00 gal Zn
M 30 x 110	S	1	2060,00 gal Zn
M 30 x 120	S	1	2120,00 gal Zn
M 33 x 90	S	1	2420,00 gal Zn
M 33 x 100	S	1	2700,00 gal Zn
M 33 x 110	S	1	2650,00 gal Zn
M 33 x 120	S	1	2700,00 gal Zn
M 33 x 130	S	1	2950,00 gal Zn

ISO	04017.524
4017	Mu 5.6 AD W7 feuerverzinkt

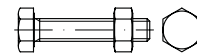

Sechskantschrauben mit Gewinde bis Kopf Mu = mit Sechskantmutter ISO 4032/5-2

für Druckbehälterbau nach AD-Regelwerk, Fabrikate mit Verzicht eines Abnahmeprüfzeugnis

Achtung! Warneinblender zu Feuerverzinkung beachten!

Maße → TI-15 Anziehmomente → TI-244
 Werkstoffeigensch. → TI-232 Normumstellung → TI-6
 Korrosionsschutz → TI-231

Rostfrei → S. 534
 Messing → S. 636

ISO 4017 → ersetzt DIN 933

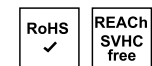

M 12 x 30	S	100	114,00 tzn
M 12 x 35	S	100	120,00 tzn
M 12 x 40	S	100	126,00 tzn
M 12 x 45	S	100	136,00 tzn
M 16 x 35	S	50	234,00 tzn
M 16 x 40	S	50	241,00 tzn
M 16 x 45	S	50	255,00 tzn
M 16 x 50	S	50	260,00 tzn
M 16 x 55	S	50	340,00 tzn
M 16 x 60	S	50	350,00 tzn
M 20 x 40	S	25	500,00 tzn
M 20 x 45	S	25	510,00 tzn
M 20 x 50	S	25	520,00 tzn
M 20 x 55	S	25	540,00 tzn
M 20 x 60	S	25	550,00 tzn

Abmessungen	VE	Stück	€/100/Obf.
M 20 x 65	S	25	580,00 tZn
M 20 x 70	S	25	660,00 tZn
M 20 x 75	S	25	720,00 tZn
M 24 x 50	S	25	940,00 tZn
M 24 x 55	S	25	1030,00 tZn
M 24 x 60	S	25	1130,00 tZn
M 24 x 65	S	25	1180,00 tZn
M 24 x 70	S	25	1250,00 tZn
M 24 x 75	S	25	1310,00 tZn
M 24 x 80	S	25	1370,00 tZn

Abmessungen	VE	Stück	€/100/Obf.
M 16 x 60	S	50	320,00
M 16 x 65	S	25	365,00
M 16 x 70	S	25	380,00
M 16 x 80	S	25	465,00
M 16 x 90	S	25	1280,00
M 16 x 100	S	25	1760,00
M 16 x 110	S	25	1890,00
M 16 x 120	S	25	2020,00
M 20 x 30	S	25	530,00
M 20 x 35	S	25	540,00
M 20 x 40	S	25	560,00
M 20 x 45	S	25	560,00
M 20 x 50	S	25	570,00
M 20 x 55	S	25	570,00
M 20 x 60	S	25	580,00
M 20 x 65	S	25	600,00
M 20 x 70	S	25	620,00
M 20 x 75	S	25	690,00
M 20 x 80	S	25	880,00
M 20 x 90	S	25	1210,00
M 20 x 100	S	25	1280,00
M 20 x 110	S	25	1530,00
M 20 x 120	S	25	1760,00
M 20 x 130	S	25	2040,00
M 20 x 140	S	25	2230,00
M 20 x 150	S	25	2550,00
M 20 x 160	S	10	2650,00
M 20 x 180	S	1	2800,00
M 20 x 200	S	1	2950,00
M 24 x 30	S	25	820,00
M 24 x 35	S	25	840,00
M 24 x 40	S	25	890,00
M 24 x 45	S	25	910,00
M 24 x 50	S	25	940,00
M 24 x 55	S	25	1000,00
M 24 x 60	S	25	1000,00
M 24 x 65	S	25	1090,00
M 24 x 70	S	25	1150,00
M 24 x 75	S	25	1250,00
M 24 x 80	S	25	1250,00
M 24 x 85	S	10	1610,00
M 24 x 90	S	10	1610,00
M 24 x 100	S	10	1760,00
M 24 x 110	S	10	2360,00
M 24 x 120	S	10	2460,00
M 24 x 130	S	1	3050,00
M 24 x 140	S	1	3300,00
M 24 x 150	S	1	3500,00
M 24 x 160	S	1	3700,00
M 24 x 180	S	1	4050,00
M 24 x 200	S	1	4600,00
M 27 x 60	S	1	2100,00
M 27 x 65	S	1	2100,00
M 27 x 70	S	1	2100,00
M 27 x 75	S	1	2100,00
M 27 x 80	S	1	2110,00
M 27 x 90	S	1	2220,00
M 27 x 100	S	1	2380,00
M 27 x 110	S	1	2460,00
M 27 x 120	S	1	2650,00
M 27 x 140	S	1	4100,00
M 30 x 50	S	1	2140,00
M 30 x 55	S	1	2250,00
M 30 x 60	S	1	2290,00
M 30 x 65	S	1	2420,00
M 30 x 70	S	1	2420,00
M 30 x 75	S	1	2600,00
M 30 x 80	S	1	2600,00
M 30 x 90	S	1	2750,00
M 30 x 100	S	1	2800,00
M 30 x 110	S	1	2950,00
M 30 x 120	S	1	2950,00
M 30 x 130	S	1	3200,00
M 30 x 140	S	1	3350,00
M 30 x 150	S	1	3500,00

Abmessungen	VE	Stück	€/100/Obf.
M 30 x 180	S	1	6500,00
M 30 x 200	S	1	6900,00
M 33 x 90	S	1	3500,00
M 33 x 100	S	1	3900,00
M 33 x 110	S	1	4050,00
M 33 x 120	S	1	4100,00
M 33 x 130	S	1	4200,00
M 36 x 70	S	1	3750,00
M 36 x 80	S	1	3950,00
M 36 x 90	S	1	4150,00
M 36 x 100	S	1	4400,00
M 36 x 110	S	1	4650,00
M 36 x 120	S	1	4800,00
M 36 x 130	S	1	4850,00

Achtung!



Feuerverzinkte Schrauben-/Mutter-Garnituren dürfen nur miteinander verschraubt werden, wenn Gewindespiel/-Toleranzen dieser Garnituren entsprechend ISO 10684 passend aufeinander abgestimmt sind. Die Verwendung mit anderen Schrauben-/Mutter-Ausführungen kann zu Verschraubungsproblemen und/oder zum Versagen der Verbindung führen.

ISO	04017.398
4017	1.7218 +QT (25CrMo4)

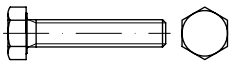

Sechskantschrauben mit Gewinde bis Kopf

Zugelassen für den Einsatz nach Druckgeräterichtlinie → APZ 3.1 auf Anfrage

Maße → **TI-15** Anziehmomente → **TI-245**
 Werkstoffeigensch. → **TI-240** Normumstellung → **TI-6**

Rostfrei → **S. 534**
 Messing → **S. 636**

ISO 4017 → ersetzt DIN 933

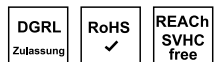

M 12 x 20	S	100	111,00
M 12 x 25	S	100	115,00
M 12 x 30	S	100	119,00
M 12 x 35	S	100	124,00
M 12 x 40	S	100	132,00
M 12 x 45	S	100	148,00
M 12 x 50	S	100	158,00
M 12 x 55	S	100	174,00
M 12 x 60	S	100	188,00
M 12 x 70	S	50	385,00
M 12 x 80	S	50	530,00
M 12 x 90	S	50	1060,00
M 12 x 100	S	50	1270,00
M 12 x 110	S	50	1870,00
M 12 x 120	S	50	1890,00
M 16 x 25	S	50	244,00
M 16 x 30	S	50	249,00
M 16 x 35	S	50	255,00
M 16 x 40	S	50	255,00
M 16 x 45	S	50	265,00
M 16 x 50	S	50	280,00
M 16 x 55	S	50	305,00

ISO	04017.397
4017	1.7218 +QT (25CrMo4) galvanisch verzinkt

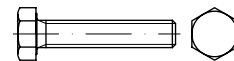

Sechskantschrauben mit Gewinde bis Kopf

Zugelassen für den Einsatz nach Druckgeräterichtlinie → APZ 3.1 auf Anfrage

Maße → **TI-15** Anziehmomente → **TI-245**
 Werkstoffeigensch. → **TI-240** Normumstellung → **TI-6**
 Korrosionsschutz → **TI-228**

Rostfrei → **S. 534**
 Messing → **S. 636**

ISO 4017 → ersetzt DIN 933

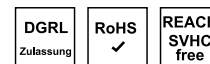

M 12 x 20	S	100	132,00 gal Zn
M 12 x 25	S	100	136,00 gal Zn
M 12 x 30	S	100	143,00 gal Zn
M 12 x 35	S	100	147,00 gal Zn
M 12 x 40	S	100	157,00 gal Zn
M 12 x 45	S	100	175,00 gal Zn
M 12 x 50	S	100	186,00 gal Zn
M 12 x 55	S	100	205,00 gal Zn
M 12 x 60	S	100	220,00 gal Zn
M 12 x 65	S	50	610,00 gal Zn
M 12 x 70	S	50	460,00 gal Zn
M 12 x 80	S	50	610,00 gal Zn
M 12 x 90	S	50	1150,00 gal Zn
M 12 x 100	S	50	1370,00 gal Zn
M 16 x 25	S	50	285,00 gal Zn
M 16 x 30	S	50	290,00 gal Zn
M 16 x 35	S	50	295,00 gal Zn
M 16 x 40	S	50	305,00 gal Zn
M 16 x 45	S	50	320,00 gal Zn
M 16 x 50	S	50	335,00 gal Zn
M 16 x 55	S	50	365,00 gal Zn
M 16 x 60	S	50	380,00 gal Zn
M 16 x 65	S	25	430,00 gal Zn
M 16 x 70	S	25	445,00 gal Zn
M 16 x 80	S	25	550,00 gal Zn
M 16 x 90	S	25	1510,00 gal Zn
M 16 x 100	S	25	2000,00 gal Zn
M 16 x 110	S	25	2160,00 gal Zn
M 16 x 120	S	25	2310,00 gal Zn
M 20 x 30	S	25	560,00 gal Zn
M 20 x 35	S	25	570,00 gal Zn
M 20 x 40	S	25	580,00 gal Zn
M 20 x 45	S	25	610,00 gal Zn
M 20 x 50	S	25	620,00 gal Zn

Abmessungen	VE	Stück	€/100/Obf.
M 20 x 55	S	25	650,00 gal Zn
M 20 x 60	S	25	680,00 gal Zn
M 20 x 65	S	25	700,00 gal Zn
M 20 x 70	S	25	730,00 gal Zn
M 20 x 75	S	25	790,00 gal Zn
M 20 x 80	S	25	1010,00 gal Zn
M 20 x 90	S	25	1330,00 gal Zn
M 20 x 100	S	25	1410,00 gal Zn
M 20 x 130	S	25	2330,00 gal Zn
M 20 x 140	S	25	2550,00 gal Zn
M 20 x 150	S	25	2900,00 gal Zn
M 20 x 160	S	10	3000,00 gal Zn
M 20 x 180	S	1	3200,00 gal Zn
M 20 x 200	S	1	3400,00 gal Zn
M 24 x 35	S	25	1050,00 gal Zn
M 24 x 40	S	25	1060,00 gal Zn
M 24 x 45	S	25	1070,00 gal Zn
M 24 x 50	S	25	1080,00 gal Zn
M 24 x 55	S	25	1150,00 gal Zn
M 24 x 60	S	25	1160,00 gal Zn
M 24 x 65	S	25	1250,00 gal Zn
M 24 x 70	S	25	1310,00 gal Zn
M 24 x 75	S	25	1430,00 gal Zn
M 24 x 80	S	25	1440,00 gal Zn
M 24 x 85	S	10	1840,00 gal Zn
M 24 x 90	S	10	1930,00 gal Zn
M 24 x 100	S	10	2010,00 gal Zn
M 24 x 110	S	10	2800,00 gal Zn
M 24 x 120	S	10	2900,00 gal Zn
M 24 x 130	S	1	3500,00 gal Zn
M 24 x 150	S	1	4550,00 gal Zn
M 24 x 160	S	1	4550,00 gal Zn
M 24 x 180	S	1	4600,00 gal Zn
M 24 x 220	S	1	5100,00 gal Zn
M 27 x 60	S	1	2330,00 gal Zn
M 27 x 65	S	1	2380,00 gal Zn
M 27 x 70	S	1	2400,00 gal Zn
M 27 x 75	S	1	2500,00 gal Zn
M 27 x 80	S	1	2600,00 gal Zn
M 27 x 90	S	1	2700,00 gal Zn
M 27 x 95	S	1	2750,00 gal Zn
M 27 x 100	S	1	2850,00 gal Zn
M 27 x 110	S	1	3000,00 gal Zn
M 27 x 120	S	1	3200,00 gal Zn
M 27 x 140	S	1	4750,00 gal Zn
M 30 x 60	S	1	2650,00 gal Zn
M 30 x 65	S	1	2750,00 gal Zn
M 30 x 70	S	1	2800,00 gal Zn
M 30 x 75	S	1	3050,00 gal Zn
M 30 x 80	S	1	3050,00 gal Zn
M 30 x 90	S	1	3200,00 gal Zn
M 30 x 100	S	1	3200,00 gal Zn
M 30 x 110	S	1	3600,00 gal Zn
M 30 x 120	S	1	3750,00 gal Zn
M 33 x 100	S	1	4700,00 gal Zn
M 33 x 110	S	1	4700,00 gal Zn
M 33 x 120	S	1	4750,00 gal Zn
M 33 x 130	S	1	5100,00 gal Zn

Abmessungen	VE	Stück	€/100/Obf.
ISO		04017.800	

4017 8.8

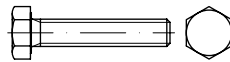

Sechskantschrauben mit Gewinde bis Kopf

*M 10/12/14/22 = RAZ 3220 übrige = RAZ 401

Maße → TI-15 Anziehmomente → TI-244
 Werkstoffeigensch. → TI-232 Normumstellung → TI-6

Rostfrei → S. 534
 Messing → S. 636

ISO 4017 → ersetzt DIN 933

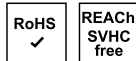

M 3 x 5	S	500	11,70
M 3 x 5	K	100	15,40
M 3 x 6	S	500	5,80
M 3 x 6	K	100	9,40
M 3 x 8	S	500	5,80
M 3 x 8	K	100	9,40
M 3 x 10	S	500	5,80
M 3 x 10	K	100	9,40
M 3 x 12	S	500	6,30
M 3 x 12	K	100	10,00
M 3 x 16	S	500	6,30
M 3 x 16	K	100	10,00
M 3 x 18	S	500	7,20
M 3 x 20	S	500	6,60
M 3 x 20	K	100	10,30
M 3 x 22	S	500	8,00
M 3 x 25	S	500	7,40
M 3 x 25	K	100	11,10
M 3 x 30	S	500	20,40
M 3 x 35	S	500	44,00
M 3 x 40	S	500	55,00
M 3 x 50	S	500	84,00
M 3 x 60	S	500	91,00
M 4 x 6	S	500	5,80
M 4 x 6	K	100	9,40
M 4 x 8	S	500	5,80
M 4 x 8	K	100	9,40
M 4 x 10	S	500	5,80
M 4 x 10	K	100	9,40
M 4 x 12	S	500	6,30
M 4 x 12	K	100	10,00
M 4 x 14	S	500	6,90
M 4 x 16	S	500	6,30
M 4 x 16	K	100	10,00
M 4 x 18	S	500	7,20
M 4 x 20	S	500	6,60
M 4 x 20	K	100	10,30
M 4 x 22	S	500	8,00
M 4 x 25	S	500	7,40
M 4 x 25	K	100	11,10
M 4 x 30	S	500	8,60
M 4 x 30	K	100	12,20
M 4 x 35	S	500	9,10
M 4 x 35	K	100	12,80
M 4 x 40	S	500	9,90
M 4 x 40	K	100	13,50
M 4 x 45	S	500	11,70
M 4 x 50	S	500	12,70
M 4 x 50	K	100	16,30
M 4 x 55	S	100	58,00

Abmessungen	VE	Stück	€/100/Obf.
M 4 x 60	S	100	88,00
M 4 x 65	S	200	125,00
M 4 x 70	S	100	125,00
M 5 x 6	S	500	15,30
M 5 x 6	K	100	19,00
M 5 x 8	S	500	4,10
M 5 x 8	K	100	7,70
M 5 x 10	S	500	4,10
M 5 x 10	K	100	7,70
M 5 x 12	S	500	4,20
M 5 x 12	K	100	7,80
M 5 x 14	S	500	4,40
M 5 x 16	S	500	4,20
M 5 x 16	K	100	7,80
M 5 x 18	S	500	4,60
M 5 x 18	K	100	8,20
M 5 x 20	S	500	4,40
M 5 x 20	K	100	8,20
M 5 x 22	S	500	11,50
M 5 x 25	S	500	5,00
M 5 x 25	K	100	8,60
M 5 x 30	S	500	5,80
M 5 x 30	K	100	9,40
M 5 x 35	S	200	6,60
M 5 x 40	S	200	8,90
M 5 x 45	S	200	10,40
M 5 x 50	S	200	11,50
M 5 x 55	S	200	17,10
M 5 x 60	S	200	17,30
M 5 x 65	S	200	56,00
M 5 x 70	S	200	56,00
M 5 x 80	S	200	84,00
M 5 x 90	S	200	135,00
M 5 x 100	S	200	158,00
M 6 x 6	S	500	21,90
M 6 x 6	K	100	25,50
M 6 x 8	S	500	6,10
M 6 x 8	K	100	9,70
M 6 x 10	S	500	5,50
M 6 x 10	K	100	9,20
M 6 x 12	S	500	5,50
M 6 x 12	K	100	9,20
M 6 x 14	S	500	4,85
M 6 x 16	S	500	4,85
M 6 x 16	K	100	8,50
M 6 x 18	S	500	5,10
M 6 x 18	K	100	8,80
M 6 x 20	S	500	5,10
M 6 x 20	K	100	8,80
M 6 x 22	S	500	5,50
M 6 x 22	K	100	9,20
M 6 x 25	S	500	5,50
M 6 x 25	K	100	9,20
M 6 x 28	S	500	12,10
M 6 x 28	K	100	15,70
M 6 x 30	S	500	5,90
M 6 x 30	K	100	9,60
M 6 x 35	S	200	6,60
M 6 x 40	S	200	7,20
M 6 x 45	S	200	10,60
M 6 x 50	S	200	10,80
M 6 x 55	S	200	18,60
M 6 x 60	S	200	21,00
M 6 x 65	S	200	27,50
M 6 x 70	S	200	34,00
M 6 x 75	S	200	40,50
M 6 x 80	S	200	40,50
M 6 x 85	S	200	73,00
M 6 x 90	S	200	72,00
M 6 x 100	S	100	111,00
M 6 x 110	S	100	129,00
M 6 x 120	S	100	137,00
M 6 x 130	S	100	216,00
M 6 x 140	S	100	232,00
M 6 x 150	S	100	280,00



- ✓ Große Artikelvielfalt
- ✓ Verlässliche Qualität
- ✓ Hohe Lieferbereitschaft

Abmessungen	VE	Stück	€/100/Obf.	Abmessungen	VE	Stück	€/100/Obf.	Abmessungen	VE	Stück	€/100/Obf.
M 7 x 12	S	500	18,90	M 10 x 300	S	50	2290,00	M 16 x 75	S	25	121,00
M 7 x 16	S	500	14,60	M 12 x 10	S	100	211,00	M 16 x 80	S	25	153,00
M 7 x 20	S	500	15,30	M 12 x 12	S	100	132,00	M 16 x 85	S	25	199,00
M 7 x 25	S	500	17,80	M 12 x 16	S	100	25,50	M 16 x 90	S	25	199,00
M 7 x 30	S	500	19,20	M 12 x 18	S	100	25,50	M 16 x 95	S	25	226,00
M 7 x 35	S	200	21,40	M 12 x 20	S	100	22,50	M 16 x 100	S	25	226,00
M 7 x 40	S	200	23,20	M 12 x 22	S	100	22,50	M 16 x 110	S	25	300,00
M 7 x 45	S	200	24,90	M 12 x 25	S	100	22,50	M 16 x 120	S	25	325,00
M 8 x 8	S	200	30,50	M 12 x 28	S	100	24,10	M 16 x 130	S	25	335,00
M 8 x 10	S	200	10,40	M 12 x 30	S	100	23,20	M 16 x 140	S	25	355,00
M 8 x 12	S	200	9,20	M 12 x 35	S	100	24,60	M 16 x 150	S	25	400,00
M 8 x 14	S	200	9,20	M 12 x 40	S	100	25,50	M 16 x 160	S	25	660,00
M 8 x 16	S	200	7,10	M 12 x 45	S	100	28,00	M 16 x 170	S	25	750,00
M 8 x 18	S	200	7,60	M 12 x 50	S	100	30,00	M 16 x 180	S	25	750,00
M 8 x 20	S	200	7,60	M 12 x 55	S	100	37,50	M 16 x 190	S	25	900,00
M 8 x 22	S	200	8,70	M 12 x 60	S	100	40,50	M 16 x 200	S	25	900,00
M 8 x 25	S	200	8,70	M 12 x 65	S	50	61,00	M 16 x 210	S	25	940,00
M 8 x 28	S	200	9,40	M 12 x 70	S	50	61,00	M 16 x 220	S	1	970,00
M 8 x 30	S	200	9,40	M 12 x 75	S	50	69,00	M 16 x 230	S	1	1010,00
M 8 x 35	S	200	10,40	M 12 x 80	S	50	87,00	M 16 x 240	S	1	1050,00
M 8 x 40	S	200	11,40	M 12 x 85	S	50	104,00	M 16 x 250	S	1	1320,00
M 8 x 45	S	200	14,00	M 12 x 90	S	50	104,00	M 16 x 260	S	1	1420,00
M 8 x 50	S	200	16,20	M 12 x 100	S	50	116,00	M 16 x 280	S	1	1530,00
M 8 x 55	S	200	22,70	M 12 x 110	S	50	180,00	M 16 x 300	S	1	1780,00
M 8 x 60	S	200	24,30	M 12 x 120	S	50	182,00	M 16 x 320	S	1	2010,00
M 8 x 65	S	200	33,50	M 12 x 130	S	50	217,00	M 16 x 340	S	1	2180,00
M 8 x 70	S	200	42,00	M 12 x 140	S	50	226,00	M 16 x 400	S	1	3350,00
M 8 x 75	S	200	51,00	M 12 x 150	S	50	244,00	M 16 x 500	S	1	4300,00
M 8 x 80	S	200	51,00	M 12 x 160	S	25	475,00	M 18 x 20	S	50	285,00
M 8 x 85	S	200	64,00	M 12 x 170	S	25	580,00	M 18 x 25	S	50	285,00
M 8 x 90	S	100	60,00	M 12 x 180	S	25	580,00	M 18 x 30	S	50	209,00
M 8 x 100	S	100	69,00	M 12 x 190	S	25	700,00	M 18 x 35	S	50	215,00
M 8 x 110	S	100	88,00	M 12 x 200	S	25	700,00	M 18 x 40	S	50	215,00
M 8 x 120	S	100	92,00	M 12 x 220	S	25	820,00	M 18 x 45	S	50	215,00
M 8 x 130	S	100	148,00	M 12 x 240	S	25	900,00	M 18 x 50	S	50	222,00
M 8 x 140	S	100	184,00	M 12 x 300	S	25	2850,00	M 18 x 55	S	25	239,00
M 8 x 150	S	100	226,00	M 14 x 16	S	100	250,00	M 18 x 60	S	25	239,00
M 8 x 160	S	100	290,00	M 14 x 20	S	100	63,00	M 18 x 65	S	25	255,00
M 8 x 170	S	100	330,00	M 14 x 25	S	100	63,00	M 18 x 70	S	25	255,00
M 8 x 180	S	100	355,00	M 14 x 30	S	100	71,00	M 18 x 75	S	25	300,00
M 8 x 200	S	100	460,00	M 14 x 35	S	100	80,00	M 18 x 80	S	25	300,00
M 10 x 10	S	200	59,00	M 14 x 40	S	100	80,00	M 18 x 85	S	25	385,00
M 10 x 12	S	200	21,50	M 14 x 45	S	100	87,00	M 18 x 90	S	25	385,00
M 10 x 16	S	200	13,70	M 14 x 50	S	100	91,00	M 18 x 100	S	25	385,00
M 10 x 18	S	200	12,80	M 14 x 55	S	100	106,00	M 18 x 110	S	25	500,00
M 10 x 20	S	200	12,80	M 14 x 60	S	50	106,00	M 18 x 120	S	25	500,00
M 10 x 22	S	200	13,70	M 14 x 65	S	50	118,00	M 18 x 130	S	25	870,00
M 10 x 25	S	200	13,70	M 14 x 70	S	50	118,00	M 18 x 140	S	25	940,00
M 10 x 28	S	200	16,50	M 14 x 75	S	50	147,00	M 18 x 150	S	25	1010,00
M 10 x 30	S	200	14,60	M 14 x 80	S	50	147,00	M 18 x 160	S	25	1080,00
M 10 x 35	S	100	16,20	M 14 x 90	S	50	209,00	M 18 x 170	S	25	1140,00
M 10 x 40	S	100	17,30	M 14 x 100	S	50	239,00	M 18 x 180	S	25	1200,00
M 10 x 45	S	100	20,70	M 14 x 110	S	50	435,00	M 18 x 190	S	25	1260,00
M 10 x 50	S	100	21,60	M 14 x 120	S	50	315,00	M 18 x 200	S	25	1310,00
M 10 x 55	S	100	30,00	M 14 x 130	S	50	510,00	M 20 x 20	S	25	241,00
M 10 x 60	S	100	32,50	M 14 x 140	S	50	550,00	M 20 x 25	S	25	182,00
M 10 x 65	S	100	50,00	M 14 x 150	S	50	570,00	M 20 x 30	S	25	106,00
M 10 x 70	S	100	50,00	M 14 x 160	S	25	710,00	M 20 x 35	S	25	106,00
M 10 x 75	S	100	56,00	M 14 x 170	S	25	760,00	M 20 x 40	S	25	99,00
M 10 x 80	S	100	70,00	M 14 x 180	S	25	800,00	M 20 x 45	S	25	100,00
M 10 x 85	S	100	84,00	M 14 x 200	S	25	870,00	M 20 x 50	S	25	101,00
M 10 x 90	S	100	84,00	M 14 x 220	S	25	3850,00	M 20 x 55	S	25	107,00
M 10 x 100	S	100	99,00	M 16 x 12	S	50	201,00	M 20 x 60	S	25	108,00
M 10 x 110	S	50	136,00	M 16 x 16	S	50	205,00	M 20 x 65	S	25	126,00
M 10 x 120	S	50	141,00	M 16 x 20	S	50	47,50	M 20 x 70	S	25	130,00
M 10 x 130	S	50	186,00	M 16 x 25	S	50	47,50	M 20 x 75	S	25	166,00
M 10 x 140	S	50	193,00	M 16 x 30	S	50	45,00	M 20 x 80	S	25	161,00
M 10 x 150	S	50	212,00	M 16 x 35	S	50	47,50	M 20 x 85	S	25	240,00
M 10 x 160	S	50	325,00	M 16 x 40	S	50	49,50	M 20 x 90	S	25	240,00
M 10 x 170	S	50	650,00	M 16 x 45	S	50	53,00	M 20 x 100	S	25	345,00
M 10 x 180	S	50	640,00	M 16 x 50	S	50	57,00	M 20 x 110	S	25	380,00
M 10 x 190	S	50	660,00	M 16 x 55	S	50	69,00	M 20 x 120	S	25	420,00
M 10 x 200	S	50	690,00	M 16 x 60	S	50	72,00	M 20 x 130	S	25	540,00
M 10 x 220	S	50	1020,00	M 16 x 65	S	25	102,00	M 20 x 140	S	25	630,00
M 10 x 240	S	50	1930,00	M 16 x 70	S	25	102,00	M 20 x 150	S	25	720,00

Abmessungen	VE	Stück	€/100/Obf.	Abmessungen	VE	Stück	€/100/Obf.	Abmessungen	VE	Stück	€/100/Obf.
M 20 x 160	S	10	780,00	M 27 x 50	S	10	830,00	M 33 x 180	S	1	3250,00
M 20 x 170	S	1	1140,00	M 27 x 55	S	10	830,00	M 33 x 190	S	1	3400,00
M 20 x 180	S	1	1200,00	M 27 x 60	S	10	830,00	M 33 x 200	S	1	3550,00
M 20 x 190	S	1	1250,00	M 27 x 65	S	10	880,00	M 33 x 300	S	1	5100,00
M 20 x 200	S	1	1300,00	M 27 x 70	S	10	880,00	M 36 x 40	S	1	1740,00
M 20 x 210	S	1	1580,00	M 27 x 75	S	10	910,00	M 36 x 45	S	1	1740,00
M 20 x 220	S	1	1680,00	M 27 x 80	S	10	910,00	M 36 x 50	S	1	1740,00
M 20 x 230	S	1	1770,00	M 27 x 85	S	10	960,00	M 36 x 55	S	1	1740,00
M 20 x 240	S	1	1860,00	M 27 x 90	S	1	960,00	M 36 x 60	S	1	1740,00
M 20 x 250	S	1	1880,00	M 27 x 100	S	1	1020,00	M 36 x 65	S	1	1810,00
M 20 x 260	S	1	1980,00	M 27 x 110	S	1	1310,00	M 36 x 70	S	1	1810,00
M 20 x 280	S	1	2100,00	M 27 x 120	S	1	1310,00	M 36 x 75	S	1	1900,00
M 20 x 300	S	1	2270,00	M 27 x 130	S	1	1320,00	M 36 x 80	S	1	1900,00
M 20 x 360	S	1	4850,00	M 27 x 140	S	1	1650,00	M 36 x 85	S	1	2030,00
M 22 x 30	S	25	610,00	M 27 x 150	S	1	1730,00	M 36 x 90	S	1	2030,00
M 22 x 35	S	25	610,00	M 27 x 160	S	1	1930,00	M 36 x 100	S	1	2160,00
M 22 x 40	S	25	530,00	M 27 x 170	S	1	2030,00	M 36 x 110	S	1	2270,00
M 22 x 45	S	25	395,00	M 27 x 180	S	1	2120,00	M 36 x 120	S	1	2330,00
M 22 x 50	S	25	395,00	M 27 x 190	S	1	2210,00	M 36 x 130	S	1	2500,00
M 22 x 55	S	25	440,00	M 27 x 200	S	1	2300,00	M 36 x 140	S	1	2600,00
M 22 x 60	S	25	440,00	M 27 x 300	S	1	4450,00	M 36 x 150	S	1	2750,00
M 22 x 65	S	25	540,00	M 30 x 35	S	1	1090,00	M 36 x 160	S	1	2850,00
M 22 x 70	S	25	540,00	M 30 x 40	S	1	1090,00	M 36 x 170	S	1	3000,00
M 22 x 75	S	25	590,00	M 30 x 45	S	1	1090,00	M 36 x 180	S	1	3150,00
M 22 x 80	S	25	590,00	M 30 x 50	S	1	1090,00	M 36 x 190	S	1	3300,00
M 22 x 90	S	10	590,00	M 30 x 55	S	1	1090,00	M 36 x 200	S	1	3450,00
M 22 x 100	S	10	730,00	M 30 x 60	S	1	1090,00	M 36 x 220	S	1	4400,00
M 22 x 110	S	10	880,00	M 30 x 65	S	1	1170,00	M 36 x 260	S	1	5300,00
M 22 x 120	S	10	880,00	M 30 x 70	S	1	1170,00	M 36 x 280	S	1	5800,00
M 22 x 130	S	10	1130,00	M 30 x 75	S	1	1250,00	M 36 x 300	S	1	6200,00
M 22 x 140	S	10	1200,00	M 30 x 80	S	1	1250,00	M 36 x 320	S	1	11000,00
M 22 x 150	S	10	1280,00	M 30 x 85	S	1	1310,00	M 36 x 340	S	1	11400,00
M 22 x 160	S	10	1440,00	M 30 x 90	S	1	1310,00	M 36 x 400	S	1	12300,00
M 22 x 170	S	10	1510,00	M 30 x 100	S	1	1360,00	M 36 x 600	S	1	15400,00
M 22 x 180	S	10	1580,00	M 30 x 110	S	1	1440,00	M 39 x 80	S	1	4050,00
M 22 x 190	S	10	1650,00	M 30 x 120	S	1	1520,00	M 39 x 90	S	1	4250,00
M 22 x 200	S	10	1720,00	M 30 x 130	S	1	1650,00	M 39 x 100	S	1	4550,00
M 24 x 25	S	25	530,00	M 30 x 140	S	1	1710,00	M 39 x 110	S	1	4800,00
M 24 x 30	S	25	530,00	M 30 x 150	S	1	1770,00	M 39 x 120	S	1	5300,00
M 24 x 35	S	25	330,00	M 30 x 160	S	1	1980,00	M 39 x 130	S	1	5400,00
M 24 x 40	S	25	183,00	M 30 x 170	S	1	2090,00	M 39 x 140	S	1	5800,00
M 24 x 45	S	25	183,00	M 30 x 180	S	1	2160,00	M 39 x 150	S	1	6200,00
M 24 x 50	S	25	171,00	M 30 x 190	S	1	2240,00	M 39 x 160	S	1	6800,00
M 24 x 55	S	25	181,00	M 30 x 200	S	1	2310,00	M 39 x 180	S	1	7900,00
M 24 x 60	S	25	186,00	M 30 x 210	S	1	2650,00	M 39 x 190	S	1	8800,00
M 24 x 65	S	25	212,00	M 30 x 220	S	1	2700,00	M 39 x 200	S	1	8800,00
M 24 x 70	S	25	212,00	M 30 x 230	S	1	2800,00	M 42 x 50	S	1	4100,00
M 24 x 75	S	25	295,00	M 30 x 240	S	1	2850,00	M 42 x 55	S	1	4100,00
M 24 x 80	S	25	270,00	M 30 x 250	S	1	3350,00	M 42 x 60	S	1	4100,00
M 24 x 85	S	10	415,00	M 30 x 260	S	1	3450,00	M 42 x 70	S	1	4100,00
M 24 x 90	S	10	415,00	M 30 x 280	S	1	3750,00	M 42 x 75	S	1	4200,00
M 24 x 100	S	10	560,00	M 30 x 300	S	1	4100,00	M 42 x 80	S	1	4200,00
M 24 x 110	S	10	650,00	M 30 x 320	S	1	4600,00	M 42 x 85	S	1	4400,00
M 24 x 120	S	10	680,00	M 30 x 340	S	1	4950,00	M 42 x 90	S	1	4400,00
M 24 x 130	S	1	1150,00	M 30 x 360	S	1	5400,00	M 42 x 100	S	1	4600,00
M 24 x 140	S	1	1220,00	M 30 x 380	S	1	5800,00	M 42 x 110	S	1	5100,00
M 24 x 150	S	1	1280,00	M 30 x 400	S	1	6400,00	M 42 x 120	S	1	5400,00
M 24 x 160	S	1	1350,00	M 30 x 500	S	1	10100,00	M 42 x 130	S	1	5600,00
M 24 x 170	S	1	1510,00	M 30 x 600	S	1	11300,00	M 42 x 140	S	1	5800,00
M 24 x 180	S	1	1510,00	M 33 x 40	S	1	1440,00	M 42 x 150	S	1	6200,00
M 24 x 190	S	1	1750,00	M 33 x 50	S	1	1440,00	M 42 x 160	S	1	6300,00
M 24 x 200	S	1	1750,00	M 33 x 60	S	1	1440,00	M 42 x 170	S	1	7200,00
M 24 x 210	S	1	1940,00	M 33 x 65	S	1	1580,00	M 42 x 180	S	1	7500,00
M 24 x 220	S	1	2010,00	M 33 x 70	S	1	1580,00	M 42 x 190	S	1	7800,00
M 24 x 230	S	1	2090,00	M 33 x 75	S	1	1620,00	M 42 x 200	S	1	8300,00
M 24 x 240	S	1	2160,00	M 33 x 80	S	1	1620,00	M 42 x 220	S	1	9900,00
M 24 x 250	S	1	2240,00	M 33 x 90	S	1	1710,00	M 42 x 250	S	1	11500,00
M 24 x 260	S	1	2700,00	M 33 x 100	S	1	1800,00	M 42 x 260	S	1	12300,00
M 24 x 280	S	1	2950,00	M 33 x 110	S	1	1970,00	M 42 x 300	S	1	14000,00
M 24 x 300	S	1	3100,00	M 33 x 120	S	1	1970,00	M 42 x 360	S	1	16000,00
M 24 x 320	S	1	3500,00	M 33 x 130	S	1	2350,00	M 42 x 400	S	1	16700,00
M 24 x 500	S	1	8700,00	M 33 x 140	S	1	2550,00	M 45 x 90	S	1	7700,00
M 27 x 30	S	10	970,00	M 33 x 150	S	1	2700,00	M 45 x 100	S	1	7900,00
M 27 x 40	S	10	970,00	M 33 x 160	S	1	3000,00	M 45 x 110	S	1	8300,00
M 27 x 45	S	10	970,00	M 33 x 170	S	1	3150,00	M 45 x 120	S	1	8200,00

Abmessungen	VE	Stück	€/100/Obf.	Abmessungen	VE	Stück	€/100/Obf.	Abmessungen	VE	Stück	€/100/Obf.
M 45 x 130	S	1	8800,00	M 4 x 20	K	100	11,00 gal Zn	M 6 x 75	S	200	45,00 gal Zn
M 45 x 140	S	1	9100,00	M 4 x 22	S	500	8,80 gal Zn	M 6 x 80	S	200	45,50 gal Zn
M 45 x 150	S	1	9400,00	M 4 x 25	S	500	8,30 gal Zn	M 6 x 85	S	200	78,00 gal Zn
M 48 x 60	S	1	9400,00	M 4 x 25	K	100	11,90 gal Zn	M 6 x 90	S	200	78,00 gal Zn
M 48 x 70	S	1	9400,00	M 4 x 30	S	500	9,50 gal Zn	M 6 x 100	S	200	118,00 gal Zn
M 48 x 80	S	1	9400,00	M 4 x 30	K	100	13,10 gal Zn	M 6 x 110	S	100	137,00 gal Zn
M 48 x 90	S	1	9400,00	M 4 x 35	S	500	10,60 gal Zn	M 6 x 120	S	100	147,00 gal Zn
M 48 x 100	S	1	9600,00	M 4 x 35	K	100	14,20 gal Zn	M 6 x 130	S	100	226,00 gal Zn
M 48 x 110	S	1	10000,00	M 4 x 40	S	500	11,50 gal Zn	M 6 x 140	S	100	241,00 gal Zn
M 48 x 120	S	1	10300,00	M 4 x 40	K	100	15,10 gal Zn	M 6 x 150	S	100	290,00 gal Zn
M 48 x 130	S	1	10600,00	M 4 x 45	S	500	13,50 gal Zn	M 7 x 12	S	500	22,30 gal Zn
M 48 x 140	S	1	10700,00	M 4 x 50	S	500	14,60 gal Zn	M 7 x 16	S	500	16,90 gal Zn
M 48 x 150	S	1	11000,00	M 4 x 55	S	100	65,00 gal Zn	M 7 x 20	S	500	18,00 gal Zn
M 48 x 160	S	1	11200,00	M 4 x 60	S	100	91,00 gal Zn	M 7 x 25	S	500	20,90 gal Zn
M 48 x 170	S	1	12000,00	M 4 x 70	S	100	129,00 gal Zn	M 7 x 30	S	500	22,60 gal Zn
M 48 x 180	S	1	12900,00	M 5 x 6	S	500	16,00 gal Zn	M 7 x 40	S	500	27,50 gal Zn
M 48 x 190	S	1	13600,00	M 5 x 8	S	500	4,60 gal Zn	M 7 x 45	S	200	30,00 gal Zn
M 48 x 200	S	1	14600,00	M 5 x 8	K	100	8,30 gal Zn	M 8 x 8	S	200	33,00 gal Zn
M 48 x 420	S	1	20400,00	M 5 x 10	S	500	4,70 gal Zn	M 8 x 10	S	200	12,50 gal Zn
				M 5 x 10	K	100	8,30 gal Zn	M 8 x 12	S	200	11,50 gal Zn
				M 5 x 12	S	500	4,85 gal Zn	M 8 x 14	S	200	11,70 gal Zn
				M 5 x 12	K	100	8,50 gal Zn	M 8 x 16	S	200	9,70 gal Zn
				M 5 x 14	S	500	5,20 gal Zn	M 8 x 18	S	200	10,20 gal Zn
				M 5 x 16	S	500	5,00 gal Zn	M 8 x 20	S	200	10,30 gal Zn
				M 5 x 16	K	100	8,60 gal Zn	M 8 x 22	S	200	11,70 gal Zn
				M 5 x 18	S	500	5,40 gal Zn	M 8 x 25	S	200	11,80 gal Zn
				M 5 x 20	S	500	5,40 gal Zn	M 8 x 28	S	200	17,20 gal Zn
				M 5 x 20	K	100	8,90 gal Zn	M 8 x 30	S	200	12,90 gal Zn
				M 5 x 22	S	500	12,60 gal Zn	M 8 x 35	S	200	14,30 gal Zn
				M 5 x 25	S	500	6,10 gal Zn	M 8 x 40	S	200	15,70 gal Zn
				M 5 x 25	K	100	9,70 gal Zn	M 8 x 45	S	200	18,60 gal Zn
				M 5 x 30	S	500	6,90 gal Zn	M 8 x 50	S	200	21,20 gal Zn
				M 5 x 30	K	100	10,60 gal Zn	M 8 x 55	S	200	30,00 gal Zn
				M 5 x 35	S	200	7,90 gal Zn	M 8 x 60	S	200	32,00 gal Zn
				M 5 x 40	S	200	10,40 gal Zn	M 8 x 65	S	200	41,50 gal Zn
				M 5 x 45	S	200	12,00 gal Zn	M 8 x 70	S	200	51,00 gal Zn
				M 5 x 50	S	200	13,20 gal Zn	M 8 x 75	S	200	60,00 gal Zn
				M 5 x 55	S	200	19,60 gal Zn	M 8 x 80	S	200	60,00 gal Zn
				M 5 x 60	S	200	20,00 gal Zn	M 8 x 85	S	200	74,00 gal Zn
				M 5 x 65	S	200	59,00 gal Zn	M 8 x 90	S	100	70,00 gal Zn
				M 5 x 70	S	200	59,00 gal Zn	M 8 x 95	S	100	80,00 gal Zn
				M 5 x 75	S	200	160,00 gal Zn	M 8 x 100	S	100	80,00 gal Zn
				M 5 x 80	S	200	88,00 gal Zn	M 8 x 110	S	100	101,00 gal Zn
				M 5 x 90	S	200	141,00 gal Zn	M 8 x 120	S	100	105,00 gal Zn
				M 5 x 100	S	200	164,00 gal Zn	M 8 x 130	S	100	164,00 gal Zn
				M 6 x 6	S	500	23,00 gal Zn	M 8 x 140	S	100	201,00 gal Zn
				M 6 x 6	K	100	27,00 gal Zn	M 8 x 150	S	100	242,00 gal Zn
				M 6 x 8	S	500	6,90 gal Zn	M 8 x 160	S	100	305,00 gal Zn
				M 6 x 8	K	100	10,60 gal Zn	M 8 x 170	S	100	350,00 gal Zn
				M 6 x 10	S	500	6,50 gal Zn	M 8 x 180	S	100	375,00 gal Zn
				M 6 x 10	K	100	10,20 gal Zn	M 8 x 190	S	100	540,00 gal Zn
				M 6 x 12	S	500	6,60 gal Zn	M 8 x 200	S	100	490,00 gal Zn
				M 6 x 12	K	100	10,20 gal Zn	M 10 x 10	S	200	65,00 gal Zn
				M 6 x 14	S	500	5,90 gal Zn	M 10 x 12	S	200	25,50 gal Zn
				M 6 x 16	S	500	6,10 gal Zn	M 10 x 14	S	200	18,10 gal Zn
				M 6 x 16	K	100	9,70 gal Zn	M 10 x 16	S	200	18,10 gal Zn
				M 6 x 18	S	500	6,30 gal Zn	M 10 x 18	S	200	17,40 gal Zn
				M 6 x 18	K	100	10,00 gal Zn	M 10 x 20	S	200	17,70 gal Zn
				M 6 x 20	S	500	6,40 gal Zn	M 10 x 22	S	200	18,70 gal Zn
				M 6 x 20	K	100	10,10 gal Zn	M 10 x 25	S	200	19,10 gal Zn
				M 6 x 22	S	500	6,90 gal Zn	M 10 x 28	S	200	22,20 gal Zn
				M 6 x 22	K	100	10,60 gal Zn	M 10 x 30	S	200	20,60 gal Zn
				M 6 x 25	S	500	7,10 gal Zn	M 10 x 35	S	100	22,70 gal Zn
				M 6 x 25	K	100	10,70 gal Zn	M 10 x 40	S	100	24,40 gal Zn
				M 6 x 28	S	500	14,30 gal Zn	M 10 x 45	S	100	28,50 gal Zn
				M 6 x 30	S	500	7,70 gal Zn	M 10 x 50	S	100	30,00 gal Zn
				M 6 x 30	K	100	11,20 gal Zn	M 10 x 55	S	100	39,00 gal Zn
				M 6 x 35	S	200	8,50 gal Zn	M 10 x 60	S	100	42,00 gal Zn
				M 6 x 40	S	200	9,40 gal Zn	M 10 x 65	S	100	63,00 gal Zn
				M 6 x 45	S	200	12,90 gal Zn	M 10 x 70	S	100	64,00 gal Zn
				M 6 x 50	S	200	13,20 gal Zn	M 10 x 75	S	100	71,00 gal Zn
				M 6 x 55	S	200	22,20 gal Zn	M 10 x 80	S	100	86,00 gal Zn
				M 6 x 60	S	200	24,90 gal Zn	M 10 x 85	S	100	100,00 gal Zn
				M 6 x 65	S	200	31,50 gal Zn	M 10 x 90	S	100	101,00 gal Zn
				M 6 x 70	S	200	38,50 gal Zn	M 10 x 95	S	100	176,00 gal Zn

ISO 04017.810
4017 8.8
 galvanisch verzinkt



Sechskantschrauben mit Gewinde bis Kopf

*M 10/12/14/22 = RAZ 3220 übrige = RAZ 401

Maße → TI-15 Anziehmomente → TI-244
 Werkstoffeigensch. → TI-232 Normumstellung → TI-6
 Korrosionsschutz → TI-228

Rostfrei → S. 534
 Messing → S. 636

ISO 4017 → ersetzt DIN 933

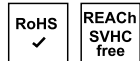

Abmessungen	VE	Stück	€/100/Obf.	Abmessungen	VE	Stück	€/100/Obf.	Abmessungen	VE	Stück	€/100/Obf.
M 10 x 100	S	100	118,00 gal Zn	M 16 x 55	S	50	94,00 gal Zn	M 20 x 250	S	1	2190,00 gal Zn
M 10 x 110	S	50	157,00 gal Zn	M 16 x 60	S	50	99,00 gal Zn	M 20 x 260	S	1	2260,00 gal Zn
M 10 x 120	S	50	161,00 gal Zn	M 16 x 65	S	25	141,00 gal Zn	M 20 x 280	S	1	2390,00 gal Zn
M 10 x 130	S	50	210,00 gal Zn	M 16 x 70	S	25	143,00 gal Zn	M 20 x 300	S	1	2600,00 gal Zn
M 10 x 140	S	50	216,00 gal Zn	M 16 x 75	S	50	164,00 gal Zn	M 20 x 320	S	1	4100,00 gal Zn
M 10 x 150	S	50	239,00 gal Zn	M 16 x 80	S	25	195,00 gal Zn	M 20 x 340	S	1	4300,00 gal Zn
M 10 x 160	S	50	360,00 gal Zn	M 16 x 85	S	25	244,00 gal Zn	M 20 x 360	S	1	5200,00 gal Zn
M 10 x 170	S	50	680,00 gal Zn	M 16 x 90	S	25	245,00 gal Zn	M 20 x 460	S	1	7900,00 gal Zn
M 10 x 180	S	50	670,00 gal Zn	M 16 x 95	S	25	280,00 gal Zn	M 22 x 40	S	25	620,00 gal Zn
M 10 x 190	S	50	700,00 gal Zn	M 16 x 100	S	25	280,00 gal Zn	M 22 x 50	S	25	460,00 gal Zn
M 10 x 200	S	50	730,00 gal Zn	M 16 x 110	S	25	355,00 gal Zn	M 22 x 55	S	25	510,00 gal Zn
M 10 x 220	S	50	1070,00 gal Zn	M 16 x 120	S	25	380,00 gal Zn	M 22 x 60	S	25	520,00 gal Zn
M 12 x 12	S	100	142,00 gal Zn	M 16 x 130	S	25	400,00 gal Zn	M 22 x 65	S	25	620,00 gal Zn
M 12 x 16	S	100	31,50 gal Zn	M 16 x 140	S	25	420,00 gal Zn	M 22 x 70	S	25	620,00 gal Zn
M 12 x 18	S	100	32,00 gal Zn	M 16 x 150	S	25	470,00 gal Zn	M 22 x 75	S	25	670,00 gal Zn
M 12 x 20	S	100	29,50 gal Zn	M 16 x 160	S	25	740,00 gal Zn	M 22 x 80	S	25	680,00 gal Zn
M 12 x 22	S	100	30,00 gal Zn	M 16 x 170	S	25	820,00 gal Zn	M 22 x 90	S	25	680,00 gal Zn
M 12 x 25	S	100	30,50 gal Zn	M 16 x 180	S	25	830,00 gal Zn	M 22 x 100	S	10	840,00 gal Zn
M 12 x 28	S	100	38,00 gal Zn	M 16 x 190	S	25	980,00 gal Zn	M 22 x 110	S	10	990,00 gal Zn
M 12 x 30	S	100	30,00 gal Zn	M 16 x 200	S	25	990,00 gal Zn	M 22 x 120	S	10	1000,00 gal Zn
M 12 x 35	S	100	32,50 gal Zn	M 16 x 210	S	25	1050,00 gal Zn	M 24 x 25	S	25	600,00 gal Zn
M 12 x 40	S	100	35,50 gal Zn	M 16 x 220	S	1	1070,00 gal Zn	M 24 x 30	S	25	610,00 gal Zn
M 12 x 45	S	100	39,00 gal Zn	M 16 x 230	S	1	1110,00 gal Zn	M 24 x 35	S	25	400,00 gal Zn
M 12 x 50	S	100	42,00 gal Zn	M 16 x 240	S	1	1150,00 gal Zn	M 24 x 40	S	25	239,00 gal Zn
M 12 x 55	S	100	51,00 gal Zn	M 16 x 250	S	1	1430,00 gal Zn	M 24 x 45	S	25	242,00 gal Zn
M 12 x 60	S	100	54,00 gal Zn	M 16 x 260	S	1	1550,00 gal Zn	M 24 x 50	S	25	233,00 gal Zn
M 12 x 65	S	50	80,00 gal Zn	M 16 x 280	S	1	1680,00 gal Zn	M 24 x 55	S	25	245,00 gal Zn
M 12 x 70	S	50	81,00 gal Zn	M 16 x 300	S	1	1940,00 gal Zn	M 24 x 60	S	25	260,00 gal Zn
M 12 x 75	S	50	91,00 gal Zn	M 16 x 320	S	1	2170,00 gal Zn	M 24 x 65	S	25	285,00 gal Zn
M 12 x 80	S	50	109,00 gal Zn	M 16 x 340	S	1	2360,00 gal Zn	M 24 x 70	S	25	290,00 gal Zn
M 12 x 85	S	50	129,00 gal Zn	M 18 x 20	S	50	315,00 gal Zn	M 24 x 75	S	25	375,00 gal Zn
M 12 x 90	S	50	129,00 gal Zn	M 18 x 25	S	50	315,00 gal Zn	M 24 x 80	S	25	355,00 gal Zn
M 12 x 95	S	50	199,00 gal Zn	M 18 x 30	S	50	240,00 gal Zn	M 24 x 85	S	25	530,00 gal Zn
M 12 x 100	S	50	144,00 gal Zn	M 18 x 35	S	50	249,00 gal Zn	M 24 x 90	S	10	530,00 gal Zn
M 12 x 110	S	50	209,00 gal Zn	M 18 x 40	S	50	255,00 gal Zn	M 24 x 95	S	10	890,00 gal Zn
M 12 x 120	S	50	213,00 gal Zn	M 18 x 45	S	50	255,00 gal Zn	M 24 x 100	S	10	690,00 gal Zn
M 12 x 130	S	50	255,00 gal Zn	M 18 x 50	S	50	265,00 gal Zn	M 24 x 110	S	10	790,00 gal Zn
M 12 x 140	S	50	265,00 gal Zn	M 18 x 55	S	25	285,00 gal Zn	M 24 x 120	S	10	820,00 gal Zn
M 12 x 150	S	100	285,00 gal Zn	M 18 x 60	S	25	285,00 gal Zn	M 24 x 130	S	1	1300,00 gal Zn
M 12 x 160	S	25	520,00 gal Zn	M 18 x 65	S	25	305,00 gal Zn	M 24 x 140	S	1	1390,00 gal Zn
M 12 x 170	S	25	620,00 gal Zn	M 18 x 70	S	25	305,00 gal Zn	M 24 x 150	S	1	1460,00 gal Zn
M 12 x 180	S	25	620,00 gal Zn	M 18 x 75	S	25	350,00 gal Zn	M 24 x 160	S	1	1540,00 gal Zn
M 12 x 190	S	25	750,00 gal Zn	M 18 x 80	S	25	355,00 gal Zn	M 24 x 170	S	1	1740,00 gal Zn
M 12 x 200	S	25	750,00 gal Zn	M 18 x 90	S	25	445,00 gal Zn	M 24 x 180	S	1	1700,00 gal Zn
M 12 x 220	S	25	880,00 gal Zn	M 18 x 100	S	25	450,00 gal Zn	M 24 x 190	S	1	2000,00 gal Zn
M 12 x 240	S	25	950,00 gal Zn	M 20 x 20	S	25	305,00 gal Zn	M 24 x 200	S	1	1970,00 gal Zn
M 12 x 260	S	25	2650,00 gal Zn	M 20 x 25	S	25	220,00 gal Zn	M 24 x 210	S	1	2160,00 gal Zn
M 14 x 20	S	100	78,00 gal Zn	M 20 x 30	S	25	137,00 gal Zn	M 24 x 220	S	1	1970,00 gal Zn
M 14 x 25	S	100	80,00 gal Zn	M 20 x 35	S	25	141,00 gal Zn	M 24 x 240	S	1	2470,00 gal Zn
M 14 x 30	S	100	89,00 gal Zn	M 20 x 40	S	25	135,00 gal Zn	M 24 x 250	S	1	2550,00 gal Zn
M 14 x 35	S	100	99,00 gal Zn	M 20 x 45	S	25	138,00 gal Zn	M 24 x 260	S	1	3050,00 gal Zn
M 14 x 40	S	100	100,00 gal Zn	M 20 x 50	S	25	143,00 gal Zn	M 24 x 280	S	1	3300,00 gal Zn
M 14 x 45	S	100	110,00 gal Zn	M 20 x 55	S	25	151,00 gal Zn	M 24 x 300	S	1	3450,00 gal Zn
M 14 x 50	S	100	115,00 gal Zn	M 20 x 60	S	25	154,00 gal Zn	M 24 x 320	S	1	3900,00 gal Zn
M 14 x 55	S	100	131,00 gal Zn	M 20 x 65	S	25	174,00 gal Zn	M 27 x 40	S	10	1200,00 gal Zn
M 14 x 60	S	50	132,00 gal Zn	M 20 x 70	S	25	181,00 gal Zn	M 27 x 45	S	10	1460,00 gal Zn
M 14 x 65	S	50	146,00 gal Zn	M 20 x 75	S	25	217,00 gal Zn	M 27 x 50	S	10	1330,00 gal Zn
M 14 x 70	S	50	147,00 gal Zn	M 20 x 80	S	25	215,00 gal Zn	M 27 x 55	S	10	1340,00 gal Zn
M 14 x 75	S	50	177,00 gal Zn	M 20 x 85	S	25	315,00 gal Zn	M 27 x 60	S	10	960,00 gal Zn
M 14 x 80	S	50	180,00 gal Zn	M 20 x 90	S	25	320,00 gal Zn	M 27 x 65	S	10	950,00 gal Zn
M 14 x 90	S	50	242,00 gal Zn	M 20 x 100	S	25	430,00 gal Zn	M 27 x 70	S	10	1020,00 gal Zn
M 14 x 100	S	50	280,00 gal Zn	M 20 x 110	S	25	470,00 gal Zn	M 27 x 75	S	10	1120,00 gal Zn
M 14 x 110	S	50	475,00 gal Zn	M 20 x 120	S	25	520,00 gal Zn	M 27 x 80	S	10	1060,00 gal Zn
M 14 x 120	S	50	355,00 gal Zn	M 20 x 130	S	25	650,00 gal Zn	M 27 x 90	S	1	1120,00 gal Zn
M 14 x 130	S	50	570,00 gal Zn	M 20 x 140	S	25	740,00 gal Zn	M 27 x 100	S	1	1190,00 gal Zn
M 14 x 140	S	50	590,00 gal Zn	M 20 x 150	S	25	830,00 gal Zn	M 27 x 110	S	1	1490,00 gal Zn
M 14 x 200	S	25	940,00 gal Zn	M 20 x 160	S	10	900,00 gal Zn	M 27 x 120	S	1	1500,00 gal Zn
M 8 x 200	S	50	220,00 gal Zn	M 20 x 170	S	10	1290,00 gal Zn	M 27 x 130	S	1	1530,00 gal Zn
M 16 x 20	S	50	62,00 gal Zn	M 20 x 180	S	1	1480,00 gal Zn	M 27 x 140	S	1	1860,00 gal Zn
M 16 x 25	S	50	64,00 gal Zn	M 20 x 190	S	1	1540,00 gal Zn	M 27 x 150	S	1	1960,00 gal Zn
M 16 x 30	S	50	63,00 gal Zn	M 20 x 200	S	1	1610,00 gal Zn	M 27 x 160	S	1	2170,00 gal Zn
M 16 x 35	S	50	67,00 gal Zn	M 20 x 210	S	1	1780,00 gal Zn	M 27 x 180	S	1	2390,00 gal Zn
M 16 x 40	S	50	70,00 gal Zn	M 20 x 220	S	1	1960,00 gal Zn	M 27 x 200	S	1	2600,00 gal Zn
M 16 x 45	S	50	75,00 gal Zn	M 20 x 230	S	1	1970,00 gal Zn	M 30 x 35	S	1	1250,00 gal Zn
M 16 x 50	S	50	80,00 gal Zn	M 20 x 240	S	1	2170,00 gal Zn	M 30 x 40	S	1	1230,00 gal Zn

Abmessungen	VE	Stück	€/100/Obf.	Abmessungen	VE	Stück	€/100/Obf.	Abmessungen	VE	Stück	€/100/Obf.
M 30 x 45	S	1	1230,00 gal Zn	M 39 x 200	S	1	9600,00 gal Zn	M 5 x 12	S	500	6,10 gal ZnDi
M 30 x 50	S	1	1240,00 gal Zn	M 42 x 50	S	1	4550,00 gal Zn	M 5 x 16	S	500	6,30 gal ZnDi
M 30 x 55	S	1	1250,00 gal Zn	M 42 x 60	S	1	4550,00 gal Zn	M 5 x 20	S	500	6,70 gal ZnDi
M 30 x 60	S	1	1260,00 gal Zn	M 42 x 70	S	1	4600,00 gal Zn	M 5 x 25	S	500	7,60 gal ZnDi
M 30 x 65	S	1	1340,00 gal Zn	M 42 x 75	S	1	4750,00 gal Zn	M 5 x 30	S	500	8,70 gal ZnDi
M 30 x 70	S	1	1350,00 gal Zn	M 42 x 80	S	1	4750,00 gal Zn	M 5 x 35	S	200	9,90 gal ZnDi
M 30 x 75	S	1	1440,00 gal Zn	M 42 x 90	S	1	4950,00 gal Zn	M 5 x 40	S	200	13,00 gal ZnDi
M 30 x 80	S	1	1440,00 gal Zn	M 42 x 100	S	1	5200,00 gal Zn	M 5 x 50	S	200	16,90 gal ZnDi
M 30 x 85	S	1	1520,00 gal Zn	M 42 x 110	S	1	5700,00 gal Zn	M 6 x 8	S	500	8,60 gal ZnDi
M 30 x 90	S	1	1520,00 gal Zn	M 42 x 120	S	1	6000,00 gal Zn	M 6 x 10	S	500	8,10 gal ZnDi
M 30 x 100	S	1	1580,00 gal Zn	M 42 x 130	S	1	6300,00 gal Zn	M 6 x 12	S	500	8,20 gal ZnDi
M 30 x 110	S	1	1670,00 gal Zn	M 42 x 140	S	1	6600,00 gal Zn	M 6 x 16	S	500	7,60 gal ZnDi
M 30 x 120	S	1	1770,00 gal Zn	M 42 x 150	S	1	7000,00 gal Zn	M 6 x 18	S	500	7,90 gal ZnDi
M 30 x 130	S	1	1910,00 gal Zn	M 42 x 160	S	1	7100,00 gal Zn	M 6 x 20	S	500	8,00 gal ZnDi
M 30 x 140	S	1	1990,00 gal Zn	M 42 x 170	S	1	8100,00 gal Zn	M 6 x 30	S	100	9,60 gal ZnDi
M 30 x 150	S	1	2070,00 gal Zn	M 42 x 180	S	1	8400,00 gal Zn	M 6 x 35	S	200	10,60 gal ZnDi
M 30 x 160	S	1	2280,00 gal Zn	M 42 x 190	S	1	8700,00 gal Zn	M 6 x 40	S	200	11,70 gal ZnDi
M 30 x 170	S	1	2350,00 gal Zn	M 42 x 200	S	1	9200,00 gal Zn	M 6 x 45	S	200	16,10 gal ZnDi
M 30 x 180	S	1	2500,00 gal Zn	M 42 x 220	S	1	10900,00 gal Zn	M 6 x 50	S	200	16,60 gal ZnDi
M 30 x 190	S	1	2700,00 gal Zn	M 48 x 60	S	1	10100,00 gal Zn	M 6 x 55	S	200	28,00 gal ZnDi
M 30 x 200	S	1	2700,00 gal Zn	M 48 x 70	S	1	10100,00 gal Zn	M 6 x 60	S	200	31,50 gal ZnDi
M 30 x 210	S	1	2900,00 gal Zn	M 48 x 80	S	1	10200,00 gal Zn	M 6 x 65	S	200	39,50 gal ZnDi
M 30 x 220	S	1	3100,00 gal Zn	M 48 x 90	S	1	10200,00 gal Zn	M 6 x 70	S	200	48,00 gal ZnDi
M 30 x 240	S	1	3300,00 gal Zn	M 48 x 100	S	1	10500,00 gal Zn	M 6 x 75	S	200	56,00 gal ZnDi
M 30 x 260	S	1	4200,00 gal Zn	M 48 x 110	S	1	10800,00 gal Zn	M 6 x 80	S	200	57,00 gal ZnDi
M 30 x 280	S	1	4550,00 gal Zn	M 48 x 120	S	1	11200,00 gal Zn	M 8 x 10	S	200	15,70 gal ZnDi
M 30 x 300	S	1	4950,00 gal Zn	M 48 x 130	S	1	11500,00 gal Zn	M 8 x 12	S	200	14,40 gal ZnDi
M 30 x 320	S	1	5300,00 gal Zn	M 48 x 140	S	1	11800,00 gal Zn	M 8 x 16	S	200	12,10 gal ZnDi
M 33 x 60	S	1	1650,00 gal Zn	M 48 x 150	S	1	12000,00 gal Zn	M 8 x 18	S	200	12,80 gal ZnDi
M 33 x 70	S	1	1810,00 gal Zn	M 48 x 200	S	1	19500,00 gal Zn	M 8 x 20	S	200	12,90 gal ZnDi
M 33 x 75	S	1	1910,00 gal Zn					M 8 x 22	S	200	14,60 gal ZnDi
M 33 x 80	S	1	1870,00 gal Zn					M 8 x 25	S	200	14,80 gal ZnDi
M 33 x 90	S	1	1970,00 gal Zn					M 8 x 30	S	200	16,10 gal ZnDi
M 33 x 100	S	1	2080,00 gal Zn					M 8 x 35	S	200	17,90 gal ZnDi
M 33 x 110	S	1	2260,00 gal Zn					M 8 x 40	S	200	19,60 gal ZnDi
M 33 x 120	S	1	2280,00 gal Zn					M 8 x 45	S	200	23,20 gal ZnDi
M 33 x 130	S	1	2700,00 gal Zn					M 8 x 50	S	200	26,50 gal ZnDi
M 33 x 140	S	1	2900,00 gal Zn					M 8 x 55	S	200	37,50 gal ZnDi
M 33 x 150	S	1	3050,00 gal Zn					M 8 x 60	S	200	40,00 gal ZnDi
M 33 x 160	S	1	3400,00 gal Zn					M 8 x 65	S	200	52,00 gal ZnDi
M 33 x 170	S	1	3550,00 gal Zn					M 8 x 70	S	200	63,00 gal ZnDi
M 33 x 180	S	1	3700,00 gal Zn					M 8 x 75	S	200	75,00 gal ZnDi
M 33 x 190	S	1	3850,00 gal Zn					M 8 x 80	S	200	75,00 gal ZnDi
M 33 x 200	S	1	4000,00 gal Zn					M 8 x 90	S	100	88,00 gal ZnDi
M 36 x 50	S	1	1980,00 gal Zn					M 8 x 100	S	100	101,00 gal ZnDi
M 36 x 55	S	1	1990,00 gal Zn					M 8 x 110	S	100	126,00 gal ZnDi
M 36 x 60	S	1	2000,00 gal Zn					M 10 x 12	S	200	32,00 gal ZnDi
M 36 x 70	S	1	2080,00 gal Zn					M 10 x 16	S	200	22,60 gal ZnDi
M 36 x 75	S	1	2190,00 gal Zn					M 10 x 20	S	200	22,10 gal ZnDi
M 36 x 80	S	1	2200,00 gal Zn					M 10 x 25	S	200	23,90 gal ZnDi
M 36 x 85	S	1	2340,00 gal Zn					M 10 x 30	S	200	26,00 gal ZnDi
M 36 x 90	S	1	2350,00 gal Zn					M 10 x 35	S	100	28,50 gal ZnDi
M 36 x 100	S	1	2500,00 gal Zn					M 10 x 40	S	100	30,50 gal ZnDi
M 36 x 110	S	1	2650,00 gal Zn					M 10 x 45	S	100	36,00 gal ZnDi
M 36 x 120	S	1	2750,00 gal Zn					M 10 x 50	S	100	37,50 gal ZnDi
M 36 x 130	S	1	2900,00 gal Zn					M 10 x 55	S	100	48,50 gal ZnDi
M 36 x 140	S	1	3000,00 gal Zn					M 10 x 60	S	100	53,00 gal ZnDi
M 36 x 150	S	1	3200,00 gal Zn					M 10 x 65	S	100	79,00 gal ZnDi
M 36 x 160	S	1	3300,00 gal Zn					M 10 x 70	S	100	80,00 gal ZnDi
M 36 x 170	S	1	3500,00 gal Zn					M 10 x 80	S	100	108,00 gal ZnDi
M 36 x 180	S	1	3650,00 gal Zn					M 10 x 90	S	100	126,00 gal ZnDi
M 36 x 190	S	1	3800,00 gal Zn					M 10 x 100	S	100	148,00 gal ZnDi
M 36 x 200	S	1	4000,00 gal Zn					M 10 x 110	S	50	197,00 gal ZnDi
M 36 x 220	S	1	5000,00 gal Zn					M 10 x 120	S	50	203,00 gal ZnDi
M 36 x 280	S	1	5200,00 gal Zn					M 10 x 130	S	50	265,00 gal ZnDi
M 39 x 80	S	1	4500,00 gal Zn					M 12 x 16	S	100	39,50 gal ZnDi
M 39 x 90	S	1	4500,00 gal Zn					M 12 x 20	S	100	37,00 gal ZnDi
M 39 x 100	S	1	5100,00 gal Zn					M 12 x 25	S	100	38,00 gal ZnDi
M 39 x 110	S	1	5300,00 gal Zn					M 12 x 30	S	100	37,50 gal ZnDi
M 39 x 120	S	1	5900,00 gal Zn					M 12 x 35	S	100	41,00 gal ZnDi
M 39 x 130	S	1	6000,00 gal Zn					M 12 x 40	S	100	44,50 gal ZnDi
M 39 x 140	S	1	6400,00 gal Zn					M 12 x 45	S	100	49,00 gal ZnDi
M 39 x 150	S	1	6900,00 gal Zn					M 12 x 50	S	100	53,00 gal ZnDi
M 39 x 160	S	1	7500,00 gal Zn					M 12 x 55	S	100	63,00 gal ZnDi
M 39 x 180	S	1	8600,00 gal Zn					M 12 x 60	S	100	67,00 gal ZnDi
M 3 x 8	S	500	7,50 gal ZnDi	M 39 x 200	S	1	9600,00 gal Zn	M 5 x 12	S	500	6,10 gal ZnDi
M 3 x 10	S	500	7,60 gal ZnDi	M 42 x 50	S	1	4550,00 gal Zn	M 5 x 16	S	500	6,30 gal ZnDi
M 3 x 12	S	500	8,30 gal ZnDi	M 42 x 60	S	1	4550,00 gal Zn	M 5 x 20	S	500	6,70 gal ZnDi
M 3 x 16	S	500	8,30 gal ZnDi	M 42 x 70	S	1	4600,00 gal Zn	M 5 x 25	S	500	7,60 gal ZnDi
M 3 x 20	S	500	8,70 gal ZnDi	M 42 x 75	S	1	4750,00 gal Zn	M 5 x 30	S	500	8,70 gal ZnDi
M 3 x 25	S	500	9,90 gal ZnDi	M 42 x 80	S	1	4750,00 gal Zn	M 5 x 35	S	200	9,90 gal ZnDi
M 4 x 6	S	500	7,80 gal ZnDi	M 42 x 90	S	1	4950,00 gal Zn	M 5 x 40	S	200	13,00 gal ZnDi
M 4 x 10	S	500	7,90 gal ZnDi	M 42 x 100	S	1	5200,00 gal Zn	M 5 x 50	S	200	16,90 gal ZnDi
M 4 x 12	S	500	8,60 gal ZnDi	M 42 x 110	S	1	5700,00 gal Zn	M 6 x 8	S	500	8,60 gal ZnDi
M 4 x 16	S	500	8,70 gal ZnDi	M 42 x 120	S	1	6000,00 gal Zn	M 6 x 10	S	500	8,10 gal ZnDi
M 4 x 20	S	500	9,20 gal ZnDi	M 42 x 130	S	1	6300,00 gal Zn	M 6 x 12	S	500	8,20 gal ZnDi
M 4 x 25	S	500	10,30 gal ZnDi	M 42 x 140	S	1	6600,00 gal Zn	M 6 x 16	S	500	7,60 gal ZnDi
M 4 x 30	S	500	12,00 gal ZnDi	M 42 x 150	S	1	7000,00 gal Zn	M 6 x 18	S	500	7,90 gal ZnDi
M 4 x 35	S	500	13,20 gal ZnDi	M 42 x 160	S	1	7100,00 gal Zn	M 6 x 20	S	500	8,00 gal ZnDi
M 4 x 40	S	500	14,40 gal ZnDi	M 42 x 170	S	1	8100,00 gal Zn	M 6 x 30	S	100	9,60 gal ZnDi
M 5 x 8	S	500	5,80 gal ZnDi	M 42 x 180	S	1	8400,00 gal Zn	M 6 x 35	S	200	10,60 gal ZnDi
M 5 x 10	S	500	5,90 gal ZnDi	M 42 x 190	S	1	8700,00 gal Zn	M 6 x 40	S	200	11,70 gal ZnDi

ISO 04017.317
4017 8.8
 galv. verz. 8 DiSP**

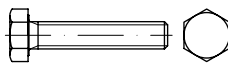

Sechskantschrauben mit Gewinde bis Kopf

*M 10/12/14/22 = RAZ 3220 übrige = RAZ 401,
 **< M 6 Mindestschichtdicke 5µm,
 Korrosionsbeständigkeit NSS: 72h WR, 120h RR

Maße → TI-15 Anziehmomente → TI-244
 Werkstoffeigensch. → TI-232 Normumstellung → TI-6
 Korrosionsschutz → TI-228

Rostfrei → S. 534
 Messing → S. 636

ISO 4017 → ersetzt DIN 933

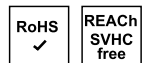

Abmessungen	VE Stück	€/100/Obf.
ISO 04017.820		
4017	8.8	feuerverzinkt

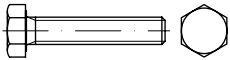

Sechskantschrauben mit Gewinde bis Kopf

*M 10/12/14/22 = RAZ 3230 übrige Ø = RAZ 403, Gewindetoleranz 6h (6az + tzn = U)

Maße → **TI-15** Anziehungsmomente → **TI-244**
 Werkstoffeigensch. → **TI-232** Normumstellung → **TI-6**
 Korrosionsschutz → **TI-231**
 Rostfrei → **S. 534**
 Messing → **S. 636**

ISO 4017 → ersetzt DIN 933



M 6	x	12	S	500	61,00 tzn
M 6	x	16	S	500	60,00 tzn
M 6	x	20	S	500	63,00 tzn
M 6	x	25	S	500	66,00 tzn
M 6	x	30	S	500	75,00 tzn
M 6	x	35	S	200	79,00 tzn
M 6	x	40	S	200	98,00 tzn
M 8	x	10	S	200	92,00 tzn
M 8	x	12	S	200	28,50 tzn
M 8	x	16	S	200	25,50 tzn
M 8	x	18	S	200	76,00 tzn
M 8	x	20	S	200	27,50 tzn
M 8	x	25	S	200	31,50 tzn
M 8	x	30	S	200	34,50 tzn
M 8	x	35	S	200	38,50 tzn
M 8	x	40	S	200	42,00 tzn
M 8	x	45	S	200	49,00 tzn
M 8	x	50	S	200	55,00 tzn
M 8	x	60	S	200	75,00 tzn
M 8	x	70	S	200	114,00 tzn
M 8	x	80	S	200	135,00 tzn
M 8	x	90	S	100	430,00 tzn
M 8	x	100	S	100	450,00 tzn
M 10	x	12	S	200	62,00 tzn
M 10	x	16	S	200	47,50 tzn
M 10	x	18	S	200	142,00 tzn
M 10	x	20	S	200	47,50 tzn
M 10	x	25	S	200	52,00 tzn
M 10	x	30	S	200	57,00 tzn
M 10	x	35	S	100	62,00 tzn
M 10	x	40	S	100	66,00 tzn
M 10	x	45	S	100	76,00 tzn
M 10	x	50	S	100	81,00 tzn
M 10	x	55	S	100	100,00 tzn
M 10	x	60	S	100	107,00 tzn
M 10	x	70	S	100	148,00 tzn
M 10	x	80	S	100	195,00 tzn
M 10	x	90	S	100	234,00 tzn
M 10	x	100	S	100	270,00 tzn
M 12	x	16	S	100	80,00 tzn
M 12	x	20	S	100	77,00 tzn
M 12	x	25	S	100	80,00 tzn
M 12	x	30	S	100	81,00 tzn
M 12	x	35	S	100	89,00 tzn
M 12	x	40	S	100	96,00 tzn
M 12	x	45	S	100	105,00 tzn
M 12	x	50	S	100	113,00 tzn
M 12	x	55	S	100	132,00 tzn
M 12	x	60	S	100	141,00 tzn

Abmessungen	VE Stück	€/100/Obf.			
M 12	x	65	S	50	177,00 tzn
M 12	x	70	S	50	193,00 tzn
M 12	x	80	S	50	255,00 tzn
M 12	x	90	S	50	295,00 tzn
M 12	x	100	S	50	330,00 tzn
M 12	x	120	S	50	475,00 tzn
M 16	x	20	S	50	161,00 tzn
M 16	x	25	S	50	167,00 tzn
M 16	x	30	S	50	167,00 tzn
M 16	x	35	S	50	181,00 tzn
M 16	x	40	S	50	193,00 tzn
M 16	x	45	S	50	204,00 tzn
M 16	x	50	S	50	220,00 tzn
M 16	x	55	S	50	255,00 tzn
M 16	x	60	S	50	265,00 tzn
M 16	x	65	S	25	335,00 tzn
M 16	x	70	S	25	340,00 tzn
M 16	x	80	S	25	460,00 tzn
M 16	x	85	S	25	510,00 tzn
M 16	x	90	S	25	570,00 tzn
M 16	x	100	S	25	630,00 tzn
M 16	x	110	S	25	800,00 tzn
M 16	x	120	S	25	860,00 tzn
M 16	x	130	S	25	950,00 tzn
M 16	x	140	S	25	960,00 tzn
M 16	x	150	S	25	1010,00 tzn
M 16	x	160	S	25	1080,00 tzn
M 16	x	170	S	25	1140,00 tzn
M 16	x	180	S	25	1190,00 tzn
M 16	x	200	S	25	1310,00 tzn
M 16	x	220	S	1	1380,00 tzn
M 16	x	240	S	1	1540,00 tzn
M 16	x	260	S	1	1640,00 tzn
M 16	x	280	S	1	1770,00 tzn
M 16	x	300	S	1	2180,00 tzn
M 20	x	30	S	25	350,00 tzn
M 20	x	35	S	25	365,00 tzn
M 20	x	40	S	25	360,00 tzn
M 20	x	45	S	25	370,00 tzn
M 20	x	50	S	25	385,00 tzn
M 20	x	55	S	25	410,00 tzn
M 20	x	60	S	25	420,00 tzn
M 20	x	65	S	25	470,00 tzn
M 20	x	70	S	25	480,00 tzn
M 20	x	75	S	25	540,00 tzn
M 20	x	80	S	25	570,00 tzn
M 20	x	90	S	25	750,00 tzn
M 20	x	100	S	25	980,00 tzn
M 20	x	110	S	25	1010,00 tzn
M 20	x	120	S	25	1180,00 tzn
M 20	x	130	S	1	1380,00 tzn
M 20	x	140	S	1	1780,00 tzn
M 20	x	150	S	1	1880,00 tzn
M 20	x	160	S	1	1940,00 tzn
M 20	x	180	S	1	2180,00 tzn
M 24	x	40	S	25	620,00 tzn
M 24	x	45	S	25	630,00 tzn
M 24	x	50	S	25	620,00 tzn
M 24	x	55	S	25	660,00 tzn
M 24	x	60	S	25	690,00 tzn
M 24	x	65	S	25	750,00 tzn
M 24	x	70	S	25	770,00 tzn
M 24	x	80	S	25	920,00 tzn
M 24	x	90	S	10	1230,00 tzn
M 24	x	100	S	10	1560,00 tzn
M 24	x	110	S	10	2900,00 tzn
M 24	x	120	S	10	3550,00 tzn
M 24	x	130	S	10	4200,00 tzn
M 24	x	140	S	10	4500,00 tzn
M 24	x	150	S	1	4950,00 tzn
M 24	x	180	S	1	6400,00 tzn
M 30	x	60	S	1	2800,00 tzn
M 30	x	70	S	1	3000,00 tzn
M 30	x	80	S	1	3250,00 tzn
M 30	x	90	S	1	3450,00 tzn

Abmessungen	VE Stück	€/100/Obf.			
M 30	x	100	S	1	3700,00 tzn
M 30	x	120	S	1	3850,00 tzn
M 30	x	130	S	1	3950,00 tzn
M 30	x	140	S	1	4050,00 tzn
M 30	x	150	S	1	4100,00 tzn
M 30	x	160	S	1	4400,00 tzn
M 30	x	170	S	1	4550,00 tzn
M 30	x	180	S	1	4600,00 tzn
M 30	x	190	S	1	4700,00 tzn
M 30	x	200	S	1	4750,00 tzn

Abmessungen	VE Stück	€/100/Obf.
ISO 04017.809		
4017	8.8	AD W7
	-50 bis +300 °C	



Sechskantschrauben mit Gewinde bis Kopf, verwendbar bei -50 bis zu +300 °C

mit Abnahmeprüfzeugnis 3.1, Preise gelten zzgl. APZ-Kosten

Werkstoffe nicht geeignet für den Einsatz nach AD-Merkblatt W10

Maße → **TI-15** Anziehungsmomente → **TI-244**
 Werkstoffeigensch. → **TI-232** Normumstellung → **TI-6**

ISO 4017 → ersetzt DIN 933

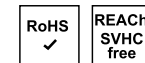

M 8	x	12	S	200	12,00
M 8	x	16	S	200	9,30
M 8	x	20	S	200	9,80
M 8	x	25	S	200	11,30
M 8	x	30	S	200	12,20
M 8	x	35	S	200	13,60
M 8	x	40	S	200	14,80
M 8	x	45	S	200	18,10
M 8	x	50	S	200	21,10
M 8	x	70	S	200	55,00
M 10	x	16	S	200	17,90
M 10	x	20	S	200	16,70
M 10	x	25	S	200	17,90
M 10	x	30	S	200	19,00
M 10	x	35	S	100	21,10
M 10	x	40	S	100	22,60
M 10	x	45	S	100	27,00
M 10	x	50	S	100	28,50
M 10	x	60	S	100	42,50
M 10	x	65	S	100	65,00
M 10	x	70	S	100	65,00
M 10	x	80	S	100	91,00
M 10	x	90	S	100	110,00
M 10	x	100	S	100	130,00
M 12	x	20	S	100	29,50
M 12	x	25	S	100	29,50
M 12	x	30	S	100	28,00
M 12	x	35	S	100	30,50
M 12	x	40	S	100	33,00
M 12	x	45	S	100	36,50
M 12	x	50	S	100	39,00
M 12	x	55	S	100	49,00
M 12	x	60	S	100	53,00
M 12	x	65	S	50	79,00
M 12	x	70	S	50	79,00
M 12	x	75	S	50	90,00
M 12	x	80	S	50	114,00

Abmessungen	VE	Stück	€/100/Obf.
M 12 x 90	S	50	136,00
M 12 x 100	S	50	152,00
M 16 x 25	S	50	62,00
M 16 x 30	S	50	59,00
M 16 x 35	S	50	62,00
M 16 x 40	S	50	65,00
M 16 x 45	S	50	68,00
M 16 x 50	S	50	74,00
M 16 x 55	S	50	89,00
M 16 x 60	S	50	94,00
M 16 x 65	S	25	134,00
M 16 x 70	S	25	134,00
M 16 x 75	S	25	158,00
M 16 x 80	S	25	199,00
M 16 x 90	S	25	260,00
M 16 x 100	S	25	295,00
M 20 x 30	S	25	138,00
M 20 x 35	S	25	138,00
M 20 x 40	S	25	129,00
M 20 x 45	S	25	131,00
M 20 x 50	S	25	133,00
M 20 x 55	S	25	139,00
M 20 x 60	S	25	141,00
M 20 x 65	S	25	164,00
M 20 x 70	S	25	169,00
M 20 x 75	S	25	217,00
M 20 x 80	S	25	210,00
M 20 x 90	S	25	315,00
M 20 x 100	S	25	445,00
M 20 x 120	S	25	550,00
M 24 x 40	S	25	238,00
M 24 x 45	S	25	238,00
M 24 x 50	S	25	222,00
M 24 x 55	S	25	235,00
M 24 x 60	S	25	242,00
M 24 x 65	S	25	280,00
M 24 x 70	S	25	280,00
M 24 x 80	S	25	355,00
M 24 x 90	S	10	540,00
M 24 x 100	S	10	730,00
M 24 x 120	S	10	880,00
M 27 x 65	S	10	1150,00
M 27 x 90	S	1	1250,00
M 27 x 100	S	1	1330,00

Abmessungen	VE	Stück	€/100/Obf.
ISO 04017.813			
4017			Mu 8.8
			galvanisch verzinkt
			SB

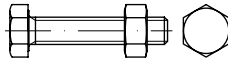

SB-Schrauben-Garnituren EN 15048, Mu = mit Sechskantmutter ISO 4032, SB = nach EN 15048

für nicht planmäßig vorgespannte Verbindungen im Stahlbau mit Abnahmeprüfzeugnis 3.1, Preise gelten zzgl. APZ-Kosten

Achtung! Nicht für den Einsatz in Stahlbauwerken in Deutschland zugelassen.

Maße → TI-15 Anziehungsmomente → TI-248
 Werkstoffeigensch. → TI-232 Normumstellung → TI-6
 Korrosionsschutz → TI-228

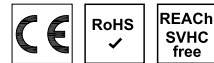

M 10 x 16	S	200	59,00 gal Zn
M 10 x 20	S	200	62,00 gal Zn
M 10 x 25	S	200	66,00 gal Zn
M 10 x 30	S	200	69,00 gal Zn
M 10 x 35	S	100	74,00 gal Zn
M 10 x 40	S	100	78,00 gal Zn
M 10 x 45	S	100	83,00 gal Zn
M 10 x 50	S	100	88,00 gal Zn
M 10 x 55	S	100	91,00 gal Zn
M 10 x 60	S	100	96,00 gal Zn
M 10 x 65	S	100	100,00 gal Zn
M 10 x 70	S	100	105,00 gal Zn
M 10 x 80	S	100	113,00 gal Zn
M 10 x 90	S	100	121,00 gal Zn
M 10 x 100	S	100	130,00 gal Zn
M 12 x 20	S	100	94,00 gal Zn
M 12 x 25	S	100	100,00 gal Zn
M 12 x 30	S	100	106,00 gal Zn
M 12 x 35	S	100	112,00 gal Zn
M 12 x 40	S	100	115,00 gal Zn
M 12 x 45	S	100	121,00 gal Zn
M 12 x 50	S	100	128,00 gal Zn
M 12 x 55	S	100	134,00 gal Zn
M 12 x 60	S	100	138,00 gal Zn
M 12 x 65	S	50	146,00 gal Zn
M 12 x 70	S	50	152,00 gal Zn
M 12 x 80	S	50	164,00 gal Zn
M 12 x 90	S	50	177,00 gal Zn
M 12 x 100	S	50	189,00 gal Zn
M 16 x 25	S	50	209,00 gal Zn
M 16 x 30	S	50	221,00 gal Zn
M 16 x 35	S	50	232,00 gal Zn
M 16 x 40	S	50	240,00 gal Zn
M 16 x 45	S	50	255,00 gal Zn
M 16 x 50	S	50	265,00 gal Zn
M 16 x 55	S	50	275,00 gal Zn
M 16 x 60	S	50	285,00 gal Zn
M 16 x 65	S	25	295,00 gal Zn
M 16 x 70	S	25	305,00 gal Zn
M 16 x 75	S	50	320,00 gal Zn
M 16 x 80	S	25	330,00 gal Zn
M 16 x 90	S	25	350,00 gal Zn
M 16 x 100	S	25	375,00 gal Zn
M 16 x 110	S	25	405,00 gal Zn
M 16 x 120	S	25	425,00 gal Zn
M 20 x 30	S	25	405,00 gal Zn
M 20 x 35	S	25	425,00 gal Zn

Abmessungen	VE	Stück	€/100/Obf.
M 20 x 40	S	25	435,00 gal Zn
M 20 x 45	S	25	450,00 gal Zn
M 20 x 50	S	25	470,00 gal Zn
M 20 x 55	S	25	485,00 gal Zn
M 20 x 60	S	25	510,00 gal Zn
M 20 x 65	S	25	520,00 gal Zn
M 20 x 70	S	25	540,00 gal Zn
M 20 x 75	S	25	560,00 gal Zn
M 20 x 80	S	25	580,00 gal Zn
M 20 x 90	S	25	610,00 gal Zn
M 20 x 100	S	25	650,00 gal Zn
M 20 x 110	S	25	690,00 gal Zn
M 20 x 120	S	25	720,00 gal Zn
M 24 x 40	S	25	720,00 gal Zn
M 24 x 45	S	25	750,00 gal Zn
M 24 x 50	S	25	780,00 gal Zn
M 24 x 55	S	25	800,00 gal Zn
M 24 x 60	S	25	830,00 gal Zn
M 24 x 65	S	25	850,00 gal Zn
M 24 x 70	S	25	880,00 gal Zn
M 24 x 80	S	25	930,00 gal Zn
M 24 x 90	S	10	980,00 gal Zn
M 24 x 100	S	10	1030,00 gal Zn
M 24 x 110	S	10	1090,00 gal Zn
M 24 x 120	S	10	1140,00 gal Zn

Abmessungen	VE	Stück	€/100/Obf.
ISO 04017.827			
4017			Mu 8.8
			feuerverzinkt
			SB



SB-Schrauben-Garnituren EN 15048, Mu = mit Sechskantmutter ISO 4032, SB = nach EN 15048

für nicht planmäßig vorgespannte Verbindungen im Stahlbau mit Abnahmeprüfzeugnis 3.1, Preise gelten zzgl. APZ-Kosten

Scheiben → ISO 7090 300HV tZn

Maße → TI-15 Anziehungsmomente → TI-248
 Werkstoffeigensch. → TI-232 Normumstellung → TI-6
 Korrosionsschutz → TI-231

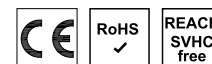

M 8 x 16	S	200	102,00 tZn
M 8 x 20	S	200	107,00 tZn
M 8 x 25	S	200	113,00 tZn
M 8 x 30	S	200	118,00 tZn
M 8 x 35	S	200	124,00 tZn
M 8 x 40	S	200	130,00 tZn
M 8 x 45	S	200	140,00 tZn
M 8 x 50	S	200	146,00 tZn
M 8 x 60	S	200	166,00 tZn
M 8 x 70	S	200	180,00 tZn
M 8 x 80	S	200	201,00 tZn
M 8 x 90	S	100	220,00 tZn
M 8 x 100	S	100	249,00 tZn
M 10 x 16	S	200	91,00 tZn
M 10 x 20	S	200	100,00 tZn
M 10 x 25	S	200	104,00 tZn
M 10 x 30	S	200	111,00 tZn
M 10 x 35	S	100	119,00 tZn
M 10 x 40	S	100	125,00 tZn
M 10 x 45	S	100	134,00 tZn
M 10 x 50	S	100	138,00 tZn
M 10 x 55	S	100	164,00 tZn

i

- ✓ Große Artikelvielfalt
- ✓ Verlässliche Qualität
- ✓ Hohe Lieferbereitschaft

Abmessungen	VE	Stück	€/100/Obf.
M 10 x 60	S	100	187,00 tZn
M 10 x 65	S	100	217,00 tZn
M 10 x 70	S	100	242,00 tZn
M 10 x 80	S	100	325,00 tZn
M 10 x 90	S	100	370,00 tZn
M 10 x 100	S	100	405,00 tZn
M 10 x 110	S	50	355,00 tZn
M 10 x 120	S	50	370,00 tZn
M 12 x 20	S	100	144,00 tZn
M 12 x 25	S	100	152,00 tZn
M 12 x 30	S	100	161,00 tZn
M 12 x 35	S	100	169,00 tZn
M 12 x 40	S	100	176,00 tZn
M 12 x 45	S	100	186,00 tZn
M 12 x 50	S	100	195,00 tZn
M 12 x 55	S	100	228,00 tZn
M 12 x 60	S	100	235,00 tZn
M 12 x 65	S	50	300,00 tZn
M 12 x 70	S	50	335,00 tZn
M 12 x 80	S	50	420,00 tZn
M 12 x 90	S	50	480,00 tZn
M 12 x 100	S	50	520,00 tZn
M 12 x 120	S	50	460,00 tZn
M 16 x 25	S	50	355,00 tZn
M 16 x 30	S	50	350,00 tZn
M 16 x 35	S	50	360,00 tZn
M 16 x 40	S	50	375,00 tZn
M 16 x 45	S	50	390,00 tZn
M 16 x 50	S	50	450,00 tZn
M 16 x 55	S	50	470,00 tZn
M 16 x 60	S	50	485,00 tZn
M 16 x 65	S	25	610,00 tZn
M 16 x 70	S	25	630,00 tZn
M 16 x 75	S	25	730,00 tZn
M 16 x 80	S	25	800,00 tZn
M 16 x 90	S	25	960,00 tZn
M 16 x 100	S	25	1090,00 tZn
M 16 x 110	S	25	1300,00 tZn
M 16 x 120	S	25	1410,00 tZn
M 16 x 130	S	25	790,00 tZn
M 16 x 140	S	25	830,00 tZn
M 16 x 150	S	25	860,00 tZn
M 16 x 160	S	25	890,00 tZn
M 16 x 170	S	25	1340,00 tZn
M 16 x 180	S	25	1370,00 tZn
M 16 x 200	S	25	1440,00 tZn
M 20 x 30	S	25	670,00 tZn
M 20 x 35	S	25	680,00 tZn
M 20 x 40	S	25	680,00 tZn
M 20 x 45	S	25	710,00 tZn
M 20 x 50	S	25	730,00 tZn
M 20 x 55	S	25	760,00 tZn
M 20 x 60	S	25	790,00 tZn
M 20 x 65	S	25	820,00 tZn
M 20 x 70	S	25	850,00 tZn
M 20 x 75	S	25	910,00 tZn
M 20 x 80	S	25	990,00 tZn
M 20 x 90	S	25	1250,00 tZn
M 20 x 100	S	25	1620,00 tZn
M 20 x 110	S	25	1760,00 tZn
M 20 x 120	S	25	1820,00 tZn
M 20 x 130	S	1	1230,00 tZn
M 20 x 140	S	1	1280,00 tZn
M 20 x 150	S	1	1320,00 tZn
M 20 x 160	S	1	1670,00 tZn
M 20 x 180	S	1	1780,00 tZn
M 20 x 200	S	1	1890,00 tZn
M 24 x 40	S	25	1140,00 tZn
M 24 x 45	S	25	1140,00 tZn
M 24 x 50	S	25	1230,00 tZn
M 24 x 55	S	25	1270,00 tZn
M 24 x 60	S	25	1340,00 tZn
M 24 x 65	S	25	1380,00 tZn
M 24 x 70	S	25	1410,00 tZn
M 24 x 80	S	25	1660,00 tZn

Abmessungen	VE	Stück	€/100/Obf.
M 24 x 90	S	10	2200,00 tZn
M 24 x 100	S	10	2700,00 tZn
M 24 x 110	S	10	4800,00 tZn
M 24 x 120	S	10	5800,00 tZn
M 24 x 130	S	10	1890,00 tZn
M 24 x 140	S	10	1980,00 tZn
M 24 x 150	S	1	2050,00 tZn
M 24 x 160	S	1	2600,00 tZn
M 24 x 180	S	1	2900,00 tZn
M 24 x 200	S	1	3100,00 tZn
M 27 x 40	S	1	1400,00 tZn
M 27 x 45	S	1	1430,00 tZn
M 27 x 50	S	1	1480,00 tZn
M 27 x 55	S	1	1490,00 tZn
M 27 x 60	S	1	1540,00 tZn
M 27 x 65	S	1	1590,00 tZn
M 27 x 70	S	1	1640,00 tZn
M 27 x 80	S	1	1740,00 tZn
M 27 x 90	S	1	1840,00 tZn
M 27 x 100	S	1	1940,00 tZn
M 27 x 110	S	1	3400,00 tZn
M 27 x 120	S	1	3600,00 tZn
M 27 x 130	S	1	4500,00 tZn
M 27 x 140	S	1	4750,00 tZn
M 27 x 150	S	1	4950,00 tZn
M 27 x 160	S	1	5100,00 tZn
M 27 x 180	S	1	5600,00 tZn
M 27 x 200	S	1	5900,00 tZn
M 30 x 60	S	1	3300,00 tZn
M 30 x 70	S	1	3300,00 tZn
M 30 x 80	S	1	3450,00 tZn
M 30 x 90	S	1	3650,00 tZn
M 30 x 100	S	1	3800,00 tZn
M 30 x 120	S	1	4100,00 tZn
M 30 x 130	S	1	4250,00 tZn
M 30 x 140	S	1	4450,00 tZn
M 30 x 150	S	1	4550,00 tZn
M 30 x 160	S	1	4750,00 tZn
M 30 x 170	S	1	4950,00 tZn
M 30 x 180	S	1	5100,00 tZn
M 30 x 190	S	1	5300,00 tZn
M 30 x 200	S	1	5400,00 tZn
M 36 x 60	S	1	3650,00 tZn
M 36 x 70	S	1	3700,00 tZn
M 36 x 80	S	1	3700,00 tZn
M 36 x 90	S	1	3900,00 tZn
M 36 x 100	S	1	4150,00 tZn
M 36 x 120	S	1	4450,00 tZn
M 36 x 130	S	1	4600,00 tZn
M 36 x 140	S	1	4800,00 tZn
M 36 x 150	S	1	5000,00 tZn
M 36 x 160	S	1	5200,00 tZn
M 36 x 170	S	1	5400,00 tZn
M 36 x 180	S	1	5600,00 tZn
M 36 x 190	S	1	5700,00 tZn
M 36 x 200	S	1	5900,00 tZn

Abmessungen	VE	Stück	€/100/Obf.
ISO		04017.100	
4017		10.9	



Sechskantschrauben mit Gewinde bis Kopf

*M 10/12/14/22 = RAZ 3250 übrige Ø = RAZ 405

Maße → **TI-15** Anziehmomente → **TI-244**
 Werkstoffeigensch. → **TI-232** Normumstellung → **TI-6**

Rostfrei → **S. 534**
 Messing → **S. 636**

ISO 4017 → ersetzt DIN 933

RoHS

REACh SVHC free

M 5 x 10	S	500	8,20
M 5 x 12	S	500	8,40
M 5 x 14	S	500	8,80
M 5 x 16	S	500	9,00
M 5 x 18	S	500	9,20
M 5 x 22	S	500	9,50
M 5 x 22	S	500	9,70
M 5 x 25	S	500	10,00
M 5 x 30	S	500	11,50
M 5 x 35	S	200	13,10
M 6 x 10	S	500	22,50
M 6 x 12	S	500	13,80
M 6 x 12	K	100	17,50
M 6 x 16	S	500	11,80
M 6 x 16	K	100	15,50
M 6 x 18	S	500	12,60
M 6 x 20	S	500	12,60
M 6 x 20	K	100	16,20
M 6 x 22	S	500	13,10
M 6 x 25	S	500	13,10
M 6 x 25	K	100	16,70
M 6 x 30	S	500	15,80
M 6 x 30	K	100	20,10
M 6 x 35	S	200	18,00
M 6 x 40	S	200	19,70
M 6 x 45	S	200	77,00
M 6 x 50	S	200	92,00
M 6 x 55	S	200	107,00
M 6 x 60	S	200	123,00
M 6 x 70	S	200	236,00
M 6 x 80	S	200	255,00
M 8 x 12	S	200	23,00
M 8 x 16	S	200	16,40
M 8 x 18	S	200	17,10
M 8 x 20	S	200	17,70
M 8 x 22	S	200	19,60
M 8 x 25	S	200	20,70
M 8 x 30	S	200	20,70
M 8 x 35	S	200	24,40
M 8 x 40	S	200	26,50
M 8 x 45	S	200	39,00
M 8 x 50	S	200	42,50
M 8 x 55	S	200	55,00
M 8 x 60	S	200	55,00
M 8 x 65	S	200	138,00
M 8 x 70	S	200	138,00
M 8 x 75	S	200	170,00
M 8 x 80	S	200	170,00
M 8 x 90	S	100	222,00
M 8 x 100	S	100	325,00

i

Wir versorgen Sie mit
 Verbindungselementen
 und Befestigungstechnik!

Abmessungen	VE	Stück	€/100/Obf.	Abmessungen	VE	Stück	€/100/Obf.	Abmessungen	VE	Stück	€/100/Obf.
M 8 x 120	S	100	500,00	M 16 x 30	S	50	110,00	M 22 x 55	S	25	1230,00
M 8 x 130	S	100	690,00	M 16 x 35	S	50	110,00	M 22 x 60	S	25	1050,00
M 8 x 140	S	100	750,00	M 16 x 40	S	50	120,00	M 22 x 65	S	25	1230,00
M 8 x 150	S	100	780,00	M 16 x 45	S	50	123,00	M 22 x 70	S	25	1290,00
M 8 x 180	S	100	940,00	M 16 x 50	S	50	136,00	M 22 x 75	S	25	1360,00
M 10 x 12	S	200	47,00	M 16 x 55	S	50	147,00	M 22 x 80	S	25	1400,00
M 10 x 16	S	200	33,50	M 16 x 60	S	50	147,00	M 22 x 90	S	25	1530,00
M 10 x 18	S	200	33,50	M 16 x 65	S	25	310,00	M 22 x 100	S	10	1580,00
M 10 x 20	S	200	29,50	M 16 x 70	S	25	310,00	M 22 x 110	S	10	1780,00
M 10 x 22	S	200	31,50	M 16 x 75	S	25	395,00	M 22 x 120	S	10	1910,00
M 10 x 25	S	200	31,50	M 16 x 80	S	25	325,00	M 22 x 130	S	10	2100,00
M 10 x 30	S	200	33,00	M 16 x 90	S	25	460,00	M 22 x 140	S	10	2240,00
M 10 x 35	S	100	35,50	M 16 x 100	S	25	590,00	M 22 x 150	S	10	2360,00
M 10 x 40	S	100	37,50	M 16 x 110	S	25	660,00	M 22 x 200	S	10	3250,00
M 10 x 45	S	100	44,50	M 16 x 120	S	25	720,00	M 24 x 30	S	25	630,00
M 10 x 50	S	100	50,00	M 16 x 130	S	25	810,00	M 24 x 35	S	25	630,00
M 10 x 55	S	100	83,00	M 16 x 140	S	25	870,00	M 24 x 40	S	25	475,00
M 10 x 60	S	100	83,00	M 16 x 150	S	25	910,00	M 24 x 45	S	25	475,00
M 10 x 65	S	100	176,00	M 16 x 160	S	25	960,00	M 24 x 50	S	25	780,00
M 10 x 70	S	100	194,00	M 16 x 170	S	25	1010,00	M 24 x 55	S	25	780,00
M 10 x 75	S	100	223,00	M 16 x 180	S	25	1060,00	M 24 x 60	S	25	780,00
M 10 x 80	S	100	223,00	M 16 x 190	S	25	1160,00	M 24 x 65	S	25	790,00
M 10 x 90	S	100	335,00	M 16 x 200	S	25	1250,00	M 24 x 70	S	25	810,00
M 10 x 100	S	100	415,00	M 16 x 220	S	1	1390,00	M 24 x 75	S	25	820,00
M 10 x 110	S	50	480,00	M 16 x 240	S	1	1730,00	M 24 x 80	S	25	830,00
M 10 x 120	S	50	660,00	M 16 x 260	S	1	1890,00	M 24 x 90	S	10	840,00
M 10 x 130	S	50	750,00	M 16 x 280	S	1	2050,00	M 24 x 100	S	10	880,00
M 10 x 140	S	50	810,00	M 16 x 300	S	1	2200,00	M 24 x 110	S	10	980,00
M 10 x 150	S	50	860,00	M 18 x 30	S	50	300,00	M 24 x 120	S	10	1050,00
M 10 x 200	S	50	1180,00	M 18 x 35	S	50	300,00	M 24 x 130	S	1	1400,00
M 12 x 16	S	100	190,00	M 18 x 40	S	50	270,00	M 24 x 140	S	1	1490,00
M 12 x 20	S	100	55,00	M 18 x 45	S	50	290,00	M 24 x 150	S	1	1580,00
M 12 x 25	S	100	51,00	M 18 x 50	S	50	295,00	M 24 x 160	S	1	1740,00
M 12 x 30	S	100	54,00	M 18 x 55	S	25	305,00	M 24 x 170	S	1	1870,00
M 12 x 35	S	100	56,00	M 18 x 60	S	25	320,00	M 24 x 180	S	1	1960,00
M 12 x 40	S	100	59,00	M 18 x 65	S	25	730,00	M 24 x 190	S	1	2040,00
M 12 x 45	S	100	67,00	M 18 x 70	S	25	840,00	M 24 x 200	S	1	2140,00
M 12 x 50	S	100	70,00	M 18 x 75	S	25	840,00	M 24 x 210	S	1	2390,00
M 12 x 55	S	100	97,00	M 18 x 80	S	25	1030,00	M 24 x 220	S	1	2390,00
M 12 x 60	S	100	104,00	M 18 x 90	S	25	1050,00	M 24 x 240	S	1	2800,00
M 12 x 65	S	50	170,00	M 18 x 100	S	25	1070,00	M 24 x 260	S	1	3200,00
M 12 x 70	S	50	215,00	M 18 x 120	S	25	1210,00	M 24 x 280	S	1	3700,00
M 12 x 75	S	50	295,00	M 18 x 130	S	25	1310,00	M 24 x 300	S	1	4000,00
M 12 x 80	S	50	295,00	M 18 x 160	S	25	1610,00	M 27 x 50	S	10	1050,00
M 12 x 90	S	50	390,00	M 18 x 200	S	25	1980,00	M 27 x 55	S	10	1050,00
M 12 x 100	S	50	460,00	M 20 x 30	S	25	440,00	M 27 x 60	S	10	1050,00
M 12 x 110	S	50	530,00	M 20 x 35	S	25	300,00	M 27 x 65	S	10	1060,00
M 12 x 120	S	50	590,00	M 20 x 40	S	25	270,00	M 27 x 70	S	10	1090,00
M 12 x 130	S	50	760,00	M 20 x 45	S	25	290,00	M 27 x 75	S	10	1110,00
M 12 x 140	S	50	830,00	M 20 x 50	S	25	295,00	M 27 x 80	S	10	1120,00
M 12 x 150	S	50	870,00	M 20 x 55	S	25	305,00	M 27 x 90	S	10	1140,00
M 12 x 160	S	25	910,00	M 20 x 60	S	25	320,00	M 27 x 100	S	10	1190,00
M 12 x 170	S	25	940,00	M 20 x 65	S	25	610,00	M 27 x 110	S	10	1320,00
M 12 x 180	S	25	1020,00	M 20 x 70	S	25	620,00	M 27 x 120	S	10	1390,00
M 12 x 200	S	25	1190,00	M 20 x 75	S	25	640,00	M 27 x 130	S	1	1460,00
M 14 x 25	S	100	101,00	M 20 x 80	S	25	640,00	M 27 x 140	S	1	1610,00
M 14 x 30	S	100	96,00	M 20 x 90	S	25	640,00	M 27 x 150	S	1	1690,00
M 14 x 35	S	100	99,00	M 20 x 100	S	25	680,00	M 27 x 160	S	1	1880,00
M 14 x 40	S	100	104,00	M 20 x 110	S	25	1050,00	M 27 x 180	S	1	2080,00
M 14 x 45	S	50	108,00	M 20 x 120	S	25	1060,00	M 27 x 200	S	1	2250,00
M 14 x 50	S	50	113,00	M 20 x 130	S	25	1220,00	M 30 x 40	S	1	1140,00
M 14 x 55	S	50	138,00	M 20 x 140	S	25	1300,00	M 30 x 50	S	1	1140,00
M 14 x 60	S	50	138,00	M 20 x 150	S	25	1390,00	M 30 x 55	S	1	1140,00
M 14 x 65	S	50	245,00	M 20 x 160	S	25	1490,00	M 30 x 60	S	1	1200,00
M 14 x 70	S	50	245,00	M 20 x 170	S	25	1580,00	M 30 x 65	S	1	1230,00
M 14 x 75	S	50	280,00	M 20 x 180	S	25	1680,00	M 30 x 70	S	1	1250,00
M 14 x 80	S	50	340,00	M 20 x 190	S	25	1750,00	M 30 x 75	S	1	1270,00
M 14 x 90	S	50	490,00	M 20 x 200	S	1	1830,00	M 30 x 80	S	1	1290,00
M 14 x 100	S	50	590,00	M 20 x 210	S	1	2130,00	M 30 x 90	S	1	1340,00
M 14 x 110	S	50	880,00	M 20 x 220	S	1	2130,00	M 30 x 100	S	1	1420,00
M 14 x 120	S	50	920,00	M 20 x 240	S	1	2390,00	M 30 x 110	S	1	1590,00
M 14 x 160	S	25	1340,00	M 20 x 260	S	1	2650,00	M 30 x 120	S	1	1690,00
M 14 x 200	S	25	1740,00	M 20 x 280	S	1	3000,00	M 30 x 130	S	1	1780,00
M 16 x 20	S	50	176,00	M 20 x 300	S	1	3250,00	M 30 x 140	S	1	1930,00

Abmessungen	VE	Stück	€/100/Obf.
M 30 x 160	S	1	2280,00
M 30 x 170	S	1	3350,00
M 30 x 180	S	1	3200,00
M 30 x 190	S	1	3650,00
M 30 x 200	S	1	3450,00
M 33 x 100	S	1	3900,00
M 33 x 160	S	1	4750,00
M 33 x 200	S	1	5700,00
M 36 x 40	S	1	2040,00
M 36 x 50	S	1	2040,00
M 36 x 55	S	1	2040,00
M 36 x 60	S	1	2040,00
M 36 x 65	S	1	2040,00
M 36 x 70	S	1	2080,00
M 36 x 75	S	1	2130,00
M 36 x 80	S	1	2170,00
M 36 x 90	S	1	2250,00
M 36 x 100	S	1	2350,00
M 36 x 110	S	1	2600,00
M 36 x 120	S	1	2750,00
M 36 x 130	S	1	2900,00
M 36 x 140	S	1	3150,00
M 36 x 150	S	1	3250,00
M 36 x 160	S	1	3650,00
M 36 x 170	S	1	4550,00
M 36 x 180	S	1	3950,00
M 36 x 190	S	1	4950,00
M 36 x 200	S	1	4250,00
M 42 x 100	S	1	5900,00
M 42 x 110	S	1	6600,00
M 42 x 130	S	1	7300,00
M 42 x 200	S	1	10800,00

ISO	04017.110
4017	10.9 galvanisch verzinkt

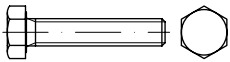

Sechskantschrauben mit Gewinde bis Kopf

*M 10/12/14/22= RAZ 3250 übrige Ø = RAZ 405, getempert

Achtung! Warneinblender zu Wasserstoffversprödung beachten.

Maße → **TI-15** Anziehungsmomente → **TI-244**
 Werkstoffeigensch. → **TI-232** Normumstellung → **TI-6**
 Korrosionsschutz → **TI-228**

Rostfrei → **S. 534**
 Messing → **S. 636**

ISO 4017 → ersetzt DIN 933

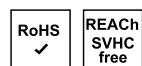

M 6 x 10	S	500	24,40 gal Zn
M 6 x 12	S	500	15,90 gal Zn
M 6 x 16	S	500	14,20 gal Zn
M 6 x 20	S	500	15,30 gal Zn
M 6 x 22	S	500	16,10 gal Zn
M 6 x 25	S	500	16,20 gal Zn
M 6 x 30	S	500	19,30 gal Zn
M 6 x 35	S	500	22,10 gal Zn
M 6 x 40	S	500	24,10 gal Zn
M 6 x 45	S	200	81,00 gal Zn
M 6 x 50	S	200	97,00 gal Zn
M 6 x 55	S	200	112,00 gal Zn

Abmessungen	VE	Stück	€/100/Obf.
M 8 x 12	S	200	28,00 gal Zn
M 8 x 16	S	200	21,40 gal Zn
M 8 x 18	S	200	22,70 gal Zn
M 8 x 20	S	200	23,30 gal Zn
M 8 x 22	S	200	26,50 gal Zn
M 8 x 25	S	200	27,00 gal Zn
M 8 x 30	S	200	28,00 gal Zn
M 8 x 35	S	200	32,50 gal Zn
M 8 x 40	S	200	35,00 gal Zn
M 8 x 45	S	200	49,50 gal Zn
M 8 x 50	S	200	53,00 gal Zn
M 8 x 55	S	200	66,00 gal Zn
M 8 x 60	S	200	68,00 gal Zn
M 8 x 70	S	200	152,00 gal Zn
M 8 x 75	S	200	184,00 gal Zn
M 8 x 80	S	200	182,00 gal Zn
M 8 x 100	S	100	340,00 gal Zn
M 10 x 12	S	200	56,00 gal Zn
M 10 x 16	S	200	43,00 gal Zn
M 10 x 18	S	200	43,00 gal Zn
M 10 x 20	S	200	39,50 gal Zn
M 10 x 25	S	200	42,50 gal Zn
M 10 x 30	S	200	45,50 gal Zn
M 10 x 35	S	100	48,00 gal Zn
M 10 x 40	S	100	52,00 gal Zn
M 10 x 45	S	200	61,00 gal Zn
M 10 x 50	S	100	67,00 gal Zn
M 10 x 55	S	100	98,00 gal Zn
M 10 x 60	S	100	102,00 gal Zn
M 10 x 70	S	100	216,00 gal Zn
M 10 x 75	S	100	247,00 gal Zn
M 10 x 80	S	100	247,00 gal Zn
M 10 x 90	S	100	360,00 gal Zn
M 10 x 100	S	100	445,00 gal Zn
M 10 x 110	S	50	510,00 gal Zn
M 12 x 20	S	100	69,00 gal Zn
M 12 x 25	S	100	66,00 gal Zn
M 12 x 30	S	100	70,00 gal Zn
M 12 x 35	S	100	75,00 gal Zn
M 12 x 40	S	100	80,00 gal Zn
M 12 x 45	S	100	88,00 gal Zn
M 12 x 50	S	100	88,00 gal Zn
M 12 x 55	S	100	120,00 gal Zn
M 12 x 60	S	100	132,00 gal Zn
M 12 x 65	S	50	200,00 gal Zn
M 12 x 70	S	50	246,00 gal Zn
M 12 x 75	S	50	270,00 gal Zn
M 12 x 80	S	50	310,00 gal Zn
M 12 x 90	S	50	425,00 gal Zn
M 12 x 100	S	50	510,00 gal Zn
M 12 x 110	S	100	570,00 gal Zn
M 12 x 120	S	100	630,00 gal Zn
M 12 x 130	S	50	770,00 gal Zn
M 12 x 140	S	50	880,00 gal Zn
M 12 x 150	S	50	930,00 gal Zn
M 12 x 160	S	25	970,00 gal Zn
M 12 x 180	S	25	1090,00 gal Zn
M 12 x 200	S	25	1270,00 gal Zn
M 14 x 30	S	100	125,00 gal Zn
M 14 x 35	S	100	129,00 gal Zn
M 14 x 40	S	100	136,00 gal Zn
M 14 x 45	S	50	141,00 gal Zn
M 14 x 50	S	50	151,00 gal Zn
M 14 x 60	S	50	181,00 gal Zn
M 14 x 65	S	50	295,00 gal Zn
M 14 x 70	S	50	295,00 gal Zn
M 14 x 80	S	50	395,00 gal Zn
M 14 x 90	S	50	550,00 gal Zn
M 16 x 20	S	50	208,00 gal Zn
M 16 x 25	S	50	142,00 gal Zn
M 16 x 30	S	50	146,00 gal Zn
M 16 x 35	S	50	151,00 gal Zn
M 16 x 40	S	50	161,00 gal Zn
M 16 x 45	S	50	166,00 gal Zn

Abmessungen	VE	Stück	€/100/Obf.
M 16 x 55	S	50	197,00 gal Zn
M 16 x 60	S	50	201,00 gal Zn
M 16 x 65	S	25	365,00 gal Zn
M 16 x 70	S	25	365,00 gal Zn
M 16 x 75	S	25	385,00 gal Zn
M 16 x 80	S	25	390,00 gal Zn
M 16 x 90	S	25	540,00 gal Zn
M 16 x 100	S	25	670,00 gal Zn
M 16 x 110	S	25	750,00 gal Zn
M 16 x 120	S	25	820,00 gal Zn
M 16 x 140	S	25	970,00 gal Zn
M 16 x 150	S	25	1020,00 gal Zn
M 16 x 160	S	25	1080,00 gal Zn
M 16 x 170	S	25	1130,00 gal Zn
M 16 x 180	S	25	1190,00 gal Zn
M 16 x 190	S	25	1290,00 gal Zn
M 16 x 200	S	25	1390,00 gal Zn
M 16 x 220	S	1	1550,00 gal Zn
M 16 x 240	S	1	1900,00 gal Zn
M 16 x 260	S	1	2070,00 gal Zn
M 16 x 280	S	1	2240,00 gal Zn
M 16 x 300	S	1	2410,00 gal Zn
M 18 x 40	S	50	330,00 gal Zn
M 18 x 45	S	50	350,00 gal Zn
M 18 x 50	S	50	355,00 gal Zn
M 18 x 55	S	25	370,00 gal Zn
M 18 x 60	S	25	390,00 gal Zn
M 18 x 70	S	25	900,00 gal Zn
M 20 x 30	S	25	510,00 gal Zn
M 20 x 35	S	25	285,00 gal Zn
M 20 x 40	S	25	345,00 gal Zn
M 20 x 45	S	25	365,00 gal Zn
M 20 x 50	S	25	375,00 gal Zn
M 20 x 55	S	25	385,00 gal Zn
M 20 x 60	S	25	410,00 gal Zn
M 20 x 65	S	25	710,00 gal Zn
M 20 x 70	S	25	720,00 gal Zn
M 20 x 75	S	25	750,00 gal Zn
M 20 x 80	S	25	750,00 gal Zn
M 20 x 90	S	25	760,00 gal Zn
M 20 x 100	S	25	810,00 gal Zn
M 20 x 110	S	25	1200,00 gal Zn
M 20 x 120	S	25	1210,00 gal Zn
M 20 x 130	S	25	1380,00 gal Zn
M 20 x 140	S	25	1470,00 gal Zn
M 20 x 150	S	25	1570,00 gal Zn
M 20 x 160	S	25	1680,00 gal Zn
M 20 x 170	S	25	1780,00 gal Zn
M 20 x 180	S	25	1890,00 gal Zn

Wichtiger Hinweis!



Bei galvanischen Überzügen auf hochfesten und federharten Teilen ($\geq 1000 \text{ N/mm}^2$ oder $\geq 320 \text{ HV}$) ist die Gefahr einer Wasserstoffversprödung (Spröbruchgefahr) nicht mit Sicherheit auszuschließen (ISO 4042).
 Durch eine rechtzeitig eingeleitete thermische Nachbehandlung (Tempern) kann die Gefahr eines wasserstoffinduzierten Spröbruchs im Regelfall verringert werden. Da aber ein Restrisiko nicht mit Sicherheit auszuschließen ist, erfolgen galvanische Überzüge auf derartigen Teilen nur auf ausdrücklichen Wunsch und auf Risiko des Auftraggebers.

M 20 x 190	S	25	1970,00 gal Zn
M 20 x 200	S	25	2060,00 gal Zn
M 20 x 210	S	1	2370,00 gal Zn
M 20 x 220	S	1	2380,00 gal Zn
M 20 x 240	S	1	2700,00 gal Zn
M 20 x 260	S	1	2950,00 gal Zn

Abmessungen	VE Stück	€/100/Obf.
ISO 04017.354		
4017	10.9	
	flZn/TL480h	

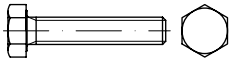

Sechskantschrauben mit Gewinde bis Kopf

TL = Schmierstoff im Topcoat mit $\mu = 0,09 - 0,14$,
Korrosionsbeständigkeit NSS: 480h RR,
Chrom(VI)-frei

Achtung! Gegenüber galv. verzinkt geänderte Anziehdrehmomente.

Maße → **TI-15** Anziehdrehmomente → **TI-245**
Werkstoffeigensch. → **TI-232** Normumstellung → **TI-6**
Korrosionsschutz → **TI-230**

Rostfrei → **S. 534**
Messing → **S. 636**

ISO 4017 → ersetzt DIN 933

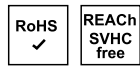

M 6	x	10	S	500	28,50 flZn
M 6	x	12	S	500	18,30 flZn
M 6	x	16	S	500	16,40 flZn
M 6	x	20	S	500	17,60 flZn
M 6	x	22	S	500	18,50 flZn
M 6	x	25	S	500	18,60 flZn
M 6	x	30	S	500	22,30 flZn
M 6	x	35	S	200	25,50 flZn
M 6	x	40	S	200	28,00 flZn
M 6	x	45	S	200	93,00 flZn
M 6	x	50	S	200	111,00 flZn
M 6	x	55	S	200	129,00 flZn
M 6	x	60	S	200	147,00 flZn
M 8	x	12	S	200	32,50 flZn
M 8	x	16	S	200	24,60 flZn
M 8	x	20	S	200	27,00 flZn
M 8	x	25	S	200	31,00 flZn
M 8	x	30	S	200	32,00 flZn
M 8	x	35	S	200	37,50 flZn
M 8	x	40	S	200	40,00 flZn
M 8	x	45	S	200	57,00 flZn
M 8	x	50	S	200	61,00 flZn
M 8	x	55	S	200	76,00 flZn
M 8	x	60	S	200	78,00 flZn
M 8	x	70	S	200	174,00 flZn
M 10	x	16	S	200	49,50 flZn
M 10	x	20	S	200	45,50 flZn
M 10	x	25	S	200	49,00 flZn
M 10	x	30	S	200	52,00 flZn
M 10	x	35	S	100	56,00 flZn
M 10	x	40	S	100	60,00 flZn
M 10	x	45	S	100	70,00 flZn
M 10	x	50	S	100	77,00 flZn
M 10	x	55	S	100	113,00 flZn
M 10	x	60	S	100	117,00 flZn
M 10	x	70	S	100	249,00 flZn
M 10	x	80	S	100	285,00 flZn
M 10	x	90	S	100	415,00 flZn
M 10	x	100	S	100	510,00 flZn
M 12	x	20	S	100	80,00 flZn
M 12	x	25	S	100	76,00 flZn
M 12	x	30	S	100	81,00 flZn
M 12	x	35	S	100	86,00 flZn
M 12	x	40	S	100	92,00 flZn
M 12	x	45	S	100	102,00 flZn
M 12	x	50	S	100	107,00 flZn

Abmessungen	VE Stück	€/100/Obf.			
M 12	x	55	S	100	138,00 flZn
M 12	x	60	S	100	153,00 flZn
M 12	x	65	S	50	230,00 flZn
M 12	x	70	S	50	285,00 flZn
M 12	x	80	S	50	380,00 flZn
M 12	x	90	S	50	490,00 flZn
M 12	x	100	S	50	580,00 flZn
M 16	x	25	S	50	164,00 flZn
M 16	x	30	S	50	167,00 flZn
M 16	x	35	S	50	174,00 flZn
M 16	x	40	S	50	186,00 flZn
M 16	x	45	S	50	192,00 flZn
M 16	x	50	S	50	210,00 flZn
M 16	x	55	S	50	227,00 flZn
M 16	x	60	S	50	232,00 flZn
M 16	x	65	S	25	420,00 flZn
M 16	x	70	S	25	420,00 flZn
M 16	x	75	S	25	435,00 flZn
M 16	x	80	S	25	450,00 flZn
M 16	x	90	S	25	620,00 flZn
M 16	x	100	S	25	770,00 flZn
M 16	x	110	S	25	860,00 flZn
M 16	x	120	S	25	940,00 flZn
M 20	x	30	S	25	580,00 flZn
M 20	x	35	S	25	330,00 flZn
M 20	x	40	S	25	395,00 flZn
M 20	x	45	S	25	420,00 flZn
M 20	x	50	S	25	430,00 flZn
M 20	x	55	S	25	445,00 flZn
M 20	x	60	S	25	470,00 flZn
M 20	x	65	S	25	810,00 flZn
M 20	x	70	S	25	830,00 flZn
M 20	x	75	S	25	860,00 flZn
M 20	x	80	S	25	860,00 flZn
M 20	x	90	S	25	870,00 flZn
M 20	x	100	S	25	930,00 flZn
M 20	x	110	S	25	1380,00 flZn
M 20	x	120	S	25	1390,00 flZn
M 24	x	40	S	25	680,00 flZn
M 24	x	45	S	25	690,00 flZn
M 24	x	50	S	25	1030,00 flZn
M 24	x	55	S	25	1050,00 flZn
M 24	x	60	S	25	1050,00 flZn
M 24	x	65	S	25	1080,00 flZn
M 24	x	70	S	25	1110,00 flZn
M 24	x	75	S	25	1130,00 flZn
M 24	x	80	S	25	1140,00 flZn
M 24	x	90	S	10	1160,00 flZn
M 24	x	100	S	10	1230,00 flZn
M 24	x	110	S	10	1370,00 flZn
M 24	x	120	S	10	1470,00 flZn
M 24	x	160	S	1	2250,00 flZn

Abmessungen	VE Stück	€/100/Obf.
ISO 04017.133		
4017	10.9	
	flZn/TL480h	



Sechskantschrauben mit Gewinde bis Kopf

flZnL = int. Schmierstoff mit $\mu = 0,12 - 0,18$,
Korrosionsbeständigkeit NSS: 480h RR,
Chrom(VI)-frei

Maße → **TI-15** Anziehdrehmomente → **TI-245**
Werkstoffeigensch. → **TI-232** Normumstellung → **TI-6**
Korrosionsschutz → **TI-230**

Rostfrei → **S. 534**
Messing → **S. 636**

ISO 4017 → ersetzt DIN 933

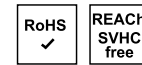

M 6	x	10	S	500	28,50 flZn
M 6	x	12	S	500	18,30 flZn
M 6	x	16	S	500	16,40 flZn
M 6	x	20	S	500	17,60 flZn
M 6	x	22	S	500	18,50 flZn
M 6	x	25	S	500	18,60 flZn
M 6	x	30	S	500	22,30 flZn
M 6	x	35	S	200	25,50 flZn
M 6	x	40	S	200	28,00 flZn
M 6	x	45	S	200	93,00 flZn
M 6	x	50	S	200	111,00 flZn
M 6	x	55	S	200	129,00 flZn
M 6	x	60	S	200	147,00 flZn
M 8	x	12	S	200	32,50 flZn
M 8	x	16	S	200	24,60 flZn
M 8	x	20	S	200	27,00 flZn
M 8	x	25	S	200	31,00 flZn
M 8	x	30	S	200	32,00 flZn
M 8	x	35	S	200	37,50 flZn
M 8	x	40	S	200	40,00 flZn
M 8	x	45	S	200	57,00 flZn
M 8	x	50	S	200	61,00 flZn
M 8	x	55	S	200	76,00 flZn
M 8	x	60	S	200	78,00 flZn
M 8	x	70	S	200	174,00 flZn
M 10	x	16	S	200	49,50 flZn
M 10	x	20	S	200	45,50 flZn
M 10	x	25	S	200	49,00 flZn
M 10	x	30	S	200	52,00 flZn
M 10	x	35	S	100	56,00 flZn
M 10	x	40	S	100	60,00 flZn
M 10	x	45	S	100	70,00 flZn
M 10	x	50	S	100	77,00 flZn
M 10	x	55	S	100	113,00 flZn
M 10	x	60	S	100	117,00 flZn
M 10	x	70	S	100	249,00 flZn
M 10	x	80	S	100	285,00 flZn
M 10	x	90	S	100	415,00 flZn
M 10	x	100	S	100	510,00 flZn
M 12	x	20	S	100	80,00 flZn
M 12	x	25	S	100	76,00 flZn
M 12	x	30	S	100	81,00 flZn
M 12	x	35	S	100	86,00 flZn
M 12	x	40	S	100	92,00 flZn
M 12	x	45	S	100	102,00 flZn
M 12	x	50	S	100	107,00 flZn

Abmessungen	VE	Stück	€/100/Obf.
M 12 x 55	S	100	138,00 flZn
M 12 x 60	S	100	153,00 flZn
M 12 x 65	S	50	230,00 flZn
M 12 x 70	S	50	285,00 flZn
M 12 x 80	S	50	380,00 flZn
M 12 x 90	S	50	490,00 flZn
M 12 x 100	S	50	580,00 flZn
M 12 x 110	S	50	670,00 flZn
M 12 x 130	S	50	790,00 flZn
M 14 x 45	S	50	164,00 flZn
M 16 x 25	S	50	164,00 flZn
M 16 x 30	S	50	167,00 flZn
M 16 x 35	S	50	174,00 flZn
M 16 x 40	S	50	186,00 flZn
M 16 x 45	S	50	192,00 flZn
M 16 x 50	S	50	210,00 flZn
M 16 x 55	S	50	227,00 flZn
M 16 x 60	S	50	232,00 flZn
M 16 x 65	S	25	420,00 flZn
M 16 x 70	S	25	420,00 flZn
M 16 x 75	S	25	435,00 flZn
M 16 x 80	S	25	450,00 flZn
M 16 x 90	S	25	620,00 flZn
M 16 x 100	S	25	770,00 flZn
M 16 x 110	S	25	860,00 flZn
M 16 x 120	S	25	940,00 flZn
M 18 x 80	S	25	620,00 flZn
M 20 x 30	S	25	580,00 flZn
M 20 x 35	S	25	330,00 flZn
M 20 x 40	S	25	395,00 flZn
M 20 x 45	S	25	420,00 flZn
M 20 x 50	S	25	430,00 flZn
M 20 x 55	S	25	445,00 flZn
M 20 x 60	S	25	470,00 flZn
M 20 x 65	S	25	810,00 flZn
M 20 x 70	S	25	830,00 flZn
M 20 x 75	S	25	860,00 flZn
M 20 x 80	S	25	860,00 flZn
M 20 x 90	S	25	870,00 flZn
M 20 x 100	S	25	930,00 flZn
M 20 x 110	S	25	1380,00 flZn
M 20 x 120	S	25	1390,00 flZn
M 24 x 40	S	25	680,00 flZn
M 24 x 45	S	25	690,00 flZn
M 24 x 50	S	25	1030,00 flZn
M 24 x 55	S	25	1050,00 flZn
M 24 x 60	S	25	1050,00 flZn
M 24 x 65	S	25	1080,00 flZn
M 24 x 70	S	25	1110,00 flZn
M 24 x 75	S	25	1130,00 flZn
M 24 x 80	S	25	1140,00 flZn
M 24 x 90	S	10	1160,00 flZn
M 24 x 100	S	10	1230,00 flZn
M 24 x 110	S	10	1370,00 flZn
M 24 x 120	S	10	1470,00 flZn
M 30 x 110	S	1	1920,00 flZn

Abmessungen	VE	Stück	€/100/Obf.
ISO		04017.200	

4017 12.9

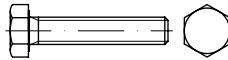

Sechskantschrauben mit Gewinde bis Kopf

*M 10/12/14/22 = RAZ 3260 übrige Ø = RAZ 406

Maße → **TI-15** Anziehmomente → **TI-244**
 Werkstoffeigensch. → **TI-232** Normumstellung → **TI-6**
 Rostfrei → **S. 534**
 Messing → **S. 636**

ISO 4017 → ersetzt DIN 933

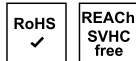

M 6 x 12	S	500	103,00
M 6 x 16	S	500	106,00
M 6 x 20	S	500	108,00
M 6 x 25	S	500	128,00
M 6 x 30	S	500	136,00
M 8 x 16	S	200	114,00
M 8 x 20	S	200	114,00
M 8 x 25	S	200	135,00
M 8 x 30	S	200	143,00
M 8 x 35	S	200	151,00
M 8 x 40	S	200	172,00
M 8 x 45	S	200	189,00
M 8 x 50	S	200	224,00
M 8 x 60	S	200	246,00
M 10 x 20	S	200	120,00
M 10 x 25	S	200	142,00
M 10 x 30	S	200	152,00
M 10 x 35	S	100	158,00
M 10 x 40	S	100	181,00
M 10 x 45	S	100	199,00
M 10 x 50	S	100	236,00
M 10 x 60	S	100	260,00
M 12 x 25	S	100	158,00
M 12 x 30	S	100	199,00
M 12 x 35	S	100	236,00
M 12 x 40	S	100	260,00
M 12 x 45	S	100	280,00
M 12 x 50	S	100	365,00
M 12 x 60	S	100	395,00
M 14 x 35	S	100	280,00
M 14 x 40	S	100	440,00
M 14 x 50	S	50	630,00
M 16 x 30	S	50	315,00
M 16 x 35	S	50	340,00
M 16 x 40	S	50	360,00
M 16 x 45	S	50	385,00
M 16 x 50	S	50	395,00
M 16 x 60	S	50	495,00
M 16 x 70	S	25	520,00
M 16 x 80	S	25	560,00
M 16 x 90	S	25	610,00
M 16 x 100	S	25	670,00
M 20 x 40	S	25	395,00
M 20 x 45	S	25	480,00
M 20 x 50	S	25	560,00
M 20 x 55	S	25	630,00
M 20 x 60	S	25	680,00
M 20 x 70	S	25	730,00
M 20 x 80	S	25	770,00
M 20 x 90	S	25	790,00

Abmessungen	VE	Stück	€/100/Obf.
M 20 x 100	S	25	880,00
M 24 x 60	S	25	1200,00
M 24 x 70	S	25	1260,00
M 24 x 80	S	25	1430,00
M 24 x 90	S	10	1470,00
M 24 x 100	S	10	1900,00

Abmessungen	VE	Stück	€/100/Obf.
ISO		04017.270	

4017 12.9 flZnL480h



Sechskantschrauben mit Gewinde bis Kopf

flZnL = int. Schmierstoff mit $\mu = 0,12 - 0,18$,
 Korrosionsbeständigkeit NSS: 480h RR,
 Chrom(VI)-frei

Maße → **TI-15** Anziehmomente → **TI-245**
 Werkstoffeigensch. → **TI-232** Normumstellung → **TI-6**
 Korrosionsschutz → **TI-230**

Rostfrei → **S. 534**
 Messing → **S. 636**

ISO 4017 → ersetzt DIN 933

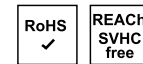

M 6 x 12	S	500	151,00 flZn
M 6 x 16	S	500	154,00 flZn
M 6 x 20	S	500	158,00 flZn
M 6 x 25	S	500	186,00 flZn
M 6 x 30	S	500	198,00 flZn
M 8 x 16	S	200	166,00 flZn
M 8 x 20	S	200	166,00 flZn
M 8 x 25	S	200	195,00 flZn
M 8 x 30	S	200	209,00 flZn
M 8 x 35	S	200	218,00 flZn
M 8 x 40	S	200	250,00 flZn
M 10 x 20	S	200	175,00 flZn
M 10 x 25	S	200	206,00 flZn
M 10 x 30	S	200	221,00 flZn
M 10 x 35	S	100	229,00 flZn
M 10 x 40	S	100	265,00 flZn
M 10 x 50	S	100	345,00 flZn
M 10 x 60	S	100	385,00 flZn
M 12 x 25	S	100	229,00 flZn
M 12 x 30	S	100	290,00 flZn
M 12 x 35	S	100	345,00 flZn
M 12 x 40	S	100	385,00 flZn
M 12 x 50	S	100	530,00 flZn
M 12 x 60	S	100	580,00 flZn
M 16 x 30	S	50	460,00 flZn
M 16 x 35	S	50	500,00 flZn
M 16 x 40	S	50	530,00 flZn
M 16 x 45	S	50	560,00 flZn
M 16 x 50	S	50	580,00 flZn
M 16 x 60	S	50	720,00 flZn
M 20 x 40	S	25	580,00 flZn
M 20 x 45	S	25	710,00 flZn
M 20 x 50	S	25	1320,00 flZn
M 20 x 60	S	25	1400,00 flZn

Abmessungen VE Stück €/100/Obf.
ISO 04026.200

4026 45 H



Gewindestifte mit Kegelkuppe und Innensechskant

Achtung! Nicht für Zugbelastung.

Maße → TI-20 Normumstellung → TI-6
Werkstoffeigensch. → TI-232 REACH → TI-262

Rostfrei → S. 541

ISO 4026 → ersetzt DIN 913



Abmessungen	VE	Stück	€/100/Obf.
M 1,6 x 2	S	500	305,00
M 1,6 x 2,5	S	500	128,00
M 1,6 x 3	S	500	113,00
M 1,6 x 4	S	500	112,00
M 1,6 x 5	S	500	118,00
M 1,6 x 6	S	500	118,00
M 1,6 x 8	S	500	119,00
M 1,6 x 10	S	500	119,00
M 2 x 2	S	500	112,00
M 2 x 3	S	500	101,00
M 2 x 4	S	500	103,00
M 2 x 5	S	500	105,00
M 2 x 6	S	500	108,00
M 2 x 8	S	500	114,00
M 2 x 10	S	500	123,00
M 2,5 x 3	S	500	83,00
M 2,5 x 4	S	500	86,00
M 2,5 x 5	S	500	89,00
M 2,5 x 6	S	500	94,00
M 2,5 x 8	S	500	97,00
M 2,5 x 10	S	500	101,00
M 3 x 3	S	1000	9,40
M 3 x 4	S	1000	8,80
M 3 x 5	S	1000	8,90
M 3 x 6	S	1000	9,10
M 3 x 6	K	200	9,10
M 3 x 8	S	1000	9,50
M 3 x 8	K	200	9,50
M 3 x 10	S	1000	9,90
M 3 x 12	S	1000	10,50
M 3 x 16	S	500	11,70
M 3 x 20	S	500	12,40
M 4 x 3	S	1000	7,70
M 4 x 4	S	1000	8,20
M 4 x 5	S	1000	7,80
M 4 x 6	S	1000	7,90
M 4 x 6	K	200	7,90
M 4 x 8	S	1000	8,20
M 4 x 8	K	200	8,20
M 4 x 10	S	1000	8,40
M 4 x 10	K	200	8,40
M 4 x 12	S	1000	8,90
M 4 x 16	S	1000	10,10
M 4 x 16	K	200	10,10
M 4 x 20	S	500	10,30
M 4 x 25	S	500	17,00
M 4 x 30	S	200	45,00
M 4 x 35	S	200	62,00
M 4 x 40	S	200	73,00
M 5 x 4	S	1000	11,90
M 5 x 5	S	1000	8,90

Abmessungen	VE	Stück	€/100/Obf.
M 5 x 6	S	1000	8,60
M 5 x 8	S	1000	8,90
M 5 x 8	K	200	8,90
M 5 x 10	S	1000	9,20
M 5 x 10	K	200	9,20
M 5 x 12	S	1000	9,90
M 5 x 16	S	1000	10,70
M 5 x 18	S	500	11,80
M 5 x 20	S	500	11,80
M 5 x 25	S	500	17,20
M 5 x 30	S	200	19,00
M 5 x 35	S	200	26,00
M 5 x 40	S	200	29,50
M 6 x 4	S	1000	19,40
M 6 x 5	S	1000	13,20
M 6 x 6	S	1000	10,10
M 6 x 6	K	200	10,10
M 6 x 8	S	1000	9,40
M 6 x 8	K	200	9,40
M 6 x 10	S	1000	9,60
M 6 x 10	K	200	9,60
M 6 x 12	S	1000	10,10
M 6 x 12	K	200	10,10
M 6 x 16	S	500	11,30
M 6 x 16	K	200	11,30
M 6 x 18	S	500	12,90
M 6 x 20	S	500	12,90
M 6 x 20	K	200	12,90
M 6 x 25	S	200	17,60
M 6 x 30	S	200	19,30
M 6 x 35	S	200	23,50
M 6 x 40	S	200	28,00
M 6 x 45	S	200	33,00
M 6 x 50	S	200	36,50
M 6 x 55	S	100	91,00
M 6 x 60	S	100	41,00
M 6 x 70	S	100	184,00
M 8 x 6	S	500	15,30
M 8 x 8	S	500	11,70
M 8 x 8	K	200	11,70
M 8 x 10	S	500	10,90
M 8 x 12	S	500	11,80
M 8 x 16	S	200	13,00
M 8 x 18	S	200	15,50
M 8 x 20	S	200	15,50
M 8 x 25	S	200	20,30
M 8 x 30	S	200	24,60
M 8 x 35	S	200	27,00
M 8 x 40	S	200	34,50
M 8 x 45	S	100	41,50
M 8 x 50	S	100	47,50
M 8 x 55	S	100	68,00
M 8 x 60	S	100	68,00
M 8 x 70	S	100	78,00
M 8 x 80	S	100	92,00
M 10 x 8	S	200	22,80
M 10 x 10	S	200	17,20
M 10 x 12	S	200	15,90
M 10 x 16	S	200	18,20
M 10 x 18	S	200	21,50
M 10 x 20	S	200	21,50
M 10 x 25	S	100	25,50
M 10 x 30	S	100	29,50
M 10 x 35	S	100	34,00
M 10 x 40	S	100	42,00
M 10 x 45	S	100	54,00
M 10 x 50	S	100	60,00
M 10 x 55	S	100	92,00
M 10 x 60	S	100	92,00
M 10 x 70	S	100	112,00
M 10 x 80	S	100	134,00
M 10 x 90	S	100	136,00
M 10 x 100	S	100	155,00
M 12 x 10	S	200	42,50
M 12 x 12	S	200	32,50

Abmessungen	VE	Stück	€/100/Obf.
M 12 x 16	S	200	29,50
M 12 x 18	S	100	34,00
M 12 x 20	S	100	34,00
M 12 x 25	S	100	38,00
M 12 x 30	S	100	42,00
M 12 x 35	S	100	45,50
M 12 x 40	S	100	50,00
M 12 x 45	S	100	57,00
M 12 x 50	S	100	68,00
M 12 x 55	S	100	82,00
M 12 x 60	S	50	82,00
M 12 x 70	S	50	114,00
M 12 x 80	S	50	136,00
M 12 x 90	S	50	355,00
M 12 x 100	S	50	610,00
M 14 x 16	S	100	310,00
M 14 x 20	S	100	91,00
M 14 x 30	S	100	105,00
M 14 x 40	S	50	118,00
M 14 x 50	S	50	151,00
M 16 x 12	S	100	255,00
M 16 x 16	S	100	63,00
M 16 x 18	S	100	68,00
M 16 x 20	S	100	68,00
M 16 x 25	S	100	74,00
M 16 x 30	S	100	79,00
M 16 x 35	S	100	85,00
M 16 x 40	S	50	89,00
M 16 x 45	S	50	101,00
M 16 x 50	S	50	113,00
M 16 x 55	S	50	129,00
M 16 x 60	S	50	159,00
M 16 x 70	S	50	181,00
M 16 x 80	S	50	204,00
M 16 x 90	S	25	227,00
M 16 x 100	S	25	580,00
M 20 x 20	S	100	124,00
M 20 x 25	S	100	132,00
M 20 x 30	S	50	141,00
M 20 x 35	S	50	148,00
M 20 x 40	S	50	157,00
M 20 x 45	S	50	165,00
M 20 x 50	S	50	177,00
M 20 x 60	S	25	230,00
M 20 x 70	S	25	290,00
M 20 x 80	S	25	315,00
M 20 x 90	S	25	370,00
M 24 x 20	S	50	680,00
M 24 x 25	S	50	610,00
M 24 x 30	S	50	255,00
M 24 x 35	S	50	265,00
M 24 x 40	S	25	280,00
M 24 x 45	S	25	550,00
M 24 x 50	S	25	325,00
M 24 x 60	S	25	480,00
M 24 x 70	S	25	530,00
M 24 x 80	S	25	570,00
M 24 x 90	S	25	620,00
M 24 x 100	S	25	890,00

Abmessungen	VE Stück	€/100/Obf.
ISO	04026.210	
4026	45 H	galvanisch verzinkt



Gewindestifte mit Kegelhülse und Innensechskant

Achtung! Nicht für Zugbelastung.

Maße → **TI-20** Normumstellung → **TI-6**
 Werkstoffeigensch. → **TI-232** REACH → **TI-262**
 Korrosionsschutz → **TI-228**

Rostfrei → **S. 541**

ISO 4026 → ersetzt DIN 913



M 2	x	4	S	500	182,00 gal Zn
M 2	x	6	S	500	195,00 gal Zn
M 2	x	8	S	500	201,00 gal Zn
M 2	x	10	S	500	225,00 gal Zn
M 3	x	3	S	1000	14,60 gal Zn
M 3	x	4	S	1000	13,20 gal Zn
M 3	x	5	S	1000	13,40 gal Zn
M 3	x	6	S	1000	13,60 gal Zn
M 3	x	8	S	1000	14,20 gal Zn
M 3	x	10	S	1000	14,70 gal Zn
M 3	x	12	S	1000	15,70 gal Zn
M 3	x	16	S	500	18,10 gal Zn
M 3	x	20	S	500	18,70 gal Zn
M 4	x	4	S	1000	10,50 gal Zn
M 4	x	5	S	1000	10,10 gal Zn
M 4	x	6	S	1000	10,30 gal Zn
M 4	x	8	S	1000	12,10 gal Zn
M 4	x	10	S	1000	12,60 gal Zn
M 4	x	12	S	1000	13,40 gal Zn
M 4	x	14	S	1000	30,00 gal Zn
M 4	x	16	S	1000	15,00 gal Zn
M 4	x	18	S	1000	15,50 gal Zn
M 4	x	20	S	500	15,50 gal Zn
M 4	x	25	S	500	25,50 gal Zn
M 4	x	30	S	500	68,00 gal Zn
M 4	x	35	S	500	92,00 gal Zn
M 4	x	40	S	500	108,00 gal Zn
M 5	x	4	S	1000	17,80 gal Zn
M 5	x	5	S	1000	17,90 gal Zn
M 5	x	6	S	1000	11,30 gal Zn
M 5	x	8	S	1000	11,80 gal Zn
M 5	x	10	S	1000	12,40 gal Zn
M 5	x	12	S	1000	14,10 gal Zn
M 5	x	16	S	1000	15,20 gal Zn
M 5	x	18	S	500	17,10 gal Zn
M 5	x	20	S	500	17,10 gal Zn
M 5	x	25	S	500	26,00 gal Zn
M 5	x	30	S	200	31,00 gal Zn
M 5	x	35	S	200	39,00 gal Zn
M 5	x	40	S	200	44,50 gal Zn
M 6	x	5	S	1000	23,50 gal Zn
M 6	x	6	S	1000	13,40 gal Zn
M 6	x	8	S	1000	12,60 gal Zn
M 6	x	10	S	1000	13,10 gal Zn
M 6	x	12	S	1000	14,10 gal Zn
M 6	x	14	S	1000	17,50 gal Zn
M 6	x	16	S	500	16,70 gal Zn
M 6	x	18	S	500	35,50 gal Zn
M 6	x	20	S	500	19,50 gal Zn
M 6	x	25	S	200	26,50 gal Zn

Abmessungen	VE Stück	€/100/Obf.			
M 6	x	30	S	200	29,50 gal Zn
M 6	x	35	S	200	37,00 gal Zn
M 6	x	40	S	200	42,50 gal Zn
M 6	x	45	S	200	53,00 gal Zn
M 6	x	50	S	200	67,00 gal Zn
M 6	x	60	S	100	72,00 gal Zn
M 8	x	6	S	500	30,50 gal Zn
M 8	x	8	S	500	16,00 gal Zn
M 8	x	10	S	500	15,40 gal Zn
M 8	x	12	S	500	16,70 gal Zn
M 8	x	16	S	200	19,30 gal Zn
M 8	x	18	S	200	27,50 gal Zn
M 8	x	20	S	200	23,20 gal Zn
M 8	x	25	S	200	33,00 gal Zn
M 8	x	30	S	200	39,50 gal Zn
M 8	x	35	S	200	35,50 gal Zn
M 8	x	40	S	200	52,00 gal Zn
M 8	x	45	S	100	62,00 gal Zn
M 8	x	50	S	100	72,00 gal Zn
M 8	x	55	S	100	108,00 gal Zn
M 8	x	60	S	100	118,00 gal Zn
M 8	x	70	S	100	132,00 gal Zn
M 8	x	80	S	100	194,00 gal Zn
M 8	x	90	S	100	345,00 gal Zn
M 8	x	100	S	100	385,00 gal Zn
M 8	x	130	S	50	480,00 gal Zn
M 10	x	8	S	200	34,50 gal Zn
M 10	x	10	S	200	24,20 gal Zn
M 10	x	12	S	200	23,20 gal Zn
M 10	x	16	S	200	27,50 gal Zn
M 10	x	20	S	200	35,50 gal Zn
M 10	x	25	S	100	42,50 gal Zn
M 10	x	30	S	100	51,00 gal Zn
M 10	x	35	S	100	57,00 gal Zn
M 10	x	40	S	100	71,00 gal Zn
M 10	x	45	S	100	86,00 gal Zn
M 10	x	50	S	100	96,00 gal Zn
M 10	x	60	S	100	164,00 gal Zn
M 10	x	70	S	100	195,00 gal Zn
M 10	x	80	S	100	233,00 gal Zn
M 10	x	90	S	100	590,00 gal Zn
M 10	x	100	S	100	670,00 gal Zn
M 12	x	10	S	200	77,00 gal Zn
M 12	x	12	S	200	48,00 gal Zn
M 12	x	14	S	200	44,00 gal Zn
M 12	x	16	S	200	44,00 gal Zn
M 12	x	20	S	200	54,00 gal Zn
M 12	x	25	S	100	62,00 gal Zn
M 12	x	30	S	100	72,00 gal Zn
M 12	x	35	S	100	78,00 gal Zn
M 12	x	40	S	100	91,00 gal Zn
M 12	x	45	S	100	105,00 gal Zn
M 12	x	50	S	100	120,00 gal Zn
M 12	x	55	S	100	143,00 gal Zn
M 12	x	60	S	50	146,00 gal Zn
M 12	x	70	S	50	201,00 gal Zn
M 12	x	80	S	50	242,00 gal Zn
M 12	x	90	S	50	340,00 gal Zn
M 12	x	100	S	50	1060,00 gal Zn
M 14	x	20	S	100	140,00 gal Zn
M 14	x	50	S	50	199,00 gal Zn
M 14	x	60	S	50	275,00 gal Zn
M 16	x	16	S	100	111,00 gal Zn
M 16	x	20	S	100	120,00 gal Zn
M 16	x	25	S	100	132,00 gal Zn
M 16	x	30	S	100	138,00 gal Zn
M 16	x	35	S	100	149,00 gal Zn
M 16	x	40	S	50	160,00 gal Zn
M 16	x	45	S	50	182,00 gal Zn
M 16	x	50	S	50	206,00 gal Zn
M 16	x	55	S	50	249,00 gal Zn
M 16	x	60	S	50	249,00 gal Zn
M 16	x	70	S	50	335,00 gal Zn
M 16	x	80	S	50	365,00 gal Zn
M 16	x	90	S	25	410,00 gal Zn

Abmessungen	VE Stück	€/100/Obf.			
M 20	x	20	S	100	216,00 gal Zn
M 20	x	25	S	100	232,00 gal Zn
M 20	x	30	S	50	250,00 gal Zn
M 20	x	35	S	50	260,00 gal Zn
M 20	x	40	S	50	280,00 gal Zn
M 20	x	50	S	50	315,00 gal Zn
M 20	x	60	S	25	340,00 gal Zn
M 20	x	70	S	25	640,00 gal Zn
M 20	x	80	S	25	710,00 gal Zn
M 20	x	90	S	25	790,00 gal Zn
M 24	x	25	S	50	800,00 gal Zn
M 24	x	30	S	50	450,00 gal Zn
M 24	x	35	S	50	460,00 gal Zn
M 24	x	40	S	25	495,00 gal Zn
M 24	x	60	S	25	840,00 gal Zn
M 24	x	70	S	25	950,00 gal Zn
M 24	x	80	S	25	1050,00 gal Zn

~ISO	04026.205	
4026	45 H	Fein

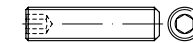

Gewindestifte mit Kegelhülse und Innensechskant, mit metrischem Feingewinde

Achtung! Nicht für Zugbelastung.

Maße → **TI-20** Normumstellung → **TI-6**
 Werkstoffeigensch. → **TI-232** REACH → **TI-262**

ISO 4026 → ersetzt DIN 913



M 4	x	0,5	x	4	S	1000	236,00
M 4	x	0,5	x	5	S	1000	265,00
M 4	x	0,5	x	6	S	1000	280,00
M 5	x	0,5	x	6	S	1000	158,00
M 5	x	0,5	x	8	S	1000	170,00
M 5	x	0,5	x	10	S	1000	255,00
M 5	x	0,5	x	12	S	1000	187,00
M 5	x	0,5	x	16	S	1000	212,00
M 5	x	0,5	x	20	S	500	590,00
M 5	x	0,5	x	25	S	500	620,00
M 5	x	0,5	x	30	S	200	650,00
M 6	x	0,75	x	5	S	1000	128,00
M 6	x	0,5	x	6	S	1000	210,00
M 6	x	0,75	x	6	S	1000	188,00
M 6	x	0,5	x	8	S	1000	230,00
M 6	x	0,75	x	8	S	1000	265,00
M 6	x	0,5	x	10	S	1000	178,00
M 6	x	0,75	x	10	S	1000	295,00
M 6	x	0,5	x	12	S	1000	315,00
M 6	x	0,75	x	12	S	1000	295,00
M 6	x	0,5	x	16	S	500	238,00
M 6	x	0,5	x	20	S	500	217,00
M 6	x	0,75	x	20	S	500	325,00
M 8	x	1	x	5	S	500	102,00
M 8	x	1	x	6	S	500	55,00
M 8	x	0,75	x	8	S	500	204,00
M 8	x	1	x	8	S	500	140,00
M 8	x	0,5	x	10	S	500	345,00
M 8	x	0,75	x	10	S	500	290,00
M 8	x	1	x	10	S	500	200,00
M 8	x	0,5	x	12	S	500	209,00
M 8	x	0,75	x	12	S	500	111,00
M 8	x	1	x	12	S	500	230,00

Abmessungen	VE	Stück	€/100/Obf.	Abmessungen	VE	Stück	€/100/Obf.	Abmessungen	VE	Stück	€/100/Obf.
M 8 x 0,5 x 16 S 200			580,00	M 14 x 1,5 x 25 S 100			305,00	M 3 x 6 S 1000			9,10
M 8 x 0,75 x 16 S 200			158,00	M 14 x 1,5 x 30 S 100			320,00	M 3 x 8 S 1000			9,50
M 8 x 1 x 16 S 200			236,00	M 14 x 1,5 x 35 S 50			335,00	M 3 x 10 S 1000			9,90
M 8 x 0,75 x 20 S 200			199,00	M 14 x 1,5 x 40 S 50			345,00	M 3 x 12 S 1000			10,50
M 8 x 1 x 20 S 200			265,00	M 14 x 1,5 x 45 S 50			360,00	M 3 x 16 S 500			11,70
M 8 x 0,75 x 25 S 200			216,00	M 14 x 1,5 x 50 S 50			415,00	M 3 x 20 S 500			12,40
M 8 x 1 x 25 S 200			121,00	M 14 x 1,5 x 60 S 50			460,00	M 4 x 4 S 1000			8,90
M 8 x 0,75 x 30 S 200			242,00	M 16 x 1 x 12 S 100			530,00	M 4 x 5 S 1000			7,80
M 8 x 1 x 30 S 200			128,00	M 16 x 1,5 x 12 S 100			260,00	M 4 x 6 S 1000			7,90
M 8 x 1 x 35 S 200			131,00	M 16 x 1 x 16 S 100			425,00	M 4 x 8 S 1000			8,20
M 8 x 1 x 40 S 200			140,00	M 16 x 1,5 x 16 S 100			320,00	M 4 x 10 S 1000			8,40
M 8 x 1 x 50 S 100			182,00	M 16 x 1 x 20 S 100			510,00	M 4 x 12 S 1000			8,90
M 8 x 1 x 60 S 100			242,00	M 16 x 1,5 x 20 S 100			325,00	M 4 x 16 S 1000			10,10
M 8 x 1 x 70 S 100			280,00	M 16 x 1,5 x 25 S 100			340,00	M 4 x 18 S 1000			10,30
M 8 x 1 x 80 S 100			325,00	M 16 x 1,5 x 30 S 100			345,00	M 4 x 20 S 500			10,30
M 8 x 1 x 90 S 100			380,00	M 16 x 1,5 x 40 S 50			380,00	M 4 x 25 S 500			17,00
M 8 x 1 x 100 S 100			420,00	M 16 x 1,5 x 50 S 50			395,00	M 4 x 30 S 200			45,00
M 10 x 1 x 8 S 200			250,00	M 16 x 1,5 x 60 S 50			415,00	M 4 x 35 S 200			62,00
M 10 x 1,25 x 8 S 200			325,00	M 16 x 1,5 x 70 S 50			460,00	M 4 x 40 S 200			73,00
M 10 x 1 x 10 S 200			250,00	M 20 x 1,5 x 20 S 100			590,00	M 5 x 4 S 1000			11,90
M 10 x 1,25 x 10 S 200			138,00	M 20 x 1,5 x 25 S 100			630,00	M 5 x 5 S 1000			9,90
M 10 x 1 x 12 S 200			233,00	M 20 x 1,5 x 30 S 50			670,00	M 5 x 6 S 1000			8,60
M 10 x 1,25 x 12 S 200			157,00	M 20 x 1,5 x 35 S 50			710,00	M 5 x 8 S 1000			8,90
M 10 x 1 x 16 S 200			335,00	M 20 x 1,5 x 40 S 50			740,00	M 5 x 10 S 1000			9,20
M 10 x 1,25 x 16 S 200			192,00	M 20 x 1,5 x 45 S 50			790,00	M 5 x 12 S 1000			9,90
M 10 x 1 x 20 S 200			345,00	M 20 x 1,5 x 50 S 50			850,00	M 5 x 16 S 1000			10,70
M 10 x 1,25 x 20 S 200			205,00	M 20 x 1,5 x 60 S 25			920,00	M 5 x 18 S 500			11,80
M 10 x 1 x 25 S 100			119,00	M 20 x 1,5 x 70 S 25			1020,00	M 5 x 20 S 500			11,80
M 10 x 1,25 x 25 S 100			228,00	M 20 x 1,5 x 80 S 25			1120,00	M 5 x 25 S 500			17,20
M 10 x 1 x 30 S 100			136,00	M 20 x 1,5 x 100 S 25			1230,00	M 5 x 30 S 200			19,00
M 10 x 1,25 x 30 S 100			234,00	M 24 x 1,5 x 25 S 50			1120,00	M 5 x 35 S 200			26,00
M 10 x 1 x 35 S 100			146,00	M 24 x 1,5 x 30 S 50			1170,00	M 5 x 40 S 200			29,50
M 10 x 1,25 x 35 S 100			247,00	M 24 x 1,5 x 40 S 25			1350,00	M 6 x 5 S 1000			13,20
M 10 x 1 x 40 S 100			221,00	M 24 x 1,5 x 60 S 25			1470,00	M 6 x 6 S 1000			11,10
M 10 x 1,25 x 40 S 100			265,00					M 6 x 8 S 1000			9,40
M 10 x 1 x 45 S 100			221,00					M 6 x 10 S 1000			9,60
M 10 x 1 x 50 S 100			232,00					M 6 x 12 S 500			10,10
M 10 x 1,25 x 50 S 100			340,00					M 6 x 16 S 500			11,30
M 10 x 1 x 60 S 100			255,00					M 6 x 18 S 500			12,90
M 10 x 1,25 x 60 S 100			345,00					M 6 x 20 S 500			12,90
M 12 x 1 x 8 S 100			182,00					M 6 x 25 S 200			17,60
M 12 x 1 x 10 S 200			560,00					M 6 x 30 S 200			19,30
M 12 x 1,25 x 10 S 200			186,00					M 6 x 35 S 200			23,50
M 12 x 1,5 x 10 S 200			600,00					M 6 x 40 S 200			28,00
M 12 x 1,25 x 12 S 200			171,00					M 6 x 45 S 200			33,00
M 12 x 1,5 x 12 S 200			131,00					M 6 x 50 S 200			36,50
M 12 x 1 x 16 S 200			620,00					M 8 x 6 S 500			15,30
M 12 x 1,25 x 16 S 200			188,00					M 8 x 8 S 500			12,90
M 12 x 1,5 x 16 S 200			137,00					M 8 x 10 S 500			10,90
M 12 x 1 x 20 S 100			640,00					M 8 x 12 S 500			11,80
M 12 x 1,25 x 20 S 100			199,00					M 8 x 16 S 500			13,00
M 12 x 1,5 x 20 S 100			147,00					M 8 x 18 S 200			15,50
M 12 x 1 x 25 S 100			790,00					M 8 x 20 S 200			15,50
M 12 x 1,25 x 25 S 100			212,00					M 8 x 25 S 200			20,30
M 12 x 1,5 x 25 S 100			155,00					M 8 x 30 S 200			24,60
M 12 x 1 x 30 S 100			157,00					M 8 x 35 S 200			27,00
M 12 x 1,25 x 30 S 100			224,00					M 8 x 40 S 200			34,50
M 12 x 1,5 x 30 S 100			165,00					M 8 x 45 S 100			41,50
M 12 x 1 x 40 S 100			201,00					M 8 x 50 S 100			47,50
M 12 x 1,25 x 40 S 100			236,00					M 8 x 55 S 100			68,00
M 12 x 1,5 x 40 S 100			201,00					M 8 x 60 S 100			68,00
M 12 x 1 x 45 S 100			245,00					M 8 x 70 S 100			78,00
M 12 x 1,5 x 45 S 100			245,00					M 8 x 80 S 100			92,00
M 12 x 1 x 50 S 100			249,00					M 10 x 8 S 200			22,80
M 12 x 1,5 x 55 S 100			300,00					M 10 x 10 S 200			18,90
M 12 x 1 x 60 S 50			385,00					M 10 x 12 S 200			15,90
M 12 x 1,5 x 70 S 50			520,00					M 10 x 16 S 200			18,20
M 14 x 1 x 10 S 200			415,00					M 10 x 18 S 200			21,50
M 14 x 1,5 x 10 S 200			485,00					M 10 x 20 S 200			21,50
M 14 x 1 x 12 S 200			425,00					M 10 x 25 S 100			25,50
M 14 x 1,5 x 12 S 200			355,00					M 10 x 30 S 100			29,50
M 14 x 1 x 16 S 100			490,00					M 10 x 35 S 100			34,00
M 14 x 1,5 x 16 S 100			325,00					M 10 x 40 S 100			42,00
M 14 x 1 x 20 S 100			720,00					M 10 x 45 S 100			54,00
M 14 x 1,5 x 20 S 100			295,00					M 10 x 50 S 100			60,00

ISO 04027.200

4027 45 H

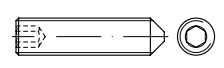

Gewindestifte mit Spitze und Innensechskant

Achtung! Nicht für Zugbelastung.
 Maße → TI-20 Normumstellung → TI-6
 Werkstoffeigensch. → TI-232 REACH → TI-262

Rostfrei → S. 542
 ISO 4027 → ersetzt DIN 914



M 2 x 2 S 500	129,00
M 2 x 3 S 500	117,00
M 2 x 4 S 500	119,00
M 2 x 5 S 500	121,00
M 2 x 6 S 500	126,00
M 2 x 8 S 500	134,00
M 2 x 10 S 500	143,00
M 2,5 x 3 S 500	97,00
M 2,5 x 4 S 500	100,00
M 2,5 x 5 S 500	102,00
M 2,5 x 6 S 500	109,00
M 2,5 x 8 S 500	114,00
M 2,5 x 10 S 500	117,00
M 3 x 3 S 1000	10,30
M 3 x 4 S 1000	8,80
M 3 x 5 S 1000	8,90

Abmessungen	VE	Stück	€/100/Obf.
M 10 x 60	S	100	92,00
M 10 x 70	S	100	112,00
M 10 x 80	S	100	134,00
M 10 x 100	S	100	229,00
M 12 x 10	S	200	42,50
M 12 x 12	S	200	35,50
M 12 x 16	S	200	29,50
M 12 x 20	S	100	34,00
M 12 x 25	S	100	38,00
M 12 x 30	S	100	42,00
M 12 x 35	S	100	45,50
M 12 x 40	S	100	50,00
M 12 x 45	S	100	57,00
M 12 x 50	S	100	68,00
M 12 x 55	S	100	82,00
M 12 x 60	S	50	82,00
M 12 x 70	S	50	114,00
M 12 x 80	S	50	136,00
M 14 x 20	S	100	91,00
M 14 x 30	S	100	105,00
M 14 x 40	S	50	118,00
M 16 x 16	S	100	69,00
M 16 x 20	S	100	68,00
M 16 x 25	S	100	74,00
M 16 x 30	S	100	79,00
M 16 x 35	S	100	85,00
M 16 x 40	S	50	89,00
M 16 x 45	S	50	121,00
M 16 x 50	S	50	133,00
M 16 x 55	S	50	149,00
M 16 x 60	S	50	149,00
M 16 x 70	S	50	181,00
M 16 x 80	S	50	204,00
M 16 x 90	S	25	227,00
M 20 x 20	S	100	136,00
M 20 x 25	S	100	132,00
M 20 x 30	S	50	141,00
M 20 x 35	S	50	148,00
M 20 x 40	S	50	157,00
M 20 x 45	S	50	195,00
M 20 x 50	S	50	207,00
M 20 x 60	S	25	223,00
M 20 x 70	S	25	300,00
M 20 x 80	S	25	345,00
M 20 x 90	S	25	385,00
M 24 x 30	S	50	255,00
M 24 x 35	S	50	265,00
M 24 x 40	S	25	280,00
M 24 x 50	S	25	325,00
M 24 x 60	S	25	480,00
M 24 x 80	S	25	570,00
M 24 x 100	S	25	890,00

Abmessungen	VE	Stück	€/100/Obf.
ISO 4027			04027.210
4027			45 H
			galvanisch verzinkt

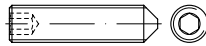

Gewindestifte mit Spitze und Innensechskant

Achtung! Nicht für Zugbelastung.

Maße → TI-20 Normumstellung → TI-6
 Werkstoffeigensch. → TI-232 REACH → TI-262
 Korrosionsschutz → TI-228

Rostfrei → S. 542

ISO 4027 → ersetzt DIN 914



M 3 x 3	S	1000	18,20 gal Zn
M 3 x 4	S	1000	11,30 gal Zn
M 3 x 5	S	1000	11,40 gal Zn
M 3 x 6	S	1000	11,70 gal Zn
M 3 x 8	S	1000	12,30 gal Zn
M 3 x 10	S	1000	13,20 gal Zn
M 4 x 4	S	1000	11,40 gal Zn
M 4 x 5	S	1000	10,30 gal Zn
M 4 x 6	S	1000	10,30 gal Zn
M 4 x 8	S	1000	10,60 gal Zn
M 4 x 10	S	1000	11,20 gal Zn
M 4 x 12	S	1000	12,30 gal Zn
M 4 x 16	S	1000	13,80 gal Zn
M 4 x 18	S	1000	18,20 gal Zn
M 4 x 20	S	500	15,50 gal Zn
M 4 x 25	S	500	30,00 gal Zn
M 4 x 30	S	500	79,00 gal Zn
M 4 x 35	S	500	108,00 gal Zn
M 5 x 4	S	1000	20,80 gal Zn
M 5 x 5	S	1000	17,60 gal Zn
M 5 x 6	S	1000	11,30 gal Zn
M 5 x 8	S	1000	11,80 gal Zn
M 5 x 10	S	1000	12,30 gal Zn
M 5 x 12	S	1000	13,40 gal Zn
M 5 x 16	S	1000	14,60 gal Zn
M 5 x 20	S	500	16,30 gal Zn
M 5 x 25	S	500	55,00 gal Zn
M 5 x 30	S	200	61,00 gal Zn
M 6 x 5	S	1000	16,30 gal Zn
M 6 x 6	S	1000	14,10 gal Zn
M 6 x 8	S	1000	12,50 gal Zn
M 6 x 10	S	1000	13,10 gal Zn
M 6 x 12	S	1000	13,80 gal Zn
M 6 x 16	S	500	16,00 gal Zn
M 6 x 18	S	500	22,50 gal Zn
M 6 x 20	S	500	18,30 gal Zn
M 6 x 25	S	200	26,50 gal Zn
M 6 x 30	S	200	29,50 gal Zn
M 6 x 40	S	200	49,00 gal Zn
M 6 x 45	S	200	58,00 gal Zn
M 8 x 8	S	500	20,00 gal Zn
M 8 x 10	S	500	15,30 gal Zn
M 8 x 12	S	500	17,60 gal Zn
M 8 x 16	S	200	19,20 gal Zn
M 8 x 20	S	200	23,00 gal Zn
M 8 x 25	S	200	33,00 gal Zn
M 8 x 30	S	200	39,50 gal Zn
M 8 x 35	S	200	44,00 gal Zn
M 8 x 40	S	200	61,00 gal Zn
M 8 x 45	S	100	72,00 gal Zn

Abmessungen	VE	Stück	€/100/Obf.
M 8 x 50	S	100	83,00 gal Zn
M 8 x 60	S	100	119,00 gal Zn
M 10 x 10	S	200	27,50 gal Zn
M 10 x 12	S	200	24,50 gal Zn
M 10 x 16	S	200	27,50 gal Zn
M 10 x 20	S	200	38,50 gal Zn
M 10 x 25	S	100	42,50 gal Zn
M 10 x 30	S	100	51,00 gal Zn
M 10 x 35	S	100	63,00 gal Zn
M 10 x 40	S	100	77,00 gal Zn
M 10 x 45	S	100	97,00 gal Zn
M 10 x 50	S	100	105,00 gal Zn
M 12 x 10	S	200	60,00 gal Zn
M 12 x 12	S	200	52,00 gal Zn
M 12 x 16	S	200	46,00 gal Zn
M 12 x 20	S	100	54,00 gal Zn
M 12 x 25	S	100	62,00 gal Zn
M 12 x 30	S	100	72,00 gal Zn
M 12 x 35	S	100	92,00 gal Zn
M 12 x 40	S	100	77,00 gal Zn
M 12 x 50	S	100	120,00 gal Zn
M 12 x 60	S	50	134,00 gal Zn
M 16 x 16	S	100	121,00 gal Zn
M 16 x 20	S	100	120,00 gal Zn
M 16 x 25	S	100	132,00 gal Zn
M 16 x 30	S	100	138,00 gal Zn
M 16 x 35	S	100	144,00 gal Zn
M 16 x 40	S	50	158,00 gal Zn
M 16 x 45	S	50	182,00 gal Zn
M 16 x 50	S	50	200,00 gal Zn
M 16 x 60	S	50	230,00 gal Zn
M 16 x 70	S	50	325,00 gal Zn
M 16 x 80	S	50	360,00 gal Zn
M 16 x 90	S	25	400,00 gal Zn
M 20 x 20	S	100	238,00 gal Zn
M 20 x 30	S	50	265,00 gal Zn
M 20 x 35	S	50	164,00 gal Zn
M 20 x 40	S	50	280,00 gal Zn
M 20 x 50	S	50	315,00 gal Zn
M 20 x 60	S	25	345,00 gal Zn

Abmessungen	VE	Stück	€/100/Obf.
ISO 4028			04028.200
4028			45 H

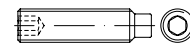

Gewindestifte mit Zapfen und Innensechskant

Achtung! Nicht für Zugbelastung.

Maße → TI-20 Normumstellung → TI-6
 Werkstoffeigensch. → TI-236 REACH → TI-262

Rostfrei → S. 543

ISO 4028 → ersetzt DIN 915



M 3 x 3	S	1000	10,30
M 3 x 4	S	1000	8,80
M 3 x 5	S	1000	8,90
M 3 x 6	S	1000	9,10
M 3 x 8	S	1000	9,50
M 3 x 10	S	1000	9,90
M 3 x 12	S	1000	10,50
M 3 x 16	S	500	11,70
M 3 x 20	S	500	12,40
M 4 x 4	S	1000	8,90

Abmessungen	VE	Stück	€/100/Obf.
M 4 x 5	S	1000	7,80
M 4 x 6	S	1000	7,90
M 4 x 8	S	1000	8,20
M 4 x 10	S	1000	8,40
M 4 x 12	S	1000	8,90
M 4 x 16	S	1000	10,10
M 4 x 20	S	500	10,30
M 4 x 25	S	500	17,00
M 4 x 30	S	200	45,00
M 4 x 35	S	200	62,00
M 4 x 40	S	200	73,00
M 5 x 4	S	1000	11,90
M 5 x 5	S	1000	9,90
M 5 x 6	S	1000	8,60
M 5 x 8	S	1000	8,90
M 5 x 10	S	1000	9,20
M 5 x 12	S	1000	9,90
M 5 x 16	S	1000	10,70
M 5 x 18	S	500	11,80
M 5 x 20	S	500	11,80
M 5 x 25	S	500	17,20
M 5 x 30	S	200	19,00
M 5 x 35	S	200	26,00
M 5 x 40	S	200	29,50
M 6 x 5	S	1000	13,20
M 6 x 6	S	1000	11,10
M 6 x 8	S	1000	9,40
M 6 x 10	S	1000	9,60
M 6 x 12	S	1000	10,10
M 6 x 16	S	500	11,30
M 6 x 18	S	500	12,90
M 6 x 20	S	500	12,90
M 6 x 25	S	500	17,60
M 6 x 30	S	200	19,30
M 6 x 35	S	200	23,50
M 6 x 40	S	200	28,00
M 6 x 45	S	200	33,00
M 6 x 50	S	200	36,50
M 8 x 6	S	500	15,30
M 8 x 8	S	500	12,90
M 8 x 10	S	500	10,90
M 8 x 12	S	500	11,80
M 8 x 16	S	200	13,00
M 8 x 18	S	200	15,50
M 8 x 20	S	200	15,50
M 8 x 25	S	200	20,30
M 8 x 30	S	200	24,60
M 8 x 35	S	200	27,00
M 8 x 40	S	200	34,50
M 8 x 45	S	100	41,50
M 8 x 50	S	100	47,50
M 8 x 55	S	100	68,00
M 8 x 60	S	100	68,00
M 8 x 70	S	100	78,00
M 8 x 80	S	100	92,00
M 10 x 8	S	200	22,80
M 10 x 10	S	200	18,90
M 10 x 12	S	200	15,90
M 10 x 16	S	200	18,20
M 10 x 18	S	200	21,50
M 10 x 20	S	200	21,50
M 10 x 25	S	100	25,50
M 10 x 30	S	100	29,50
M 10 x 35	S	100	34,00
M 10 x 40	S	100	42,00
M 10 x 45	S	100	54,00
M 10 x 50	S	100	60,00
M 10 x 55	S	100	99,00
M 10 x 60	S	100	92,00
M 10 x 70	S	100	112,00
M 10 x 80	S	100	134,00
M 12 x 10	S	200	42,50
M 12 x 12	S	200	35,50
M 12 x 16	S	200	29,50
M 12 x 18	S	100	34,00

Abmessungen	VE	Stück	€/100/Obf.
M 12 x 20	S	100	34,00
M 12 x 25	S	100	38,00
M 12 x 30	S	100	42,00
M 12 x 35	S	100	45,50
M 12 x 40	S	100	50,00
M 12 x 45	S	100	57,00
M 12 x 50	S	100	68,00
M 12 x 55	S	100	82,00
M 12 x 60	S	50	82,00
M 12 x 70	S	50	114,00
M 12 x 80	S	50	136,00
M 14 x 20	S	100	91,00
M 14 x 30	S	100	105,00
M 14 x 40	S	50	118,00
M 16 x 16	S	100	69,00
M 16 x 20	S	100	68,00
M 16 x 25	S	100	74,00
M 16 x 30	S	100	79,00
M 16 x 35	S	100	85,00
M 16 x 40	S	50	89,00
M 16 x 45	S	50	101,00
M 16 x 50	S	50	113,00
M 16 x 55	S	50	129,00
M 16 x 60	S	50	149,00
M 16 x 70	S	50	181,00
M 16 x 80	S	50	204,00
M 16 x 90	S	25	227,00
M 16 x 100	S	25	265,00
M 20 x 20	S	100	136,00
M 20 x 25	S	100	132,00
M 20 x 30	S	50	141,00
M 20 x 35	S	50	148,00
M 20 x 40	S	50	157,00
M 20 x 45	S	50	230,00
M 20 x 50	S	50	177,00
M 20 x 60	S	25	255,00
M 20 x 70	S	25	270,00
M 20 x 80	S	25	340,00
M 20 x 90	S	25	395,00
M 24 x 30	S	50	255,00
M 24 x 35	S	50	265,00
M 24 x 40	S	25	280,00
M 24 x 45	S	25	315,00
M 24 x 50	S	25	325,00
M 24 x 60	S	25	480,00
M 24 x 70	S	25	530,00
M 24 x 80	S	25	570,00
M 24 x 90	S	25	620,00
M 24 x 100	S	25	890,00

Abmessungen	VE	Stück	€/100/Obf.
ISO		04028.210	
4028		45 H	galvanisch verzinkt

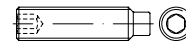

Gewindestifte mit Zapfen und Innensechskant

Achtung! Nicht für Zugbelastung.

Maße → **TI-20** Normumstellung → **TI-6**
 Werkstoffeigensch. → **TI-232** REACH → **TI-262**
 Korrosionsschutz → **TI-228**

Rostfrei → **S. 543**

ISO 4028 → ersetzt DIN 915



M 3 x 6	S	1000	12,00 gal Zn
M 3 x 8	S	1000	12,40 gal Zn
M 3 x 10	S	1000	12,80 gal Zn
M 3 x 12	S	1000	13,40 gal Zn
M 3 x 16	S	1000	14,60 gal Zn
M 3 x 20	S	500	15,00 gal Zn
M 4 x 4	S	1000	19,70 gal Zn
M 4 x 5	S	1000	18,20 gal Zn
M 4 x 6	S	1000	16,70 gal Zn
M 4 x 8	S	1000	11,10 gal Zn
M 4 x 10	S	1000	11,50 gal Zn
M 4 x 12	S	1000	18,20 gal Zn
M 4 x 16	S	1000	21,80 gal Zn
M 4 x 20	S	500	27,00 gal Zn
M 4 x 25	S	500	30,50 gal Zn
M 4 x 30	S	500	79,00 gal Zn
M 5 x 5	S	1000	13,20 gal Zn
M 5 x 6	S	1000	17,60 gal Zn
M 5 x 8	S	1000	18,00 gal Zn
M 5 x 10	S	1000	12,60 gal Zn
M 5 x 12	S	1000	13,80 gal Zn
M 5 x 16	S	1000	15,20 gal Zn
M 5 x 20	S	500	29,50 gal Zn
M 5 x 25	S	500	20,60 gal Zn
M 5 x 30	S	200	22,60 gal Zn
M 6 x 6	S	1000	22,10 gal Zn
M 6 x 8	S	1000	18,70 gal Zn
M 6 x 10	S	1000	13,50 gal Zn
M 6 x 12	S	1000	14,40 gal Zn
M 6 x 16	S	500	16,60 gal Zn
M 6 x 20	S	500	32,50 gal Zn
M 6 x 25	S	200	37,50 gal Zn
M 6 x 30	S	200	41,00 gal Zn
M 6 x 35	S	200	47,50 gal Zn
M 6 x 40	S	200	33,50 gal Zn
M 6 x 45	S	200	38,00 gal Zn
M 6 x 50	S	200	42,00 gal Zn
M 8 x 8	S	500	18,70 gal Zn
M 8 x 10	S	500	16,70 gal Zn
M 8 x 12	S	500	17,60 gal Zn
M 8 x 16	S	200	20,30 gal Zn
M 8 x 20	S	200	24,50 gal Zn
M 8 x 25	S	200	52,00 gal Zn
M 8 x 30	S	200	59,00 gal Zn
M 8 x 35	S	200	36,00 gal Zn
M 8 x 40	S	200	78,00 gal Zn
M 8 x 50	S	100	107,00 gal Zn
M 10 x 8	S	200	36,50 gal Zn
M 10 x 12	S	200	30,00 gal Zn
M 10 x 16	S	200	32,00 gal Zn



- ✓ Große Artikelvielfalt
- ✓ Verlässliche Qualität
- ✓ Hohe Lieferbereitschaft

Abmessungen	VE	Stück	€/100/Obf.	Abmessungen	VE	Stück	€/100/Obf.	Abmessungen	VE	Stück	€/100/Obf.
M 10 x 20	S	200	35,50 gal Zn	M 3 x 3	S	1000	9,40	M 10 x 20	S	200	21,50
M 10 x 25	S	100	42,50 gal Zn	M 3 x 4	S	1000	8,80	M 10 x 25	S	100	25,50
M 10 x 30	S	100	56,00 gal Zn	M 3 x 5	S	1000	8,90	M 10 x 30	S	100	29,50
M 10 x 35	S	100	44,00 gal Zn	M 3 x 6	S	1000	9,10	M 10 x 35	S	100	34,00
M 10 x 40	S	100	77,00 gal Zn	M 3 x 8	S	1000	9,50	M 10 x 40	S	100	42,00
M 10 x 50	S	100	148,00 gal Zn	M 3 x 10	S	1000	9,90	M 10 x 45	S	100	54,00
M 10 x 55	S	100	113,00 gal Zn	M 3 x 12	S	1000	10,50	M 10 x 50	S	100	60,00
M 10 x 60	S	100	213,00 gal Zn	M 3 x 16	S	500	11,70	M 10 x 60	S	100	92,00
M 12 x 12	S	200	56,00 gal Zn	M 3 x 20	S	500	12,40	M 10 x 70	S	100	112,00
M 12 x 16	S	200	59,00 gal Zn	M 4 x 4	S	1000	8,20	M 10 x 80	S	100	134,00
M 12 x 20	S	100	54,00 gal Zn	M 4 x 5	S	1000	7,80	M 12 x 10	S	200	42,50
M 12 x 25	S	100	66,00 gal Zn	M 4 x 6	S	1000	7,90	M 12 x 12	S	200	32,50
M 12 x 30	S	100	74,00 gal Zn	M 4 x 8	S	1000	8,20	M 12 x 16	S	200	29,50
M 12 x 35	S	100	81,00 gal Zn	M 4 x 10	S	1000	8,40	M 12 x 20	S	100	34,00
M 12 x 40	S	100	87,00 gal Zn	M 4 x 12	S	1000	8,90	M 12 x 25	S	100	38,00
M 12 x 50	S	100	136,00 gal Zn	M 4 x 16	S	1000	10,10	M 12 x 30	S	100	42,00
M 12 x 55	S	100	102,00 gal Zn	M 4 x 20	S	500	10,30	M 12 x 35	S	100	45,50
M 12 x 60	S	50	102,00 gal Zn	M 4 x 25	S	500	17,00	M 12 x 40	S	100	50,00
M 12 x 70	S	50	134,00 gal Zn	M 4 x 30	S	200	45,00	M 12 x 45	S	100	57,00
M 12 x 80	S	50	156,00 gal Zn	M 4 x 40	S	200	73,00	M 12 x 50	S	100	68,00
M 16 x 16	S	100	134,00 gal Zn	M 5 x 4	S	1000	11,90	M 12 x 55	S	100	82,00
M 16 x 20	S	100	131,00 gal Zn	M 5 x 5	S	1000	8,90	M 12 x 60	S	50	82,00
M 16 x 25	S	100	148,00 gal Zn	M 5 x 6	S	1000	8,60	M 12 x 70	S	50	114,00
M 16 x 30	S	100	161,00 gal Zn	M 5 x 8	S	1000	7,80	M 12 x 80	S	50	136,00
M 16 x 35	S	100	175,00 gal Zn	M 5 x 8	K	200	8,90	M 14 x 20	S	100	91,00
M 16 x 40	S	50	189,00 gal Zn	M 5 x 10	S	1000	9,20	M 14 x 30	S	100	105,00
M 16 x 45	S	50	211,00 gal Zn	M 5 x 12	S	1000	9,90	M 14 x 40	S	50	118,00
M 16 x 50	S	50	226,00 gal Zn	M 5 x 16	S	1000	10,70	M 14 x 50	S	50	151,00
M 16 x 55	S	50	242,00 gal Zn	M 5 x 18	S	500	11,80	M 16 x 16	S	100	63,00
M 16 x 60	S	50	255,00 gal Zn	M 5 x 20	S	500	11,80	M 16 x 20	S	100	68,00
M 16 x 70	S	50	365,00 gal Zn	M 5 x 25	S	500	16,70	M 16 x 25	S	100	74,00
M 20 x 25	S	100	231,00 gal Zn	M 5 x 30	S	200	19,00	M 16 x 30	S	100	79,00
M 20 x 35	S	50	260,00 gal Zn	M 5 x 35	S	200	26,00	M 16 x 35	S	100	85,00
M 20 x 40	S	50	275,00 gal Zn	M 5 x 40	S	200	29,50	M 16 x 40	S	50	89,00
M 20 x 50	S	50	310,00 gal Zn	M 6 x 5	S	1000	13,20	M 16 x 45	S	50	101,00
M 20 x 60	S	25	340,00 gal Zn	M 6 x 6	S	1000	8,80	M 16 x 50	S	50	113,00
M 20 x 70	S	25	450,00 gal Zn	M 6 x 6	K	200	10,10	M 16 x 55	S	50	129,00
M 20 x 80	S	25	500,00 gal Zn	M 6 x 8	S	1000	8,20	M 16 x 60	S	50	129,00
M 24 x 30	S	50	255,00 gal Zn	M 6 x 8	K	200	9,40	M 16 x 70	S	50	181,00
M 24 x 40	S	25	270,00 gal Zn	M 6 x 10	S	1000	8,30	M 16 x 80	S	50	204,00
				M 6 x 10	K	200	9,60	M 16 x 90	S	25	227,00
				M 6 x 12	S	1000	8,80	M 16 x 100	S	25	495,00
				M 6 x 12	K	200	10,10	M 20 x 20	S	100	124,00
				M 6 x 16	S	500	9,90	M 20 x 25	S	100	132,00
				M 6 x 16	K	200	11,30	M 20 x 30	S	50	141,00
				M 6 x 18	S	500	12,90	M 20 x 35	S	50	148,00
				M 6 x 20	S	500	12,90	M 20 x 40	S	50	157,00
				M 6 x 25	S	200	17,60	M 20 x 45	S	50	165,00
				M 6 x 30	S	200	19,30	M 20 x 50	S	50	177,00
				M 6 x 35	S	200	23,50	M 20 x 60	S	25	193,00
				M 6 x 40	S	200	28,00	M 20 x 70	S	25	260,00
				M 6 x 45	S	200	33,00	M 20 x 80	S	25	285,00
				M 6 x 50	S	200	36,50	M 20 x 90	S	25	315,00
				M 8 x 6	S	500	15,30	M 24 x 30	S	50	255,00
				M 8 x 8	S	500	10,20	M 24 x 35	S	50	265,00
				M 8 x 8	K	200	11,70	M 24 x 50	S	25	325,00
				M 8 x 10	S	500	10,90	M 24 x 60	S	25	480,00
				M 8 x 12	S	500	11,80	M 24 x 70	S	25	530,00
				M 8 x 16	S	200	13,00	M 24 x 90	S	25	620,00
				M 8 x 18	S	200	15,50	M 24 x 100	S	25	890,00
				M 8 x 20	S	200	15,50				
				M 8 x 25	S	200	20,30				
				M 8 x 30	S	200	24,60				
				M 8 x 35	S	200	27,00				
				M 8 x 40	S	200	34,50				
				M 8 x 45	S	100	41,50				
				M 8 x 50	S	100	47,50				
				M 8 x 55	S	100	68,00				
				M 8 x 60	S	100	68,00				
				M 8 x 70	S	100	78,00				
				M 8 x 80	S	100	92,00				
				M 10 x 8	S	200	22,80				
				M 10 x 10	S	200	17,20				
				M 10 x 12	S	200	15,90				
				M 10 x 16	S	200	18,20				

ISO 04029.200

4029 45 H



Gewindestifte mit Ringschneide und Innensechskant

Achtung! Nicht für Zugbelastung.

Maße → TI-21 Normumstellung → TI-6
 Werkstoffeigensch. → TI-232 REACH → TI-262

Rostfrei → S. 543

ISO 4029 → ersetzt DIN 916



M 2 x 2,5	S	500	112,00
M 2 x 3	S	500	101,00
M 2 x 4	S	500	103,00
M 2 x 5	S	500	105,00
M 2 x 6	S	500	108,00
M 2,5 x 3	S	500	83,00
M 2,5 x 4	S	500	86,00
M 2,5 x 5	S	500	89,00
M 2,5 x 6	S	500	94,00
M 2,5 x 10	S	500	101,00

Abmessungen	VE Stück	€/100/Obf.
ISO	04029.210	
4029	45 H	galvanisch verzinkt



Gewindestifte mit Ringschneide und Innensechskant

Achtung! Nicht für Zugbelastung.

Maße → **TI-21** Normumstellung → **TI-6**
 Werkstoffeigensch. → **TI-232** REACH → **TI-262**
 Korrosionsschutz → **TI-228**

Rostfrei → **S. 543**

ISO 4029 → ersetzt DIN 916



M 3	x	3	S	1000	11,80 gal Zn
M 3	x	4	S	1000	11,20 gal Zn
M 3	x	5	S	1000	11,40 gal Zn
M 3	x	6	S	1000	11,70 gal Zn
M 3	x	8	S	1000	12,10 gal Zn
M 3	x	10	S	1000	12,40 gal Zn
M 3	x	12	S	1000	13,10 gal Zn
M 3	x	16	S	500	14,20 gal Zn
M 3	x	20	S	500	15,00 gal Zn
M 4	x	4	S	1000	10,30 gal Zn
M 4	x	5	S	1000	10,30 gal Zn
M 4	x	6	S	1000	10,30 gal Zn
M 4	x	8	S	1000	10,60 gal Zn
M 4	x	10	S	1000	15,30 gal Zn
M 4	x	12	S	1000	16,60 gal Zn
M 4	x	16	S	1000	18,10 gal Zn
M 4	x	20	S	500	18,70 gal Zn
M 5	x	5	S	1000	11,70 gal Zn
M 5	x	6	S	1000	11,30 gal Zn
M 5	x	8	S	1000	11,80 gal Zn
M 5	x	10	S	1000	12,40 gal Zn
M 5	x	12	S	1000	18,10 gal Zn
M 5	x	16	S	1000	18,70 gal Zn
M 5	x	20	S	500	20,70 gal Zn
M 5	x	25	S	500	31,00 gal Zn
M 5	x	30	S	200	33,50 gal Zn
M 5	x	40	S	200	43,50 gal Zn
M 6	x	5	S	1000	23,60 gal Zn
M 6	x	6	S	1000	16,10 gal Zn
M 6	x	8	S	1000	12,60 gal Zn
M 6	x	10	S	1000	13,10 gal Zn
M 6	x	12	S	1000	13,80 gal Zn
M 6	x	16	S	500	16,00 gal Zn
M 6	x	20	S	500	19,50 gal Zn
M 6	x	25	S	200	26,50 gal Zn
M 6	x	30	S	200	34,50 gal Zn
M 6	x	35	S	200	41,50 gal Zn
M 6	x	40	S	200	60,00 gal Zn
M 6	x	45	S	200	58,00 gal Zn
M 6	x	50	S	200	67,00 gal Zn
M 8	x	6	S	500	28,00 gal Zn
M 8	x	8	S	500	16,00 gal Zn
M 8	x	10	S	500	15,40 gal Zn
M 8	x	12	S	500	16,70 gal Zn
M 8	x	16	S	200	19,30 gal Zn
M 8	x	20	S	200	24,90 gal Zn
M 8	x	25	S	200	33,00 gal Zn
M 8	x	30	S	200	39,50 gal Zn
M 8	x	35	S	200	42,00 gal Zn
M 8	x	40	S	200	49,50 gal Zn

Abmessungen	VE Stück	€/100/Obf.
M 8 x 45	S 100	72,00 gal Zn
M 8 x 50	S 100	83,00 gal Zn
M 10 x 8	S 200	27,00 gal Zn
M 10 x 10	S 200	26,00 gal Zn
M 10 x 12	S 200	23,20 gal Zn
M 10 x 14	S 200	36,50 gal Zn
M 10 x 16	S 200	27,50 gal Zn
M 10 x 20	S 200	33,00 gal Zn
M 10 x 25	S 100	44,50 gal Zn
M 10 x 30	S 100	48,50 gal Zn
M 10 x 35	S 100	63,00 gal Zn
M 10 x 40	S 100	77,00 gal Zn
M 10 x 50	S 100	105,00 gal Zn
M 10 x 60	S 100	128,00 gal Zn
M 10 x 70	S 100	147,00 gal Zn
M 10 x 80	S 100	147,00 gal Zn
M 12 x 10	S 200	47,50 gal Zn
M 12 x 12	S 200	38,00 gal Zn
M 12 x 16	S 200	47,00 gal Zn
M 12 x 20	S 100	54,00 gal Zn
M 12 x 25	S 100	62,00 gal Zn
M 12 x 30	S 100	72,00 gal Zn
M 12 x 35	S 100	78,00 gal Zn
M 12 x 40	S 100	85,00 gal Zn
M 12 x 45	S 100	100,00 gal Zn
M 12 x 50	S 100	94,00 gal Zn
M 12 x 60	S 50	102,00 gal Zn
M 16 x 16	S 100	111,00 gal Zn
M 16 x 20	S 100	120,00 gal Zn
M 16 x 25	S 100	132,00 gal Zn
M 16 x 30	S 100	138,00 gal Zn
M 16 x 35	S 100	147,00 gal Zn
M 16 x 40	S 50	160,00 gal Zn
M 16 x 50	S 50	184,00 gal Zn
M 16 x 60	S 50	200,00 gal Zn
M 16 x 70	S 50	255,00 gal Zn
M 16 x 90	S 25	305,00 gal Zn
M 20 x 20	S 100	197,00 gal Zn
M 20 x 30	S 50	213,00 gal Zn

~ISO	04029.205
4029	45 H Fein

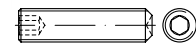

Gewindestifte mit Ringschneide und Innensechskant, mit metrischem Feingewinde

Achtung! Nicht für Zugbelastung.

Maße → **TI-21** Normumstellung → **TI-6**
 Werkstoffeigensch. → **TI-232** REACH → **TI-262**

ISO 4029 → ersetzt DIN 916



M 6	x	0,75	x	6	S	1000	111,00
M 6	x	0,75	x	8	S	1000	119,00
M 6	x	0,75	x	10	S	1000	130,00
M 6	x	0,75	x	12	S	1000	136,00
M 6	x	0,75	x	16	S	500	144,00
M 6	x	0,75	x	20	S	500	146,00
M 8	x	1	x	6	S	500	57,00
M 8	x	1	x	8	S	500	39,00
M 8	x	1	x	10	S	200	50,00
M 8	x	1	x	12	S	200	60,00
M 8	x	1	x	16	S	200	89,00

Abmessungen	VE Stück	€/100/Obf.
M 8 x 1 x 20	S 200	99,00
M 8 x 1 x 25	S 200	124,00
M 8 x 1 x 30	S 200	134,00
M 8 x 1 x 40	S 200	169,00
M 8 x 1 x 50	S 100	210,00
M 10 x 1 x 8	S 200	78,00
M 10 x 1,25 x 8	S 200	365,00
M 10 x 1 x 10	S 200	59,00
M 10 x 1,25 x 10	S 200	192,00
M 10 x 1 x 12	S 200	80,00
M 10 x 1,25 x 12	S 200	236,00
M 10 x 1 x 16	S 200	100,00
M 10 x 1,25 x 16	S 200	260,00
M 10 x 1 x 20	S 200	147,00
M 10 x 1,25 x 20	S 200	265,00
M 10 x 1 x 25	S 100	151,00
M 10 x 1,25 x 25	S 100	270,00
M 10 x 1 x 30	S 100	157,00
M 10 x 1,25 x 30	S 100	285,00
M 12 x 1 x 10	S 200	410,00
M 12 x 1,5 x 10	S 200	211,00
M 12 x 1 x 12	S 200	160,00
M 12 x 1,25 x 12	S 200	244,00
M 12 x 1,5 x 12	S 200	215,00
M 12 x 1 x 16	S 200	175,00
M 12 x 1,25 x 16	S 200	250,00
M 12 x 1,25 x 20	S 100	270,00
M 12 x 1,5 x 20	S 100	244,00
M 12 x 1,25 x 25	S 100	285,00
M 12 x 1,5 x 25	S 100	255,00
M 12 x 1,25 x 30	S 100	300,00
M 16 x 1,5 x 16	S 100	365,00
M 16 x 1,5 x 20	S 100	370,00
M 16 x 1,5 x 25	S 100	380,00
M 16 x 1,5 x 30	S 100	400,00
M 16 x 1,5 x 40	S 50	425,00

ISO	04032.(**)
4032	5-2 AD W7

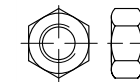

Sechskantmuttern, ISO-Typ 1

für Druckbehälterbau nach AD-Regelwerk bis M 39,

*M 5 - M 39 = RAZ 3320 übrige Ø = RAZ 411,
 **M 6 - M 39 = 504 übrige Ø = 500

Maße → **TI-62** Normumstellung → **TI-7**
 Werkstoffeigensch. → **TI-233** REACH → **TI-262**
 Anziehmomente → **TI-244**

Rostfrei → **S. 544**

ISO 4032 → ersetzt DIN 934



M 6	S	100	11,80
M 8	S	100	13,80
M 10	S	100	19,70
M 12	S	100	21,60
M 14	S	100	38,00
M 16	S	100	39,00
M 18	S	50	69,00
M 20	S	50	82,00
M 22	S	50	107,00
M 24	S	50	125,00
M 27	S	50	199,00
M 30	S	25	260,00

Abmessungen	VE	Stück	€/100/Obf.
M 33	S	10	410,00
M 36	S	10	495,00
M 39	S	5	720,00
M 42	S	1	1080,00
M 45	S	1	1320,00

ISO	04032.514
4032	5-2 AD W7
	galvanisch verzinkt

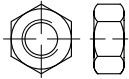

Sechskantmuttern, ISO-Typ 1

für Druckbehälterbau nach AD-Regelwerk

Maße → **TI-62** Anziehmomente → **TI-244**
 Werkstoffeigensch. → **TI-233** Normumstellung → **TI-7**
 Korrosionsschutz → **TI-228** REACH → **TI-262**

Rostfrei → **S. 544**

ISO 4032 → ersetzt DIN 934



M 6	S	100	15,30 gal Zn
M 8	S	100	19,40 gal Zn
M 10	S	100	23,20 gal Zn
M 12	S	100	27,00 gal Zn
M 16	S	100	48,50 gal Zn
M 20	S	100	101,00 gal Zn
M 24	S	50	158,00 gal Zn
M 27	S	50	246,00 gal Zn
M 30	S	25	330,00 gal Zn
M 33	S	10	495,00 gal Zn
M 36	S	10	620,00 gal Zn
M 39	S	10	820,00 gal Zn

ISO	04032.524
4032	5-2 AD W7
	feuerverzinkt

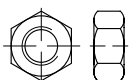

Sechskantmuttern, ISO-Typ 1

für Druckbehälterbau nach AD-Regelwerk,
Gewindetoleranz 6H

Maße → **TI-62** Anziehmomente → **TI-244**
 Werkstoffeigensch. → **TI-233** Normumstellung → **TI-7**
 Korrosionsschutz → **TI-231** REACH → **TI-262**

Rostfrei → **S. 544**

ISO 4032 → ersetzt DIN 934

M 10	S	100	36,50 tZn
M 12	S	100	38,00 tZn
M 16	S	100	69,00 tZn
M 20	S	50	138,00 tZn
M 24	S	50	223,00 tZn
M 27	S	50	305,00 tZn

Abmessungen	VE	Stück	€/100/Obf.
M 30	S	25	390,00 tZn
M 33	S	25	485,00 tZn
M 36	S	10	910,00 tZn

ISO	04032.004
4032	C35 AD W7

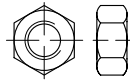

Sechskantmuttern, ISO-Typ 1

für Druckbehälterbau nach AD-Regelwerk,
Fabrikate mit Verzicht eines Abnahmeprüfzeugnis

Maße → **TI-62** Normumstellung → **TI-7**
 Werkstoffeigensch. → **TI-233**

Rostfrei → **S. 544**

ISO 4032 → ersetzt DIN 934



M 12	S	100	47,50
M 16	S	100	84,00
M 20	S	50	126,00
M 24	S	25	215,00
M 27	S	25	345,00
M 30	S	25	510,00
M 33	S	10	720,00
M 36	S	10	920,00

ISO	04032.374
4032	1.7218 +QT (25CrMo4)



Sechskantmuttern, ISO-Typ 1

Zugelassen für den Einsatz nach
Druckgeräterichtlinie → APZ 3.1 auf Anfrage

Maße → **TI-15** Anziehmomente → **TI-245**
 Werkstoffeigensch. → **TI-240** Normumstellung → **TI-7**

ISO 4032 → ersetzt DIN 934

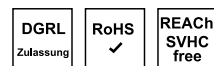

M 12	S	100	39,00
M 16	S	100	68,00
M 20	S	50	143,00
M 24	S	50	220,00
M 27	S	50	350,00
M 30	S	25	450,00
M 33	S	10	720,00
M 36	S	10	860,00
M 39	S	5	1700,00

Abmessungen	VE	Stück	€/100/Obf.
-------------	----	-------	------------

ISO	04032.375
4032	1.7218 +QT (25CrMo4)
	galvanisch verzinkt

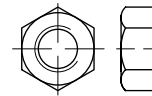

Sechskantmuttern, ISO-Typ 1

Zugelassen für den Einsatz nach
Druckgeräterichtlinie → APZ 3.1 auf Anfrage

Maße → **TI-62** Anziehmomente → **TI-245**
 Werkstoffeigensch. → **TI-240** Normumstellung → **TI-7**
 Korrosionsschutz → **TI-228**

ISO 4032 → ersetzt DIN 934

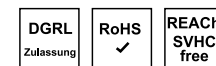

M 12	S	100	47,50 gal Zn
M 16	S	100	85,00 gal Zn
M 20	S	100	177,00 gal Zn
M 24	S	50	280,00 gal Zn
M 27	S	50	435,00 gal Zn
M 30	S	25	580,00 gal Zn
M 33	S	10	860,00 gal Zn
M 36	S	10	1090,00 gal Zn

ISO	04032.301
4032	6 AU

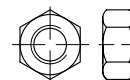

Sechskantmuttern, ISO-Typ 1

*M 5 - M 39 = RAZ 3320 übrige Ø = RAZ 411,
Kennzeichnung ab Ø M 12

Maße → **TI-62** Normumstellung → **TI-7**
 Werkstoffeigensch. → **TI-233** REACH → **TI-262**

Rostfrei → **S. 544**

Messing, Aluminium, Titan, Kupfer → **S. 637**

ISO 4032 → ersetzt DIN 934



M 1	K	100	226,00
M 1,2	K	100	148,00
M 1,4	K	100	153,00
M 1,6	K	100	102,00
M 1,7	K	100	99,00
M 2	S	1000	27,00
M 2	K	100	35,00
M 2,3	S	1000	17,70
M 2,5	S	1000	17,70
M 2,5	K	100	35,00
M 2,6	S	1000	29,00
M 2,6	K	100	35,00
M 3	S	1000	29,00
M 3	K	100	33,00
M 3,5	S	1000	30,50
M 3,5	K	100	34,00
M 4	S	1000	19,70
M 4	K	100	34,50
M 5	S	1000	26,00

Abmessungen	VE	Stück	€/100/Obf.
M 6	S	1000	33,00
M 8	S	1000	64,00
M 10	S	500	106,00
M 12	S	250	151,00
M 14	S	250	226,00
M 16	S	100	335,00
M 18	S	50	510,00
M 20	S	50	630,00
M 22	S	50	760,00
M 24	S	25	1090,00
M 27	S	25	1750,00
M 30	S	10	2550,00
M 36	S	10	4300,00
M 39	S	5	5400,00
M 42	S	1	7100,00
M 45	S	1	8700,00
M 48	S	1	10400,00
M 52	S	1	12600,00
M 56	S	1	17200,00
M 60	S	1	20600,00
M 64	S	1	33900,00
M 68	S	1	38800,00

Abmessungen	VE	Stück	€/100/Obf.
ISO	04032.800		

4032 8

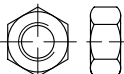

Sechskantmutter, ISO-Typ 1

*M 5 - M 39 = RAZ 3330 übrige Ø = RAZ 412

Maße → [TI-62](#) Anziehungsmomente → [TI-244](#)
 Werkstoffeigensch. → [TI-233](#) Normumstellung → [TI-7](#)

Rostfrei → [S. 544](#)
 Messing, Aluminium, Titan, Kupfer → [S. 637](#)

ISO 4032 → ersetzt DIN 934



Abmessungen	VE	Stück	€/100/Obf.
ISO	04032.810		

4032 8 galvanisch verzinkt

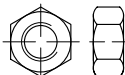

Sechskantmutter, ISO-Typ 1

*M 5 - M 39 = RAZ 3330 übrige Ø = RAZ 412

Maße → [TI-62](#) Anziehungsmomente → [TI-244](#)
 Werkstoffeigensch. → [TI-233](#) Normumstellung → [TI-7](#)
 Korrosionsschutz → [TI-228](#)

Rostfrei → [S. 544](#)
 Messing, Aluminium, Titan, Kupfer → [S. 637](#)

ISO 4032 → ersetzt DIN 934



ISO	04032.304
-----	-----------

4032 6 AU Links

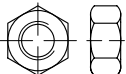

Sechskantmutter, ISO-Typ 1, mit metrischem Linksgewinde

*M 5 - M 39 = RAZ 3320 übrige Ø = RAZ 411, Kennzeichnung ab Ø M 12

Maße → [TI-62](#) Normumstellung → [TI-7](#)
 Werkstoffeigensch. → [TI-233](#) REACH → [TI-262](#)

Rostfrei → [S. 546](#)

ISO 4032 → ersetzt DIN 934



M 4	S	100	119,00
M 5	S	100	119,00
M 6	S	100	119,00
M 8	S	100	124,00
M 10	S	100	47,00
M 12	S	100	230,00
M 14	S	50	96,00
M 16	S	50	124,00
M 18	S	50	175,00
M 20	S	50	232,00
M 22	S	25	285,00
M 24	S	25	365,00
M 27	S	10	570,00
M 30	S	10	730,00
M 36	S	5	1280,00
M 42	S	1	9100,00
M 48	S	1	14300,00

M 2,5	S	1000	2,60
M 2,5	K	100	5,40
M 3	S	1000	1,70
M 3	K	100	4,45
M 4	S	1000	1,90
M 4	K	100	4,75
M 5	S	1000	2,45
M 6	S	1000	2,90
M 7	S	1000	4,70
M 8	S	1000	4,60
M 10	S	500	9,40
M 12	S	500	13,50
M 14	S	500	18,70
M 16	S	200	27,00
M 18	S	100	41,00
M 20	S	100	47,50
M 22	S	50	88,00
M 24	S	50	84,00
M 27	S	25	152,00
M 30	S	25	190,00
M 33	S	10	255,00
M 36	S	10	310,00
M 39	S	5	600,00
M 42	S	5	820,00
M 45	S	1	1050,00
M 48	S	1	1540,00
M 52	S	1	1810,00
M 56	S	1	3450,00
M 60	S	1	3950,00
M 64	S	1	4850,00

M 2	S	1000	2,60 gal Zn
M 2	K	100	5,50 gal Zn
M 2,5	S	1000	2,70 gal Zn
M 2,5	K	100	5,50 gal Zn
M 3	S	1000	1,75 gal Zn
M 3	K	100	4,60 gal Zn
M 4	S	1000	2,15 gal Zn
M 4	K	100	4,95 gal Zn
M 5	S	1000	2,80 gal Zn
M 5	K	100	6,10 gal Zn
M 6	S	1000	3,45 gal Zn
M 6	K	100	6,80 gal Zn
M 7	S	1000	5,30 gal Zn
M 8	S	1000	5,60 gal Zn
M 8	K	100	8,90 gal Zn
M 10	S	500	11,20 gal Zn
M 10	K	100	14,80 gal Zn
M 12	S	500	16,30 gal Zn
M 12	K	100	19,90 gal Zn
M 14	S	500	23,00 gal Zn
M 16	S	200	33,50 gal Zn
M 16	K	50	39,00 gal Zn
M 18	S	100	49,50 gal Zn
M 20	S	100	60,00 gal Zn
M 20	K	25	77,00 gal Zn
M 22	S	50	89,00 gal Zn
M 24	S	50	102,00 gal Zn
M 27	S	50	183,00 gal Zn
M 30	S	25	230,00 gal Zn
M 33	S	10	345,00 gal Zn
M 36	S	10	385,00 gal Zn
M 39	S	5	680,00 gal Zn
M 42	S	1	910,00 gal Zn
M 45	S	1	1150,00 gal Zn
M 48	S	1	1720,00 gal Zn
M 52	S	1	2010,00 gal Zn
M 56	S	1	3800,00 gal Zn
M 60	S	1	5100,00 gal Zn
M 64	S	1	5300,00 gal Zn
M 68	S	1	6700,00 gal Zn

Abmessungen	VE Stück	€/100/Obf.
ISO	04032.359	
4032	8**	galv. verz. 8 DiSP***

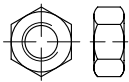

Sechskantmutter, ISO-Typ 1

* < M 5 = RAZ 412,
 ** ≤ M 5: Festigkeitsklasse = 6,
 *** < M 6 Mindestschichtdicke 5µm,
 Korrosionsbeständigkeit NSS: 72h WR, 120h RR

Maße → **TI-62** Anziehungsmomente → **TI-244**
 Werkstoffeigensch. → **TI-233** Normumstellung → **TI-7**
 Korrosionsschutz → **TI-228**

Rostfrei → **S. 544**
 Messing, Aluminium, Titan, Kupfer → **S. 637**

ISO 4032 → ersetzt DIN 934



M 2,5	S 1000	3,55 gal ZnDi
M 3	S 1000	2,30 gal ZnDi
M 3	K 100	6,00 gal ZnDi
M 4	S 1000	2,85 gal ZnDi
M 4	K 100	6,70 gal ZnDi
M 5	S 1000	3,60 gal ZnDi
M 6	S 1000	4,70 gal ZnDi
M 8	S 1000	7,50 gal ZnDi
M 10	S 500	15,40 gal ZnDi
M 12	S 500	22,20 gal ZnDi
M 14	S 100	39,00 gal ZnDi
M 16	S 200	45,00 gal ZnDi
M 20	S 100	78,00 gal ZnDi
M 24	S 50	130,00 gal ZnDi
M 30	S 25	315,00 gal ZnDi
M 36	S 10	520,00 gal ZnDi

ISO	04032.428
4032	8*
	galv. verz. 8 DiSP** + SL***

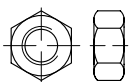

Sechskantmutter, ISO-Typ 1

* < M 5: Festigkeitsklasse = 6,
 ** < M 6 Mindestschichtdicke 5µm,
 ***SL = Sealer and Lubrication
 (Versiegelung und Schmierung mit µ = 0,12 - 0,18),
 Korrosionsbeständigkeit NSS: 120h WR, 264h RR

Maße → **TI-62** Anziehungsmomente → **TI-244**
 Werkstoffeigensch. → **TI-233** Normumstellung → **TI-7**
 Korrosionsschutz → **TI-228**

Rostfrei → **S. 544**
 Messing, Aluminium, Titan, Kupfer → **S. 637**

ISO 4032 → ersetzt DIN 934



M 3	S 1000	2,20 gal ZnDi
M 4	S 1000	2,70 gal ZnDi
M 5	S 1000	3,95 gal ZnDi

Abmessungen	VE Stück	€/100/Obf.
M 6	S 1000	4,45 gal ZnDi
M 8	S 1000	7,20 gal ZnDi
M 10	S 500	14,30 gal ZnDi
M 12	S 500	21,00 gal ZnDi
M 14	S 200	30,50 gal ZnDi
M 16	S 200	44,50 gal ZnDi
M 20	S 100	79,00 gal ZnDi
M 24	S 50	162,00 gal ZnDi
M 30	S 25	300,00 gal ZnDi
M 36	S 10	495,00 gal ZnDi

ISO	04032.353
4032	8
	flZn/TL480h

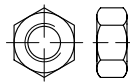

Sechskantmutter, ISO-Typ 1

TL = Schmierstoff im Topcoat mit µ = 0,09 - 0,14,
 Korrosionsbeständigkeit NSS: 480h RR,
 Chrom(VI)-frei

Achtung! Gegenüber galv. verzinkt geänderte Anziehdrehmomente.

Maße → **TI-62** Anziehungsmomente → **TI-245**
 Werkstoffeigensch. → **TI-233** Normumstellung → **TI-7**
 Korrosionsschutz → **TI-230**

Rostfrei → **S. 544**
 Messing, Aluminium, Titan, Kupfer → **S. 637**

ISO 4032 → ersetzt DIN 934



M 6	S 1000	5,40 flZn
M 8	S 1000	15,30 flZn
M 10	S 500	30,00 flZn
M 12	S 500	51,00 flZn
M 16	S 200	77,00 flZn
M 20	S 100	199,00 flZn
M 24	S 50	310,00 flZn

ISO	04032.820
4032	8
	feuerverzinkt

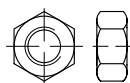

Sechskantmutter, ISO-Typ 1

Gewindetoleranz 6H,
 *M 5 - M 39 = RAZ 3340 übrige Ø = RAZ 413

Maße → **TI-62** Anziehungsmomente → **TI-244**
 Werkstoffeigensch. → **TI-233** Normumstellung → **TI-7**
 Korrosionsschutz → **TI-231**

Rostfrei → **S. 544**
 Messing, Aluminium, Titan, Kupfer → **S. 637**

ISO 4032 → ersetzt DIN 934



M 6	S 1000	6,30 tZn
M 8	S 1000	11,50 tZn
M 10	S 500	20,30 tZn

Abmessungen	VE Stück	€/100/Obf.
M 12	S 500	28,00 tZn
M 14	S 500	48,00 tZn
M 16	S 200	54,00 tZn
M 18	S 50	103,00 tZn
M 20	S 100	96,00 tZn
M 22	S 50	181,00 tZn
M 24	S 50	160,00 tZn
M 27	S 25	295,00 tZn
M 30	S 25	365,00 tZn
M 33	S 10	495,00 tZn
M 36	S 10	630,00 tZn
M 39	S 5	1140,00 tZn
M 42	S 5	1580,00 tZn
M 45	S 1	2050,00 tZn
M 48	S 1	2410,00 tZn
M 52	S 1	3650,00 tZn
M 56	S 1	5600,00 tZn
M 64	S 1	7200,00 tZn

ISO	04032.830
4032	8
	galvanisch vernickelt

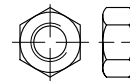

Sechskantmutter, ISO-Typ 1

*M 5 - M 39 = RAZ 3330 übrige Ø = RAZ 412

Maße → **TI-62** Anziehungsmomente → **TI-244**
 Werkstoffeigensch. → **TI-233** Normumstellung → **TI-7**
 Korrosionsschutz → **TI-228**

Rostfrei → **S. 544**
 Messing, Aluminium, Titan, Kupfer → **S. 637**

ISO 4032 → ersetzt DIN 934

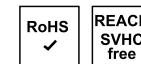

M 3	S 1000	2,25 gal Ni
M 4	S 1000	2,75 gal Ni
M 5	S 1000	8,70 gal Ni
M 6	S 1000	4,85 gal Ni
M 8	S 1000	9,60 gal Ni
M 10	S 500	18,80 gal Ni

Abmessungen VE Stück €/100/Obf.

ISO	04032.805
-----	-----------

4032

8

Links

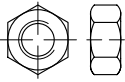

Sechskantmuttern, ISO-Typ 1 mit metrischem Linksgewinde

Maße → [TI-62](#) Anziehmomente → [TI-244](#)
 Werkstoffeigensch. → [TI-233](#) Normumstellung → [TI-7](#)

Rostfrei → [S. 546](#)

ISO 4032 → ersetzt DIN 934

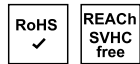

M 6 -LH	S	100	14,30
M 8 -LH	S	100	11,50
M 10 -LH	S	100	18,80
M 12 -LH	S	100	33,00
M 16 -LH	S	50	63,00
M 20 -LH	S	50	91,00
M 24 -LH	S	50	207,00
M 30 -LH	S	25	345,00

ISO	04032.814
-----	-----------

4032

8

galvanisch verzinkt

Links

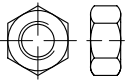

Sechskantmuttern, ISO-Typ 1, mit metrischem Linksgewinde

*M 5 - M 39 = RAZ 3330 übrige Ø = RAZ 412

Maße → [TI-62](#) Anziehmomente → [TI-244](#)
 Werkstoffeigensch. → [TI-233](#) Normumstellung → [TI-7](#)
 Korrosionsschutz → [TI-228](#)

Rostfrei → [S. 546](#)

ISO 4032 → ersetzt DIN 934

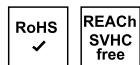

M 4	S	100	8,40 gal Zn
M 5	S	100	760,00 gal Zn
M 6	S	100	10,20 gal Zn
M 8	S	100	12,80 gal Zn
M 10	S	100	21,00 gal Zn
M 12	S	100	31,50 gal Zn
M 16	S	50	72,00 gal Zn
M 20	S	50	102,00 gal Zn
M 24	S	50	230,00 gal Zn
M 30	S	25	390,00 gal Zn
M 36	S	1	1150,00 gal Zn
M 39	S	1	2120,00 gal Zn
M 42	S	1	2700,00 gal Zn
M 48	S	1	4250,00 gal Zn

Abmessungen VE Stück €/100/Obf.

ISO	04032.809
-----	-----------

4032

8

-50 bis +300 °C

AD W7

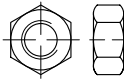

Sechskantmuttern, ISO-Typ 1 verwendbar bei -50 bis zu +300 °C

mit Abnahmeprüfzeugnis 3.1,
 Preise gelten zzgl. APZ-Kosten

Werkstoffe nicht geeignet für den Einsatz nach AD-Merkblatt W10

Maße → [TI-62](#) Anziehmomente → [TI-244](#)
 Werkstoffeigensch. → [TI-233](#) Normumstellung → [TI-7](#)

ISO 4032 → ersetzt DIN 934



M 8	S	1000	6,00
M 10	S	500	12,30
M 12	S	500	17,60
M 16	S	200	35,50
M 20	S	100	62,00
M 24	S	50	110,00
M 27	S	25	198,00

ISO	04032.819
-----	-----------

4032

8

Zn, -50 bis +300°C

AD W7

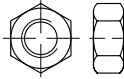

Sechskantmuttern, ISO-Typ 1 verwendbar bei -50 bis zu +300 °C

mit Abnahmeprüfzeugnis 3.1,
 Preise gelten zzgl. APZ-Kosten

Maße → [TI-62](#) Anziehmomente → [TI-244](#)
 Werkstoffeigensch. → [TI-233](#) Normumstellung → [TI-7](#)
 Korrosionsschutz → [TI-228](#)

ISO 4032 → ersetzt DIN 934



M 8	S	1000	7,30 gal Zn
M 10	S	500	14,60 gal Zn
M 12	S	500	21,20 gal Zn
M 16	S	200	62,50 gal Zn
M 20	S	100	79,00 gal Zn
M 24	S	50	215,00 gal Zn
M 27	S	50	239,00 gal Zn

Abmessungen VE Stück €/100/Obf.

ISO	04032.100
-----	-----------

4032

10

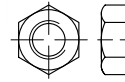

Sechskantmuttern, ISO-Typ 1

*M 5 - M 39 = RAZ 3320 übrige Ø = RAZ 411

Maße → [TI-62](#) Anziehmomente → [TI-244](#)
 Werkstoffeigensch. → [TI-233](#) Normumstellung → [TI-7](#)

Rostfrei → [S. 544](#)

Messing, Aluminium, Titan, Kupfer → [S. 637](#)

ISO 4032 → ersetzt DIN 934

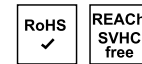

M 4	S	1000	6,20
M 4	K	100	8,80
M 5	S	1000	6,20
M 6	S	1000	6,90
M 8	S	1000	9,50
M 10	S	500	17,20
M 12	S	500	27,50
M 14	S	100	44,50
M 16	S	100	54,00
M 18	S	100	79,00
M 20	S	50	84,00
M 22	S	50	124,00
M 24	S	50	137,00
M 27	S	50	190,00
M 30	S	10	295,00
M 33	S	10	390,00
M 36	S	10	510,00
M 39	S	5	860,00
M 42	S	1	1310,00
M 45	S	1	1610,00
M 48	S	1	1870,00
M 52	S	1	3700,00

ISO	04032.110
-----	-----------

4032

10

galvanisch verzinkt

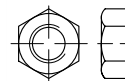

Sechskantmuttern, ISO-Typ 1

*M 5 - M 39 = RAZ 3320 übrige Ø = RAZ 411

Maße → [TI-62](#) Anziehmomente → [TI-244](#)
 Werkstoffeigensch. → [TI-233](#) Normumstellung → [TI-7](#)
 Korrosionsschutz → [TI-228](#)

Rostfrei → [S. 544](#)

Messing, Aluminium, Titan, Kupfer → [S. 637](#)

ISO 4032 → ersetzt DIN 934

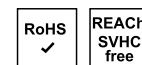

M 4	S	1000	6,80 gal Zn
M 4	K	100	9,40 gal Zn
M 5	S	1000	6,80 gal Zn
M 6	S	1000	7,60 gal Zn

Abmessungen	VE	Stück	€/100/Obf.
M 8	S	1000	10,60 gal Zn
M 10	S	500	19,80 gal Zn
M 12	S	500	31,50 gal Zn
M 14	S	100	51,00 gal Zn
M 16	S	100	62,00 gal Zn
M 18	S	100	87,00 gal Zn
M 20	S	50	97,00 gal Zn
M 22	S	50	134,00 gal Zn
M 24	S	50	163,00 gal Zn
M 27	S	50	200,00 gal Zn
M 30	S	10	345,00 gal Zn
M 33	S	10	500,00 gal Zn
M 36	S	10	620,00 gal Zn
M 39	S	1	990,00 gal Zn
M 42	S	5	1470,00 gal Zn
M 48	S	1	1470,00 gal Zn
M 52	S	1	3900,00 gal Zn

ISO	04032.180
4032	10 galv. verz. 8 DiSP*

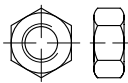

Sechskantmuttern, ISO-Typ 1

* < M 6 Mindestschichtdicke 5µm,
Korrosionsbeständigkeit NSS: 72h WR, 120h RR

Maße → TI-62 Anziehmomente → TI-244
Werkstoffeigensch. → TI-233 Normumstellung → TI-7
Korrosionsschutz → TI-228

Rostfrei → S. 544
Messing, Aluminium, Titan, Kupfer → S. 637

ISO 4032 → ersetzt DIN 934

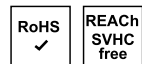

M 5	S	1000	8,10 gal ZnDi
M 6	S	1000	9,50 gal ZnDi
M 8	S	1000	13,40 gal ZnDi
M 10	S	500	25,50 gal ZnDi
M 12	S	500	41,50 gal ZnDi
M 16	S	100	79,00 gal ZnDi
M 20	S	50	124,00 gal ZnDi
M 24	S	50	206,00 gal ZnDi
M 27	S	50	290,00 gal ZnDi
M 30	S	10	450,00 gal ZnDi

Abmessungen	VE	Stück	€/100/Obf.
ISO			04032.354
4032	10		fiZn/TL480h

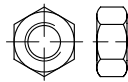

Sechskantmuttern, ISO-Typ 1

TL = Schmierstoff im Topcoat mit $\mu = 0,09 - 0,14$,
Korrosionsbeständigkeit NSS: 480h RR,
Chrom(VI)-frei

Achtung! Gegenüber galv. verzinkt geänderte Anziehdrehmomente.

Maße → TI-62 Anziehmomente → TI-245
Werkstoffeigensch. → TI-233 Normumstellung → TI-7
Korrosionsschutz → TI-230

Rostfrei → S. 544
Messing, Aluminium, Titan, Kupfer → S. 637

ISO 4032 → ersetzt DIN 934



M 6	S	1000	9,90 fiZn
M 8	S	1000	15,80 fiZn
M 10	S	500	27,50 fiZn
M 12	S	500	45,00 fiZn
M 16	S	100	85,00 fiZn
M 20	S	50	175,00 fiZn
M 24	S	50	247,00 fiZn
M 30	S	25	310,00 fiZn

ISO	04032.133
4032	10 fiZnL480h

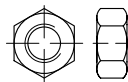

Sechskantmuttern, ISO-Typ 1

fiZnL = int. Schmierstoff mit $\mu = 0,12 - 0,18$,
Korrosionsbeständigkeit NSS: 480h RR,
Chrom(VI)-frei

Maße → TI-62 Anziehmomente → TI-245
Werkstoffeigensch. → TI-233 Normumstellung → TI-7
Korrosionsschutz → TI-230

Rostfrei → S. 544
Messing, Aluminium, Titan, Kupfer → S. 637

ISO 4032 → ersetzt DIN 934

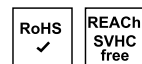

M 6	S	1000	9,90 fiZn
M 8	S	1000	15,80 fiZn
M 10	S	500	27,50 fiZn
M 12	S	500	45,00 fiZn
M 16	S	100	85,00 fiZn
M 18	S	100	128,00 fiZn
M 20	S	50	175,00 fiZn
M 24	S	50	247,00 fiZn
M 30	S	25	355,00 fiZn

Abmessungen	VE	Stück	€/100/Obf.
ISO			04032.120
4032	10		feuerverzinkt

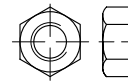

Sechskantmuttern, ISO-Typ 1

Gewindetoleranz 6H

Maße → TI-62 Anziehmomente → TI-244
Werkstoffeigensch. → TI-233 Normumstellung → TI-7
Korrosionsschutz → TI-231

Rostfrei → S. 544
Messing, Aluminium, Titan, Kupfer → S. 637

ISO 4032 → ersetzt DIN 934

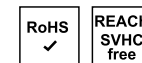

M 12	S	100	73,00 tZn
M 16	S	100	218,00 tZn
M 20	S	100	94,00 tZn
M 22	S	50	425,00 tZn
M 24	S	50	440,00 tZn
M 27	S	25	730,00 tZn
M 30	S	25	670,00 tZn
M 33	S	10	1150,00 tZn
M 36	S	10	1340,00 tZn
M 42	S	1	3650,00 tZn
M 48	S	1	4550,00 tZn

ISO	04032.200
4032	12

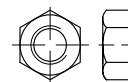

Sechskantmuttern, ISO-Typ 1

Maße → TI-62 Anziehmomente → TI-244
Werkstoffeigensch. → TI-233 Normumstellung → TI-7

Rostfrei → S. 544
Messing, Aluminium, Titan, Kupfer → S. 637

ISO 4032 → ersetzt DIN 934

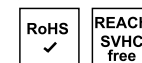

M 6	S	100	16,50
M 8	S	100	23,20
M 10	S	100	41,50
M 12	S	500	59,00
M 16	S	100	86,00
M 20	S	50	172,00
M 24	S	25	305,00
M 27	S	25	570,00
M 30	S	10	860,00
M 36	S	10	940,00

Abmessungen	VE Stück	€/100/Obf.
ISO	04032.270	
4032	12	flZnL480h

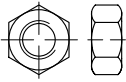

Sechskantmuttern, ISO-Typ 1

flZnL = int. Schmierstoff mit $\mu = 0,12 - 0,18$,
Korrosionsbeständigkeit NSS: 480h RR,
Chrom(VI)-frei

Maße → [TI-62](#) Anziehmomente → [TI-244](#)
Werkstoffeigensch. → [TI-233](#) Normumstellung → [TI-7](#)
Korrosionsschutz → [TI-230](#)

Rostfrei → [S. 544](#)
Messing, Aluminium, Titan, Kupfer → [S. 637](#)

ISO 4032 → ersetzt DIN 934



M 6	S 100	24,00
M 8	S 100	34,00
M 10	S 100	60,00
M 12	S 100	85,00
M 16	S 100	125,00
M 20	S 50	250,00

ISO	04033.200
4033	12

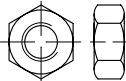

Sechskantmuttern, ISO-Typ 2

Maße → [TI-62](#) Anziehmomente → [TI-244](#)
Werkstoffeigensch. → [TI-233](#) Normumstellung → [TI-7](#)

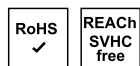

M 6	S 100	16,50
M 8	S 100	23,20
M 10	S 100	41,50
M 12	S 100	59,00
M 16	S 100	86,00
M 20	S 50	172,00
M 24	S 50	305,00
M 27	S 25	570,00
M 30	S 10	860,00
M 36	S 10	1250,00

Abmessungen	VE Stück	€/100/Obf.
ISO	04035.400	
4035	04	

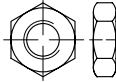

Niedrige Sechskantmuttern mit Fasen

*M 10, 12, 14, 22 = RAZ 3370

Maße → [TI-61](#) Normumstellung → [TI-7](#)
Werkstoffeigensch. → [TI-233](#) REACH → [TI-262](#)

Rostfrei → [S. 547](#)
Messing → [S. 638](#)

ISO 4035 → ersetzt DIN 439 Form B



M 2	S 1000	3,90
M 2	K 100	7,70
M 2,5	S 1000	3,90
M 2,5	K 100	7,70
M 3	S 1000	3,10
M 3	K 100	6,60
M 3,5	K 100	7,00
M 4	S 1000	3,45
M 4	K 100	7,20
M 5	S 1000	3,95
M 5	K 100	7,60
M 6	S 1000	4,40
M 6	K 100	7,90
M 8	S 1000	8,50
M 8	K 100	11,90
M 10	S 500	16,40
M 12	S 100	29,50
M 14	S 100	36,00
M 16	S 100	39,00
M 18	S 100	73,00
M 20	S 50	86,00
M 22	S 50	132,00
M 24	S 50	155,00
M 27	S 25	295,00
M 30	S 25	310,00
M 33	S 10	560,00
M 36	S 10	660,00
M 42	S 10	1350,00

Abmessungen	VE Stück	€/100/Obf.
ISO	04035.410	
4035	04	galvanisch verzinkt

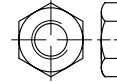

Niedrige Sechskantmuttern mit Fasen

*M 10, 12, 14, 22 = RAZ 3370

Maße → [TI-61](#) Normumstellung → [TI-7](#)
Werkstoffeigensch. → [TI-233](#) REACH → [TI-262](#)
Korrosionsschutz → [TI-228](#)

Rostfrei → [S. 547](#)
Messing → [S. 638](#)

ISO 4035 → ersetzt DIN 439 Form B



M 2	S 1000	3,95 gal Zn
M 2,5	S 1000	3,95 gal Zn
M 3	S 1000	3,15 gal Zn
M 3	K 100	6,70 gal Zn
M 4	S 1000	3,70 gal Zn
M 4	K 100	7,30 gal Zn
M 5	S 1000	4,30 gal Zn
M 5	K 100	7,80 gal Zn
M 6	S 1000	4,95 gal Zn
M 6	K 100	8,50 gal Zn
M 8	S 1000	9,60 gal Zn
M 8	K 100	13,20 gal Zn
M 10	S 500	19,00 gal Zn
M 12	S 100	33,50 gal Zn
M 14	S 100	41,00 gal Zn
M 16	S 100	44,50 gal Zn
M 20	S 50	96,00 gal Zn
M 24	S 50	174,00 gal Zn
M 30	S 25	345,00 gal Zn
M 33	S 10	630,00 gal Zn
M 36	S 10	730,00 gal Zn
M 42	S 10	1420,00 gal Zn

Abmessungen	VE Stück	€/100/Obf.
ISO	04035.308	
4035	04	galv. verz. 8 DiSP*

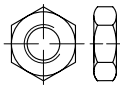

Niedrige Sechskantmuttern mit Fasen

*< M 6 Mindestschichtdicke 5µm, Korrosionsbeständigkeit NSS: 72h WR, 120h RR

Maße → [TI-61](#) Normumstellung → [TI-7](#)
 Werkstoffeigensch. → [TI-233](#) REACH → [TI-262](#)
 Korrosionsschutz → [TI-228](#)
 Rostfrei → [S. 547](#)
 Messing → [S. 638](#)

ISO 4035 → ersetzt DIN 439 Form B



M 3	S 1000	4,25 gal ZnDi
M 4	S 1000	5,10 gal ZnDi
M 5	S 1000	6,00 gal ZnDi
M 6	S 100	6,90 gal ZnDi
M 8	S 1000	13,00 gal ZnDi

ISO	04035.470
4035	04
	fiZn/TL480h

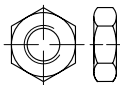

Niedrige Sechskantmuttern mit Fasen

TL = Schmierstoff im Topcoat mit $\mu = 0,09 - 0,14$, Korrosionsbeständigkeit NSS: 480h RR, Chrom(VI)-frei, *M 10, 12 = RAZ 3370

Maße → [TI-61](#) Normumstellung → [TI-7](#)
 Werkstoffeigensch. → [TI-233](#) REACH → [TI-262](#)
 Korrosionsschutz → [TI-230](#)
 Rostfrei → [S. 547](#)
 Messing → [S. 638](#)

ISO 4035 → ersetzt DIN 439 Form B



M 6	S 1000	6,50 fiZn
M 8	S 1000	12,50 fiZn
M 10	S 500	35,50 fiZn
M 12	S 100	44,00 fiZn
M 16	S 100	58,00 fiZn
M 20	S 50	125,00 fiZn
M 24	S 50	226,00 fiZn
M 30	S 25	510,00 fiZn

Abmessungen	VE Stück	€/100/Obf.
ISO	04035.420	
4035	04	feuerverzinkt

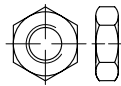

Niedrige Sechskantmuttern mit Fasen

Gewindetoleranz 6H, *M 10, 12 = RAZ 3370

Maße → [TI-61](#) Normumstellung → [TI-7](#)
 Werkstoffeigensch. → [TI-233](#) REACH → [TI-262](#)
 Korrosionsschutz → [TI-231](#)
 Rostfrei → [S. 547](#)
 Messing → [S. 638](#)

ISO 4035 → ersetzt DIN 439 Form B

M 8	S 100	48,50 tZn
M 10	S 100	48,50 tZn
M 12	S 100	48,50 tZn
M 16	S 100	56,00 tZn
M 20	S 50	118,00 tZn
M 24	S 50	210,00 tZn
M 27	S 25	380,00 tZn
M 30	S 25	420,00 tZn

ISO	04035.414
4035	04
	galvanisch verzinkt Links

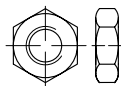

Niedrige Sechskantmuttern mit metrischem Linksgewinde, mit Fasen

*M 10, 12 = RAZ 3370

Maße → [TI-61](#) Normumstellung → [TI-7](#)
 Werkstoffeigensch. → [TI-233](#) REACH → [TI-262](#)
 Korrosionsschutz → [TI-228](#)
 Rostfrei → [S. 547](#)
 Messing → [S. 638](#)

ISO 4035 → ersetzt DIN 439 Form B



M 6	S 100	36,50 gal Zn
M 8	S 100	18,20 gal Zn
M 10	S 100	36,50 gal Zn
M 12	S 100	73,00 gal Zn
M 16	S 50	115,00 gal Zn
M 20	S 50	218,00 gal Zn
M 24	S 25	425,00 gal Zn
M 30	S 25	730,00 gal Zn
M 36	S 10	1940,00 gal Zn
M 42	S 10	2180,00 gal Zn

Abmessungen	VE Stück	€/100/Obf.
ISO	04035.500	
4035	05	

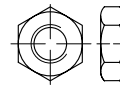

Sechskantmuttern, niedrige Form, mit Fasen

Maße → [TI-61](#) Normumstellung → [TI-7](#)
 Werkstoffeigensch. → [TI-233](#)

Rostfrei → [S. 547](#)
 Messing → [S. 638](#)

ISO 4035 → ersetzt DIN 439 Form B

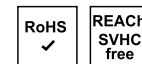

M 10	S 500	42,50
M 12	S 100	78,00
M 14	S 100	234,00
M 22	S 50	470,00

ISO	04035.510
4035	05
	galvanisch verzinkt

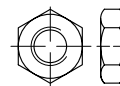

Sechskantmuttern, niedrige Form, mit Fasen

Maße → [TI-61](#) Korrosionsschutz → [TI-228](#)
 Werkstoffeigensch. → [TI-233](#) Normumstellung → [TI-7](#)

Rostfrei → [S. 547](#)
 Messing → [S. 638](#)

ISO 4035 → ersetzt DIN 439 Form B

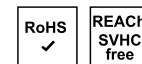

M 4	S 1000	29,50 gal Zn
M 5	S 1000	36,50 gal Zn
M 6	S 1000	39,00 gal Zn
M 8	S 1000	42,50 gal Zn
M 10	S 500	44,50 gal Zn
M 12	S 100	83,00 gal Zn
M 14	S 100	240,00 gal Zn
M 16	S 100	305,00 gal Zn
M 20	S 50	410,00 gal Zn
M 22	S 50	485,00 gal Zn

Abmessungen	VE Stück	€/100/Obf.
~DIN	04109.010	
4109	Stahl + Dämmeinlage	
	galvanisch verzinkt	

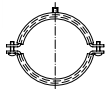

Schraubroherschellen, Kombi-Gewindeanschluss M8/M10, Schallschutz-Einlage ~ DIN 4109

≤ 71 = Bandstahl 20 X 1,0,
 ≥ 72 = Bandstahl 25 X 2,5,
 Temperaturbeständig -50 bis +110 °C

Maße → **TI-132**

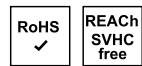

Für Rohr Ø von - bis / Kombi-Gewindeanschluss

20-23 M8/M10	S	100	335,00 gal Zn
25-28 M8/M10	S	100	360,00 gal Zn
32-35 M8/M10	S	100	380,00 gal Zn
40-43 M8/M10	S	100	425,00 gal Zn
48-53 M8/M10	S	50	510,00 gal Zn
57-61 M8/M10	S	50	570,00 gal Zn
60-64 M8/M10	S	50	610,00 gal Zn

ISO	04762.800
4762	8.8



Zylinderschrauben mit Innensechskant

Maße → **TI-12** Anziehmomente → **TI-244**
 Werkstoffeigensch. → **TI-232** Normumstellung → **TI-6**

Rostfrei → **S. 547**

ISO 4762 → ersetzt DIN 912 (austauschbar)

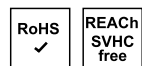

M 3 x 4	S	500	33,50
M 3 x 5	S	500	33,50
M 3 x 6	S	500	9,40
M 3 x 8	S	500	6,50
M 3 x 10	S	500	5,40
M 3 x 12	S	500	5,70
M 3 x 14	S	500	9,20
M 3 x 16	S	500	5,90
M 3 x 18	S	500	6,20
M 3 x 20	S	500	6,30
M 3 x 22	S	500	11,80
M 3 x 25	S	500	6,80
M 3 x 30	S	500	7,60
M 3 x 35	S	500	29,50
M 3 x 35	K	100	33,00
M 3 x 40	S	500	31,00
M 3 x 40	K	100	35,00
M 3 x 45	S	500	79,00
M 3 x 45	K	100	83,00
M 3 x 50	S	500	88,00
M 3 x 50	K	100	91,00
M 4 x 4	S	500	105,00
M 4 x 5	S	500	19,50

Abmessungen	VE Stück	€/100/Obf.	
M 4 x 5	K	100	23,20
M 4 x 6	S	500	11,20
M 4 x 6	K	100	14,90
M 4 x 8	S	500	6,60
M 4 x 8	K	100	10,20
M 4 x 10	S	500	4,85
M 4 x 10	K	100	8,60
M 4 x 12	S	500	5,30
M 4 x 12	K	100	8,90
M 4 x 14	S	500	8,30
M 4 x 16	S	500	5,00
M 4 x 16	K	100	8,70
M 4 x 18	S	500	5,30
M 4 x 18	K	100	8,90
M 4 x 20	S	500	5,40
M 4 x 20	K	100	9,10
M 4 x 22	S	500	10,20
M 4 x 25	S	500	6,00
M 4 x 25	K	100	9,70
M 4 x 28	S	500	11,80
M 4 x 30	S	500	6,60
M 4 x 30	K	100	10,30
M 4 x 35	S	500	7,90
M 4 x 35	K	100	11,60
M 4 x 40	S	500	8,30
M 4 x 40	K	100	12,00
M 4 x 45	S	500	18,00
M 4 x 45	K	100	21,60
M 4 x 50	S	500	19,90
M 4 x 50	K	100	23,60
M 4 x 55	S	200	23,90
M 4 x 55	K	100	27,50
M 4 x 60	S	200	23,90
M 4 x 60	K	100	27,50
M 4 x 65	S	200	37,50
M 4 x 65	K	100	41,00
M 4 x 70	S	200	37,50
M 4 x 70	K	100	41,00
M 4 x 75	S	200	68,00
M 4 x 80	S	200	78,00
M 4 x 85	S	200	300,00
M 4 x 90	S	200	330,00
M 4 x 95	S	200	365,00
M 4 x 100	S	200	390,00
M 4 x 110	S	200	420,00
M 4 x 120	S	200	480,00
M 5 x 5	S	500	107,00
M 5 x 6	S	500	11,80
M 5 x 6	K	100	15,50
M 5 x 8	S	500	9,20
M 5 x 8	K	100	12,80
M 5 x 10	S	500	4,75
M 5 x 10	K	100	8,40
M 5 x 12	S	500	4,85
M 5 x 12	K	100	8,60
M 5 x 14	S	500	8,30
M 5 x 16	S	500	4,75
M 5 x 16	K	100	8,40
M 5 x 18	S	500	5,10
M 5 x 18	K	100	8,80
M 5 x 20	S	500	5,30
M 5 x 20	K	100	8,90
M 5 x 22	S	500	9,40
M 5 x 25	S	500	5,40
M 5 x 25	K	100	9,10
M 5 x 30	S	500	6,60
M 5 x 30	K	100	10,30
M 5 x 35	S	200	7,10
M 5 x 40	S	200	7,60
M 5 x 45	S	200	12,90
M 5 x 50	S	200	18,40
M 5 x 55	S	200	22,70
M 5 x 60	S	200	24,20
M 5 x 65	S	200	34,50
M 5 x 70	S	200	35,50

Abmessungen	VE Stück	€/100/Obf.	
M 5 x 75	S	200	44,50
M 5 x 80	S	200	47,00
M 5 x 85	S	200	65,00
M 5 x 90	S	200	60,00
M 5 x 95	S	200	77,00
M 5 x 100	S	200	64,00
M 5 x 105	S	100	165,00
M 5 x 110	S	200	72,00
M 5 x 115	S	100	195,00
M 5 x 120	S	100	79,00
M 5 x 125	S	100	335,00
M 5 x 130	S	100	305,00
M 5 x 135	S	100	365,00
M 5 x 140	S	100	510,00
M 5 x 145	S	100	680,00
M 5 x 150	S	100	660,00
M 5 x 155	S	100	690,00
M 5 x 160	S	100	670,00
M 5 x 165	S	100	720,00
M 5 x 170	S	100	710,00
M 5 x 175	S	100	760,00
M 5 x 180	S	100	740,00
M 5 x 185	S	100	910,00
M 5 x 190	S	100	910,00
M 5 x 195	S	100	990,00
M 5 x 200	S	100	970,00
M 5 x 210	S	100	1150,00
M 5 x 220	S	100	1180,00
M 6 x 6	S	500	31,00
M 6 x 8	S	500	10,40
M 6 x 8	K	100	14,10
M 6 x 10	S	500	5,00
M 6 x 10	K	100	8,70
M 6 x 12	S	500	5,30
M 6 x 12	K	100	8,90
M 6 x 14	S	500	7,70
M 6 x 16	S	500	4,85
M 6 x 16	K	100	8,60
M 6 x 18	S	500	5,30
M 6 x 18	K	100	8,90
M 6 x 20	S	500	5,30
M 6 x 20	K	100	8,90
M 6 x 22	S	500	9,40
M 6 x 22	K	100	13,10
M 6 x 25	S	500	5,40
M 6 x 25	K	100	9,10
M 6 x 28	S	500	14,60
M 6 x 30	S	500	6,30
M 6 x 30	K	100	9,90
M 6 x 35	S	200	6,80
M 6 x 40	S	200	7,60
M 6 x 45	S	200	9,90
M 6 x 50	S	200	10,30
M 6 x 55	S	200	16,40
M 6 x 60	S	200	17,50
M 6 x 65	S	200	23,60
M 6 x 70	S	200	24,20
M 6 x 75	S	200	34,00
M 6 x 80	S	200	34,50
M 6 x 85	S	200	45,50
M 6 x 90	S	200	41,00
M 6 x 95	S	200	107,00
M 6 x 100	S	200	48,00
M 6 x 105	S	100	107,00
M 6 x 110	S	100	70,00
M 6 x 115	S	100	135,00
M 6 x 120	S	100	81,00
M 6 x 125	S	100	184,00
M 6 x 130	S	100	130,00
M 6 x 135	S	100	206,00
M 6 x 140	S	100	176,00
M 6 x 145	S	100	400,00
M 6 x 150	S	100	209,00
M 6 x 155	S	100	520,00
M 6 x 160	S	100	590,00

Abmessungen	VE	Stück	€/100/Obf.	Abmessungen	VE	Stück	€/100/Obf.	Abmessungen	VE	Stück	€/100/Obf.
M 6 x 165	S	100	620,00	M 10 x 35	S	100	17,50	M 12 x 165	S	50	380,00
M 6 x 170	S	100	710,00	M 10 x 40	S	100	18,60	M 12 x 170	S	50	310,00
M 6 x 175	S	100	800,00	M 10 x 45	S	100	20,50	M 12 x 180	S	50	310,00
M 6 x 180	S	100	800,00	M 10 x 50	S	100	21,80	M 12 x 190	S	50	360,00
M 6 x 185	S	100	970,00	M 10 x 55	S	100	23,60	M 12 x 200	S	50	360,00
M 6 x 190	S	100	970,00	M 10 x 60	S	100	25,50	M 12 x 210	S	25	920,00
M 6 x 195	S	100	1060,00	M 10 x 65	S	100	27,50	M 12 x 220	S	25	670,00
M 6 x 200	S	100	1060,00	M 10 x 70	S	100	28,50	M 12 x 230	S	25	990,00
M 6 x 210	S	100	1120,00	M 10 x 75	S	100	35,00	M 12 x 240	S	25	750,00
M 6 x 220	S	100	1180,00	M 10 x 80	S	100	36,00	M 12 x 250	S	25	1070,00
M 6 x 230	S	100	1270,00	M 10 x 85	S	100	71,00	M 12 x 260	S	25	820,00
M 6 x 240	S	100	1270,00	M 10 x 90	S	100	47,50	M 12 x 270	S	25	1140,00
M 6 x 250	S	100	1330,00	M 10 x 95	S	100	124,00	M 12 x 280	S	25	880,00
M 6 x 280	S	100	1430,00	M 10 x 100	S	100	52,00	M 12 x 290	S	25	1370,00
M 6 x 300	S	100	1590,00	M 10 x 105	S	100	136,00	M 12 x 300	S	25	950,00
M 8 x 8	S	200	27,50	M 10 x 110	S	100	60,00	M 12 x 310	S	25	1190,00
M 8 x 10	S	200	12,30	M 10 x 115	S	100	147,00	M 12 x 320	S	25	1190,00
M 8 x 12	S	200	12,80	M 10 x 120	S	50	73,00	M 12 x 340	S	25	1410,00
M 8 x 14	S	200	12,90	M 10 x 125	S	50	166,00	M 12 x 360	S	25	1990,00
M 8 x 16	S	200	7,90	M 10 x 130	S	50	108,00	M 12 x 380	S	25	2120,00
M 8 x 18	S	200	8,40	M 10 x 135	S	50	204,00	M 12 x 400	S	25	2210,00
M 8 x 20	S	200	8,00	M 10 x 140	S	50	131,00	M 14 x 20	S	100	111,00
M 8 x 22	S	200	14,30	M 10 x 150	S	50	180,00	M 14 x 25	S	100	82,00
M 8 x 25	S	200	8,80	M 10 x 155	S	50	285,00	M 14 x 30	S	100	74,00
M 8 x 30	S	200	9,20	M 10 x 160	S	50	197,00	M 14 x 35	S	100	85,00
M 8 x 35	S	200	10,50	M 10 x 170	S	50	325,00	M 14 x 40	S	100	76,00
M 8 x 40	S	200	11,90	M 10 x 180	S	50	300,00	M 14 x 45	S	50	86,00
M 8 x 45	S	200	12,60	M 10 x 185	S	50	440,00	M 14 x 50	S	50	85,00
M 8 x 50	S	200	13,00	M 10 x 190	S	50	355,00	M 14 x 55	S	50	106,00
M 8 x 55	S	200	15,30	M 10 x 200	S	50	330,00	M 14 x 60	S	50	97,00
M 8 x 60	S	200	17,00	M 10 x 210	S	50	650,00	M 14 x 65	S	50	123,00
M 8 x 65	S	200	24,70	M 10 x 220	S	50	650,00	M 14 x 70	S	50	124,00
M 8 x 70	S	200	25,50	M 10 x 230	S	50	670,00	M 14 x 75	S	50	137,00
M 8 x 75	S	200	31,50	M 10 x 240	S	50	670,00	M 14 x 80	S	50	143,00
M 8 x 80	S	200	40,50	M 10 x 250	S	50	830,00	M 14 x 85	S	50	154,00
M 8 x 85	S	100	60,00	M 10 x 260	S	50	800,00	M 14 x 90	S	50	154,00
M 8 x 90	S	100	50,00	M 10 x 270	S	50	880,00	M 14 x 95	S	50	182,00
M 8 x 95	S	100	83,00	M 10 x 280	S	50	880,00	M 14 x 100	S	50	170,00
M 8 x 100	S	100	56,00	M 10 x 290	S	50	960,00	M 14 x 110	S	50	204,00
M 8 x 105	S	100	83,00	M 10 x 300	S	50	960,00	M 14 x 120	S	50	223,00
M 8 x 110	S	100	66,00	M 10 x 320	S	50	1280,00	M 14 x 130	S	50	255,00
M 8 x 115	S	100	129,00	M 10 x 340	S	50	1440,00	M 14 x 140	S	25	265,00
M 8 x 120	S	100	78,00	M 12 x 14	S	100	137,00	M 14 x 150	S	25	345,00
M 8 x 125	S	100	164,00	M 12 x 16	S	100	29,00	M 14 x 160	S	25	600,00
M 8 x 130	S	100	102,00	M 12 x 18	S	100	50,00	M 14 x 170	S	25	630,00
M 8 x 135	S	100	174,00	M 12 x 20	S	100	27,00	M 14 x 180	S	25	660,00
M 8 x 140	S	100	114,00	M 12 x 22	S	100	46,00	M 14 x 190	S	25	680,00
M 8 x 145	S	100	300,00	M 12 x 25	S	100	23,50	M 14 x 200	S	25	700,00
M 8 x 150	S	100	192,00	M 12 x 30	S	100	23,40	M 14 x 210	S	25	1060,00
M 8 x 155	S	100	330,00	M 12 x 35	S	100	24,70	M 14 x 220	S	25	850,00
M 8 x 160	S	100	242,00	M 12 x 40	S	100	26,90	M 14 x 230	S	25	1100,00
M 8 x 165	S	100	355,00	M 12 x 45	S	100	29,00	M 14 x 240	S	25	880,00
M 8 x 170	S	100	375,00	M 12 x 50	S	100	29,50	M 14 x 250	S	25	1160,00
M 8 x 180	S	100	335,00	M 12 x 55	S	100	33,50	M 14 x 260	S	25	920,00
M 8 x 190	S	100	440,00	M 12 x 60	S	100	35,00	M 14 x 270	S	25	1220,00
M 8 x 200	S	100	355,00	M 12 x 65	S	50	39,00	M 14 x 280	S	25	970,00
M 8 x 210	S	100	490,00	M 12 x 70	S	50	40,00	M 14 x 290	S	25	1410,00
M 8 x 220	S	100	510,00	M 12 x 75	S	50	42,00	M 14 x 300	S	25	1040,00
M 8 x 230	S	100	550,00	M 12 x 80	S	50	45,00	M 16 x 16	S	50	325,00
M 8 x 240	S	100	590,00	M 12 x 85	S	50	94,00	M 16 x 18	S	50	325,00
M 8 x 250	S	100	610,00	M 12 x 90	S	50	53,00	M 16 x 20	S	50	99,00
M 8 x 260	S	100	650,00	M 12 x 95	S	50	147,00	M 16 x 25	S	50	73,00
M 8 x 270	S	100	670,00	M 12 x 100	S	50	66,00	M 16 x 30	S	50	46,50
M 8 x 280	S	100	690,00	M 12 x 105	S	50	158,00	M 16 x 35	S	50	47,00
M 8 x 300	S	100	730,00	M 12 x 110	S	50	75,00	M 16 x 40	S	50	51,00
M 10 x 10	S	200	104,00	M 12 x 115	S	50	174,00	M 16 x 45	S	50	54,00
M 10 x 12	S	200	45,50	M 12 x 120	S	50	88,00	M 16 x 50	S	50	58,00
M 10 x 14	S	200	35,50	M 12 x 125	S	50	195,00	M 16 x 55	S	50	62,00
M 10 x 16	S	200	23,20	M 12 x 130	S	50	125,00	M 16 x 60	S	50	66,00
M 10 x 18	S	200	47,50	M 12 x 135	S	50	215,00	M 16 x 65	S	25	75,00
M 10 x 20	S	200	14,50	M 12 x 140	S	50	148,00	M 16 x 70	S	25	78,00
M 10 x 22	S	200	28,50	M 12 x 145	S	50	241,00	M 16 x 75	S	25	83,00
M 10 x 25	S	200	14,90	M 12 x 150	S	50	190,00	M 16 x 80	S	25	85,00
M 10 x 28	S	200	32,50	M 12 x 155	S	50	260,00	M 16 x 85	S	25	216,00
M 10 x 30	S	200	16,10	M 12 x 160	S	50	229,00	M 16 x 90	S	25	101,00

Abmessungen	VE	Stück	€/100/Obf.	Abmessungen	VE	Stück	€/100/Obf.	Abmessungen	VE	Stück	€/100/Obf.
M 16 x 95	S	25	171,00	M 18 x 300	S	1	1490,00	M 22 x 110	S	1	950,00
M 16 x 100	S	25	111,00	M 18 x 320	S	1	1860,00	M 22 x 120	S	1	970,00
M 16 x 110	S	25	146,00	M 18 x 350	S	1	2600,00	M 22 x 130	S	1	1000,00
M 16 x 120	S	25	160,00	M 20 x 20	S	25	400,00	M 22 x 140	S	1	1040,00
M 16 x 130	S	25	183,00	M 20 x 25	S	25	400,00	M 22 x 150	S	1	1070,00
M 16 x 140	S	25	236,00	M 20 x 30	S	25	184,00	M 22 x 160	S	1	1090,00
M 16 x 150	S	25	305,00	M 20 x 35	S	25	184,00	M 22 x 170	S	1	1300,00
M 16 x 160	S	25	320,00	M 20 x 40	S	25	105,00	M 22 x 180	S	1	1180,00
M 16 x 170	S	25	420,00	M 20 x 45	S	25	109,00	M 22 x 190	S	1	1400,00
M 16 x 180	S	25	375,00	M 20 x 50	S	25	112,00	M 22 x 200	S	1	1270,00
M 16 x 190	S	25	600,00	M 20 x 55	S	25	119,00	M 22 x 210	S	1	1880,00
M 16 x 200	S	25	450,00	M 20 x 60	S	25	119,00	M 22 x 220	S	1	1500,00
M 16 x 210	S	25	720,00	M 20 x 65	S	25	131,00	M 22 x 240	S	1	1600,00
M 16 x 220	S	25	540,00	M 20 x 70	S	25	131,00	M 22 x 250	S	1	2100,00
M 16 x 230	S	25	810,00	M 20 x 75	S	25	138,00	M 22 x 260	S	1	1680,00
M 16 x 240	S	25	690,00	M 20 x 80	S	25	140,00	M 22 x 280	S	1	1770,00
M 16 x 250	S	25	750,00	M 20 x 85	S	25	1050,00	M 22 x 300	S	1	1890,00
M 16 x 260	S	25	750,00	M 20 x 90	S	25	171,00	M 24 x 30	S	25	1250,00
M 16 x 270	S	25	960,00	M 20 x 95	S	25	1100,00	M 24 x 35	S	25	1250,00
M 16 x 280	S	25	810,00	M 20 x 100	S	25	182,00	M 24 x 40	S	25	720,00
M 16 x 290	S	25	980,00	M 20 x 110	S	25	197,00	M 24 x 45	S	25	720,00
M 16 x 300	S	25	950,00	M 20 x 120	S	25	212,00	M 24 x 50	S	25	260,00
M 16 x 310	S	10	1750,00	M 20 x 130	S	25	310,00	M 24 x 55	S	25	290,00
M 16 x 320	S	10	1600,00	M 20 x 140	S	25	455,00	M 24 x 60	S	25	290,00
M 16 x 330	S	10	2050,00	M 20 x 150	S	25	530,00	M 24 x 65	S	25	310,00
M 16 x 340	S	10	1880,00	M 20 x 160	S	10	530,00	M 24 x 70	S	25	310,00
M 16 x 350	S	10	2440,00	M 20 x 170	S	10	650,00	M 24 x 75	S	25	315,00
M 16 x 360	S	10	2220,00	M 20 x 180	S	10	650,00	M 24 x 80	S	25	315,00
M 16 x 370	S	10	2750,00	M 20 x 190	S	10	770,00	M 24 x 85	S	10	1060,00
M 16 x 380	S	10	2480,00	M 20 x 200	S	1	770,00	M 24 x 90	S	10	380,00
M 16 x 390	S	10	2950,00	M 20 x 210	S	1	870,00	M 24 x 95	S	10	1100,00
M 16 x 400	S	10	2650,00	M 20 x 220	S	1	870,00	M 24 x 100	S	10	395,00
M 16 x 410	S	10	3200,00	M 20 x 230	S	1	1020,00	M 24 x 105	S	10	1060,00
M 16 x 420	S	10	2950,00	M 20 x 240	S	1	1020,00	M 24 x 110	S	10	460,00
M 16 x 440	S	10	3100,00	M 20 x 250	S	1	1080,00	M 24 x 120	S	10	495,00
M 16 x 460	S	10	3400,00	M 20 x 260	S	1	1080,00	M 24 x 125	S	10	1060,00
M 16 x 480	S	10	3550,00	M 20 x 270	S	1	1220,00	M 24 x 130	S	1	570,00
M 16 x 500	S	10	4250,00	M 20 x 280	S	1	1220,00	M 24 x 140	S	1	730,00
M 16 x 520	S	10	4450,00	M 20 x 290	S	1	1330,00	M 24 x 150	S	1	910,00
M 16 x 540	S	10	4700,00	M 20 x 300	S	1	1330,00	M 24 x 160	S	1	800,00
M 16 x 560	S	10	5100,00	M 20 x 310	S	1	1520,00	M 24 x 170	S	1	860,00
M 16 x 580	S	10	5300,00	M 20 x 320	S	1	1160,00	M 24 x 180	S	1	890,00
M 16 x 600	S	10	5700,00	M 20 x 330	S	1	1490,00	M 24 x 190	S	1	950,00
M 18 x 30	S	50	242,00	M 20 x 340	S	1	1510,00	M 24 x 200	S	1	970,00
M 18 x 35	S	50	242,00	M 20 x 350	S	1	1770,00	M 24 x 210	S	1	1660,00
M 18 x 40	S	50	212,00	M 20 x 360	S	1	1610,00	M 24 x 220	S	1	1330,00
M 18 x 45	S	50	226,00	M 20 x 370	S	1	2050,00	M 24 x 230	S	1	1760,00
M 18 x 50	S	50	230,00	M 20 x 380	S	1	1860,00	M 24 x 240	S	1	1420,00
M 18 x 55	S	25	239,00	M 20 x 390	S	1	2400,00	M 24 x 250	S	1	1870,00
M 18 x 60	S	25	244,00	M 20 x 400	S	1	2180,00	M 24 x 260	S	1	1500,00
M 18 x 65	S	25	270,00	M 20 x 410	S	1	2250,00	M 24 x 270	S	1	2010,00
M 18 x 70	S	25	280,00	M 20 x 420	S	1	2250,00	M 24 x 280	S	1	1610,00
M 18 x 75	S	25	290,00	M 20 x 440	S	1	2410,00	M 24 x 290	S	1	2190,00
M 18 x 80	S	25	295,00	M 20 x 450	S	1	2850,00	M 24 x 300	S	1	1750,00
M 18 x 85	S	25	320,00	M 20 x 460	S	1	2600,00	M 24 x 310	S	1	3000,00
M 18 x 90	S	25	320,00	M 20 x 480	S	1	2750,00	M 24 x 320	S	1	2600,00
M 18 x 100	S	25	355,00	M 20 x 500	S	1	2900,00	M 24 x 330	S	1	3050,00
M 18 x 110	S	25	465,00	M 20 x 520	S	1	3850,00	M 24 x 340	S	1	2650,00
M 18 x 120	S	25	510,00	M 20 x 540	S	1	4000,00	M 24 x 350	S	1	3100,00
M 18 x 130	S	25	540,00	M 20 x 560	S	1	4150,00	M 24 x 360	S	1	3000,00
M 18 x 140	S	25	630,00	M 20 x 580	S	1	4350,00	M 24 x 370	S	1	3200,00
M 18 x 150	S	25	740,00	M 20 x 600	S	1	4600,00	M 24 x 380	S	1	3200,00
M 18 x 160	S	25	800,00	M 22 x 35	S	25	630,00	M 24 x 390	S	1	3400,00
M 18 x 170	S	25	840,00	M 22 x 40	S	25	630,00	M 24 x 400	S	1	3400,00
M 18 x 180	S	25	880,00	M 22 x 45	S	25	630,00	M 24 x 410	S	1	3650,00
M 18 x 190	S	25	920,00	M 22 x 50	S	25	790,00	M 24 x 420	S	1	3650,00
M 18 x 200	S	1	1090,00	M 22 x 55	S	25	790,00	M 24 x 430	S	1	3900,00
M 18 x 210	S	1	1420,00	M 22 x 60	S	25	790,00	M 24 x 440	S	1	3900,00
M 18 x 220	S	1	1160,00	M 22 x 65	S	25	820,00	M 24 x 450	S	1	4150,00
M 18 x 230	S	1	1590,00	M 22 x 70	S	25	820,00	M 24 x 460	S	1	4150,00
M 18 x 240	S	1	1220,00	M 22 x 75	S	25	850,00	M 24 x 470	S	1	4400,00
M 18 x 250	S	1	1700,00	M 22 x 80	S	25	850,00	M 24 x 480	S	1	4400,00
M 18 x 260	S	1	1300,00	M 22 x 85	S	25	850,00	M 24 x 490	S	1	4700,00
M 18 x 270	S	1	1820,00	M 22 x 90	S	25	910,00	M 24 x 500	S	1	4700,00
M 18 x 280	S	1	1390,00	M 22 x 100	S	10	930,00	M 24 x 520	S	1	6400,00

Abmessungen	VE	Stück	€/100/Obf.	Abmessungen	VE	Stück	€/100/Obf.	Abmessungen	VE	Stück	€/100/Obf.
M 24 x 530	S	1	6700,00	M 30 x 350	S	1	3850,00	M 36 x 420	S	1	17500,00
M 24 x 540	S	1	6900,00	M 30 x 360	S	1	4000,00	M 36 x 430	S	1	17800,00
M 24 x 560	S	1	7200,00	M 30 x 370	S	1	5400,00	M 36 x 440	S	1	17800,00
M 24 x 580	S	1	7500,00	M 30 x 380	S	1	5400,00	M 36 x 500	S	1	18800,00
M 24 x 600	S	1	7700,00	M 30 x 390	S	1	5900,00	M 36 x 560	S	1	19800,00
M 27 x 40	S	10	1550,00	M 30 x 400	S	1	5900,00	M 36 x 600	S	1	20500,00
M 27 x 45	S	10	1550,00	M 30 x 420	S	1	5900,00	M 42 x 70	S	1	3600,00
M 27 x 50	S	10	1080,00	M 30 x 430	S	1	5900,00	M 42 x 80	S	1	3600,00
M 27 x 55	S	10	1080,00	M 30 x 440	S	1	6400,00	M 42 x 90	S	1	3600,00
M 27 x 60	S	10	1080,00	M 30 x 450	S	1	6400,00	M 42 x 100	S	1	3700,00
M 27 x 65	S	10	1120,00	M 30 x 460	S	1	7500,00	M 42 x 110	S	1	3700,00
M 27 x 70	S	10	1120,00	M 30 x 470	S	1	7900,00	M 42 x 120	S	1	3900,00
M 27 x 75	S	10	1170,00	M 30 x 480	S	1	7900,00	M 42 x 130	S	1	4050,00
M 27 x 80	S	10	1170,00	M 30 x 490	S	1	8400,00	M 42 x 140	S	1	4000,00
M 27 x 85	S	10	1220,00	M 30 x 500	S	1	8400,00	M 42 x 150	S	1	4500,00
M 27 x 90	S	10	1220,00	M 30 x 540	S	1	15500,00	M 42 x 160	S	1	4200,00
M 27 x 100	S	10	1270,00	M 30 x 700	S	1	18400,00	M 42 x 170	S	1	4850,00
M 27 x 110	S	10	1310,00	M 33 x 50	S	1	3900,00	M 42 x 180	S	1	4450,00
M 27 x 120	S	10	1440,00	M 33 x 55	S	1	3900,00	M 42 x 190	S	1	5400,00
M 27 x 130	S	1	1500,00	M 33 x 60	S	1	1600,00	M 42 x 200	S	1	5100,00
M 27 x 140	S	1	1560,00	M 33 x 65	S	1	1600,00	M 42 x 210	S	1	5800,00
M 27 x 150	S	1	1620,00	M 33 x 70	S	1	1600,00	M 42 x 220	S	1	5800,00
M 27 x 160	S	1	1660,00	M 33 x 80	S	1	1600,00	M 42 x 240	S	1	9600,00
M 27 x 170	S	1	1910,00	M 33 x 90	S	1	1690,00	M 42 x 260	S	1	10300,00
M 27 x 180	S	1	1780,00	M 33 x 100	S	1	1820,00	M 42 x 270	S	1	20200,00
M 27 x 190	S	1	2020,00	M 33 x 110	S	1	1900,00	M 42 x 280	S	1	10900,00
M 27 x 200	S	1	1860,00	M 33 x 120	S	1	2040,00	M 42 x 300	S	1	11800,00
M 27 x 210	S	1	2800,00	M 33 x 130	S	1	2110,00	M 42 x 350	S	1	22600,00
M 27 x 220	S	1	2010,00	M 33 x 140	S	1	2230,00	M 42 x 400	S	1	23900,00
M 27 x 230	S	1	3000,00	M 33 x 150	S	1	2360,00	M 42 x 500	S	1	27100,00
M 27 x 240	S	1	2170,00	M 33 x 160	S	1	2410,00	M 42 x 560	S	1	28900,00
M 27 x 250	S	1	3200,00	M 33 x 180	S	1	2650,00	M 48 x 80	S	1	6600,00
M 27 x 260	S	1	2310,00	M 33 x 190	S	1	3800,00	M 48 x 90	S	1	6600,00
M 27 x 270	S	1	3450,00	M 33 x 200	S	1	2850,00	M 48 x 100	S	1	6600,00
M 27 x 280	S	1	2460,00	M 36 x 50	S	1	2120,00	M 48 x 110	S	1	7000,00
M 27 x 300	S	1	2650,00	M 36 x 55	S	1	2120,00	M 48 x 120	S	1	7300,00
M 27 x 320	S	1	5500,00	M 36 x 60	S	1	2120,00	M 48 x 130	S	1	7600,00
M 30 x 35	S	10	1990,00	M 36 x 65	S	1	2120,00	M 48 x 140	S	1	8000,00
M 30 x 40	S	10	1990,00	M 36 x 70	S	1	2080,00	M 48 x 150	S	1	8500,00
M 30 x 45	S	10	1990,00	M 36 x 75	S	1	2080,00	M 48 x 160	S	1	8900,00
M 30 x 50	S	10	1310,00	M 36 x 80	S	1	2080,00	M 48 x 170	S	1	9700,00
M 30 x 55	S	10	1310,00	M 36 x 85	S	1	2140,00	M 48 x 180	S	1	9700,00
M 30 x 60	S	10	1310,00	M 36 x 90	S	1	2140,00	M 48 x 190	S	1	10400,00
M 30 x 65	S	10	1340,00	M 36 x 95	S	1	2200,00	M 48 x 200	S	1	10400,00
M 30 x 70	S	10	1370,00	M 36 x 100	S	1	2200,00	M 48 x 210	S	1	13900,00
M 30 x 75	S	10	1430,00	M 36 x 110	S	1	2250,00	M 48 x 220	S	1	13900,00
M 30 x 80	S	10	1430,00	M 36 x 120	S	1	2360,00	M 48 x 240	S	1	15100,00
M 30 x 85	S	1	1480,00	M 36 x 130	S	1	2430,00	M 48 x 260	S	1	16300,00
M 30 x 90	S	1	1480,00	M 36 x 140	S	1	2550,00	M 48 x 270	S	1	25000,00
M 30 x 95	S	1	1480,00	M 36 x 150	S	1	2650,00	M 48 x 280	S	1	17400,00
M 30 x 100	S	1	1540,00	M 36 x 160	S	1	2700,00	M 48 x 300	S	1	18000,00
M 30 x 110	S	1	1590,00	M 36 x 170	S	1	3100,00	M 56 x 120	S	1	15800,00
M 30 x 120	S	1	1650,00	M 36 x 180	S	1	2950,00	M 56 x 130	S	1	17200,00
M 30 x 130	S	1	1710,00	M 36 x 190	S	1	3350,00	M 56 x 140	S	1	17900,00
M 30 x 140	S	1	1760,00	M 36 x 200	S	1	3150,00	M 56 x 150	S	1	19100,00
M 30 x 150	S	1	1850,00	M 36 x 210	S	1	3700,00	M 56 x 160	S	1	19900,00
M 30 x 160	S	1	1930,00	M 36 x 220	S	1	3350,00	M 56 x 180	S	1	20600,00
M 30 x 170	S	1	1990,00	M 36 x 230	S	1	3900,00	M 56 x 200	S	1	22000,00
M 30 x 180	S	1	2050,00	M 36 x 240	S	1	3500,00	M 56 x 210	S	1	24700,00
M 30 x 190	S	1	2130,00	M 36 x 250	S	1	4100,00	M 56 x 220	S	1	22400,00
M 30 x 200	S	1	2220,00	M 36 x 260	S	1	3700,00	M 56 x 230	S	1	26000,00
M 30 x 210	S	1	2390,00	M 36 x 270	S	1	4350,00	M 56 x 260	S	1	24400,00
M 30 x 220	S	1	2390,00	M 36 x 280	S	1	3950,00	M 56 x 280	S	1	25700,00
M 30 x 230	S	1	2500,00	M 36 x 290	S	1	4750,00	M 56 x 300	S	1	27700,00
M 30 x 240	S	1	2500,00	M 36 x 300	S	1	4300,00				
M 30 x 250	S	1	2650,00	M 36 x 310	S	1	6400,00				
M 30 x 260	S	1	2650,00	M 36 x 320	S	1	5800,00				
M 30 x 270	S	1	2800,00	M 36 x 330	S	1	6900,00				
M 30 x 280	S	1	2800,00	M 36 x 340	S	1	6300,00				
M 30 x 290	S	1	3800,00	M 36 x 350	S	1	7600,00				
M 30 x 300	S	1	3000,00	M 36 x 360	S	1	6900,00				
M 30 x 310	S	1	3800,00	M 36 x 370	S	1	9400,00				
M 30 x 320	S	1	3400,00	M 36 x 380	S	1	8500,00				
M 30 x 330	S	1	3850,00	M 36 x 390	S	1	9900,00				
M 30 x 340	S	1	3600,00	M 36 x 400	S	1	9000,00				

Abmessungen	VE Stück	€/100/Obf.
ISO	04762.810	
4762	8.8	galvanisch verzinkt



Zylinderschrauben mit Innensechskant

Maße → TI-12 Anziehmomente → TI-244
 Werkstoffeigensch. → TI-232 Normumstellung → TI-6
 Korrosionsschutz → TI-228

Rostfrei → S. 547

ISO 4762 → ersetzt DIN 912 (austauschbar)

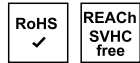

M 3	x	4	S	500	33,50 gal Zn
M 3	x	5	S	500	33,50 gal Zn
M 3	x	6	S	500	9,40 gal Zn
M 3	x	8	S	500	6,60 gal Zn
M 3	x	10	S	500	5,60 gal Zn
M 3	x	12	S	500	5,80 gal Zn
M 3	x	14	S	500	9,40 gal Zn
M 3	x	16	S	500	6,20 gal Zn
M 3	x	18	S	500	6,30 gal Zn
M 3	x	20	S	500	6,60 gal Zn
M 3	x	22	S	500	12,10 gal Zn
M 3	x	25	S	500	7,10 gal Zn
M 3	x	30	S	500	7,90 gal Zn
M 3	x	35	S	500	30,00 gal Zn
M 3	x	40	S	500	31,50 gal Zn
M 3	x	45	S	500	80,00 gal Zn
M 3	x	50	S	500	89,00 gal Zn
M 4	x	4	S	500	106,00 gal Zn
M 4	x	5	S	500	20,00 gal Zn
M 4	x	6	S	500	11,60 gal Zn
M 4	x	6	K	100	15,20 gal Zn
M 4	x	8	S	500	6,80 gal Zn
M 4	x	8	K	100	10,50 gal Zn
M 4	x	10	S	500	5,30 gal Zn
M 4	x	10	K	100	8,90 gal Zn
M 4	x	12	S	500	5,50 gal Zn
M 4	x	12	K	100	9,20 gal Zn
M 4	x	14	S	500	8,80 gal Zn
M 4	x	16	S	500	5,40 gal Zn
M 4	x	16	K	100	9,10 gal Zn
M 4	x	18	S	500	5,70 gal Zn
M 4	x	20	S	500	5,90 gal Zn
M 4	x	20	K	100	9,50 gal Zn
M 4	x	22	S	500	10,90 gal Zn
M 4	x	25	S	500	6,60 gal Zn
M 4	x	25	K	100	10,30 gal Zn
M 4	x	28	S	500	12,80 gal Zn
M 4	x	30	S	500	7,20 gal Zn
M 4	x	30	K	100	10,90 gal Zn
M 4	x	35	S	500	8,60 gal Zn
M 4	x	35	K	100	12,30 gal Zn
M 4	x	40	S	500	9,20 gal Zn
M 4	x	40	K	100	12,80 gal Zn
M 4	x	45	S	500	19,20 gal Zn
M 4	x	50	S	500	21,20 gal Zn
M 4	x	55	S	200	29,00 gal Zn
M 4	x	60	S	200	29,00 gal Zn
M 4	x	65	S	200	44,00 gal Zn
M 4	x	70	S	200	44,00 gal Zn
M 4	x	75	S	200	76,00 gal Zn
M 4	x	80	S	200	86,00 gal Zn
M 4	x	85	S	200	310,00 gal Zn
M 4	x	90	S	200	340,00 gal Zn

M 4	x	95	S	200	370,00 gal Zn
M 4	x	100	S	200	400,00 gal Zn
M 4	x	110	S	200	430,00 gal Zn
M 4	x	120	S	200	495,00 gal Zn
M 5	x	5	S	500	107,00 gal Zn
M 5	x	6	S	500	12,40 gal Zn
M 5	x	6	K	100	16,10 gal Zn
M 5	x	8	S	500	9,80 gal Zn
M 5	x	8	K	100	13,50 gal Zn
M 5	x	10	S	500	5,30 gal Zn
M 5	x	10	K	100	8,90 gal Zn
M 5	x	12	S	500	5,40 gal Zn
M 5	x	12	K	100	9,10 gal Zn
M 5	x	14	S	500	9,10 gal Zn
M 5	x	14	K	100	12,80 gal Zn
M 5	x	16	S	500	5,40 gal Zn
M 5	x	16	K	100	9,10 gal Zn
M 5	x	18	S	500	5,70 gal Zn
M 5	x	18	K	100	9,40 gal Zn
M 5	x	20	S	500	5,90 gal Zn
M 5	x	20	K	100	9,50 gal Zn
M 5	x	22	S	500	10,30 gal Zn
M 5	x	22	K	100	14,00 gal Zn
M 5	x	25	S	500	6,30 gal Zn
M 5	x	25	K	100	9,90 gal Zn
M 5	x	30	S	500	7,70 gal Zn
M 5	x	30	K	100	11,30 gal Zn
M 5	x	35	S	200	8,20 gal Zn
M 5	x	40	S	200	8,70 gal Zn
M 5	x	45	S	200	14,70 gal Zn
M 5	x	50	S	200	20,40 gal Zn
M 5	x	55	S	200	25,00 gal Zn
M 5	x	60	S	200	26,50 gal Zn
M 5	x	65	S	200	37,00 gal Zn
M 5	x	70	S	200	38,00 gal Zn
M 5	x	75	S	200	47,50 gal Zn
M 5	x	80	S	200	50,00 gal Zn
M 5	x	85	S	200	69,00 gal Zn
M 5	x	90	S	200	63,00 gal Zn
M 5	x	95	S	200	80,00 gal Zn
M 5	x	100	S	200	68,00 gal Zn
M 5	x	110	S	200	76,00 gal Zn
M 5	x	115	S	100	200,00 gal Zn
M 5	x	120	S	100	83,00 gal Zn
M 5	x	125	S	100	340,00 gal Zn
M 5	x	130	S	100	310,00 gal Zn
M 5	x	140	S	100	520,00 gal Zn
M 5	x	150	S	100	660,00 gal Zn
M 5	x	160	S	100	680,00 gal Zn
M 5	x	170	S	100	720,00 gal Zn
M 5	x	180	S	100	750,00 gal Zn
M 5	x	200	S	100	980,00 gal Zn
M 6	x	6	S	500	32,00 gal Zn
M 6	x	6	K	100	36,00 gal Zn
M 6	x	8	S	500	11,50 gal Zn
M 6	x	8	K	100	15,10 gal Zn
M 6	x	10	S	500	5,80 gal Zn
M 6	x	10	K	100	9,40 gal Zn
M 6	x	12	S	500	6,10 gal Zn
M 6	x	12	K	100	9,70 gal Zn
M 6	x	14	S	500	8,90 gal Zn
M 6	x	14	K	100	12,60 gal Zn
M 6	x	16	S	500	5,90 gal Zn
M 6	x	16	K	100	9,50 gal Zn
M 6	x	18	S	500	6,30 gal Zn
M 6	x	18	K	100	9,90 gal Zn
M 6	x	20	S	500	6,40 gal Zn
M 6	x	20	K	100	10,10 gal Zn
M 6	x	22	S	500	11,00 gal Zn
M 6	x	22	K	100	14,60 gal Zn
M 6	x	25	S	500	6,80 gal Zn
M 6	x	25	K	100	10,40 gal Zn
M 6	x	28	S	500	16,00 gal Zn
M 6	x	28	K	100	19,60 gal Zn
M 6	x	30	S	500	7,70 gal Zn

M 6	x	30	K	100	11,50 gal Zn
M 6	x	35	S	200	8,50 gal Zn
M 6	x	40	S	200	9,40 gal Zn
M 6	x	45	S	200	12,00 gal Zn
M 6	x	50	S	200	12,60 gal Zn
M 6	x	55	S	200	19,70 gal Zn
M 6	x	60	S	200	21,00 gal Zn
M 6	x	65	S	200	27,50 gal Zn
M 6	x	70	S	200	28,50 gal Zn
M 6	x	75	S	200	38,00 gal Zn
M 6	x	80	S	200	39,50 gal Zn
M 6	x	85	S	200	50,00 gal Zn
M 6	x	90	S	200	46,00 gal Zn
M 6	x	95	S	200	112,00 gal Zn
M 6	x	100	S	200	54,00 gal Zn
M 6	x	105	S	100	112,00 gal Zn
M 6	x	110	S	100	77,00 gal Zn
M 6	x	115	S	100	141,00 gal Zn
M 6	x	120	S	100	88,00 gal Zn
M 6	x	125	S	100	190,00 gal Zn
M 6	x	130	S	100	138,00 gal Zn
M 6	x	140	S	100	184,00 gal Zn
M 6	x	145	S	100	410,00 gal Zn
M 6	x	150	S	100	216,00 gal Zn
M 6	x	160	S	100	600,00 gal Zn
M 6	x	170	S	100	740,00 gal Zn
M 6	x	180	S	100	810,00 gal Zn
M 6	x	200	S	100	1080,00 gal Zn
M 6	x	210	S	100	1140,00 gal Zn
M 6	x	220	S	100	1190,00 gal Zn
M 6	x	230	S	100	1290,00 gal Zn
M 6	x	280	S	100	1450,00 gal Zn
M 6	x	300	S	100	1620,00 gal Zn
M 8	x	8	S	200	30,00 gal Zn
M 8	x	10	S	200	14,10 gal Zn
M 8	x	12	S	200	14,70 gal Zn
M 8	x	14	S	200	15,50 gal Zn
M 8	x	16	S	200	10,00 gal Zn
M 8	x	18	S	200	10,60 gal Zn
M 8	x	20	S	200	10,30 gal Zn
M 8	x	22	S	200	17,50 gal Zn
M 8	x	25	S	200	11,30 gal Zn
M 8	x	30	S	200	12,10 gal Zn
M 8	x	35	S	200	13,20 gal Zn
M 8	x	40	S	200	15,00 gal Zn
M 8	x	45	S	200	15,50 gal Zn
M 8	x	50	S	200	17,30 gal Zn
M 8	x	55	S	200	20,00 gal Zn
M 8	x	60	S	200	22,00 gal Zn
M 8	x	65	S	200	32,00 gal Zn
M 8	x	70	S	200	33,00 gal Zn
M 8	x	75	S	200	39,50 gal Zn
M 8	x	80	S	200	49,00 gal Zn
M 8	x	85	S	100	75,00 gal Zn
M 8	x	90	S	100	60,00 gal Zn
M 8	x	95	S	100	85,00 gal Zn
M 8	x	100	S	100	66,00 gal Zn
M 8	x	105	S	100	94,00 gal Zn
M 8	x	110	S	100	78,00 gal Zn
M 8	x	115	S	100	142,00 gal Zn
M 8	x	120	S	100	90,00 gal Zn
M 8	x	125	S	100	176,00 gal Zn
M 8	x	130	S	100	116,00 gal Zn
M 8	x	135	S	100	187,00 gal Zn
M 8	x	140	S	100	128,00 gal Zn
M 8	x	145	S	100	310,00 gal Zn
M 8	x	150	S	100	206,00 gal Zn
M 8	x	160	S	100	260,00 gal Zn
M 8	x	170	S	100	390,00 gal Zn
M 8	x	180	S	100	355,00 gal Zn
M 8	x	190	S	100	460,00 gal Zn
M 8	x	200	S	100	375,00 gal Zn
M 8	x	210	S	100	510,00 gal Zn
M 8	x	220	S	100	550,00 gal Zn
M 8	x	230	S	100	590,00 gal Zn

Abmessungen	VE	Stück	€/100/Obf.	Abmessungen	VE	Stück	€/100/Obf.	Abmessungen	VE	Stück	€/100/Obf.
M 8 x 240	S	100	630,00 gal Zn	M 12 x 130	S	50	155,00 gal Zn	M 16 x 270	S	25	1070,00 gal Zn
M 8 x 250	S	100	650,00 gal Zn	M 12 x 135	S	50	241,00 gal Zn	M 16 x 280	S	25	920,00 gal Zn
M 8 x 260	S	100	650,00 gal Zn	M 12 x 140	S	50	181,00 gal Zn	M 16 x 300	S	25	1070,00 gal Zn
M 8 x 270	S	100	710,00 gal Zn	M 12 x 145	S	50	275,00 gal Zn	M 16 x 320	S	10	1720,00 gal Zn
M 8 x 280	S	100	890,00 gal Zn	M 12 x 150	S	50	223,00 gal Zn	M 16 x 340	S	10	2010,00 gal Zn
M 10 x 10	S	200	108,00 gal Zn	M 12 x 155	S	50	295,00 gal Zn	M 16 x 360	S	10	2360,00 gal Zn
M 10 x 12	S	200	50,00 gal Zn	M 12 x 160	S	50	265,00 gal Zn	M 18 x 30	S	50	270,00 gal Zn
M 10 x 14	S	200	39,50 gal Zn	M 12 x 170	S	50	350,00 gal Zn	M 18 x 35	S	50	270,00 gal Zn
M 10 x 16	S	200	27,00 gal Zn	M 12 x 180	S	50	350,00 gal Zn	M 18 x 40	S	50	242,00 gal Zn
M 10 x 18	S	200	53,00 gal Zn	M 12 x 190	S	50	405,00 gal Zn	M 18 x 45	S	50	260,00 gal Zn
M 10 x 20	S	200	18,40 gal Zn	M 12 x 200	S	50	405,00 gal Zn	M 18 x 50	S	50	265,00 gal Zn
M 10 x 22	S	200	34,00 gal Zn	M 12 x 210	S	25	970,00 gal Zn	M 18 x 55	S	25	275,00 gal Zn
M 10 x 25	S	200	19,30 gal Zn	M 12 x 220	S	25	720,00 gal Zn	M 18 x 60	S	25	285,00 gal Zn
M 10 x 30	S	200	20,90 gal Zn	M 12 x 230	S	25	1040,00 gal Zn	M 18 x 70	S	25	320,00 gal Zn
M 10 x 35	S	100	22,40 gal Zn	M 12 x 240	S	25	800,00 gal Zn	M 18 x 80	S	25	345,00 gal Zn
M 10 x 40	S	100	24,40 gal Zn	M 12 x 250	S	25	1130,00 gal Zn	M 18 x 90	S	25	375,00 gal Zn
M 10 x 45	S	100	27,00 gal Zn	M 12 x 260	S	25	880,00 gal Zn	M 18 x 100	S	25	415,00 gal Zn
M 10 x 50	S	100	29,00 gal Zn	M 12 x 270	S	25	1200,00 gal Zn	M 18 x 110	S	25	530,00 gal Zn
M 10 x 55	S	100	31,00 gal Zn	M 12 x 290	S	25	1430,00 gal Zn	M 18 x 120	S	25	580,00 gal Zn
M 10 x 60	S	100	33,50 gal Zn	M 12 x 300	S	25	1010,00 gal Zn	M 20 x 25	S	25	425,00 gal Zn
M 10 x 65	S	100	36,00 gal Zn	M 14 x 20	S	100	120,00 gal Zn	M 20 x 30	S	25	213,00 gal Zn
M 10 x 70	S	100	37,50 gal Zn	M 14 x 25	S	100	93,00 gal Zn	M 20 x 35	S	25	216,00 gal Zn
M 10 x 75	S	100	44,50 gal Zn	M 14 x 30	S	100	86,00 gal Zn	M 20 x 40	S	25	131,00 gal Zn
M 10 x 80	S	100	46,00 gal Zn	M 14 x 35	S	100	98,00 gal Zn	M 20 x 45	S	25	137,00 gal Zn
M 10 x 85	S	100	62,00 gal Zn	M 14 x 40	S	100	91,00 gal Zn	M 20 x 50	S	25	143,00 gal Zn
M 10 x 90	S	100	63,00 gal Zn	M 14 x 45	S	50	102,00 gal Zn	M 20 x 55	S	25	152,00 gal Zn
M 10 x 95	S	100	142,00 gal Zn	M 14 x 50	S	50	102,00 gal Zn	M 20 x 60	S	25	154,00 gal Zn
M 10 x 100	S	100	69,00 gal Zn	M 14 x 55	S	50	126,00 gal Zn	M 20 x 65	S	25	166,00 gal Zn
M 10 x 110	S	100	78,00 gal Zn	M 14 x 60	S	50	117,00 gal Zn	M 20 x 70	S	25	170,00 gal Zn
M 10 x 115	S	100	166,00 gal Zn	M 14 x 65	S	50	144,00 gal Zn	M 20 x 75	S	25	180,00 gal Zn
M 10 x 120	S	50	93,00 gal Zn	M 14 x 70	S	50	148,00 gal Zn	M 20 x 80	S	25	181,00 gal Zn
M 10 x 125	S	50	187,00 gal Zn	M 14 x 75	S	50	161,00 gal Zn	M 20 x 85	S	25	1090,00 gal Zn
M 10 x 130	S	50	129,00 gal Zn	M 14 x 80	S	50	167,00 gal Zn	M 20 x 90	S	25	217,00 gal Zn
M 10 x 135	S	50	224,00 gal Zn	M 14 x 90	S	50	182,00 gal Zn	M 20 x 100	S	25	232,00 gal Zn
M 10 x 140	S	50	154,00 gal Zn	M 14 x 100	S	50	201,00 gal Zn	M 20 x 110	S	25	270,00 gal Zn
M 10 x 150	S	50	203,00 gal Zn	M 14 x 110	S	50	236,00 gal Zn	M 20 x 120	S	25	295,00 gal Zn
M 10 x 155	S	50	310,00 gal Zn	M 14 x 120	S	50	260,00 gal Zn	M 20 x 130	S	25	395,00 gal Zn
M 10 x 160	S	50	223,00 gal Zn	M 14 x 130	S	50	295,00 gal Zn	M 20 x 140	S	25	550,00 gal Zn
M 10 x 170	S	50	315,00 gal Zn	M 14 x 140	S	25	310,00 gal Zn	M 20 x 150	S	25	620,00 gal Zn
M 10 x 180	S	50	325,00 gal Zn	M 14 x 150	S	25	390,00 gal Zn	M 20 x 160	S	10	640,00 gal Zn
M 10 x 190	S	50	385,00 gal Zn	M 14 x 160	S	25	650,00 gal Zn	M 20 x 170	S	10	770,00 gal Zn
M 10 x 200	S	50	360,00 gal Zn	M 14 x 200	S	25	760,00 gal Zn	M 20 x 180	S	10	770,00 gal Zn
M 10 x 210	S	50	680,00 gal Zn	M 16 x 20	S	50	114,00 gal Zn	M 20 x 190	S	10	890,00 gal Zn
M 10 x 220	S	50	680,00 gal Zn	M 16 x 25	S	50	89,00 gal Zn	M 20 x 200	S	1	900,00 gal Zn
M 10 x 230	S	50	710,00 gal Zn	M 16 x 30	S	50	60,00 gal Zn	M 20 x 210	S	1	1000,00 gal Zn
M 10 x 240	S	50	710,00 gal Zn	M 16 x 35	S	50	62,00 gal Zn	M 20 x 220	S	1	1010,00 gal Zn
M 10 x 250	S	50	870,00 gal Zn	M 16 x 40	S	50	65,00 gal Zn	M 20 x 230	S	1	1160,00 gal Zn
M 10 x 260	S	50	850,00 gal Zn	M 16 x 45	S	50	70,00 gal Zn	M 20 x 240	S	1	1160,00 gal Zn
M 10 x 270	S	50	930,00 gal Zn	M 16 x 50	S	50	76,00 gal Zn	M 20 x 250	S	1	1230,00 gal Zn
M 10 x 280	S	50	930,00 gal Zn	M 16 x 55	S	50	82,00 gal Zn	M 20 x 260	S	1	1230,00 gal Zn
M 10 x 300	S	50	1010,00 gal Zn	M 16 x 60	S	50	86,00 gal Zn	M 20 x 270	S	1	1380,00 gal Zn
M 12 x 14	S	100	143,00 gal Zn	M 16 x 65	S	25	97,00 gal Zn	M 20 x 280	S	1	1390,00 gal Zn
M 12 x 16	S	100	34,00 gal Zn	M 16 x 70	S	25	98,00 gal Zn	M 20 x 300	S	1	1480,00 gal Zn
M 12 x 20	S	100	32,50 gal Zn	M 16 x 75	S	25	109,00 gal Zn	M 20 x 310	S	1	1710,00 gal Zn
M 12 x 22	S	100	54,00 gal Zn	M 16 x 80	S	25	111,00 gal Zn	M 20 x 320	S	1	1720,00 gal Zn
M 12 x 25	S	100	29,00 gal Zn	M 16 x 85	S	25	250,00 gal Zn	M 22 x 50	S	25	850,00 gal Zn
M 12 x 30	S	100	30,50 gal Zn	M 16 x 90	S	25	131,00 gal Zn	M 22 x 80	S	25	930,00 gal Zn
M 12 x 35	S	100	31,50 gal Zn	M 16 x 95	S	25	205,00 gal Zn	M 22 x 100	S	10	1030,00 gal Zn
M 12 x 40	S	100	33,00 gal Zn	M 16 x 100	S	25	144,00 gal Zn	M 24 x 30	S	25	1270,00 gal Zn
M 12 x 45	S	100	35,00 gal Zn	M 16 x 110	S	25	193,00 gal Zn	M 24 x 40	S	25	780,00 gal Zn
M 12 x 50	S	100	38,50 gal Zn	M 16 x 120	S	25	211,00 gal Zn	M 24 x 45	S	25	780,00 gal Zn
M 12 x 55	S	100	42,00 gal Zn	M 16 x 130	S	25	236,00 gal Zn	M 24 x 50	S	25	310,00 gal Zn
M 12 x 60	S	100	45,00 gal Zn	M 16 x 140	S	25	295,00 gal Zn	M 24 x 55	S	25	345,00 gal Zn
M 12 x 65	S	50	51,00 gal Zn	M 16 x 150	S	25	370,00 gal Zn	M 24 x 60	S	25	345,00 gal Zn
M 12 x 70	S	50	53,00 gal Zn	M 16 x 160	S	25	385,00 gal Zn	M 24 x 65	S	25	370,00 gal Zn
M 12 x 75	S	50	56,00 gal Zn	M 16 x 170	S	25	485,00 gal Zn	M 24 x 70	S	25	375,00 gal Zn
M 12 x 80	S	50	57,00 gal Zn	M 16 x 180	S	25	445,00 gal Zn	M 24 x 75	S	25	380,00 gal Zn
M 12 x 85	S	50	118,00 gal Zn	M 16 x 190	S	25	690,00 gal Zn	M 24 x 80	S	25	385,00 gal Zn
M 12 x 90	S	50	69,00 gal Zn	M 16 x 200	S	25	530,00 gal Zn	M 24 x 85	S	10	1130,00 gal Zn
M 12 x 95	S	50	163,00 gal Zn	M 16 x 210	S	25	820,00 gal Zn	M 24 x 90	S	10	455,00 gal Zn
M 12 x 100	S	50	83,00 gal Zn	M 16 x 220	S	25	630,00 gal Zn	M 24 x 100	S	10	475,00 gal Zn
M 12 x 110	S	50	101,00 gal Zn	M 16 x 230	S	25	920,00 gal Zn	M 24 x 110	S	10	580,00 gal Zn
M 12 x 115	S	50	200,00 gal Zn	M 16 x 240	S	25	780,00 gal Zn	M 24 x 120	S	10	620,00 gal Zn
M 12 x 120	S	50	115,00 gal Zn	M 16 x 250	S	25	850,00 gal Zn	M 24 x 130	S	1	710,00 gal Zn
M 12 x 125	S	50	222,00 gal Zn	M 16 x 260	S	25	850,00 gal Zn	M 24 x 140	S	1	870,00 gal Zn

Abmessungen	VE Stück	€/100/Obf.
ISO 04762.428		
4762	8.8	galv. verz. 8 DiSP* + SL**

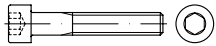

Zylinderschrauben mit Innensechskant

* < M 6 Mindestschichtdicke 5µm,
 **SL = Sealer and Lubrication
 (Versiegelung und Schmierung mit $\mu = 0,12 - 0,18$),
 Korrosionsbeständigkeit NSS: 120h WR, 264h RR

Maße → **TI-12** Anziehmomente → **TI-244**
 Werkstoffeigensch. → **TI-232** Normumstellung → **TI-6**
 Korrosionsschutz → **TI-228**

Rostfrei → **S. 547**

ISO 4762 → ersetzt DIN 912 (austauschbar)



M 3	x	6	S	500	11,30 gal ZnDi
M 3	x	8	S	500	7,90 gal ZnDi
M 3	x	10	S	500	6,70 gal ZnDi
M 3	x	12	S	500	6,90 gal ZnDi
M 3	x	16	S	500	7,40 gal ZnDi
M 3	x	20	S	500	7,90 gal ZnDi
M 4	x	6	S	500	13,80 gal ZnDi
M 4	x	8	S	500	8,20 gal ZnDi
M 4	x	10	S	500	6,30 gal ZnDi
M 4	x	12	S	500	6,60 gal ZnDi
M 4	x	16	S	500	6,40 gal ZnDi
M 4	x	20	S	500	7,00 gal ZnDi
M 4	x	25	S	500	8,00 gal ZnDi
M 4	x	30	S	500	8,50 gal ZnDi
M 4	x	35	S	500	10,40 gal ZnDi
M 4	x	40	S	500	11,10 gal ZnDi
M 4	x	45	S	500	24,00 gal ZnDi
M 4	x	50	S	500	28,50 gal ZnDi
M 5	x	6	S	500	14,90 gal ZnDi
M 5	x	8	S	500	11,70 gal ZnDi
M 5	x	10	S	500	6,40 gal ZnDi
M 5	x	12	S	500	6,50 gal ZnDi
M 5	x	14	S	500	11,10 gal ZnDi
M 5	x	16	S	500	6,40 gal ZnDi
M 5	x	20	S	500	7,00 gal ZnDi
M 5	x	22	S	500	12,90 gal ZnDi
M 5	x	25	S	500	7,50 gal ZnDi
M 5	x	30	S	500	9,20 gal ZnDi
M 5	x	35	S	200	9,90 gal ZnDi
M 5	x	40	S	200	10,50 gal ZnDi
M 5	x	45	S	200	19,20 gal ZnDi
M 5	x	50	S	200	24,70 gal ZnDi
M 5	x	55	S	200	27,00 gal ZnDi
M 6	x	8	S	500	13,80 gal ZnDi
M 6	x	10	S	500	6,90 gal ZnDi
M 6	x	12	S	500	7,30 gal ZnDi
M 6	x	16	S	500	7,00 gal ZnDi
M 6	x	20	S	500	7,70 gal ZnDi
M 6	x	22	S	500	13,50 gal ZnDi
M 6	x	25	S	500	8,10 gal ZnDi
M 6	x	30	S	500	9,30 gal ZnDi
M 6	x	32	S	200	9,80 gal ZnDi
M 6	x	35	S	200	10,30 gal ZnDi
M 6	x	40	S	200	11,20 gal ZnDi
M 6	x	45	S	200	14,40 gal ZnDi
M 6	x	50	S	200	15,20 gal ZnDi
M 6	x	55	S	200	23,60 gal ZnDi
M 6	x	60	S	200	25,50 gal ZnDi
M 6	x	65	S	200	36,50 gal ZnDi

Abmessungen	VE Stück	€/100/Obf.			
M 6	x	70	S	200	37,50 gal ZnDi
M 6	x	75	S	200	49,50 gal ZnDi
M 6	x	80	S	200	51,00 gal ZnDi
M 6	x	85	S	200	47,50 gal ZnDi
M 6	x	100	S	200	64,00 gal ZnDi
M 6	x	105	S	100	154,00 gal ZnDi
M 6	x	110	S	100	62,00 gal ZnDi
M 6	x	130	S	100	76,00 gal ZnDi
M 8	x	10	S	200	16,90 gal ZnDi
M 8	x	12	S	200	17,60 gal ZnDi
M 8	x	16	S	200	12,20 gal ZnDi
M 8	x	20	S	200	12,40 gal ZnDi
M 8	x	25	S	200	13,60 gal ZnDi
M 8	x	30	S	200	14,60 gal ZnDi
M 8	x	35	S	200	15,90 gal ZnDi
M 8	x	40	S	200	18,00 gal ZnDi
M 8	x	45	S	200	18,60 gal ZnDi
M 8	x	50	S	200	20,70 gal ZnDi
M 8	x	55	S	200	31,50 gal ZnDi
M 8	x	60	S	200	26,50 gal ZnDi
M 8	x	65	S	200	45,00 gal ZnDi
M 8	x	70	S	200	47,50 gal ZnDi
M 8	x	80	S	200	67,00 gal ZnDi
M 8	x	85	S	200	59,00 gal ZnDi
M 8	x	90	S	100	75,00 gal ZnDi
M 8	x	100	S	100	90,00 gal ZnDi
M 8	x	110	S	100	104,00 gal ZnDi
M 8	x	200	S	50	200,00 gal ZnDi
M 10	x	12	S	200	60,00 gal ZnDi
M 10	x	16	S	200	32,50 gal ZnDi
M 10	x	20	S	200	22,10 gal ZnDi
M 10	x	25	S	200	23,40 gal ZnDi
M 10	x	30	S	200	25,50 gal ZnDi
M 10	x	35	S	100	27,00 gal ZnDi
M 10	x	40	S	100	30,00 gal ZnDi
M 10	x	45	S	100	33,00 gal ZnDi
M 10	x	50	S	100	34,50 gal ZnDi
M 10	x	55	S	100	37,50 gal ZnDi
M 10	x	60	S	100	40,50 gal ZnDi
M 10	x	65	S	100	39,50 gal ZnDi
M 10	x	70	S	100	60,00 gal ZnDi
M 10	x	80	S	100	72,00 gal ZnDi
M 10	x	90	S	100	90,00 gal ZnDi
M 10	x	100	S	100	97,00 gal ZnDi
M 10	x	110	S	100	108,00 gal ZnDi
M 10	x	120	S	50	128,00 gal ZnDi
M 10	x	135	S	50	152,00 gal ZnDi
M 12	x	20	S	100	48,00 gal ZnDi
M 12	x	25	S	100	35,00 gal ZnDi
M 12	x	30	S	100	37,00 gal ZnDi
M 12	x	35	S	100	37,50 gal ZnDi
M 12	x	40	S	100	40,00 gal ZnDi
M 12	x	45	S	100	42,50 gal ZnDi
M 12	x	50	S	100	106,00 gal ZnDi
M 12	x	60	S	100	54,00 gal ZnDi
M 12	x	65	S	50	61,00 gal ZnDi
M 12	x	70	S	50	64,00 gal ZnDi
M 12	x	75	S	50	67,00 gal ZnDi
M 12	x	80	S	50	68,00 gal ZnDi
M 12	x	90	S	50	83,00 gal ZnDi
M 12	x	100	S	50	106,00 gal ZnDi
M 12	x	110	S	50	105,00 gal ZnDi
M 12	x	120	S	50	128,00 gal ZnDi
M 14	x	30	S	100	79,00 gal ZnDi
M 16	x	25	S	50	103,00 gal ZnDi
M 16	x	30	S	50	73,00 gal ZnDi
M 16	x	35	S	50	74,00 gal ZnDi
M 16	x	40	S	50	78,00 gal ZnDi
M 16	x	45	S	50	87,00 gal ZnDi
M 16	x	50	S	50	92,00 gal ZnDi
M 16	x	55	S	50	105,00 gal ZnDi
M 16	x	60	S	50	135,00 gal ZnDi
M 16	x	65	S	25	118,00 gal ZnDi
M 16	x	70	S	25	120,00 gal ZnDi
M 16	x	75	S	25	137,00 gal ZnDi

Abmessungen	VE Stück	€/100/Obf.			
M 16	x	80	S	25	175,00 gal ZnDi
M 16	x	85	S	25	305,00 gal ZnDi
M 16	x	90	S	25	204,00 gal ZnDi
M 16	x	100	S	25	221,00 gal ZnDi
M 16	x	120	S	25	295,00 gal ZnDi
M 16	x	130	S	25	330,00 gal ZnDi
M 16	x	140	S	25	172,00 gal ZnDi
M 16	x	150	S	25	455,00 gal ZnDi
M 16	x	180	S	25	540,00 gal ZnDi
M 16	x	300	S	25	1070,00 gal ZnDi
M 20	x	35	S	25	136,00 gal ZnDi
M 20	x	50	S	25	172,00 gal ZnDi
M 20	x	55	S	25	147,00 gal ZnDi
M 20	x	60	S	25	185,00 gal ZnDi
M 20	x	65	S	25	199,00 gal ZnDi
M 20	x	70	S	25	195,00 gal ZnDi
M 20	x	100	S	25	236,00 gal ZnDi
M 20	x	120	S	25	345,00 gal ZnDi
M 20	x	150	S	25	760,00 gal ZnDi
M 20	x	180	S	25	770,00 gal ZnDi

Abmessungen	VE Stück	€/100/Obf.
ISO 04762.353		
4762	8.8	f1Zn/TL480h

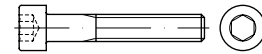

Zylinderschrauben mit Innensechskant

TL = Schmierstoff im Topcoat mit $\mu = 0,09 - 0,14$,
 Korrosionsbeständigkeit NSS: 480h RR,
 Chrom(VI)-frei

Achtung! Gegenüber galv. verzinkt geänderte Anziehdrehmomente.

Maße → **TI-12** Anziehmomente → **TI-245**
 Werkstoffeigensch. → **TI-232** Normumstellung → **TI-6**
 Korrosionsschutz → **TI-230**

Rostfrei → **S. 547**

ISO 4762 → ersetzt DIN 912 (austauschbar)

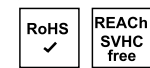

M 6	x	12	S	500	10,30 f1Zn
M 6	x	14	S	500	15,30 f1Zn
M 6	x	16	S	500	9,90 f1Zn
M 6	x	18	S	500	10,70 f1Zn
M 6	x	20	S	500	10,80 f1Zn
M 6	x	22	S	500	18,60 f1Zn
M 6	x	25	S	500	11,50 f1Zn
M 6	x	28	S	500	27,00 f1Zn
M 6	x	30	S	500	13,20 f1Zn
M 6	x	35	S	200	14,30 f1Zn
M 6	x	40	S	200	15,90 f1Zn
M 6	x	45	S	200	20,50 f1Zn
M 6	x	50	S	200	21,40 f1Zn
M 6	x	55	S	200	34,00 f1Zn
M 6	x	60	S	200	36,00 f1Zn
M 6	x	65	S	200	47,00 f1Zn
M 6	x	70	S	200	48,50 f1Zn
M 6	x	75	S	200	65,00 f1Zn
M 6	x	80	S	200	67,00 f1Zn
M 8	x	16	S	200	17,10 f1Zn
M 8	x	20	S	200	17,50 f1Zn
M 8	x	25	S	200	19,20 f1Zn
M 8	x	30	S	200	20,50 f1Zn
M 8	x	35	S	200	22,40 f1Zn
M 8	x	40	S	200	25,50 f1Zn
M 8	x	45	S	200	26,50 f1Zn

Abmessungen	VE	Stück	€/100/Obf.
M 8 x 50	S	200	29,50 flZn
M 8 x 55	S	200	34,00 flZn
M 8 x 60	S	200	38,00 flZn
M 8 x 65	S	200	54,00 flZn
M 8 x 70	S	200	56,00 flZn
M 8 x 75	S	200	68,00 flZn
M 8 x 80	S	200	84,00 flZn
M 8 x 90	S	100	102,00 flZn
M 10 x 20	S	200	31,50 flZn
M 10 x 25	S	200	33,50 flZn
M 10 x 30	S	200	36,00 flZn
M 10 x 35	S	100	38,50 flZn
M 10 x 40	S	100	42,00 flZn
M 10 x 45	S	100	45,50 flZn
M 10 x 50	S	100	49,00 flZn
M 10 x 55	S	100	53,00 flZn
M 10 x 60	S	100	57,00 flZn
M 10 x 65	S	100	62,00 flZn
M 10 x 70	S	100	64,00 flZn
M 10 x 75	S	100	76,00 flZn
M 10 x 80	S	100	78,00 flZn
M 10 x 90	S	100	107,00 flZn
M 12 x 20	S	100	55,00 flZn
M 12 x 25	S	100	49,50 flZn
M 12 x 30	S	100	52,00 flZn
M 12 x 35	S	100	54,00 flZn
M 12 x 40	S	100	56,00 flZn
M 12 x 45	S	100	60,00 flZn
M 12 x 50	S	100	65,00 flZn
M 12 x 55	S	100	72,00 flZn
M 12 x 60	S	100	77,00 flZn
M 12 x 65	S	50	86,00 flZn
M 12 x 70	S	50	90,00 flZn
M 12 x 75	S	50	94,00 flZn
M 12 x 80	S	50	97,00 flZn
M 12 x 90	S	50	118,00 flZn
M 12 x 100	S	50	141,00 flZn
M 16 x 30	S	50	102,00 flZn
M 16 x 35	S	50	105,00 flZn
M 16 x 40	S	50	111,00 flZn
M 16 x 45	S	50	119,00 flZn
M 16 x 50	S	50	129,00 flZn
M 16 x 55	S	50	138,00 flZn
M 16 x 60	S	50	145,00 flZn
M 16 x 65	S	25	164,00 flZn
M 16 x 70	S	25	167,00 flZn
M 16 x 75	S	25	185,00 flZn
M 16 x 80	S	25	188,00 flZn
M 16 x 90	S	25	223,00 flZn
M 16 x 100	S	25	245,00 flZn
M 16 x 110	S	25	335,00 flZn
M 16 x 120	S	25	360,00 flZn
M 20 x 65	S	25	285,00 flZn
M 20 x 70	S	25	290,00 flZn
M 20 x 75	S	25	305,00 flZn
M 20 x 80	S	25	310,00 flZn
M 20 x 90	S	25	375,00 flZn
M 20 x 100	S	25	400,00 flZn
M 20 x 110	S	25	465,00 flZn
M 20 x 120	S	25	495,00 flZn
M 20 x 130	S	25	680,00 flZn
M 20 x 140	S	25	930,00 flZn
M 20 x 150	S	25	1060,00 flZn
M 20 x 160	S	10	1080,00 flZn
M 20 x 170	S	10	1290,00 flZn
M 20 x 180	S	10	1290,00 flZn
M 24 x 75	S	25	650,00 flZn
M 24 x 80	S	25	650,00 flZn
M 24 x 90	S	10	770,00 flZn
M 24 x 100	S	10	810,00 flZn
M 24 x 110	S	10	980,00 flZn
M 24 x 120	S	10	1060,00 flZn
M 24 x 130	S	1	1200,00 flZn

Abmessungen	VE	Stück	€/100/Obf.
M 24 x 140	S	1	1470,00 flZn
M 24 x 150	S	1	1790,00 flZn
M 24 x 160	S	1	1620,00 flZn
M 24 x 170	S	1	1720,00 flZn
M 24 x 180	S	1	1800,00 flZn

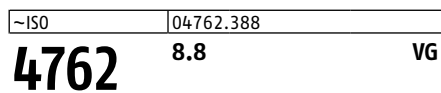

Zylinderschrauben mit Innensechskant, VG = Vollgewinde

Maße → TI-12 Anziehmomente → TI-244
 Werkstoffeigensch. → TI-232 Normumstellung → TI-6

Form und übrige Maße identisch mit ISO 4762

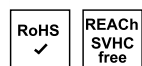

M 5 x 40	S	200	24,60
M 5 x 50	S	200	28,50
M 5 x 60	S	200	31,50
M 5 x 70	S	200	35,00
M 5 x 80	S	200	38,50
M 6 x 40	S	200	27,50
M 6 x 50	S	200	34,00
M 6 x 60	S	200	41,00
M 6 x 70	S	200	46,50
M 6 x 80	S	200	52,00
M 6 x 90	S	200	67,00
M 6 x 100	S	200	138,00
M 8 x 50	S	200	52,00
M 8 x 60	S	200	59,00
M 8 x 70	S	200	73,00
M 8 x 80	S	200	88,00
M 8 x 90	S	100	95,00
M 8 x 100	S	100	111,00
M 10 x 50	S	100	80,00
M 10 x 60	S	100	131,00
M 10 x 70	S	100	152,00
M 10 x 80	S	100	177,00
M 10 x 90	S	100	255,00
M 10 x 100	S	100	295,00
M 12 x 70	S	50	182,00
M 12 x 80	S	50	218,00
M 12 x 90	S	50	295,00
M 12 x 100	S	50	415,00
M 16 x 70	S	25	242,00
M 16 x 80	S	25	295,00
M 16 x 90	S	25	390,00
M 16 x 100	S	25	550,00
M 16 x 120	S	25	660,00

Abmessungen	VE	Stück	€/100/Obf.
~ISO		04762.329	
4762		8.8	VG
		galvanisch verzinkt	

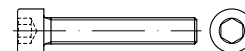

Zylinderschrauben mit Innensechskant, VG = Vollgewinde

Maße → TI-12 Anziehmomente → TI-244
 Werkstoffeigensch. → TI-232 Normumstellung → TI-6
 Korrosionsschutz → TI-228

Form und übrige Maße identisch mit ISO 4762

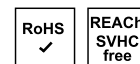

M 4 x 30	S	500	35,50 gal Zn
M 5 x 40	S	200	35,50 gal Zn
M 5 x 45	S	200	38,00 gal Zn
M 5 x 50	S	200	40,50 gal Zn
M 5 x 60	S	200	45,00 gal Zn
M 5 x 70	S	200	50,00 gal Zn
M 5 x 80	S	200	55,00 gal Zn
M 6 x 40	S	200	39,00 gal Zn
M 6 x 50	S	200	48,50 gal Zn
M 6 x 60	S	200	58,00 gal Zn
M 6 x 70	S	200	67,00 gal Zn
M 6 x 75	S	200	91,00 gal Zn
M 6 x 80	S	200	74,00 gal Zn
M 6 x 90	S	200	95,00 gal Zn
M 6 x 100	S	200	197,00 gal Zn
M 8 x 45	S	200	71,00 gal Zn
M 8 x 50	S	200	74,00 gal Zn
M 8 x 60	S	200	85,00 gal Zn
M 8 x 70	S	200	105,00 gal Zn
M 8 x 75	S	200	115,00 gal Zn
M 8 x 80	S	200	125,00 gal Zn
M 8 x 90	S	100	136,00 gal Zn
M 8 x 100	S	100	159,00 gal Zn
M 10 x 50	S	100	114,00 gal Zn
M 10 x 60	S	100	187,00 gal Zn
M 10 x 80	S	100	255,00 gal Zn
M 10 x 90	S	100	360,00 gal Zn
M 10 x 100	S	100	420,00 gal Zn
M 12 x 60	S	100	222,00 gal Zn
M 12 x 80	S	50	315,00 gal Zn
M 12 x 100	S	50	590,00 gal Zn



- ✓ Große Artikelvielfalt
- ✓ Verlässliche Qualität
- ✓ Hohe Lieferbereitschaft

Abmessungen	VE Stück	€/100/Obf.
ISO	04762.100	

4762 10.9



Zylinderschrauben mit Innensechskant

Maße → TI-12 Anziehungsmomente → TI-244
 Werkstoffeigensch. → TI-232 Normumstellung → TI-6

Rostfrei → S. 547

ISO 4762 → ersetzt DIN 912 (austauschbar)

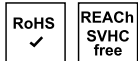

M 3	x	6	S	500	10,10
M 3	x	8	S	500	8,00
M 3	x	10	S	500	6,60
M 3	x	12	S	500	6,90
M 3	x	14	S	500	16,30
M 3	x	16	S	500	7,10
M 3	x	20	S	500	7,60
M 3	x	25	S	500	8,20
M 3	x	30	S	500	9,40
M 4	x	6	S	500	20,20
M 4	x	8	S	500	7,70
M 4	x	10	S	500	7,10
M 4	x	12	S	500	7,20
M 4	x	14	S	500	20,40
M 4	x	16	S	500	7,30
M 4	x	18	S	500	7,60
M 4	x	20	S	500	7,70
M 4	x	22	S	500	20,50
M 4	x	25	S	500	8,00
M 4	x	30	S	500	8,60
M 4	x	35	S	500	8,90
M 4	x	40	S	500	9,70
M 4	x	45	S	500	25,00
M 4	x	50	S	500	26,00
M 4	x	55	S	200	28,50
M 4	x	60	S	200	30,50
M 4	x	65	S	200	31,00
M 4	x	70	S	200	34,50
M 5	x	6	S	500	23,50
M 5	x	8	S	500	16,70
M 5	x	10	S	500	6,20
M 5	x	12	S	500	6,50
M 5	x	14	S	500	17,00
M 5	x	16	S	500	6,60
M 5	x	18	S	500	8,00
M 5	x	20	S	500	6,90
M 5	x	22	S	500	17,70
M 5	x	25	S	500	7,30
M 5	x	30	S	500	7,80
M 5	x	35	S	200	10,40
M 5	x	40	S	200	10,60
M 5	x	45	S	200	18,00
M 5	x	50	S	200	24,20
M 5	x	55	S	200	27,50
M 5	x	60	S	200	29,00
M 5	x	65	S	200	40,00
M 5	x	70	S	200	40,50
M 5	x	75	S	200	64,00
M 5	x	80	S	200	64,00
M 5	x	85	S	200	136,00
M 5	x	90	S	200	70,00
M 5	x	95	S	200	194,00
M 5	x	100	S	200	78,00
M 5	x	110	S	100	181,00

M 5	x	120	S	100	186,00
M 5	x	130	S	100	530,00
M 5	x	135	S	100	640,00
M 5	x	140	S	100	640,00
M 5	x	150	S	100	650,00
M 5	x	160	S	100	660,00
M 5	x	170	S	100	700,00
M 5	x	180	S	100	720,00
M 5	x	190	S	100	830,00
M 5	x	200	S	100	910,00
M 6	x	8	S	500	18,60
M 6	x	10	S	500	6,30
M 6	x	12	S	500	6,50
M 6	x	14	S	500	14,60
M 6	x	16	S	500	6,60
M 6	x	18	S	500	7,40
M 6	x	20	S	500	6,70
M 6	x	22	S	500	18,10
M 6	x	25	S	500	6,90
M 6	x	30	S	500	7,90
M 6	x	35	S	200	8,40
M 6	x	40	S	200	9,40
M 6	x	45	S	200	12,30
M 6	x	50	S	200	14,60
M 6	x	55	S	200	23,20
M 6	x	60	S	200	23,60
M 6	x	65	S	200	30,00
M 6	x	70	S	200	39,50
M 6	x	75	S	200	49,00
M 6	x	80	S	200	54,00
M 6	x	85	S	200	96,00
M 6	x	90	S	200	66,00
M 6	x	95	S	200	115,00
M 6	x	100	S	200	79,00
M 6	x	110	S	100	108,00
M 6	x	120	S	100	117,00
M 6	x	130	S	100	360,00
M 6	x	135	S	100	420,00
M 6	x	140	S	100	380,00
M 6	x	145	S	100	520,00
M 6	x	150	S	100	425,00
M 6	x	160	S	100	720,00
M 6	x	170	S	100	790,00
M 6	x	180	S	100	840,00
M 6	x	190	S	100	1030,00
M 6	x	200	S	100	1140,00
M 6	x	210	S	50	1170,00
M 6	x	220	S	50	1190,00
M 6	x	230	S	50	1290,00
M 6	x	240	S	50	1290,00
M 8	x	10	S	200	15,30
M 8	x	12	S	200	15,30
M 8	x	14	S	200	22,70
M 8	x	16	S	200	10,80
M 8	x	18	S	200	11,70
M 8	x	20	S	200	10,20
M 8	x	22	S	200	23,50
M 8	x	25	S	200	11,00
M 8	x	30	S	200	11,60
M 8	x	35	S	200	12,90
M 8	x	40	S	200	14,30
M 8	x	45	S	200	15,10
M 8	x	50	S	200	16,60
M 8	x	55	S	200	22,50
M 8	x	60	S	200	23,00
M 8	x	65	S	200	31,00
M 8	x	70	S	200	32,00
M 8	x	75	S	200	39,50
M 8	x	80	S	200	52,00
M 8	x	85	S	100	78,00
M 8	x	90	S	100	63,00
M 8	x	95	S	100	90,00
M 8	x	100	S	100	74,00
M 8	x	110	S	100	96,00
M 8	x	120	S	100	97,00

M 8	x	125	S	100	209,00
M 8	x	130	S	100	148,00
M 8	x	135	S	100	224,00
M 8	x	140	S	50	163,00
M 8	x	150	S	50	275,00
M 8	x	160	S	50	310,00
M 8	x	170	S	50	355,00
M 8	x	180	S	50	375,00
M 8	x	190	S	50	590,00
M 8	x	200	S	50	590,00
M 8	x	220	S	50	660,00
M 8	x	240	S	50	830,00
M 8	x	250	S	50	880,00
M 8	x	260	S	50	880,00
M 8	x	270	S	50	950,00
M 8	x	280	S	50	950,00
M 8	x	300	S	50	1000,00
M 10	x	10	S	200	70,00
M 10	x	12	S	200	70,00
M 10	x	16	S	200	31,00
M 10	x	18	S	200	72,00
M 10	x	20	S	200	18,70
M 10	x	22	S	200	53,00
M 10	x	25	S	200	20,30
M 10	x	30	S	200	21,00
M 10	x	35	S	100	22,30
M 10	x	40	S	100	23,20
M 10	x	45	S	100	26,00
M 10	x	50	S	100	27,50
M 10	x	55	S	100	30,00
M 10	x	60	S	100	30,50
M 10	x	65	S	100	32,00
M 10	x	70	S	100	33,00
M 10	x	75	S	100	45,00
M 10	x	80	S	100	46,00
M 10	x	85	S	100	104,00
M 10	x	90	S	100	60,00
M 10	x	95	S	100	113,00
M 10	x	100	S	100	67,00
M 10	x	110	S	50	111,00
M 10	x	115	S	50	229,00
M 10	x	120	S	50	146,00
M 10	x	125	S	50	229,00
M 10	x	130	S	50	172,00
M 10	x	135	S	50	260,00
M 10	x	140	S	50	193,00
M 10	x	145	S	50	380,00
M 10	x	150	S	50	285,00
M 10	x	160	S	50	320,00
M 10	x	170	S	50	375,00
M 10	x	180	S	50	395,00
M 10	x	190	S	50	445,00
M 10	x	200	S	50	445,00
M 10	x	210	S	50	560,00
M 10	x	220	S	50	540,00
M 10	x	230	S	50	650,00
M 10	x	240	S	50	630,00
M 10	x	250	S	50	690,00
M 10	x	260	S	50	710,00
M 10	x	270	S	50	960,00
M 10	x	280	S	50	800,00
M 10	x	290	S	50	1070,00
M 10	x	300	S	50	890,00
M 10	x	310	S	50	2180,00
M 10	x	320	S	50	2350,00
M 10	x	340	S	50	2850,00
M 10	x	350	S	50	3700,00
M 10	x	400	S	50	4900,00
M 12	x	12	S	100	285,00
M 12	x	14	S	100	83,00
M 12	x	16	S	100	83,00
M 12	x	18	S	100	83,00
M 12	x	20	S	100	37,00
M 12	x	25	S	100	31,00
M 12	x	30	S	100	32,50

Abmessungen	VE	Stück	€/100/Obf.	Abmessungen	VE	Stück	€/100/Obf.	Abmessungen	VE	Stück	€/100/Obf.
M 12 x 35	S	100	33,50	M 16 x 50	S	50	75,00	M 20 x 80	S	25	172,00
M 12 x 40	S	100	34,00	M 16 x 55	S	50	78,00	M 20 x 85	S	25	425,00
M 12 x 45	S	100	36,00	M 16 x 60	S	50	81,00	M 20 x 90	S	25	201,00
M 12 x 50	S	100	37,50	M 16 x 65	S	25	93,00	M 20 x 95	S	25	780,00
M 12 x 55	S	100	41,50	M 16 x 70	S	25	93,00	M 20 x 100	S	25	220,00
M 12 x 60	S	100	43,50	M 16 x 75	S	25	106,00	M 20 x 110	S	25	249,00
M 12 x 65	S	50	48,00	M 16 x 80	S	25	106,00	M 20 x 120	S	25	305,00
M 12 x 70	S	50	50,00	M 16 x 85	S	25	375,00	M 20 x 125	S	25	1420,00
M 12 x 75	S	50	53,00	M 16 x 90	S	25	129,00	M 20 x 130	S	25	390,00
M 12 x 80	S	50	54,00	M 16 x 100	S	25	141,00	M 20 x 135	S	25	1450,00
M 12 x 85	S	50	144,00	M 16 x 110	S	25	170,00	M 20 x 140	S	25	570,00
M 12 x 90	S	50	68,00	M 16 x 120	S	25	205,00	M 20 x 145	S	25	1480,00
M 12 x 95	S	50	160,00	M 16 x 125	S	25	450,00	M 20 x 150	S	25	660,00
M 12 x 100	S	50	76,00	M 16 x 130	S	25	290,00	M 20 x 160	S	10	860,00
M 12 x 110	S	50	116,00	M 16 x 140	S	25	375,00	M 20 x 170	S	10	1050,00
M 12 x 120	S	50	130,00	M 16 x 150	S	25	425,00	M 20 x 180	S	10	920,00
M 12 x 125	S	50	265,00	M 16 x 160	S	25	520,00	M 20 x 190	S	10	1020,00
M 12 x 130	S	50	200,00	M 16 x 170	S	25	610,00	M 20 x 200	S	10	860,00
M 12 x 135	S	50	315,00	M 16 x 180	S	25	610,00	M 20 x 210	S	1	1780,00
M 12 x 140	S	50	234,00	M 16 x 190	S	25	760,00	M 20 x 220	S	1	1250,00
M 12 x 150	S	50	305,00	M 16 x 200	S	25	860,00	M 20 x 230	S	1	2000,00
M 12 x 160	S	25	340,00	M 16 x 210	S	25	1360,00	M 20 x 240	S	1	1330,00
M 12 x 170	S	25	365,00	M 16 x 220	S	25	920,00	M 20 x 250	S	1	2140,00
M 12 x 180	S	25	390,00	M 16 x 230	S	25	1410,00	M 20 x 260	S	1	1400,00
M 12 x 190	S	25	770,00	M 16 x 240	S	25	920,00	M 20 x 270	S	1	2290,00
M 12 x 200	S	25	500,00	M 16 x 250	S	25	1500,00	M 20 x 280	S	1	1470,00
M 12 x 210	S	25	740,00	M 16 x 260	S	25	1030,00	M 20 x 290	S	1	2650,00
M 12 x 220	S	25	740,00	M 16 x 270	S	25	1590,00	M 20 x 300	S	1	1630,00
M 12 x 230	S	25	860,00	M 16 x 280	S	25	1130,00	M 20 x 310	S	1	2060,00
M 12 x 240	S	25	840,00	M 16 x 290	S	25	1830,00	M 20 x 320	S	1	2120,00
M 12 x 250	S	25	1240,00	M 16 x 300	S	25	1270,00	M 20 x 330	S	1	2330,00
M 12 x 260	S	25	920,00	M 16 x 320	S	10	1700,00	M 20 x 340	S	1	2400,00
M 12 x 270	S	25	1260,00	M 16 x 330	S	10	1700,00	M 20 x 350	S	1	2600,00
M 12 x 280	S	25	980,00	M 16 x 340	S	10	1840,00	M 20 x 360	S	1	2650,00
M 12 x 290	S	25	1280,00	M 16 x 350	S	10	1860,00	M 20 x 380	S	1	2900,00
M 12 x 300	S	25	1060,00	M 16 x 360	S	10	1980,00	M 20 x 400	S	1	3200,00
M 12 x 310	S	25	2080,00	M 16 x 380	S	10	2800,00	M 22 x 40	S	25	1070,00
M 12 x 320	S	25	2280,00	M 16 x 400	S	10	2950,00	M 22 x 45	S	25	860,00
M 12 x 330	S	25	2700,00	M 18 x 35	S	50	375,00	M 22 x 50	S	25	1070,00
M 12 x 340	S	25	2700,00	M 18 x 40	S	50	315,00	M 22 x 60	S	25	1130,00
M 12 x 360	S	25	3400,00	M 18 x 45	S	50	320,00	M 22 x 65	S	25	1160,00
M 12 x 380	S	25	4050,00	M 18 x 50	S	50	320,00	M 22 x 70	S	25	1160,00
M 12 x 400	S	25	4400,00	M 18 x 55	S	25	320,00	M 22 x 75	S	25	1220,00
M 14 x 20	S	100	197,00	M 18 x 60	S	25	320,00	M 22 x 80	S	25	1220,00
M 14 x 25	S	100	152,00	M 18 x 65	S	25	345,00	M 22 x 90	S	25	1300,00
M 14 x 30	S	100	146,00	M 18 x 70	S	25	345,00	M 22 x 100	S	10	1330,00
M 14 x 35	S	100	151,00	M 18 x 75	S	25	385,00	M 22 x 110	S	10	1360,00
M 14 x 40	S	100	120,00	M 18 x 80	S	25	380,00	M 22 x 120	S	10	1360,00
M 14 x 45	S	50	124,00	M 18 x 90	S	25	385,00	M 22 x 130	S	10	1430,00
M 14 x 50	S	50	131,00	M 18 x 120	S	25	495,00	M 22 x 140	S	10	1490,00
M 14 x 55	S	50	197,00	M 18 x 130	S	25	850,00	M 22 x 150	S	10	1530,00
M 14 x 60	S	50	144,00	M 18 x 140	S	25	930,00	M 22 x 160	S	10	1560,00
M 14 x 65	S	50	176,00	M 18 x 150	S	25	1040,00	M 22 x 180	S	10	1750,00
M 14 x 70	S	50	182,00	M 18 x 160	S	25	1140,00	M 22 x 200	S	10	2050,00
M 14 x 75	S	50	206,00	M 18 x 180	S	25	1260,00	M 22 x 220	S	10	2120,00
M 14 x 80	S	50	206,00	M 18 x 200	S	25	1260,00	M 24 x 30	S	25	930,00
M 14 x 90	S	50	221,00	M 18 x 210	S	10	1500,00	M 24 x 35	S	25	930,00
M 14 x 100	S	50	249,00	M 18 x 220	S	10	1500,00	M 24 x 40	S	25	840,00
M 14 x 110	S	50	265,00	M 18 x 240	S	10	1590,00	M 24 x 45	S	25	860,00
M 14 x 120	S	50	300,00	M 18 x 250	S	10	1700,00	M 24 x 50	S	25	420,00
M 14 x 125	S	50	660,00	M 18 x 260	S	10	1700,00	M 24 x 55	S	25	445,00
M 14 x 130	S	50	335,00	M 18 x 280	S	10	1820,00	M 24 x 60	S	25	445,00
M 14 x 140	S	25	425,00	M 18 x 300	S	10	1930,00	M 24 x 65	S	25	460,00
M 14 x 150	S	25	485,00	M 20 x 20	S	25	570,00	M 24 x 70	S	25	460,00
M 14 x 160	S	25	780,00	M 20 x 25	S	25	570,00	M 24 x 75	S	25	480,00
M 14 x 170	S	25	820,00	M 20 x 30	S	25	315,00	M 24 x 80	S	25	480,00
M 14 x 180	S	25	860,00	M 20 x 35	S	25	315,00	M 24 x 85	S	10	870,00
M 14 x 190	S	25	880,00	M 20 x 40	S	25	136,00	M 24 x 90	S	10	550,00
M 14 x 200	S	25	910,00	M 20 x 45	S	25	137,00	M 24 x 95	S	10	900,00
M 16 x 20	S	50	197,00	M 20 x 50	S	25	138,00	M 24 x 100	S	10	570,00
M 16 x 25	S	50	143,00	M 20 x 55	S	25	147,00	M 24 x 110	S	10	630,00
M 16 x 30	S	50	66,00	M 20 x 60	S	25	152,00	M 24 x 120	S	10	650,00
M 16 x 35	S	50	69,00	M 20 x 65	S	25	165,00	M 24 x 130	S	10	850,00
M 16 x 40	S	50	71,00	M 20 x 70	S	25	165,00	M 24 x 140	S	10	1080,00
M 16 x 45	S	50	73,00	M 20 x 75	S	25	172,00	M 24 x 150	S	10	1270,00

Abmessungen	VE	Stück	€/100/Obf.	Abmessungen	VE	Stück	€/100/Obf.	Abmessungen	VE	Stück	€/100/Obf.
M 24 x 160	S	10	1360,00	M 30 x 75	S	10	1630,00	M 36 x 110	S	1	2950,00
M 24 x 170	S	10	1630,00	M 30 x 80	S	10	1630,00	M 36 x 120	S	1	3050,00
M 24 x 180	S	10	1690,00	M 30 x 85	S	10	1700,00	M 36 x 130	S	1	3200,00
M 24 x 190	S	10	2060,00	M 30 x 90	S	10	1700,00	M 36 x 140	S	1	3300,00
M 24 x 200	S	10	1810,00	M 30 x 95	S	10	1800,00	M 36 x 150	S	1	3400,00
M 24 x 210	S	1	2320,00	M 30 x 100	S	10	1800,00	M 36 x 160	S	1	3500,00
M 24 x 220	S	1	2110,00	M 30 x 110	S	10	1890,00	M 36 x 170	S	1	4350,00
M 24 x 230	S	1	2550,00	M 30 x 120	S	10	1980,00	M 36 x 180	S	1	3800,00
M 24 x 240	S	1	2300,00	M 30 x 130	S	10	2050,00	M 36 x 190	S	1	3950,00
M 24 x 250	S	1	2750,00	M 30 x 140	S	10	2130,00	M 36 x 200	S	1	4100,00
M 24 x 260	S	1	2460,00	M 30 x 150	S	10	2240,00	M 36 x 210	S	1	4350,00
M 24 x 270	S	1	2900,00	M 30 x 160	S	10	2340,00	M 36 x 220	S	1	4350,00
M 24 x 280	S	1	2550,00	M 30 x 170	S	10	2460,00	M 36 x 230	S	1	4550,00
M 24 x 290	S	1	3050,00	M 30 x 180	S	10	2480,00	M 36 x 240	S	1	4550,00
M 24 x 300	S	1	2650,00	M 30 x 190	S	10	2650,00	M 36 x 250	S	1	4800,00
M 24 x 310	S	1	2850,00	M 30 x 200	S	10	2700,00	M 36 x 260	S	1	4800,00
M 24 x 320	S	1	2850,00	M 30 x 210	S	1	2950,00	M 36 x 270	S	1	4850,00
M 24 x 330	S	1	3200,00	M 30 x 220	S	1	2950,00	M 36 x 280	S	1	5100,00
M 24 x 340	S	1	3200,00	M 30 x 230	S	1	3250,00	M 36 x 290	S	1	5400,00
M 24 x 350	S	1	3500,00	M 30 x 240	S	1	3250,00	M 36 x 300	S	1	5600,00
M 24 x 360	S	1	3500,00	M 30 x 250	S	1	3500,00	M 36 x 310	S	1	6200,00
M 24 x 380	S	1	3750,00	M 30 x 260	S	1	3500,00	M 36 x 320	S	1	6600,00
M 24 x 400	S	1	4100,00	M 30 x 270	S	1	3750,00	M 36 x 330	S	1	6900,00
M 24 x 420	S	1	5400,00	M 30 x 280	S	1	3400,00	M 36 x 340	S	1	7000,00
M 24 x 440	S	1	5900,00	M 30 x 290	S	1	4300,00	M 36 x 350	S	1	7200,00
M 24 x 450	S	1	6000,00	M 30 x 300	S	1	3700,00	M 36 x 360	S	1	7300,00
M 24 x 460	S	1	6300,00	M 30 x 310	S	1	5500,00	M 36 x 380	S	1	7700,00
M 24 x 480	S	1	6800,00	M 30 x 320	S	1	4800,00	M 36 x 400	S	1	8300,00
M 24 x 500	S	1	7300,00	M 30 x 330	S	1	5900,00	M 36 x 420	S	1	10600,00
M 24 x 520	S	1	7700,00	M 30 x 340	S	1	6100,00	M 36 x 440	S	1	12800,00
M 27 x 40	S	10	1660,00	M 30 x 350	S	1	7000,00	M 36 x 450	S	1	13300,00
M 27 x 45	S	10	1660,00	M 30 x 360	S	1	6600,00	M 36 x 460	S	1	13300,00
M 27 x 50	S	10	1350,00	M 30 x 380	S	1	7200,00	M 36 x 480	S	1	13900,00
M 27 x 55	S	10	1350,00	M 30 x 400	S	1	7900,00	M 36 x 500	S	1	14300,00
M 27 x 60	S	10	1350,00	M 30 x 420	S	1	8400,00	M 42 x 80	S	1	9100,00
M 27 x 65	S	10	1410,00	M 30 x 440	S	1	10900,00	M 42 x 90	S	1	9100,00
M 27 x 70	S	10	1410,00	M 30 x 450	S	1	11900,00	M 42 x 100	S	1	4500,00
M 27 x 75	S	10	1470,00	M 30 x 460	S	1	11900,00	M 42 x 110	S	1	4650,00
M 27 x 80	S	10	1470,00	M 30 x 480	S	1	13300,00	M 42 x 120	S	1	4950,00
M 27 x 85	S	10	1520,00	M 30 x 500	S	1	13900,00	M 42 x 130	S	1	5000,00
M 27 x 90	S	10	1520,00	M 30 x 520	S	1	14200,00	M 42 x 140	S	1	5600,00
M 27 x 95	S	10	1590,00	M 33 x 60	S	1	2000,00	M 42 x 150	S	1	5900,00
M 27 x 100	S	10	1590,00	M 33 x 70	S	1	2000,00	M 42 x 160	S	1	6100,00
M 27 x 110	S	10	1630,00	M 33 x 80	S	1	2000,00	M 42 x 170	S	1	6300,00
M 27 x 120	S	10	1800,00	M 33 x 90	S	1	2120,00	M 42 x 180	S	1	6400,00
M 27 x 130	S	1	1880,00	M 33 x 100	S	1	2280,00	M 42 x 190	S	1	6700,00
M 27 x 140	S	1	1950,00	M 33 x 110	S	1	2380,00	M 42 x 200	S	1	7000,00
M 27 x 150	S	1	2020,00	M 33 x 120	S	1	2550,00	M 42 x 220	S	1	8100,00
M 27 x 160	S	1	2080,00	M 33 x 130	S	1	2650,00	M 42 x 240	S	1	8800,00
M 27 x 170	S	1	2600,00	M 33 x 140	S	1	2800,00	M 42 x 260	S	1	9500,00
M 27 x 180	S	1	2230,00	M 33 x 150	S	1	2950,00	M 42 x 280	S	1	10000,00
M 27 x 190	S	1	2800,00	M 33 x 160	S	1	3050,00	M 42 x 300	S	1	10900,00
M 27 x 200	S	1	2330,00	M 33 x 170	S	1	3950,00	M 42 x 320	S	1	19000,00
M 27 x 210	S	1	3600,00	M 33 x 180	S	1	3350,00	M 42 x 400	S	1	22800,00
M 27 x 220	S	1	2650,00	M 33 x 190	S	1	4250,00	M 42 x 420	S	1	23200,00
M 27 x 230	S	1	3900,00	M 33 x 200	S	1	3550,00	M 48 x 110	S	1	8800,00
M 27 x 240	S	1	2850,00	M 33 x 220	S	1	3850,00	M 48 x 160	S	1	10700,00
M 27 x 250	S	1	4150,00	M 33 x 240	S	1	4100,00	M 48 x 200	S	1	12500,00
M 27 x 260	S	1	3050,00	M 33 x 260	S	1	4400,00	M 48 x 400	S	1	51500,00
M 27 x 270	S	1	3150,00	M 33 x 280	S	1	4600,00				
M 27 x 280	S	1	3200,00	M 33 x 300	S	1	4950,00				
M 27 x 290	S	1	3300,00	M 33 x 320	S	1	5700,00				
M 27 x 300	S	1	3450,00	M 33 x 340	S	1	6200,00				
M 27 x 320	S	1	5000,00	M 33 x 360	S	1	6500,00				
M 27 x 340	S	1	5400,00	M 33 x 380	S	1	7100,00				
M 27 x 360	S	1	5800,00	M 33 x 400	S	1	7700,00				
M 27 x 380	S	1	6600,00	M 36 x 50	S	1	4000,00				
M 27 x 400	S	1	7800,00	M 36 x 55	S	1	4000,00				
M 30 x 40	S	10	1670,00	M 36 x 60	S	1	2700,00				
M 30 x 45	S	10	1670,00	M 36 x 65	S	1	2700,00				
M 30 x 50	S	10	1530,00	M 36 x 70	S	1	2700,00				
M 30 x 55	S	10	1530,00	M 36 x 75	S	1	2700,00				
M 30 x 60	S	10	1530,00	M 36 x 80	S	1	2700,00				
M 30 x 65	S	10	1590,00	M 36 x 90	S	1	2800,00				
M 30 x 70	S	10	1590,00	M 36 x 100	S	1	2850,00				



- ✓ Große Artikelvielfalt
- ✓ Verlässliche Qualität
- ✓ Hohe Lieferbereitschaft

Abmessungen	VE Stück	€/100/Obf.
ISO 04762.110		
4762	10.9	galvanisch verzinkt



Zylinderschrauben mit Innensechskant

getempert

Achtung! Warneinblender zu Wasserstoffversprödung beachten.

Maße → **TI-12** Anziehmomente → **TI-244**
 Werkstoffeigensch. → **TI-232** Normumstellung → **TI-6**
 Korrosionsschutz → **TI-228**

Rostfrei → **S. 547**

ISO 4762 → ersetzt DIN 912 (austauschbar)

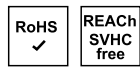

Abmessungen	VE Stück	€/100/Obf.	Abmessungen	VE Stück	€/100/Obf.	Abmessungen	VE Stück	€/100/Obf.
M 3 x 6	S 500	10,50 gal Zn	M 5 x 120	S 100	193,00 gal Zn	M 10 x 60	S 100	57,00 gal Zn
M 3 x 8	S 500	8,50 gal Zn	M 5 x 130	S 100	540,00 gal Zn	M 10 x 65	S 100	58,00 gal Zn
M 3 x 10	S 500	7,10 gal Zn	M 5 x 140	S 100	540,00 gal Zn	M 10 x 70	S 100	63,00 gal Zn
M 3 x 12	S 500	7,50 gal Zn	M 5 x 150	S 100	660,00 gal Zn	M 10 x 75	S 100	76,00 gal Zn
M 3 x 16	S 500	7,90 gal Zn	M 5 x 160	S 100	670,00 gal Zn	M 10 x 80	S 100	78,00 gal Zn
M 3 x 20	S 500	8,40 gal Zn	M 6 x 8	S 500	23,00 gal Zn	M 10 x 85	S 100	134,00 gal Zn
M 3 x 25	S 500	9,20 gal Zn	M 6 x 10	S 500	11,80 gal Zn	M 10 x 90	S 100	94,00 gal Zn
M 3 x 30	S 500	10,60 gal Zn	M 6 x 12	S 500	12,30 gal Zn	M 10 x 95	S 100	147,00 gal Zn
M 4 x 6	S 500	14,80 gal Zn	M 6 x 14	S 500	20,00 gal Zn	M 10 x 100	S 100	104,00 gal Zn
M 4 x 8	S 500	8,70 gal Zn	M 6 x 16	S 500	12,60 gal Zn	M 10 x 110	S 50	152,00 gal Zn
M 4 x 10	S 500	8,20 gal Zn	M 6 x 18	S 500	13,90 gal Zn	M 10 x 120	S 50	190,00 gal Zn
M 4 x 12	S 500	8,30 gal Zn	M 6 x 20	S 500	13,20 gal Zn	M 10 x 130	S 50	218,00 gal Zn
M 4 x 14	S 500	21,70 gal Zn	M 6 x 22	S 500	24,60 gal Zn	M 10 x 140	S 50	239,00 gal Zn
M 4 x 16	S 500	8,60 gal Zn	M 6 x 25	S 500	14,00 gal Zn	M 10 x 160	S 50	365,00 gal Zn
M 4 x 18	S 500	8,80 gal Zn	M 6 x 30	S 500	15,90 gal Zn	M 10 x 170	S 50	420,00 gal Zn
M 4 x 20	S 500	9,10 gal Zn	M 6 x 35	S 200	16,70 gal Zn	M 10 x 180	S 50	445,00 gal Zn
M 4 x 25	S 500	9,70 gal Zn	M 6 x 40	S 200	19,50 gal Zn	M 10 x 210	S 50	610,00 gal Zn
M 4 x 30	S 500	10,60 gal Zn	M 6 x 45	S 200	21,00 gal Zn	M 10 x 220	S 50	610,00 gal Zn
M 4 x 35	S 500	11,50 gal Zn	M 6 x 50	S 200	22,10 gal Zn	M 12 x 20	S 100	51,00 gal Zn
M 4 x 40	S 500	12,50 gal Zn	M 6 x 55	S 200	31,00 gal Zn	M 12 x 25	S 100	64,00 gal Zn
M 4 x 45	S 500	28,00 gal Zn	M 6 x 60	S 200	32,50 gal Zn	M 12 x 30	S 100	67,00 gal Zn
M 4 x 50	S 500	29,50 gal Zn	M 6 x 65	S 200	38,00 gal Zn	M 12 x 35	S 100	70,00 gal Zn
M 4 x 60	S 200	33,50 gal Zn	M 6 x 70	S 200	49,50 gal Zn	M 12 x 40	S 100	72,00 gal Zn
M 4 x 65	S 200	34,50 gal Zn	M 6 x 75	S 200	59,00 gal Zn	M 12 x 45	S 100	65,00 gal Zn
M 5 x 6	S 500	24,90 gal Zn	M 6 x 80	S 200	63,00 gal Zn	M 12 x 50	S 100	82,00 gal Zn
M 5 x 8	S 500	18,20 gal Zn	M 6 x 85	S 200	106,00 gal Zn	M 12 x 55	S 100	89,00 gal Zn
M 5 x 10	S 500	7,70 gal Zn	M 6 x 90	S 200	76,00 gal Zn	M 12 x 60	S 100	94,00 gal Zn
M 5 x 12	S 500	8,20 gal Zn	M 6 x 100	S 200	88,00 gal Zn	M 12 x 65	S 50	103,00 gal Zn
M 5 x 14	S 500	18,20 gal Zn	M 6 x 110	S 100	118,00 gal Zn	M 12 x 70	S 50	107,00 gal Zn
M 5 x 16	S 500	8,60 gal Zn	M 6 x 120	S 100	128,00 gal Zn	M 12 x 75	S 50	114,00 gal Zn
M 5 x 18	S 500	10,30 gal Zn	M 6 x 125	S 100	221,00 gal Zn	M 12 x 80	S 50	115,00 gal Zn
M 5 x 20	S 500	9,20 gal Zn	M 6 x 130	S 100	375,00 gal Zn	M 12 x 85	S 50	187,00 gal Zn
M 5 x 25	S 500	9,90 gal Zn	M 6 x 140	S 100	395,00 gal Zn	M 12 x 90	S 50	116,00 gal Zn
M 5 x 30	S 500	10,80 gal Zn	M 6 x 150	S 100	445,00 gal Zn	M 12 x 95	S 50	206,00 gal Zn
M 5 x 35	S 200	13,70 gal Zn	M 6 x 160	S 100	750,00 gal Zn	M 12 x 100	S 50	132,00 gal Zn
M 5 x 40	S 200	14,40 gal Zn	M 8 x 10	S 200	20,10 gal Zn	M 12 x 110	S 50	188,00 gal Zn
M 5 x 45	S 200	22,10 gal Zn	M 8 x 12	S 200	20,10 gal Zn	M 12 x 120	S 50	193,00 gal Zn
M 5 x 50	S 200	29,00 gal Zn	M 8 x 14	S 200	28,50 gal Zn	M 12 x 125	S 50	325,00 gal Zn
M 5 x 55	S 200	32,50 gal Zn	M 8 x 16	S 200	16,10 gal Zn	M 12 x 130	S 50	295,00 gal Zn
M 5 x 60	S 200	34,50 gal Zn	M 8 x 20	S 200	21,70 gal Zn	M 12 x 135	S 50	375,00 gal Zn
M 5 x 65	S 200	46,00 gal Zn	M 8 x 22	S 200	35,00 gal Zn	M 12 x 140	S 50	335,00 gal Zn
M 5 x 70	S 200	47,00 gal Zn	M 8 x 25	S 200	23,60 gal Zn	M 12 x 150	S 50	410,00 gal Zn
M 5 x 75	S 200	71,00 gal Zn	M 8 x 30	S 200	25,00 gal Zn	M 12 x 160	S 25	450,00 gal Zn
M 5 x 80	S 200	71,00 gal Zn	M 8 x 35	S 200	28,00 gal Zn	M 12 x 170	S 25	485,00 gal Zn
M 5 x 85	S 200	143,00 gal Zn	M 8 x 40	S 200	31,00 gal Zn	M 12 x 180	S 25	520,00 gal Zn
M 5 x 90	S 200	77,00 gal Zn	M 8 x 45	S 200	32,50 gal Zn	M 12 x 190	S 25	910,00 gal Zn
M 5 x 95	S 200	201,00 gal Zn	M 8 x 50	S 200	36,00 gal Zn	M 12 x 200	S 25	640,00 gal Zn
M 5 x 100	S 200	85,00 gal Zn	M 8 x 55	S 200	43,50 gal Zn	M 12 x 210	S 25	880,00 gal Zn
M 5 x 110	S 100	189,00 gal Zn	M 8 x 60	S 200	45,00 gal Zn	M 12 x 220	S 25	890,00 gal Zn
			M 8 x 65	S 200	53,00 gal Zn	M 12 x 230	S 25	1020,00 gal Zn
			M 8 x 70	S 200	50,00 gal Zn	M 12 x 240	S 25	1010,00 gal Zn
			M 8 x 75	S 200	57,00 gal Zn	M 12 x 250	S 25	1410,00 gal Zn
			M 8 x 80	S 200	72,00 gal Zn	M 12 x 260	S 25	1100,00 gal Zn
			M 8 x 90	S 100	84,00 gal Zn	M 12 x 270	S 25	1440,00 gal Zn
			M 8 x 100	S 100	95,00 gal Zn	M 12 x 280	S 25	1170,00 gal Zn
			M 8 x 120	S 100	128,00 gal Zn	M 12 x 290	S 25	1480,00 gal Zn
			M 8 x 125	S 100	240,00 gal Zn	M 12 x 300	S 25	1270,00 gal Zn
			M 8 x 130	S 100	178,00 gal Zn	M 12 x 310	S 25	2290,00 gal Zn
			M 8 x 140	S 50	193,00 gal Zn	M 12 x 320	S 25	2500,00 gal Zn
			M 8 x 150	S 50	305,00 gal Zn	M 12 x 330	S 25	2950,00 gal Zn
			M 8 x 160	S 50	345,00 gal Zn	M 12 x 340	S 25	2950,00 gal Zn
			M 8 x 170	S 50	390,00 gal Zn	M 12 x 360	S 25	3600,00 gal Zn
			M 8 x 180	S 50	415,00 gal Zn	M 12 x 380	S 25	4300,00 gal Zn
			M 8 x 200	S 50	640,00 gal Zn	M 14 x 30	S 100	171,00 gal Zn
			M 10 x 10	S 200	80,00 gal Zn	M 14 x 35	S 100	178,00 gal Zn
			M 10 x 12	S 200	80,00 gal Zn	M 14 x 40	S 100	151,00 gal Zn
			M 10 x 16	S 200	42,50 gal Zn	M 14 x 45	S 50	158,00 gal Zn
			M 10 x 20	S 200	39,00 gal Zn	M 14 x 50	S 50	167,00 gal Zn
			M 10 x 25	S 200	43,00 gal Zn	M 14 x 55	S 50	236,00 gal Zn
			M 10 x 30	S 200	45,00 gal Zn	M 14 x 60	S 50	187,00 gal Zn
			M 10 x 35	S 100	48,00 gal Zn	M 14 x 65	S 50	221,00 gal Zn
			M 10 x 40	S 100	51,00 gal Zn	M 14 x 70	S 50	229,00 gal Zn
			M 10 x 45	S 100	42,50 gal Zn	M 14 x 80	S 50	260,00 gal Zn
			M 10 x 50	S 100	45,50 gal Zn	M 14 x 90	S 50	280,00 gal Zn
			M 10 x 55	S 100	54,00 gal Zn	M 14 x 100	S 50	315,00 gal Zn

Abmessungen VE Stück €/100/Obf.

ISO 04762.200

4762 12.9

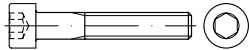

Zylinderschrauben mit Innensechskant

Maße → TI-12 Anziehmomente → TI-244
 Werkstoffeigensch. → TI-232 Normumstellung → TI-6

Rostfrei → S. 547

ISO 4762 → ersetzt DIN 912 (austauschbar)

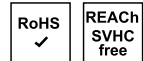

M 1,4	x	6	S	100	155,00
M 1,4	x	10	S	100	184,00
M 1,6	x	3	S	100	114,00
M 1,6	x	4	S	100	126,00
M 1,6	x	5	S	100	134,00
M 1,6	x	6	S	100	137,00
M 2	x	3	S	100	95,00
M 2	x	4	S	100	98,00
M 2	x	5	S	100	99,00
M 2	x	6	S	100	105,00
M 2	x	8	S	100	108,00
M 2	x	10	S	100	113,00
M 2	x	12	S	100	135,00
M 2,5	x	4	S	100	81,00
M 2,5	x	5	S	100	85,00
M 2,5	x	6	S	100	90,00
M 2,5	x	8	S	100	91,00
M 2,5	x	10	S	100	95,00
M 2,5	x	12	S	100	115,00
M 2,5	x	16	S	100	137,00
M 2,5	x	20	S	100	158,00
M 3	x	4	S	500	36,00
M 3	x	5	S	500	36,00
M 3	x	5	K	100	39,50
M 3	x	6	S	500	10,10
M 3	x	6	K	100	13,70
M 3	x	8	S	500	8,00
M 3	x	8	K	100	11,70
M 3	x	10	S	500	6,60
M 3	x	10	K	100	10,20
M 3	x	12	S	500	6,90
M 3	x	12	K	100	10,50
M 3	x	14	S	500	7,10
M 3	x	14	K	100	10,80
M 3	x	16	S	500	7,10
M 3	x	16	K	100	10,80
M 3	x	18	S	500	7,60
M 3	x	18	K	100	11,20
M 3	x	20	S	500	7,60
M 3	x	20	K	100	11,20
M 3	x	22	S	500	8,20
M 3	x	22	K	100	11,80
M 3	x	25	S	500	8,20
M 3	x	25	K	100	11,80
M 3	x	30	S	500	9,40
M 3	x	30	K	100	13,10
M 3	x	35	S	500	26,50
M 3	x	35	K	100	30,50
M 3	x	40	S	500	44,00
M 3	x	45	S	500	58,00
M 3	x	50	S	500	65,00
M 4	x	5	S	500	37,00
M 4	x	5	K	100	40,50
M 4	x	6	S	500	20,40

Abmessungen VE Stück €/100/Obf.

M 4	x	6	K	100	24,10
M 4	x	8	S	500	7,70
M 4	x	8	K	100	11,40
M 4	x	10	S	500	7,10
M 4	x	10	K	100	10,80
M 4	x	12	S	500	7,20
M 4	x	12	K	100	10,90
M 4	x	14	S	500	20,00
M 4	x	14	K	100	23,60
M 4	x	16	S	500	7,30
M 4	x	16	K	100	11,00
M 4	x	18	S	500	7,60
M 4	x	18	K	100	11,20
M 4	x	20	S	500	7,70
M 4	x	20	K	100	11,40
M 4	x	22	S	500	19,70
M 4	x	22	K	100	23,40
M 4	x	25	S	500	8,00
M 4	x	25	K	100	11,70
M 4	x	30	S	500	8,60
M 4	x	30	K	100	12,20
M 4	x	35	S	500	8,90
M 4	x	35	K	100	12,60
M 4	x	40	S	500	9,70
M 4	x	40	K	100	13,40
M 4	x	45	S	500	23,80
M 4	x	45	K	100	27,50
M 4	x	50	S	500	23,80
M 4	x	50	K	100	27,50
M 4	x	55	S	200	28,50
M 4	x	60	S	200	29,50
M 4	x	65	S	200	36,50
M 4	x	70	S	200	42,50
M 4	x	75	S	500	105,00
M 4	x	80	S	200	113,00
M 4	x	90	S	200	375,00
M 4	x	100	S	200	410,00
M 4	x	110	S	200	600,00
M 4	x	120	S	200	620,00
M 5	x	6	S	500	23,50
M 5	x	6	K	100	27,50
M 5	x	8	S	500	16,70
M 5	x	8	K	100	20,40
M 5	x	10	S	500	6,20
M 5	x	10	K	100	9,80
M 5	x	12	S	500	6,50
M 5	x	12	K	100	10,20
M 5	x	14	S	500	17,00
M 5	x	14	K	100	20,60
M 5	x	16	S	500	6,60
M 5	x	16	K	100	10,20
M 5	x	18	S	500	8,00
M 5	x	18	K	100	11,70
M 5	x	20	S	500	6,90
M 5	x	20	K	100	10,60
M 5	x	22	S	500	17,70
M 5	x	22	K	100	21,30
M 5	x	25	S	500	7,30
M 5	x	25	K	100	11,00
M 5	x	30	S	500	7,80
M 5	x	30	K	100	11,50
M 5	x	35	S	200	10,40
M 5	x	40	S	200	10,60
M 5	x	45	S	200	18,00
M 5	x	50	S	200	24,20
M 5	x	55	S	200	27,50
M 5	x	60	S	200	29,00
M 5	x	65	S	200	40,00
M 5	x	70	S	200	40,50
M 5	x	75	S	200	63,00
M 5	x	80	S	200	64,00
M 5	x	85	S	200	73,00
M 5	x	90	S	200	70,00
M 5	x	95	S	200	82,00
M 5	x	100	S	200	78,00

Abmessungen VE Stück €/100/Obf.

M 5	x	105	S	100	182,00
M 5	x	110	S	100	87,00
M 5	x	115	S	100	212,00
M 5	x	120	S	100	128,00
M 5	x	125	S	100	590,00
M 5	x	130	S	100	530,00
M 5	x	135	S	100	650,00
M 5	x	140	S	100	670,00
M 5	x	145	S	100	650,00
M 5	x	150	S	100	670,00
M 5	x	155	S	100	660,00
M 5	x	160	S	100	710,00
M 5	x	165	S	100	700,00
M 5	x	170	S	100	750,00
M 5	x	175	S	100	750,00
M 5	x	180	S	100	750,00
M 5	x	190	S	100	910,00
M 5	x	200	S	100	910,00
M 5	x	210	S	100	1150,00
M 5	x	220	S	100	1150,00
M 5	x	230	S	100	1170,00
M 5	x	240	S	100	1220,00
M 6	x	6	S	500	192,00
M 6	x	6	K	100	195,00
M 6	x	8	S	500	18,60
M 6	x	8	K	100	22,20
M 6	x	10	S	500	6,30
M 6	x	10	K	100	10,00
M 6	x	12	S	500	14,20
M 6	x	12	K	100	17,90
M 6	x	14	S	500	14,60
M 6	x	16	S	500	6,60
M 6	x	16	K	100	10,20
M 6	x	18	S	500	7,40
M 6	x	18	K	100	11,10
M 6	x	20	S	500	6,60
M 6	x	20	K	100	10,30
M 6	x	22	S	500	16,20
M 6	x	22	K	100	19,90
M 6	x	25	S	500	6,90
M 6	x	25	K	100	10,60
M 6	x	30	S	500	7,80
M 6	x	30	K	100	11,50
M 6	x	35	S	200	8,40
M 6	x	40	S	200	9,40
M 6	x	45	S	200	12,30
M 6	x	50	S	200	14,60
M 6	x	55	S	200	23,20
M 6	x	60	S	200	23,60
M 6	x	65	S	200	30,00
M 6	x	70	S	200	39,50
M 6	x	75	S	200	49,00
M 6	x	80	S	200	54,00
M 6	x	85	S	200	101,00
M 6	x	90	S	100	66,00
M 6	x	95	S	100	130,00
M 6	x	100	S	100	79,00
M 6	x	105	S	100	160,00
M 6	x	110	S	100	108,00
M 6	x	115	S	100	209,00
M 6	x	120	S	100	117,00
M 6	x	125	S	100	330,00
M 6	x	130	S	100	350,00
M 6	x	135	S	100	460,00
M 6	x	140	S	100	365,00
M 6	x	145	S	100	650,00
M 6	x	150	S	100	700,00
M 6	x	155	S	100	720,00
M 6	x	160	S	100	700,00
M 6	x	165	S	100	750,00
M 6	x	170	S	100	770,00
M 6	x	175	S	100	830,00
M 6	x	180	S	100	820,00
M 6	x	185	S	100	1020,00
M 6	x	190	S	100	1000,00

Abmessungen	VE	Stück	€/100/Obf.	Abmessungen	VE	Stück	€/100/Obf.	Abmessungen	VE	Stück	€/100/Obf.
M 6 x 200	S	100	1110,00	M 10 x 110	S	50	111,00	M 14 x 90	S	50	221,00
M 6 x 210	S	100	1160,00	M 10 x 120	S	50	146,00	M 14 x 100	S	50	249,00
M 6 x 220	S	100	1200,00	M 10 x 130	S	50	172,00	M 14 x 110	S	50	265,00
M 6 x 230	S	100	1300,00	M 10 x 140	S	50	193,00	M 14 x 120	S	50	300,00
M 6 x 240	S	100	1320,00	M 10 x 150	S	50	285,00	M 14 x 130	S	50	335,00
M 6 x 250	S	100	1440,00	M 10 x 160	S	50	355,00	M 14 x 140	S	25	425,00
M 6 x 260	S	100	1470,00	M 10 x 170	S	50	420,00	M 14 x 150	S	25	485,00
M 6 x 270	S	100	1620,00	M 10 x 180	S	50	445,00	M 14 x 160	S	25	780,00
M 6 x 280	S	100	2040,00	M 10 x 190	S	50	600,00	M 14 x 170	S	25	820,00
M 6 x 290	S	100	2370,00	M 10 x 200	S	50	500,00	M 14 x 180	S	25	860,00
M 6 x 300	S	100	2800,00	M 10 x 210	S	50	560,00	M 14 x 190	S	25	880,00
M 8 x 8	S	200	181,00	M 10 x 220	S	50	540,00	M 14 x 200	S	25	910,00
M 8 x 10	S	200	15,30	M 10 x 230	S	50	650,00	M 14 x 220	S	10	1100,00
M 8 x 12	S	200	15,30	M 10 x 240	S	50	630,00	M 14 x 240	S	10	1140,00
M 8 x 14	S	200	22,60	M 10 x 250	S	50	690,00	M 14 x 260	S	10	1190,00
M 8 x 16	S	200	10,80	M 10 x 260	S	50	710,00	M 14 x 280	S	10	1260,00
M 8 x 18	S	200	11,70	M 10 x 270	S	50	960,00	M 14 x 300	S	10	1340,00
M 8 x 20	S	200	10,20	M 10 x 280	S	50	800,00	M 16 x 20	S	50	197,00
M 8 x 22	S	200	23,50	M 10 x 290	S	50	1070,00	M 16 x 22	S	50	480,00
M 8 x 25	S	200	11,00	M 10 x 300	S	50	890,00	M 16 x 25	S	50	143,00
M 8 x 30	S	200	11,60	M 12 x 12	S	100	325,00	M 16 x 30	S	50	66,00
M 8 x 35	S	200	12,90	M 12 x 16	S	100	42,00	M 16 x 35	S	50	69,00
M 8 x 40	S	200	14,30	M 12 x 18	S	100	42,00	M 16 x 40	S	50	71,00
M 8 x 45	S	200	15,10	M 12 x 20	S	100	37,00	M 16 x 45	S	50	73,00
M 8 x 50	S	200	16,60	M 12 x 22	S	100	102,00	M 16 x 50	S	50	75,00
M 8 x 55	S	200	22,50	M 12 x 25	S	100	31,00	M 16 x 55	S	50	78,00
M 8 x 60	S	200	23,00	M 12 x 30	S	100	32,50	M 16 x 60	S	50	81,00
M 8 x 65	S	200	31,00	M 12 x 35	S	100	33,50	M 16 x 65	S	25	93,00
M 8 x 70	S	200	32,00	M 12 x 40	S	100	34,00	M 16 x 70	S	25	93,00
M 8 x 75	S	200	39,50	M 12 x 45	S	100	36,00	M 16 x 75	S	25	106,00
M 8 x 80	S	200	52,00	M 12 x 50	S	100	37,50	M 16 x 80	S	25	106,00
M 8 x 90	S	100	63,00	M 12 x 55	S	100	41,50	M 16 x 85	S	25	129,00
M 8 x 100	S	100	74,00	M 12 x 60	S	100	43,50	M 16 x 90	S	25	129,00
M 8 x 110	S	100	96,00	M 12 x 65	S	50	48,00	M 16 x 100	S	25	141,00
M 8 x 120	S	100	97,00	M 12 x 70	S	50	50,00	M 16 x 110	S	25	170,00
M 8 x 130	S	100	148,00	M 12 x 75	S	50	59,00	M 16 x 120	S	25	205,00
M 8 x 140	S	50	163,00	M 12 x 80	S	50	60,00	M 16 x 130	S	25	305,00
M 8 x 150	S	50	275,00	M 12 x 90	S	50	68,00	M 16 x 140	S	25	335,00
M 8 x 160	S	50	325,00	M 12 x 100	S	50	76,00	M 16 x 150	S	25	395,00
M 8 x 170	S	50	375,00	M 12 x 110	S	50	116,00	M 16 x 160	S	25	440,00
M 8 x 180	S	50	400,00	M 12 x 120	S	50	130,00	M 16 x 170	S	25	540,00
M 8 x 190	S	50	660,00	M 12 x 130	S	50	200,00	M 16 x 180	S	25	540,00
M 8 x 200	S	50	570,00	M 12 x 140	S	50	234,00	M 16 x 190	S	25	710,00
M 8 x 210	S	50	710,00	M 12 x 150	S	50	310,00	M 16 x 200	S	25	610,00
M 8 x 220	S	50	730,00	M 12 x 160	S	25	345,00	M 16 x 210	S	25	1380,00
M 8 x 230	S	50	770,00	M 12 x 170	S	25	390,00	M 16 x 220	S	25	920,00
M 8 x 240	S	50	800,00	M 12 x 180	S	25	395,00	M 16 x 230	S	25	1440,00
M 8 x 250	S	50	850,00	M 12 x 190	S	25	510,00	M 16 x 240	S	25	920,00
M 8 x 260	S	50	890,00	M 12 x 200	S	25	510,00	M 16 x 250	S	25	1500,00
M 8 x 270	S	50	920,00	M 12 x 220	S	25	790,00	M 16 x 260	S	25	1030,00
M 8 x 280	S	50	950,00	M 12 x 230	S	25	1130,00	M 16 x 270	S	25	1590,00
M 8 x 290	S	50	1220,00	M 12 x 240	S	25	840,00	M 16 x 280	S	25	1130,00
M 8 x 300	S	50	1300,00	M 12 x 250	S	25	1240,00	M 16 x 290	S	25	1830,00
M 8 x 310	S	50	1640,00	M 12 x 260	S	25	920,00	M 16 x 300	S	25	1270,00
M 10 x 10	S	200	235,00	M 12 x 280	S	25	980,00	M 16 x 310	S	1	1560,00
M 10 x 12	S	200	79,00	M 12 x 300	S	25	1060,00	M 16 x 320	S	1	1700,00
M 10 x 16	S	200	31,00	M 12 x 310	S	25	2900,00	M 16 x 330	S	1	1700,00
M 10 x 18	S	200	31,00	M 12 x 320	S	1	2900,00	M 16 x 340	S	1	1840,00
M 10 x 20	S	200	18,70	M 12 x 340	S	1	3150,00	M 16 x 350	S	1	1860,00
M 10 x 22	S	200	52,00	M 12 x 360	S	1	3600,00	M 16 x 360	S	1	1980,00
M 10 x 25	S	200	20,30	M 12 x 380	S	1	5600,00	M 16 x 370	S	1	2900,00
M 10 x 30	S	200	21,00	M 12 x 400	S	1	6400,00	M 16 x 380	S	1	2800,00
M 10 x 35	S	100	22,30	M 14 x 20	S	100	193,00	M 16 x 390	S	1	3350,00
M 10 x 40	S	100	23,20	M 14 x 25	S	100	152,00	M 16 x 400	S	1	2950,00
M 10 x 45	S	100	26,00	M 14 x 30	S	100	146,00	M 16 x 420	S	1	3750,00
M 10 x 50	S	100	27,50	M 14 x 35	S	100	151,00	M 18 x 30	S	50	415,00
M 10 x 55	S	100	30,00	M 14 x 40	S	100	135,00	M 18 x 35	S	50	415,00
M 10 x 60	S	100	33,00	M 14 x 45	S	50	138,00	M 18 x 40	S	50	315,00
M 10 x 65	S	100	37,00	M 14 x 50	S	50	147,00	M 18 x 45	S	50	320,00
M 10 x 70	S	100	33,00	M 14 x 55	S	50	197,00	M 18 x 50	S	50	320,00
M 10 x 75	S	100	45,00	M 14 x 60	S	50	161,00	M 18 x 55	S	25	320,00
M 10 x 80	S	100	46,00	M 14 x 65	S	50	176,00	M 18 x 60	S	25	320,00
M 10 x 85	S	100	104,00	M 14 x 70	S	50	182,00	M 18 x 65	S	25	345,00
M 10 x 90	S	100	60,00	M 14 x 75	S	50	206,00	M 18 x 70	S	25	345,00
M 10 x 100	S	100	67,00	M 14 x 80	S	50	206,00	M 18 x 75	S	25	380,00

Abmessungen	VE	Stück	€/100/Obf.	Abmessungen	VE	Stück	€/100/Obf.	Abmessungen	VE	Stück	€/100/Obf.
M 18 x 80	S	25	380,00	M 22 x 110	S	10	1420,00	M 27 x 180	S	1	2310,00
M 18 x 90	S	25	385,00	M 22 x 120	S	10	1450,00	M 27 x 190	S	1	3400,00
M 18 x 100	S	25	420,00	M 22 x 130	S	1	1490,00	M 27 x 200	S	1	2420,00
M 18 x 110	S	25	450,00	M 22 x 140	S	1	1550,00	M 27 x 210	S	1	3650,00
M 18 x 120	S	25	495,00	M 22 x 150	S	1	1590,00	M 27 x 220	S	1	2650,00
M 18 x 130	S	25	550,00	M 22 x 160	S	1	1630,00	M 27 x 230	S	1	3900,00
M 18 x 140	S	25	650,00	M 22 x 170	S	1	1700,00	M 27 x 240	S	1	2850,00
M 18 x 150	S	25	760,00	M 22 x 180	S	1	1750,00	M 27 x 250	S	1	4150,00
M 18 x 160	S	25	1040,00	M 22 x 200	S	1	2050,00	M 27 x 260	S	1	3050,00
M 18 x 170	S	25	1100,00	M 22 x 220	S	1	2120,00	M 27 x 280	S	1	3200,00
M 18 x 180	S	25	1150,00	M 22 x 240	S	1	2230,00	M 27 x 300	S	1	3450,00
M 18 x 190	S	25	1190,00	M 22 x 260	S	1	2310,00	M 30 x 45	S	1	1570,00
M 18 x 200	S	10	1230,00	M 22 x 280	S	1	2390,00	M 30 x 50	S	1	1570,00
M 18 x 220	S	10	1500,00	M 22 x 300	S	1	2460,00	M 30 x 55	S	1	1570,00
M 18 x 240	S	10	1590,00	M 24 x 40	S	25	840,00	M 30 x 60	S	1	1570,00
M 18 x 260	S	1	1700,00	M 24 x 45	S	25	860,00	M 30 x 65	S	1	1610,00
M 18 x 280	S	1	1820,00	M 24 x 50	S	25	420,00	M 30 x 70	S	1	1640,00
M 18 x 300	S	1	1930,00	M 24 x 55	S	25	445,00	M 30 x 75	S	1	1640,00
M 20 x 30	S	25	355,00	M 24 x 60	S	25	445,00	M 30 x 80	S	1	1710,00
M 20 x 35	S	25	355,00	M 24 x 65	S	25	460,00	M 30 x 90	S	1	1780,00
M 20 x 40	S	25	136,00	M 24 x 70	S	25	460,00	M 30 x 100	S	1	1850,00
M 20 x 45	S	25	137,00	M 24 x 75	S	25	480,00	M 30 x 110	S	1	1920,00
M 20 x 50	S	25	138,00	M 24 x 80	S	25	480,00	M 30 x 120	S	1	1990,00
M 20 x 55	S	25	147,00	M 24 x 90	S	10	550,00	M 30 x 130	S	1	2060,00
M 20 x 60	S	25	152,00	M 24 x 100	S	10	570,00	M 30 x 140	S	1	2130,00
M 20 x 65	S	25	165,00	M 24 x 110	S	10	630,00	M 30 x 150	S	1	2240,00
M 20 x 70	S	25	165,00	M 24 x 120	S	10	650,00	M 30 x 160	S	1	2340,00
M 20 x 75	S	25	172,00	M 24 x 130	S	1	1080,00	M 30 x 170	S	1	2460,00
M 20 x 80	S	25	192,00	M 24 x 140	S	1	1100,00	M 30 x 180	S	1	2480,00
M 20 x 90	S	25	201,00	M 24 x 150	S	1	1290,00	M 30 x 190	S	1	2650,00
M 20 x 100	S	25	220,00	M 24 x 160	S	1	1700,00	M 30 x 200	S	1	2700,00
M 20 x 110	S	25	249,00	M 24 x 170	S	1	1900,00	M 30 x 210	S	1	2950,00
M 20 x 120	S	25	305,00	M 24 x 180	S	1	2130,00	M 30 x 220	S	1	2950,00
M 20 x 130	S	25	390,00	M 24 x 190	S	1	2240,00	M 30 x 230	S	1	3250,00
M 20 x 140	S	25	570,00	M 24 x 200	S	1	2240,00	M 30 x 240	S	1	3050,00
M 20 x 150	S	25	660,00	M 24 x 210	S	1	2440,00	M 30 x 250	S	1	3500,00
M 20 x 160	S	10	670,00	M 24 x 220	S	1	2300,00	M 30 x 260	S	1	3500,00
M 20 x 170	S	10	940,00	M 24 x 230	S	1	2600,00	M 30 x 270	S	1	3750,00
M 20 x 180	S	10	920,00	M 24 x 240	S	1	2390,00	M 30 x 280	S	1	3400,00
M 20 x 190	S	10	1020,00	M 24 x 250	S	1	2750,00	M 30 x 290	S	1	4300,00
M 20 x 200	S	10	860,00	M 24 x 260	S	1	2470,00	M 30 x 300	S	1	3700,00
M 20 x 210	S	10	1780,00	M 24 x 270	S	1	2900,00	M 30 x 320	S	1	4800,00
M 20 x 220	S	10	1250,00	M 24 x 280	S	1	2550,00	M 30 x 340	S	1	6100,00
M 20 x 230	S	10	2000,00	M 24 x 290	S	1	3050,00	M 30 x 360	S	1	6600,00
M 20 x 240	S	10	1330,00	M 24 x 300	S	1	2650,00	M 30 x 380	S	1	7200,00
M 20 x 250	S	10	2140,00	M 24 x 310	S	1	2850,00	M 30 x 400	S	1	7900,00
M 20 x 260	S	10	1400,00	M 24 x 320	S	1	2850,00	M 30 x 420	S	1	8400,00
M 20 x 270	S	10	2290,00	M 24 x 330	S	1	3200,00	M 30 x 440	S	1	10900,00
M 20 x 280	S	10	1470,00	M 24 x 340	S	1	3200,00	M 30 x 460	S	1	11900,00
M 20 x 290	S	10	2650,00	M 24 x 350	S	1	3500,00	M 33 x 60	S	1	2080,00
M 20 x 300	S	10	1630,00	M 24 x 360	S	1	3500,00	M 33 x 70	S	1	2080,00
M 20 x 310	S	1	2060,00	M 24 x 380	S	1	3750,00	M 33 x 80	S	1	2080,00
M 20 x 320	S	1	2120,00	M 24 x 400	S	1	4100,00	M 33 x 90	S	1	2200,00
M 20 x 330	S	1	2330,00	M 24 x 420	S	1	5400,00	M 33 x 100	S	1	2370,00
M 20 x 340	S	1	2400,00	M 24 x 440	S	1	5900,00	M 33 x 110	S	1	2470,00
M 20 x 350	S	1	2600,00	M 24 x 450	S	1	6500,00	M 33 x 120	S	1	2650,00
M 20 x 360	S	1	2650,00	M 24 x 460	S	1	6300,00	M 33 x 130	S	1	2750,00
M 20 x 380	S	1	2900,00	M 24 x 480	S	1	6800,00	M 33 x 140	S	1	2900,00
M 20 x 400	S	1	3200,00	M 24 x 500	S	1	7300,00	M 33 x 150	S	1	3100,00
M 20 x 420	S	1	3550,00	M 27 x 50	S	10	1410,00	M 33 x 160	S	1	3150,00
M 20 x 440	S	1	3900,00	M 27 x 55	S	10	1410,00	M 33 x 170	S	1	4650,00
M 20 x 460	S	1	4250,00	M 27 x 60	S	10	1410,00	M 33 x 180	S	1	3450,00
M 20 x 480	S	1	4600,00	M 27 x 65	S	10	1460,00	M 33 x 200	S	1	3650,00
M 20 x 500	S	1	4950,00	M 27 x 70	S	10	1460,00	M 33 x 210	S	1	5500,00
M 22 x 40	S	25	820,00	M 27 x 75	S	10	1520,00	M 33 x 220	S	1	3950,00
M 22 x 45	S	25	820,00	M 27 x 80	S	10	1520,00	M 33 x 240	S	1	4300,00
M 22 x 50	S	25	1030,00	M 27 x 90	S	10	1580,00	M 33 x 260	S	1	4600,00
M 22 x 55	S	25	1170,00	M 27 x 100	S	10	1660,00	M 33 x 280	S	1	4900,00
M 22 x 60	S	25	1170,00	M 27 x 110	S	10	1700,00	M 33 x 300	S	1	5200,00
M 22 x 65	S	25	1210,00	M 27 x 120	S	10	1870,00	M 36 x 60	S	1	2700,00
M 22 x 70	S	25	1210,00	M 27 x 130	S	1	1950,00	M 36 x 70	S	1	2700,00
M 22 x 75	S	25	1270,00	M 27 x 140	S	1	2030,00	M 36 x 80	S	1	2700,00
M 22 x 80	S	25	1270,00	M 27 x 150	S	1	2110,00	M 36 x 90	S	1	2800,00
M 22 x 90	S	25	1360,00	M 27 x 160	S	1	2160,00	M 36 x 100	S	1	2850,00
M 22 x 100	S	10	1390,00	M 27 x 170	S	1	3100,00	M 36 x 110	S	1	2950,00

Abmessungen	VE	Stück	€/100/Obf.
M 36 x 120	S	1	3050,00
M 36 x 130	S	1	3200,00
M 36 x 140	S	1	3300,00
M 36 x 150	S	1	3400,00
M 36 x 160	S	1	3500,00
M 36 x 170	S	1	4350,00
M 36 x 180	S	1	3800,00
M 36 x 200	S	1	4100,00
M 36 x 220	S	1	4350,00
M 36 x 240	S	1	4550,00
M 36 x 260	S	1	4800,00
M 36 x 280	S	1	5100,00
M 36 x 300	S	1	5600,00
M 36 x 320	S	1	6600,00
M 36 x 340	S	1	7000,00
M 36 x 360	S	1	7300,00
M 36 x 380	S	1	7700,00
M 36 x 400	S	1	8300,00
M 36 x 420	S	1	10600,00
M 39 x 100	S	1	4750,00
M 39 x 110	S	1	5200,00
M 39 x 120	S	1	5400,00
M 39 x 130	S	1	5700,00
M 39 x 140	S	1	6000,00
M 39 x 150	S	1	6300,00
M 39 x 160	S	1	6400,00
M 39 x 170	S	1	6800,00
M 39 x 180	S	1	7000,00
M 39 x 200	S	1	7600,00
M 39 x 220	S	1	8200,00
M 39 x 240	S	1	8800,00
M 39 x 260	S	1	9800,00
M 39 x 280	S	1	10300,00
M 39 x 300	S	1	10900,00
M 42 x 120	S	1	4950,00
M 42 x 130	S	1	5000,00
M 42 x 140	S	1	5600,00
M 42 x 150	S	1	5900,00
M 42 x 160	S	1	6100,00
M 42 x 170	S	1	6300,00
M 42 x 180	S	1	6400,00
M 42 x 190	S	1	6700,00
M 42 x 200	S	1	7000,00
M 42 x 220	S	1	8100,00
M 42 x 240	S	1	8800,00
M 42 x 260	S	1	9500,00
M 42 x 280	S	1	10000,00
M 42 x 300	S	1	10900,00
M 48 x 120	S	1	8800,00
M 48 x 130	S	1	9100,00
M 48 x 140	S	1	9600,00
M 48 x 150	S	1	10100,00
M 48 x 160	S	1	10700,00
M 48 x 180	S	1	11700,00
M 48 x 200	S	1	12500,00
M 48 x 220	S	1	16700,00
M 48 x 240	S	1	18100,00
M 48 x 260	S	1	19600,00
M 48 x 280	S	1	20900,00
M 48 x 300	S	1	21700,00

Abmessungen	VE	Stück	€/100/Obf.
ISO 4762			12.9
			fiZn/TL480h

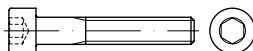

Zylinderschrauben mit Innensechskant

TL = Schmierstoff im Topcoat mit $\mu = 0,09 - 0,14$,
 Korrosionsbeständigkeit NSS: 480h RR,
 Chrom(VI)-frei

Achtung! Gegenüber galv. verzinkt geänderte Anziehdrehmomente.

Maße → **TI-12** Anziehdrehmomente → **TI-245**
 Werkstoffeigensch. → **TI-232** Normumstellung → **TI-6**
 Korrosionsschutz → **TI-230**

Rostfrei → **S. 547**

ISO 4762 → ersetzt DIN 912 (austauschbar)



M 6 x 12	S	500	15,60 flZn
M 6 x 14	S	500	26,00 flZn
M 6 x 16	S	500	16,00 flZn
M 6 x 18	S	500	17,70 flZn
M 6 x 20	S	500	16,70 flZn
M 6 x 22	S	500	31,50 flZn
M 6 x 25	S	500	17,70 flZn
M 6 x 30	S	500	20,10 flZn
M 6 x 35	S	200	21,20 flZn
M 6 x 40	S	200	24,70 flZn
M 6 x 45	S	200	26,50 flZn
M 6 x 50	S	200	28,00 flZn
M 6 x 55	S	200	39,00 flZn
M 6 x 60	S	200	41,00 flZn
M 6 x 65	S	200	47,50 flZn
M 6 x 70	S	200	63,00 flZn
M 6 x 75	S	200	75,00 flZn
M 6 x 80	S	200	80,00 flZn
M 8 x 16	S	200	20,40 flZn
M 8 x 20	S	200	27,50 flZn
M 8 x 25	S	200	30,00 flZn
M 8 x 30	S	200	32,00 flZn
M 8 x 35	S	200	35,50 flZn
M 8 x 40	S	200	39,50 flZn
M 8 x 45	S	200	41,50 flZn
M 8 x 50	S	200	46,00 flZn
M 8 x 55	S	200	55,00 flZn
M 8 x 60	S	200	57,00 flZn
M 8 x 65	S	200	67,00 flZn
M 8 x 70	S	200	64,00 flZn
M 8 x 75	S	200	72,00 flZn
M 8 x 80	S	200	91,00 flZn
M 8 x 90	S	100	106,00 flZn
M 10 x 20	S	200	49,50 flZn
M 10 x 25	S	200	54,00 flZn
M 10 x 30	S	200	57,00 flZn
M 10 x 35	S	100	61,00 flZn
M 10 x 40	S	100	65,00 flZn
M 10 x 45	S	100	54,00 flZn
M 10 x 50	S	100	58,00 flZn
M 10 x 55	S	100	68,00 flZn
M 10 x 60	S	100	72,00 flZn
M 10 x 65	S	100	74,00 flZn
M 10 x 70	S	100	79,00 flZn
M 10 x 75	S	100	97,00 flZn
M 10 x 80	S	100	98,00 flZn
M 10 x 90	S	100	119,00 flZn

Abmessungen	VE	Stück	€/100/Obf.
M 12 x 20	S	100	65,00 flZn
M 12 x 25	S	100	81,00 flZn
M 12 x 30	S	100	85,00 flZn
M 12 x 35	S	100	89,00 flZn
M 12 x 40	S	100	92,00 flZn
M 12 x 45	S	100	82,00 flZn
M 12 x 50	S	100	104,00 flZn
M 12 x 55	S	100	113,00 flZn
M 12 x 60	S	100	119,00 flZn
M 12 x 65	S	50	130,00 flZn
M 12 x 70	S	50	136,00 flZn
M 12 x 75	S	50	146,00 flZn
M 12 x 80	S	50	146,00 flZn
M 12 x 90	S	50	149,00 flZn
M 12 x 100	S	50	169,00 flZn
M 16 x 30	S	50	140,00 flZn
M 16 x 35	S	50	149,00 flZn
M 16 x 40	S	50	141,00 flZn
M 16 x 45	S	50	147,00 flZn
M 16 x 50	S	50	157,00 flZn
M 16 x 55	S	50	182,00 flZn
M 16 x 60	S	50	190,00 flZn
M 16 x 65	S	25	207,00 flZn
M 16 x 70	S	25	211,00 flZn
M 16 x 75	S	25	222,00 flZn
M 16 x 80	S	25	222,00 flZn
M 16 x 90	S	25	275,00 flZn
M 16 x 100	S	25	310,00 flZn
M 16 x 110	S	25	355,00 flZn
M 16 x 120	S	25	420,00 flZn
M 20 x 65	S	25	360,00 flZn
M 20 x 70	S	25	370,00 flZn
M 20 x 75	S	25	365,00 flZn
M 20 x 80	S	25	395,00 flZn
M 20 x 90	S	25	430,00 flZn
M 20 x 100	S	25	490,00 flZn
M 20 x 110	S	25	530,00 flZn
M 20 x 120	S	25	610,00 flZn
M 20 x 130	S	25	740,00 flZn
M 20 x 140	S	25	980,00 flZn
M 20 x 150	S	25	1110,00 flZn
M 20 x 160	S	10	1390,00 flZn
M 20 x 170	S	10	1640,00 flZn
M 20 x 180	S	10	1500,00 flZn
M 24 x 80	S	25	890,00 flZn
M 24 x 90	S	10	1000,00 flZn
M 24 x 100	S	10	1050,00 flZn
M 24 x 110	S	10	1150,00 flZn
M 24 x 120	S	10	1200,00 flZn
M 24 x 130	S	10	1480,00 flZn
M 24 x 140	S	10	1800,00 flZn
M 24 x 150	S	10	2070,00 flZn
M 24 x 160	S	10	2210,00 flZn
M 24 x 170	S	10	2550,00 flZn
M 24 x 180	S	10	2700,00 flZn



- ✓ Große Artikelvielfalt
- ✓ Verlässliche Qualität
- ✓ Hohe Lieferbereitschaft



Wir versorgen Sie mit
 Verbindungselementen
 und Befestigungstechnik!

Abmessungen	VE Stück	€/100/Obf.
ISO	04766.000	

4766

14 H



Gewindestifte mit Kegelschuppe, mit Schlitz

Maße → **TI-19** Normumstellung → **TI-6**
 Werkstoffeigensch. → **TI-232** REACH → **TI-262**

Rostfrei → **S. 552**
 Messing, Kunststoff → **S. 638**

ISO 4766 → ersetzt DIN 551 (austauschbar)



M 1,6	x	2	K	100	15,10
M 1,6	x	3	K	100	12,10
M 2	x	3	K	200	10,60
M 2	x	4	K	200	10,70
M 2	x	5	K	200	10,80
M 2	x	6	K	200	11,10
M 2	x	8	K	200	11,20
M 2,5	x	3	K	200	11,20
M 2,5	x	4	K	200	10,80
M 2,5	x	5	K	200	11,10
M 2,5	x	6	K	200	11,20
M 2,5	x	8	K	200	11,30
M 2,5	x	10	K	200	11,80
M 2,5	x	16	K	200	13,40
M 3	x	3	S	1000	7,40
M 3	x	3	K	200	8,40
M 3	x	4	S	1000	4,15
M 3	x	4	K	200	5,00
M 3	x	5	S	1000	3,95
M 3	x	5	K	200	5,30
M 3	x	6	S	1000	4,10
M 3	x	6	K	200	5,45
M 3	x	8	S	1000	4,15
M 3	x	8	K	200	5,60
M 3	x	10	S	1000	4,15
M 3	x	10	K	200	5,60
M 3	x	12	S	1000	4,60
M 3	x	12	K	200	5,90
M 3	x	16	K	200	6,30
M 3	x	20	K	200	7,20
M 3	x	22	K	200	10,30
M 3	x	25	K	200	11,20
M 3	x	30	K	200	12,90
M 4	x	3	K	200	13,20
M 4	x	4	S	1000	4,15
M 4	x	4	K	200	5,10
M 4	x	5	S	1000	4,30
M 4	x	5	K	200	5,30
M 4	x	6	S	1000	4,30
M 4	x	6	K	200	5,30
M 4	x	8	S	1000	4,30
M 4	x	8	K	200	5,30
M 4	x	10	S	1000	4,60
M 4	x	10	K	200	5,50
M 4	x	12	S	1000	4,85
M 4	x	12	K	200	5,90
M 4	x	16	S	1000	5,40
M 4	x	16	K	200	6,60
M 4	x	20	K	200	7,20
M 4	x	25	K	200	7,90
M 4	x	30	K	200	9,40
M 4	x	40	K	100	42,50

Abmessungen	VE Stück	€/100/Obf.			
M 5	x	4	K	200	9,40
M 5	x	5	K	1000	5,50
M 5	x	5	K	200	6,50
M 5	x	6	S	1000	4,85
M 5	x	6	K	200	5,90
M 5	x	8	S	1000	5,30
M 5	x	8	K	200	6,20
M 5	x	10	S	1000	5,90
M 5	x	10	K	200	6,80
M 5	x	12	S	1000	6,20
M 5	x	12	K	200	7,30
M 5	x	16	S	1000	7,90
M 5	x	16	K	200	8,80
M 5	x	20	K	200	9,20
M 5	x	25	K	200	9,70
M 5	x	30	K	200	11,30
M 5	x	35	K	100	23,80
M 5	x	40	K	100	23,90
M 6	x	4	K	200	9,40
M 6	x	5	K	200	9,40
M 6	x	6	S	1000	5,90
M 6	x	6	K	200	6,80
M 6	x	8	S	1000	6,30
M 6	x	8	K	200	7,40
M 6	x	10	S	1000	6,70
M 6	x	10	K	200	7,70
M 6	x	12	S	1000	7,20
M 6	x	12	K	200	9,20
M 6	x	16	S	1000	8,20
M 6	x	16	K	200	9,40
M 6	x	18	K	200	9,60
M 6	x	20	S	1000	9,10
M 6	x	20	K	200	9,90
M 6	x	25	S	1000	10,50
M 6	x	25	K	100	11,80
M 6	x	30	K	100	13,80
M 6	x	35	K	100	16,30
M 6	x	40	K	100	56,00
M 6	x	50	K	100	60,00
M 6	x	60	K	100	66,00
M 8	x	5	K	100	23,90
M 8	x	6	K	100	16,70
M 8	x	8	K	100	9,40
M 8	x	10	K	100	10,50
M 8	x	12	S	1000	9,70
M 8	x	12	K	100	11,80
M 8	x	16	S	1000	10,30
M 8	x	16	K	100	12,40
M 8	x	18	K	100	14,30
M 8	x	20	S	1000	12,60
M 8	x	20	K	100	14,70
M 8	x	25	S	1000	14,10
M 8	x	25	K	100	16,10
M 8	x	30	K	100	19,70
M 8	x	35	K	100	22,30
M 8	x	40	K	100	30,00
M 8	x	45	K	100	46,00
M 8	x	50	K	100	48,00
M 8	x	60	K	100	53,00
M 8	x	70	K	100	57,00
M 8	x	80	K	100	62,00
M 10	x	6	K	100	33,00
M 10	x	8	K	100	33,00
M 10	x	10	K	100	32,20
M 10	x	12	K	100	23,50
M 10	x	16	K	100	25,00
M 10	x	20	K	100	27,50
M 10	x	25	K	100	30,00
M 10	x	30	K	100	32,50
M 10	x	35	K	100	34,50
M 10	x	40	K	100	37,00
M 10	x	45	K	100	67,00
M 10	x	50	K	100	69,50
M 10	x	60	K	100	82,00
M 10	x	70	K	100	84,00

Abmessungen	VE Stück	€/100/Obf.			
M 10	x	80	K	100	91,00
M 12	x	20	S	100	51,00
M 12	x	25	S	100	54,00
M 12	x	30	S	100	65,00
M 12	x	35	S	100	68,00
M 12	x	40	S	100	73,00
M 12	x	60	S	50	103,00

ISO	04766.010
-----	-----------

4766

14 H
galvanisch verzinkt

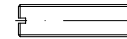

Gewindestifte mit Kegelschuppe, mit Schlitz

Maße → **TI-19** Normumstellung → **TI-6**
 Werkstoffeigensch. → **TI-232** REACH → **TI-262**
 Korrosionsschutz → **TI-228**

Rostfrei → **S. 552**
 Messing, Kunststoff → **S. 638**

ISO 4766 → ersetzt DIN 551 (austauschbar)



M 3	x	3	S	200	11,20 gal Zn
M 3	x	4	S	200	7,80 gal Zn
M 3	x	5	S	200	7,70 gal Zn
M 3	x	6	S	200	7,80 gal Zn
M 3	x	8	S	200	7,80 gal Zn
M 3	x	10	S	200	7,80 gal Zn
M 3	x	12	S	200	8,30 gal Zn
M 3	x	16	S	200	9,10 gal Zn
M 3	x	20	S	200	18,40 gal Zn
M 4	x	4	S	200	7,80 gal Zn
M 4	x	5	S	200	8,00 gal Zn
M 4	x	6	S	200	8,20 gal Zn
M 4	x	8	S	200	8,20 gal Zn
M 4	x	10	S	200	8,30 gal Zn
M 4	x	12	S	200	8,60 gal Zn
M 4	x	16	S	200	9,10 gal Zn
M 4	x	20	S	200	9,90 gal Zn
M 4	x	25	S	200	10,70 gal Zn
M 4	x	30	S	200	12,10 gal Zn
M 4	x	40	S	200	46,00 gal Zn
M 5	x	5	S	200	9,20 gal Zn
M 5	x	6	S	200	8,60 gal Zn
M 5	x	8	S	200	9,00 gal Zn
M 5	x	10	S	200	10,00 gal Zn
M 5	x	12	S	200	10,10 gal Zn
M 5	x	16	S	200	11,10 gal Zn
M 5	x	20	S	200	11,90 gal Zn
M 5	x	25	S	200	46,00 gal Zn
M 5	x	30	S	200	14,90 gal Zn
M 5	x	35	S	100	21,80 gal Zn
M 6	x	6	S	200	10,10 gal Zn
M 6	x	8	S	200	10,60 gal Zn
M 6	x	10	S	200	11,20 gal Zn
M 6	x	12	S	200	11,50 gal Zn
M 6	x	16	S	200	11,80 gal Zn
M 6	x	20	S	200	12,60 gal Zn
M 6	x	25	S	100	14,20 gal Zn
M 6	x	30	S	100	16,60 gal Zn
M 6	x	35	S	100	19,00 gal Zn
M 6	x	40	S	100	53,00 gal Zn
M 6	x	50	S	100	55,00 gal Zn
M 8	x	6	S	100	22,10 gal Zn
M 8	x	8	S	100	13,00 gal Zn

Abmessungen	VE	Stück	€/100/Obf.
M 8 x 10	S	100	14,90 gal Zn
M 8 x 12	S	100	16,30 gal Zn
M 8 x 16	S	100	18,40 gal Zn
M 8 x 20	S	100	19,20 gal Zn
M 8 x 25	S	100	21,60 gal Zn
M 8 x 30	S	100	23,90 gal Zn
M 8 x 35	S	100	27,00 gal Zn
M 8 x 40	S	100	34,50 gal Zn
M 8 x 45	S	100	51,00 gal Zn
M 8 x 50	S	100	53,00 gal Zn
M 8 x 60	S	100	57,00 gal Zn
M 10 x 6	S	100	43,00 gal Zn
M 10 x 10	S	100	28,00 gal Zn
M 10 x 12	S	100	26,50 gal Zn
M 10 x 16	S	100	28,00 gal Zn
M 10 x 20	S	100	30,50 gal Zn
M 10 x 25	S	100	33,00 gal Zn
M 10 x 30	S	100	35,50 gal Zn
M 10 x 35	S	100	33,00 gal Zn
M 10 x 40	S	100	42,00 gal Zn
M 10 x 45	S	100	72,00 gal Zn
M 10 x 50	S	100	54,00 gal Zn
M 10 x 60	S	100	59,00 gal Zn
M 10 x 70	S	100	89,00 gal Zn
M 10 x 80	S	100	97,00 gal Zn
M 12 x 12	S	100	56,00 gal Zn
M 12 x 16	S	100	56,00 gal Zn
M 12 x 20	S	100	56,00 gal Zn
M 12 x 25	S	100	59,00 gal Zn
M 12 x 30	S	100	69,00 gal Zn
M 12 x 35	S	100	74,00 gal Zn
M 12 x 40	S	100	79,00 gal Zn
M 12 x 45	S	100	85,00 gal Zn
M 12 x 50	S	100	97,00 gal Zn
M 12 x 60	S	50	109,00 gal Zn

DIN 05299.013
5299 Stahl Form C
 galvanisch verzinkt

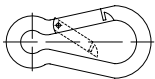

**Karabinerhaken,
C = birnformig**

Maße → TI-133 Korrosionsschutz → TI-228

RoHS ✓ REACH SVHC free

Länge x Draht Ø

C 40 x 4	S	100	330,00 gal Zn
C 50 x 5	S	100	340,00 gal Zn
C 60 x 6	S	100	400,00 gal Zn
C 70 x 7	S	50	510,00 gal Zn
C 80 x 8	S	50	610,00 gal Zn
C 100 x 10	S	50	1030,00 gal Zn

Abmessungen VE Stück €/100/Obf.
 DIN 05406.000
5406 Stahl MB

**Mutternsicherungen/
Sicherungsbleche
für Nutmuttern DIN 981**

Maße → TI-98

RoHS ✓ REACH SVHC free

Typ / Nr. / für Nutmutter

MB 0/M10 x 0,75	S	25	170,00
MB 1/M 12 x 1	S	25	126,00
MB 2/M 15 x 1	S	25	117,00
MB 3/M 17 x 1	S	25	126,00
MB 4/M 20 x 1	S	25	147,00
MB 5/M 25 x 1,5	S	25	132,00
MB 6/M 30 x 1,5	S	25	132,00
MB 7/M 35 x 1,5	S	25	132,00
MB 8/M 40 x 1,5	S	25	132,00
MB 9/M 45 x 1,5	S	25	157,00
MB 10/M 50 x 1,5	S	25	177,00
MB 11/M 55 x 2	S	10	227,00
MB 12/M 60 x 2	S	10	260,00
MB 13/M 65 x 2	S	10	305,00
MB 14/M 70 x 2	S	10	345,00
MB 15/M 75 x 2	S	10	370,00
MB 16/M 80 x 2	S	10	455,00
MB 17/M 85 x 2	S	10	485,00
MB 18/M 90 x 2	S	10	530,00
MB 19/M 95 x 2	S	10	600,00
MB 20/M100 x 2	S	10	670,00
MB 21/M105 x 2	S	10	840,00
MB 22/M110 x 2	S	10	890,00
MB 23/M115 x 2	S	10	1120,00
MB 24/M120 x 2	S	10	1120,00
MB 25/M125 x 2	S	5	2120,00
MB 26/M130 x 2	S	5	2120,00
MB 27/M135 x 2	S	5	3100,00
MB 28/M140 x 2	S	5	2800,00
MB 29/M145 x 2	S	5	4950,00
MB 30/M150 x 2	S	5	3350,00

Abmessungen VE Stück €/100/Obf.
 DIN 05586.014
5586 Stahl Form B
 galvanisch verzinkt

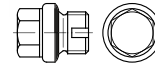

**Verschlusschrauben
mit Bund und Entlüftung,
B = mit aufgeschmolzener Dichtung**

Maße → TI-24 REACH → TI-262
 Korrosionsschutz → TI-228

RoHS ✓

BG 1/8 A	S	100	730,00 gal Zn
BG 1/4 A	S	100	730,00 gal Zn
BG 1/2 A	S	50	1020,00 gal Zn
BG 3/4 A	S	25	1660,00 gal Zn
BG 1 A	S	25	2110,00 gal Zn
BG 1 1/2 A	S	25	5200,00 gal Zn
BG 2 A	S	10	7900,00 gal Zn

DIN 06304.534
6304 5.8 Form E
 brüniert

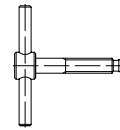

**Knebelschrauben mit festem Knebel,
E = ohne Druckstück**

Druckstücke → DIN 6311/S

Maße → TI-127 REACH → TI-262

RoHS ✓

EM 6 x 40	S	1	1690,00 brün
EM 6 x 50	S	1	1750,00 brün
EM 8 x 50	S	1	2030,00 brün
EM 8 x 60	S	1	2150,00 brün
EM 10 x 60	S	1	2400,00 brün
EM 10 x 70	S	1	2600,00 brün
EM 12 x 70	S	1	3000,00 brün
EM 12 x 80	S	1	3150,00 brün
EM 16 x 75	S	1	4000,00 brün
EM 16 x 110	S	1	4400,00 brün
EM 20 x 90	S	1	6200,00 brün
EM 20 x 110	S	1	6600,00 brün

Abmessungen	VE Stück	€/100/Obf.
DIN	06305.530	
6305	5	brüniert

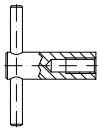

Knebelmuttern mit festem Knebel

Maße → **TI-127** REACH → **TI-262**



M 10	S	1	2030,00 brün
M 12	S	1	2330,00 brün
M 16	S	1	3150,00 brün
M 20	S	1	4750,00 brün

DIN	06306.534	
6306	5.8	Form D brüniert

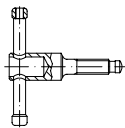

Knebelschrauben mit losem Knebel, D = ohne Druckstück

Druckstücke → DIN 6311/S

Maße → **TI-128** REACH → **TI-262**



DM 10	x	40	S	1	3300,00 brün
DM 10	x	50	S	1	3350,00 brün
DM 12	x	50	S	1	3950,00 brün
DM 12	x	60	S	1	4000,00 brün
DM 16	x	55	S	1	5000,00 brün
DM 16	x	70	S	1	5300,00 brün
DM 16	x	90	S	1	5600,00 brün
DM 20	x	70	S	1	7300,00 brün
DM 20	x	90	S	1	7800,00 brün

Abmessungen	VE Stück	€/100/Obf.
DIN	06307.530	
6307	5	brüniert

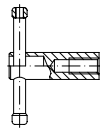

Knebelmuttern mit losem Knebel

Maße → **TI-128** REACH → **TI-262**



M 10	S	1	2900,00 brün
M 12	S	1	3150,00 brün
M 16	S	1	4100,00 brün
M 20	S	1	5700,00 brün

DIN	06311.004	
6311	Stahl	Form S



Druckstücke, S = mit Sprengring

- Knebelschrauben → DIN 6304/6306
- Druckstifte → DIN 6332

Maße → **TI-128** REACH → **TI-262**



Außen Ø – für Schraube / Stift M

S 12 M 6	S	10	590,00
S 16 M 8	S	10	600,00
S 20 M 10	S	10	710,00
S 25 M 12	S	10	830,00
S 32 M 16	S	10	1250,00
S 40 M 20	S	5	1770,00

DIN	06319.003	
6319	Stahl	Form C

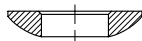

Kugelscheiben, einsatzgehärtet

Maße → **TI-112**



Innen Ø x Außen Ø x Dicke

C 6,4	x	12	x	2,3	S	50	94,00
C 8,4	x	17	x	3,2	S	50	113,00
C 10,5	x	21	x	4	S	50	158,00
C 13	x	24	x	4,6	S	50	181,00
C 17	x	30	x	5,3	S	25	290,00

Abmessungen	VE Stück	€/100/Obf.					
C21	x	36	x	6,3	S	10	440,00
C25	x	44	x	8,2	S	10	720,00
C31	x	56	x	11,2	S	1	1230,00
C37	x	68	x	14	S	1	2800,00
C43	x	78	x	17	S	1	3950,00
C50	x	92	x	21	S	1	5900,00

DIN	06319.013	
6319	Stahl	Form C galvanisch verzinkt

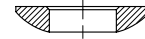

Kugelscheiben, einsatzgehärtet

Maße → **TI-112** Korrosionsschutz → **TI-228**

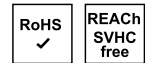

Innen Ø x Außen Ø x Dicke

C 13	x	24	x	4,6	S	50	265,00 gal Zn
C 17	x	30	x	5,3	S	25	415,00 gal Zn
C 21	x	36	x	6,3	S	10	620,00 gal Zn
C 25	x	44	x	8,2	S	10	1080,00 gal Zn
C 31	x	56	x	11,2	S	1	1710,00 gal Zn
C 37	x	68	x	14	S	1	4500,00 gal Zn

DIN	06319.004	
6319	Stahl	Form D

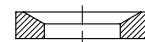

Kegelpfannen, einsatzgehärtet

Außen Ø = Außen Ø von Kugelscheiben

Maße → **TI-112**

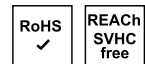

Innen Ø x Außen Ø x Dicke

D 7,1	x	12	x	2,8	S	50	78,00
D 9,6	x	17	x	3,5	S	50	120,00
D 12	x	21	x	4,2	S	50	167,00
D 14,2	x	24	x	5	S	50	194,00
D 19	x	30	x	6,2	S	25	310,00
D 23,2	x	36	x	7,5	S	10	495,00
D 28	x	44	x	9,5	S	10	790,00
D 35	x	56	x	12	S	1	1310,00
D 42	x	68	x	14	S	1	2900,00
D 49	x	78	x	18	S	1	2950,00
D 56	x	92	x	22	S	1	3700,00

Abmessungen	VE Stück	€/100/Obf.
DIN 06319.014		
6319	Stahl	Form D
	galvanisch verzinkt*	

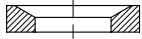

Kegelfpannen, einsatzgehärtet

Außen Ø = Außen Ø von Kugelscheiben,
*getempert

Maße → **TI-112**

Korrosionsschutz → **TI-228**



Innen Ø x Außen Ø x Dicke

D 14,2	x	24	x	5	S	50	295,00 gal Zn
D 19	x	30	x	6,2	S	25	460,00 gal Zn
D 23,2	x	36	x	7,5	S	10	740,00 gal Zn
D 28	x	44	x	9,5	S	10	1190,00 gal Zn
D 35	x	56	x	12	S	1	1950,00 gal Zn
D 42	x	68	x	14	S	1	5500,00 gal Zn

DIN	06319.005	Stahl	Form G
6319			

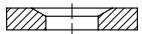

Kegelfpannen, vergütet

Außen Ø > Außen Ø von Kugelscheiben

Maße → **TI-112**

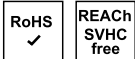

Innen Ø x Außen Ø x Dicke

G 12	x	30	x	5	S	50	315,00
G 14,2	x	36	x	6	S	50	390,00
G 19	x	44	x	7	S	25	560,00
G 23,2	x	50	x	8	S	10	840,00
G 28	x	60	x	10	S	10	1460,00
G 35	x	68	x	12	S	1	2290,00

Abmessungen	VE Stück	€/100/Obf.
DIN 06325.000		
6325	Stahl gehärtet	m6

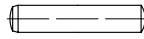

Zylinderstifte, Toleranzfeld m6

Maße → **TI-116**

DIN 6325 → wird ersetzt durch ISO 8734



1 m6	x	4	S	1000	24,40
1 m6	x	5	S	1000	25,50
1 m6	x	6	S	1000	26,00
1 m6	x	8	S	1000	26,50
1 m6	x	10	S	1000	27,00
1 m6	x	12	S	1000	28,00
1,5 m6	x	4	S	1000	21,00
1,5 m6	x	5	S	1000	21,00
1,5 m6	x	6	S	1000	21,50
1,5 m6	x	8	S	1000	22,30
1,5 m6	x	10	S	1000	23,00
1,5 m6	x	12	S	1000	23,90
1,5 m6	x	14	S	1000	24,40
1,5 m6	x	16	S	1000	25,50
1,5 m6	x	20	S	1000	26,50
2 m6	x	4	S	1000	22,10
2 m6	x	5	S	1000	22,10
2 m6	x	6	S	1000	22,30
2 m6	x	8	S	1000	22,60
2 m6	x	10	S	1000	23,30
2 m6	x	12	S	1000	24,10
2 m6	x	14	S	1000	24,60
2 m6	x	16	S	1000	26,00
2 m6	x	18	S	1000	26,50
2 m6	x	20	S	1000	27,00
2 m6	x	24	S	1000	32,50
2 m6	x	30	S	1000	47,00
2 m6	x	32	S	500	48,00
2 m6	x	50	S	500	54,00
2,5 m6	x	6	S	1000	22,60
2,5 m6	x	8	S	1000	23,00
2,5 m6	x	10	S	1000	23,90
2,5 m6	x	12	S	1000	24,40
2,5 m6	x	14	S	1000	25,50
2,5 m6	x	16	S	1000	26,50
2,5 m6	x	18	S	1000	27,00
2,5 m6	x	20	S	1000	28,00
2,5 m6	x	24	S	1000	38,50
2,5 m6	x	26	S	1000	41,00
2,5 m6	x	28	S	1000	44,00
3 m6	x	6	S	500	23,30
3 m6	x	8	S	500	23,30
3 m6	x	10	S	500	24,10
3 m6	x	12	S	500	24,60
3 m6	x	14	S	500	26,00
3 m6	x	16	S	500	27,00
3 m6	x	18	S	500	27,50
3 m6	x	20	S	500	28,50
3 m6	x	22	S	500	29,50
3 m6	x	24	S	500	31,00
3 m6	x	26	S	500	31,50
3 m6	x	28	S	500	32,50
3 m6	x	30	S	500	33,50
3 m6	x	32	S	500	34,00
3 m6	x	40	S	500	49,50
3 m6	x	45	S	500	57,00

Abmessungen	VE Stück	€/100/Obf.			
3 m6	x	50	S	500	67,00
4 m6	x	6	S	500	23,30
4 m6	x	8	S	500	25,50
4 m6	x	10	S	500	27,00
4 m6	x	12	S	500	29,00
4 m6	x	14	S	500	31,00
4 m6	x	16	S	500	31,50
4 m6	x	18	S	500	33,50
4 m6	x	20	S	500	34,50
4 m6	x	22	S	500	36,00
4 m6	x	24	S	500	38,00
4 m6	x	26	S	500	39,00
4 m6	x	28	S	500	41,50
4 m6	x	30	S	500	42,50
4 m6	x	32	S	500	44,00
4 m6	x	36	S	500	47,00
4 m6	x	40	S	500	53,00
4 m6	x	45	S	500	63,00
4 m6	x	50	S	500	76,00
4 m6	x	60	S	500	106,00
5 m6	x	8	S	500	33,50
5 m6	x	10	S	500	33,50
5 m6	x	12	S	500	33,50
5 m6	x	14	S	500	34,50
5 m6	x	16	S	500	37,00
5 m6	x	18	S	500	39,50
5 m6	x	20	S	500	41,50
5 m6	x	22	S	500	61,00
5 m6	x	24	S	500	46,00
5 m6	x	26	S	500	47,50
5 m6	x	28	S	500	51,00
5 m6	x	30	S	500	53,00
5 m6	x	32	S	500	54,00
5 m6	x	36	S	500	58,00
5 m6	x	40	S	500	63,00
5 m6	x	45	S	500	68,00
5 m6	x	50	S	500	82,00
5 m6	x	55	S	500	89,00
5 m6	x	60	S	500	96,00
5 m6	x	70	S	500	112,00
6 m6	x	8	S	200	38,00
6 m6	x	10	S	200	38,00
6 m6	x	12	S	200	38,00
6 m6	x	14	S	200	41,00
6 m6	x	16	S	200	43,00
6 m6	x	18	S	200	46,00
6 m6	x	20	S	200	48,50
6 m6	x	22	S	200	51,00
6 m6	x	24	S	200	54,00
6 m6	x	26	S	200	57,00
6 m6	x	28	S	200	60,00
6 m6	x	30	S	200	63,00
6 m6	x	32	S	200	67,00
6 m6	x	36	S	200	73,00
6 m6	x	40	S	200	77,00
6 m6	x	45	S	200	84,00
6 m6	x	50	S	200	92,00
6 m6	x	55	S	200	105,00
6 m6	x	60	S	200	112,00
6 m6	x	70	S	200	125,00
6 m6	x	80	S	200	166,00
6 m6	x	90	S	200	189,00
6 m6	x	100	S	200	211,00
8 m6	x	10	S	100	77,00
8 m6	x	12	S	100	71,00
8 m6	x	14	S	100	71,00
8 m6	x	16	S	100	77,00
8 m6	x	18	S	100	82,00
8 m6	x	20	S	100	85,00
8 m6	x	22	S	100	90,00
8 m6	x	24	S	100	94,00
8 m6	x	26	S	100	96,00
8 m6	x	28	S	100	101,00
8 m6	x	30	S	100	106,00
8 m6	x	32	S	100	111,00

Abmessungen	VE	Stück	€/100/Obf.
8 m6 x 36	S	100	117,00
8 m6 x 40	S	100	125,00
8 m6 x 45	S	100	136,00
8 m6 x 50	S	100	146,00
8 m6 x 55	S	100	155,00
8 m6 x 60	S	100	166,00
8 m6 x 70	S	100	190,00
8 m6 x 80	S	100	207,00
8 m6 x 90	S	100	229,00
8 m6 x 100	S	100	250,00
8 m6 x 120	S	100	295,00
10 m6 x 16	S	100	124,00
10 m6 x 20	S	100	126,00
10 m6 x 22	S	100	130,00
10 m6 x 24	S	100	131,00
10 m6 x 26	S	100	137,00
10 m6 x 28	S	100	143,00
10 m6 x 30	S	100	148,00
10 m6 x 32	S	100	155,00
10 m6 x 36	S	100	176,00
10 m6 x 40	S	100	186,00
10 m6 x 45	S	100	205,00
10 m6 x 50	S	100	216,00
10 m6 x 55	S	100	234,00
10 m6 x 60	S	100	246,00
10 m6 x 70	S	100	280,00
10 m6 x 80	S	100	310,00
10 m6 x 90	S	100	345,00
10 m6 x 100	S	100	380,00
10 m6 x 110	S	100	425,00
10 m6 x 120	S	100	520,00
12 m6 x 20	S	100	184,00
12 m6 x 24	S	100	200,00
12 m6 x 26	S	100	200,00
12 m6 x 28	S	100	200,00
12 m6 x 30	S	100	205,00
12 m6 x 32	S	100	213,00
12 m6 x 36	S	100	229,00
12 m6 x 40	S	100	244,00
12 m6 x 45	S	100	265,00
12 m6 x 50	S	100	285,00
12 m6 x 55	S	100	305,00
12 m6 x 60	S	100	325,00
12 m6 x 70	S	100	410,00
12 m6 x 80	S	100	445,00
12 m6 x 90	S	100	485,00
12 m6 x 100	S	100	530,00
12 m6 x 110	S	100	590,00
12 m6 x 120	S	100	630,00
14 m6 x 50	S	50	590,00
14 m6 x 60	S	50	680,00
14 m6 x 70	S	50	790,00
14 m6 x 80	S	50	950,00
14 m6 x 90	S	50	1030,00
14 m6 x 100	S	50	1110,00
14 m6 x 120	S	50	1310,00
16 m6 x 30	S	50	540,00
16 m6 x 40	S	50	570,00
16 m6 x 45	S	50	610,00
16 m6 x 50	S	50	650,00
16 m6 x 55	S	50	680,00
16 m6 x 60	S	50	740,00
16 m6 x 70	S	50	850,00
16 m6 x 80	S	50	990,00
16 m6 x 90	S	50	1050,00
16 m6 x 100	S	1	1140,00
16 m6 x 110	S	1	1260,00
16 m6 x 120	S	1	1350,00
20 m6 x 40	S	25	890,00
20 m6 x 50	S	25	910,00
20 m6 x 60	S	25	990,00
20 m6 x 80	S	25	1260,00
20 m6 x 100	S	25	1470,00
20 m6 x 120	S	25	1720,00

Abmessungen	VE	Stück	€/100/Obf.
DIN 06330.102			

6330 10 Form B

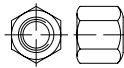

Sechskantmuttern mit einer Höhe von 1,5 d, B = kugelige und ebene Auflagefläche

Maße → TI-64 Werkstoffeigensch. → TI-233
Rostfrei → S. 553

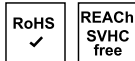

Gewinde – Schlüsselweite

BM 6 SW 10	S	50	77,00
BM 8 SW 13	S	50	95,00
BM 10 SW 16	S	50	107,00
BM 12 SW 18	S	25	161,00
BM 14 SW 22	S	25	365,00
BM 16 SW 24	S	25	265,00
BM 18 SW 27	S	25	440,00
BM 20 SW 30	S	10	455,00
BM 22 SW 32	S	10	1320,00
BM 24 SW 36	S	10	720,00
BM 27 SW 41	S	1	1760,00
BM 30 SW 46	S	1	1420,00

Abmessungen	VE	Stück	€/100/Obf.
DIN 06330.112			

6330 10 Form B galvanisch verzinkt

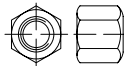

Sechskantmuttern mit einer Höhe von 1,5 d, B = kugelige und ebene Auflagefläche

Maße → TI-64 Korrosionsschutz → TI-228
Werkstoffeigensch. → TI-233
Rostfrei → S. 553



Gewinde – Schlüsselweite

BM 6 SW 10	S	50	86,00 gal Zn
BM 8 SW 13	S	50	103,00 gal Zn
BM 10 SW 16	S	50	130,00 gal Zn
BM 12 SW 18	S	25	197,00 gal Zn
BM 14 SW 22	S	25	445,00 gal Zn
BM 16 SW 24	S	25	325,00 gal Zn
BM 18 SW 27	S	25	530,00 gal Zn
BM 20 SW 30	S	10	560,00 gal Zn
BM 24 SW 36	S	10	840,00 gal Zn
BM 27 SW 41	S	1	2040,00 gal Zn
BM 30 SW 46	S	1	1520,00 gal Zn

Abmessungen	VE	Stück	€/100/Obf.
DIN 06331.100			

6331 10

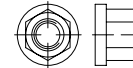

Sechskantmuttern mit Bund, mit einer Höhe von 1,5 d

Maße → TI-64 Werkstoffeigensch. → TI-233
Rostfrei → S. 553



Gewinde – Schlüsselweite

M 6 SW 10	S	100	79,00
M 8 SW 13	S	50	174,00
M 10 SW 16	S	50	265,00
M 12 SW 18	S	25	325,00
M 14 SW 22	S	10	630,00
M 16 SW 24	S	10	530,00
M 18 SW 27	S	10	690,00
M 20 SW 30	S	10	690,00
M 22 SW 32	S	1	1420,00
M 24 SW 36	S	1	1280,00
M 27 SW 41	S	1	3000,00
M 30 SW 46	S	1	2150,00
M 36 SW 55	S	1	5600,00
M 42 SW 65	S	1	9900,00

Abmessungen	VE	Stück	€/100/Obf.
DIN 06331.110			

6331 10 galvanisch verzinkt



Sechskantmuttern mit Bund, mit einer Höhe von 1,5 d

Maße → TI-64 Korrosionsschutz → TI-228
Werkstoffeigensch. → TI-233
Rostfrei → S. 553

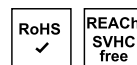

Gewinde – Schlüsselweite

M 6 SW 10	S	100	105,00 gal Zn
M 8 SW 13	S	50	193,00 gal Zn
M 10 SW 16	S	50	310,00 gal Zn
M 12 SW 18	S	25	385,00 gal Zn
M 14 SW 22	S	10	780,00 gal Zn
M 16 SW 24	S	10	670,00 gal Zn
M 20 SW 30	S	10	1050,00 gal Zn
M 24 SW 36	S	1	1920,00 gal Zn
M 27 SW 41	S	1	3650,00 gal Zn
M 30 SW 46	S	1	3050,00 gal Zn

Abmessungen	VE Stück	€/100/Obf.
DIN	06332.534	
6332	5.8	Form IS
	brüniert	

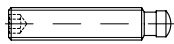

Gewindestifte mit Druckzapfen, mit gehärtetem Zapfen, IS = mit Innensechskant

Druckstücke → DIN 6311

Maße → **TI-129** REACH → **TI-262**
Werkstoffeigensch. → **TI-233**

Ausführung mit Schlitz (S/Sz) auf Anfrage



IS M 6	x	30	S	1	380,00 brün
IS M 6	x	35	S	10	390,00 brün
IS M 6	x	40	S	10	390,00 brün
IS M 6	x	45	S	10	395,00 brün
IS M 6	x	50	S	10	410,00 brün
IS M 8	x	35	S	10	425,00 brün
IS M 8	x	40	S	10	440,00 brün
IS M 8	x	45	S	10	460,00 brün
IS M 8	x	50	S	10	480,00 brün
IS M 8	x	60	S	10	510,00 brün
IS M 8	x	70	S	10	560,00 brün
IS M 10	x	45	S	10	580,00 brün
IS M 10	x	50	S	10	590,00 brün
IS M 10	x	60	S	10	620,00 brün
IS M 10	x	80	S	10	780,00 brün
IS M 12	x	50	S	10	720,00 brün
IS M 12	x	60	S	10	740,00 brün
IS M 12	x	65	S	10	760,00 brün
IS M 12	x	70	S	10	790,00 brün
IS M 12	x	80	S	10	830,00 brün
IS M 12	x	100	S	10	920,00 brün
IS M 16	x	65	S	1	1070,00 brün
IS M 16	x	75	S	1	1170,00 brün
IS M 16	x	80	S	1	1210,00 brün
IS M 16	x	100	S	1	1410,00 brün
IS M 16	x	125	S	1	1520,00 brün
IS M 20	x	80	S	1	1950,00 brün
IS M 20	x	100	S	1	2150,00 brün
IS M 20	x	125	S	1	2360,00 brün
IS M 20	x	150	S	1	2600,00 brün

Abmessungen	VE Stück	€/100/Obf.
~DIN	06334.100	
6334	10	

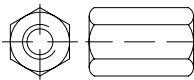

Sechskantmuttern mit einer Höhe von 3 d

Maße → **TI-64** Werkstoffeigensch. → **TI-233**

Rostfrei → **S. 553**

Runde und Sechskant-Muffen
→ Artikel 88088/88087

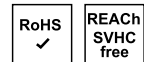

Innengewinde - Schlüsselweite

M 8 SW 13	S	100	222,00
M 10 SW 17	S	50	265,00
M 12 SW 19	S	50	335,00
M 16 SW 24	S	25	670,00
M 20 SW 30	S	25	1130,00
M 24 SW 36	S	10	1890,00
M 30 SW 46	S	10	3800,00
M 36 SW 55	S	1	7300,00

~DIN	06334.110
6334	10
	galvanisch verzinkt

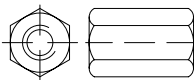

Sechskantmuttern mit einer Höhe von 3 d

Maße → **TI-64** Korrosionsschutz → **TI-228**

Werkstoffeigensch. → **TI-233**

Rostfrei → **S. 553**

Runde und Sechskant-Muffen
→ Artikel 88088/88087

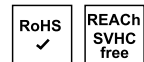

Innengewinde - Schlüsselweite

M 6 SW 10	S	100	218,00 gal Zn
M 8 SW 13	S	100	241,00 gal Zn
M 10 SW 17	S	50	280,00 gal Zn
M 12 SW 19	S	50	370,00 gal Zn
M 16 SW 24	S	25	740,00 gal Zn
M 20 SW 30	S	25	1200,00 gal Zn
M 24 SW 36	S	10	2040,00 gal Zn
M 30 SW 46	S	10	5400,00 gal Zn

Abmessungen	VE Stück	€/100/Obf.
DIN	06335.004	
6335	Grauguss	Form D

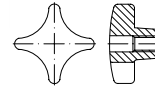

Kreuzgriffe, D = mit Gewinde-Durchloch

Maße → **TI-126**

Andere Formen/Ausführungen auf Anfrage



Griff Ø - Innengewinde

D 32 M 6	S	10	680,00
D 40 M 8	S	10	760,00
D 50 M 10	S	10	990,00
D 63 M 12	S	10	1410,00
D 80 M 16	S	5	2410,00
D 100 M 20	S	5	5100,00

DIN	06336.004
6336	Grauguss
	Form D

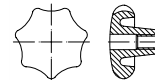

Sterngriffe, D = mit Gewinde-Durchloch

Maße → **TI-126**

Andere Formen/Ausführungen auf Anfrage



Griff Ø - Innengewinde

D 32 M 6	S	10	730,00
D 40 M 8	S	10	880,00
D 50 M 8	S	10	1280,00
D 50 M 10	S	10	1740,00
D 63 M 10	S	10	1770,00
D 63 M 12	S	10	2410,00
D 80 M 12	S	5	3300,00
D 80 M 16	S	5	4100,00

Abmessungen	VE Stück	€/100/Obf.
DIN	06340.000	
6340	Stahl vergütet	

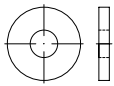

Scheiben für Spannzeuge, vergütet

Maße → TI-84

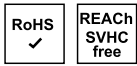

Innen Ø x Außen Ø x Dicke

6,4	x	17	x	3	S	100	114,00
8,4	x	23	x	4	S	100	114,00
10,5	x	28	x	4	S	100	135,00
13	x	35	x	5	S	50	180,00
15	x	40	x	5	S	100	255,00
17	x	45	x	6	S	50	255,00
21	x	50	x	6	S	25	395,00
25	x	60	x	8	S	10	610,00
31	x	68	x	10	S	10	1110,00

DIN	06340.010
6340	Stahl vergütet galvanisch verzinkt

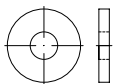

Scheiben für Spannzeuge, vergütet

getempert

Achtung! Warneinblender zu Wasserstoffversprödung beachten.

Maße → TI-84

Korrosionsschutz → TI-228



Innen Ø x Außen Ø x Dicke

6,4	x	17	x	3	S	100	128,00 gal Zn
8,4	x	23	x	4	S	100	138,00 gal Zn
10,5	x	28	x	4	S	100	164,00 gal Zn
13	x	35	x	5	S	50	204,00 gal Zn
15	x	40	x	5	S	100	290,00 gal Zn
17	x	45	x	6	S	50	290,00 gal Zn

Wichtiger Hinweis!



Bei galvanischen Überzügen auf hochfesten und federharten Teilen ($\geq 1000 \text{ N/mm}^2$ oder $\geq 320 \text{ HV}$) ist die Gefahr einer Wasserstoffversprödung (Sprödbbruchgefahr) nicht mit Sicherheit auszuschließen (ISO 4042). Durch eine rechtzeitig eingeleitete thermische Nachbehandlung (Tempern) kann die Gefahr eines wasserstoffinduzierten Sprödbrechens im Regelfall verringert werden. Da aber ein Restrisiko nicht mit Sicherheit auszuschließen ist, erfolgen galvanische Überzüge auf derartigen Teilen nur auf ausdrücklichen Wunsch und auf Risiko des Auftraggebers.

Abmessungen	VE Stück	€/100/Obf.					
21	x	50	x	6	S	25	445,00 gal Zn
25	x	60	x	8	S	10	690,00 gal Zn
31	x	68	x	10	S	10	1180,00 gal Zn

DIN	06796.030
6796	Federstahl phosphatiert

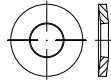

Spannscheiben für Schraubverbindungen

Rostfrei → S. 553

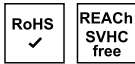

Nenn Ø x Außen Ø x Dicke

3	x	7	x	0,6	S	10000	1,55
3	x	7	x	0,6	K	500	2,40
4	x	9	x	1	S	5000	2,40
4	x	9	x	1	K	250	3,95
5	x	11	x	1,2	S	2500	3,45
5	x	11	x	1,2	K	250	5,10
6	x	14	x	1,5	S	1000	5,90
6	x	14	x	1,5	K	250	7,80
8	x	18	x	2	S	1000	11,90
8	x	18	x	2	K	250	14,40
10	x	23	x	2,5	S	500	31,00
10	x	23	x	2,5	K	100	38,00
12	x	29	x	3	S	250	58,00
12	x	29	x	3	K	100	67,00
14	x	35	x	3,5	S	100	103,00
16	x	39	x	4	S	100	115,00
18	x	42	x	4,5	S	100	183,00
20	x	45	x	5	S	100	226,00
22	x	49	x	5,5	S	100	1050,00
24	x	56	x	6	S	50	1120,00
27	x	60	x	6,5	S	50	1520,00
30	x	70	x	7	S	50	1750,00

DIN	06796.014
6796	Federstahl mechanisch verzinkt

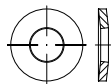

Spannscheiben für Schraubverbindungen

Rostfrei → S. 553

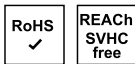

Nenn Ø x Außen Ø x Dicke

5	x	11	x	1,2	S	2500	3,75 mech Zn
6	x	14	x	1,5	S	2500	6,50 mech Zn
8	x	18	x	2	S	1000	13,20 mech Zn
10	x	23	x	2,5	S	500	34,00 mech Zn
12	x	29	x	3	S	250	69,00 mech Zn
14	x	35	x	3,5	S	100	113,00 mech Zn
16	x	39	x	4	S	100	128,00 mech Zn

Abmessungen	VE Stück	€/100/Obf.
DIN	06796.309	
6796	Federstahl fZn/TL480h	

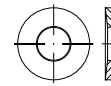

Spannscheiben für Schraubverbindungen

Korrosionsbeständigkeit NSS: 480h RR

Rostfrei → S. 553



Nenn Ø x Außen Ø x Dicke

6	x	14	x	1,5	S	2500	6,50 fZnnc
8	x	18	x	2	S	1000	13,20 fZnnc
10	x	23	x	2,5	S	500	34,00 fZnnc
12	x	29	x	3	S	250	69,00 fZnnc
14	x	35	x	3,5	S	100	113,00 fZnnc
16	x	39	x	4	S	100	128,00 fZnnc
18	x	42	x	4,5	S	100	193,00 fZnnc
20	x	45	x	5	S	100	249,00 fZnnc
22	x	49	x	5,5	S	100	1170,00 fZnnc
24	x	56	x	6	S	50	1310,00 fZnnc
27	x	60	x	6,5	S	50	1760,00 fZnnc
30	x	70	x	7	S	50	2070,00 fZnnc

~DIN	06797.001
6797	Federstahl Form A

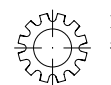

Zahnscheiben, A = außengezähnt

Maße → TI-99

Rostfrei → S. 553



A 3,2	S	5000	1,60
A 3,2	K	500	2,90
A 4,3	S	5000	1,75
A 4,3	K	500	3,30
A 5,3	S	3000	2,20
A 5,3	K	500	3,60
A 6,4	S	2000	2,60
A 6,4	K	500	4,10
A 8,4	S	2000	4,80
A 8,4	K	250	7,30
A 10,5	S	1000	7,30
A 10,5	K	250	9,90
A 13	S	750	10,10
A 13	K	100	14,80
A 15	S	500	18,20
A 15	K	100	23,00
A 17	S	500	24,60
A 17	K	100	31,00
A 19	K	100	47,00

Abmessungen	VE	Stück	€/100/Obf.
A 21	S	200	44,00
A 21	K	100	52,00
A 23	S	100	63,00
A 25	S	100	67,00
A 31	S	100	105,00

~DIN 06797.011

6797 Federstahl Form A
galvanisch verzinkt

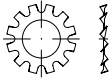

**Zahnscheiben,
A = außengezahnt**

Maße → TI-99 Korrosionsschutz → TI-228
Rostfrei → S. 553

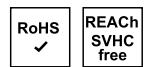

A 3,2	S	5000	1,85 gal Zn
A 3,2	K	500	3,15 gal Zn
A 3,7	K	500	3,30 gal Zn
A 4,3	S	5000	1,95 gal Zn
A 4,3	K	500	3,40 gal Zn
A 5,3	S	3000	2,70 gal Zn
A 5,3	K	500	4,15 gal Zn
A 6,4	S	2000	3,00 gal Zn
A 6,4	K	500	4,45 gal Zn
A 7,4	K	250	7,80 gal Zn
A 8,4	S	2000	5,90 gal Zn
A 8,4	K	250	8,40 gal Zn
A 10,5	S	1000	8,90 gal Zn
A 10,5	K	250	11,70 gal Zn
A 13	S	750	12,30 gal Zn
A 13	K	100	17,40 gal Zn
A 15	K	100	27,00 gal Zn
A 17	S	500	29,00 gal Zn
A 17	K	100	36,00 gal Zn
A 19	K	100	54,00 gal Zn
A 21	S	200	53,00 gal Zn
A 21	K	100	61,00 gal Zn
A 23	S	100	74,00 gal Zn
A 25	S	100	78,00 gal Zn
A 28	S	100	106,00 gal Zn
A 31	S	100	123,00 gal Zn

~DIN 06797.081

6797 Federstahl Form A
galv. verz. 8 DiSP*

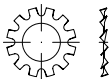

**Zahnscheiben,
A = außengezahnt**

* $\varnothing 6$ Mindestschichtdicke 5µm,
Korrosionsbeständigkeit NSS: 72h WR, 120h RR

Maße → TI-99 Korrosionsschutz → TI-228
Rostfrei → S. 553

A 3,2	K	500	17,20 gal ZnDi
A 4,3	K	500	18,50 gal ZnDi
A 5,3	K	500	22,50 gal ZnDi

Abmessungen	VE	Stück	€/100/Obf.
A 6,4	K	500	24,10 gal ZnDi
A 8,4	K	250	46,50 gal ZnDi
A 10,5	K	250	65,00 gal ZnDi

~DIN 06797.004

6797 Federstahl Form I

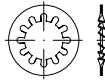

**Zahnscheiben,
I = innengezahnt**

Maße → TI-99
Rostfrei → S. 554

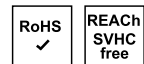

I 3,2	S	5000	1,60
I 3,2	K	500	2,90
I 4,3	S	5000	1,75
I 4,3	K	500	3,30
I 5,3	S	3000	2,20
I 5,3	K	500	3,60
I 6,4	S	2000	2,60
I 6,4	K	500	4,10
I 7,4	K	250	4,95
I 8,4	S	2000	4,80
I 8,4	K	250	7,30
I 10,5	S	1000	7,30
I 10,5	K	250	9,90
I 13	S	750	10,10
I 13	K	100	14,80
I 15	S	500	18,20
I 15	K	100	23,00
I 17	S	500	24,60
I 17	K	100	31,00
I 21	S	200	44,00
I 23	S	100	63,00
I 25	S	100	67,00
I 28	S	100	91,00
I 31	S	100	105,00

~DIN 06797.014

6797 Federstahl Form I
galvanisch verzinkt

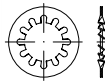

**Zahnscheiben,
I = innengezahnt**

Maße → TI-99 Korrosionsschutz → TI-228
Rostfrei → S. 554



I 3,2	S	5000	1,85 gal Zn
I 3,2	K	500	3,15 gal Zn
I 3,7	K	500	3,30 gal Zn
I 4,3	S	5000	1,95 gal Zn
I 4,3	K	500	3,40 gal Zn
I 5,3	S	3000	2,70 gal Zn

Abmessungen	VE	Stück	€/100/Obf.
I 5,3	K	500	4,15 gal Zn
I 6,4	S	2000	3,00 gal Zn
I 6,4	K	500	4,45 gal Zn
I 7,4	K	250	7,80 gal Zn
I 8,4	S	2000	5,90 gal Zn
I 8,4	K	250	8,40 gal Zn
I 10,5	S	1000	8,90 gal Zn
I 10,5	K	250	11,70 gal Zn
I 13	S	750	12,30 gal Zn
I 13	K	100	17,40 gal Zn
I 15	K	100	27,00 gal Zn
I 17	S	500	29,00 gal Zn
I 17	K	100	36,00 gal Zn
I 19	K	100	54,00 gal Zn
I 21	S	200	53,00 gal Zn
I 21	K	100	61,00 gal Zn
I 23	S	100	73,00 gal Zn
I 25	S	100	78,00 gal Zn
I 28	S	100	106,00 gal Zn
I 31	S	100	123,00 gal Zn

~DIN 06797.015

6797 Federstahl Form V
galvanisch verzinkt

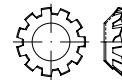

**Fächerscheiben,
V = versenkt**

Maße → TI-99 Korrosionsschutz → TI-228

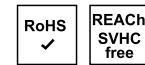

V 3,2	S	5000	3,35 gal Zn
V 3,2	K	250	5,80 gal Zn
V 4,3	S	3000	3,70 gal Zn
V 4,3	K	250	6,00 gal Zn
V 5,3	S	4000	4,80 gal Zn
V 5,3	K	250	7,30 gal Zn
V 6,4	S	2000	5,50 gal Zn
V 6,4	K	250	7,90 gal Zn
V 8,4	S	2000	8,50 gal Zn
V 8,4	K	100	11,40 gal Zn
V 10,5	S	1000	11,40 gal Zn
V 10,5	K	100	26,50 gal Zn
V 13	S	500	24,50 gal Zn
V 13	K	100	31,00 gal Zn

Abmessungen	VE Stück	€/100/Obf.
~DIN	06798.001	

6798

Federstahl Form A

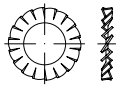

**Fächerscheiben,
A = außengezahnt**

Maße → TI-99
Rostfrei → S. 554
Bronze → S. 639

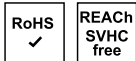

A 2,2	S 5000	1,60
A 2,2	K 500	2,90
A 2,5	K 500	2,90
A 2,7	K 500	2,90
A 3,2	S 5000	1,60
A 3,2	K 500	2,90
A 4,3	S 5000	1,75
A 4,3	K 500	3,30
A 5,3	S 3000	2,20
A 5,3	K 500	3,60
A 6,4	S 2000	2,60
A 6,4	K 500	4,10
A 8,4	S 2000	4,80
A 8,4	K 250	7,30
A 10,5	S 1000	7,30
A 10,5	K 250	9,90
A 13	S 750	10,10
A 13	K 100	14,80
A 15	K 100	19,50
A 17	S 500	21,30
A 17	K 100	26,50
A 19	K 100	41,50
A 21	S 200	44,00
A 21	K 100	52,00
A 23	S 100	63,00
A 25	S 100	66,00
A 28	S 100	91,00
A 31	S 100	105,00

~DIN	06798.011
6798	Federstahl Form A galvanisch verzinkt

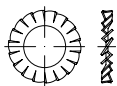

**Fächerscheiben,
A = außengezahnt**

Maße → TI-99
Rostfrei → S. 554
Bronze → S. 639

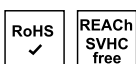

A 2,2	S 5000	1,70 gal Zn
A 2,2	K 500	3,15 gal Zn
A 2,5	S 5000	1,70 gal Zn
A 2,5	K 500	3,15 gal Zn

Abmessungen	VE Stück	€/100/Obf.
-------------	----------	------------

A 2,7	S 5000	1,85 gal Zn
A 2,7	K 500	3,30 gal Zn
A 3,2	S 5000	1,85 gal Zn
A 3,2	K 500	3,15 gal Zn
A 3,7	K 500	3,30 gal Zn
A 4,3	S 5000	1,95 gal Zn
A 4,3	K 500	3,40 gal Zn
A 5,3	S 3000	2,70 gal Zn
A 5,3	K 500	4,15 gal Zn
A 6,4	S 2000	3,00 gal Zn
A 6,4	K 500	4,45 gal Zn
A 7,4	K 250	7,80 gal Zn
A 8,4	S 2000	5,90 gal Zn
A 8,4	K 250	8,40 gal Zn
A 10,5	S 1000	8,90 gal Zn
A 10,5	K 250	11,70 gal Zn
A 13	S 750	12,30 gal Zn
A 13	K 100	17,40 gal Zn
A 15	K 100	27,00 gal Zn
A 17	S 500	29,00 gal Zn
A 17	K 100	36,00 gal Zn
A 19	K 100	54,00 gal Zn
A 21	S 200	53,00 gal Zn
A 21	K 100	61,00 gal Zn
A 23	S 100	73,00 gal Zn
A 25	S 100	78,00 gal Zn
A 28	S 100	106,00 gal Zn
A 31	S 100	123,00 gal Zn

~DIN	06798.081
6798	Federstahl Form A galv. verz. 8 DiSP*

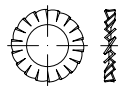

**Fächerscheiben
A = außengezahnt**

* $\varnothing 6$ Mindestschichtdicke 5µm,
Korrosionsbeständigkeit NSS: 72h WR, 120h RR

Maße → TI-99
Rostfrei → S. 554
Bronze → S. 639



A 5,3	S 3000	3,35 gal ZnDi
A 6,4	S 2000	3,75 gal ZnDi
A 8,4	S 2000	7,40 gal ZnDi
A 10,5	S 1000	11,40 gal ZnDi
A 13	S 750	27,00 gal ZnDi

Abmessungen	VE Stück	€/100/Obf.
~DIN	06798.004	

6798

Federstahl Form I

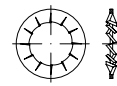

**Fächerscheiben,
I = innengezahnt**

Maße → TI-99
Rostfrei → S. 554



I 2,5	K 500	2,90
I 3,2	S 5000	1,60
I 3,2	K 500	2,90
I 4,3	S 5000	1,75
I 4,3	K 500	3,30
I 5,3	S 3000	2,20
I 5,3	K 500	3,60
I 6,4	S 2000	2,60
I 6,4	K 500	4,10
I 8,4	S 2000	4,80
I 8,4	K 250	7,30
I 10,5	S 1000	7,30
I 10,5	K 250	9,90
I 13	S 750	10,10
I 13	K 100	14,80
I 15	K 100	19,00
I 17	S 500	21,30
I 17	K 100	26,50
I 21	S 200	44,00
I 23	S 100	63,00
I 25	S 100	67,00

~DIN	06798.014
6798	Federstahl Form I galvanisch verzinkt



**Fächerscheiben,
I = innengezahnt**

Maße → TI-99
Rostfrei → S. 554

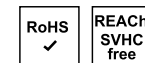

I 2,2	S 5000	1,70 gal Zn
I 2,2	K 500	3,15 gal Zn
I 3,2	S 5000	1,85 gal Zn
I 3,2	K 500	3,15 gal Zn
I 3,7	K 500	3,30 gal Zn
I 4,3	S 5000	1,95 gal Zn
I 4,3	K 500	3,40 gal Zn
I 5,3	S 3000	2,70 gal Zn
I 5,3	K 500	4,15 gal Zn
I 6,4	S 2000	3,00 gal Zn
I 6,4	K 500	4,45 gal Zn
I 7,4	K 250	7,80 gal Zn
I 8,4	S 2000	5,90 gal Zn

Abmessungen	VE Stück	€/100/Obf.
I 8,4	K 250	8,40 gal Zn
I 10,5	S 1000	8,90 gal Zn
I 10,5	K 250	11,70 gal Zn
I 13	S 750	12,30 gal Zn
I 13	K 100	17,40 gal Zn
I 15	K 100	27,00 gal Zn
I 17	S 500	29,00 gal Zn
I 17	K 100	36,00 gal Zn
I 19	K 100	54,00 gal Zn
I 21	S 200	53,00 gal Zn
I 21	K 100	61,00 gal Zn
I 23	S 100	73,00 gal Zn
I 25	S 100	78,00 gal Zn
I 28	S 100	106,00 gal Zn
I 31	S 100	123,00 gal Zn

~DIN 06798.005

6798 Federstahl Form V

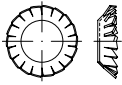

Fächerscheiben,
V = versenkt

Maße → TI-99

Rostfrei → S. 554

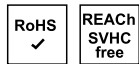

V 3,2	S 5000	3,25
V 3,2	K 250	5,50
V 4,3	S 3000	3,35
V 4,3	K 250	5,80
V 5,3	S 4000	4,55
V 5,3	K 250	6,80
V 6,4	S 2000	4,80
V 6,4	K 250	9,30
V 8,4	S 2000	7,80
V 8,4	K 100	12,50
V 10,5	S 1000	9,90
V 10,5	K 100	28,00
V 13	S 500	22,10
V 13	K 100	32,00

~DIN 06798.015

6798 Federstahl Form V galvanisch verzinkt

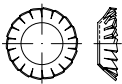

Fächerscheiben,
V = versenkt

Maße → TI-99

Korrosionsschutz → TI-228

Rostfrei → S. 554

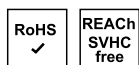

V 3,2	S 5000	3,35 gal Zn
V 3,2	K 250	5,80 gal Zn
V 4,3	S 3000	3,70 gal Zn
V 4,3	K 250	6,00 gal Zn

Abmessungen	VE Stück	€/100/Obf.
V 5,3	S 4000	4,80 gal Zn
V 5,3	K 250	7,30 gal Zn
V 6,4	S 2000	5,50 gal Zn
V 6,4	K 250	7,90 gal Zn
V 8,4	S 2000	8,50 gal Zn
V 8,4	K 100	11,40 gal Zn
V 10,5	S 1000	11,40 gal Zn
V 10,5	K 100	16,40 gal Zn
V 13	S 500	24,50 gal Zn
V 13	K 100	31,00 gal Zn

DIN 06799.000

6799 Federstahl

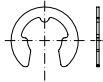

Sicherungsscheiben für Wellen

Maße → TI-100



Nennmaß = Nut Ø

0,8	K 500	10,10
1,2	K 500	3,40
1,5	S 10000	1,55
1,5	K 500	2,85
1,9	S 10000	1,55
1,9	K 500	2,90
2,3	S 5000	1,75
2,3	K 500	3,00
3,2	S 5000	1,85
3,2	K 500	3,35
4	S 5000	2,45
4	K 500	4,20
5	S 5000	3,00
5	K 500	5,00
6	S 2500	3,35
6	K 500	5,50
7	S 2500	4,85
7	K 250	8,60
8	S 2000	6,60
8	K 250	10,60
9	S 1000	8,80
9	K 250	13,40
10	S 1000	10,50
10	K 250	15,20
12	S 1000	13,40
12	K 200	20,70
15	S 500	23,00
15	K 150	34,00
19	S 250	59,00
19	K 150	79,00
24	S 100	84,00

Abmessungen	VE Stück	€/100/Obf.
DIN	06799.010	

6799 Federstahl galvanisch verzinkt



Sicherungsscheiben für Wellen

Maße → TI-100

Korrosionsschutz → TI-228

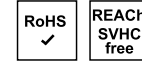

Nennmaß = Nut Ø

2,3	S 500	5,50 gal Zn
3,2	S 500	6,10 gal Zn
4	S 500	7,30 gal Zn
5	S 500	9,10 gal Zn
6	S 500	10,30 gal Zn
7	S 250	10,90 gal Zn
8	S 250	12,10 gal Zn
9	S 250	14,00 gal Zn
10	S 250	14,60 gal Zn
12	S 200	15,80 gal Zn

DIN 06880.000

6880 Stahl C45+C

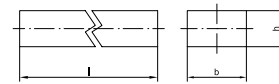

Keilstahl

Maße → TI-137

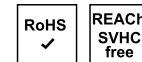

Breite b x Höhe h x Länge l

3	x	3	x	1000	S	1	1340,00
4	x	4	x	1000	S	1	1580,00
5	x	5	x	1000	S	1	1820,00
6	x	6	x	1000	S	1	2300,00
8	x	7	x	1000	S	1	3100,00
10	x	8	x	1000	S	1	4500,00
12	x	8	x	1000	S	1	5400,00
14	x	9	x	1000	S	1	7200,00
16	x	10	x	1000	S	1	9100,00
18	x	11	x	1000	S	1	11200,00
20	x	12	x	1000	S	1	14000,00
22	x	14	x	1000	S	1	17600,00
25	x	14	x	1000	S	1	20600,00
28	x	16	x	1000	S	1	25500,00
32	x	18	x	1000	S	1	32700,00
36	x	20	x	1000	S	1	38800,00

Abmessungen VE Stück €/100/Obf.

DIN 06885.001

6885 **Stahl C45+C** **Form A**

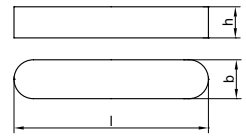

**Passfedern, hohe Form,
A = rundstirnig ohne Bohrung(en)**

Maße → TI-138

Rostfrei → S. 555

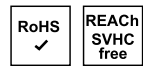

Breite b x Höhe h x Länge l

A 2	x	2	x	8	S	100	34,50
A 2	x	2	x	10	S	100	36,50
A 2	x	2	x	12	S	100	37,00
A 2	x	2	x	16	S	100	48,50
A 3	x	3	x	8	S	100	32,50
A 3	x	3	x	10	S	100	34,00
A 3	x	3	x	12	S	100	34,00
A 3	x	3	x	14	S	100	31,50
A 3	x	3	x	16	S	100	31,50
A 3	x	3	x	18	S	100	31,50
A 3	x	3	x	20	S	100	32,50
A 3	x	3	x	22	S	100	48,50
A 3	x	3	x	25	S	100	34,00
A 4	x	4	x	8	S	100	32,50
A 4	x	4	x	10	S	100	33,50
A 4	x	4	x	12	S	100	33,50
A 4	x	4	x	14	S	100	31,50
A 4	x	4	x	16	S	100	31,50
A 4	x	4	x	18	S	100	31,50
A 4	x	4	x	20	S	100	33,00
A 4	x	4	x	22	S	100	33,00
A 4	x	4	x	25	S	100	33,50
A 4	x	4	x	30	S	100	34,50
A 4	x	4	x	32	S	100	34,50
A 4	x	4	x	36	S	100	36,00
A 4	x	4	x	40	S	100	36,50
A 5	x	5	x	10	S	100	33,00
A 5	x	5	x	12	S	100	33,00
A 5	x	5	x	14	S	100	31,50
A 5	x	5	x	16	S	100	32,50
A 5	x	5	x	18	S	100	32,50
A 5	x	5	x	20	S	100	33,00
A 5	x	5	x	22	S	100	33,00
A 5	x	5	x	25	S	100	34,50
A 5	x	5	x	28	S	100	34,50
A 5	x	5	x	30	S	100	36,00
A 5	x	5	x	32	S	100	36,00
A 5	x	5	x	36	S	100	36,50
A 5	x	5	x	40	S	100	37,00
A 5	x	5	x	50	S	100	39,50
A 5	x	5	x	56	S	100	39,50
A 6	x	6	x	10	S	100	39,00
A 6	x	6	x	12	S	100	39,00
A 6	x	6	x	14	S	100	36,50
A 6	x	6	x	16	S	100	37,00
A 6	x	6	x	18	S	50	37,00
A 6	x	6	x	20	S	50	43,00
A 6	x	6	x	22	S	50	43,00
A 6	x	6	x	25	S	50	44,50
A 6	x	6	x	28	S	50	44,50
A 6	x	6	x	30	S	50	46,00
A 6	x	6	x	32	S	50	46,00

Abmessungen VE Stück €/100/Obf.

A 6	x	6	x	36	S	50	47,50
A 6	x	6	x	40	S	50	48,50
A 6	x	6	x	45	S	50	51,00
A 6	x	6	x	50	S	50	52,00
A 6	x	6	x	56	S	50	57,00
A 6	x	6	x	60	S	50	61,00
A 6	x	6	x	63	S	50	63,00
A 6	x	6	x	70	S	50	66,00
A 6	x	6	x	80	S	50	66,00
A 6	x	6	x	100	S	50	78,00
A 8	x	7	x	16	S	50	46,00
A 8	x	7	x	18	S	50	52,00
A 8	x	7	x	20	S	50	52,00
A 8	x	7	x	22	S	50	52,00
A 8	x	7	x	25	S	50	54,00
A 8	x	7	x	28	S	50	54,00
A 8	x	7	x	30	S	50	56,00
A 8	x	7	x	32	S	50	56,00
A 8	x	7	x	35	S	50	57,00
A 8	x	7	x	36	S	50	57,00
A 8	x	7	x	40	S	50	59,00
A 8	x	7	x	45	S	50	61,00
A 8	x	7	x	50	S	50	63,00
A 8	x	7	x	56	S	50	66,00
A 8	x	7	x	60	S	50	68,00
A 8	x	7	x	63	S	50	72,00
A 8	x	7	x	70	S	50	73,00
A 8	x	7	x	80	S	50	78,00
A 8	x	7	x	90	S	50	83,00
A 8	x	7	x	100	S	50	86,00
A 8	x	7	x	110	S	50	96,00
A 8	x	7	x	120	S	50	103,00
A 10	x	8	x	20	S	50	56,00
A 10	x	8	x	22	S	50	59,00
A 10	x	8	x	25	S	50	59,00
A 10	x	8	x	28	S	50	59,00
A 10	x	8	x	30	S	50	62,00
A 10	x	8	x	32	S	50	62,00
A 10	x	8	x	36	S	50	63,00
A 10	x	8	x	40	S	50	66,00
A 10	x	8	x	45	S	50	68,00
A 10	x	8	x	50	S	50	72,00
A 10	x	8	x	55	S	50	77,00
A 10	x	8	x	56	S	50	77,00
A 10	x	8	x	60	S	50	79,00
A 10	x	8	x	63	S	25	88,00
A 10	x	8	x	70	S	25	94,00
A 10	x	8	x	80	S	25	96,00
A 10	x	8	x	90	S	25	107,00
A 10	x	8	x	100	S	25	115,00
A 10	x	8	x	110	S	25	121,00
A 10	x	8	x	120	S	25	136,00
A 10	x	8	x	125	S	25	176,00
A 10	x	8	x	140	S	25	224,00
A 12	x	8	x	20	S	50	72,00
A 12	x	8	x	25	S	50	74,00
A 12	x	8	x	28	S	50	76,00
A 12	x	8	x	30	S	50	77,00
A 12	x	8	x	32	S	50	77,00
A 12	x	8	x	35	S	50	82,00
A 12	x	8	x	36	S	50	82,00
A 12	x	8	x	40	S	50	84,00
A 12	x	8	x	45	S	50	85,00
A 12	x	8	x	50	S	50	91,00
A 12	x	8	x	55	S	25	102,00
A 12	x	8	x	56	S	25	102,00
A 12	x	8	x	60	S	25	105,00
A 12	x	8	x	63	S	25	108,00
A 12	x	8	x	65	S	25	108,00
A 12	x	8	x	70	S	25	114,00
A 12	x	8	x	75	S	25	119,00
A 12	x	8	x	80	S	25	123,00
A 12	x	8	x	90	S	25	130,00
A 12	x	8	x	100	S	25	138,00
A 12	x	8	x	110	S	25	161,00

Abmessungen VE Stück €/100/Obf.

A 12	x	8	x	120	S	25	167,00
A 12	x	8	x	125	S	25	176,00
A 12	x	8	x	140	S	25	217,00
A 12	x	8	x	150	S	25	255,00
A 14	x	9	x	28	S	25	102,00
A 14	x	9	x	30	S	25	103,00
A 14	x	9	x	32	S	25	103,00
A 14	x	9	x	36	S	25	105,00
A 14	x	9	x	40	S	25	108,00
A 14	x	9	x	45	S	25	113,00
A 14	x	9	x	50	S	25	117,00
A 14	x	9	x	56	S	25	125,00
A 14	x	9	x	60	S	25	130,00
A 14	x	9	x	63	S	25	135,00
A 14	x	9	x	70	S	25	141,00
A 14	x	9	x	80	S	25	157,00
A 14	x	9	x	90	S	25	172,00
A 14	x	9	x	100	S	25	200,00
A 14	x	9	x	110	S	25	203,00
A 14	x	9	x	120	S	25	204,00
A 14	x	9	x	125	S	25	205,00
A 14	x	9	x	140	S	10	265,00
A 14	x	9	x	150	S	10	315,00
A 14	x	9	x	160	S	10	340,00
A 14	x	9	x	180	S	10	385,00
A 14	x	9	x	200	S	10	510,00
A 16	x	10	x	36	S	25	148,00
A 16	x	10	x	40	S	25	152,00
A 16	x	10	x	45	S	25	157,00
A 16	x	10	x	50	S	25	164,00
A 16	x	10	x	55	S	25	177,00
A 16	x	10	x	56	S	25	177,00
A 16	x	10	x	60	S	25	183,00
A 16	x	10	x	63	S	25	187,00
A 16	x	10	x	70	S	25	192,00
A 16	x	10	x	80	S	25	206,00
A 16	x	10	x	90	S	25	226,00
A 16	x	10	x	100	S	10	242,00
A 16	x	10	x	110	S	10	270,00
A 16	x	10	x	125	S	10	300,00
A 16	x	10	x	140	S	10	330,00
A 16	x	10	x	160	S	10	385,00
A 16	x	10	x	180	S	10	440,00
A 18	x	11	x	36	S	10	176,00
A 18	x	11	x	40	S	10	176,00
A 18	x	11	x	45	S	10	176,00
A 18	x	11	x	50	S	10	176,00
A 18	x	11	x	56	S	10	184,00
A 18	x	11	x	60	S	10	194,00
A 18	x	11	x	63	S	10	194,00
A 18	x	11	x	70	S	10	232,00
A 18	x	11	x	80	S	10	265,00
A 18	x	11	x	90	S	10	285,00
A 18	x	11	x	100	S	10	300,00
A 18	x	11	x	110	S	10	310,00
A 18	x	11	x	120	S	10	335,00
A 18	x	11	x	125	S	10	335,00
A 18	x	11	x	140	S	10	360,00
A 18	x	11	x	160	S	10	415,00
A 18	x	11	x	180	S	10	530,00
A 18	x	11	x	200	S	10	610,00
A 20	x	12	x	50	S	10	255,00
A 20	x	12	x	56	S	10	255,00
A 20	x	12	x	60	S	10	275,00
A 20	x	12	x	63	S	10	275,00
A 20	x	12	x	70	S	10	280,00
A 20	x	12	x	80	S	10	310,00
A 20	x	12	x	90	S	10	335,00
A 20	x	12	x	100	S	10	365,00
A 20	x	12	x	110	S	10	420,00
A 20	x	12	x	125	S	10	460,00
A 20	x	12	x				

Abmessungen	VE	Stück	€/100/Obf.
A 20 x 12 x 200 S 10	10	920,00	
A 20 x 12 x 220 S 10	10	950,00	
A 20 x 12 x 250 S 10	10	1070,00	
A 22 x 14 x 50 S 10	10	355,00	
A 22 x 14 x 63 S 10	10	365,00	
A 22 x 14 x 70 S 10	10	370,00	
A 22 x 14 x 80 S 10	10	390,00	
A 22 x 14 x 90 S 10	10	415,00	
A 22 x 14 x 100 S 10	10	425,00	
A 22 x 14 x 110 S 10	10	430,00	
A 22 x 14 x 125 S 10	10	570,00	
A 22 x 14 x 140 S 10	10	630,00	
A 22 x 14 x 160 S 5	5	740,00	
A 22 x 14 x 180 S 5	5	840,00	
A 22 x 14 x 200 S 5	5	880,00	
A 22 x 14 x 250 S 5	5	1110,00	
A 25 x 14 x 70 S 1	1	530,00	
A 25 x 14 x 80 S 1	1	530,00	
A 25 x 14 x 90 S 1	1	560,00	
A 25 x 14 x 100 S 1	1	600,00	
A 25 x 14 x 110 S 1	1	660,00	
A 25 x 14 x 125 S 1	1	690,00	
A 25 x 14 x 140 S 1	1	820,00	
A 25 x 14 x 160 S 1	1	920,00	
A 25 x 14 x 180 S 1	1	1130,00	
A 25 x 14 x 200 S 1	1	1170,00	
A 28 x 16 x 80 S 1	1	670,00	
A 28 x 16 x 90 S 1	1	720,00	
A 28 x 16 x 100 S 1	1	770,00	
A 28 x 16 x 110 S 1	1	890,00	
A 28 x 16 x 120 S 1	1	890,00	
A 28 x 16 x 125 S 1	1	910,00	
A 28 x 16 x 140 S 1	1	1030,00	
A 28 x 16 x 160 S 1	1	1170,00	
A 28 x 16 x 180 S 1	1	1310,00	
A 28 x 16 x 200 S 1	1	1480,00	
A 28 x 16 x 220 S 1	1	1630,00	
A 28 x 16 x 250 S 1	1	1840,00	
A 28 x 16 x 320 S 1	1	2230,00	
A 32 x 18 x 70 S 1	1	860,00	
A 32 x 18 x 90 S 1	1	910,00	
A 32 x 18 x 100 S 1	1	940,00	
A 32 x 18 x 110 S 1	1	1110,00	
A 32 x 18 x 125 S 1	1	1180,00	
A 32 x 18 x 140 S 1	1	1250,00	
A 32 x 18 x 160 S 1	1	1430,00	
A 32 x 18 x 180 S 1	1	1600,00	
A 32 x 18 x 200 S 1	1	1760,00	
A 32 x 18 x 220 S 1	1	2150,00	
A 32 x 18 x 250 S 1	1	2280,00	
A 36 x 20 x 100 S 1	1	1140,00	
A 36 x 20 x 125 S 1	1	1340,00	
A 36 x 20 x 140 S 1	1	1540,00	
A 36 x 20 x 160 S 1	1	1740,00	
A 36 x 20 x 170 S 1	1	1940,00	
A 36 x 20 x 180 S 1	1	2030,00	
A 36 x 20 x 200 S 1	1	2170,00	
A 36 x 20 x 220 S 1	1	2330,00	
A 36 x 20 x 250 S 1	1	3000,00	
A 40 x 22 x 140 S 1	1	1920,00	
A 40 x 22 x 160 S 1	1	2130,00	
A 40 x 22 x 240 S 1	1	3550,00	
A 40 x 22 x 280 S 1	1	4000,00	
A 45 x 25 x 200 S 1	1	4150,00	
A 45 x 25 x 220 S 1	1	4200,00	
A 45 x 25 x 250 S 1	1	4850,00	

Abmessungen	VE	Stück	€/100/Obf.
-------------	----	-------	------------

DIN 06887.000
6887 Stahl C45+C

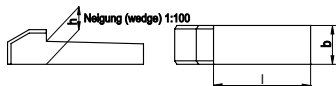

Nasenkeile

Maße → TI-138

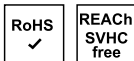

Breite b x Höhe h x Länge l

6 x 6 x 32 S 50	50	167,00
6 x 6 x 40 S 50	50	171,00
6 x 6 x 50 S 50	50	175,00
8 x 7 x 32 S 25	25	239,00
8 x 7 x 36 S 25	25	239,00
8 x 7 x 40 S 25	25	236,00
8 x 7 x 45 S 25	25	242,00
8 x 7 x 50 S 25	25	250,00
8 x 7 x 60 S 25	25	265,00
8 x 7 x 63 S 25	25	265,00
10 x 8 x 40 S 25	25	345,00
10 x 8 x 45 S 25	25	345,00
10 x 8 x 50 S 25	25	365,00
10 x 8 x 60 S 25	25	380,00
10 x 8 x 70 S 10	10	415,00
10 x 8 x 80 S 10	10	430,00
10 x 8 x 90 S 10	10	510,00
10 x 8 x 100 S 10	10	570,00
12 x 8 x 40 S 25	25	360,00
12 x 8 x 50 S 25	25	370,00
12 x 8 x 56 S 10	10	385,00
12 x 8 x 60 S 10	10	410,00
12 x 8 x 63 S 10	10	410,00
12 x 8 x 70 S 10	10	420,00
12 x 8 x 80 S 10	10	440,00
12 x 8 x 90 S 10	10	460,00
12 x 8 x 100 S 10	10	485,00
14 x 9 x 56 S 10	10	475,00
14 x 9 x 60 S 10	10	495,00
14 x 9 x 63 S 10	10	495,00
14 x 9 x 70 S 10	10	540,00
14 x 9 x 80 S 10	10	560,00
14 x 9 x 90 S 10	10	590,00
14 x 9 x 100 S 10	10	620,00
16 x 10 x 70 S 10	10	630,00
16 x 10 x 80 S 10	10	660,00
16 x 10 x 90 S 10	10	680,00
16 x 10 x 100 S 10	10	690,00

Abmessungen	VE	Stück	€/100/Obf.
-------------	----	-------	------------

DIN 06888.000
6888 Stahl C45+C

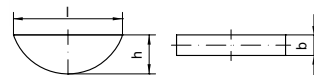

Scheibenfedern

Maße → TI-138



Breite b x Höhe h

2 x 2,6 S 100	100	18,40
2 x 3,7 S 100	100	26,00
2 x 5 S 100	100	31,50
2,5 x 3,7 S 100	100	26,00
3 x 3,7 S 100	100	26,00
3 x 5 S 100	100	33,50
3 x 6,5 S 100	100	41,50
3 x 7,5 S 100	100	48,00
4 x 5 S 100	100	33,00
4 x 6,5 S 100	100	41,50
4 x 7,5 S 100	100	48,00
4 x 9 S 100	100	56,00
5 x 6,5 S 100	100	41,50
5 x 7,5 S 100	100	48,00
5 x 9 S 100	100	56,00
5 x 10 S 100	100	63,00
6 x 7,5 S 100	100	48,00
6 x 9 S 50	50	56,00
6 x 10 S 50	50	63,00
6 x 11 S 50	50	69,00
8 x 9 S 50	50	56,00
8 x 11 S 50	50	69,00
8 x 13 S 50	50	88,00
10 x 11 S 25	25	92,00
10 x 13 S 25	25	102,00
10 x 16 S 25	25	168,00

Abmessungen	VE	Stück	€/100/Obf.
-------------	----	-------	------------

DIN 06899.010
6899 Stahl Form BF galvanisch verzinkt



Kauschen für Faserseile, BF = mittelschwer, mit tiefer Rille

Seilklemmen → DIN 741

Maße → TI-133

Korrosionsschutz → TI-228

Weitere Abmessungen und Kauschen nach DIN 3090 und 3091 auf Anfrage

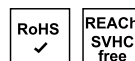

Nenngröße / Rillenweite = für Seil-Nenn Ø

BF 3,5 / RW 4 S 100	100	66,00 gal Zn
BF 4 / RW 5 S 100	100	73,00 gal Zn
BF 5 / RW 6 S 100	100	83,00 gal Zn
BF 6 / RW 7 S 100	100	101,00 gal Zn
BF 7 / RW 8 S 100	100	121,00 gal Zn
BF 9 / RW10 S 50	50	151,00 gal Zn
BF 11 / RW12 S 50	50	211,00 gal Zn

Abmessungen VE Stück €/100/Obf.

DIN 06911.000

6911 **Stahl vergütet geschwärzt**

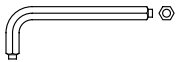

Winkelschraubendreher mit Zapfenführung

Sechskant-Stiftschlüssel für DIN 6912



SW 3 M 4	K 10	320,00
SW 4 M 5	K 10	320,00
SW 5 M 6	S 50	275,00
SW 5 M 6	K 10	375,00
SW 6 M 8	S 50	295,00
SW 6 M 8	K 10	390,00
SW 8 M 10	S 50	520,00
SW 8 M 10	K 10	630,00
SW 10 M 12	S 25	790,00
SW 10 M 12	K 5	890,00
SW 12 M 14	S 25	1020,00
SW 12 M 14	K 5	1200,00
SW 14 M 16/18	S 25	2220,00
SW 14 M 16/18	K 5	2280,00
SW 17 M 20	K 5	2750,00
SW 19 M 24	S 5	4350,00
SW 22 M 30	S 1	5800,00

DIN 06912.800

6912 **08.8**

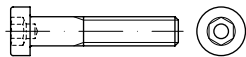

Zylinderschrauben mit Innensechskant, niedriger Kopf, mit Schlüsselführung

Maße → TI-12 Anziehmomente → TI-246

Werkstoffeigensch. → TI-232

Rostfrei → S. 555



M 4 x 6	S 500	35,50
M 4 x 6	K 100	39,00
M 4 x 8	S 500	25,00
M 4 x 8	K 100	29,00
M 4 x 10	S 500	18,30
M 4 x 10	K 100	22,00
M 4 x 12	S 500	17,20
M 4 x 12	K 100	20,90
M 4 x 16	S 500	18,00
M 4 x 16	K 100	21,60
M 4 x 18	S 500	21,60
M 4 x 20	S 500	19,60
M 4 x 20	K 100	23,20
M 4 x 25	S 500	22,20
M 4 x 25	K 100	26,00
M 4 x 30	S 500	23,70
M 4 x 30	K 100	27,50

Abmessungen VE Stück €/100/Obf.

M 4 x 35	S 500	27,50
M 4 x 35	K 100	31,50
M 4 x 40	S 500	28,50
M 4 x 40	K 100	32,50
M 5 x 6	S 500	36,50
M 5 x 6	K 100	40,50
M 5 x 8	S 500	32,00
M 5 x 8	K 100	35,50
M 5 x 10	S 500	20,70
M 5 x 10	K 100	24,40
M 5 x 12	S 500	19,10
M 5 x 12	K 100	22,70
M 5 x 16	S 500	19,90
M 5 x 16	K 100	23,60
M 5 x 18	S 500	21,60
M 5 x 20	S 500	20,40
M 5 x 20	K 100	24,10
M 5 x 25	S 500	21,90
M 5 x 25	K 100	26,00
M 5 x 30	S 500	25,50
M 5 x 30	K 100	29,00
M 5 x 35	S 200	29,00
M 5 x 40	S 200	33,00
M 5 x 45	S 200	35,00
M 5 x 50	S 200	50,00
M 5 x 55	S 200	56,00
M 5 x 60	S 200	60,00
M 6 x 8	S 500	39,50
M 6 x 8	K 100	43,00
M 6 x 10	S 500	23,60
M 6 x 10	K 100	27,50
M 6 x 12	S 500	21,60
M 6 x 12	K 100	25,50
M 6 x 16	S 500	23,20
M 6 x 16	K 100	27,00
M 6 x 18	S 500	24,00
M 6 x 18	K 100	28,00
M 6 x 20	S 500	24,00
M 6 x 20	K 100	28,00
M 6 x 22	S 500	26,00
M 6 x 25	S 500	24,90
M 6 x 25	K 100	28,50
M 6 x 30	S 500	26,50
M 6 x 30	K 100	30,50
M 6 x 35	S 200	29,50
M 6 x 40	S 200	31,50
M 6 x 45	S 200	35,00
M 6 x 50	S 200	38,50
M 6 x 55	S 200	43,00
M 6 x 60	S 200	46,50
M 6 x 65	S 200	61,00
M 6 x 70	S 200	67,00
M 6 x 75	S 200	70,00
M 6 x 80	S 200	77,00
M 6 x 90	S 200	82,00
M 6 x 100	S 200	103,00
M 6 x 110	S 200	144,00
M 6 x 120	S 200	166,00
M 8 x 10	S 200	44,50
M 8 x 12	S 200	39,50
M 8 x 16	S 200	30,00
M 8 x 18	S 200	33,50
M 8 x 20	S 200	30,50
M 8 x 22	S 200	35,00
M 8 x 25	S 200	32,50
M 8 x 30	S 200	36,00
M 8 x 35	S 200	40,00
M 8 x 40	S 200	45,00
M 8 x 45	S 200	50,00
M 8 x 50	S 200	53,00
M 8 x 55	S 200	58,00
M 8 x 60	S 200	63,00
M 8 x 65	S 200	70,00
M 8 x 70	S 200	80,00
M 8 x 75	S 200	116,00

Abmessungen VE Stück €/100/Obf.

M 8 x 80	S 200	116,00
M 8 x 90	S 100	125,00
M 8 x 100	S 100	134,00
M 8 x 110	S 100	176,00
M 8 x 120	S 100	211,00
M 10 x 16	S 200	95,00
M 10 x 18	S 200	80,00
M 10 x 20	S 200	50,00
M 10 x 22	S 200	51,00
M 10 x 25	S 200	51,00
M 10 x 30	S 200	53,00
M 10 x 35	S 200	61,00
M 10 x 40	S 100	68,00
M 10 x 45	S 100	75,00
M 10 x 50	S 100	83,00
M 10 x 55	S 100	93,00
M 10 x 60	S 100	100,00
M 10 x 65	S 100	108,00
M 10 x 70	S 100	116,00
M 10 x 75	S 100	119,00
M 10 x 80	S 100	134,00
M 10 x 90	S 100	147,00
M 10 x 100	S 100	200,00
M 10 x 110	S 100	233,00
M 10 x 120	S 100	265,00
M 10 x 130	S 50	315,00
M 10 x 140	S 50	390,00
M 12 x 16	S 100	275,00
M 12 x 20	S 100	88,00
M 12 x 25	S 100	82,00
M 12 x 30	S 100	85,00
M 12 x 35	S 100	90,00
M 12 x 40	S 100	100,00
M 12 x 45	S 100	110,00
M 12 x 50	S 100	119,00
M 12 x 55	S 100	129,00
M 12 x 60	S 100	137,00
M 12 x 65	S 100	146,00
M 12 x 70	S 100	155,00
M 12 x 75	S 50	177,00
M 12 x 80	S 50	181,00
M 12 x 90	S 50	197,00
M 12 x 100	S 50	220,00
M 12 x 110	S 50	285,00
M 12 x 120	S 50	325,00
M 12 x 130	S 50	365,00
M 12 x 140	S 50	400,00
M 12 x 150	S 50	450,00
M 12 x 160	S 1	760,00
M 14 x 30	S 100	177,00
M 14 x 35	S 100	189,00
M 14 x 40	S 100	206,00
M 14 x 45	S 50	217,00
M 14 x 50	S 50	255,00
M 14 x 60	S 50	260,00
M 14 x 70	S 50	310,00
M 14 x 80	S 50	365,00
M 14 x 90	S 50	415,00
M 14 x 100	S 50	465,00
M 16 x 25	S 50	200,00
M 16 x 30	S 50	186,00
M 16 x 35	S 50	193,00
M 16 x 40	S 50	205,00
M 16 x 45	S 50	213,00
M 16 x 50	S 50	226,00
M 16 x 55	S 50	249,00
M 16 x 60	S 50	275,00
M 16 x 65	S 50	295,00
M 16 x 70	S 50	300,00
M 16 x 75	S 50	335,00
M 16 x 80	S 50	350,00
M 16 x 90	S 25	365,00
M 16 x 100	S 25	420,00
M 16 x 110	S 25	660,00
M 16 x 120	S 25	490,00

Abmessungen	VE	Stück	€/100/Obf.	Abmessungen	VE	Stück	€/100/Obf.	Abmessungen	VE	Stück	€/100/Obf.
M 16 x 130	S	25	530,00	M 4 x 6	S	500	35,50 gal Zn	M 10 x 20	S	200	56,00 gal Zn
M 16 x 140	S	25	600,00	M 4 x 8	S	500	25,50 gal Zn	M 10 x 25	S	200	58,00 gal Zn
M 16 x 150	S	25	700,00	M 4 x 10	S	500	18,70 gal Zn	M 10 x 30	S	200	61,00 gal Zn
M 16 x 160	S	25	770,00	M 4 x 12	S	500	17,80 gal Zn	M 10 x 35	S	200	70,00 gal Zn
M 16 x 180	S	25	880,00	M 4 x 14	S	500	21,60 gal Zn	M 10 x 40	S	100	78,00 gal Zn
M 16 x 200	S	25	960,00	M 4 x 16	S	500	18,60 gal Zn	M 10 x 45	S	100	86,00 gal Zn
M 20 x 30	S	25	1010,00	M 4 x 18	S	500	22,70 gal Zn	M 10 x 50	S	100	95,00 gal Zn
M 20 x 35	S	25	1020,00	M 4 x 20	S	500	20,40 gal Zn	M 10 x 55	S	100	107,00 gal Zn
M 20 x 40	S	25	660,00	M 4 x 25	S	500	23,20 gal Zn	M 10 x 60	S	100	114,00 gal Zn
M 20 x 45	S	25	670,00	M 4 x 30	S	500	24,90 gal Zn	M 10 x 65	S	100	124,00 gal Zn
M 20 x 50	S	25	680,00	M 4 x 35	S	500	29,00 gal Zn	M 10 x 70	S	100	134,00 gal Zn
M 20 x 55	S	25	680,00	M 4 x 40	S	500	30,00 gal Zn	M 10 x 75	S	100	144,00 gal Zn
M 20 x 60	S	25	690,00	M 5 x 6	S	500	37,50 gal Zn	M 10 x 80	S	100	153,00 gal Zn
M 20 x 65	S	25	710,00	M 5 x 8	S	500	32,50 gal Zn	M 10 x 90	S	100	167,00 gal Zn
M 20 x 70	S	25	740,00	M 5 x 10	S	500	21,50 gal Zn	M 10 x 100	S	100	223,00 gal Zn
M 20 x 80	S	25	790,00	M 5 x 12	S	500	20,00 gal Zn	M 10 x 120	S	100	295,00 gal Zn
M 20 x 90	S	25	850,00	M 5 x 16	S	500	21,00 gal Zn	M 10 x 130	S	100	350,00 gal Zn
M 20 x 100	S	25	910,00	M 5 x 18	S	500	22,90 gal Zn	M 10 x 140	S	50	385,00 gal Zn
M 20 x 110	S	25	1000,00	M 5 x 20	S	500	21,70 gal Zn	M 12 x 16	S	100	285,00 gal Zn
M 20 x 120	S	25	1080,00	M 5 x 25	S	500	23,50 gal Zn	M 12 x 20	S	100	97,00 gal Zn
M 20 x 130	S	25	1160,00	M 5 x 30	S	500	27,50 gal Zn	M 12 x 25	S	100	92,00 gal Zn
M 20 x 140	S	25	1240,00	M 5 x 35	S	200	31,00 gal Zn	M 12 x 30	S	100	97,00 gal Zn
M 20 x 150	S	25	1330,00	M 5 x 40	S	200	35,50 gal Zn	M 12 x 35	S	100	103,00 gal Zn
M 20 x 160	S	10	1490,00	M 5 x 45	S	200	37,50 gal Zn	M 12 x 40	S	100	114,00 gal Zn
M 20 x 180	S	10	1660,00	M 5 x 50	S	200	53,00 gal Zn	M 12 x 45	S	100	126,00 gal Zn
M 20 x 220	S	1	2600,00	M 5 x 55	S	200	59,00 gal Zn	M 12 x 50	S	100	137,00 gal Zn
M 24 x 40	S	1	1370,00	M 5 x 60	S	200	63,00 gal Zn	M 12 x 55	S	100	148,00 gal Zn
M 24 x 45	S	1	1410,00	M 6 x 8	S	500	40,50 gal Zn	M 12 x 60	S	100	157,00 gal Zn
M 24 x 50	S	1	1410,00	M 6 x 10	S	500	24,90 gal Zn	M 12 x 65	S	100	167,00 gal Zn
M 24 x 55	S	1	1500,00	M 6 x 12	S	500	23,00 gal Zn	M 12 x 70	S	100	180,00 gal Zn
M 24 x 60	S	1	1500,00	M 6 x 14	S	500	23,00 gal Zn	M 12 x 80	S	50	206,00 gal Zn
M 24 x 70	S	1	1590,00	M 6 x 16	S	500	24,90 gal Zn	M 12 x 90	S	50	226,00 gal Zn
M 24 x 80	S	1	1680,00	M 6 x 18	S	500	26,00 gal Zn	M 12 x 100	S	50	255,00 gal Zn
M 24 x 90	S	1	1810,00	M 6 x 20	S	500	26,00 gal Zn	M 12 x 110	S	50	325,00 gal Zn
M 24 x 100	S	1	1850,00	M 6 x 22	S	500	28,00 gal Zn	M 12 x 120	S	50	395,00 gal Zn
M 24 x 120	S	1	1940,00	M 6 x 25	S	500	27,00 gal Zn	M 12 x 130	S	50	710,00 gal Zn
M 24 x 130	S	1	2030,00	M 6 x 30	S	500	29,50 gal Zn	M 12 x 140	S	50	440,00 gal Zn
M 24 x 140	S	1	2120,00	M 6 x 35	S	200	31,50 gal Zn	M 12 x 150	S	50	540,00 gal Zn
M 24 x 180	S	1	3000,00	M 6 x 40	S	200	36,00 gal Zn	M 12 x 160	S	1	800,00 gal Zn
M 30 x 50	S	1	2160,00	M 6 x 45	S	200	39,00 gal Zn	M 12 x 180	S	1	860,00 gal Zn
M 30 x 55	S	1	2220,00	M 6 x 50	S	200	42,50 gal Zn	M 14 x 30	S	100	207,00 gal Zn
M 30 x 60	S	1	2220,00	M 6 x 55	S	200	47,50 gal Zn	M 14 x 35	S	100	220,00 gal Zn
M 30 x 70	S	1	2300,00	M 6 x 60	S	200	52,00 gal Zn	M 14 x 40	S	100	236,00 gal Zn
M 30 x 80	S	1	2390,00	M 6 x 65	S	200	66,00 gal Zn	M 14 x 45	S	50	247,00 gal Zn
M 30 x 90	S	1	2430,00	M 6 x 70	S	200	72,00 gal Zn	M 14 x 50	S	50	285,00 gal Zn
M 30 x 100	S	1	2550,00	M 6 x 80	S	200	86,00 gal Zn	M 14 x 60	S	50	295,00 gal Zn
M 30 x 110	S	1	2600,00	M 6 x 90	S	200	91,00 gal Zn	M 14 x 70	S	50	345,00 gal Zn
M 30 x 120	S	1	2700,00	M 6 x 100	S	200	112,00 gal Zn	M 16 x 25	S	50	230,00 gal Zn
M 30 x 150	S	1	3000,00	M 6 x 110	S	200	154,00 gal Zn	M 16 x 30	S	50	210,00 gal Zn
M 30 x 160	S	1	3050,00	M 6 x 120	S	200	176,00 gal Zn	M 16 x 35	S	50	217,00 gal Zn
M 36 x 60	S	1	4300,00	M 8 x 10	S	200	47,50 gal Zn	M 16 x 40	S	50	233,00 gal Zn
M 36 x 70	S	1	4450,00	M 8 x 12	S	200	42,00 gal Zn	M 16 x 45	S	50	242,00 gal Zn
M 36 x 80	S	1	4700,00	M 8 x 14	S	200	107,00 gal Zn	M 16 x 50	S	50	260,00 gal Zn
				M 8 x 16	S	200	33,00 gal Zn	M 16 x 60	S	50	310,00 gal Zn
				M 8 x 18	S	200	36,00 gal Zn	M 16 x 70	S	50	345,00 gal Zn
				M 8 x 20	S	200	34,00 gal Zn	M 16 x 80	S	50	400,00 gal Zn
				M 8 x 22	S	200	38,00 gal Zn	M 16 x 90	S	25	420,00 gal Zn
				M 8 x 25	S	200	37,00 gal Zn	M 16 x 100	S	25	480,00 gal Zn
				M 8 x 30	S	200	40,50 gal Zn	M 16 x 110	S	25	680,00 gal Zn
				M 8 x 35	S	200	45,50 gal Zn	M 16 x 120	S	25	560,00 gal Zn
				M 8 x 40	S	200	51,00 gal Zn	M 16 x 130	S	25	780,00 gal Zn
				M 8 x 45	S	200	57,00 gal Zn	M 16 x 140	S	25	870,00 gal Zn
				M 8 x 50	S	200	61,00 gal Zn	M 16 x 150	S	25	970,00 gal Zn
				M 8 x 55	S	200	67,00 gal Zn	M 16 x 160	S	25	840,00 gal Zn
				M 8 x 60	S	200	72,00 gal Zn	M 16 x 180	S	25	950,00 gal Zn
				M 8 x 65	S	200	80,00 gal Zn	M 16 x 200	S	25	1040,00 gal Zn
				M 8 x 70	S	200	90,00 gal Zn	M 20 x 30	S	25	1060,00 gal Zn
				M 8 x 75	S	200	129,00 gal Zn	M 20 x 35	S	25	1090,00 gal Zn
				M 8 x 80	S	200	129,00 gal Zn	M 20 x 40	S	25	710,00 gal Zn
				M 8 x 90	S	100	138,00 gal Zn	M 20 x 45	S	25	720,00 gal Zn
				M 8 x 100	S	100	148,00 gal Zn	M 20 x 50	S	25	730,00 gal Zn
				M 8 x 105	S	100	600,00 gal Zn	M 20 x 60	S	25	750,00 gal Zn
				M 8 x 110	S	100	190,00 gal Zn	M 20 x 70	S	25	810,00 gal Zn
				M 10 x 16	S	200	100,00 gal Zn	M 20 x 80	S	25	870,00 gal Zn
				M 10 x 18	S	200	86,00 gal Zn	M 20 x 90	S	25	940,00 gal Zn

DIN 06912.810

6912 08.8 galvanisch verzinkt

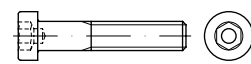

Zylinderschrauben mit Innensechskant, niedriger Kopf, mit Schlüsselführung

Maße → TI-12 Korrosionsschutz → TI-228
 Werkstoffeigensch. → TI-232 Anziehmomente → TI-246

Rostfrei → S. 555

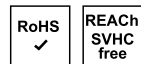

Abmessungen	VE	Stück	€/100/Obf.
M 20 x 100	S	25	1010,00 gal Zn
M 20 x 110	S	25	1090,00 gal Zn
M 20 x 120	S	25	1170,00 gal Zn
M 20 x 130	S	25	1260,00 gal Zn
M 20 x 140	S	25	1340,00 gal Zn
M 20 x 150	S	25	1430,00 gal Zn
M 20 x 160	S	10	1590,00 gal Zn
M 20 x 180	S	10	1750,00 gal Zn
M 20 x 200	S	10	1920,00 gal Zn
M 20 x 220	S	1	2700,00 gal Zn
M 24 x 40	S	1	1520,00 gal Zn
M 24 x 45	S	1	1560,00 gal Zn
M 24 x 50	S	1	1560,00 gal Zn
M 24 x 60	S	1	1650,00 gal Zn
M 24 x 70	S	1	1740,00 gal Zn
M 24 x 80	S	1	1840,00 gal Zn
M 24 x 90	S	1	1970,00 gal Zn
M 24 x 100	S	1	2020,00 gal Zn
M 30 x 50	S	1	2210,00 gal Zn
M 30 x 55	S	1	2270,00 gal Zn
M 30 x 60	S	1	2270,00 gal Zn
M 30 x 70	S	1	2350,00 gal Zn
M 30 x 80	S	1	2350,00 gal Zn
M 30 x 90	S	1	2490,00 gal Zn
M 30 x 100	S	1	2600,00 gal Zn

DIN 06912.100

6912 010.9

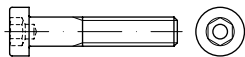

Zylinderschrauben mit Innensechskant, niedriger Kopf, mit Schlüsselführung

Maße → **TI-12** Anziehmomente → **TI-246**
 Werkstoffeigensch. → **TI-232**

Rostfrei → **S. 555**



M 6 x 10	S	500	48,50
M 6 x 12	S	500	44,50
M 6 x 16	S	500	47,50
M 6 x 20	S	500	49,50
M 6 x 25	S	500	52,00
M 6 x 30	S	500	55,00
M 6 x 35	S	200	59,00
M 6 x 40	S	200	66,00
M 8 x 16	S	200	62,00
M 8 x 20	S	200	63,00
M 8 x 25	S	200	67,00
M 8 x 30	S	200	73,00
M 8 x 35	S	200	82,00
M 8 x 40	S	200	92,00
M 8 x 45	S	200	102,00
M 8 x 50	S	200	108,00
M 8 x 60	S	200	129,00
M 10 x 16	S	200	270,00
M 10 x 20	S	200	102,00
M 10 x 25	S	200	105,00
M 10 x 30	S	200	108,00
M 10 x 35	S	200	124,00
M 10 x 40	S	100	141,00
M 10 x 45	S	100	154,00
M 10 x 50	S	100	171,00
M 10 x 60	S	100	204,00
M 12 x 25	S	100	167,00
M 12 x 30	S	100	174,00

Abmessungen	VE	Stück	€/100/Obf.
M 12 x 35	S	100	184,00
M 12 x 40	S	100	204,00
M 12 x 45	S	100	226,00
M 12 x 50	S	100	245,00
M 12 x 60	S	100	280,00
M 16 x 30	S	50	390,00
M 16 x 35	S	50	395,00
M 16 x 40	S	50	425,00
M 16 x 45	S	50	440,00
M 16 x 50	S	50	460,00
M 16 x 60	S	50	560,00
M 16 x 70	S	50	620,00
M 16 x 80	S	50	720,00
M 20 x 40	S	25	1230,00
M 20 x 50	S	25	1240,00
M 20 x 60	S	25	1250,00
M 20 x 70	S	25	1300,00
M 24 x 40	S	25	2550,00
M 24 x 50	S	25	2550,00
M 24 x 60	S	25	2700,00
M 24 x 70	S	25	3250,00
M 24 x 80	S	25	3300,00
M 24 x 90	S	25	3450,00

DIN 06912.110

6912 010.9 **galvanisch verzinkt**

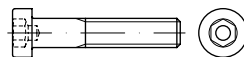

Zylinderschrauben mit Innensechskant, niedriger Kopf, mit Schlüsselführung

getempert

Achtung! Warneinblender zu Wasserstoffversprödung beachten.

Maße → **TI-12** Korrosionsschutz → **TI-228**
 Werkstoffeigensch. → **TI-232** Anziehmomente → **TI-246**

Rostfrei → **S. 555**

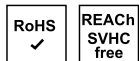

M 6 x 12	S	500	109,00 gal Zn
M 6 x 16	S	500	111,00 gal Zn
M 6 x 20	S	500	117,00 gal Zn
M 6 x 25	S	500	120,00 gal Zn
M 6 x 30	S	500	130,00 gal Zn
M 8 x 16	S	200	200,00 gal Zn
M 8 x 20	S	200	201,00 gal Zn
M 8 x 25	S	200	220,00 gal Zn

Wichtiger Hinweis!

Bei galvanischen Überzügen auf hochfesten und federharten Teilen ($\geq 1000 \text{ N/mm}^2$ oder $\geq 320 \text{ HV}$) ist die Gefahr einer Wasserstoffversprödung (Spröbruchgefahr) nicht mit Sicherheit auszuschließen (ISO 4042). Durch eine rechtzeitig eingeleitete thermische Nachbehandlung (Tempern) kann die Gefahr eines wasserstoffinduzierten Spröbruchs im Regelfall verringert werden. Da aber ein Restrisiko nicht mit Sicherheit auszuschließen ist, erfolgen galvanische Überzüge auf derartigen Teilen nur auf ausdrücklichen Wunsch und auf Risiko des Auftraggebers.

Abmessungen	VE	Stück	€/100/Obf.
M 8 x 30	S	200	239,00 gal Zn
M 10 x 20	S	200	285,00 gal Zn
M 10 x 25	S	200	300,00 gal Zn
M 10 x 30	S	200	310,00 gal Zn
M 10 x 40	S	100	340,00 gal Zn
M 12 x 25	S	100	520,00 gal Zn
M 12 x 30	S	100	530,00 gal Zn
M 16 x 30	S	50	1140,00 gal Zn
M 16 x 35	S	50	1150,00 gal Zn
M 16 x 40	S	50	1190,00 gal Zn

DIN 06917.000

6917 **Stahl vergütet**

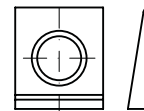

Scheiben, vierkant, keilförmig 14 %, für HV-Verbindung an Doppel-T-Trägern im Stahlbau

Maße → **TI-85**

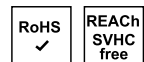

• ÜH-Fabrikate

13	S	1	123,00
17	S	1	138,00
21	S	1	218,00
25	S	1	750,00

DIN 06917.020

6917 **Stahl vergütet feuerverzinkt**

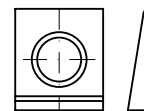

Scheiben, vierkant, keilförmig 14 %, für HV-Verbindungen an Doppel-T-Trägern im Stahlbau

Maße → **TI-85**

Korrosionsschutz → **TI-231**



• ÜH-Fabrikate

13	S	1	130,00 tZn
17	S	1	150,00 tZn
21	S	1	238,00 tZn
23	S	1	600,00 tZn
25	S	1	840,00 tZn

Abmessungen VE Stück €/100/Obf.
 DIN 06918.000

6918

Stahl vergütet

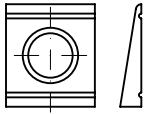

Scheiben, vierkant, keilförmig 8 %, für HV-Verbindungen an U-Profilen im Stahlbau

Maße → [TI-85](#)

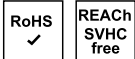

• ÜH-Fabrikate

13	S	1	121,00
17	S	1	143,00
21	S	1	191,00
23	S	1	250,00
25	S	1	365,00
28	S	1	390,00
31	S	1	670,00

DIN 06918.020

6918

Stahl vergütet
feuerverzinkt

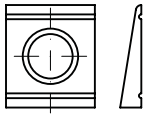

Scheiben, vierkant, keilförmig 8 %, für HV-Verbindungen an U-Profilen im Stahlbau

Maße → [TI-85](#)

Korrosionsschutz → [TI-231](#)

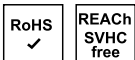

• ÜH-Fabrikate

13	S	1	125,00 tZn
17	S	1	152,00 tZn
21	S	1	210,00 tZn
23	S	1	275,00 tZn
25	S	1	400,00 tZn
28	S	1	430,00 tZn
31	S	1	730,00 tZn

Abmessungen VE Stück €/100/Obf.
 DIN 06921.800

6921

8.8

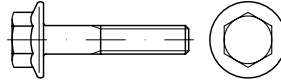

Sechskantschrauben mit Flansch

Maße → [TI-17](#)

Anziehmomente → [TI-244](#)

Werkstoffeigensch. → [TI-232](#)

Normumstellung → [TI-6](#)

Rostfrei → [S. 557](#)

DIN 6921 → wird ersetzt durch EN 1665

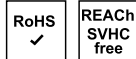

M 6	x	12	S	500	28,00
M 6	x	16	S	500	18,80
M 6	x	20	S	500	18,10
M 6	x	25	S	500	18,10
M 6	x	30	S	500	20,30
M 8	x	12	S	200	57,00
M 8	x	16	S	200	51,00
M 8	x	20	S	200	36,00
M 8	x	25	S	200	36,50
M 8	x	30	S	200	39,50
M 8	x	35	S	200	43,00
M 8	x	40	S	200	46,00
M 8	x	50	S	200	53,00
M 10	x	16	S	200	83,00
M 10	x	20	S	200	51,00
M 10	x	25	S	200	54,00
M 10	x	30	S	200	57,00
M 10	x	35	S	100	63,00
M 10	x	40	S	100	68,00
M 10	x	45	S	100	76,00
M 10	x	50	S	100	80,00
M 10	x	60	S	100	89,00
M 12	x	20	S	100	153,00
M 12	x	25	S	100	142,00
M 12	x	30	S	100	153,00
M 12	x	35	S	100	167,00
M 12	x	40	S	100	174,00
M 12	x	45	S	100	190,00
M 12	x	50	S	100	201,00
M 12	x	60	S	100	227,00
M 12	x	70	S	50	260,00
M 12	x	80	S	50	290,00
M 12	x	90	S	50	330,00
M 12	x	100	S	50	355,00
M 16	x	30	S	50	233,00
M 16	x	35	S	50	249,00
M 16	x	40	S	50	265,00
M 16	x	45	S	50	280,00
M 16	x	50	S	50	295,00
M 16	x	60	S	50	345,00
M 16	x	65	S	25	365,00
M 16	x	70	S	25	365,00

Abmessungen VE Stück €/100/Obf.
 DIN 06921.810

6921

8.8

galvanisch verzinkt

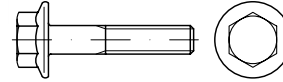

Sechskantschrauben mit Flansch

Maße → [TI-17](#)

Anziehmomente → [TI-244](#)

Werkstoffeigensch. → [TI-232](#)

Normumstellung → [TI-6](#)

Korrosionsschutz → [TI-228](#)

Rostfrei → [S. 557](#)

DIN 6921 → wird ersetzt durch EN 1665

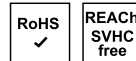

M 6	x	12	S	500	30,50 gal Zn
M 6	x	16	S	500	21,10 gal Zn
M 6	x	20	S	500	21,10 gal Zn
M 6	x	25	S	500	22,40 gal Zn
M 8	x	12	S	200	62,00 gal Zn
M 8	x	16	S	200	56,00 gal Zn
M 8	x	20	S	200	41,00 gal Zn
M 8	x	25	S	200	42,50 gal Zn
M 8	x	30	S	200	45,50 gal Zn
M 8	x	35	S	200	49,50 gal Zn
M 8	x	40	S	200	50,00 gal Zn
M 8	x	50	S	200	61,00 gal Zn
M 8	x	60	S	200	69,00 gal Zn
M 10	x	20	S	200	59,00 gal Zn
M 10	x	25	S	200	62,00 gal Zn
M 10	x	30	S	200	74,00 gal Zn
M 12	x	20	S	100	165,00 gal Zn
M 12	x	25	S	100	155,00 gal Zn
M 12	x	30	S	100	166,00 gal Zn
M 12	x	35	S	100	181,00 gal Zn
M 12	x	40	S	100	188,00 gal Zn
M 12	x	45	S	100	206,00 gal Zn
M 12	x	50	S	100	218,00 gal Zn
M 12	x	60	S	100	245,00 gal Zn
M 12	x	70	S	50	280,00 gal Zn
M 12	x	80	S	50	310,00 gal Zn
M 12	x	90	S	50	355,00 gal Zn
M 16	x	30	S	50	260,00 gal Zn
M 16	x	35	S	50	275,00 gal Zn
M 16	x	40	S	50	290,00 gal Zn
M 16	x	50	S	50	315,00 gal Zn
M 16	x	60	S	50	380,00 gal Zn
M 16	x	70	S	25	425,00 gal Zn

Abmessungen VE Stück €/100/Obf.
DIN 06921.100

6921 10.9



Sechskantschrauben mit Flansch

Maße → TI-17 Anziehmomente → TI-244
Werkstoffeigensch. → TI-232 Normumstellung → TI-6

Rostfrei → S. 557

DIN 6921 → wird ersetzt durch EN 1665

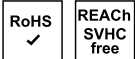

M 5	x	10	S	500	28,50
M 5	x	12	S	500	29,50
M 5	x	16	S	500	30,50
M 5	x	20	S	500	31,00
M 6	x	12	S	500	36,00
M 6	x	16	S	500	23,30
M 6	x	20	S	500	24,00
M 6	x	25	S	500	24,90
M 6	x	30	S	500	26,00
M 8	x	10	S	200	56,00
M 8	x	12	S	200	55,00
M 8	x	16	S	200	53,00
M 8	x	20	S	200	44,50
M 8	x	25	S	200	46,00
M 8	x	30	S	200	49,50
M 8	x	35	S	200	54,00
M 8	x	40	S	200	57,00
M 8	x	50	S	200	66,00
M 10	x	16	S	200	92,00
M 10	x	20	S	200	63,00
M 10	x	25	S	200	68,00
M 10	x	30	S	200	73,00
M 10	x	35	S	100	80,00
M 10	x	40	S	100	85,00
M 10	x	50	S	100	101,00
M 10	x	60	S	100	113,00
M 12	x	25	S	100	136,00
M 12	x	30	S	100	141,00
M 12	x	35	S	100	146,00
M 12	x	40	S	100	153,00
M 12	x	45	S	100	189,00
M 12	x	50	S	100	189,00
M 12	x	60	S	100	226,00
M 12	x	80	S	50	360,00
M 16	x	30	S	50	330,00
M 16	x	35	S	50	345,00
M 16	x	40	S	50	365,00
M 16	x	50	S	50	410,00
M 16	x	60	S	50	480,00
M 16	x	70	S	25	510,00

Abmessungen VE Stück €/100/Obf.
DIN 06921.110

6921 10.9
galvanisch verzinkt

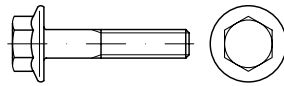

Sechskantschrauben mit Flansch

getempert

Achtung! Warneinblender zu Wasserstoffversprödung beachten.

Maße → TI-17 Anziehmomente → TI-244
Werkstoffeigensch. → TI-232 Normumstellung → TI-6
Korrosionsschutz → TI-228

Rostfrei → S. 557

DIN 6921 → wird ersetzt durch EN 1665

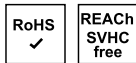

M 5	x	10	S	500	37,00 gal Zn
M 5	x	12	S	500	38,00 gal Zn
M 5	x	16	S	500	40,00 gal Zn
M 5	x	20	S	500	40,00 gal Zn
M 6	x	12	S	500	45,50 gal Zn
M 6	x	16	S	500	33,00 gal Zn
M 6	x	20	S	500	34,00 gal Zn
M 6	x	25	S	500	34,50 gal Zn
M 6	x	30	S	500	35,50 gal Zn
M 8	x	10	S	200	66,00 gal Zn
M 8	x	16	S	200	66,00 gal Zn
M 8	x	20	S	200	57,00 gal Zn
M 8	x	25	S	200	59,00 gal Zn
M 8	x	30	S	200	62,00 gal Zn
M 8	x	35	S	200	69,00 gal Zn
M 8	x	40	S	200	69,00 gal Zn
M 8	x	50	S	200	78,00 gal Zn
M 10	x	16	S	200	108,00 gal Zn
M 10	x	20	S	200	82,00 gal Zn
M 10	x	25	S	200	88,00 gal Zn
M 10	x	30	S	200	91,00 gal Zn
M 10	x	40	S	100	103,00 gal Zn
M 10	x	50	S	100	120,00 gal Zn
M 10	x	60	S	100	134,00 gal Zn
M 12	x	25	S	100	160,00 gal Zn
M 12	x	30	S	100	165,00 gal Zn
M 12	x	35	S	100	176,00 gal Zn
M 12	x	40	S	100	183,00 gal Zn
M 12	x	45	S	100	226,00 gal Zn
M 12	x	50	S	100	226,00 gal Zn

Wichtiger Hinweis!

Bei galvanischen Überzügen auf hochfesten und federharten Teilen (≥ 1000 N/mm² oder ≥ 320 HV) ist die Gefahr einer Wasserstoffversprödung (Spröbruchgefahr) nicht mit Sicherheit auszuschließen (ISO 4042). Durch eine rechtzeitig eingeleitete thermische Nachbehandlung (Tempern) kann die Gefahr eines wasserstoffinduzierten Spröbruchs im Regelfall verringert werden. Da aber ein Restrisiko nicht mit Sicherheit auszuschließen ist, erfolgen galvanische Überzüge auf derartigen Teilen nur auf ausdrücklichen Wunsch und auf Risiko des Auftraggebers.

Abmessungen VE Stück €/100/Obf.

M 12	x	60	S	100	265,00 gal Zn
M 12	x	70	S	50	395,00 gal Zn
M 12	x	80	S	50	395,00 gal Zn
M 16	x	35	S	50	390,00 gal Zn
M 16	x	40	S	50	410,00 gal Zn
M 16	x	50	S	50	450,00 gal Zn
M 16	x	60	S	50	530,00 gal Zn
M 16	x	70	S	25	560,00 gal Zn

DIN 06923.800

6923 8

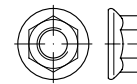

Sechskantmuttern mit Flansch

Maße → TI-64 Anziehmomente → TI-244
Werkstoffeigensch. → TI-233 Normumstellung → TI-7

Rostfrei → S. 558

DIN 6923 → wird ersetzt durch EN 1661



M 4	S	1000	9,10
M 5	S	1000	10,30
M 6	S	1000	13,40
M 8	S	1000	19,40
M 10	S	500	36,50
M 12	S	250	51,00
M 16	S	50	158,00
M 20	S	50	270,00

~DIN 06923.804

6923 8 **Sperrzahn**

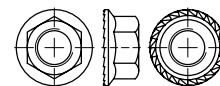

Sechskantmuttern mit Flansch und Sperrverzahnung

Maße → TI-64 Anziehmomente → TI-244
Werkstoffeigensch. → TI-233

Rostfrei → S. 558

Oberflächengehärtete Muttern → Artikel 88934

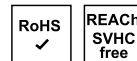

M 4	S	1000	9,70
M 5	S	1000	10,90
M 6	S	1000	13,40
M 8	S	1000	21,80
M 10	S	500	39,00
M 12	S	250	55,00
M 16	S	50	164,00
M 20	S	50	425,00

Abmessungen VE Stück €/100/Obf.

DIN	06923.810
6923	8 galvanisch verzinkt

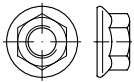

Sechskantmutter mit Flansch

Maße → [TI-64](#) Anziehmomente → [TI-244](#)
 Werkstoffeigensch. → [TI-233](#) Normumstellung → [TI-7](#)
 Korrosionsschutz → [TI-228](#)
 Rostfrei → [S. 558](#)
 DIN 6923 → wird ersetzt durch EN 1661

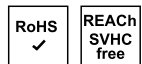

M 4	S 1000	12,50 gal Zn
M 5	S 1000	14,30 gal Zn
M 6	S 1000	15,80 gal Zn
M 8	S 1000	22,70 gal Zn
M 10	S 500	41,50 gal Zn
M 12	S 250	57,00 gal Zn
M 16	S 50	177,00 gal Zn
M 20	S 50	295,00 gal Zn

~DIN	06923.814
6923	8 Sperrzahn galvanisch verzinkt

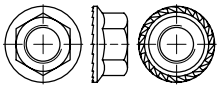

Sechskantmutter mit Flansch und Sperrverzahnung

Maße → [TI-64](#) Korrosionsschutz → [TI-228](#)
 Werkstoffeigensch. → [TI-233](#) Anziehmomente → [TI-244](#)
 Rostfrei → [S. 558](#)
 Oberflächengehärtete Muttern → Artikel 88934

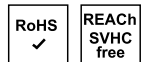

M 4	S 1000	13,40 gal Zn
M 5	S 1000	14,60 gal Zn
M 6	S 1000	16,40 gal Zn
M 8	S 1000	24,20 gal Zn
M 10	S 500	44,00 gal Zn
M 12	S 250	61,00 gal Zn
M 16	S 50	182,00 gal Zn
M 20	S 50	455,00 gal Zn

Abmessungen VE Stück €/100/Obf.

DIN	06923.100
6923	10

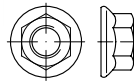

Sechskantmutter mit Flansch

Maße → [TI-64](#) Anziehmomente → [TI-244](#)
 Werkstoffeigensch. → [TI-233](#) Normumstellung → [TI-7](#)
 Rostfrei → [S. 558](#)
 DIN 6923 → wird ersetzt durch EN 1661

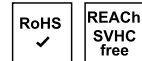

M 5	S 1000	11,50
M 6	S 1000	16,40
M 8	S 1000	36,00
M 10	S 500	60,00
M 12	S 250	92,00
M 16	S 50	218,00
M 20	S 50	485,00

~DIN	06923.104
6923	10 Sperrzahn

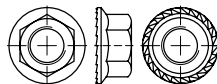

Sechskantmutter mit Flansch und Sperrverzahnung

Maße → [TI-64](#) Anziehmomente → [TI-244](#)
 Werkstoffeigensch. → [TI-233](#)
 Rostfrei → [S. 558](#)
 Oberflächengehärtete Muttern → Artikel 88934

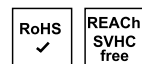

M 5	S 1000	12,10
M 6	S 1000	17,00
M 8	S 1000	36,50
M 10	S 500	61,00
M 12	S 250	95,00
M 16	S 50	223,00
M 20	S 50	510,00

Abmessungen VE Stück €/100/Obf.

DIN	06923.110
6923	10 galvanisch verzinkt

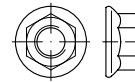

Sechskantmutter mit Flansch

Maße → [TI-64](#) Anziehmomente → [TI-244](#)
 Werkstoffeigensch. → [TI-233](#) Normumstellung → [TI-7](#)
 Korrosionsschutz → [TI-228](#)
 Rostfrei → [S. 558](#)
 DIN 6923 → wird ersetzt durch EN 1661

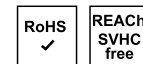

M 5	S 1000	13,40 gal Zn
M 6	S 1000	18,20 gal Zn
M 8	S 1000	39,00 gal Zn
M 10	S 500	66,00 gal Zn
M 12	S 250	100,00 gal Zn
M 16	S 50	230,00 gal Zn
M 20	S 50	530,00 gal Zn

~DIN	06923.114
6923	10 Sperrzahn galvanisch verzinkt

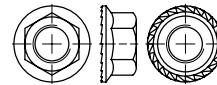

Sechskantmutter mit Flansch und Sperrverzahnung

Maße → [TI-64](#) Korrosionsschutz → [TI-228](#)
 Werkstoffeigensch. → [TI-233](#) Anziehmomente → [TI-244](#)
 Rostfrei → [S. 558](#)
 Oberflächengehärtete Muttern → Artikel 88934

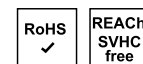

M 5	S 1000	14,60 gal Zn
M 6	S 1000	19,40 gal Zn
M 8	S 1000	41,50 gal Zn
M 10	S 500	68,00 gal Zn
M 12	S 250	103,00 gal Zn
M 16	S 50	242,00 gal Zn
M 20	S 50	550,00 gal Zn

Abmessungen	VE Stück	€/100/Obf.
DIN	06924.810	
6924	8	galvanisch verzinkt

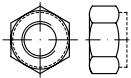

Sechskantmuttern mit Klemmteil, mit nichtmetallischem Einsatz, hohe Form

für Temperatur-Einsatz von -50 bis +120 °C

Maße → **TI-9** Normumstellung → **TI-7**
 Werkstoffeigensch. → **TI-233** Schraubensicherung → **TI-256**
 Korrosionsschutz → **TI-228**

Rostfrei → **S. 559**

DIN 6924 Regelgew. → wird ersetzt durch ISO 7040 (austauschbar)



M 4	S 200	20,00 gal Zn
M 5	S 200	19,00 gal Zn
M 6	S 100	22,10 gal Zn
M 8	S 100	28,00 gal Zn
M 10	S 100	48,00 gal Zn
M 12	S 100	62,00 gal Zn
M 16	S 50	120,00 gal Zn
M 20	S 50	227,00 gal Zn
M 24	S 25	360,00 gal Zn

DIN	06924.110
6924	10
	galvanisch verzinkt

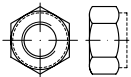

Sechskantmuttern mit Klemmteil, mit nichtmetallischem Einsatz, hohe Form

für Temperatur-Einsatz von -50 bis +120 °C,
 *M 10/12 RAZ = 3395, übrige Ø RAZ = 480

Maße → **TI-9** Normumstellung → **TI-7**
 Werkstoffeigensch. → **TI-233** Schraubensicherung → **TI-256**
 Korrosionsschutz → **TI-228**

Rostfrei → **S. 559**

DIN 6924 Regelgew. → wird ersetzt durch ISO 7040 (austauschbar)



M 10	S 100	77,00 gal Zn
M 12	S 100	111,00 gal Zn
M 16	S 50	197,00 gal Zn
M 20	S 50	360,00 gal Zn
M 24	S 25	480,00 gal Zn

Abmessungen	VE Stück	€/100/Obf.
DIN	06924.115	
6924	10	Fein galvanisch verzinkt

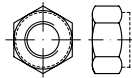

Sechskantmuttern mit Klemmteil, mit nichtmetallischem Einsatz, hohe Form, mit metr. Feingewinde

für Temperatur-Einsatz von -50 bis +120 °C

Maße → **TI-9** Normumstellung → **TI-7**
 Werkstoffeigensch. → **TI-233** Schraubensicherung → **TI-256**
 Korrosionsschutz → **TI-228**

DIN 6924 Feingew. → wird ersetzt durch ISO 10512



M 10	x 1	S 100	84,00 gal Zn
M 12	x 1,5	S 100	120,00 gal Zn
M 14	x 1,5	S 100	161,00 gal Zn
M 16	x 1,5	S 50	216,00 gal Zn
M 20	x 1,5	S 50	390,00 gal Zn
M 24	x 2	S 25	570,00 gal Zn

DIN	06925.810
6925	8
	galvanisch verzinkt

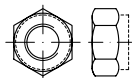

Sechskantmuttern mit Klemmteil, Ganzmetallmuttern

*< M 18 RAZ = 615, ab M18 RAZ = 480

Maße → **TI-9** Normumstellung → **TI-7**
 Werkstoffeigensch. → **TI-233** Schraubensicherung → **TI-256**
 Korrosionsschutz → **TI-228**

DIN 6925 Regelgew. → wird ersetzt durch ISO 7042



M 4	S 100	9,10 gal Zn
M 5	S 100	9,10 gal Zn
M 6	S 100	10,80 gal Zn
M 8	S 100	15,20 gal Zn
M 10	S 100	26,50 gal Zn
M 12	S 100	43,00 gal Zn
M 14	S 100	59,00 gal Zn
M 16	S 100	84,00 gal Zn
M 18	S 50	126,00 gal Zn
M 20	S 50	131,00 gal Zn
M 24	S 25	230,00 gal Zn
M 27	S 25	510,00 gal Zn
M 30	S 10	600,00 gal Zn
M 33	S 10	1150,00 gal Zn
M 36	S 10	1210,00 gal Zn

Abmessungen	VE Stück	€/100/Obf.
DIN	06925.840	
6925	8	fiZn/TL480h

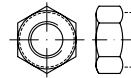

Sechskantmuttern mit Klemmteil, Ganzmetallmuttern

TL = Schmierstoff im Topcoat mit $\mu = 0,09 - 0,14$,
 Korrosionsbeständigkeit NSS: 480h RR,
 Chrom(VI)-frei,
 *bei Abmessung M 10 und 12 RAZ = 3395

Maße → **TI-9** Normumstellung → **TI-7**
 Werkstoffeigensch. → **TI-233** Schraubensicherung → **TI-256**
 Korrosionsschutz → **TI-230**

DIN 6925 Regelgew. → wird ersetzt durch ISO 7042



M 6	S 1000	11,10 fiZn
M 8	S 500	17,10 fiZn
M 10	S 500	30,00 fiZn
M 12	S 250	46,00 fiZn
M 16	S 100	88,00 fiZn
M 20	S 50	171,00 fiZn
M 24	S 25	310,00 fiZn

DIN	06925.815
6925	8
	galvanisch verzinkt
	Fein

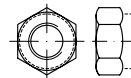

Sechskantmuttern mit Klemmteil, mit metrischem Feingewinde, Ganzmetallmuttern, einteilig

*bei Abmessung M 10, 12 und 14 RAZ = 3395

Maße → **TI-9** Normumstellung → **TI-7**
 Werkstoffeigensch. → **TI-233** Schraubensicherung → **TI-256**
 Korrosionsschutz → **TI-228**

DIN 6925 Feingew. → wird ersetzt durch ISO 10513



M 8	x 1	S 100	30,00 gal Zn
M 10	x 1	S 100	34,50 gal Zn
M 12	x 1,5	S 100	42,00 gal Zn
M 14	x 1,5	S 100	60,00 gal Zn
M 16	x 1,5	S 100	79,00 gal Zn
M 18	x 1,5	S 50	136,00 gal Zn
M 20	x 1,5	S 50	131,00 gal Zn
M 24	x 1,5	S 25	239,00 gal Zn
M 24	x 2	S 25	239,00 gal Zn
M 30	x 2	S 10	620,00 gal Zn

Abmessungen	VE Stück	€/100/Obf.
DIN	06925.110	
6925	10	galvanisch verzinkt

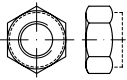

Sechskantmuttern mit Klemmteil, Ganzmetallmuttern

Maße → **TI-9** Normumstellung → **TI-7**
 Werkstoffeigensch. → **TI-233** Schraubensicherung → **TI-256**
 Korrosionsschutz → **TI-228**

DIN 6925 Regelgew. → wird ersetzt durch ISO 7042

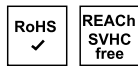

M 8	S	100	34,50 gal Zn
M 10	S	100	51,00 gal Zn
M 12	S	100	66,00 gal Zn
M 14	S	100	84,00 gal Zn
M 16	S	50	103,00 gal Zn
M 18	S	50	157,00 gal Zn
M 20	S	50	182,00 gal Zn
M 24	S	25	295,00 gal Zn
M 27	S	10	830,00 gal Zn
M 30	S	10	590,00 gal Zn
M 36	S	10	3050,00 gal Zn

DIN	06925.140
6925	10
	flZn/TL480h

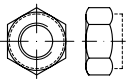

Sechskantmuttern mit Klemmteil, Ganzmetallmuttern

TL = Schmierstoff im Topcoat mit $\mu = 0,09 - 0,14$,
 Korrosionsbeständigkeit NSS: 480h RR,
 Chrom(VI)-frei,
 *bei Abmessung M 10 und 12 RAZ = 3395

Maße → **TI-9** Normumstellung → **TI-7**
 Werkstoffeigensch. → **TI-233** Schraubensicherung → **TI-256**
 Korrosionsschutz → **TI-230**

DIN 6925 Regelgew. → wird ersetzt durch ISO 7042

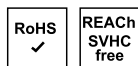

M 8	S	500	79,00 flZn
M 10	S	500	109,00 flZn
M 12	S	250	121,00 flZn
M 16	S	50	146,00 flZn
M 18	S	50	182,00 flZn
M 20	S	50	218,00 flZn
M 24	S	25	400,00 flZn

Abmessungen	VE Stück	€/100/Obf.
DIN	06925.115	
6925	10	galvanisch verzinkt
		Fein

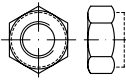

Sechskantmuttern mit Klemmteil, mit metrischem Feingewinde, Ganzmetallmuttern, einteilig

*bei Abmessung M 10, 12 und 14 RAZ = 3395

Maße → **TI-9** Normumstellung → **TI-7**
 Werkstoffeigensch. → **TI-233** Schraubensicherung → **TI-256**
 Korrosionsschutz → **TI-228**

DIN 6925 Feingew. → wird ersetzt durch ISO 10513



M 8	x 1	S	100	34,00 gal Zn
M 10	x 1	S	100	54,00 gal Zn
M 10	x 1,25	S	100	53,00 gal Zn
M 12	x 1,25	S	100	65,00 gal Zn
M 12	x 1,5	S	100	65,00 gal Zn
M 14	x 1,5	S	100	92,00 gal Zn
M 16	x 1,5	S	50	112,00 gal Zn
M 18	x 1,5	S	50	170,00 gal Zn
M 20	x 1,5	S	50	197,00 gal Zn
M 24	x 1,5	S	25	315,00 gal Zn
M 24	x 2	S	25	315,00 gal Zn

DIN	06926.810
6926	8
	galvanisch verzinkt



Sechskantmuttern mit Klemmteil und Flansch, mit nichtmetallischem Einsatz

für Temperatur-Einsatz von -50 bis +120 °C

Maße → **TI-69** Normumstellung → **TI-7**
 Werkstoffeigensch. → **TI-233** Schraubensicherung → **TI-256**
 Korrosionsschutz → **TI-228**

DIN 6926 Regelgew. → wird ersetzt durch EN 1663



M 5	S	100	14,60 gal Zn
M 6	S	100	18,10 gal Zn
M 8	S	100	22,20 gal Zn
M 16	S	100	84,00 gal Zn

Abmessungen	VE Stück	€/100/Obf.
DIN	06927.810	
6927	8	galvanisch verzinkt

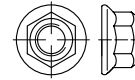

Sechskantmuttern mit Klemmteil und Flansch, Ganzmetallmuttern

Maße → **TI-69** Normumstellung → **TI-7**
 Werkstoffeigensch. → **TI-233** Schraubensicherung → **TI-256**
 Korrosionsschutz → **TI-228**

DIN 6927 Regelgew. → wird ersetzt durch EN 1664

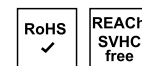

M 5	S	100	14,60 gal Zn
M 6	S	100	18,10 gal Zn
M 8	S	100	22,20 gal Zn
M 10 SW16	S	100	26,00 gal Zn
M 12	S	100	36,50 gal Zn
M 16	S	100	84,00 gal Zn

ISO	07040.810
7040	8
	galvanisch verzinkt

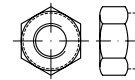

Sechskantmuttern mit Klemmteil, mit nichtmetallischem Einsatz, hohe Form

für Temperatur-Einsatz von -50 bis +120 °C,
 *M 14 RAZ = 3395, M 20/24 RAZ = 480,
 übrige Ø RAZ = 615

Maße → **TI-9** Normumstellung → **TI-7**
 Werkstoffeigensch. → **TI-233** Schraubensicherung → **TI-256**
 Korrosionsschutz → **TI-228**

Rostfrei → **S. 559**

ISO 7040 → ersetzt DIN 982 und 6924



M 4	S	200	20,00 gal Zn
M 5	S	200	19,00 gal Zn
M 6	S	100	22,10 gal Zn
M 8	S	100	28,00 gal Zn
M 10	S	100	48,00 gal Zn
M 12	S	100	62,00 gal Zn
M 14	S	100	83,00 gal Zn
M 16	S	50	120,00 gal Zn
M 20	S	50	227,00 gal Zn
M 24	S	25	360,00 gal Zn

Abmessungen	VE Stück	€/100/Obf.
ISO	07040.814	
7040	8	WS*
galvanisch verzinkt		

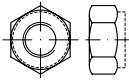

Sechskantmuttern mit Klemmteil, mit nichtmetallischem Einsatz, hohe Form, mit wärmostabilisiertem* Polyamid-Klemmring

*bis ~ +150/180 °C (BN 205107-03)

Maße → **TI-9** Normumstellung → **TI-7**
 Werkstoffeigensch. → **TI-233** Schraubensicherung → **TI-256**
 Korrosionsschutz → **TI-228**

Rostfrei → **S. 560**

ISO 7040 → ersetzt DIN 982 und 6924



M 5	S 1000	22,40 gal Zn
M 6	S 1000	23,30 gal Zn
M 8	S 1000	32,50 gal Zn
M 10	S 500	53,00 gal Zn
M 12	S 500	72,00 gal Zn
M 16	S 200	160,00 gal Zn
M 20	S 50	445,00 gal Zn
M 24	S 25	510,00 gal Zn

ISO	07040.110
7040	10
galvanisch verzinkt	

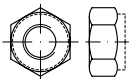

Sechskantmuttern mit Klemmteil, mit nichtmetallischem Einsatz, hohe Form

für Temperatur-Einsatz von -50 bis +120 °C,
 *M 10/12 RAZ = 3395, übrige Ø RAZ = 480

Maße → **TI-9** Normumstellung → **TI-7**
 Werkstoffeigensch. → **TI-233** Schraubensicherung → **TI-256**
 Korrosionsschutz → **TI-228**

Rostfrei → **S. 559**

ISO 7040 → ersetzt DIN 982 und 6924



M 10	S 100	77,00 gal Zn
M 12	S 100	111,00 gal Zn
M 16	S 50	197,00 gal Zn
M 20	S 50	360,00 gal Zn
M 24	S 25	480,00 gal Zn

Abmessungen	VE Stück	€/100/Obf.
ISO	07042.810	
7042	8	
galvanisch verzinkt		

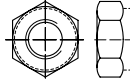

Sechskantmuttern mit Klemmteil, Ganzmetallmuttern

*M 10/12/22 RAZ = 3395, M 14 RAZ = 615,
 übrige Ø RAZ = 480

Maße → **TI-9** Normumstellung → **TI-7**
 Werkstoffeigensch. → **TI-233** Schraubensicherung → **TI-256**
 Korrosionsschutz → **TI-228**

ISO 7042 → ersetzt DIN 980 und 6925



M 4	S 100	9,10 gal Zn
M 5	S 100	9,10 gal Zn
M 10	S 500	21,70 gal Zn
M 12	S 250	34,00 gal Zn
M 14	S 100	59,00 gal Zn
M 18	S 50	126,00 gal Zn
M 20	S 50	131,00 gal Zn
M 24	S 25	230,00 gal Zn
M 27	S 25	510,00 gal Zn
M 30	S 10	600,00 gal Zn
M 33	S 10	1150,00 gal Zn
M 36	S 10	1210,00 gal Zn

ISO	07042.841
7042	8
fiZn/TL 480h	

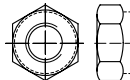

Sechskantmuttern mit Klemmteil, Ganzmetallmuttern

TL = Schmierstoff im Topcoat mit $\mu = 0,09 - 0,14$,
 Korrosionsbeständigkeit NSS: 480h RR,
 Chrom(VI)-frei

Achtung! Gegenüber galv. verzinkt geänderte Anziehdrehmomente.

Maße → **TI-9** Normumstellung → **TI-7**
 Werkstoffeigensch. → **TI-233** Schraubensicherung → **TI-256**
 Korrosionsschutz → **TI-230**

ISO 7042 → ersetzt DIN 980 und 6925



M 6	S 1000	11,10 fiZn
M 8	S 500	17,10 fiZn
M 10	S 500	30,00 fiZn
M 12	S 250	46,00 fiZn
M 16	S 100	88,00 fiZn
M 20	S 50	171,00 fiZn
M 24	S 25	310,00 fiZn

Abmessungen	VE Stück	€/100/Obf.
ISO	07042.820	
7042	8	
feuerverzinkt		

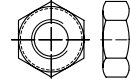

Sechskantmuttern mit Klemmteil, Ganzmetallmuttern, zweiteilig

Gewindetoleranz 6H

→ ISO 4014/4017 8.8 tZn SB

Maße → **TI-9** Normumstellung → **TI-7**
 Werkstoffeigensch. → **TI-233** Schraubensicherung → **TI-256**
 Korrosionsschutz → **TI-230**

CE = auch zur Verwendung im Stahlbau als nicht planmäßig vorgespannte Schraubverb. nach EN 15048



M 5	S 100	177,00 tZn
M 6	S 100	71,00 tZn
M 8	S 100	83,00 tZn
M 10	S 100	95,00 tZn
M 12	S 100	115,00 tZn
M 16	S 50	219,00 tZn
M 20	S 50	680,00 tZn
M 24	S 25	940,00 tZn

ISO	07042.110
7042	10
galvanisch verzinkt	

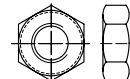

Sechskantmuttern mit Klemmteil, Ganzmetallmuttern

*M 22 RAZ = 3395, M 27/30/36 RAZ = 480,
 übrige Ø RAZ = 615

Maße → **TI-9** Normumstellung → **TI-7**
 Werkstoffeigensch. → **TI-233** Schraubensicherung → **TI-256**
 Korrosionsschutz → **TI-228**

ISO 7042 → ersetzt DIN 980 und 6925



M 8	S 100	34,50 gal Zn
M 10	S 100	51,00 gal Zn
M 12	S 100	66,00 gal Zn
M 14	S 100	84,00 gal Zn
M 16	S 50	103,00 gal Zn
M 18	S 50	157,00 gal Zn
M 20	S 50	182,00 gal Zn
M 24	S 25	295,00 gal Zn
M 27	S 10	830,00 gal Zn
M 30	S 10	590,00 gal Zn
M 36	S 10	3050,00 gal Zn

Abmessungen	VE Stück	€/100/Obf.
ISO 07042.140		
7042	10	
	fZn/TL480h	

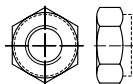

Sechskantmuttern mit Klemmteil, Ganzmetallmuttern

TL = Schmierstoff im Topcoat mit $\mu = 0,09 - 0,14$, Korrosionsbeständigkeit NSS: 480h RR, Chrom(VI)-frei

Achtung! Gegenüber galv. verzinkt geänderte Anziehdrehmomente.

Maße \rightarrow TI-9 Normumstellung \rightarrow TI-7
 Werkstoffeigensch. \rightarrow TI-233 Schraubensicherung \rightarrow TI-256
 Korrosionsschutz \rightarrow TI-230

ISO 7042 \rightarrow ersetzt DIN 980 und 6925

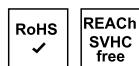

M 8	S	500	79,00 fZn
M 10	S	500	109,00 fZn
M 12	S	250	121,00 fZn
M 16	S	50	146,00 fZn
M 18	S	50	182,00 fZn
M 20	S	50	218,00 fZn
M 24	S	25	400,00 fZn

ISO	07045.404		
7045	4.8		H



Linsenschrauben mit Phillips-Kreuzschlitz H

Maße \rightarrow TI-40 Normumstellung \rightarrow TI-11
 Werkstoffeigensch. \rightarrow TI-232 REACH \rightarrow TI-262

Rostfrei \rightarrow S. 561

ISO 7045 \rightarrow ersetzt DIN 7985 (austauschbar)



M 3	x	5-H	S	2000	6,10
M 3	x	6-H	S	2000	3,45
M 3	x	8-H	S	2000	2,30
M 3	x	10-H	S	2000	2,40
M 3	x	12-H	S	2000	2,45
M 3	x	16-H	S	2000	2,75
M 3	x	20-H	S	2000	3,10
M 4	x	6-H	S	2000	5,10
M 4	x	8-H	S	2000	3,30
M 4	x	10-H	S	2000	3,40
M 4	x	12-H	S	2000	3,45
M 4	x	16-H	S	2000	4,10
M 4	x	20-H	S	2000	4,20
M 4	x	25-H	S	1000	4,40
M 4	x	30-H	S	1000	6,00
M 5	x	8-H	S	2000	4,80
M 5	x	10-H	S	2000	4,85

Abmessungen	VE Stück	€/100/Obf.			
M 5	x	12-H	S	1000	5,10
M 5	x	16-H	S	1000	5,60
M 5	x	20-H	S	1000	6,00
M 5	x	25-H	S	1000	6,90
M 6	x	10-H	S	1000	7,20
M 6	x	12-H	S	1000	7,20
M 6	x	16-H	S	1000	7,90
M 6	x	20-H	S	1000	8,20
M 6	x	25-H	S	500	9,10
M 6	x	40-H	S	500	13,60
M 8	x	16-H	S	500	16,70
M 8	x	25-H	S	200	20,60

ISO	07045.414		
7045	4.8		H
	galvanisch verzinkt		



Linsenschrauben mit Phillips-Kreuzschlitz H

Maße \rightarrow TI-40 Normumstellung \rightarrow TI-11
 Werkstoffeigensch. \rightarrow TI-232 REACH \rightarrow TI-262

Korrosionsschutz \rightarrow TI-228

Rostfrei \rightarrow S. 561

ISO 7045 \rightarrow ersetzt DIN 7985 (austauschbar)



M 2	x	4-H	S	2000	8,40 gal Zn
M 2	x	4-H	K	200	11,30 gal Zn
M 2	x	5-H	S	2000	8,40 gal Zn
M 2	x	5-H	K	200	11,30 gal Zn
M 2	x	6-H	S	2000	4,60 gal Zn
M 2	x	6-H	K	200	6,30 gal Zn
M 2	x	8-H	S	2000	4,60 gal Zn
M 2	x	8-H	K	200	7,60 gal Zn
M 2	x	10-H	S	2000	4,75 gal Zn
M 2	x	10-H	K	200	7,70 gal Zn
M 2	x	12-H	S	2000	4,85 gal Zn
M 2	x	12-H	K	200	7,80 gal Zn
M 2	x	16-H	S	2000	5,00 gal Zn
M 2	x	16-H	K	200	7,90 gal Zn
M 2	x	20-H	S	2000	5,30 gal Zn
M 2	x	20-H	K	200	8,20 gal Zn
M 2,5	x	4-H	S	2000	9,20 gal Zn
M 2,5	x	4-H	K	200	12,10 gal Zn
M 2,5	x	5-H	S	2000	9,20 gal Zn
M 2,5	x	5-H	K	200	12,10 gal Zn
M 2,5	x	6-H	S	2000	4,70 gal Zn
M 2,5	x	6-H	K	200	7,70 gal Zn
M 2,5	x	8-H	S	2000	4,70 gal Zn
M 2,5	x	8-H	K	200	7,70 gal Zn
M 2,5	x	10-H	S	2000	4,80 gal Zn
M 2,5	x	10-H	K	200	7,80 gal Zn
M 2,5	x	12-H	K	200	7,90 gal Zn
M 2,5	x	14-H	S	2000	9,70 gal Zn
M 2,5	x	16-H	S	2000	5,40 gal Zn
M 2,5	x	16-H	K	200	8,40 gal Zn
M 2,5	x	20-H	S	2000	5,80 gal Zn
M 2,5	x	20-H	K	200	8,70 gal Zn
M 2,5	x	25-H	S	2000	6,80 gal Zn
M 2,5	x	25-H	K	200	9,70 gal Zn
M 2,5	x	30-H	S	2000	14,60 gal Zn
M 2,5	x	30-H	K	200	17,50 gal Zn
M 3	x	3-H	S	2000	12,10 gal Zn
M 3	x	3-H	K	200	14,60 gal Zn
M 3	x	4-H	S	2000	10,00 gal Zn

Abmessungen	VE Stück	€/100/Obf.			
M 3	x	4-H	K	200	12,90 gal Zn
M 3	x	5-H	S	2000	6,70 gal Zn
M 3	x	5-H	K	200	9,60 gal Zn
M 3	x	6-H	K	200	6,80 gal Zn
M 3	x	8-H	K	200	5,50 gal Zn
M 3	x	10-H	S	2000	2,60 gal Zn
M 3	x	10-H	K	200	5,50 gal Zn
M 3	x	12-H	S	2000	2,75 gal Zn
M 3	x	12-H	K	200	5,70 gal Zn
M 3	x	14-H	S	2000	3,25 gal Zn
M 3	x	14-H	K	200	6,20 gal Zn
M 3	x	16-H	S	2000	3,00 gal Zn
M 3	x	16-H	K	200	5,90 gal Zn
M 3	x	18-H	S	2000	3,40 gal Zn
M 3	x	18-H	K	200	6,30 gal Zn
M 3	x	20-H	S	2000	3,40 gal Zn
M 3	x	20-H	K	200	6,30 gal Zn
M 3	x	22-H	S	2000	3,85 gal Zn
M 3	x	22-H	K	200	6,80 gal Zn
M 3	x	25-H	S	2000	4,20 gal Zn
M 3	x	25-H	K	200	7,20 gal Zn
M 3	x	28-H	S	2000	13,40 gal Zn
M 3	x	28-H	K	200	16,30 gal Zn
M 3	x	30-H	S	2000	5,30 gal Zn
M 3	x	30-H	K	200	8,20 gal Zn
M 3	x	35-H	S	2000	8,20 gal Zn
M 3	x	35-H	K	200	11,10 gal Zn
M 3	x	40-H	S	1000	8,50 gal Zn
M 3	x	40-H	K	200	11,40 gal Zn
M 3	x	45-H	S	1000	12,80 gal Zn
M 3	x	45-H	K	200	15,10 gal Zn
M 3	x	50-H	S	1000	14,60 gal Zn
M 3	x	50-H	K	200	17,50 gal Zn
M 3	x	55-H	S	200	30,50 gal Zn
M 3,5	x	5-H	S	2000	10,90 gal Zn
M 3,5	x	6-H	S	2000	11,20 gal Zn
M 4	x	4-H	S	2000	12,10 gal Zn
M 4	x	4-H	K	200	15,10 gal Zn
M 4	x	5-H	S	2000	8,60 gal Zn
M 4	x	5-H	K	200	11,50 gal Zn
M 4	x	6-H	S	2000	5,60 gal Zn
M 4	x	6-H	K	200	8,60 gal Zn
M 4	x	8-H	K	200	6,70 gal Zn
M 4	x	10-H	K	200	6,80 gal Zn
M 4	x	12-H	S	2000	3,90 gal Zn
M 4	x	12-H	K	200	6,80 gal Zn
M 4	x	14-H	S	2000	5,40 gal Zn
M 4	x	14-H	K	200	8,40 gal Zn
M 4	x	16-H	S	2000	4,40 gal Zn
M 4	x	16-H	K	200	7,30 gal Zn
M 4	x	18-H	S	2000	5,10 gal Zn
M 4	x	18-H	K	200	8,00 gal Zn
M 4	x	20-H	S	2000	4,60 gal Zn
M 4	x	20-H	K	200	7,70 gal Zn
M 4	x	22-H	S	2000	7,30 gal Zn
M 4	x	25-H	S	1000	4,85 gal Zn
M 4	x	25-H	K	200	7,90 gal Zn
M 4	x	30-H	S	1000	6,70 gal Zn
M 4	x	30-H	K	200	9,60 gal Zn
M 4	x	35-H	S	1000	7,80 gal Zn
M 4	x	35-H	K	200	10,70 gal Zn
M 4	x	40-H	S	1000	8,80 gal Zn
M 4	x	40-H	K	200	11,70 gal Zn
M 4	x	45-H	S	1000	13,50 gal Zn
M 4	x	45-H	K	200	16,50 gal Zn
M 4	x	50-H	S	1000	16,10 gal Zn
M 4	x	50-H	K	200	19,20 gal Zn
M 4	x	55-H	S	500	23,20 gal Zn
M 4	x	60-H	S	500	23,20 gal Zn
M 4	x	65-H	S	500	47,50 gal Zn
M 4	x	70-H	S	500	30,00 gal Zn
M 4	x	80-H	S	500	38,50 gal Zn
M 4	x	85-H	S	500	48,50 gal Zn
M 4	x	90-H	S	200	67,00 gal Zn
M 4	x	100-H	S	200	79,00 gal Zn

Abmessungen	VE	Stück	€/100/Obf.
M 5 x 6 -H	S	2000	10,70 gal Zn
M 5 x 6 -H	K	200	13,60 gal Zn
M 5 x 8 -H	S	2000	5,30 gal Zn
M 5 x 8 -H	K	200	8,20 gal Zn
M 5 x 10 -H	K	200	8,40 gal Zn
M 5 x 12 -H	S	1000	5,60 gal Zn
M 5 x 12 -H	K	200	8,60 gal Zn
M 5 x 14 -H	S	1000	6,10 gal Zn
M 5 x 14 -H	K	200	9,00 gal Zn
M 5 x 16 -H	K	200	9,10 gal Zn
M 5 x 18 -H	S	1000	7,30 gal Zn
M 5 x 18 -H	K	200	10,20 gal Zn
M 5 x 20 -H	S	1000	6,70 gal Zn
M 5 x 20 -H	K	200	9,60 gal Zn
M 5 x 25 -H	S	1000	7,80 gal Zn
M 5 x 25 -H	K	200	10,70 gal Zn
M 5 x 30 -H	S	1000	9,20 gal Zn
M 5 x 30 -H	K	200	12,10 gal Zn
M 5 x 35 -H	S	500	10,60 gal Zn
M 5 x 35 -H	K	200	13,40 gal Zn
M 5 x 40 -H	S	500	10,60 gal Zn
M 5 x 40 -H	K	200	13,50 gal Zn
M 5 x 45 -H	S	500	12,40 gal Zn
M 5 x 45 -H	K	200	15,40 gal Zn
M 5 x 50 -H	S	500	18,10 gal Zn
M 5 x 50 -H	K	200	21,00 gal Zn
M 5 x 60 -H	S	200	23,90 gal Zn
M 5 x 70 -H	S	200	33,50 gal Zn
M 5 x 80 -H	S	200	42,00 gal Zn
M 5 x 90 -H	S	200	48,50 gal Zn
M 5 x 100 -H	S	200	57,00 gal Zn
M 6 x 8 -H	K	200	17,00 gal Zn
M 6 x 10 -H	S	1000	8,00 gal Zn
M 6 x 10 -H	K	200	10,90 gal Zn
M 6 x 12 -H	S	1000	7,80 gal Zn
M 6 x 12 -H	K	200	10,80 gal Zn
M 6 x 14 -H	S	1000	9,70 gal Zn
M 6 x 14 -H	K	200	12,80 gal Zn
M 6 x 16 -H	K	200	11,80 gal Zn
M 6 x 18 -H	S	1000	9,70 gal Zn
M 6 x 20 -H	S	1000	9,10 gal Zn
M 6 x 20 -H	K	200	12,00 gal Zn
M 6 x 25 -H	S	500	10,10 gal Zn
M 6 x 25 -H	K	200	13,00 gal Zn
M 6 x 30 -H	S	500	11,80 gal Zn
M 6 x 30 -H	K	200	14,80 gal Zn
M 6 x 35 -H	S	500	14,20 gal Zn
M 6 x 35 -H	K	200	17,10 gal Zn
M 6 x 40 -H	K	200	18,10 gal Zn
M 6 x 45 -H	S	500	15,80 gal Zn
M 6 x 45 -H	K	200	18,70 gal Zn
M 6 x 50 -H	S	200	18,00 gal Zn
M 6 x 55 -H	S	200	47,50 gal Zn
M 6 x 60 -H	S	200	22,20 gal Zn
M 6 x 70 -H	S	200	35,50 gal Zn
M 6 x 75 -H	S	200	41,00 gal Zn
M 6 x 80 -H	S	200	41,00 gal Zn
M 6 x 90 -H	S	100	49,50 gal Zn
M 6 x 100 -H	S	100	58,00 gal Zn
M 8 x 12 -H	S	500	26,50 gal Zn
M 8 x 12 -H	K	200	29,50 gal Zn
M 8 x 16 -H	S	500	18,60 gal Zn
M 8 x 16 -H	K	200	21,50 gal Zn
M 8 x 20 -H	S	500	19,70 gal Zn
M 8 x 20 -H	K	200	22,70 gal Zn
M 8 x 25 -H	S	200	22,70 gal Zn
M 8 x 30 -H	S	200	24,90 gal Zn
M 8 x 35 -H	S	200	28,00 gal Zn
M 8 x 40 -H	S	100	29,50 gal Zn
M 8 x 45 -H	S	100	34,50 gal Zn
M 8 x 50 -H	S	100	36,00 gal Zn
M 8 x 60 -H	S	100	44,50 gal Zn
M 8 x 70 -H	S	100	54,00 gal Zn

Abmessungen	VE	Stück	€/100/Obf.
M 8 x 80 -H	S	100	68,00 gal Zn
M 8 x 90 -H	S	100	91,00 gal Zn
M 10 x 25 -H	S	100	115,00 gal Zn

ISO 07045.416

7045 4.8 galvanisch verzinkt Z



Linsenschrauben mit Pozidriv-Kreuzschlitz Z

Maße → TI-40 Normumstellung → TI-11
 Werkstoffeigensch. → TI-232 REACH → TI-262
 Korrosionsschutz → TI-228

Rostfrei → S. 562

ISO 7045 → ersetzt DIN 7985 (austauschbar)



M 2,5 x 4 -Z	S	2000	9,20 gal Zn
M 2,5 x 5 -Z	S	2000	9,20 gal Zn
M 2,5 x 6 -Z	S	2000	4,70 gal Zn
M 2,5 x 8 -Z	S	2000	4,70 gal Zn
M 2,5 x 10 -Z	S	2000	4,80 gal Zn
M 2,5 x 12 -Z	S	2000	4,95 gal Zn
M 2,5 x 16 -Z	S	2000	5,40 gal Zn
M 3 x 4 -Z	S	2000	10,00 gal Zn
M 3 x 5 -Z	S	2000	6,70 gal Zn
M 3 x 6 -Z	S	2000	3,85 gal Zn
M 3 x 8 -Z	S	2000	2,60 gal Zn
M 3 x 10 -Z	S	2000	2,60 gal Zn
M 3 x 12 -Z	S	2000	2,75 gal Zn
M 3 x 16 -Z	S	2000	3,00 gal Zn
M 3 x 20 -Z	S	2000	3,40 gal Zn
M 3 x 25 -Z	S	2000	4,20 gal Zn
M 3 x 30 -Z	S	2000	5,30 gal Zn
M 3 x 35 -Z	S	2000	8,20 gal Zn
M 3 x 40 -Z	S	1000	8,50 gal Zn
M 4 x 5 -Z	S	2000	8,60 gal Zn
M 4 x 6 -Z	S	2000	5,60 gal Zn
M 4 x 8 -Z	S	2000	3,65 gal Zn
M 4 x 10 -Z	S	2000	3,75 gal Zn
M 4 x 12 -Z	S	2000	3,90 gal Zn
M 4 x 16 -Z	S	2000	4,40 gal Zn
M 4 x 18 -Z	S	2000	5,10 gal Zn
M 4 x 20 -Z	S	2000	4,60 gal Zn
M 4 x 25 -Z	S	1000	4,85 gal Zn
M 4 x 30 -Z	S	1000	6,70 gal Zn
M 4 x 35 -Z	S	1000	7,80 gal Zn
M 4 x 40 -Z	S	1000	8,80 gal Zn
M 4 x 45 -Z	S	1000	13,50 gal Zn
M 4 x 50 -Z	S	1000	16,10 gal Zn
M 4 x 60 -Z	S	500	23,20 gal Zn
M 4 x 70 -Z	S	500	30,00 gal Zn
M 5 x 6 -Z	S	2000	10,70 gal Zn
M 5 x 8 -Z	S	2000	5,30 gal Zn
M 5 x 10 -Z	S	2000	5,40 gal Zn
M 5 x 12 -Z	S	1000	5,60 gal Zn
M 5 x 16 -Z	S	1000	6,20 gal Zn
M 5 x 20 -Z	S	1000	6,70 gal Zn
M 5 x 25 -Z	S	1000	7,80 gal Zn
M 5 x 30 -Z	S	1000	9,20 gal Zn
M 5 x 35 -Z	S	500	10,60 gal Zn
M 5 x 40 -Z	S	500	10,60 gal Zn
M 5 x 45 -Z	S	500	12,40 gal Zn
M 5 x 50 -Z	S	500	18,10 gal Zn

Abmessungen	VE	Stück	€/100/Obf.
M 5 x 60 -Z	S	200	23,90 gal Zn
M 5 x 70 -Z	S	200	33,50 gal Zn
M 5 x 80 -Z	S	200	42,00 gal Zn
M 6 x 8 -Z	S	1000	14,10 gal Zn
M 6 x 10 -Z	S	1000	8,00 gal Zn
M 6 x 12 -Z	S	1000	7,80 gal Zn
M 6 x 16 -Z	S	1000	8,80 gal Zn
M 6 x 20 -Z	S	1000	9,10 gal Zn
M 6 x 25 -Z	S	500	10,10 gal Zn
M 6 x 30 -Z	S	500	11,80 gal Zn
M 6 x 35 -Z	S	500	14,20 gal Zn
M 6 x 40 -Z	S	500	15,20 gal Zn
M 6 x 45 -Z	S	500	15,80 gal Zn
M 6 x 50 -Z	S	200	18,00 gal Zn
M 6 x 60 -Z	S	200	22,20 gal Zn

ISO 07045.435

7045 4.8 galv. verz. 8 DiSP* H



Linsenschrauben mit Phillips-Kreuzschlitz H

*< M 6 Mindestschichtdicke 5µm, Korrosionsbeständigkeit NSS: 72h WR, 120h RR

Maße → TI-40 Normumstellung → TI-11
 Werkstoffeigensch. → TI-232 REACH → TI-262
 Korrosionsschutz → TI-228

Rostfrei → S. 561

ISO 7045 → ersetzt DIN 7985 (austauschbar)



M 3 x 6 -H	S	2000	5,10 gal ZnDi
M 3 x 8 -H	S	2000	3,55 gal ZnDi
M 3 x 12 -H	S	2000	4,00 gal ZnDi
M 3 x 16 -H	S	2000	4,10 gal ZnDi
M 4 x 8 -H	S	2000	5,10 gal ZnDi
M 4 x 10 -H	S	2000	5,30 gal ZnDi
M 4 x 12 -H	S	2000	5,50 gal ZnDi
M 4 x 16 -H	S	2000	6,00 gal ZnDi
M 4 x 20 -H	S	2000	6,20 gal ZnDi
M 4 x 25 -H	S	1000	7,60 gal ZnDi
M 4 x 30 -H	S	1000	8,50 gal ZnDi
M 5 x 8 -H	S	2000	6,70 gal ZnDi
M 5 x 10 -H	S	2000	7,30 gal ZnDi
M 5 x 12 -H	S	1000	7,60 gal ZnDi
M 5 x 16 -H	S	1000	8,40 gal ZnDi
M 5 x 20 -H	S	1000	8,70 gal ZnDi
M 6 x 10 -H	S	1000	10,70 gal ZnDi
M 6 x 12 -H	S	1000	10,90 gal ZnDi
M 6 x 25 -H	S	500	13,40 gal ZnDi

Abmessungen VE Stück €/100/Obf.
ISO 07046.404

7046-1 4.8 H



Senkschrauben mit Phillips-Kreuzschlitz H

Maße → TI-39 Normumstellung → TI-11
Werkstoffeigensch. → TI-232 REACH → TI-262

Rostfrei → S. 563

ISO 7046 → ersetzt DIN 965 (austauschbar)



M 2,5	x	6-H	S	2000	4,55
M 2,5	x	8-H	S	2000	4,60
M 3	x	5-H	S	2000	5,40
M 3	x	6-H	S	2000	3,70
M 3	x	8-H	S	2000	1,95
M 3	x	10-H	S	2000	2,15
M 3	x	12-H	S	2000	2,20
M 3	x	16-H	S	2000	2,75
M 3	x	20-H	S	2000	2,80
M 3	x	25-H	S	2000	3,95
M 4	x	6-H	S	2000	5,20
M 4	x	8-H	S	2000	2,80
M 4	x	10-H	S	2000	2,85
M 4	x	12-H	S	2000	3,10
M 4	x	16-H	S	2000	3,35
M 4	x	20-H	S	2000	3,65
M 4	x	25-H	S	1000	4,15
M 4	x	30-H	S	1000	5,40
M 5	x	8-H	S	2000	7,30
M 5	x	10-H	S	2000	3,90
M 5	x	12-H	S	1000	4,10
M 5	x	16-H	S	1000	4,40
M 5	x	20-H	S	1000	5,00
M 5	x	25-H	S	1000	5,60
M 5	x	40-H	S	500	8,40
M 6	x	10-H	S	1000	9,70
M 6	x	12-H	S	1000	5,70
M 6	x	16-H	S	1000	6,50
M 6	x	20-H	S	1000	7,20
M 6	x	25-H	S	500	8,20
M 6	x	30-H	S	200	9,10
M 6	x	35-H	S	500	10,70
M 8	x	16-H	S	500	14,90
M 8	x	20-H	S	500	15,50
M 8	x	25-H	S	200	17,10
M 8	x	30-H	S	200	19,50

Abmessungen VE Stück €/100/Obf.
ISO 07046.414

7046-1 4.8 galvanisch verzinkt H



Senkschrauben mit Phillips-Kreuzschlitz H

Maße → TI-39 Normumstellung → TI-11
Werkstoffeigensch. → TI-232 REACH → TI-262
Korrosionsschutz → TI-228

Rostfrei → S. 563

ISO 7046 → ersetzt DIN 965 (austauschbar)



M 2	x	5-H	S	2000	4,60 gal Zn
M 2	x	6-H	S	2000	4,60 gal Zn
M 2	x	6-H	K	200	7,60 gal Zn
M 2	x	8-H	S	2000	4,60 gal Zn
M 2	x	8-H	K	200	7,60 gal Zn
M 2	x	10-H	K	200	7,70 gal Zn
M 2	x	12-H	S	2000	4,85 gal Zn
M 2	x	12-H	K	200	7,80 gal Zn
M 2	x	16-H	S	2000	5,00 gal Zn
M 2	x	16-H	K	200	7,90 gal Zn
M 2	x	20-H	S	2000	5,30 gal Zn
M 2	x	20-H	K	200	8,20 gal Zn
M 2,5	x	4-H	S	2000	11,10 gal Zn
M 2,5	x	4-H	K	200	14,00 gal Zn
M 2,5	x	5-H	S	2000	6,70 gal Zn
M 2,5	x	5-H	K	200	9,60 gal Zn
M 2,5	x	6-H	S	2000	5,00 gal Zn
M 2,5	x	6-H	K	200	8,00 gal Zn
M 2,5	x	8-H	S	2000	4,60 gal Zn
M 2,5	x	8-H	K	200	8,00 gal Zn
M 2,5	x	10-H	K	200	8,20 gal Zn
M 2,5	x	12-H	S	2000	5,30 gal Zn
M 2,5	x	12-H	K	200	8,30 gal Zn
M 2,5	x	16-H	S	2000	5,80 gal Zn
M 2,5	x	16-H	K	200	8,80 gal Zn
M 2,5	x	20-H	S	2000	8,30 gal Zn
M 2,5	x	20-H	K	200	11,20 gal Zn
M 3	x	4-H	S	2000	5,10 gal Zn
M 3	x	4-H	K	200	7,70 gal Zn
M 3	x	5-H	S	2000	5,90 gal Zn
M 3	x	5-H	K	200	8,80 gal Zn
M 3	x	6-H	K	200	7,10 gal Zn
M 3	x	8-H	K	200	5,20 gal Zn
M 3	x	10-H	K	200	5,30 gal Zn
M 3	x	12-H	S	2000	2,40 gal Zn
M 3	x	12-H	K	200	5,40 gal Zn
M 3	x	14-H	S	2000	2,80 gal Zn
M 3	x	14-H	K	200	5,80 gal Zn
M 3	x	16-H	S	2000	3,00 gal Zn
M 3	x	16-H	K	200	6,00 gal Zn
M 3	x	18-H	S	2000	3,40 gal Zn
M 3	x	18-H	K	200	6,30 gal Zn
M 3	x	20-H	S	2000	3,15 gal Zn
M 3	x	20-H	K	200	6,10 gal Zn
M 3	x	22-H	S	2000	3,65 gal Zn
M 3	x	22-H	K	200	6,60 gal Zn
M 3	x	25-H	S	2000	4,40 gal Zn
M 3	x	25-H	K	200	7,30 gal Zn
M 3	x	30-H	S	2000	5,40 gal Zn
M 3	x	30-H	K	200	8,60 gal Zn
M 3	x	35-H	S	2000	7,90 gal Zn
M 3	x	40-H	S	1000	9,10 gal Zn

Abmessungen VE Stück €/100/Obf.

M 3	x	45-H	S	1000	10,30 gal Zn
M 3	x	50-H	S	1000	11,30 gal Zn
M 4	x	5-H	S	2000	5,70 gal Zn
M 4	x	5-H	K	200	8,60 gal Zn
M 4	x	6-H	S	2000	5,70 gal Zn
M 4	x	6-H	K	200	8,60 gal Zn
M 4	x	8-H	K	200	6,10 gal Zn
M 4	x	10-H	S	2000	3,25 gal Zn
M 4	x	10-H	K	200	6,20 gal Zn
M 4	x	12-H	K	200	6,30 gal Zn
M 4	x	14-H	S	2000	3,65 gal Zn
M 4	x	14-H	K	200	6,70 gal Zn
M 4	x	16-H	S	2000	3,70 gal Zn
M 4	x	16-H	K	200	6,70 gal Zn
M 4	x	18-H	S	2000	4,45 gal Zn
M 4	x	20-H	S	2000	3,95 gal Zn
M 4	x	20-H	K	200	6,90 gal Zn
M 4	x	25-H	S	1000	4,55 gal Zn
M 4	x	25-H	K	200	7,60 gal Zn
M 4	x	28-H	S	1000	12,80 gal Zn
M 4	x	30-H	S	1000	5,90 gal Zn
M 4	x	30-H	K	200	8,90 gal Zn
M 4	x	35-H	S	1000	7,40 gal Zn
M 4	x	35-H	K	200	10,50 gal Zn
M 4	x	40-H	S	1000	8,60 gal Zn
M 4	x	40-H	K	200	11,50 gal Zn
M 4	x	45-H	S	1000	10,60 gal Zn
M 4	x	45-H	K	200	13,40 gal Zn
M 4	x	50-H	S	1000	12,60 gal Zn
M 4	x	50-H	K	200	15,70 gal Zn
M 4	x	60-H	S	500	18,00 gal Zn
M 4	x	60-H	K	200	21,00 gal Zn
M 4	x	70-H	S	500	24,10 gal Zn
M 4	x	80-H	S	500	31,00 gal Zn
M 4	x	90-H	S	200	83,00 gal Zn
M 5	x	6-H	S	2000	8,20 gal Zn
M 5	x	6-H	K	200	11,50 gal Zn
M 5	x	8-H	S	2000	8,20 gal Zn
M 5	x	8-H	K	200	11,10 gal Zn
M 5	x	10-H	S	2000	4,25 gal Zn
M 5	x	10-H	K	200	7,20 gal Zn
M 5	x	12-H	K	200	7,30 gal Zn
M 5	x	14-H	S	1000	7,90 gal Zn
M 5	x	14-H	K	200	10,90 gal Zn
M 5	x	16-H	K	200	7,90 gal Zn
M 5	x	20-H	K	200	8,50 gal Zn
M 5	x	25-H	S	1000	6,20 gal Zn
M 5	x	25-H	K	200	9,10 gal Zn
M 5	x	30-H	S	1000	7,80 gal Zn
M 5	x	30-H	K	200	10,80 gal Zn
M 5	x	35-H	S	500	8,60 gal Zn
M 5	x	35-H	K	200	11,70 gal Zn
M 5	x	40-H	S	500	9,40 gal Zn
M 5	x	40-H	K	200	12,30 gal Zn
M 5	x	45-H	S	500	10,90 gal Zn
M 5	x	45-H	K	200	13,80 gal Zn
M 5	x	50-H	S	500	15,20 gal Zn
M 5	x	50-H	K	200	18,10 gal Zn
M 5	x	55-H	S	200	35,50 gal Zn
M 5	x	60-H	S	200	19,30 gal Zn
M 5	x	70-H	S	200	23,40 gal Zn
M 5	x	80-H	S	200	36,00 gal Zn
M 5	x	90-H	S	100	51,00 gal Zn
M 6	x	8-H	S	1000	9,10 gal Zn
M 6	x	8-H	K	200	12,00 gal Zn
M 6	x	10-H	K	200	13,70 gal Zn
M 6	x	12-H	K	200	9,20 gal Zn
M 6	x	14-H	S	1000	8,60 gal Zn
M 6	x	16-H	S	1000	7,20 gal Zn
M 6	x	16-H	K	200	10,20 gal Zn
M 6	x	18-H	S	1000	14,60 gal Zn
M 6	x	18-H	K	200	18,20 gal Zn
M 6	x	20-H	S	1000	7,90 gal Zn
M 6	x	20-H	K	200	10,80 gal Zn
M 6	x	25-H	S	500	8,90 gal Zn

Abmessungen	VE	Stück	€/100/Obf.
M 6 x 25 -H	K	200	11,80 gal Zn
M 6 x 30 -H	S	500	10,20 gal Zn
M 6 x 30 -H	K	200	13,10 gal Zn
M 6 x 35 -H	S	500	11,80 gal Zn
M 6 x 35 -H	K	200	14,70 gal Zn
M 6 x 40 -H	S	500	13,20 gal Zn
M 6 x 40 -H	K	200	16,10 gal Zn
M 6 x 45 -H	S	200	15,50 gal Zn
M 6 x 50 -H	S	200	17,60 gal Zn
M 6 x 55 -H	S	200	26,00 gal Zn
M 6 x 60 -H	S	200	21,10 gal Zn
M 6 x 70 -H	S	200	26,50 gal Zn
M 6 x 80 -H	S	200	39,50 gal Zn
M 8 x 12 -H	S	500	44,50 gal Zn
M 8 x 16 -H	S	500	16,60 gal Zn
M 8 x 16 -H	K	200	19,50 gal Zn
M 8 x 20 -H	S	500	17,10 gal Zn
M 8 x 20 -H	K	200	20,10 gal Zn
M 8 x 25 -H	S	200	19,00 gal Zn
M 8 x 30 -H	S	200	21,60 gal Zn
M 8 x 35 -H	S	200	26,00 gal Zn
M 8 x 40 -H	S	100	30,50 gal Zn
M 8 x 45 -H	S	100	33,00 gal Zn
M 8 x 50 -H	S	100	34,00 gal Zn
M 8 x 55 -H	S	100	44,00 gal Zn
M 8 x 60 -H	S	100	39,00 gal Zn
M 8 x 70 -H	S	100	47,00 gal Zn
M 8 x 80 -H	S	100	57,00 gal Zn
M 8 x 90 -H	S	100	68,00 gal Zn
M 8 x 100 -H	S	100	78,00 gal Zn
M 10 x 16 -H	S	100	66,00 gal Zn
M 10 x 20 -H	S	100	38,50 gal Zn
M 10 x 25 -H	S	100	40,00 gal Zn
M 10 x 30 -H	S	100	44,00 gal Zn
M 10 x 40 -H	S	100	50,00 gal Zn
M 10 x 45 -H	S	100	54,00 gal Zn
M 10 x 50 -H	S	100	57,00 gal Zn
M 10 x 60 -H	S	100	72,00 gal Zn

ISO	07046.415
7046-1	4.8 galvanisch verzinkt
	Z



Senkschrauben mit Pozidriv-Kreuzschlitz Z

Maße → **TI-39** Normumstellung → **TI-11**
 Werkstoffeigensch. → **TI-232** REACH → **TI-262**
 Korrosionsschutz → **TI-228**

Rostfrei → **S. 564**

ISO 7046 → ersetzt DIN 965 (austauschbar)



M 2,5 x 4 -Z	S	2000	11,10 gal Zn
M 2,5 x 5 -Z	S	2000	6,70 gal Zn
M 2,5 x 6 -Z	S	2000	5,00 gal Zn
M 2,5 x 8 -Z	S	2000	4,60 gal Zn
M 2,5 x 10 -Z	S	2000	5,20 gal Zn
M 2,5 x 12 -Z	S	2000	5,30 gal Zn
M 3 x 4 -Z	S	2000	5,70 gal Zn
M 3 x 5 -Z	S	2000	6,20 gal Zn
M 3 x 6 -Z	S	2000	4,15 gal Zn
M 3 x 8 -Z	S	2000	2,20 gal Zn
M 3 x 10 -Z	S	2000	2,30 gal Zn
M 3 x 12 -Z	S	2000	2,40 gal Zn
M 3 x 16 -Z	S	2000	3,00 gal Zn

Abmessungen	VE	Stück	€/100/Obf.
M 3 x 20 -Z	S	2000	3,15 gal Zn
M 3 x 25 -Z	S	2000	4,40 gal Zn
M 4 x 6 -Z	S	2000	5,70 gal Zn
M 4 x 8 -Z	S	2000	3,10 gal Zn
M 4 x 10 -Z	S	2000	3,25 gal Zn
M 4 x 12 -Z	S	2000	3,35 gal Zn
M 4 x 16 -Z	S	2000	3,70 gal Zn
M 4 x 20 -Z	S	2000	3,95 gal Zn
M 4 x 25 -Z	S	1000	4,55 gal Zn
M 4 x 30 -Z	S	1000	5,90 gal Zn
M 4 x 35 -Z	S	1000	7,40 gal Zn
M 4 x 40 -Z	S	1000	8,60 gal Zn
M 4 x 45 -Z	S	500	10,60 gal Zn
M 4 x 50 -Z	S	500	12,60 gal Zn
M 5 x 8 -Z	S	2000	8,20 gal Zn
M 5 x 10 -Z	S	2000	4,25 gal Zn
M 5 x 12 -Z	S	1000	4,40 gal Zn
M 5 x 16 -Z	S	1000	4,85 gal Zn
M 5 x 20 -Z	S	1000	5,50 gal Zn
M 5 x 25 -Z	S	1000	6,20 gal Zn
M 5 x 30 -Z	S	1000	7,80 gal Zn
M 5 x 35 -Z	S	500	8,60 gal Zn
M 5 x 40 -Z	S	500	9,40 gal Zn
M 5 x 45 -Z	S	500	10,90 gal Zn
M 5 x 50 -Z	S	500	15,20 gal Zn
M 5 x 60 -Z	S	200	19,30 gal Zn
M 5 x 70 -Z	S	200	23,40 gal Zn
M 5 x 80 -Z	S	200	36,00 gal Zn
M 6 x 10 -Z	S	1000	10,80 gal Zn
M 6 x 12 -Z	S	1000	6,30 gal Zn
M 6 x 16 -Z	S	1000	7,20 gal Zn
M 6 x 20 -Z	S	1000	7,90 gal Zn
M 6 x 25 -Z	S	500	8,90 gal Zn
M 6 x 30 -Z	S	500	9,00 gal Zn
M 6 x 35 -Z	S	500	11,80 gal Zn
M 6 x 40 -Z	S	500	13,20 gal Zn
M 6 x 45 -Z	S	200	15,50 gal Zn
M 6 x 50 -Z	S	200	17,60 gal Zn
M 6 x 60 -Z	S	200	21,10 gal Zn

ISO	07047.414
7047	4.8 galvanisch verzinkt
	H

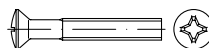

Linsensenkschrauben mit Phillips-Kreuzschlitz H

Maße → **TI-39** Normumstellung → **TI-11**
 Werkstoffeigensch. → **TI-232** REACH → **TI-262**
 Korrosionsschutz → **TI-228**

Rostfrei → **S. 565**

ISO 7047 → ersetzt DIN 966 (austauschbar)



M 2,5 x 5 -H	S	2000	8,40 gal Zn
M 2,5 x 6 -H	S	2000	6,00 gal Zn
M 2,5 x 6 -H	K	200	8,90 gal Zn
M 2,5 x 8 -H	S	2000	6,20 gal Zn
M 2,5 x 8 -H	K	200	9,10 gal Zn
M 2,5 x 10 -H	S	2000	6,20 gal Zn
M 2,5 x 10 -H	K	200	9,10 gal Zn
M 3 x 5 -H	S	2000	6,00 gal Zn
M 3 x 5 -H	K	200	8,90 gal Zn
M 3 x 6 -H	S	2000	4,55 gal Zn
M 3 x 6 -H	K	200	7,60 gal Zn
M 3 x 8 -H	S	2000	2,40 gal Zn

Abmessungen	VE	Stück	€/100/Obf.
M 3 x 8 -H	K	200	5,30 gal Zn
M 3 x 10 -H	S	2000	2,45 gal Zn
M 3 x 10 -H	K	200	5,40 gal Zn
M 3 x 12 -H	S	2000	3,00 gal Zn
M 3 x 12 -H	K	200	5,90 gal Zn
M 3 x 16 -H	S	2000	3,70 gal Zn
M 3 x 16 -H	K	200	6,60 gal Zn
M 3 x 20 -H	S	2000	3,90 gal Zn
M 3 x 20 -H	K	200	6,80 gal Zn
M 3 x 25 -H	S	2000	5,00 gal Zn
M 3 x 25 -H	K	200	8,90 gal Zn
M 3 x 30 -H	S	2000	6,30 gal Zn
M 3 x 30 -H	K	200	9,20 gal Zn
M 3 x 35 -H	S	2000	9,20 gal Zn
M 3 x 40 -H	S	1000	10,50 gal Zn
M 4 x 6 -H	S	2000	6,70 gal Zn
M 4 x 6 -H	K	200	9,60 gal Zn
M 4 x 8 -H	S	2000	3,30 gal Zn
M 4 x 8 -H	K	200	6,20 gal Zn
M 4 x 10 -H	S	2000	3,40 gal Zn
M 4 x 10 -H	K	200	6,30 gal Zn
M 4 x 12 -H	S	2000	3,60 gal Zn
M 4 x 12 -H	K	200	6,50 gal Zn
M 4 x 16 -H	S	2000	3,95 gal Zn
M 4 x 16 -H	K	200	6,90 gal Zn
M 4 x 20 -H	S	2000	4,25 gal Zn
M 4 x 20 -H	K	200	7,20 gal Zn
M 4 x 25 -H	S	1000	4,85 gal Zn
M 4 x 25 -H	K	200	7,80 gal Zn
M 4 x 30 -H	S	1000	6,80 gal Zn
M 4 x 30 -H	K	200	9,70 gal Zn
M 4 x 35 -H	S	1000	8,60 gal Zn
M 4 x 35 -H	K	200	11,50 gal Zn
M 4 x 40 -H	S	1000	9,90 gal Zn
M 4 x 40 -H	K	200	12,80 gal Zn
M 4 x 45 -H	S	1000	11,40 gal Zn
M 4 x 45 -H	K	200	14,30 gal Zn
M 4 x 50 -H	S	1000	15,80 gal Zn
M 4 x 50 -H	K	200	18,70 gal Zn
M 4 x 60 -H	S	500	22,70 gal Zn
M 5 x 8 -H	S	2000	9,40 gal Zn
M 5 x 8 -H	K	200	12,30 gal Zn
M 5 x 10 -H	S	2000	4,60 gal Zn
M 5 x 10 -H	K	200	7,60 gal Zn
M 5 x 12 -H	S	1000	4,70 gal Zn
M 5 x 12 -H	K	200	7,60 gal Zn
M 5 x 16 -H	S	1000	5,30 gal Zn
M 5 x 16 -H	K	200	8,20 gal Zn
M 5 x 20 -H	S	1000	6,70 gal Zn
M 5 x 20 -H	K	200	9,60 gal Zn
M 5 x 25 -H	S	1000	6,70 gal Zn
M 5 x 25 -H	K	200	9,60 gal Zn
M 5 x 30 -H	S	1000	8,50 gal Zn
M 5 x 30 -H	K	200	11,40 gal Zn
M 5 x 35 -H	S	500	9,40 gal Zn
M 5 x 40 -H	S	500	10,10 gal Zn
M 5 x 45 -H	S	500	12,60 gal Zn
M 5 x 50 -H	S	500	16,50 gal Zn
M 5 x 60 -H	S	200	22,40 gal Zn
M 5 x 70 -H	S	200	33,00 gal Zn
M 5 x 80 -H	S	200	42,00 gal Zn
M 6 x 10 -H	S	1000	11,50 gal Zn
M 6 x 10 -H	K	200	14,40 gal Zn
M 6 x 12 -H	S	1000	6,90 gal Zn
M 6 x 12 -H	K	200	9,90 gal Zn
M 6 x 16 -H	S	1000	7,80 gal Zn
M 6 x 16 -H	K	200	10,70 gal Zn
M 6 x 20 -H	S	1000	8,60 gal Zn
M 6 x 20 -H	K	200	11,50 gal Zn
M 6 x 25 -H	S	500	9,70 gal Zn
M 6 x 30 -H	S	500	11,10 gal Zn
M 6 x 35 -H	S	500	12,80 gal Zn
M 6 x 40 -H	S	500	14,30 gal Zn
M 6 x 45 -H	S	500	17,80 gal Zn
M 6 x 50 -H	S	200	18,90 gal Zn

Abmessungen	VE	Stück	€/100/Obf.
M 6 x 60 -H	S	200	23,80 gal Zn
M 6 x 70 -H	S	200	33,00 gal Zn
M 6 x 80 -H	S	200	47,00 gal Zn
M 8 x 16 -H	S	500	31,50 gal Zn
M 8 x 20 -H	S	500	19,40 gal Zn
M 8 x 25 -H	S	200	23,40 gal Zn
M 8 x 30 -H	S	200	26,50 gal Zn
M 8 x 35 -H	S	200	30,00 gal Zn
M 8 x 40 -H	S	100	38,00 gal Zn
M 8 x 45 -H	S	100	40,00 gal Zn
M 8 x 50 -H	S	100	41,50 gal Zn
M 8 x 60 -H	S	100	48,50 gal Zn
M 8 x 70 -H	S	100	60,00 gal Zn
M 8 x 80 -H	S	100	72,00 gal Zn

Abmessungen	VE	Stück	€/100/Obf.
C3,5 x 25 -H	S	500	5,50 gal Zn
C3,5 x 25 -H	K	100	8,60 gal Zn
C3,5 x 32 -H	S	500	6,00 gal Zn
C3,5 x 32 -H	K	100	9,00 gal Zn
C3,5 x 38 -H	S	500	6,70 gal Zn
C3,5 x 38 -H	K	100	9,60 gal Zn
C3,5 x 45 -H	S	500	10,90 gal Zn
C3,5 x 50 -H	S	500	13,20 gal Zn
C3,9 x 6,5 -H	S	2000	6,50 gal Zn
C3,9 x 9,5 -H	S	1000	3,25 gal Zn
C3,9 x 9,5 -H	K	100	6,20 gal Zn
C3,9 x 13 -H	S	1000	3,30 gal Zn
C3,9 x 13 -H	K	100	6,30 gal Zn
C3,9 x 16 -H	S	1000	3,60 gal Zn
C3,9 x 16 -H	K	100	6,70 gal Zn
C3,9 x 19 -H	S	1000	4,10 gal Zn
C3,9 x 19 -H	K	100	7,10 gal Zn
C3,9 x 22 -H	S	500	5,40 gal Zn
C3,9 x 22 -H	K	100	8,40 gal Zn
C3,9 x 25 -H	S	500	6,00 gal Zn
C3,9 x 25 -H	K	100	9,00 gal Zn
C3,9 x 32 -H	S	500	6,20 gal Zn
C3,9 x 32 -H	K	100	9,10 gal Zn
C3,9 x 38 -H	S	500	8,80 gal Zn
C3,9 x 38 -H	K	100	11,70 gal Zn
C3,9 x 45 -H	S	1000	9,00 gal Zn
C4,2 x 9,5 -H	S	1000	3,40 gal Zn
C4,2 x 9,5 -H	K	100	6,50 gal Zn
C4,2 x 13 -H	S	1000	3,45 gal Zn
C4,2 x 13 -H	K	100	6,50 gal Zn
C4,2 x 16 -H	S	1000	3,90 gal Zn
C4,2 x 16 -H	K	100	6,90 gal Zn
C4,2 x 19 -H	S	500	4,15 gal Zn
C4,2 x 19 -H	K	100	7,20 gal Zn
C4,2 x 22 -H	S	500	5,70 gal Zn
C4,2 x 22 -H	K	100	8,80 gal Zn
C4,2 x 25 -H	S	500	6,30 gal Zn
C4,2 x 25 -H	K	100	9,40 gal Zn
C4,2 x 32 -H	S	500	6,30 gal Zn
C4,2 x 32 -H	K	100	9,40 gal Zn
C4,2 x 38 -H	S	500	9,10 gal Zn
C4,2 x 38 -H	K	100	12,10 gal Zn
C4,2 x 45 -H	S	500	10,60 gal Zn
C4,2 x 45 -H	K	100	13,50 gal Zn
C4,2 x 50 -H	S	500	11,90 gal Zn
C4,2 x 50 -H	K	100	14,90 gal Zn
C4,2 x 60 -H	S	250	20,30 gal Zn
C4,2 x 70 -H	S	250	24,00 gal Zn
C4,2 x 80 -H	S	250	26,50 gal Zn
C4,8 x 9,5 -H	S	500	4,80 gal Zn
C4,8 x 9,5 -H	K	100	7,80 gal Zn
C4,8 x 13 -H	S	500	4,85 gal Zn
C4,8 x 13 -H	K	100	7,90 gal Zn
C4,8 x 16 -H	S	500	5,10 gal Zn
C4,8 x 16 -H	K	100	8,20 gal Zn
C4,8 x 19 -H	S	500	5,80 gal Zn
C4,8 x 19 -H	K	100	8,80 gal Zn
C4,8 x 22 -H	S	500	6,20 gal Zn
C4,8 x 22 -H	K	100	9,20 gal Zn
C4,8 x 25 -H	S	500	7,30 gal Zn
C4,8 x 25 -H	K	100	10,30 gal Zn
C4,8 x 32 -H	S	250	8,40 gal Zn
C4,8 x 32 -H	K	100	11,40 gal Zn
C4,8 x 38 -H	S	250	9,70 gal Zn
C4,8 x 38 -H	K	100	12,60 gal Zn
C4,8 x 45 -H	S	250	13,10 gal Zn
C4,8 x 45 -H	K	100	16,10 gal Zn
C4,8 x 50 -H	S	250	14,60 gal Zn
C4,8 x 50 -H	K	100	17,60 gal Zn
C4,8 x 60 -H	S	250	23,30 gal Zn
C4,8 x 70 -H	S	250	31,00 gal Zn
C4,8 x 80 -H	S	250	37,00 gal Zn
C4,8 x 90 -H	S	250	45,00 gal Zn
C4,8 x 100 -H	S	250	54,00 gal Zn
C4,8 x 110 -H	S	250	62,00 gal Zn

Abmessungen	VE	Stück	€/100/Obf.
C4,8 x 120 -H	S	250	76,00 gal Zn
C5,5 x 13 -H	S	500	6,50 gal Zn
C5,5 x 13 -H	K	100	9,60 gal Zn
C5,5 x 16 -H	S	500	7,20 gal Zn
C5,5 x 16 -H	K	100	10,20 gal Zn
C5,5 x 19 -H	S	500	7,60 gal Zn
C5,5 x 19 -H	K	100	10,60 gal Zn
C5,5 x 22 -H	S	500	10,60 gal Zn
C5,5 x 22 -H	K	100	13,50 gal Zn
C5,5 x 25 -H	S	250	11,20 gal Zn
C5,5 x 25 -H	K	100	14,20 gal Zn
C5,5 x 32 -H	S	250	12,90 gal Zn
C5,5 x 32 -H	K	100	15,90 gal Zn
C5,5 x 38 -H	S	250	16,00 gal Zn
C5,5 x 38 -H	K	100	18,90 gal Zn
C5,5 x 45 -H	S	250	18,00 gal Zn
C5,5 x 45 -H	K	100	21,00 gal Zn
C5,5 x 50 -H	S	250	21,10 gal Zn
C5,5 x 50 -H	K	100	24,00 gal Zn
C5,5 x 60 -H	S	250	40,00 gal Zn
C5,5 x 70 -H	S	250	49,50 gal Zn
C5,5 x 80 -H	S	250	59,00 gal Zn
C6,3 x 13 -H	S	250	9,50 gal Zn
C6,3 x 13 -H	K	100	12,40 gal Zn
C6,3 x 16 -H	S	250	9,70 gal Zn
C6,3 x 16 -H	K	100	12,60 gal Zn
C6,3 x 19 -H	S	250	9,90 gal Zn
C6,3 x 19 -H	K	100	12,90 gal Zn
C6,3 x 22 -H	S	250	11,80 gal Zn
C6,3 x 22 -H	K	100	14,80 gal Zn
C6,3 x 25 -H	S	250	14,30 gal Zn
C6,3 x 25 -H	K	100	17,40 gal Zn
C6,3 x 32 -H	S	250	15,70 gal Zn
C6,3 x 32 -H	K	100	18,70 gal Zn
C6,3 x 38 -H	S	250	19,50 gal Zn
C6,3 x 38 -H	K	100	22,60 gal Zn
C6,3 x 45 -H	S	250	24,00 gal Zn
C6,3 x 45 -H	K	100	27,00 gal Zn
C6,3 x 50 -H	S	250	26,00 gal Zn
C6,3 x 50 -H	K	100	28,50 gal Zn
C6,3 x 60 -H	S	250	45,50 gal Zn
C6,3 x 70 -H	S	250	65,00 gal Zn
C6,3 x 80 -H	S	250	83,00 gal Zn
C6,3 x 90 -H	S	250	101,00 gal Zn
C6,3 x 100 -H	S	250	119,00 gal Zn

ISO 07049.019

7049 Stahl gehärtet Form C-H galvanisch verzinkt

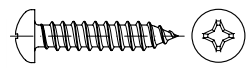

Linsenkopf-Blechschraben mit Phillips-Kreuzschlitz H, C = mit Spitze

Nennlänge ab 60 mm mit Teilgewinde

Maße → TI-46 Montage → TI-251
 Korrosionsschutz → TI-228 Normumstellung → TI-11

Rostfrei → S. 566

ISO 7049 → ersetzt DIN 7981 (austauschbar)

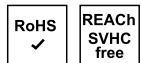

C2,2 x 4,5 -H	S	2000	6,30 gal Zn
C2,2 x 6,5 -H	S	2000	4,55 gal Zn
C2,2 x 6,5 -H	K	100	7,00 gal Zn
C2,2 x 9,5 -H	S	2000	4,25 gal Zn
C2,2 x 13 -H	S	2000	4,55 gal Zn
C2,2 x 16 -H	S	2000	5,50 gal Zn
C2,2 x 19 -H	S	2000	7,20 gal Zn
C2,2 x 22 -H	S	2000	8,90 gal Zn
C2,9 x 6,5 -H	K	100	5,60 gal Zn
C2,9 x 6,5 -H	S	2000	2,60 gal Zn
C2,9 x 9,5 -H	S	2000	2,30 gal Zn
C2,9 x 9,5 -H	K	100	5,40 gal Zn
C2,9 x 13 -H	S	2000	2,45 gal Zn
C2,9 x 13 -H	K	100	5,50 gal Zn
C2,9 x 16 -H	S	2000	2,60 gal Zn
C2,9 x 16 -H	K	100	5,60 gal Zn
C2,9 x 19 -H	S	2000	3,70 gal Zn
C2,9 x 19 -H	K	100	6,70 gal Zn
C2,9 x 22 -H	S	2000	4,60 gal Zn
C2,9 x 22 -H	K	100	7,70 gal Zn
C2,9 x 25 -H	S	1000	4,95 gal Zn
C2,9 x 25 -H	K	100	7,90 gal Zn
C2,9 x 32 -H	S	1000	5,90 gal Zn
C3,5 x 6,5 -H	S	1000	3,60 gal Zn
C3,5 x 6,5 -H	K	100	6,60 gal Zn
C3,5 x 9,5 -H	S	1000	2,75 gal Zn
C3,5 x 9,5 -H	K	100	5,70 gal Zn
C3,5 x 13 -H	S	1000	2,85 gal Zn
C3,5 x 13 -H	K	100	5,90 gal Zn
C3,5 x 16 -H	S	1000	3,00 gal Zn
C3,5 x 16 -H	K	100	6,00 gal Zn
C3,5 x 19 -H	S	1000	3,75 gal Zn
C3,5 x 19 -H	K	100	6,80 gal Zn
C3,5 x 22 -H	S	1000	5,30 gal Zn
C3,5 x 22 -H	K	100	8,30 gal Zn

ISO 07049.014

7049 Stahl gehärtet Form F galvanisch verzinkt

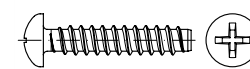

Linsenkopf-Blechschraben mit Phillips-Kreuzschlitz H, F = mit Zapfen

Maße → TI-46 Montage → TI-251
 Korrosionsschutz → TI-228 Normumstellung → TI-11

Rostfrei → S. 566

ISO 7049 → ersetzt DIN 7981 (austauschbar)

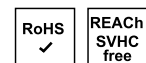

F 2,2 x 4,5 -H	S	2000	7,30 gal Zn
F 2,2 x 6,5 -H	S	2000	7,30 gal Zn
F 2,2 x 9,5 -H	S	2000	7,30 gal Zn
F 2,2 x 13 -H	S	2000	10,30 gal Zn
F 2,2 x 16 -H	S	2000	12,60 gal Zn

Abmessungen	VE	Stück	€/100/Obf.
F 2,9 x 4,5 -H	S	2000	7,30 gal Zn
F 2,9 x 6,5 -H	S	2000	2,80 gal Zn
F 2,9 x 6,5 -H	K	100	5,60 gal Zn
F 2,9 x 9,5 -H	S	2000	2,60 gal Zn
F 2,9 x 9,5 -H	K	100	5,40 gal Zn
F 2,9 x 13 -H	S	2000	2,75 gal Zn
F 2,9 x 13 -H	K	100	5,50 gal Zn
F 2,9 x 16 -H	S	2000	2,90 gal Zn
F 2,9 x 16 -H	K	100	5,60 gal Zn
F 2,9 x 19 -H	S	2000	4,25 gal Zn
F 2,9 x 22 -H	S	2000	5,90 gal Zn
F 3,5 x 6,5 -H	S	1000	2,90 gal Zn
F 3,5 x 9,5 -H	S	2000	3,00 gal Zn
F 3,5 x 9,5 -H	K	100	5,70 gal Zn
F 3,5 x 13 -H	S	1000	3,10 gal Zn
F 3,5 x 13 -H	K	100	5,90 gal Zn
F 3,5 x 16 -H	S	1000	3,15 gal Zn
F 3,5 x 16 -H	K	100	6,00 gal Zn
F 3,5 x 19 -H	S	1000	3,40 gal Zn
F 3,5 x 22 -H	S	1000	4,25 gal Zn
F 3,5 x 25 -H	S	1000	6,00 gal Zn
F 3,9 x 6,5 -H	S	1000	4,25 gal Zn
F 3,9 x 9,5 -H	S	1000	3,60 gal Zn
F 3,9 x 9,5 -H	K	100	6,20 gal Zn
F 3,9 x 13 -H	S	1000	3,65 gal Zn
F 3,9 x 13 -H	K	100	6,30 gal Zn
F 3,9 x 16 -H	S	1000	3,95 gal Zn
F 3,9 x 16 -H	K	100	6,70 gal Zn
F 3,9 x 19 -H	S	1000	4,85 gal Zn
F 3,9 x 22 -H	S	1000	5,70 gal Zn
F 3,9 x 25 -H	S	1000	6,30 gal Zn
F 4,2 x 6,5 -H	S	1000	4,95 gal Zn
F 4,2 x 9,5 -H	S	1000	4,55 gal Zn
F 4,2 x 13 -H	S	1000	3,90 gal Zn
F 4,2 x 13 -H	K	100	6,50 gal Zn
F 4,2 x 16 -H	S	1000	3,75 gal Zn
F 4,2 x 19 -H	S	1000	6,10 gal Zn
F 4,2 x 22 -H	S	1000	6,10 gal Zn
F 4,2 x 25 -H	S	1000	7,30 gal Zn
F 4,2 x 32 -H	S	1000	7,30 gal Zn
F 4,8 x 6,5 -H	S	1000	6,10 gal Zn
F 4,8 x 9,5 -H	S	500	4,80 gal Zn
F 4,8 x 9,5 -H	K	100	7,80 gal Zn
F 4,8 x 13 -H	S	500	5,20 gal Zn
F 4,8 x 13 -H	K	100	7,90 gal Zn
F 4,8 x 16 -H	S	500	5,40 gal Zn
F 4,8 x 16 -H	K	100	8,20 gal Zn
F 4,8 x 19 -H	S	500	9,60 gal Zn
F 4,8 x 22 -H	S	500	11,10 gal Zn
F 4,8 x 25 -H	S	500	11,50 gal Zn
F 4,8 x 32 -H	S	500	14,90 gal Zn
F 4,8 x 38 -H	S	500	18,20 gal Zn
F 5,5 x 13 -H	S	500	6,00 gal Zn
F 5,5 x 16 -H	S	500	6,70 gal Zn
F 5,5 x 19 -H	S	500	10,30 gal Zn
F 5,5 x 22 -H	S	500	12,10 gal Zn
F 5,5 x 25 -H	S	250	15,20 gal Zn
F 5,5 x 32 -H	S	250	18,20 gal Zn
F 5,5 x 38 -H	S	250	23,00 gal Zn
F 6,3 x 13 -H	S	250	9,10 gal Zn
F 6,3 x 16 -H	S	250	13,40 gal Zn

Abmessungen	VE	Stück	€/100/Obf.
ISO		07049.303	
7049		Stahl gehärtet Form C-Z	
		galvanisch verzinkt	



Linsenkopf-Blehschrauben, mit Pozidriv-Kreuzschlitz Z, C = mit Spitze

Maße → **TI-46** Montage → **TI-251**
 Korrosionsschutz → **TI-228** Normumstellung → **TI-6**
 ISO 7049 → ersetzt DIN 7981 (austauschbar)



2,2 x 4,5 -C-Z	S	2000	6,30 gal Zn
2,2 x 6,5 -C-Z	S	2000	4,55 gal Zn
2,2 x 6,5 -C-Z	K	100	7,00 gal Zn
2,2 x 9,5 -C-Z	S	2000	4,25 gal Zn
2,2 x 13 -C-Z	S	2000	4,55 gal Zn
2,2 x 16 -C-Z	S	2000	5,50 gal Zn
2,2 x 19 -C-Z	S	2000	7,20 gal Zn
2,2 x 22 -C-Z	S	2000	8,90 gal Zn
2,9 x 6,5 -C-Z	S	2000	2,60 gal Zn
2,9 x 6,5 -C-Z	K	100	5,60 gal Zn
2,9 x 9,5 -C-Z	S	2000	2,30 gal Zn
2,9 x 9,5 -C-Z	K	100	5,40 gal Zn
2,9 x 13 -C-Z	S	2000	2,45 gal Zn
2,9 x 13 -C-Z	K	100	5,50 gal Zn
2,9 x 16 -C-Z	S	2000	2,60 gal Zn
2,9 x 16 -C-Z	K	100	5,60 gal Zn
2,9 x 19 -C-Z	S	2000	3,70 gal Zn
2,9 x 19 -C-Z	K	100	6,70 gal Zn
2,9 x 22 -C-Z	S	1000	4,60 gal Zn
2,9 x 22 -C-Z	K	100	7,70 gal Zn
2,9 x 25 -C-Z	S	1000	4,95 gal Zn
2,9 x 25 -C-Z	K	100	7,90 gal Zn
2,9 x 32 -C-Z	S	1000	5,90 gal Zn
3,5 x 6,5 -C-Z	S	1000	3,60 gal Zn
3,5 x 6,5 -C-Z	K	100	6,60 gal Zn
3,5 x 9,5 -C-Z	S	1000	2,75 gal Zn
3,5 x 9,5 -C-Z	K	100	5,70 gal Zn
3,5 x 13 -C-Z	S	1000	2,85 gal Zn
3,5 x 13 -C-Z	K	100	5,90 gal Zn
3,5 x 16 -C-Z	S	1000	3,00 gal Zn
3,5 x 16 -C-Z	K	100	6,00 gal Zn
3,5 x 19 -C-Z	S	1000	3,75 gal Zn
3,5 x 19 -C-Z	K	100	6,80 gal Zn
3,5 x 22 -C-Z	S	1000	5,30 gal Zn
3,5 x 22 -C-Z	K	100	8,30 gal Zn
3,5 x 25 -C-Z	S	500	5,50 gal Zn
3,5 x 25 -C-Z	K	100	8,60 gal Zn
3,5 x 32 -C-Z	S	500	6,20 gal Zn
3,5 x 32 -C-Z	K	100	9,00 gal Zn
3,5 x 38 -C-Z	S	500	6,70 gal Zn
3,5 x 38 -C-Z	K	100	9,60 gal Zn
3,5 x 45 -C-Z	S	500	10,90 gal Zn
3,5 x 50 -C-Z	S	500	13,20 gal Zn
3,9 x 6,5 -C-Z	S	2000	6,50 gal Zn
3,9 x 9,5 -C-Z	S	1000	3,25 gal Zn
3,9 x 9,5 -C-Z	K	100	6,20 gal Zn
3,9 x 13 -C-Z	S	1000	3,30 gal Zn
3,9 x 13 -C-Z	K	100	6,30 gal Zn
3,9 x 16 -C-Z	S	1000	3,60 gal Zn
3,9 x 16 -C-Z	K	100	6,70 gal Zn
3,9 x 19 -C-Z	S	1000	4,10 gal Zn
3,9 x 19 -C-Z	K	100	7,10 gal Zn
3,9 x 22 -C-Z	S	500	5,40 gal Zn

3,9 x 22 -C-Z	K	100	8,40 gal Zn
3,9 x 25 -C-Z	S	500	6,00 gal Zn
3,9 x 25 -C-Z	K	100	9,00 gal Zn
3,9 x 32 -C-Z	S	500	6,40 gal Zn
3,9 x 32 -C-Z	K	100	9,10 gal Zn
3,9 x 38 -C-Z	S	500	8,80 gal Zn
3,9 x 38 -C-Z	K	100	11,70 gal Zn
3,9 x 45 -C-Z	S	500	9,00 gal Zn
4,2 x 9,5 -C-Z	S	1000	3,40 gal Zn
4,2 x 9,5 -C-Z	K	100	6,50 gal Zn
4,2 x 13 -C-Z	S	1000	3,45 gal Zn
4,2 x 13 -C-Z	K	100	6,50 gal Zn
4,2 x 16 -C-Z	S	1000	3,90 gal Zn
4,2 x 16 -C-Z	K	100	6,90 gal Zn
4,2 x 19 -C-Z	S	500	4,15 gal Zn
4,2 x 19 -C-Z	K	100	7,20 gal Zn
4,2 x 22 -C-Z	S	500	5,70 gal Zn
4,2 x 22 -C-Z	K	100	8,80 gal Zn
4,2 x 25 -C-Z	S	500	6,30 gal Zn
4,2 x 25 -C-Z	K	100	9,40 gal Zn
4,2 x 32 -C-Z	S	500	6,30 gal Zn
4,2 x 32 -C-Z	K	100	9,40 gal Zn
4,2 x 38 -C-Z	S	500	9,10 gal Zn
4,2 x 38 -C-Z	K	100	12,10 gal Zn
4,2 x 45 -C-Z	S	500	10,60 gal Zn
4,2 x 45 -C-Z	K	100	13,50 gal Zn
4,2 x 50 -C-Z	S	500	11,90 gal Zn
4,2 x 50 -C-Z	K	100	14,90 gal Zn
4,2 x 60 -C-Z	S	250	20,30 gal Zn
4,2 x 70 -C-Z	S	250	24,00 gal Zn
4,2 x 80 -C-Z	S	250	26,50 gal Zn
4,8 x 9,5 -C-Z	S	500	4,80 gal Zn
4,8 x 9,5 -C-Z	K	100	7,80 gal Zn
4,8 x 13 -C-Z	S	500	4,85 gal Zn
4,8 x 13 -C-Z	K	100	7,90 gal Zn
4,8 x 16 -C-Z	S	500	5,10 gal Zn
4,8 x 16 -C-Z	K	100	8,20 gal Zn
4,8 x 19 -C-Z	S	500	5,80 gal Zn
4,8 x 19 -C-Z	K	100	8,80 gal Zn
4,8 x 22 -C-Z	S	500	6,20 gal Zn
4,8 x 22 -C-Z	K	100	9,20 gal Zn
4,8 x 25 -C-Z	S	500	7,30 gal Zn
4,8 x 25 -C-Z	K	100	10,30 gal Zn
4,8 x 32 -C-Z	S	250	8,40 gal Zn
4,8 x 32 -C-Z	K	100	11,40 gal Zn
4,8 x 38 -C-Z	S	250	9,70 gal Zn
4,8 x 38 -C-Z	K	100	12,60 gal Zn
4,8 x 45 -C-Z	S	250	13,10 gal Zn
4,8 x 45 -C-Z	K	100	16,10 gal Zn
4,8 x 50 -C-Z	S	250	14,60 gal Zn
4,8 x 50 -C-Z	K	100	17,60 gal Zn
4,8 x 60 -C-Z	S	250	23,30 gal Zn
4,8 x 70 -C-Z	S	250	31,00 gal Zn
4,8 x 80 -C-Z	S	250	37,00 gal Zn
4,8 x 90 -C-Z	S	250	45,00 gal Zn
4,8 x 100 -C-Z	S	250	54,00 gal Zn
4,8 x 110 -C-Z	S	250	62,00 gal Zn
4,8 x 120 -C-Z	S	250	76,00 gal Zn
5,5 x 13 -C-Z	S	500	6,50 gal Zn
5,5 x 13 -C-Z	K	100	9,60 gal Zn
5,5 x 16 -C-Z	S	500	7,20 gal Zn
5,5 x 16 -C-Z	K	100	10,20 gal Zn
5,5 x 19 -C-Z	S	500	7,20 gal Zn
5,5 x 19 -C-Z	K	100	10,60 gal Zn
5,5 x 22 -C-Z	S	500	10,60 gal Zn
5,5 x 22 -C-Z	K	100	13,50 gal Zn
5,5 x 25 -C-Z	S	250	11,20 gal Zn
5,5 x 25 -C-Z	K	100	14,20 gal Zn
5,5 x 32 -C-Z	S	250	12,90 gal Zn
5,5 x 32 -C-Z	K	100	15,90 gal Zn
5,5 x 38 -C-Z	S	250	12,90 gal Zn
5,5 x 38 -C-Z	K	100	18,90 gal Zn
5,5 x 45 -C-Z	S	250	18,00 gal Zn
5,5 x 45 -C-Z	K	100	21,00 gal Zn
5,5 x 50 -C-Z	S	250	21,10 gal Zn

Abmessungen	VE	Stück	€/100/Obf.
5,5 x 50 -C-Z	K	100	24,00 gal Zn
5,5 x 60 -C-Z	S	250	40,00 gal Zn
5,5 x 70 -C-Z	S	250	49,50 gal Zn
5,5 x 80 -C-Z	S	250	59,00 gal Zn
6,3 x 13 -C-Z	S	250	9,50 gal Zn
6,3 x 13 -C-Z	K	100	12,40 gal Zn
6,3 x 16 -C-Z	S	250	9,70 gal Zn
6,3 x 16 -C-Z	K	100	12,60 gal Zn
6,3 x 19 -C-Z	S	250	9,90 gal Zn
6,3 x 19 -C-Z	K	100	12,90 gal Zn
6,3 x 22 -C-Z	S	250	11,80 gal Zn
6,3 x 22 -C-Z	K	100	14,80 gal Zn
6,3 x 25 -C-Z	S	250	14,30 gal Zn
6,3 x 25 -C-Z	K	100	17,40 gal Zn
6,3 x 32 -C-Z	S	250	15,70 gal Zn
6,3 x 32 -C-Z	K	100	18,70 gal Zn
6,3 x 38 -C-Z	S	250	19,50 gal Zn
6,3 x 38 -C-Z	K	100	22,60 gal Zn
6,3 x 45 -C-Z	S	250	24,00 gal Zn
6,3 x 45 -C-Z	K	100	27,00 gal Zn
6,3 x 50 -C-Z	S	250	26,00 gal Zn
6,3 x 50 -C-Z	K	100	28,50 gal Zn
6,3 x 60 -C-Z	S	250	45,50 gal Zn
6,3 x 70 -C-Z	S	250	65,00 gal Zn
6,3 x 80 -C-Z	S	250	83,00 gal Zn
6,3 x 90 -C-Z	S	250	101,00 gal Zn
6,3 x 100 -C-Z	S	250	119,00 gal Zn

ISO 07050.014
7050 Stahl gehärtet Form C-H
 galvanisch verzinkt

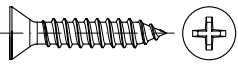

Senk-Blechschraben mit Phillips-Kreuzschlitz H, C = mit Spitze

Nennlänge ab 6 mm mit Teilgewinde,
 Senk $\sphericalangle = 90^\circ$

Maße \rightarrow TI-47 Montage \rightarrow TI-251
 Korrosionsschutz \rightarrow TI-228 Normumstellung \rightarrow TI-11

Rostfrei \rightarrow S. 567

ISO 7050 \rightarrow ersetzt DIN 7982

RoHS REACH SVHC free

2,2 x 6,5 -C-H	S	2000	5,60 gal Zn
2,2 x 9,5 -C-H	S	2000	5,30 gal Zn
2,2 x 13 -C-H	S	2000	5,30 gal Zn
2,2 x 16 -C-H	S	2000	7,90 gal Zn
2,9 x 6,5 -C-H	S	2000	5,70 gal Zn
2,9 x 9,5 -C-H	S	2000	2,30 gal Zn
2,9 x 13 -C-H	S	2000	2,45 gal Zn
2,9 x 16 -C-H	S	2000	2,60 gal Zn
2,9 x 19 -C-H	S	2000	3,70 gal Zn
2,9 x 22 -C-H	S	2000	4,30 gal Zn
2,9 x 25 -C-H	S	1000	5,30 gal Zn
2,9 x 32 -C-H	S	1000	6,00 gal Zn
3,5 x 6,5 -C-H	S	1000	3,65 gal Zn
3,5 x 9,5 -C-H	S	1000	2,75 gal Zn
3,5 x 13 -C-H	S	1000	2,85 gal Zn
3,5 x 16 -C-H	S	1000	3,00 gal Zn
3,5 x 19 -C-H	S	1000	3,90 gal Zn
3,5 x 22 -C-H	S	1000	4,70 gal Zn
3,5 x 25 -C-H	S	500	5,70 gal Zn
3,5 x 32 -C-H	S	500	7,20 gal Zn
3,5 x 38 -C-H	S	500	7,90 gal Zn

Abmessungen	VE	Stück	€/100/Obf.
4,2 x 9,5 -C-H	S	1000	3,40 gal Zn
4,2 x 13 -C-H	S	1000	3,45 gal Zn
4,2 x 16 -C-H	S	1000	3,85 gal Zn
4,2 x 19 -C-H	S	500	4,40 gal Zn
4,2 x 22 -C-H	S	500	5,00 gal Zn
4,2 x 25 -C-H	S	500	6,20 gal Zn
4,2 x 32 -C-H	S	500	7,80 gal Zn
4,2 x 38 -C-H	S	500	9,40 gal Zn
4,2 x 45 -C-H	S	500	10,50 gal Zn
4,2 x 50 -C-H	S	500	19,20 gal Zn
4,2 x 60 -C-H	S	250	22,00 gal Zn
4,2 x 70 -C-H	S	250	26,00 gal Zn
4,2 x 80 -C-H	S	250	28,50 gal Zn
4,8 x 9,5 -C-H	S	500	7,80 gal Zn
4,8 x 13 -C-H	S	500	4,85 gal Zn
4,8 x 16 -C-H	S	500	5,10 gal Zn
4,8 x 19 -C-H	S	500	4,70 gal Zn
4,8 x 22 -C-H	S	500	6,20 gal Zn
4,8 x 25 -C-H	S	500	7,30 gal Zn
4,8 x 32 -C-H	S	250	8,40 gal Zn
4,8 x 38 -C-H	S	250	9,70 gal Zn
4,8 x 45 -C-H	S	250	10,70 gal Zn
4,8 x 50 -C-H	S	250	20,30 gal Zn
4,8 x 60 -C-H	S	250	24,00 gal Zn
4,8 x 70 -C-H	S	250	29,50 gal Zn
4,8 x 80 -C-H	S	250	37,00 gal Zn
4,8 x 90 -C-H	S	250	44,00 gal Zn
4,8 x 100 -C-H	S	250	58,00 gal Zn
4,8 x 110 -C-H	S	100	73,00 gal Zn
4,8 x 120 -C-H	S	100	91,00 gal Zn
5,5 x 13 -C-H	S	500	8,00 gal Zn
5,5 x 16 -C-H	S	500	7,20 gal Zn
5,5 x 19 -C-H	S	500	7,60 gal Zn
5,5 x 22 -C-H	S	500	10,50 gal Zn
5,5 x 25 -C-H	S	250	11,20 gal Zn
5,5 x 32 -C-H	S	250	11,30 gal Zn
5,5 x 38 -C-H	S	250	14,70 gal Zn
5,5 x 45 -C-H	S	250	18,00 gal Zn
5,5 x 50 -C-H	S	250	21,80 gal Zn
5,5 x 60 -C-H	S	250	30,50 gal Zn
6,3 x 16 -C-H	S	250	11,70 gal Zn
6,3 x 19 -C-H	S	250	13,20 gal Zn
6,3 x 22 -C-H	S	250	14,70 gal Zn
6,3 x 25 -C-H	S	250	15,70 gal Zn
6,3 x 32 -C-H	S	250	17,20 gal Zn
6,3 x 38 -C-H	S	250	20,90 gal Zn
6,3 x 45 -C-H	S	250	24,00 gal Zn
6,3 x 50 -C-H	S	250	27,50 gal Zn
6,3 x 60 -C-H	S	250	49,50 gal Zn
6,3 x 70 -C-H	S	250	65,00 gal Zn
6,3 x 80 -C-H	S	250	79,00 gal Zn

Abmessungen VE Stück €/100/Obf.
 ISO 07050.016
7050 Stahl gehärtet Form C-Z
 galvanisch verzinkt

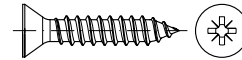

Senk-Blechschraben mit Pozidriv-Kreuzschlitz Z, C = mit Spitze

Senk $\sphericalangle = 90^\circ$

Maße \rightarrow TI-47 Montage \rightarrow TI-251
 Korrosionsschutz \rightarrow TI-228 Normumstellung \rightarrow TI-11

ISO 7050 \rightarrow ersetzt DIN 7982

RoHS REACH SVHC free

2,2 x 6,5 -C-Z	S	2000	8,40 gal Zn
2,2 x 9,5 -C-Z	S	2000	7,90 gal Zn
2,2 x 13 -C-Z	S	2000	8,00 gal Zn
2,2 x 16 -C-Z	S	2000	11,80 gal Zn
2,9 x 6,5 -C-Z	S	2000	8,60 gal Zn
2,9 x 9,5 -C-Z	S	2000	3,45 gal Zn
2,9 x 13 -C-Z	S	2000	3,65 gal Zn
2,9 x 16 -C-Z	S	2000	3,95 gal Zn
2,9 x 19 -C-Z	S	2000	5,60 gal Zn
2,9 x 22 -C-Z	S	2000	6,50 gal Zn
2,9 x 25 -C-Z	S	1000	8,00 gal Zn
2,9 x 32 -C-Z	S	1000	9,00 gal Zn
3,5 x 6,5 -C-Z	S	1000	5,50 gal Zn
3,5 x 9,5 -C-Z	S	1000	4,10 gal Zn
3,5 x 13 -C-Z	S	1000	4,30 gal Zn
3,5 x 16 -C-Z	S	1000	4,50 gal Zn
3,5 x 19 -C-Z	S	1000	5,90 gal Zn
3,5 x 22 -C-Z	S	1000	7,00 gal Zn
3,5 x 25 -C-Z	S	500	8,60 gal Zn
3,5 x 32 -C-Z	S	500	10,80 gal Zn
3,5 x 38 -C-Z	S	500	11,80 gal Zn
3,9 x 9,5 -C-Z	S	1000	4,85 gal Zn
3,9 x 13 -C-Z	S	1000	4,95 gal Zn
3,9 x 16 -C-Z	S	1000	5,40 gal Zn
3,9 x 19 -C-Z	S	1000	6,30 gal Zn
3,9 x 22 -C-Z	S	500	7,20 gal Zn
3,9 x 25 -C-Z	S	500	8,90 gal Zn
3,9 x 32 -C-Z	S	500	11,30 gal Zn
3,9 x 38 -C-Z	S	500	13,10 gal Zn
3,9 x 45 -C-Z	S	500	14,00 gal Zn
3,9 x 50 -C-Z	S	500	26,50 gal Zn
3,9 x 60 -C-Z	S	250	29,50 gal Zn
4,2 x 9,5 -C-Z	S	1000	5,10 gal Zn
4,2 x 13 -C-Z	S	1000	5,20 gal Zn
4,2 x 16 -C-Z	S	1000	5,80 gal Zn
4,2 x 19 -C-Z	S	500	6,60 gal Zn
4,2 x 22 -C-Z	S	500	7,50 gal Zn
4,2 x 25 -C-Z	S	500	9,30 gal Zn
4,2 x 32 -C-Z	S	500	11,70 gal Zn
4,2 x 38 -C-Z	S	500	14,00 gal Zn
4,2 x 45 -C-Z	S	500	15,70 gal Zn
4,2 x 50 -C-Z	S	500	29,00 gal Zn
4,2 x 60 -C-Z	S	250	33,00 gal Zn
4,2 x 70 -C-Z	S	250	38,50 gal Zn
4,2 x 80 -C-Z	S	250	43,00 gal Zn
4,8 x 9,5 -C-Z	S	500	11,70 gal Zn
4,8 x 13 -C-Z	S	500	7,30 gal Zn
4,8 x 16 -C-Z	S	500	7,70 gal Zn
4,8 x 19 -C-Z	S	500	7,00 gal Zn
4,8 x 22 -C-Z	S	500	9,30 gal Zn
4,8 x 25 -C-Z	S	500	10,90 gal Zn

Abmessungen	VE	Stück	€/100/Obf.
4,8 x 32 -C-Z	S	250	12,60 gal Zn
4,8 x 38 -C-Z	S	250	14,60 gal Zn
4,8 x 45 -C-Z	S	250	16,00 gal Zn
4,8 x 50 -C-Z	S	250	30,50 gal Zn
4,8 x 60 -C-Z	S	250	36,00 gal Zn
4,8 x 70 -C-Z	S	250	44,00 gal Zn
4,8 x 80 -C-Z	S	250	56,00 gal Zn
4,8 x 90 -C-Z	S	250	66,00 gal Zn
4,8 x 100 -C-Z	S	250	87,00 gal Zn
4,8 x 110 -C-Z	S	100	109,00 gal Zn
4,8 x 120 -C-Z	S	100	137,00 gal Zn
5,5 x 13 -C-Z	S	500	12,00 gal Zn
5,5 x 16 -C-Z	S	500	10,80 gal Zn
5,5 x 19 -C-Z	S	500	11,30 gal Zn
5,5 x 22 -C-Z	S	500	15,70 gal Zn
5,5 x 25 -C-Z	S	250	16,70 gal Zn
5,5 x 32 -C-Z	S	250	16,90 gal Zn
5,5 x 38 -C-Z	S	250	22,00 gal Zn
5,5 x 45 -C-Z	S	250	27,00 gal Zn
5,5 x 50 -C-Z	S	250	33,00 gal Zn
5,5 x 60 -C-Z	S	250	45,50 gal Zn
6,3 x 16 -C-Z	S	250	17,50 gal Zn
6,3 x 19 -C-Z	S	250	19,80 gal Zn
6,3 x 22 -C-Z	S	250	22,00 gal Zn
6,3 x 25 -C-Z	S	250	23,50 gal Zn
6,3 x 32 -C-Z	S	250	26,00 gal Zn
6,3 x 38 -C-Z	S	250	31,50 gal Zn
6,3 x 45 -C-Z	S	250	36,00 gal Zn
6,3 x 50 -C-Z	S	250	41,50 gal Zn
6,3 x 60 -C-Z	S	250	74,00 gal Zn
6,3 x 70 -C-Z	S	250	97,00 gal Zn
6,3 x 80 -C-Z	S	250	118,00 gal Zn

ISO	07051.014
7051	Stahl gehärtet Form C-H galvanisch verzinkt

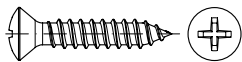

Linsensenk-Blechschauben mit Phillips-Kreuzschlitz H, C = mit Spitze

Senk $\sphericalangle = 90^\circ$

Maße \rightarrow TI-47 Montage \rightarrow TI-251
 Korrosionsschutz \rightarrow TI-228 Normumstellung \rightarrow TI-11

Rostfrei \rightarrow S. 567

ISO 7051 \rightarrow ersetzt DIN 7983

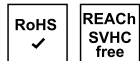

2,9 x 6,5 -C-H	S	2000	5,60 gal Zn
2,9 x 9,5 -C-H	S	2000	2,30 gal Zn
2,9 x 13 -C-H	S	2000	2,45 gal Zn
2,9 x 16 -C-H	S	2000	2,80 gal Zn
2,9 x 19 -C-H	S	2000	3,70 gal Zn
2,9 x 22 -C-H	S	2000	4,60 gal Zn
2,9 x 25 -C-H	S	1000	4,85 gal Zn
3,5 x 9,5 -C-H	S	1000	3,35 gal Zn
3,5 x 13 -C-H	S	1000	3,90 gal Zn
3,5 x 16 -C-H	S	1000	3,00 gal Zn
3,5 x 19 -C-H	S	1000	3,95 gal Zn
3,5 x 22 -C-H	S	1000	4,70 gal Zn
3,5 x 25 -C-H	S	500	5,30 gal Zn
3,5 x 32 -C-H	S	500	6,70 gal Zn
3,5 x 38 -C-H	S	500	7,30 gal Zn
4,2 x 9,5 -C-H	S	1000	2,85 gal Zn
4,2 x 13 -C-H	S	1000	3,45 gal Zn

Abmessungen	VE	Stück	€/100/Obf.
4,2 x 16 -C-H	S	1000	3,85 gal Zn
4,2 x 19 -C-H	S	500	4,45 gal Zn
4,2 x 22 -C-H	S	500	6,20 gal Zn
4,2 x 25 -C-H	S	500	6,30 gal Zn
4,2 x 32 -C-H	S	500	7,30 gal Zn
4,2 x 38 -C-H	S	500	7,40 gal Zn
4,2 x 45 -C-H	S	500	10,50 gal Zn
4,2 x 50 -C-H	S	500	12,90 gal Zn
4,8 x 9,5 -C-H	S	500	7,80 gal Zn
4,8 x 13 -C-H	S	500	4,85 gal Zn
4,8 x 16 -C-H	S	500	5,10 gal Zn
4,8 x 19 -C-H	S	500	6,20 gal Zn
4,8 x 22 -C-H	S	500	7,10 gal Zn
4,8 x 25 -C-H	S	500	8,40 gal Zn
4,8 x 32 -C-H	S	250	9,00 gal Zn
4,8 x 38 -C-H	S	250	9,70 gal Zn
4,8 x 45 -C-H	S	250	10,70 gal Zn
4,8 x 50 -C-H	S	250	13,60 gal Zn
5,5 x 13 -C-H	S	500	8,80 gal Zn
5,5 x 16 -C-H	S	500	9,50 gal Zn
5,5 x 19 -C-H	S	500	10,20 gal Zn
5,5 x 22 -C-H	S	500	11,30 gal Zn
5,5 x 25 -C-H	S	250	12,10 gal Zn
5,5 x 32 -C-H	S	250	14,00 gal Zn
5,5 x 38 -C-H	S	250	14,70 gal Zn
5,5 x 45 -C-H	S	250	18,00 gal Zn
5,5 x 50 -C-H	S	250	20,70 gal Zn
6,3 x 16 -C-H	S	250	11,80 gal Zn
6,3 x 19 -C-H	S	250	12,30 gal Zn
6,3 x 22 -C-H	S	250	14,20 gal Zn
6,3 x 25 -C-H	S	250	14,30 gal Zn
6,3 x 32 -C-H	S	250	17,20 gal Zn
6,3 x 38 -C-H	S	250	18,00 gal Zn
6,3 x 45 -C-H	S	250	19,30 gal Zn
6,3 x 50 -C-H	S	250	25,50 gal Zn

ISO	07089.000
7089	Stahl 200 HV

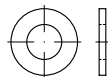

Flache Scheiben, normale Reihe, Produktklasse A, ohne Fase

Maße \rightarrow TI-84 Normumstellung \rightarrow TI-84

Rostfrei \rightarrow S. 568

Messing, Kupfer, Kunststoff, Aluminium \rightarrow S. 639

ISO 7089 \rightarrow ersetzt DIN 125 Form A



für Schrauben M

1,6	S	100	33,50
2	S	5000	1,40
2,5	S	5000	1,50
3	S	5000	0,45
4	S	1000	1,35
5	S	1000	1,65
5	K	100	3,75
6	S	1000	2,75
6	K	100	5,20
8	S	1000	3,85
8	K	100	5,90
10	S	500	6,30
10	K	100	8,70
12	S	500	22,40
12	K	100	14,20
14	S	250	13,10

Abmessungen	VE	Stück	€/100/Obf.
16	S	250	41,00
16	K	100	20,10
18	S	250	25,50
18	K	100	30,50
20	S	200	27,50
20	K	100	32,50
22	S	200	54,00
24	S	200	117,00
24	K	100	69,00
27	S	100	96,00
30	S	100	120,00
33	S	50	114,00
36	S	50	232,00

ISO	07089.010
7089	Stahl 200 HV galvanisch verzinkt

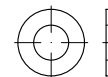

Flache Scheiben, normale Reihe, Produktklasse A, ohne Fase

Maße \rightarrow TI-84 Normumstellung \rightarrow TI-84

Korrosionsschutz \rightarrow TI-228

Rostfrei \rightarrow S. 568

Messing, Kupfer, Kunststoff, Aluminium \rightarrow S. 639

ISO 7089 \rightarrow ersetzt DIN 125 Form A

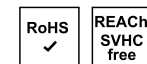

für Schrauben M

2	S	5000	1,20 gal Zn
2,5	S	5000	1,55 gal Zn
3	S	1000	1,60 gal Zn
3	K	200	3,45 gal Zn
4	S	1000	1,95 gal Zn
4	K	200	4,25 gal Zn
5	S	1000	1,95 gal Zn
5	K	100	4,55 gal Zn
6	S	1000	3,45 gal Zn
6	K	100	6,80 gal Zn
8	S	1000	4,85 gal Zn
8	K	100	8,30 gal Zn
10	S	500	8,40 gal Zn
10	K	100	12,10 gal Zn
12	S	500	14,90 gal Zn
12	K	100	21,80 gal Zn
14	S	250	19,70 gal Zn
14	K	100	24,20 gal Zn
16	S	250	22,30 gal Zn
16	K	100	31,50 gal Zn
18	S	250	29,50 gal Zn
18	K	100	39,00 gal Zn
20	S	200	36,50 gal Zn
20	K	100	48,50 gal Zn
22	S	200	65,00 gal Zn
22	K	100	77,00 gal Zn
24	S	200	72,00 gal Zn
24	K	100	84,00 gal Zn
27	S	100	121,00 gal Zn
30	S	100	166,00 gal Zn
33	S	50	121,00 gal Zn
36	S	50	315,00 gal Zn

Abmessungen	VE Stück	€/100/Obf.
ISO	07089.080	
7089	Stahl 200 HV	galv. verz. 8 DiSP*

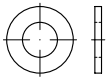

Flache Scheiben, normale Reihe, Produktklasse A, ohne Fase

* $\varnothing 6$ Mindestschichtdicke 5µm, Korrosionsbeständigkeit NSS: 72h WR, 120h RR

Maße → **TI-84** Normumstellung → **TI-84**
 Korrosionsschutz → **TI-228**
 Rostfrei → **S. 568**
 Messing, Kupfer, Kunststoff, Aluminium → **S. 639**

ISO 7089 → ersetzt DIN 125 Form A



für Schrauben M

5	S	1000	2,60 gal ZnDi
6	S	1000	4,75 gal ZnDi
8	S	1000	6,30 gal ZnDi
10	S	500	10,70 gal ZnDi
12	S	500	19,20 gal ZnDi
16	S	250	28,50 gal ZnDi
20	S	200	47,00 gal ZnDi
24	S	200	126,00 gal ZnDi
30	S	100	212,00 gal ZnDi
36	S	50	420,00 gal ZnDi

ISO	07089.428
7089	Stahl 200 HV
	galv. verz. 8 DiSP* + S**

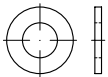

Flache Scheiben, normale Reihe, Produktklasse A, ohne Fase

* $\varnothing 6$ Mindestschichtdicke 5µm, **S = Sealer (Versiegelung), Korrosionsbeständigkeit NSS: 120h WR, 264h RR

Maße → **TI-84** Normumstellung → **TI-84**
 Korrosionsschutz → **TI-228**
 Rostfrei → **S. 568**
 Messing, Kupfer, Kunststoff, Aluminium → **S. 639**

ISO 7089 → ersetzt DIN 125 Form A



für Schrauben M

3	S	1000	1,05 gal ZnDi
4	S	1000	1,60 gal ZnDi
5	S	1000	2,50 gal ZnDi
6	S	1000	4,45 gal ZnDi
8	S	1000	6,00 gal ZnDi
10	S	500	10,20 gal ZnDi
12	S	500	18,30 gal ZnDi
14	S	500	26,00 gal ZnDi
16	S	250	27,00 gal ZnDi
18	S	250	46,50 gal ZnDi
20	S	200	44,50 gal ZnDi
24	S	200	121,00 gal ZnDi

Abmessungen	VE Stück	€/100/Obf.
30	S	100 204,00 gal ZnDi
36	S	50 400,00 gal ZnDi

ISO	07089.020
7089	Stahl 200 HV
	feuerverzinkt

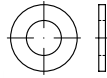

Flache Scheiben, normale Reihe, Produktklasse A, ohne Fase

Maße → **TI-84** Normumstellung → **TI-84**
 Korrosionsschutz → **TI-231**
 Rostfrei → **S. 568**
 Messing, Kupfer, Kunststoff, Aluminium → **S. 639**

ISO 7089 → ersetzt DIN 125 Form A

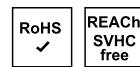

für Schrauben M

6	S	1000	6,80 tZn
8	S	1000	9,50 tZn
10	S	500	17,00 tZn
12	S	500	22,40 tZn
14	S	500	36,50 tZn
16	S	250	34,00 tZn
18	S	250	53,00 tZn
20	S	200	54,00 tZn
24	S	200	102,00 tZn
27	S	100	194,00 tZn
30	S	100	194,00 tZn
33	S	50	164,00 tZn

ISO	07089.031
7089	Stahl 200 HV
	galvanisch vernickelt

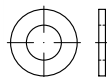

Flache Scheiben, normale Reihe, Produktklasse A, ohne Fase

Maße → **TI-84** Normumstellung → **TI-84**
 Korrosionsschutz → **TI-228**
 Rostfrei → **S. 568**
 Messing, Kupfer, Kunststoff, Aluminium → **S. 639**

ISO 7089 → ersetzt DIN 125 Form A



für Schrauben M

3	S	1000	3,20 gal Ni
4	S	1000	3,90 gal Ni
5	S	1000	3,90 gal Ni
6	S	1000	6,90 gal Ni
8	S	1000	9,70 gal Ni
10	S	1000	16,80 gal Ni

Abmessungen	VE Stück	€/100/Obf.
ISO	07089.005	
7089	Stahl 200 HV	nitrocarburiert



Flache Scheiben, normale Reihe, Produktklasse A, ohne Fase

Oberflächenhärte max. 450 HV

Maße → **TI-84** Normumstellung → **TI-84**
 Rostfrei → **S. 568**
 Messing, Kupfer, Kunststoff, Aluminium → **S. 639**

ISO 7089 → ersetzt DIN 125 Form A

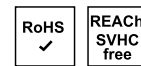

für Schrauben M

12	S	500	15,90
16	S	250	29,00
20	S	200	41,50
24	S	200	81,00
27	S	100	164,00
30	S	100	200,00
33	S	50	285,00
36	S	50	345,00
39	S	50	640,00

ISO	07089.012
7089	Stahl 200 HV
	gal Zn, nitrocarburiert



Flache Scheiben, normale Reihe, Produktklasse A, ohne Fase

Oberflächenhärte max. 450 HV

Maße → **TI-84** Normumstellung → **TI-84**
 Korrosionsschutz → **TI-228**
 Rostfrei → **S. 568**
 Messing, Kupfer, Kunststoff, Aluminium → **S. 639**

ISO 7089 → ersetzt DIN 125 Form A

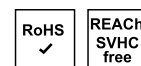

für Schrauben M

12	S	500	20,70 gal Zn
16	S	250	38,00 gal Zn
20	S	200	54,00 gal Zn
24	S	200	102,00 gal Zn
27	S	100	213,00 gal Zn
30	S	100	260,00 gal Zn
33	S	50	370,00 gal Zn
36	S	50	450,00 gal Zn
39	S	50	830,00 gal Zn

Abmessungen VE Stück €/100/Obf.
ISO 07089.004

7089 **Stahl vergütet 300 HV**

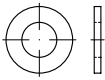

Flache Scheiben, normale Reihe, Produktklasse A, ohne Fase

Maße → **TI-84** Normumstellung → **TI-84**

Rostfrei → **S. 568**
Messing, Kupfer, Kunststoff, Aluminium → **S. 639**

ISO 7089 → ersetzt DIN 125 Form A



für Schrauben M

4	S	200	27,50
5	S	200	56,00
6	S	200	66,00
8	S	200	69,00
10	S	100	244,00
12	S	100	275,00
16	S	100	510,00
20	S	100	530,00
24	S	50	690,00
30	S	50	880,00

ISO 07089.015

7089 **Stahl vergütet 300 HV galvanisch verzinkt**

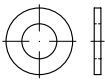

Flache Scheiben, normale Reihe, Produktklasse A, ohne Fase

Maße → **TI-84** Normumstellung → **TI-84**

Korrosionsschutz → **TI-228**

Rostfrei → **S. 568**
Messing, Kupfer, Kunststoff, Aluminium → **S. 639**

ISO 7089 → ersetzt DIN 125 Form A



für Schrauben M

4	S	200	29,00 gal Zn
5	S	200	58,00 gal Zn
6	S	200	67,00 gal Zn
8	S	200	72,00 gal Zn
10	S	100	260,00 gal Zn
12	S	100	285,00 gal Zn
16	S	100	520,00 gal Zn
20	S	100	560,00 gal Zn
24	S	50	740,00 gal Zn
27	S	50	850,00 gal Zn
30	S	50	920,00 gal Zn
36	S	50	1060,00 gal Zn

Abmessungen VE Stück €/100/Obf.
ISO 07089.438

7089 **Stahl vergütet 300 HV galv. verz. 8 DiSP* + S****

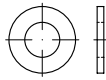

Flache Scheiben, normale Reihe, Produktklasse A, ohne Fase

*< Ø 6 Mindestschichtdicke 5µm,
**S = Sealer (Versiegelung),
Korrosionsbeständigkeit NSS: 120h WR, 264h RR

Maße → **TI-84** Normumstellung → **TI-84**

Korrosionsschutz → **TI-228**

Rostfrei → **S. 568**
Messing, Kupfer, Kunststoff, Aluminium → **S. 639**

ISO 7089 → ersetzt DIN 125 Form A



für Schrauben M

4	S	200	35,00 gal ZnDi
5	S	200	69,00 gal ZnDi
6	S	200	80,00 gal ZnDi
8	S	200	86,00 gal ZnDi
10	S	100	310,00 gal ZnDi
12	S	100	340,00 gal ZnDi
16	S	100	620,00 gal ZnDi
20	S	100	670,00 gal ZnDi
24	S	50	890,00 gal ZnDi

ISO 07089.013

7089 **Stahl vergütet 300 HV galvanisch verzinkt**

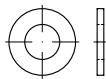

Flache Scheiben, normale Reihe, Produktklasse A, ohne Fase

CE-konform nur bei Verwendung mit
SB-Garnituren nach EN 15048

Maße → **TI-84** Normumstellung → **TI-84**

Korrosionsschutz → **TI-228**

ISO 7089 → ersetzt DIN 125 Form A

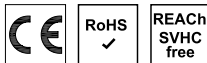

für Schrauben M

10	S	100	310,00 gal Zn
12	S	100	340,00 gal Zn
16	S	100	620,00 gal Zn
20	S	100	670,00 gal Zn
24	S	50	890,00 gal Zn
27	S	50	1010,00 gal Zn

Abmessungen VE Stück €/100/Obf.
ISO 07089.024

7089 **Stahl vergütet 300 HV feuerverzinkt**

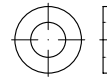

Flache Scheiben, normale Reihe, Produktklasse A, ohne Fase

Maße → **TI-84** Normumstellung → **TI-84**

Korrosionsschutz → **TI-231**

Rostfrei → **S. 568**
Messing, Kupfer, Kunststoff, Aluminium → **S. 639**

ISO 7089 → ersetzt DIN 125 Form A



für Schrauben M

10	S	500	30,50 tZn
12	S	500	39,00 tZn
16	S	250	83,00 tZn
20	S	200	102,00 tZn
24	S	200	200,00 tZn
27	S	100	340,00 tZn
30	S	50	1090,00 tZn
36	S	50	1280,00 tZn

ISO 07090.000

7090 **Stahl 200 HV**

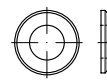

Flache Scheiben mit Fase, normale Reihe, Produktklasse A

Maße → **TI-84** Normumstellung → **TI-84**

Rostfrei → **S. 569**

Messing → **S. 640**

ISO 7090 → ersetzt DIN 125 Form B



für Schrauben M

3	S	1000	3,40
4	S	1000	2,35
5	S	1000	3,35
6	S	1000	3,65
8	S	1000	6,20
10	S	500	11,40
12	S	500	13,20
14	S	250	19,40
16	S	250	19,70
18	S	250	22,40
20	S	200	30,00
22	S	200	35,50
24	S	200	57,00
27	S	50	94,00
30	S	100	120,00
33	S	50	224,00
36	S	50	232,00
39	S	25	260,00
42	S	25	445,00
45	S	25	475,00

Abmessungen	VE	Stück	€/100/Obf.
48	S	10	700,00
52	S	1	1120,00
56	S	1	1520,00
60	S	1	1810,00
64	S	1	1810,00

ISO	07090.010
7090	Stahl 200 HV galvanisch verzinkt



Flache Scheiben mit Fase, normale Reihe, Produktklasse A

Maße → **TI-84** Normumstellung → **TI-84**
 Korrosionsschutz → **TI-228**
 Rostfrei → **S. 569**
 Messing → **S. 640**
 ISO 7090 → ersetzt DIN 125 Form B

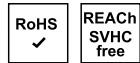

für Schrauben M

3	S	1000	3,40 gal Zn
3	K	100	5,30 gal Zn
4	S	1000	2,50 gal Zn
4	K	100	4,75 gal Zn
5	S	1000	3,65 gal Zn
5	K	100	6,30 gal Zn
6	S	1000	5,20 gal Zn
6	K	100	8,50 gal Zn
8	S	1000	7,70 gal Zn
8	K	100	11,10 gal Zn
10	S	500	14,30 gal Zn
10	K	100	18,10 gal Zn
12	S	500	16,70 gal Zn
12	K	100	23,60 gal Zn
14	S	250	23,00 gal Zn
16	S	250	26,00 gal Zn
16	K	100	34,50 gal Zn
18	S	250	33,00 gal Zn
20	S	200	38,00 gal Zn
20	K	100	50,00 gal Zn
22	S	200	40,00 gal Zn
24	S	200	72,00 gal Zn
24	K	100	84,00 gal Zn
27	S	50	128,00 gal Zn
30	S	100	166,00 gal Zn
33	S	50	249,00 gal Zn
36	S	50	315,00 gal Zn
39	S	25	380,00 gal Zn
42	S	25	610,00 gal Zn
45	S	25	670,00 gal Zn
48	S	10	980,00 gal Zn
52	S	1	1400,00 gal Zn
56	S	1	1940,00 gal Zn
60	S	1	2240,00 gal Zn
64	S	1	2280,00 gal Zn

Abmessungen	VE	Stück	€/100/Obf.
ISO		07090.080	
7090		Stahl 200 HV galv. verz. 8 DiSP*	



Flache Scheiben mit Fase, normale Reihe, Produktklasse A

* $\varnothing 6$ Mindestschichtdicke 5µm,
 Korrosionsbeständigkeit NSS: 72h WR, 120h RR

Maße → **TI-84** Normumstellung → **TI-84**
 Korrosionsschutz → **TI-228**
 Rostfrei → **S. 569**
 Messing → **S. 640**

ISO 7090 → ersetzt DIN 125 Form B



für Schrauben M

5	S	1000	4,55 gal ZnDi
6	S	1000	6,90 gal ZnDi
8	S	1000	10,90 gal ZnDi
10	S	500	19,40 gal ZnDi
12	S	500	22,70 gal ZnDi
16	S	250	34,50 gal ZnDi
20	S	200	51,00 gal ZnDi
24	S	200	126,00 gal ZnDi
30	S	100	212,00 gal ZnDi
36	S	50	420,00 gal ZnDi

ISO	07090.428
7090	Stahl 200 HV galv. verz. 8 DiSP* + S**



Flache Scheiben mit Fase, normale Reihe, Produktklasse A

* $\varnothing 6$ Mindestschichtdicke 5µm,
 **S = Sealer (Versiegelung),
 Korrosionsbeständigkeit NSS: 120h WR, 264h RR

Maße → **TI-84** Normumstellung → **TI-84**
 Korrosionsschutz → **TI-228**
 Rostfrei → **S. 569**
 Messing → **S. 640**

ISO 7090 → ersetzt DIN 125 Form B

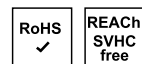

für Schrauben M

5	S	1000	11,20 gal ZnDi
6	S	1000	6,70 gal ZnDi
8	S	1000	10,50 gal ZnDi
10	S	500	18,60 gal ZnDi
12	S	500	21,70 gal ZnDi
16	S	250	33,00 gal ZnDi
20	S	200	49,00 gal ZnDi
22	S	200	74,00 gal ZnDi
24	S	200	121,00 gal ZnDi
27	S	100	192,00 gal ZnDi
30	S	100	204,00 gal ZnDi

Abmessungen	VE	Stück	€/100/Obf.
36	S	50	400,00 gal ZnDi
42	S	25	760,00 gal ZnDi
48	S	25	760,00 gal ZnDi

ISO	07090.353
7090	Stahl 200 HV fZn/TL480h

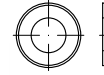

Flache Scheiben mit Fase, normale Reihe, Produktklasse A

Reibwert 0,09 - 0,14,
 Korrosionsbeständigkeit NSS: 480h RR,
 Chrom(VI)-frei

Maße → **TI-84** Normumstellung → **TI-84**
 Korrosionsschutz → **TI-230**

Rostfrei → **S. 569**
 Messing → **S. 640**

ISO 7090 → ersetzt DIN 125 Form B

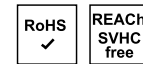

für Schrauben M

6	S	1000	8,20 fZn
8	S	1000	10,00 fZn
10	S	500	18,70 fZn
12	S	500	21,80 fZn
14	S	250	30,00 fZn
16	S	250	39,50 fZn
18	S	250	47,00 fZn
20	S	200	66,00 fZn
22	S	200	67,00 fZn
24	S	200	105,00 fZn

ISO	07090.318
7090	Stahl 300 HV fZnL480h



Flache Scheiben mit Fase, normale Reihe, Produktklasse A

fZnL = int. Schmierstoff mit $\mu = 0,12 - 0,18$,
 Korrosionsbeständigkeit NSS: 480h RR,
 Chrom(VI)-frei

Maße → **TI-84** Normumstellung → **TI-84**
 Korrosionsschutz → **TI-230**

Rostfrei → **S. 569**
 Messing → **S. 640**

ISO 7090 → ersetzt DIN 125 Form B

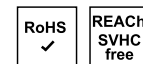

für Schrauben M

6	S	1000	8,20 fZn
8	S	1000	10,00 fZn
10	S	500	18,70 fZn
12	S	500	21,80 fZn
14	S	250	30,00 fZn
16	S	250	39,50 fZn
18	S	200	47,00 fZn

Abmessungen	VE	Stück	€/100/Obf.
20	S	200	66,00 flZn
22	S	200	67,00 flZn
24	S	200	105,00 flZn

ISO	07090.020
7090	Stahl 200 HV feuerverzinkt



**Flache Scheiben mit Fase,
normale Reihe, Produktklasse A**

Maße → **TI-84** Normumstellung → **TI-84**
Korrosionsschutz → **TI-231**

Rostfrei → **S. 569**
Messing → **S. 640**

ISO 7090 → ersetzt DIN 125 Form B



für Schrauben M

6	S	1000	10,90 tZn
8	S	1000	17,00 tZn
10	S	1000	29,50 tZn
12	S	500	39,00 tZn
16	S	250	56,00 tZn
20	S	200	82,00 tZn
22	S	200	69,00 tZn
24	S	200	158,00 tZn
27	S	100	173,00 tZn
30	S	100	360,00 tZn
33	S	50	270,00 tZn
36	S	50	690,00 tZn
39	S	25	475,00 tZn
42	S	25	670,00 tZn
45	S	25	700,00 tZn
48	S	25	1300,00 tZn
52	S	1	1300,00 tZn

ISO	07090.016
7090	Stahl vergütet 300 HV galvanisch verzinkt

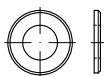

**Flache Scheiben, normale Reihe,
Produktklasse A, mit Fase**

CE-konform nur bei Verwendung mit
SB-Garnituren nach EN 15048

Maße → **TI-84** Normumstellung → **TI-84**
Korrosionsschutz → **TI-228**

ISO 7090 → ersetzt DIN 125 Form B



für Schrauben M

10	S	100	310,00 gal Zn
12	S	100	340,00 gal Zn
16	S	100	620,00 gal Zn
20	S	100	670,00 gal Zn
24	S	50	890,00 gal Zn
27	S	50	1010,00 gal Zn

Abmessungen	VE	Stück	€/100/Obf.
ISO		07090.026	
7090		Stahl 300 HV feuerverzinkt	



**Flache Scheiben mit Fase,
normale Reihe, Produktklasse A**

CE-konform nur bei Verwendung mit
SB-Garnituren nach EN 15048

Maße → **TI-84** Normumstellung → **TI-84**
Korrosionsschutz → **TI-231**

ISO 7090 → ersetzt DIN 125 Form B

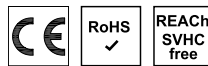

für Schrauben M

8	S	100	280,00 tZn
10	S	100	305,00 tZn
12	S	100	340,00 tZn
16	S	100	620,00 tZn
20	S	100	650,00 tZn
24	S	50	840,00 tZn
27	S	50	930,00 tZn
30	S	50	1090,00 tZn
36	S	50	1090,00 tZn

ISO	07091.000
7091	Stahl 100 HV

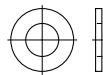

**Flache Scheiben,
normale Reihe, Produktklasse C**

Maße → **TI-84** Normumstellung → **TI-84**

ISO 7091 → ersetzt DIN 126 (austauschbar)



für Schrauben M

5	S	1000	1,55
5	K	100	6,10
6	S	1000	1,75
6	K	100	6,30
8	S	1000	3,30
8	K	100	7,80
10	S	1000	4,85
10	K	100	9,90
12	S	500	6,90
12	K	100	13,80
14	K	100	18,40
16	S	250	10,20
16	K	100	16,70
18	K	100	24,20
20	S	250	16,60
20	K	100	22,90
22	S	100	21,20
24	S	100	26,50
27	S	100	36,00
30	S	100	43,00
33	S	100	66,00
36	S	100	84,00

Abmessungen	VE	Stück	€/100/Obf.
39	S	50	101,00
42	S	50	158,00
45	S	50	181,00
48	S	25	224,00
52	S	25	475,00
56	S	25	680,00
60	S	10	760,00
64	S	10	820,00
72	S	10	1060,00
80	S	1	1700,00

ISO	07091.010
7091	Stahl 100 HV galvanisch verzinkt

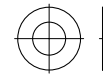

**Flache Scheiben,
normale Reihe, Produktklasse C**

Maße → **TI-84** Normumstellung → **TI-84**
Korrosionsschutz → **TI-228**

ISO 7091 → ersetzt DIN 126 (austauschbar)

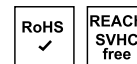

für Schrauben M

5	S	1000	1,70 gal Zn
5	K	100	6,20 gal Zn
6	S	1000	2,20 gal Zn
6	K	100	6,70 gal Zn
8	S	1000	3,95 gal Zn
8	K	100	8,40 gal Zn
10	S	1000	6,20 gal Zn
10	K	100	11,10 gal Zn
12	S	500	9,20 gal Zn
12	K	100	16,00 gal Zn
14	K	100	21,50 gal Zn
16	S	250	14,30 gal Zn
16	K	100	20,50 gal Zn
18	K	100	29,50 gal Zn
20	S	250	22,90 gal Zn
20	K	100	28,50 gal Zn
22	S	100	28,00 gal Zn
24	S	100	38,50 gal Zn
27	S	100	49,50 gal Zn
30	S	100	61,00 gal Zn
33	S	100	89,00 gal Zn
36	S	100	113,00 gal Zn
39	S	50	143,00 gal Zn
42	S	50	216,00 gal Zn
45	S	50	255,00 gal Zn
48	S	25	325,00 gal Zn
52	S	25	590,00 gal Zn
56	S	25	830,00 gal Zn

Abmessungen	VE Stück	€/100/Obf.
ISO	07092.004	

7092

Stahl 200 HV

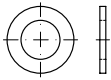

Flache Scheiben, kleine Reihe, Produktklasse A

vorzugsweise für Zylinderschrauben

Maße → TI-84

Normumstellung → TI-84

Rostfrei → S. 569

Messing → S. 641

ISO 7092 → ersetzt DIN 433



für Schrauben M

2	S 5000	3,50
3	S 5000	0,35
3,5	S 5000	1,70
4	S 5000	1,45
5	S 5000	1,00
6	S 1000	1,70
8	S 1000	3,15
10	S 1000	4,80
12	S 1000	7,60
14	S 500	11,10
16	S 500	14,20
18	S 500	21,20
20	S 500	25,50

ISO	07092.014
7092	Stahl 200 HV galvanisch verzinkt

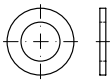

Flache Scheiben, kleine Reihe, Produktklasse A

vorzugsweise für Zylinderschrauben

Maße → TI-84

Normumstellung → TI-84

Korrosionsschutz → TI-228

Rostfrei → S. 569

Messing → S. 641

ISO 7092 → ersetzt DIN 433



für Schrauben M

2	S 5000	1,45 gal Zn
2,5	S 5000	1,20 gal Zn
3	S 5000	0,55 gal Zn
4	S 5000	0,45 gal Zn
5	S 5000	1,05 gal Zn
6	S 1000	1,95 gal Zn
8	S 1000	3,65 gal Zn
10	S 1000	5,40 gal Zn
12	S 1000	8,40 gal Zn
14	S 500	12,30 gal Zn

Abmessungen	VE Stück	€/100/Obf.
16	S 500	15,70 gal Zn
18	S 500	23,50 gal Zn
20	S 500	28,50 gal Zn

ISO	07093.004
-----	-----------

7093-1

Stahl 200 HV

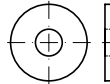

Flache Scheiben, große Reihe, Produktklasse A

Maße → TI-85

Normumstellung → TI-84

Rostfrei → S. 570

Messing → S. 641

ISO 7093 → ersetzt DIN 9021

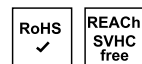

für Schrauben M

3	S 10000	0,75
4	S 5000	1,15
5	S 2500	1,50
6	S 2500	2,80
8	S 500	6,10
10	S 250	21,80
12	S 100	33,00
14	S 100	27,50
16	S 100	50,00
18	S 100	122,00
20	S 100	76,00
24	S 50	109,00
30	S 25	218,00
36	S 25	610,00

ISO	07093.014
7093-1	Stahl 200 HV galvanisch verzinkt

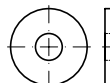

Flache Scheiben, große Reihe, Produktklasse A

Maße → TI-85

Normumstellung → TI-84

Korrosionsschutz → TI-228

Rostfrei → S. 570

Messing → S. 641

ISO 7093 → ersetzt DIN 9021



für Schrauben M

3	S 10000	1,85 gal Zn
4	S 5000	2,20 gal Zn
5	S 2500	2,55 gal Zn
6	S 2500	3,05 gal Zn
8	S 500	4,40 gal Zn
10	S 250	24,20 gal Zn
12	S 100	46,00 gal Zn
14	S 100	39,00 gal Zn
16	S 100	68,00 gal Zn
18	S 100	84,00 gal Zn

Abmessungen	VE Stück	€/100/Obf.
20	S 100	91,00 gal Zn
24	S 50	146,00 gal Zn
30	S 25	295,00 gal Zn
36	S 25	710,00 gal Zn

ISO	07093.024
-----	-----------

7093-1

Stahl 200 HV

feuerverzinkt

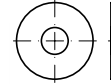

Flache Scheiben, große Reihe, Produktklasse A

Maße → TI-85

Normumstellung → TI-84

Korrosionsschutz → TI-231

Rostfrei → S. 570

Messing → S. 641

ISO 7093 → ersetzt DIN 9021

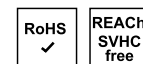

für Schrauben M

6	S 2500	6,10 tZn
8	S 500	8,80 tZn
10	S 250	68,00 tZn
12	S 100	92,00 tZn
16	S 100	136,00 tZn
18	S 100	126,00 tZn
20	S 100	194,00 tZn
24	S 50	295,00 tZn
30	S 25	590,00 tZn
36	S 25	1340,00 tZn

ISO	07094.000
-----	-----------

7094

Stahl 100 HV

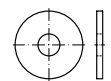

Flache Scheiben, extra große Reihe, Produktklasse C

vorwiegend für Holzkonstruktionen

Maße → TI-84

Normumstellung → TI-84

Rostfrei → S. 570

ISO 7094 → ersetzt DIN 440 Form R (austauschbar)

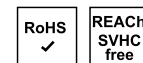

für Schrauben M

5	S 100	6,20
6	S 100	6,80
8	S 100	11,40
10	S 100	16,00
12	S 100	28,50
16	S 50	49,50
20	S 50	83,00
22	S 50	126,00
24	S 50	164,00
27	S 25	215,00
30	S 25	250,00
33	S 25	285,00

Abmessungen	VE	Stück	€/100/Obf.
36	S	25	460,00
39	S	25	910,00
42	S	10	970,00

ISO	07094.010
7094	Stahl 100 HV galvanisch verzinkt



Flache Scheiben, extra große Reihe, Produktklasse C

vorwiegend für Holzkonstruktionen

Maße → **TI-84** Normumstellung → **TI-84**
 Korrosionsschutz → **TI-228**

Rostfrei → **S. 570**

ISO 7094 → ersetzt DIN 440 Form R (austauschbar)

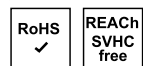

für Schrauben M

5	S	100	7,20 gal Zn
6	S	100	8,30 gal Zn
8	S	100	14,70 gal Zn
10	S	100	20,70 gal Zn
12	S	100	39,50 gal Zn
16	S	50	73,00 gal Zn
20	S	50	142,00 gal Zn
22	S	50	181,00 gal Zn
24	S	50	224,00 gal Zn
27	S	25	300,00 gal Zn
30	S	25	345,00 gal Zn
33	S	25	395,00 gal Zn
36	S	25	630,00 gal Zn
39	S	25	1110,00 gal Zn

ISO	07094.020
7094	Stahl 100 HV feuerverzinkt



Flache Scheiben, extra große Reihe, Produktklasse C

vorwiegend für Holzkonstruktionen

Maße → **TI-84** Normumstellung → **TI-84**
 Korrosionsschutz → **TI-231**

Rostfrei → **S. 570**

ISO 7094 → ersetzt DIN 440 Form R (austauschbar)



für Schrauben M

6	S	100	29,50 tzn
8	S	100	39,50 tzn
10	S	100	39,50 tzn
12	S	100	48,00 tzn
16	S	50	89,00 tzn
20	S	50	143,00 tzn
24	S	50	295,00 tzn

Abmessungen	VE	Stück	€/100/Obf.
-------------	----	-------	------------

DIN	07343.000
7343	Federstahl

Spiral-Spannstifte, Regelausführung

Maße → **TI-121** Normumstellung → **TI-10**

Rostfrei → **S. 571**

DIN 7343 → wird ersetzt durch ISO 8750 (austauschbar)



1,5	x	5	S	1000	6,50
1,5	x	6	S	1000	6,50
1,5	x	8	S	1000	6,90
1,5	x	10	S	1000	7,20
1,5	x	12	S	1000	7,20
2	x	6	S	1000	7,30
2	x	8	S	1000	7,40
2	x	10	S	1000	7,60
2	x	12	S	1000	7,70
2	x	14	S	1000	7,70
2	x	16	S	1000	7,70
2	x	18	S	1000	7,80
2	x	20	S	1000	8,60
2,5	x	10	S	1000	8,20
2,5	x	12	S	1000	8,40
2,5	x	16	S	1000	8,50
2,5	x	20	S	1000	9,10
3	x	8	S	1000	8,20
3	x	10	S	1000	8,50
3	x	12	S	1000	8,80
3	x	14	S	1000	8,90
3	x	16	S	1000	9,10
3	x	18	S	1000	9,40
3	x	20	S	1000	9,60
3	x	24	S	1000	10,10
3	x	26	S	1000	10,50
3	x	30	S	1000	10,50
3,5	x	20	S	1000	10,50
3,5	x	24	S	1000	11,30
4	x	8	S	500	10,50
4	x	10	S	500	10,50
4	x	12	S	500	10,50
4	x	14	S	500	10,70
4	x	16	S	500	11,10
4	x	18	S	500	11,30
4	x	20	S	500	11,50
4	x	24	S	500	12,10
4	x	26	S	500	12,50
4	x	30	S	500	13,60
4	x	32	S	500	14,80
4	x	36	S	500	16,00
4	x	40	S	500	17,10
4	x	50	S	500	20,40
5	x	20	S	500	15,50
5	x	22	S	500	16,30
5	x	24	S	500	16,60
5	x	26	S	500	17,50
5	x	30	S	500	18,70
5	x	32	S	500	19,40
5	x	40	S	500	22,00
6	x	14	S	500	19,40
6	x	18	S	500	20,00
6	x	20	S	500	20,60

Abmessungen	VE	Stück	€/100/Obf.
-------------	----	-------	------------

6	x	24	S	500	23,50
6	x	26	S	500	22,70
6	x	30	S	500	28,00
6	x	35	S	500	31,50
6	x	40	S	250	33,50
6	x	45	S	250	37,00
6	x	50	S	250	41,00
8	x	20	S	500	39,00
8	x	24	S	500	41,00
8	x	30	S	250	51,00
8	x	35	S	250	57,00
8	x	40	S	500	60,00
8	x	45	S	500	67,00
8	x	50	S	250	72,00
10	x	40	S	250	92,00
10	x	50	S	250	113,00
10	x	55	S	250	103,00
10	x	60	S	200	111,00
10	x	70	S	100	164,00
12	x	40	S	50	211,00
12	x	50	S	100	226,00
12	x	60	S	50	240,00
12	x	80	S	50	285,00
14	x	50	S	25	270,00
14	x	70	S	25	310,00
16	x	60	S	25	305,00
16	x	90	S	25	690,00

DIN	07344.000
7344	Federstahl

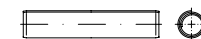

Spiral-Spannstifte, schwere Ausführung

Maße → **TI-121** Normumstellung → **TI-10**

DIN 7344 → wird ersetzt durch ISO 8748 (austauschbar)

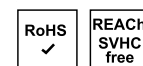

1,5	x	14	S	1000	8,30
2	x	8	S	1000	7,90
2	x	10	S	1000	8,20
2	x	12	S	1000	8,30
2	x	16	S	1000	8,50
2	x	18	S	1000	8,60
2,5	x	12	S	1000	8,50
2,5	x	14	S	1000	8,80
2,5	x	16	S	1000	8,80
2,5	x	20	S	1000	8,90
2,5	x	24	S	1000	9,10
3	x	8	S	1000	9,60
3	x	10	S	1000	9,90
3	x	12	S	1000	9,90
3	x	14	S	1000	10,10
3	x	16	S	1000	10,50
3	x	18	S	1000	10,70
3	x	20	S	1000	10,80
3	x	24	S	1000	11,30
3	x	30	S	1000	12,10
3	x	32	S	1000	11,70
4	x	12	S	1000	11,30
4	x	14	S	1000	11,50
4	x	16	S	1000	11,80
4	x	18	S	500	12,30
4	x	20	S	500	12,90
4	x	24	S	500	13,80

Abmessungen	VE	Stück	€/100/Obf.	Abmessungen	VE	Stück	€/100/Obf.	Abmessungen	VE	Stück	€/100/Obf.
4 x 26	S	500	15,50	3 x 10	S	200	7,80	10 x 14	S	100	26,00
4 x 30	S	500	16,00	3 x 12	S	200	7,90	10 x 16	S	100	27,50
4 x 40	S	500	19,00	3 x 14	S	200	7,90	10 x 20	S	100	32,50
5 x 12	S	1000	8,80	3 x 16	S	200	8,30	10 x 22	S	100	34,00
5 x 14	S	500	10,80	3 x 18	S	200	8,40	10 x 24	S	100	37,00
5 x 18	S	500	14,00	3 x 22	S	200	8,80	10 x 26	S	100	39,00
5 x 20	S	500	16,00	3 x 24	S	200	8,90	10 x 30	S	100	43,00
5 x 22	S	500	17,40	3 x 26	S	200	9,20	10 x 36	S	100	51,00
5 x 24	S	500	18,20	3 x 28	S	200	9,70	10 x 40	S	100	54,00
5 x 26	S	500	20,40	3 x 30	S	200	10,10	10 x 45	S	50	63,00
5 x 28	S	500	20,70	3 x 32	S	200	10,50	10 x 50	S	50	69,00
5 x 30	S	500	21,20	3 x 36	S	200	11,30	10 x 60	S	50	83,00
5 x 35	S	500	24,60	3 x 40	S	200	12,40	10 x 70	S	50	97,00
5 x 36	S	200	28,00	4 x 6	S	200	8,50	10 x 80	S	50	111,00
6 x 16	S	500	22,70	4 x 8	S	200	8,60	10 x 90	S	50	124,00
6 x 20	S	500	23,60	4 x 10	S	200	8,60	10 x 100	S	50	138,00
6 x 24	S	500	27,50	4 x 12	S	200	8,80	12 x 10	S	50	310,00
6 x 30	S	500	32,50	4 x 14	S	200	9,20	12 x 16	S	50	265,00
6 x 40	S	250	41,50	4 x 16	S	200	9,20	12 x 20	S	50	148,00
6 x 45	S	200	46,00	4 x 18	S	200	9,20	12 x 24	S	50	157,00
6 x 50	S	250	51,00	4 x 20	S	200	9,60	12 x 26	S	50	160,00
8 x 20	S	500	103,00	4 x 22	S	200	9,60	12 x 28	S	50	164,00
8 x 40	S	500	144,00	4 x 24	S	200	9,90	12 x 30	S	50	157,00
8 x 50	S	250	146,00	4 x 26	S	200	10,20	12 x 32	S	50	174,00
				4 x 28	S	200	10,70	12 x 36	S	50	174,00
				4 x 30	S	200	11,20	12 x 40	S	50	181,00
				4 x 32	S	100	12,80	12 x 45	S	50	184,00
				4 x 36	S	100	13,20	12 x 50	S	50	189,00
				4 x 40	S	100	14,30	12 x 55	S	50	197,00
				4 x 45	S	100	15,30	12 x 60	S	50	204,00
				4 x 50	S	100	16,50	12 x 65	S	50	216,00
				5 x 5	S	200	9,90	12 x 70	S	50	223,00
				5 x 6	S	200	9,90	12 x 80	S	50	239,00
				5 x 8	S	200	10,10	12 x 100	S	25	580,00
				5 x 12	S	200	9,90	13 x 10	S	25	300,00
				5 x 14	S	200	11,10	13 x 12	S	25	290,00
				5 x 16	S	200	11,40	13 x 14	S	25	285,00
				5 x 18	S	200	12,10	13 x 16	S	25	275,00
				5 x 20	S	100	13,40	13 x 20	S	50	157,00
				5 x 22	S	100	14,60	13 x 22	S	50	160,00
				5 x 24	S	100	15,00	13 x 24	S	50	164,00
				5 x 26	S	100	15,50	13 x 26	S	50	167,00
				5 x 28	S	100	15,30	13 x 28	S	50	171,00
				5 x 30	S	100	15,50	13 x 30	S	50	177,00
				5 x 32	S	100	16,10	13 x 36	S	50	184,00
				5 x 36	S	100	17,10	13 x 40	S	50	200,00
				5 x 40	S	100	18,00	13 x 50	S	50	197,00
				5 x 45	S	100	19,40	13 x 70	S	50	232,00
				5 x 50	S	100	20,40	16 x 10	S	25	335,00
				5 x 60	S	100	24,50	16 x 12	S	25	320,00
				5 x 70	S	100	29,50	16 x 14	S	25	310,00
				5 x 80	S	100	36,00	16 x 16	S	25	300,00
				6 x 10	S	100	12,50	16 x 18	S	25	295,00
				6 x 12	S	100	12,80	16 x 20	S	50	197,00
				6 x 14	S	100	13,60	16 x 22	S	50	200,00
				6 x 16	S	100	13,80	16 x 24	S	50	204,00
				6 x 18	S	100	14,60	16 x 26	S	50	206,00
				6 x 20	S	100	15,50	16 x 28	S	50	210,00
				6 x 22	S	100	16,40	16 x 30	S	50	216,00
				6 x 24	S	100	17,20	16 x 32	S	50	221,00
				6 x 26	S	100	18,30	16 x 36	S	50	223,00
				6 x 28	S	100	19,30	16 x 40	S	50	227,00
				6 x 30	S	100	20,30	16 x 45	S	50	230,00
				6 x 32	S	100	21,30	16 x 50	S	50	233,00
				6 x 36	S	100	22,30	16 x 55	S	50	236,00
				6 x 40	S	100	23,50	16 x 60	S	25	249,00
				6 x 45	S	100	26,50	16 x 70	S	25	285,00
				6 x 50	S	100	28,00	16 x 120	S	25	950,00
				6 x 55	S	100	30,50	21 x 30	S	50	440,00
				6 x 60	S	100	33,00	21 x 36	S	25	445,00
				6 x 70	S	100	39,00	21 x 40	S	25	475,00
				6 x 80	S	100	44,50	21 x 45	S	25	510,00
				6 x 100	S	100	72,00	21 x 50	S	25	510,00
				10 x 10	S	50	74,00	21 x 60	S	25	560,00
				10 x 12	S	50	74,00	21 x 85	S	25	730,00

DIN 07346.000

7346 Federstahl



Spannstifte (Spannhülsen), leichte Ausführung

Maße → **TI-122** Normumstellung → **TI-10**

DIN 7346 → wird ersetzt durch ISO 13337 (austauschbar)



2 x 4	S	200	7,80
2 x 5	S	200	8,30
2 x 6	S	200	8,40
2 x 8	S	200	8,50
2 x 10	S	200	8,60
2 x 12	S	200	8,60
2 x 14	S	200	8,60
2 x 16	S	200	8,80
2 x 18	S	200	8,80
2 x 20	S	200	9,50
2 x 22	S	200	9,70
2 x 24	S	200	9,90
2 x 30	S	200	11,40
2,5 x 5	S	200	8,80
2,5 x 6	S	200	8,80
2,5 x 8	S	200	8,90
2,5 x 10	S	200	9,20
2,5 x 12	S	200	9,20
2,5 x 14	S	200	9,20
2,5 x 16	S	200	9,50
2,5 x 18	S	200	9,60
2,5 x 20	S	200	9,70
2,5 x 24	S	200	10,50
2,5 x 26	S	200	10,80
2,5 x 30	S	200	12,30
3 x 4	S	200	7,40
3 x 5	S	200	7,60
3 x 6	S	200	7,70
3 x 8	S	200	7,70

Abmessungen VE Stück €/100/Obf.
DIN 07349.000

7349 Stahl 100 HV



Scheiben für Schrauben mit schweren Spannstiften

Maße → **TI-85**
Rostfrei → **S. 571**



Innen Ø Außen Ø x Dicke

19	x	44	x	8	S	50	136,00
21	x	44	x	8	S	25	137,00
23	x	50	x	8	S	25	204,00
25	x	50	x	10	S	10	270,00
28	x	60	x	10	S	10	345,00
31	x	68	x	10	S	10	445,00

DIN 07349.010
7349 Stahl 100 HV galvanisch verzinkt



Scheiben für Schrauben mit schweren Spannstiften

Maße → **TI-85** Korrosionsschutz → **TI-228**
Rostfrei → **S. 571**



Innen Ø Außen Ø x Dicke

19	x	44	x	8	S	50	171,00 gal Zn
21	x	44	x	8	S	25	171,00 gal Zn
23	x	50	x	8	S	25	249,00 gal Zn
25	x	50	x	10	S	25	330,00 gal Zn
28	x	60	x	10	S	25	425,00 gal Zn
31	x	68	x	10	S	25	560,00 gal Zn

DIN 07349.080
7349 Stahl 100 HV galv. verz. 8 DiSP



Scheiben für Schrauben mit schweren Spannstiften

Maße → **TI-85** Korrosionsschutz → **TI-228**
Rostfrei → **S. 571**

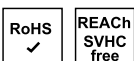

Innen Ø Außen Ø x Dicke

21	x	44	x	8	S	25	229,00 gal ZnDi
----	---	----	---	---	---	----	-----------------

Abmessungen VE Stück €/100/Obf.
DIN 07349.020

7349 Stahl 100 HV feuerverzinkt



Scheiben für Schrauben mit schweren Spannstiften

Maße → **TI-85** Korrosionsschutz → **TI-231**
Rostfrei → **S. 571**

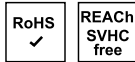

Innen Ø Außen Ø x Dicke

21	x	44	x	8	S	50	244,00 tZn
25	x	50	x	10	S	25	480,00 tZn
31	x	68	x	10	S	25	630,00 tZn

DIN 07349.001
7349 Stahl 200 HV



Scheiben für Schrauben mit schweren Spannstiften

Maße → **TI-85**

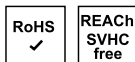

Innen Ø Außen Ø x Dicke

3,2	x	9	x	1	S	1000	1,55
4,3	x	12	x	1,6	S	1000	2,60
5,3	x	15	x	2	S	1000	4,60
6,4	x	17	x	3	S	1000	9,60
8,4	x	21	x	4	S	500	20,00
10,5	x	25	x	4	S	500	29,50
13	x	30	x	6	S	250	52,00
15	x	36	x	6	S	250	69,00
17	x	40	x	6	S	250	84,00

DIN 07349.011
7349 Stahl 200 HV galvanisch verzinkt



Scheiben für Schrauben mit schweren Spannstiften

Maße → **TI-85** Korrosionsschutz → **TI-228**



Innen Ø Außen Ø x Dicke

3,2	x	9	x	1	S	1000	1,65 gal Zn
4,3	x	12	x	1,6	S	1000	2,90 gal Zn
5,3	x	15	x	2	S	1000	5,30 gal Zn

Abmessungen VE Stück €/100/Obf.

6,4	x	17	x	3	S	1000	11,40 gal Zn
8,4	x	21	x	4	S	500	24,10 gal Zn
10,5	x	25	x	4	S	500	36,00 gal Zn
13	x	30	x	6	S	250	65,00 gal Zn
15	x	36	x	6	S	250	88,00 gal Zn
17	x	40	x	6	S	250	105,00 gal Zn

DIN 07349.081

7349 Stahl 200 HV galv. verz. 8 DiSP



Scheiben für Schrauben mit schweren Spannstiften

Maße → **TI-85** Korrosionsschutz → **TI-228**

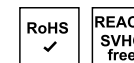

Innen Ø Außen Ø x Dicke

6,4	x	17	x	3	S	1000	14,40 gal ZnDi
8,4	x	21	x	4	S	500	34,00 gal ZnDi
10,5	x	25	x	4	S	500	41,50 gal ZnDi
13	x	30	x	6	S	250	88,00 gal ZnDi
17	x	40	x	6	S	250	143,00 gal ZnDi

DIN 07349.021

7349 Stahl 200 HV feuerverzinkt



Scheiben für Schrauben mit schweren Spannstiften

Maße → **TI-85** Korrosionsschutz → **TI-231**

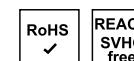

Innen Ø Außen Ø x Dicke

8,4	x	21	x	4	S	100	45,50 tZn
10,5	x	25	x	4	S	100	56,00 tZn
13	x	30	x	6	S	50	95,00 tZn
17	x	40	x	6	S	50	132,00 tZn

Abmessungen	VE Stück	€/100/Obf.
~ISO	07379.200	
7379	12.9	h8

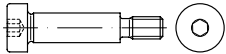

**Passschulter-schrauben,
Außen-Nennmaße = ISO 7379,
Schaftpassung h8**

Maße → **TI-13** Werkstoffeigensch. → **TI-232**



Schaft Ø / Gewinde M x Schaftlänge

6 - M 5 x 10	S	50	226,00
6 - M 5 x 12	S	50	233,00
6 - M 5 x 16	S	50	242,00
6 - M 5 x 20	S	50	265,00
6 - M 5 x 25	S	50	285,00
6 - M 5 x 30	S	50	305,00
8 - M 6 x 10	S	50	275,00
8 - M 6 x 12	S	50	275,00
8 - M 6 x 16	S	50	280,00
8 - M 6 x 20	S	50	285,00
8 - M 6 x 25	S	50	295,00
8 - M 6 x 30	S	50	305,00
8 - M 6 x 40	S	50	360,00
8 - M 6 x 45	S	50	415,00
8 - M 6 x 50	S	50	475,00
10 - M 8 x 10	S	50	340,00
10 - M 8 x 12	S	50	340,00
10 - M 8 x 16	S	50	345,00
10 - M 8 x 20	S	50	345,00
10 - M 8 x 25	S	50	355,00
10 - M 8 x 30	S	50	365,00
10 - M 8 x 40	S	50	380,00
10 - M 8 x 45	S	50	390,00
10 - M 8 x 50	S	50	390,00
10 - M 8 x 60	S	25	410,00
10 - M 8 x 70	S	25	430,00
10 - M 8 x 80	S	25	455,00
12 - M 10 x 12	S	25	485,00
12 - M 10 x 16	S	25	510,00
12 - M 10 x 20	S	25	530,00
12 - M 10 x 25	S	25	530,00
12 - M 10 x 30	S	25	540,00
12 - M 10 x 35	S	25	540,00
12 - M 10 x 40	S	25	550,00
12 - M 10 x 50	S	25	560,00
12 - M 10 x 60	S	25	570,00
12 - M 10 x 70	S	10	590,00
12 - M 10 x 80	S	10	600,00
12 - M 10 x 100	S	10	610,00
16 - M 12 x 20	S	25	780,00
16 - M 12 x 25	S	25	780,00
16 - M 12 x 30	S	25	820,00
16 - M 12 x 40	S	25	850,00
16 - M 12 x 50	S	25	890,00
16 - M 12 x 70	S	25	960,00
20 - M 16 x 40	S	10	2550,00
20 - M 16 x 50	S	10	2750,00
20 - M 16 x 60	S	10	2950,00
20 - M 16 x 70	S	10	3150,00
20 - M 16 x 80	S	10	3350,00

Abmessungen	VE Stück	€/100/Obf.
~ISO	07379.204	
7379	12.9	f9

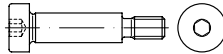

**Passschulter-schrauben,
Außen-Nennmaße = ISO 7379,
Schaftpassung f9**

Maße → **TI-13** Werkstoffeigensch. → **TI-232**

Rostfrei → **S. 572**



Schaft Ø / Gewinde M x Schaftlänge

6 - M 5 x 16	S	50	218,00
6 - M 5 x 20	S	50	235,00
6 - M 5 x 25	S	50	255,00
6 - M 5 x 30	S	50	275,00
8 - M 6 x 10	S	50	244,00
8 - M 6 x 12	S	50	244,00
8 - M 6 x 16	S	50	249,00
8 - M 6 x 20	S	50	255,00
8 - M 6 x 25	S	50	265,00
8 - M 6 x 30	S	50	275,00
8 - M 6 x 40	S	50	325,00
8 - M 6 x 45	S	50	425,00
8 - M 6 x 50	S	50	305,00
10 - M 8 x 10	S	50	305,00
10 - M 8 x 12	S	50	315,00
10 - M 8 x 16	S	50	315,00
10 - M 8 x 20	S	50	320,00
10 - M 8 x 25	S	50	330,00
10 - M 8 x 30	S	50	350,00
10 - M 8 x 40	S	50	350,00
10 - M 8 x 45	S	50	365,00
10 - M 8 x 50	S	50	385,00
10 - M 8 x 60	S	25	385,00
10 - M 8 x 70	S	25	440,00
10 - M 8 x 80	S	25	455,00
12 - M 10 x 12	S	25	470,00
12 - M 10 x 16	S	25	470,00
12 - M 10 x 20	S	25	480,00
12 - M 10 x 25	S	25	485,00
12 - M 10 x 30	S	25	495,00
12 - M 10 x 35	S	25	510,00
12 - M 10 x 40	S	25	520,00
12 - M 10 x 50	S	25	530,00
12 - M 10 x 60	S	25	540,00
12 - M 10 x 70	S	10	550,00
12 - M 10 x 80	S	10	700,00
12 - M 10 x 100	S	10	700,00
16 - M 12 x 20	S	25	730,00
16 - M 12 x 25	S	25	770,00
16 - M 12 x 30	S	25	800,00
16 - M 12 x 40	S	25	870,00
16 - M 12 x 50	S	25	2280,00
16 - M 12 x 70	S	25	2460,00
20 - M 16 x 40	S	10	2650,00
20 - M 16 x 50	S	10	2800,00
20 - M 16 x 60	S	10	3000,00
20 - M 16 x 70	S	10	3250,00
20 - M 16 x 80	S	10	3550,00

Abmessungen	VE Stück	€/100/Obf.
ISO	07380.100	
7380-1	010.9	

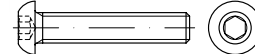

**Flachkopfschrauben
mit Innensechskant**

einige Fabrikate Gewinde bis Kopf

Achtung! Schrauben nur eingeschränkt belastbar.

Maße → **TI-14** Anziehmomente → **TI-246**

Werkstoffeigensch. → **TI-232**

Rostfrei → **S. 572**

Mit Innensechsrund-Antrieb → ~ ISO 7380 ISR

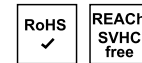

M 3 x 5	S	500	29,50
M 3 x 6	S	500	15,20
M 3 x 8	S	500	16,60
M 3 x 10	S	500	17,10
M 3 x 12	S	500	17,10
M 3 x 16	S	500	19,40
M 3 x 20	S	500	20,60
M 3 x 25	S	500	46,00
M 4 x 6	S	500	18,60
M 4 x 8	S	500	18,10
M 4 x 10	S	500	18,10
M 4 x 12	S	500	19,30
M 4 x 16	S	500	20,60
M 4 x 20	S	500	22,00
M 4 x 25	S	500	24,40
M 4 x 30	S	500	27,50
M 4 x 35	S	500	42,50
M 4 x 40	S	500	52,00
M 5 x 6	S	500	42,50
M 5 x 8	S	500	18,80
M 5 x 10	S	500	19,00
M 5 x 12	S	500	19,80
M 5 x 16	S	500	21,20
M 5 x 20	S	500	22,10
M 5 x 25	S	500	22,40
M 5 x 30	S	500	23,30
M 5 x 35	S	200	44,00
M 5 x 40	S	200	53,00
M 5 x 45	S	200	63,00
M 6 x 6	S	500	36,50
M 6 x 8	S	500	19,20
M 6 x 10	S	500	19,20
M 6 x 12	S	500	20,40
M 6 x 14	S	500	20,40
M 6 x 16	S	500	21,80
M 6 x 18	S	500	24,90
M 6 x 20	S	500	22,40
M 6 x 22	S	500	26,00
M 6 x 25	S	500	23,40
M 6 x 30	S	500	25,50
M 6 x 35	S	200	29,50
M 6 x 40	S	200	33,50
M 6 x 45	S	200	39,50
M 6 x 50	S	200	41,50
M 6 x 55	S	200	85,00
M 6 x 60	S	200	92,00
M 8 x 8	S	200	57,00
M 8 x 10	S	200	31,50
M 8 x 12	S	200	31,00

Abmessungen	VE	Stück	€/100/Obf.
M 8 x 16	S	200	30,50
M 8 x 20	S	200	26,00
M 8 x 25	S	200	27,00
M 8 x 30	S	200	29,50
M 8 x 35	S	200	34,50
M 8 x 40	S	200	42,50
M 8 x 45	S	200	56,00
M 8 x 50	S	200	53,00
M 8 x 55	S	200	88,00
M 8 x 60	S	200	88,00
M 10 x 12	S	200	111,00
M 10 x 16	S	200	69,00
M 10 x 20	S	200	63,00
M 10 x 25	S	200	68,00
M 10 x 30	S	200	73,00
M 10 x 35	S	100	78,00
M 10 x 40	S	100	83,00
M 10 x 45	S	100	88,00
M 10 x 50	S	100	92,00
M 10 x 55	S	100	136,00
M 10 x 60	S	100	155,00

ISO	07380.110
7380-1	010.9
galvanisch verzinkt	

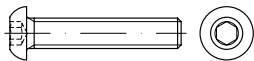

Flachkopfschrauben mit Innensechskant

einige Fabrikate Gewinde bis Kopf

Achtung! Schrauben nur eingeschränkt belastbar.
Achtung! Warneinblender zu Wasserstoffversprödung beachten.

Maße → **TI-14** Korrosionsschutz → **TI-228**
 Werkstoffeigensch. → **TI-232** Anziehmomente → **TI-246**

Rostfrei → **S. 572**

Mit Innensechsrund-Antrieb → ~ ISO 7380 ISR

RoHS	REACH SVHC free
✓	

M 3 x 5	S	500	33,00 gal Zn
M 3 x 6	S	500	18,70 gal Zn
M 3 x 8	S	500	19,30 gal Zn
M 3 x 10	S	500	17,40 gal Zn
M 3 x 12	S	500	17,40 gal Zn
M 3 x 16	S	500	19,70 gal Zn
M 3 x 20	S	500	21,10 gal Zn
M 3 x 25	S	500	47,00 gal Zn
M 3 x 30	S	500	47,50 gal Zn
M 4 x 5	S	500	18,60 gal Zn
M 4 x 6	S	500	18,60 gal Zn
M 4 x 8	S	500	18,30 gal Zn
M 4 x 10	S	500	18,40 gal Zn
M 4 x 12	S	500	19,70 gal Zn
M 4 x 16	S	500	21,30 gal Zn
M 4 x 20	S	500	22,70 gal Zn
M 4 x 25	S	500	25,50 gal Zn
M 4 x 30	S	500	31,00 gal Zn
M 4 x 40	S	500	55,00 gal Zn
M 5 x 6	S	500	43,00 gal Zn
M 5 x 8	S	500	19,40 gal Zn
M 5 x 10	S	500	19,30 gal Zn
M 5 x 12	S	500	20,30 gal Zn
M 5 x 14	S	500	30,50 gal Zn
M 5 x 16	S	500	21,60 gal Zn

Abmessungen	VE	Stück	€/100/Obf.
M 5 x 20	S	500	23,40 gal Zn
M 5 x 25	S	500	24,50 gal Zn
M 5 x 30	S	500	25,50 gal Zn
M 5 x 35	S	200	45,00 gal Zn
M 5 x 40	S	200	54,00 gal Zn
M 5 x 45	S	200	65,00 gal Zn
M 6 x 6	S	500	38,00 gal Zn
M 6 x 8	S	500	20,10 gal Zn
M 6 x 10	S	500	20,30 gal Zn
M 6 x 12	S	500	21,60 gal Zn
M 6 x 14	S	500	22,00 gal Zn
M 6 x 16	S	500	22,20 gal Zn
M 6 x 18	S	500	30,50 gal Zn
M 6 x 20	S	500	23,60 gal Zn
M 6 x 25	S	500	26,50 gal Zn
M 6 x 30	S	500	28,50 gal Zn
M 6 x 35	S	200	33,50 gal Zn
M 6 x 40	S	200	38,00 gal Zn
M 6 x 45	S	200	44,00 gal Zn
M 6 x 50	S	200	45,50 gal Zn
M 6 x 55	S	200	89,00 gal Zn
M 6 x 60	S	200	97,00 gal Zn
M 8 x 8	S	200	60,00 gal Zn
M 8 x 10	S	200	34,00 gal Zn
M 8 x 12	S	200	33,50 gal Zn
M 8 x 14	S	200	34,00 gal Zn
M 8 x 16	S	200	34,00 gal Zn
M 8 x 18	S	200	34,00 gal Zn
M 8 x 20	S	200	30,50 gal Zn
M 8 x 25	S	200	32,50 gal Zn
M 8 x 30	S	200	36,50 gal Zn
M 8 x 35	S	200	42,50 gal Zn
M 8 x 40	S	200	51,00 gal Zn
M 8 x 45	S	200	60,00 gal Zn
M 8 x 50	S	200	63,00 gal Zn
M 8 x 55	S	200	99,00 gal Zn
M 8 x 60	S	200	99,00 gal Zn
M 10 x 12	S	200	121,00 gal Zn
M 10 x 16	S	200	80,00 gal Zn
M 10 x 20	S	200	74,00 gal Zn
M 10 x 25	S	200	79,00 gal Zn
M 10 x 30	S	200	85,00 gal Zn
M 10 x 35	S	100	91,00 gal Zn
M 10 x 40	S	100	99,00 gal Zn
M 10 x 45	S	100	99,00 gal Zn
M 10 x 50	S	100	103,00 gal Zn
M 10 x 55	S	100	148,00 gal Zn
M 10 x 60	S	100	167,00 gal Zn
M 12 x 14	S	100	255,00 gal Zn
M 12 x 16	S	100	230,00 gal Zn
M 12 x 20	S	100	177,00 gal Zn
M 12 x 25	S	100	171,00 gal Zn
M 12 x 30	S	100	190,00 gal Zn
M 12 x 35	S	100	167,00 gal Zn
M 12 x 40	S	100	229,00 gal Zn
M 12 x 45	S	100	249,00 gal Zn
M 12 x 50	S	100	270,00 gal Zn
M 12 x 60	S	100	290,00 gal Zn
M 16 x 30	S	100	425,00 gal Zn
M 16 x 40	S	100	440,00 gal Zn
M 16 x 45	S	50	450,00 gal Zn
M 16 x 50	S	50	460,00 gal Zn
M 16 x 60	S	50	475,00 gal Zn

Abmessungen	VE	Stück	€/100/Obf.
~ISO		07380.114	
7380-1		010.9	ISR
galvanisch verzinkt			

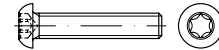

Flachkopfschrauben, ISR = Innensechsrund

~DIN 34805-1

Achtung! Schrauben nur eingeschränkt belastbar.

Achtung! Warneinblender zu Wasserstoffversprödung beachten.

Maße → **TI-14** Korrosionsschutz → **TI-228**
 Werkstoffeigensch. → **TI-232** Anziehmomente → **TI-246**

Rostfrei → **S. 572**

RoHS	REACH SVHC free
✓	

M 4 x 6-T20	S	500	20,30 gal Zn
M 4 x 8-T20	S	500	20,30 gal Zn
M 4 x 10-T20	S	500	20,50 gal Zn
M 4 x 12-T20	S	500	21,80 gal Zn
M 4 x 16-T20	S	500	23,60 gal Zn
M 4 x 20-T20	S	500	25,50 gal Zn
M 5 x 8-T25	S	500	19,40 gal Zn
M 5 x 10-T25	S	500	19,50 gal Zn
M 5 x 12-T25	S	500	20,50 gal Zn
M 5 x 16-T25	S	500	22,90 gal Zn
M 5 x 20-T25	S	500	26,00 gal Zn
M 5 x 25-T25	S	500	27,50 gal Zn
M 5 x 30-T25	S	500	28,50 gal Zn
M 5 x 35-T25	S	500	30,50 gal Zn
M 6 x 16-T30	S	500	25,50 gal Zn
M 6 x 20-T30	S	500	26,50 gal Zn
M 6 x 25-T30	S	500	29,00 gal Zn
M 8 x 12-T40	S	200	36,50 gal Zn
M 8 x 16-T40	S	200	38,00 gal Zn
M 8 x 20-T40	S	200	33,50 gal Zn
M 8 x 25-T40	S	200	36,00 gal Zn
M 8 x 30-T40	S	200	40,00 gal Zn
M 8 x 35-T40	S	200	42,50 gal Zn

Wichtiger Hinweis!

Bei galvanischen Überzügen auf hochfesten und federharten Teilen ($\geq 1000 \text{ N/mm}^2$ oder $\geq 320 \text{ HV}$) ist die Gefahr einer Wasserstoffversprödung (Sprödbruchgefahr) nicht mit Sicherheit auszuschließen (ISO 4042). Durch eine rechtzeitig eingeleitete thermische Nachbehandlung (Tempern) kann die Gefahr eines wasserstoffinduzierten Sprödbruchs im Regelfall verringert werden. Da aber ein Restrisiko nicht mit Sicherheit auszuschließen ist, erfolgen galvanische Überzüge auf derartigen Teilen nur auf ausdrücklichen Wunsch und auf Risiko des Auftraggebers.



Abmessungen	VE Stück	€/100/Obf.
ISO	07380.102	

7380-2 010.9

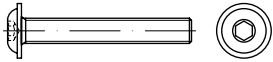

Flachkopfschrauben mit Innensechskant und Bund

einige Fabrikate mit Gewinde bis Kopf

Achtung! Schrauben nur eingeschränkt belastbar.

Maße → **TI-14** Anziehmomente → **TI-246**
 Werkstoffeigensch. → **TI-232**
 Rostfrei → **S. 573**

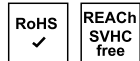

M 4	x	6	S	500	22,70
M 4	x	8	S	500	22,00
M 4	x	10	S	500	21,10
M 4	x	12	S	500	22,30
M 4	x	16	S	500	23,40
M 4	x	20	S	500	24,60
M 4	x	25	S	500	29,00
M 4	x	30	S	500	33,50
M 5	x	6	S	500	48,00
M 5	x	8	S	500	23,20
M 5	x	10	S	500	22,30
M 5	x	12	S	500	23,20
M 5	x	16	S	500	27,50
M 5	x	20	S	500	28,00
M 5	x	25	S	500	28,50
M 5	x	30	S	500	33,00
M 5	x	35	S	200	37,00
M 6	x	6	S	500	111,00
M 6	x	8	S	500	27,00
M 6	x	10	S	500	25,50
M 6	x	12	S	500	27,50
M 6	x	16	S	500	28,50
M 6	x	20	S	500	29,00
M 6	x	25	S	500	29,50
M 6	x	30	S	500	31,50
M 6	x	35	S	500	33,00
M 6	x	40	S	500	41,50
M 8	x	12	S	200	39,50
M 8	x	16	S	200	39,50
M 8	x	20	S	200	38,50
M 8	x	25	S	200	41,50
M 8	x	30	S	200	44,00
M 8	x	35	S	200	54,00
M 8	x	40	S	200	70,00
M 8	x	50	S	200	101,00
M 8	x	60	S	200	128,00
M 10	x	20	S	200	77,00
M 10	x	25	S	200	94,00
M 10	x	30	S	200	107,00
M 10	x	35	S	100	119,00

Abmessungen	VE Stück	€/100/Obf.
ISO	07380.112	

7380-2 010.9 galvanisch verzinkt

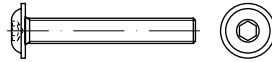

Flachkopfschrauben mit Innensechskant und Bund

einige Fabrikate mit Gewinde bis Kopf

Achtung! Schrauben nur eingeschränkt belastbar.

Achtung! Warneinblender zu Wasserstoffversprödung beachten.
 Maße → **TI-14** Korrosionsschutz → **TI-228**
 Werkstoffeigensch. → **TI-232** Anziehmomente → **TI-246**

Rostfrei → **S. 573**



M 3	x	6	S	500	20,00 gal Zn
M 3	x	8	S	500	20,00 gal Zn
M 3	x	10	S	500	20,00 gal Zn
M 3	x	12	S	500	22,40 gal Zn
M 4	x	6	S	500	26,50 gal Zn
M 4	x	8	S	500	22,70 gal Zn
M 4	x	10	S	500	22,10 gal Zn
M 4	x	12	S	500	23,60 gal Zn
M 4	x	16	S	500	25,00 gal Zn
M 4	x	20	S	500	34,00 gal Zn
M 4	x	25	S	500	40,00 gal Zn
M 4	x	30	S	500	45,50 gal Zn
M 5	x	6	S	500	44,00 gal Zn
M 5	x	8	S	500	24,40 gal Zn
M 5	x	10	S	500	23,60 gal Zn
M 5	x	12	S	500	24,60 gal Zn
M 5	x	16	S	500	29,50 gal Zn
M 5	x	20	S	500	30,00 gal Zn
M 5	x	25	S	500	35,50 gal Zn
M 5	x	30	S	500	41,00 gal Zn
M 5	x	35	S	200	46,00 gal Zn
M 6	x	8	S	500	28,50 gal Zn
M 6	x	10	S	500	27,50 gal Zn
M 6	x	12	S	500	29,50 gal Zn
M 6	x	14	S	500	27,50 gal Zn
M 6	x	16	S	500	31,50 gal Zn
M 6	x	20	S	500	33,00 gal Zn
M 6	x	25	S	500	34,00 gal Zn
M 6	x	30	S	500	35,50 gal Zn
M 6	x	35	S	500	37,00 gal Zn
M 6	x	40	S	500	41,50 gal Zn
M 6	x	45	S	200	45,00 gal Zn
M 6	x	50	S	200	45,50 gal Zn
M 6	x	60	S	200	50,00 gal Zn
M 8	x	10	S	200	51,00 gal Zn
M 8	x	12	S	200	44,50 gal Zn
M 8	x	14	S	200	44,50 gal Zn
M 8	x	16	S	200	44,50 gal Zn
M 8	x	20	S	200	44,00 gal Zn
M 8	x	25	S	200	47,50 gal Zn
M 8	x	30	S	200	51,00 gal Zn
M 8	x	35	S	200	63,00 gal Zn
M 8	x	40	S	200	66,00 gal Zn
M 8	x	45	S	200	72,00 gal Zn
M 8	x	50	S	200	78,00 gal Zn
M 8	x	60	S	200	84,00 gal Zn
M 10	x	20	S	200	92,00 gal Zn
M 10	x	30	S	200	130,00 gal Zn
M 10	x	35	S	100	136,00 gal Zn

Abmessungen	VE Stück	€/100/Obf.
-------------	----------	------------

M 10	x	40	S	100	142,00 gal Zn
M 10	x	50	S	100	148,00 gal Zn
M 12	x	20	S	100	189,00 gal Zn
M 12	x	25	S	100	204,00 gal Zn
M 12	x	30	S	100	216,00 gal Zn
M 12	x	40	S	100	236,00 gal Zn
M 12	x	50	S	100	255,00 gal Zn
M 12	x	60	S	100	270,00 gal Zn

Wichtiger Hinweis!

Bei galvanischen Überzügen auf hochfesten und federharten Teilen ($\geq 1000 \text{ N/mm}^2$ oder $\geq 320 \text{ HV}$) ist die Gefahr einer Wasserstoffversprödung (Spröbruchgefahr) nicht mit Sicherheit auszuschließen (ISO 4042). Durch eine rechtzeitig eingeleitete thermische Nachbehandlung (Tempern) kann die Gefahr eines wasserstoffinduzierten Spröbruchs im Regelfall verringert werden. Da aber ein Restrisiko nicht mit Sicherheit auszuschließen ist, erfolgen galvanische Überzüge auf derartigen Teilen nur auf ausdrücklichen Wunsch und auf Risiko des Auftraggebers.

~ISO	07380.349
------	-----------

7380-2 010.9 galvanisch verzinkt



Flachkopfschrauben mit Bund, ISR = Innensechsrund

einige Fabrikate mit Gewinde bis Kopf
 ~DIN 34805-2

Achtung! Schrauben nur eingeschränkt belastbar.

Achtung! Warneinblender zu Wasserstoffversprödung beachten.

Maße → **TI-14** Korrosionsschutz → **TI-228**
 Werkstoffeigensch. → **TI-232** Anziehmomente → **TI-246**

Rostfrei → **S. 573**

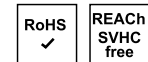

M 3	x	6 -T10	S	500	21,80 gal Zn
M 3	x	8 -T10	S	500	21,80 gal Zn
M 3	x	10 -T10	S	500	21,80 gal Zn
M 3	x	12 -T10	S	500	24,20 gal Zn
M 3	x	20 -T10	S	500	25,50 gal Zn
M 4	x	6 -T20	S	500	29,50 gal Zn
M 4	x	8 -T20	S	500	25,50 gal Zn
M 4	x	10 -T20	S	500	24,20 gal Zn
M 4	x	12 -T20	S	500	25,50 gal Zn
M 4	x	16 -T20	S	500	28,00 gal Zn
M 4	x	20 -T20	S	500	38,00 gal Zn
M 4	x	30 -T20	S	500	50,00 gal Zn
M 5	x	6 -T25	S	500	48,50 gal Zn
M 5	x	8 -T25	S	500	27,00 gal Zn
M 5	x	10 -T25	S	500	25,50 gal Zn
M 5	x	12 -T25	S	500	27,00 gal Zn
M 5	x	16 -T25	S	500	31,50 gal Zn
M 5	x	20 -T25	S	500	33,00 gal Zn
M 5	x	25 -T25	S	500	39,00 gal Zn
M 5	x	30 -T25	S	500	45,00 gal Zn

Abmessungen	VE	Stück	€/100/Obf.
M 5 x 35 -T25	S	200	51,00 gal Zn
M 6 x 6 -T30	S	500	25,50 gal Zn
M 6 x 10 -T30	S	500	30,50 gal Zn
M 6 x 12 -T30	S	500	33,00 gal Zn
M 6 x 16 -T30	S	500	35,50 gal Zn
M 6 x 20 -T30	S	500	36,50 gal Zn
M 6 x 25 -T30	S	500	38,00 gal Zn
M 6 x 30 -T30	S	500	39,00 gal Zn
M 6 x 40 -T30	S	200	45,00 gal Zn
M 6 x 50 -T30	S	200	50,00 gal Zn
M 8 x 10 -T40	S	200	56,00 gal Zn
M 8 x 12 -T40	S	200	48,50 gal Zn
M 8 x 16 -T40	S	200	48,50 gal Zn
M 8 x 20 -T40	S	200	48,50 gal Zn
M 8 x 25 -T40	S	200	53,00 gal Zn
M 8 x 30 -T40	S	200	56,00 gal Zn
M 8 x 35 -T40	S	200	69,00 gal Zn
M 8 x 40 -T40	S	200	72,00 gal Zn
M 8 x 50 -T40	S	200	85,00 gal Zn

ISO 07434.000

7434 14 H



Gewindestifte mit Schlitz und Spitze

Maße → **TI-19** Normumstellung → **TI-6**
 Werkstoffeigensch. → **TI-232** REACH → **TI-262**

Rostfrei → **S. 573**
 Messing → **S. 641**

ISO 7434 → ersetzt DIN 553 (austauschbar)



M 1,6 x 2	K	100	12,10
M 1,6 x 3	K	100	12,10
M 2 x 3	K	200	10,60
M 2 x 4	K	200	10,70
M 2 x 5	K	200	10,80
M 2 x 6	K	200	11,10
M 2 x 12	K	200	12,40
M 2,5 x 3	K	200	11,20
M 2,5 x 4	K	200	10,80
M 2,5 x 5	K	200	11,10
M 2,5 x 6	K	200	11,20
M 2,5 x 8	K	200	11,30
M 2,5 x 10	K	200	11,80
M 2,5 x 12	K	200	12,60
M 3 x 3	K	200	8,40
M 3 x 4	S	1000	4,15
M 3 x 4	K	200	5,00
M 3 x 5	S	1000	3,95
M 3 x 5	K	200	4,85
M 3 x 6	S	1000	4,10
M 3 x 6	K	200	5,30
M 3 x 8	S	1000	4,15
M 3 x 8	K	200	5,40
M 3 x 10	S	1000	4,15
M 3 x 10	K	200	5,70
M 3 x 12	K	200	5,50
M 3 x 16	K	200	9,10
M 3 x 20	K	200	12,90
M 4 x 4	S	1000	4,15
M 4 x 4	K	200	6,90
M 4 x 5	S	1000	4,30
M 4 x 5	K	200	5,30
M 4 x 6	S	1000	4,30

Abmessungen	VE	Stück	€/100/Obf.
M 4 x 6	K	200	5,30
M 4 x 8	S	1000	4,30
M 4 x 8	K	200	5,30
M 4 x 10	S	1000	4,60
M 4 x 10	K	200	5,50
M 4 x 12	S	1000	4,85
M 4 x 12	K	200	5,90
M 4 x 16	K	200	6,30
M 4 x 20	K	200	7,20
M 4 x 30	K	200	9,40
M 5 x 5	S	1000	4,85
M 5 x 5	K	200	8,20
M 5 x 6	S	1000	4,85
M 5 x 6	K	200	9,00
M 5 x 8	S	1000	5,30
M 5 x 8	K	200	6,20
M 5 x 10	S	1000	5,90
M 5 x 10	K	200	6,80
M 5 x 12	S	1000	6,20
M 5 x 12	K	200	8,60
M 5 x 16	S	1000	7,90
M 5 x 16	K	200	8,80
M 5 x 20	K	200	9,20
M 5 x 25	K	200	9,70
M 6 x 5	K	200	9,40
M 6 x 6	S	1000	8,20
M 6 x 6	K	200	7,20
M 6 x 8	S	1000	6,30
M 6 x 8	K	200	7,40
M 6 x 10	S	1000	6,70
M 6 x 10	K	200	7,70
M 6 x 12	S	1000	7,20
M 6 x 12	K	200	7,90
M 6 x 16	S	1000	8,20
M 6 x 16	K	200	9,60
M 6 x 20	S	1000	9,10
M 6 x 20	K	200	9,90
M 6 x 25	S	1000	10,50
M 6 x 25	K	100	12,50
M 6 x 30	K	100	13,80
M 6 x 40	K	100	39,00
M 8 x 8	K	100	16,40
M 8 x 10	S	1000	8,40
M 8 x 10	K	100	13,50
M 8 x 12	S	1000	9,70
M 8 x 12	K	100	11,80
M 8 x 16	S	1000	10,30
M 8 x 16	K	100	12,50
M 8 x 18	K	100	14,30
M 8 x 20	S	1000	12,60
M 8 x 20	K	100	14,70
M 8 x 25	S	1000	14,10
M 8 x 25	K	100	18,20
M 8 x 30	K	100	19,70
M 8 x 40	K	100	33,00
M 8 x 50	K	100	68,00
M 10 x 10	K	100	23,20
M 10 x 12	K	100	23,50
M 10 x 16	K	100	25,00
M 10 x 20	K	100	27,50
M 10 x 25	K	100	30,00
M 10 x 30	K	100	32,50
M 10 x 35	K	100	34,50
M 10 x 40	K	100	53,00
M 10 x 60	K	100	78,00

Abmessungen VE Stück €/100/Obf.
 ISO 07435.000

7435 14 H



Gewindestifte mit Schlitz und Zapfen

Maße → **TI-19** Normumstellung → **TI-6**
 Werkstoffeigensch. → **TI-232** REACH → **TI-262**

ISO 7435 → ersetzt DIN 417 (austauschbar)



M 3 x 5	S	100	17,00
M 3 x 6	S	100	11,10
M 3 x 8	S	100	11,40
M 3 x 10	S	100	14,40
M 3 x 12	S	100	15,10
M 4 x 5	S	100	23,50
M 4 x 6	S	100	18,80
M 4 x 8	S	100	11,80
M 4 x 10	S	100	12,10
M 4 x 12	S	100	16,00
M 4 x 16	S	100	13,70
M 5 x 8	S	100	13,50
M 5 x 10	S	100	14,60
M 5 x 12	S	100	15,10
M 5 x 16	S	100	18,10
M 5 x 20	S	100	23,50
M 5 x 25	S	100	24,70
M 6 x 8	S	100	15,40
M 6 x 10	S	100	16,00
M 6 x 12	S	100	16,70
M 6 x 16	S	100	18,60
M 6 x 20	S	100	20,20
M 6 x 25	S	100	22,60
M 6 x 30	S	100	31,50
M 8 x 10	S	100	38,00
M 8 x 12	S	100	21,60
M 8 x 16	S	100	22,40
M 8 x 20	S	100	27,00
M 8 x 25	S	100	29,50
M 8 x 30	S	100	36,00
M 8 x 35	S	100	51,00
M 8 x 40	S	100	69,00
M 10 x 12	S	50	77,00
M 10 x 16	S	50	50,00
M 10 x 20	S	50	69,00
M 10 x 25	S	50	59,00
M 10 x 30	S	50	78,00
M 10 x 35	S	50	85,00
M 10 x 40	S	50	90,00
M 10 x 50	S	50	160,00
M 12 x 20	S	50	109,00
M 12 x 25	S	50	118,00
M 12 x 40	S	50	148,00
M 12 x 50	S	50	165,00

Abmessungen	VE Stück	€/100/Obf.
DIN 7500	07500.014	
7500 Stahl Form C-Z galvanisch verzinkt		

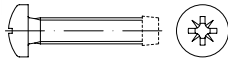

Gewindefurchende Schrauben, mit metrischem Gewinde, C = Linsenkopf nach DIN 7985 Z = mit Pozidriv-Kreuzschlitz Z gehärtet

Maße → **TI-41**

Korrosionsschutz → **TI-228**

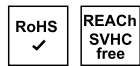

CM 2	x	5 -Z	S	1000	5,80 gal Zn
CM 2	x	6 -Z	S	1000	5,70 gal Zn
CM 2	x	8 -Z	S	1000	5,90 gal Zn
CM 2	x	10 -Z	S	1000	9,10 gal Zn
CM 2	x	12 -Z	S	1000	10,30 gal Zn
CM 2,5	x	4 -Z	S	1000	5,80 gal Zn
CM 2,5	x	5 -Z	S	1000	5,90 gal Zn
CM 2,5	x	6 -Z	S	1000	6,00 gal Zn
CM 2,5	x	8 -Z	S	1000	6,20 gal Zn
CM 2,5	x	10 -Z	S	1000	6,50 gal Zn
CM 2,5	x	12 -Z	S	1000	6,50 gal Zn
CM 2,5	x	16 -Z	S	1000	6,80 gal Zn
CM 2,5	x	20 -Z	S	1000	6,90 gal Zn
CM 3	x	4 -Z	S	1000	11,90 gal Zn
CM 3	x	5 -Z	S	2000	12,80 gal Zn
CM 3	x	6 -Z	S	2000	12,80 gal Zn
CM 3	x	8 -Z	S	2000	13,00 gal Zn
CM 3	x	10 -Z	S	2000	13,60 gal Zn
CM 3	x	12 -Z	S	1000	14,00 gal Zn
CM 3	x	16 -Z	S	1000	14,20 gal Zn
CM 3	x	20 -Z	S	1000	14,40 gal Zn
CM 3	x	25 -Z	S	1000	14,70 gal Zn
CM 3	x	30 -Z	S	1000	15,80 gal Zn
CM 3,5	x	6 -Z	S	1000	17,00 gal Zn
CM 3,5	x	8 -Z	S	1000	17,00 gal Zn
CM 3,5	x	10 -Z	S	1000	21,20 gal Zn
CM 3,5	x	12 -Z	S	1000	22,10 gal Zn
CM 3,5	x	16 -Z	S	1000	23,00 gal Zn
CM 4	x	6 -Z	S	2000	16,90 gal Zn
CM 4	x	8 -Z	S	2000	16,90 gal Zn
CM 4	x	10 -Z	S	2000	18,00 gal Zn
CM 4	x	12 -Z	S	2000	20,00 gal Zn
CM 4	x	16 -Z	S	2000	21,80 gal Zn
CM 4	x	20 -Z	S	2000	22,90 gal Zn
CM 4	x	25 -Z	S	1000	25,50 gal Zn
CM 4	x	30 -Z	S	1000	26,00 gal Zn
CM 4	x	35 -Z	S	1000	30,50 gal Zn
CM 4	x	40 -Z	S	1000	36,50 gal Zn
CM 5	x	6 -Z	S	1000	22,60 gal Zn
CM 5	x	8 -Z	S	2000	24,00 gal Zn
CM 5	x	10 -Z	S	2000	24,00 gal Zn
CM 5	x	12 -Z	S	1000	26,00 gal Zn
CM 5	x	16 -Z	S	1000	28,50 gal Zn
CM 5	x	20 -Z	S	1000	31,00 gal Zn
CM 5	x	25 -Z	S	1000	34,50 gal Zn
CM 5	x	30 -Z	S	1000	34,50 gal Zn
CM 5	x	35 -Z	S	500	42,50 gal Zn
CM 5	x	40 -Z	S	500	51,00 gal Zn
CM 6	x	8 -Z	S	500	28,50 gal Zn
CM 6	x	10 -Z	S	1000	41,00 gal Zn
CM 6	x	12 -Z	S	1000	51,00 gal Zn
CM 6	x	16 -Z	S	1000	45,50 gal Zn
CM 6	x	20 -Z	S	1000	48,50 gal Zn

Abmessungen	VE Stück	€/100/Obf.			
CM 6	x	25 -Z	S	500	49,50 gal Zn
CM 6	x	30 -Z	S	500	50,00 gal Zn
CM 6	x	35 -Z	S	500	51,00 gal Zn
CM 6	x	40 -Z	S	500	52,00 gal Zn
CM 8	x	16 -Z	S	250	66,00 gal Zn
CM 8	x	20 -Z	S	250	72,00 gal Zn
CM 8	x	25 -Z	S	250	78,00 gal Zn
CM 8	x	30 -Z	S	250	85,00 gal Zn
CM 8	x	35 -Z	S	250	92,00 gal Zn
CM 8	x	40 -Z	S	100	107,00 gal Zn

Abmessungen	VE Stück	€/100/Obf.
DIN 7500	07500.017	
7500 Stahl Form CE-ISR/PE galvanisch verzinkt		

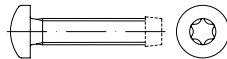

Gewindefurchende Schrauben, mit metrischem Gewinde, CE/PE = Linsenkopf nach ISO 14583 ISR = Innensechsrund gehärtet

Maße → **TI-41**

Korrosionsschutz → **TI-228**

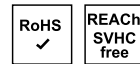

CEM 3	x	4-T10	S	1000	15,20 gal Zn
CEM 3	x	5-T10	S	1000	15,20 gal Zn
CEM 3	x	6-T10	S	1000	15,30 gal Zn
CEM 3	x	8-T10	S	1000	15,50 gal Zn
CEM 3	x	10-T10	S	1000	16,30 gal Zn
CEM 3	x	12-T10	S	1000	16,70 gal Zn
CEM 3	x	16-T10	S	1000	17,00 gal Zn
CEM 3	x	20-T10	S	1000	17,40 gal Zn
CEM 3	x	25-T10	S	1000	30,50 gal Zn
CEM 4	x	6-T20	S	1000	20,30 gal Zn
CEM 4	x	8-T20	S	1000	20,60 gal Zn
CEM 4	x	10-T20	S	1000	21,60 gal Zn
CEM 4	x	12-T20	S	1000	24,00 gal Zn
CEM 4	x	16-T20	S	1000	26,50 gal Zn
CEM 4	x	20-T20	S	1000	27,50 gal Zn
CEM 4	x	25-T20	S	1000	30,50 gal Zn
CEM 4	x	30-T20	S	1000	31,00 gal Zn
CEM 4	x	35-T20	S	1000	36,50 gal Zn
CEM 5	x	6-T25	S	1000	27,50 gal Zn
CEM 5	x	8-T25	S	1000	29,00 gal Zn
CEM 5	x	10-T25	S	1000	30,00 gal Zn
CEM 5	x	12-T25	S	1000	31,00 gal Zn
CEM 5	x	16-T25	S	1000	34,50 gal Zn
CEM 5	x	20-T25	S	1000	37,00 gal Zn
CEM 5	x	25-T25	S	1000	42,00 gal Zn
CEM 5	x	30-T25	S	500	44,00 gal Zn
CEM 5	x	35-T25	S	1000	47,00 gal Zn
CEM 5	x	40-T25	S	1000	53,00 gal Zn
CEM 6	x	8-T30	S	1000	49,50 gal Zn
CEM 6	x	10-T30	S	1000	49,50 gal Zn
CEM 6	x	12-T30	S	500	54,00 gal Zn
CEM 6	x	16-T30	S	500	55,00 gal Zn
CEM 6	x	20-T30	S	500	59,00 gal Zn
CEM 6	x	25-T30	S	500	59,00 gal Zn
CEM 6	x	30-T30	S	500	60,00 gal Zn
CEM 6	x	35-T30	S	500	61,00 gal Zn
CEM 6	x	40-T30	S	500	62,00 gal Zn
CEM 6	x	45-T30	S	500	71,00 gal Zn
CEM 6	x	50-T30	S	500	83,00 gal Zn
CEM 8	x	12-T45	S	500	63,00 gal Zn
CEM 8	x	16-T45	S	500	66,00 gal Zn
CEM 8	x	20-T45	S	500	72,00 gal Zn

Abmessungen	VE Stück	€/100/Obf.			
CEM 8	x	25-T45	S	500	78,00 gal Zn
CEM 8	x	30-T45	S	100	85,00 gal Zn
CEM 8	x	35-T45	S	100	92,00 gal Zn
CEM 8	x	40-T45	S	100	107,00 gal Zn
CEM 8	x	45-T45	S	100	119,00 gal Zn
CEM 8	x	50-T45	S	100	135,00 gal Zn
CEM 8	x	60-T45	S	250	200,00 gal Zn

Abmessungen	VE Stück	€/100/Obf.
~DIN 7500	07500.015	
7500 Stahl ~Form D galvanisch verzinkt		



Gewindefurchende Schrauben, mit metrischem Gewinde, ~D = Sechskant-Flanschkopf gehärtet

Maße → **TI-41**

Korrosionsschutz → **TI-228**

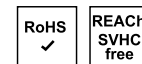

DM 4	x	6	S	1000	12,10 gal Zn
DM 4	x	8	S	1000	10,20 gal Zn
DM 4	x	10	S	1000	10,60 gal Zn
DM 4	x	12	S	1000	11,30 gal Zn
DM 4	x	16	S	1000	12,40 gal Zn
DM 4	x	20	S	1000	13,60 gal Zn
DM 4	x	25	S	1000	17,00 gal Zn
DM 4	x	30	S	1000	23,60 gal Zn
DM 5	x	8	S	1000	14,70 gal Zn
DM 5	x	10	S	1000	16,10 gal Zn
DM 5	x	12	S	1000	17,00 gal Zn
DM 5	x	16	S	1000	18,10 gal Zn
DM 5	x	20	S	1000	19,20 gal Zn
DM 5	x	25	S	1000	22,20 gal Zn
DM 5	x	30	S	1000	26,00 gal Zn
DM 5	x	35	S	1000	30,50 gal Zn
DM 5	x	40	S	1000	39,00 gal Zn
DM 6	x	8	S	1000	29,00 gal Zn
DM 6	x	10	S	1000	31,00 gal Zn
DM 6	x	12	S	1000	31,50 gal Zn
DM 6	x	16	S	1000	33,00 gal Zn
DM 6	x	20	S	1000	33,00 gal Zn
DM 6	x	25	S	1000	34,00 gal Zn
DM 6	x	30	S	1000	37,00 gal Zn
DM 6	x	35	S	500	42,50 gal Zn
DM 6	x	40	S	500	51,00 gal Zn
DM 6	x	45	S	500	67,00 gal Zn
DM 6	x	50	S	500	84,00 gal Zn
DM 8	x	12	S	500	59,00 gal Zn
DM 8	x	16	S	500	55,00 gal Zn
DM 8	x	20	S	500	59,00 gal Zn
DM 8	x	25	S	500	67,00 gal Zn
DM 8	x	30	S	500	74,00 gal Zn
DM 8	x	35	S	500	85,00 gal Zn
DM 8	x	40	S	500	88,00 gal Zn
DM 8	x	45	S	500	109,00 gal Zn
DM 8	x	50	S	250	112,00 gal Zn
DM 8	x	60	S	500	167,00 gal Zn

Abmessungen	VE Stück	€/100/Obf.
~DIN	07500.018	
7500	Stahl	Form E
	galvanisch verzinkt	

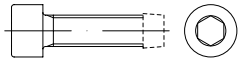

Gewindefurchende Schrauben, mit metrischem Gewinde, E = Zylinderkopf*

*nach DIN 912 gehärtet

Maße → **TI-41**

Korrosionsschutz → **TI-228**

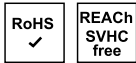

EM 4	x	6	S	2000	18,20 gal Zn
EM 4	x	8	S	2000	18,90 gal Zn
EM 4	x	10	S	2000	20,50 gal Zn
EM 4	x	12	S	2000	22,40 gal Zn
EM 4	x	16	S	2000	24,40 gal Zn
EM 4	x	20	S	1000	26,50 gal Zn
EM 4	x	25	S	1000	30,00 gal Zn
EM 4	x	30	S	1000	34,00 gal Zn
EM 4	x	35	S	1000	42,50 gal Zn
EM 4	x	40	S	500	55,00 gal Zn
EM 4	x	45	S	500	71,00 gal Zn
EM 5	x	8	S	2000	22,10 gal Zn
EM 5	x	10	S	2000	24,20 gal Zn
EM 5	x	12	S	2000	27,00 gal Zn
EM 5	x	16	S	2000	30,00 gal Zn
EM 5	x	20	S	1000	33,00 gal Zn
EM 5	x	25	S	1000	38,00 gal Zn
EM 5	x	30	S	1000	43,50 gal Zn
EM 5	x	35	S	1000	65,00 gal Zn
EM 5	x	40	S	500	58,00 gal Zn
EM 6	x	8	S	1000	44,00 gal Zn
EM 6	x	10	S	1000	48,00 gal Zn
EM 6	x	12	S	1000	53,00 gal Zn
EM 6	x	16	S	1000	59,00 gal Zn
EM 6	x	20	S	1000	135,00 gal Zn
EM 6	x	25	S	1000	74,00 gal Zn
EM 6	x	30	S	500	85,00 gal Zn
EM 6	x	35	S	250	98,00 gal Zn
EM 6	x	40	S	250	113,00 gal Zn
EM 6	x	45	S	250	130,00 gal Zn
EM 6	x	50	S	250	150,00 gal Zn
EM 8	x	30	S	250	300,00 gal Zn
EM 8	x	35	S	250	340,00 gal Zn
EM 8	x	50	S	100	485,00 gal Zn

Abmessungen	VE Stück	€/100/Obf.
DIN	07500.016	
7500	Stahl	Form M-Z
	galvanisch verzinkt	

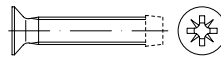

Gewindefurchende Schrauben, mit metrischem Gewinde, M = Senkkopf nach DIN 965 Z = mit Pozidriv-Kreuzschlitz Z gehärtet

Maße → **TI-41**

Korrosionsschutz → **TI-228**

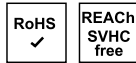

MM 2,5	x	5 -Z	S	4000	6,00 gal Zn
MM 2,5	x	6 -Z	S	1000	5,70 gal Zn
MM 2,5	x	8 -Z	S	1000	5,90 gal Zn
MM 2,5	x	10 -Z	S	1000	6,00 gal Zn
MM 2,5	x	12 -Z	S	1000	6,10 gal Zn
MM 2,5	x	16 -Z	S	1000	9,70 gal Zn
MM 2,5	x	20 -Z	S	1000	12,50 gal Zn
MM 3	x	4 -Z	S	1000	9,70 gal Zn
MM 3	x	5 -Z	S	1000	9,70 gal Zn
MM 3	x	6 -Z	S	1000	6,20 gal Zn
MM 3	x	8 -Z	S	1000	6,30 gal Zn
MM 3	x	10 -Z	S	1000	6,80 gal Zn
MM 3	x	12 -Z	S	1000	6,90 gal Zn
MM 3	x	16 -Z	S	1000	7,70 gal Zn
MM 3	x	20 -Z	S	1000	8,90 gal Zn
MM 3	x	25 -Z	S	1000	9,10 gal Zn
MM 4	x	6 -Z	S	1000	12,10 gal Zn
MM 4	x	8 -Z	S	1000	8,50 gal Zn
MM 4	x	10 -Z	S	1000	8,90 gal Zn
MM 4	x	12 -Z	S	1000	9,50 gal Zn
MM 4	x	16 -Z	S	1000	10,70 gal Zn
MM 4	x	20 -Z	S	1000	11,20 gal Zn
MM 4	x	25 -Z	S	1000	12,90 gal Zn
MM 4	x	30 -Z	S	1000	14,00 gal Zn
MM 5	x	8 -Z	S	1000	14,60 gal Zn
MM 5	x	10 -Z	S	1000	11,80 gal Zn
MM 5	x	12 -Z	S	1000	12,60 gal Zn
MM 5	x	16 -Z	S	1000	14,10 gal Zn
MM 5	x	20 -Z	S	1000	15,70 gal Zn
MM 5	x	25 -Z	S	1000	19,50 gal Zn
MM 5	x	30 -Z	S	1000	21,10 gal Zn
MM 5	x	35 -Z	S	1000	24,00 gal Zn
MM 5	x	40 -Z	S	1000	27,00 gal Zn
MM 6	x	8 -Z	S	1000	24,20 gal Zn
MM 6	x	10 -Z	S	1000	24,20 gal Zn
MM 6	x	12 -Z	S	500	20,30 gal Zn
MM 6	x	16 -Z	S	500	22,20 gal Zn
MM 6	x	20 -Z	S	500	22,90 gal Zn
MM 6	x	25 -Z	S	500	26,50 gal Zn
MM 6	x	30 -Z	S	500	28,50 gal Zn
MM 6	x	35 -Z	S	500	31,00 gal Zn
MM 6	x	40 -Z	S	500	36,00 gal Zn
MM 6	x	45 -Z	S	500	48,50 gal Zn
MM 6	x	50 -Z	S	500	49,50 gal Zn
MM 8	x	10 -Z	S	500	44,00 gal Zn
MM 8	x	12 -Z	S	500	39,00 gal Zn
MM 8	x	16 -Z	S	250	44,00 gal Zn
MM 8	x	20 -Z	S	250	46,00 gal Zn
MM 8	x	25 -Z	S	250	47,00 gal Zn
MM 8	x	30 -Z	S	250	60,00 gal Zn
MM 8	x	35 -Z	S	250	71,00 gal Zn
MM 8	x	40 -Z	S	250	85,00 gal Zn

Abmessungen	VE Stück	€/100/Obf.
MM 8 x 45 -Z	S 250	100,00 gal Zn
MM 8 x 50 -Z	S 250	119,00 gal Zn
MM 8 x 60 -Z	S 250	163,00 gal Zn

DIN	07504.014
7504	Stahl
	galvanisch verzinkt
	Form K

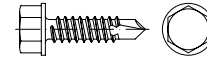

Bohrschrauben, mit Blechschrauben-Gewinde, K = Sechskant-Flanschkopf*

*nach DIN 6928/~ ISO 15480 gehärtet

Maße → **TI-42**

Montage → **TI-251**

Korrosionsschutz → **TI-228**

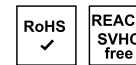

K 3,5	x	9,5	S	1000	9,50 gal Zn
K 3,5	x	13	S	1000	9,70 gal Zn
K 3,5	x	16	S	1000	10,70 gal Zn
K 3,5	x	19	S	1000	11,20 gal Zn
K 3,5	x	22	S	1000	17,20 gal Zn
K 3,5	x	25	S	1000	22,20 gal Zn
K 3,9	x	13	S	1000	10,30 gal Zn
K 3,9	x	16	S	1000	11,30 gal Zn
K 3,9	x	19	S	1000	12,30 gal Zn
K 3,9	x	22	S	1000	19,40 gal Zn
K 3,9	x	25	S	1000	25,50 gal Zn
K 3,9	x	32	S	1000	35,00 gal Zn
K 4,2	x	13	S	1000	11,70 gal Zn
K 4,2	x	16	S	1000	12,30 gal Zn
K 4,2	x	19	S	1000	12,50 gal Zn
K 4,2	x	22	S	1000	14,30 gal Zn
K 4,2	x	25	S	1000	15,20 gal Zn
K 4,2	x	32	S	500	21,50 gal Zn
K 4,2	x	38	S	500	28,00 gal Zn
K 4,8	x	13	S	1000	14,30 gal Zn
K 4,8	x	16	S	1000	15,00 gal Zn
K 4,8	x	19	S	1000	15,70 gal Zn
K 4,8	x	22	S	1000	18,00 gal Zn
K 4,8	x	25	S	1000	19,20 gal Zn
K 4,8	x	32	S	500	21,50 gal Zn
K 4,8	x	38	S	500	24,00 gal Zn
K 4,8	x	45	S	500	27,00 gal Zn
K 4,8	x	50	S	500	28,50 gal Zn
K 4,8	x	60	S	500	33,50 gal Zn
K 4,8	x	70	S	250	37,00 gal Zn
K 4,8	x	80	S	250	42,50 gal Zn
K 5,5	x	16	S	500	21,50 gal Zn
K 5,5	x	19	S	500	20,30 gal Zn
K 5,5	x	22	S	500	22,90 gal Zn
K 5,5	x	25	S	500	23,60 gal Zn
K 5,5	x	32	S	250	26,50 gal Zn
K 5,5	x	38	S	250	26,50 gal Zn
K 5,5	x	45	S	250	27,00 gal Zn
K 5,5	x	50	S	250	27,00 gal Zn
K 5,5	x	60	S	250	39,00 gal Zn
K 5,5	x	70	S	100	46,00 gal Zn
K 5,5	x	80	S	100	55,00 gal Zn
K 5,5	x	90	S	100	63,00 gal Zn
K 5,5	x	100	S	100	78,00 gal Zn
K 6,3	x	16	S	500	27,00 gal Zn
K 6,3	x	19	S	500	28,50 gal Zn
K 6,3	x	22	S	500	30,50 gal Zn

- ✓ Große Artikelvielfalt
- ✓ Verlässliche Qualität
- ✓ Hohe Lieferbereitschaft

Abmessungen	VE	Stück	€/100/Obf.
K 6,3 x 25	S	500	31,50 gal Zn
K 6,3 x 32	S	250	37,00 gal Zn
K 6,3 x 38	S	250	39,50 gal Zn
K 6,3 x 45	S	250	44,50 gal Zn
K 6,3 x 50	S	250	49,50 gal Zn
K 6,3 x 60	S	250	54,00 gal Zn
K 6,3 x 70	S	100	60,00 gal Zn
K 6,3 x 80	S	100	68,00 gal Zn
K 6,3 x 90	S	100	83,00 gal Zn
K 6,3 x 100	S	100	100,00 gal Zn
K 6,3 x 110	S	100	119,00 gal Zn
K 6,3 x 120	S	100	141,00 gal Zn
K 6,3 x 130	S	100	165,00 gal Zn
K 6,3 x 140	S	100	194,00 gal Zn
K 6,3 x 150	S	100	230,00 gal Zn
K 6,3 x 160	S	100	295,00 gal Zn

DIN	07504.015
7504	Stahl Form N-H galvanisch verzinkt

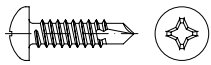

Bohrschrauben, mit Blechschrauben-Gewinde, N = Linsenkopf nach DIN 7981 H = mit Phillips-Kreuzschlitz H gehärtet

Maße → **TI-42** Montage → **TI-251**
 Korrosionsschutz → **TI-228**

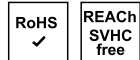

N 2,9 x 9,5-H	S	1000	8,60 gal Zn
N 2,9 x 13 -H	S	1000	8,80 gal Zn
N 2,9 x 16 -H	S	1000	8,90 gal Zn
N 2,9 x 19 -H	S	1000	9,60 gal Zn
N 3,5 x 9,5-H	S	1000	9,90 gal Zn
N 3,5 x 13 -H	S	1000	10,10 gal Zn
N 3,5 x 16 -H	S	1000	10,30 gal Zn
N 3,5 x 19 -H	S	1000	10,70 gal Zn
N 3,5 x 22 -H	S	1000	11,70 gal Zn
N 3,5 x 25 -H	S	1000	12,00 gal Zn
N 3,5 x 32 -H	S	1000	13,40 gal Zn
N 3,9 x 9,5-H	S	1000	10,10 gal Zn
N 3,9 x 13 -H	S	1000	10,20 gal Zn
N 3,9 x 16 -H	S	1000	10,80 gal Zn
N 3,9 x 19 -H	S	1000	11,30 gal Zn
N 3,9 x 22 -H	S	1000	11,70 gal Zn
N 3,9 x 25 -H	S	1000	12,10 gal Zn
N 3,9 x 32 -H	S	1000	12,90 gal Zn
N 3,9 x 38 -H	S	500	13,70 gal Zn
N 3,9 x 45 -H	S	500	14,60 gal Zn
N 3,9 x 50 -H	S	500	16,00 gal Zn
N 4,2 x 13 -H	S	1000	12,30 gal Zn
N 4,2 x 16 -H	S	1000	12,60 gal Zn
N 4,2 x 19 -H	S	1000	12,90 gal Zn
N 4,2 x 22 -H	S	1000	14,40 gal Zn
N 4,2 x 25 -H	S	1000	15,30 gal Zn
N 4,2 x 32 -H	S	500	16,50 gal Zn
N 4,2 x 38 -H	S	500	17,80 gal Zn
N 4,2 x 45 -H	S	500	19,30 gal Zn
N 4,2 x 50 -H	S	500	20,90 gal Zn
N 4,8 x 13 -H	S	1000	14,90 gal Zn
N 4,8 x 16 -H	S	1000	15,30 gal Zn
N 4,8 x 19 -H	S	1000	16,00 gal Zn
N 4,8 x 22 -H	S	1000	17,00 gal Zn
N 4,8 x 25 -H	S	1000	18,70 gal Zn

Abmessungen	VE	Stück	€/100/Obf.
N 4,8 x 32 -H	S	500	18,80 gal Zn
N 4,8 x 38 -H	S	500	20,60 gal Zn
N 4,8 x 45 -H	S	500	22,20 gal Zn
N 4,8 x 50 -H	S	500	23,60 gal Zn
N 4,8 x 60 -H	S	250	26,50 gal Zn
N 4,8 x 70 -H	S	250	29,00 gal Zn
N 4,8 x 80 -H	S	250	32,00 gal Zn
N 4,8 x 90 -H	S	250	51,00 gal Zn
N 4,8 x 100 -H	S	250	80,00 gal Zn
N 4,8 x 110 -H	S	100	119,00 gal Zn
N 4,8 x 120 -H	S	250	170,00 gal Zn
N 5,5 x 16 -H	S	500	18,60 gal Zn
N 5,5 x 19 -H	S	500	19,40 gal Zn
N 5,5 x 22 -H	S	500	21,50 gal Zn
N 5,5 x 25 -H	S	500	29,00 gal Zn
N 5,5 x 32 -H	S	500	31,50 gal Zn
N 5,5 x 38 -H	S	500	34,00 gal Zn
N 5,5 x 45 -H	S	500	36,50 gal Zn
N 5,5 x 50 -H	S	500	39,50 gal Zn
N 5,5 x 60 -H	S	250	43,50 gal Zn
N 5,5 x 70 -H	S	250	49,00 gal Zn
N 5,5 x 80 -H	S	250	54,00 gal Zn
N 6,3 x 16 -H	S	500	32,50 gal Zn
N 6,3 x 19 -H	S	500	34,00 gal Zn
N 6,3 x 22 -H	S	500	37,00 gal Zn
N 6,3 x 25 -H	S	500	40,00 gal Zn
N 6,3 x 32 -H	S	500	43,00 gal Zn
N 6,3 x 38 -H	S	500	46,50 gal Zn
N 6,3 x 45 -H	S	500	50,00 gal Zn
N 6,3 x 50 -H	S	500	54,00 gal Zn
N 6,3 x 60 -H	S	250	60,00 gal Zn
N 6,3 x 70 -H	S	250	66,00 gal Zn
N 6,3 x 80 -H	S	250	72,00 gal Zn
N 6,3 x 90 -H	S	100	81,00 gal Zn
N 6,3 x 100 -H	S	100	91,00 gal Zn

~DIN	07504.301
7504	Stahl Form N-ISR galvanisch verzinkt

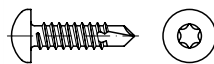

Bohrschrauben, mit Blechschrauben-Gewinde, N = Linsenkopf nach ISO 14585 ISR = Innensechsrund gehärtet

Maße → **TI-42** Montage → **TI-251**
 Korrosionsschutz → **TI-228**

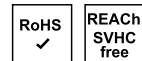

N 2,9 x 9,5-T10	S	1000	11,70 gal Zn
N 2,9 x 13 -T10	S	1000	11,80 gal Zn
N 2,9 x 16 -T10	S	1000	12,00 gal Zn
N 2,9 x 19 -T10	S	1000	13,00 gal Zn
N 3,5 x 9,5-T15	S	1000	13,40 gal Zn
N 3,5 x 13 -T15	S	1000	13,70 gal Zn
N 3,5 x 16 -T15	S	1000	14,60 gal Zn
N 3,5 x 19 -T15	S	1000	15,70 gal Zn
N 3,5 x 22 -T15	S	1000	15,80 gal Zn
N 3,5 x 25 -T15	S	1000	16,30 gal Zn
N 3,5 x 32 -T15	S	1000	18,20 gal Zn
N 3,9 x 9,5-T20	S	1000	13,70 gal Zn
N 3,9 x 13 -T20	S	1000	13,80 gal Zn
N 3,9 x 16 -T20	S	1000	14,60 gal Zn
N 3,9 x 19 -T20	S	1000	15,30 gal Zn
N 3,9 x 22 -T20	S	1000	15,80 gal Zn

Abmessungen	VE	Stück	€/100/Obf.
N 3,9 x 25 -T20	S	1000	16,40 gal Zn
N 3,9 x 32 -T20	S	1000	17,50 gal Zn
N 3,9 x 38 -T20	S	500	18,60 gal Zn
N 3,9 x 45 -T20	S	500	19,70 gal Zn
N 3,9 x 50 -T20	S	500	21,80 gal Zn
N 4,2 x 13 -T20	S	1000	16,60 gal Zn
N 4,2 x 16 -T20	S	1000	17,00 gal Zn
N 4,2 x 19 -T20	S	1000	17,40 gal Zn
N 4,2 x 22 -T20	S	1000	19,50 gal Zn
N 4,2 x 25 -T20	S	1000	20,70 gal Zn
N 4,2 x 32 -T20	S	500	22,40 gal Zn
N 4,2 x 38 -T20	S	500	24,20 gal Zn
N 4,2 x 45 -T20	S	500	26,50 gal Zn
N 4,2 x 50 -T20	S	500	28,50 gal Zn
N 4,8 x 13 -T25	S	1000	20,20 gal Zn
N 4,8 x 16 -T25	S	1000	20,70 gal Zn
N 4,8 x 19 -T25	S	1000	21,60 gal Zn
N 4,8 x 22 -T25	S	1000	23,00 gal Zn
N 4,8 x 25 -T25	S	1000	25,50 gal Zn
N 4,8 x 32 -T25	S	500	25,50 gal Zn
N 4,8 x 38 -T25	S	500	28,00 gal Zn
N 4,8 x 45 -T25	S	500	30,50 gal Zn
N 4,8 x 50 -T25	S	500	32,50 gal Zn
N 4,8 x 55 -T25	S	500	35,00 gal Zn
N 4,8 x 60 -T25	S	250	35,50 gal Zn
N 4,8 x 70 -T25	S	250	39,00 gal Zn
N 4,8 x 80 -T25	S	250	43,00 gal Zn
N 5,5 x 16 -T25	S	500	25,50 gal Zn
N 5,5 x 19 -T25	S	500	26,50 gal Zn
N 5,5 x 22 -T25	S	500	29,00 gal Zn
N 5,5 x 25 -T25	S	500	39,00 gal Zn
N 5,5 x 32 -T25	S	500	42,00 gal Zn
N 5,5 x 38 -T25	S	500	45,50 gal Zn
N 5,5 x 45 -T25	S	500	49,50 gal Zn
N 5,5 x 50 -T25	S	500	54,00 gal Zn
N 5,5 x 60 -T25	S	250	59,00 gal Zn
N 5,5 x 70 -T25	S	250	67,00 gal Zn
N 5,5 x 80 -T25	S	250	73,00 gal Zn
N 6,3 x 16 -T30	S	500	44,00 gal Zn
N 6,3 x 19 -T30	S	500	46,00 gal Zn
N 6,3 x 22 -T30	S	500	50,00 gal Zn
N 6,3 x 25 -T30	S	500	54,00 gal Zn
N 6,3 x 32 -T30	S	500	59,00 gal Zn
N 6,3 x 38 -T30	S	500	63,00 gal Zn
N 6,3 x 45 -T30	S	500	68,00 gal Zn
N 6,3 x 50 -T30	S	500	74,00 gal Zn
N 6,3 x 60 -T30	S	250	81,00 gal Zn
N 6,3 x 70 -T30	S	250	89,00 gal Zn
N 6,3 x 80 -T30	S	250	98,00 gal Zn
N 6,3 x 90 -T30	S	100	109,00 gal Zn
N 6,3 x 100 -T30	S	100	128,00 gal Zn



Wir versorgen Sie mit
 Verbindungselementen
 und Befestigungstechnik!

Abmessungen	VE Stück	€/100/Obf.
DIN	07504.016	
7504	Stahl	Form P-H
	galvanisch verzinkt	

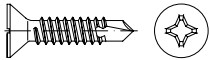

**Bohrschrauben,
mit Blechschrauben-Gewinde,
P = Senkkopf*
H = mit Phillips-Kreuzschlitz H**

*nach DIN 7982 (Senk \sphericalangle = 80°)
gehärtet

Maße → **TI-42** Montage → **TI-251**
Korrosionsschutz → **TI-228**

DIN 7504 Form P → wird ersetzt durch ISO 15482



P 2,9	x 13 -H	S 1000	8,20 gal Zn
P 2,9	x 16 -H	S 1000	8,40 gal Zn
P 2,9	x 19 -H	S 1000	8,90 gal Zn
P 3,5	x 13 -H	S 1000	9,40 gal Zn
P 3,5	x 16 -H	S 1000	9,60 gal Zn
P 3,5	x 19 -H	S 1000	9,90 gal Zn
P 3,5	x 22 -H	S 1000	10,80 gal Zn
P 3,5	x 25 -H	S 1000	11,20 gal Zn
P 3,9	x 13 -H	S 1000	9,10 gal Zn
P 3,9	x 16 -H	S 1000	9,20 gal Zn
P 3,9	x 19 -H	S 1000	9,20 gal Zn
P 3,9	x 22 -H	S 1000	10,30 gal Zn
P 3,9	x 25 -H	S 1000	10,70 gal Zn
P 3,9	x 32 -H	S 1000	12,00 gal Zn
P 3,9	x 38 -H	S 500	14,80 gal Zn
P 3,9	x 45 -H	S 500	15,20 gal Zn
P 4,2	x 13 -H	S 1000	11,30 gal Zn
P 4,2	x 16 -H	S 1000	11,70 gal Zn
P 4,2	x 19 -H	S 1000	11,90 gal Zn
P 4,2	x 22 -H	S 1000	13,50 gal Zn
P 4,2	x 25 -H	S 1000	14,20 gal Zn
P 4,2	x 32 -H	S 500	15,20 gal Zn
P 4,2	x 38 -H	S 500	17,00 gal Zn
P 4,2	x 45 -H	S 500	18,90 gal Zn
P 4,2	x 50 -H	S 500	23,60 gal Zn
P 4,8	x 16 -H	S 1000	12,10 gal Zn
P 4,8	x 19 -H	S 1000	14,00 gal Zn
P 4,8	x 22 -H	S 1000	14,70 gal Zn
P 4,8	x 25 -H	S 500	14,80 gal Zn
P 4,8	x 32 -H	S 500	16,10 gal Zn
P 4,8	x 38 -H	S 500	17,70 gal Zn
P 4,8	x 45 -H	S 500	21,10 gal Zn
P 4,8	x 50 -H	S 250	24,10 gal Zn
P 5,5	x 25 -H	S 250	18,10 gal Zn
P 5,5	x 32 -H	S 250	19,70 gal Zn
P 5,5	x 38 -H	S 250	21,20 gal Zn
P 5,5	x 45 -H	S 250	23,80 gal Zn
P 5,5	x 50 -H	S 250	26,50 gal Zn
P 6,3	x 25 -H	S 250	26,00 gal Zn
P 6,3	x 32 -H	S 250	27,50 gal Zn
P 6,3	x 38 -H	S 250	29,50 gal Zn
P 6,3	x 45 -H	S 250	33,50 gal Zn
P 6,3	x 50 -H	S 250	36,50 gal Zn
P 6,3	x 60 -H	S 250	38,50 gal Zn
P 6,3	x 70 -H	S 250	65,00 gal Zn
P 6,3	x 80 -H	S 250	88,00 gal Zn

Abmessungen	VE Stück	€/100/Obf.
DIN	07504.019	
7504	Stahl	Form P-ISR
	galvanisch verzinkt	

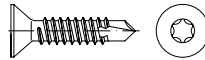

**Bohrschrauben,
mit Blechschrauben-Gewinde,
P = Senkkopf*
ISR = Innensechsrund**

*nach DIN 7982 (Senk \sphericalangle = 80°)
gehärtet

Maße → **TI-42** Montage → **TI-251**
Korrosionsschutz → **TI-228**

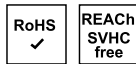

P 2,9	x 13 -T10	S 1000	8,20 gal Zn
P 3,5	x 13 -T15	S 1000	9,40 gal Zn
P 3,5	x 16 -T15	S 1000	9,60 gal Zn
P 3,5	x 19 -T15	S 1000	9,90 gal Zn
P 3,5	x 22 -T15	S 1000	10,80 gal Zn
P 3,5	x 25 -T15	S 1000	11,20 gal Zn
P 3,9	x 13 -T20	S 1000	9,10 gal Zn
P 3,9	x 16 -T20	S 1000	9,20 gal Zn
P 3,9	x 19 -T20	S 1000	9,20 gal Zn
P 3,9	x 22 -T20	S 1000	10,30 gal Zn
P 3,9	x 25 -T20	S 1000	10,70 gal Zn
P 3,9	x 32 -T20	S 1000	12,00 gal Zn
P 3,9	x 38 -T20	S 500	14,80 gal Zn
P 4,2	x 13 -T20	S 1000	11,30 gal Zn
P 4,2	x 16 -T20	S 1000	11,70 gal Zn
P 4,2	x 19 -T20	S 1000	11,90 gal Zn
P 4,2	x 22 -T20	S 1000	13,50 gal Zn
P 4,2	x 25 -T20	S 1000	14,20 gal Zn
P 4,2	x 32 -T20	S 500	15,20 gal Zn
P 4,2	x 38 -T20	S 500	17,00 gal Zn
P 4,2	x 45 -T20	S 500	18,90 gal Zn
P 4,2	x 50 -T20	S 500	23,60 gal Zn
P 4,8	x 16 -T25	S 1000	12,10 gal Zn
P 4,8	x 19 -T25	S 1000	14,00 gal Zn
P 4,8	x 22 -T25	S 1000	14,70 gal Zn
P 4,8	x 25 -T25	S 500	14,80 gal Zn
P 4,8	x 32 -T25	S 500	16,10 gal Zn
P 4,8	x 38 -T25	S 500	17,70 gal Zn
P 4,8	x 45 -T25	S 500	21,10 gal Zn
P 4,8	x 50 -T25	S 250	24,10 gal Zn
P 5,5	x 19 -T25	S 250	18,10 gal Zn
P 5,5	x 22 -T25	S 250	18,10 gal Zn
P 5,5	x 25 -T25	S 250	18,10 gal Zn
P 5,5	x 32 -T25	S 250	19,70 gal Zn
P 5,5	x 38 -T25	S 250	21,20 gal Zn
P 5,5	x 45 -T25	S 250	23,80 gal Zn
P 5,5	x 50 -T25	S 250	26,50 gal Zn
P 6,3	x 19 -T30	S 250	26,00 gal Zn
P 6,3	x 22 -T30	S 250	26,00 gal Zn
P 6,3	x 25 -T30	S 250	26,00 gal Zn
P 6,3	x 32 -T30	S 250	27,50 gal Zn
P 6,3	x 38 -T30	S 250	29,50 gal Zn
P 6,3	x 45 -T30	S 250	33,50 gal Zn
P 6,3	x 50 -T30	S 250	36,50 gal Zn
P 6,3	x 60 -T30	S 250	38,50 gal Zn
P 6,3	x 70 -T30	S 250	65,00 gal Zn
P 6,3	x 80 -T30	S 100	83,00 gal Zn

Abmessungen	VE Stück	€/100/Obf.
DIN	07513.011	
7513	Stahl	Form A
	galvanisch verzinkt	



**Sechskant-Schneidschrauben,
A = Sechskantkopf nach DIN 933**
gehärtet

Maße → **TI-44** Korrosionsschutz → **TI-228**

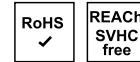

AM 4	x 8	S 1000	21,80 gal Zn
AM 4	x 10	S 1000	19,40 gal Zn
AM 4	x 12	S 1000	14,60 gal Zn
AM 4	x 16	S 1000	22,20 gal Zn
AM 4	x 20	S 1000	26,50 gal Zn
AM 4	x 25	S 1000	34,00 gal Zn
AM 5	x 10	S 1000	17,10 gal Zn
AM 5	x 12	S 1000	18,00 gal Zn
AM 5	x 16	S 1000	18,60 gal Zn
AM 5	x 20	S 500	24,20 gal Zn
AM 5	x 25	S 500	34,00 gal Zn
AM 5	x 30	S 500	44,00 gal Zn
AM 6	x 12	S 1000	34,00 gal Zn
AM 6	x 16	S 500	36,00 gal Zn
AM 6	x 20	S 500	37,00 gal Zn
AM 6	x 25	S 500	38,50 gal Zn
AM 6	x 30	S 500	47,50 gal Zn
AM 6	x 35	S 500	63,00 gal Zn
AM 8	x 16	S 100	52,00 gal Zn
AM 8	x 20	S 100	55,00 gal Zn
AM 8	x 25	S 100	57,00 gal Zn
AM 8	x 30	S 100	72,00 gal Zn
AM 8	x 35	S 100	83,00 gal Zn
AM 8	x 40	S 100	97,00 gal Zn
AM 8	x 45	S 50	112,00 gal Zn
AM 8	x 50	S 50	128,00 gal Zn

DIN	07513.012
7513	Stahl
	galvanisch verzinkt
	Form B



**Zylinder-Schneidschrauben,
B = Kopf mit Schlitz nach DIN 84**
gehärtet

Maße → **TI-44** Korrosionsschutz → **TI-228**

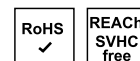

BM 3	x 6	S 1000	7,40 gal Zn
BM 3	x 8	S 1000	7,40 gal Zn
BM 3	x 10	S 1000	7,40 gal Zn
BM 3	x 12	S 1000	7,70 gal Zn
BM 3	x 16	S 1000	9,70 gal Zn
BM 3	x 20	S 1000	12,10 gal Zn
BM 4	x 8	S 1000	10,00 gal Zn
BM 4	x 10	S 1000	10,20 gal Zn

Abmessungen	VE	Stück	€/100/Obf.
BM 4 x 12	S	1000	10,50 gal Zn
BM 4 x 16	S	1000	11,10 gal Zn
BM 4 x 20	S	1000	11,90 gal Zn
BM 4 x 25	S	1000	17,00 gal Zn
BM 5 x 10	S	1000	12,40 gal Zn
BM 5 x 12	S	1000	13,10 gal Zn
BM 5 x 16	S	1000	13,60 gal Zn
BM 5 x 20	S	1000	14,60 gal Zn
BM 6 x 12	S	1000	18,20 gal Zn
BM 6 x 16	S	500	21,50 gal Zn
BM 6 x 20	S	500	28,00 gal Zn
BM 6 x 25	S	500	30,50 gal Zn

DIN	07516.011
7516	Stahl Form A-H galvanisch verzinkt



**Gewinde-Schneidschrauben,
A = Linsenkopf nach DIN 7985
H = mit Phillips-Kreuzschlitz H**
gehärtet

Maße → **TI-45**

Korrosionsschutz → **TI-228**

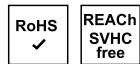

AM 3 x 6-H	S	2000	10,00 gal Zn
AM 3 x 8-H	S	2000	10,00 gal Zn
AM 3 x 10-H	S	2000	10,10 gal Zn
AM 3 x 12-H	S	2000	10,30 gal Zn
AM 3 x 16-H	S	2000	10,60 gal Zn
AM 4 x 6-H	S	2000	13,20 gal Zn
AM 4 x 8-H	S	2000	13,20 gal Zn
AM 4 x 10-H	S	2000	13,40 gal Zn
AM 4 x 12-H	S	2000	13,80 gal Zn
AM 4 x 16-H	S	2000	14,20 gal Zn
AM 4 x 20-H	S	1000	15,20 gal Zn
AM 4 x 25-H	S	1000	15,30 gal Zn
AM 4 x 30-H	S	1000	16,30 gal Zn
AM 5 x 10-H	S	2000	16,50 gal Zn
AM 5 x 12-H	S	1000	17,10 gal Zn
AM 5 x 16-H	S	1000	17,40 gal Zn
AM 5 x 20-H	S	500	18,90 gal Zn
AM 5 x 25-H	S	500	20,00 gal Zn
AM 5 x 30-H	S	500	21,20 gal Zn
AM 5 x 35-H	S	500	25,50 gal Zn
AM 5 x 40-H	S	500	31,00 gal Zn
AM 6 x 12-H	S	500	35,50 gal Zn
AM 6 x 16-H	S	500	31,50 gal Zn
AM 6 x 20-H	S	500	33,50 gal Zn
AM 6 x 25-H	S	500	35,50 gal Zn
AM 6 x 30-H	S	500	36,50 gal Zn
AM 6 x 35-H	S	500	40,00 gal Zn
AM 6 x 40-H	S	250	46,00 gal Zn
AM 6 x 50-H	S	250	52,00 gal Zn
AM 8 x 16-H	S	500	46,00 gal Zn
AM 8 x 20-H	S	500	51,00 gal Zn
AM 8 x 25-H	S	500	57,00 gal Zn
AM 8 x 30-H	S	500	63,00 gal Zn
AM 8 x 35-H	S	500	79,00 gal Zn
AM 8 x 40-H	S	500	95,00 gal Zn

Abmessungen	VE	Stück	€/100/Obf.
DIN	07516.014		
7516	Stahl Form D-H galvanisch verzinkt		



**Gewinde-Schneidschrauben,
D = Senkkopf nach DIN 965
H = mit Phillips-Kreuzschlitz H**
gehärtet

Maße → **TI-45**

Korrosionsschutz → **TI-228**

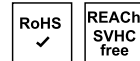

DM 3 x 6-H	S	2000	9,70 gal Zn
DM 3 x 8-H	S	2000	9,70 gal Zn
DM 3 x 10-H	S	2000	9,90 gal Zn
DM 3 x 12-H	S	2000	10,20 gal Zn
DM 3 x 16-H	S	2000	10,20 gal Zn
DM 4 x 8-H	S	2000	13,40 gal Zn
DM 4 x 10-H	S	2000	13,10 gal Zn
DM 4 x 12-H	S	2000	13,20 gal Zn
DM 4 x 16-H	S	2000	13,50 gal Zn
DM 4 x 20-H	S	1000	14,70 gal Zn
DM 4 x 25-H	S	1000	17,00 gal Zn
DM 5 x 10-H	S	2000	15,70 gal Zn
DM 5 x 12-H	S	1000	15,70 gal Zn
DM 5 x 16-H	S	1000	16,30 gal Zn
DM 5 x 20-H	S	500	17,40 gal Zn
DM 5 x 25-H	S	500	18,60 gal Zn
DM 5 x 30-H	S	500	24,20 gal Zn
DM 6 x 12-H	S	1000	30,00 gal Zn
DM 6 x 16-H	S	500	30,00 gal Zn
DM 6 x 20-H	S	500	31,50 gal Zn
DM 6 x 25-H	S	500	33,50 gal Zn
DM 6 x 30-H	S	500	34,50 gal Zn
DM 6 x 35-H	S	500	36,50 gal Zn
DM 6 x 40-H	S	250	41,50 gal Zn
DM 6 x 45-H	S	250	66,00 gal Zn
DM 6 x 50-H	S	250	76,00 gal Zn
DM 6 x 60-H	S	250	92,00 gal Zn
DM 8 x 16-H	S	100	73,00 gal Zn
DM 8 x 20-H	S	100	71,00 gal Zn
DM 8 x 25-H	S	100	79,00 gal Zn
DM 8 x 30-H	S	100	91,00 gal Zn
DM 8 x 35-H	S	100	107,00 gal Zn
DM 8 x 40-H	S	100	121,00 gal Zn

Abmessungen	VE	Stück	€/100/Obf.
DIN	07516.015		
7516	Stahl Form E-H galvanisch verzinkt		



**Gewinde-Schneidschrauben,
E = Linsensenkkopf nach DIN 966
H = mit Phillips-Kreuzschlitz H**
gehärtet

Maße → **TI-45**

Korrosionsschutz → **TI-228**

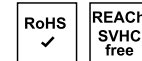

EM 3 x 6-H	S	2000	18,00 gal Zn
EM 3 x 8-H	S	2000	18,00 gal Zn
EM 3 x 10-H	S	2000	18,60 gal Zn
EM 3 x 12-H	S	2000	18,90 gal Zn
EM 3 x 16-H	S	1000	21,50 gal Zn
EM 3 x 20-H	S	1000	22,40 gal Zn
EM 4 x 8-H	S	2000	21,10 gal Zn
EM 4 x 10-H	S	2000	19,20 gal Zn
EM 4 x 12-H	S	2000	25,50 gal Zn
EM 4 x 16-H	S	2000	19,00 gal Zn
EM 4 x 20-H	S	1000	20,90 gal Zn
EM 4 x 25-H	S	1000	34,00 gal Zn
EM 5 x 10-H	S	1000	29,50 gal Zn
EM 5 x 12-H	S	1000	29,50 gal Zn
EM 5 x 16-H	S	1000	23,20 gal Zn
EM 5 x 20-H	S	500	24,50 gal Zn
EM 5 x 25-H	S	500	34,50 gal Zn
EM 5 x 30-H	S	500	45,00 gal Zn
EM 6 x 12-H	S	1000	56,00 gal Zn
EM 6 x 16-H	S	500	42,50 gal Zn
EM 6 x 20-H	S	500	59,00 gal Zn
EM 6 x 25-H	S	500	62,00 gal Zn
EM 6 x 30-H	S	500	65,00 gal Zn
EM 6 x 35-H	S	500	68,00 gal Zn
EM 6 x 40-H	S	500	77,00 gal Zn
EM 6 x 50-H	S	500	55,00 gal Zn
EM 6 x 60-H	S	500	40,50 gal Zn
EM 8 x 16-H	S	500	140,00 gal Zn
EM 8 x 20-H	S	250	134,00 gal Zn
EM 8 x 25-H	S	250	152,00 gal Zn
EM 8 x 30-H	S	250	170,00 gal Zn
EM 8 x 35-H	S	250	212,00 gal Zn



- ✓ Große Artikelvielfalt
- ✓ Verlässliche Qualität
- ✓ Hohe Lieferbereitschaft

Abmessungen	VE Stück	€/100/Obf.
~DIN	07516.018	
7516	Stahl	Form AE-ISR
	galvanisch verzinkt	



Gewinde-Schneidschrauben,
AE = Linsenkopf nach ISO 7045
ISR = Innensechsrund
 gehärtet

Stiftschlüssel → ~ DIN 911 ISR,
 Bits → Artikel 88655

Maße → **TI-45** Korrosionsschutz → **TI-228**

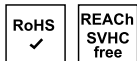

AE M 4	x 16 -T20	S 2000	19,40 gal Zn
AE M 4	x 20 -T20	S 1000	20,50 gal Zn
AE M 5	x 10 -T25	S 1000	22,40 gal Zn
AE M 5	x 12 -T25	S 1000	23,20 gal Zn
AE M 5	x 16 -T25	S 1000	23,60 gal Zn
AE M 5	x 20 -T25	S 500	26,00 gal Zn
AE M 5	x 25 -T25	S 500	27,00 gal Zn
AE M 6	x 12 -T30	S 1000	48,50 gal Zn
AE M 6	x 16 -T30	S 500	42,50 gal Zn
AE M 6	x 20 -T30	S 500	45,50 gal Zn
AE M 6	x 25 -T30	S 500	47,50 gal Zn

~DIN	07516.017
7516	Stahl
	Form DE-ISR
	galvanisch verzinkt



Gewinde-Schneidschrauben,
DE = Senkkopf nach ISO 7046-1
ISR = Innensechsrund
 gehärtet

Stiftschlüssel → ~ DIN 911 ISR,
 Bits → Artikel 88655

Maße → **TI-45** Korrosionsschutz → **TI-228**



DE M 3	x 6 -T10	S 2000	13,40 gal Zn
DE M 3	x 8 -T10	S 2000	13,40 gal Zn
DE M 3	x 10 -T10	S 2000	13,60 gal Zn
DE M 3	x 12 -T10	S 2000	14,00 gal Zn
DE M 3	x 16 -T10	S 1000	14,00 gal Zn
DE M 3	x 20 -T10	S 1000	17,50 gal Zn
DE M 4	x 8 -T20	S 2000	18,10 gal Zn
DE M 4	x 10 -T20	S 2000	19,10 gal Zn
DE M 4	x 12 -T20	S 2000	19,40 gal Zn
DE M 4	x 16 -T20	S 2000	20,30 gal Zn
DE M 4	x 20 -T20	S 1000	21,00 gal Zn
DE M 4	x 25 -T20	S 1000	22,90 gal Zn
DE M 5	x 10 -T25	S 1000	21,20 gal Zn
DE M 5	x 12 -T25	S 1000	21,20 gal Zn
DE M 5	x 16 -T25	S 1000	22,40 gal Zn

Abmessungen	VE Stück	€/100/Obf.	
DE M 5	x 20 -T25	S 500	24,20 gal Zn
DE M 5	x 25 -T25	S 500	27,00 gal Zn
DE M 5	x 30 -T25	S 500	33,00 gal Zn
DE M 6	x 12 -T30	S 1000	40,00 gal Zn
DE M 6	x 16 -T30	S 500	40,00 gal Zn
DE M 6	x 20 -T30	S 500	42,50 gal Zn
DE M 6	x 25 -T30	S 500	45,50 gal Zn
DE M 6	x 30 -T30	S 500	47,00 gal Zn
DE M 6	x 35 -T30	S 500	49,50 gal Zn
DE M 6	x 40 -T30	S 500	56,00 gal Zn
DE M 6	x 45 -T30	S 500	60,00 gal Zn
DE M 6	x 50 -T30	S 500	68,00 gal Zn
DE M 8	x 20 -T45	S 250	102,00 gal Zn
DE M 8	x 25 -T45	S 250	107,00 gal Zn
DE M 8	x 30 -T45	S 250	128,00 gal Zn

DIN	07604.001
7604	Stahl
	Form A

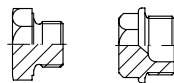

bis M 16 ab M 18

Verschlusschrauben mit Bund und
Außensechskant, leichte Ausführung,
mit zylindrischem Feingewinde,
A = kurzer Einschraubzapfen

Maße → **TI-24** REACH → **TI-262**

Rostfrei → **S. 574**



AM 10	x 1	S 100	95,00
AM 12	x 1,5	S 50	137,00
AM 14	x 1,5	S 50	163,00
AM 16	x 1,5	S 50	205,00
AM 18	x 1,5	S 25	235,00
AM 22	x 1,5	S 25	265,00
AM 26	x 1,5	S 25	480,00
AM 30	x 1,5	S 25	590,00

Abmessungen	VE Stück	€/100/Obf.
DIN	07604.011	
7604	Stahl	Form A
	galvanisch verzinkt	

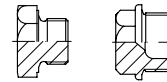

bis M16 ab M18

Verschlusschrauben mit Bund und
Außensechskant, leichte Ausführung,
mit zylindrischem Feingewinde,
A = kurzer Einschraubzapfen

Maße → **TI-24** REACH → **TI-262**

Korrosionsschutz → **TI-228**

Rostfrei → **S. 574**



AM 10	x 1	S 100	101,00 gal Zn
AM 12	x 1,5	S 50	147,00 gal Zn
AM 14	x 1,5	S 50	172,00 gal Zn
AM 16	x 1,5	S 50	221,00 gal Zn
AM 18	x 1,5	S 25	260,00 gal Zn
AM 22	x 1,5	S 25	300,00 gal Zn
AM 26	x 1,5	S 25	530,00 gal Zn
AM 30	x 1,5	S 25	630,00 gal Zn

DIN	07604.003
7604	Stahl
	Form C

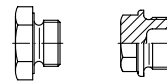

bis M16 ab M18

Verschlusschrauben mit Bund und
Außensechskant, leichte Ausführung,
mit zylindrischem Feingewinde,
C = langer Einschraubzapfen

Maße → **TI-24** REACH → **TI-262**



CM 8	x 1	S 100	83,00
CM 10	x 1	S 100	95,00
CM 22	x 1,5	S 25	370,00
CM 26	x 1,5	S 25	510,00
CM 30	x 1,5	S 25	630,00
CM 38	x 1,5	S 10	960,00
CM 45	x 1,5	S 1	1350,00
CM 52	x 1,5	S 1	2160,00

Abmessungen	VE Stück	€/100/Obf.
DIN	07643.010	
7643	Stahl	galvanisch verzinkt

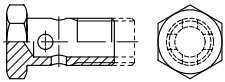

Hohlschrauben für Ringstutzen, Gewindelänge kurz

Maße → **TI-34** REACH → **TI-262**
 Korrosionsschutz → **TI-228**



Rohr-Außen Ø = Anzahl Löcher - Gewinde

4-5-3 M 8	x	1	S	50	227,00 gal Zn
6-3 M10	x	1	S	50	275,00 gal Zn
8-3 M12	x	1,5	S	50	345,00 gal Zn
10-3 M14	x	1,5	S	50	420,00 gal Zn
12-3 M16	x	1,5	S	25	600,00 gal Zn
15-3 M18	x	1,5	S	25	840,00 gal Zn
18-3 M22	x	1,5	S	10	1670,00 gal Zn
22-4 M26	x	1,5	S	10	2650,00 gal Zn

DIN	07965.010
7965	Stahl
	galvanisch verzinkt

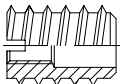

Einschraubmuttern "RAMPA" (Schraubdübel)

Maße → **TI-79** REACH → **TI-262**
 Korrosionsschutz → **TI-228**
 Messing → **S. 642**



Innennutzgewinde x Länge

M 3	x	8	S	100	36,00
M 3	x	10	S	100	39,00
M 3	x	12	S	100	43,00
M 4	x	8	S	100	33,50
M 4	x	10	S	100	35,50
M 4	x	12	S	100	40,00
M 4	x	15	S	100	49,50
M 5	x	10	S	100	41,50
M 5	x	12	S	100	44,50
M 5	x	15	S	100	55,00
M 5	x	18	S	100	65,00
M 5	x	20	S	100	78,00
M 6	x	12	S	100	51,00
M 6	x	15	S	100	59,00
M 6	x	18	S	100	72,00
M 6	x	20	S	100	80,00
M 6	x	25	S	100	106,00
M 6	x	30	S	100	166,00
M 8	x	18	S	100	107,00
M 8	x	30	S	100	212,00
M 10	x	20	S	100	174,00
M 10	x	25	S	100	218,00
M 10	x	30	S	100	260,00

Abmessungen	VE Stück	€/100/Obf.			
M 10	x	40	S	100	340,00
M 12	x	25	S	100	325,00
M 12	x	30	S	50	390,00

~DIN	07967.000
------	-----------

7967 Federstahl



Sicherungsmuttern (Palmuttern)

Maße → **TI-68** Schraubensicherung → **TI-256**
 Rostfrei → **S. 574**

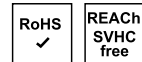

M 6	S	1000	9,40
M 8	S	1000	10,10
M 10	S	1000	12,50
M 12	S	1000	18,10
M 16	S	500	26,00
M 20	S	250	42,00
M 22	S	200	88,00
M 24	S	200	68,00
M 27	S	100	96,00
M 30	S	100	113,00
M 33	S	50	200,00
M 36	S	25	480,00
M 42	S	1	610,00
M 48	S	1	890,00

~DIN	07967.010
------	-----------

7967 Federstahl galvanisch verzinkt



Sicherungsmuttern (Palmuttern)

Maße → **TI-68** Schraubensicherung → **TI-256**
 Korrosionsschutz → **TI-228**
 Rostfrei → **S. 574**

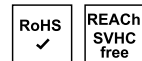

M 6	S	1000	10,60 gal Zn
M 6	K	100	14,30 gal Zn
M 8	S	1000	13,70 gal Zn
M 8	K	100	17,50 gal Zn
M 10	S	1000	14,30 gal Zn
M 10	K	100	18,10 gal Zn
M 12	S	1000	19,40 gal Zn
M 12	K	100	23,20 gal Zn
M 14	S	500	44,00 gal Zn
M 14	K	100	51,00 gal Zn
M 16	S	500	27,50 gal Zn
M 16	K	100	31,50 gal Zn
M 20	S	250	47,50 gal Zn
M 20	K	100	52,00 gal Zn
M 22	S	200	97,00 gal Zn
M 22	K	100	103,00 gal Zn
M 24	S	200	88,00 gal Zn

Abmessungen	VE Stück	€/100/Obf.	
M 24	K	100	92,00 gal Zn
M 27	S	100	142,00 gal Zn
M 30	S	100	152,00 gal Zn
M 33	S	50	241,00 gal Zn
M 36	S	25	560,00 gal Zn
M 42	S	1	730,00 gal Zn
M 48	S	1	1080,00 gal Zn

~DIN	07967.020
------	-----------

7967 Federstahl feuerverzinkt

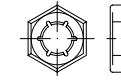

Sicherungsmuttern (Palmuttern)

Maße → **TI-68** Schraubensicherung → **TI-256**
 Korrosionsschutz → **TI-231**
 Rostfrei → **S. 574**

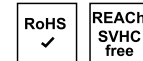

M 8	S	100	19,40 tZn
M 10	S	100	20,70 tZn
M 12	S	100	26,50 tZn
M 16	S	100	36,00 tZn
M 20	S	100	57,00 tZn
M 22	S	100	126,00 tZn
M 24	S	100	111,00 tZn
M 27	S	100	229,00 tZn
M 30	S	100	265,00 tZn
M 33	S	50	365,00 tZn
M 36	S	25	610,00 tZn
M 42	S	1	970,00 tZn
M 48	S	1	1210,00 tZn

DIN	07968.500
-----	-----------

7968 Mu 5.6 SB

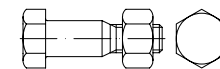

Sechskant-Passschrauben für Stahlkonstruktionen, Mu = mit Sechskantmutter

für nicht planmäßig vorgespannte Verbindungen im Stahlbau

Maße → **TI-57** Anziehmomente → **TI-248**
 Werkstoffeigensch. → **TI-232**

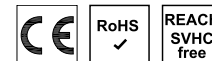

M 12	x	35	S	100	1340,00
M 12	x	40	S	100	1470,00
M 12	x	45	S	100	1520,00
M 12	x	50	S	100	1570,00
M 12	x	55	S	100	1630,00
M 12	x	60	S	100	1760,00
M 12	x	70	S	50	2060,00
M 16	x	35	S	50	880,00
M 16	x	40	S	50	920,00
M 16	x	45	S	50	940,00

Abmessungen	VE	Stück	€/100/Obf.
M 16 x 50	S	50	960,00
M 16 x 55	S	50	990,00
M 16 x 60	S	50	1010,00
M 16 x 65	S	25	1050,00
M 16 x 70	S	25	1060,00
M 16 x 75	S	25	1080,00
M 16 x 80	S	25	1110,00
M 16 x 90	S	25	1150,00
M 16 x 100	S	25	1610,00
M 16 x 110	S	25	1770,00
M 16 x 120	S	25	1860,00
M 20 x 40	S	25	1080,00
M 20 x 45	S	25	1120,00
M 20 x 50	S	25	1150,00
M 20 x 55	S	25	1210,00
M 20 x 60	S	25	1240,00
M 20 x 65	S	25	1260,00
M 20 x 70	S	25	1300,00
M 20 x 75	S	25	1320,00
M 20 x 80	S	25	1350,00
M 20 x 85	S	25	1470,00
M 20 x 90	S	25	1420,00
M 20 x 100	S	25	1480,00
M 20 x 110	S	25	1920,00
M 20 x 120	S	25	2010,00
M 20 x 130	S	25	2210,00
M 24 x 50	S	25	1240,00
M 24 x 55	S	25	1260,00
M 24 x 60	S	25	1280,00
M 24 x 65	S	25	1320,00
M 24 x 70	S	25	1350,00
M 24 x 75	S	25	1370,00
M 24 x 80	S	25	1410,00
M 24 x 85	S	10	1540,00
M 24 x 90	S	10	1470,00
M 24 x 95	S	10	1640,00
M 24 x 100	S	10	1540,00
M 24 x 105	S	10	1870,00
M 24 x 110	S	10	1950,00
M 24 x 115	S	10	2550,00
M 24 x 120	S	10	2050,00
M 24 x 125	S	10	2700,00
M 24 x 130	S	10	2550,00
M 24 x 140	S	10	2700,00
M 27 x 60	S	10	1630,00
M 27 x 65	S	10	1670,00
M 27 x 70	S	10	1720,00
M 27 x 75	S	10	1750,00
M 27 x 80	S	10	1800,00
M 27 x 85	S	10	1940,00
M 27 x 90	S	10	1870,00
M 27 x 95	S	10	2050,00
M 27 x 100	S	10	1940,00
M 27 x 105	S	10	2210,00
M 27 x 110	S	10	2050,00
M 27 x 115	S	10	2850,00
M 27 x 120	S	10	2210,00
M 27 x 130	S	10	2850,00
M 27 x 140	S	10	3000,00
M 30 x 80	S	10	2850,00
M 30 x 90	S	10	3000,00
M 30 x 100	S	10	5500,00
M 30 x 120	S	10	3600,00
M 30 x 130	S	10	3700,00

Abmessungen	VE	Stück	€/100/Obf.
DIN	07968.510		
7968	Mu 5.6	SB	
galvanisch verzinkt			

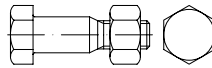

Sechskant-Passschrauben für Stahlkonstruktionen, Mu = mit Sechskantmutter

für nicht planmäßig vorgespannte Verbindungen im Stahlbau

Maße → **TI-57** Korrosionsschutz → **TI-228**
 Werkstoffeigensch. → **TI-232** Anziehmomente → **TI-248**



M 12 x 40	S	100	1480,00 gal Zn
M 12 x 45	S	100	1540,00 gal Zn
M 12 x 50	S	100	1600,00 gal Zn
M 12 x 55	S	100	1650,00 gal Zn
M 16 x 40	S	50	960,00 gal Zn
M 16 x 45	S	50	990,00 gal Zn
M 16 x 50	S	50	1020,00 gal Zn
M 16 x 55	S	50	1050,00 gal Zn
M 16 x 60	S	50	1070,00 gal Zn
M 16 x 70	S	25	1130,00 gal Zn
M 20 x 45	S	25	1210,00 gal Zn
M 20 x 50	S	25	1250,00 gal Zn
M 20 x 55	S	25	1310,00 gal Zn
M 20 x 60	S	25	1340,00 gal Zn
M 20 x 65	S	25	1370,00 gal Zn
M 20 x 70	S	25	1410,00 gal Zn
M 20 x 75	S	25	1430,00 gal Zn
M 20 x 80	S	25	1460,00 gal Zn
M 20 x 90	S	25	1550,00 gal Zn
M 20 x 100	S	25	1640,00 gal Zn
M 24 x 60	S	25	1440,00 gal Zn
M 24 x 65	S	25	1470,00 gal Zn
M 24 x 70	S	25	1520,00 gal Zn
M 24 x 75	S	25	1550,00 gal Zn
M 24 x 80	S	25	1580,00 gal Zn
M 24 x 90	S	10	1660,00 gal Zn
M 24 x 100	S	10	1750,00 gal Zn
M 24 x 105	S	10	2070,00 gal Zn

Abmessungen	VE	Stück	€/100/Obf.
DIN	07968.520		
7968	Mu 5.6	SB	
feuerverzinkt			

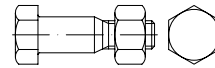

Sechskant-Passschrauben für Stahlkonstruktionen, Mu = mit Sechskantmutter

für nicht planmäßig vorgespannte Verbindungen im Stahlbau

Achtung! Infoeinblender beachten.

Maße → **TI-57** Korrosionsschutz → **TI-231**
 Werkstoffeigensch. → **TI-232** Anziehmomente → **TI-248**

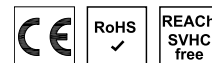

M 12 x 35	S	100	1370,00 tZn
M 12 x 40	S	100	1510,00 tZn
M 12 x 45	S	100	1550,00 tZn
M 12 x 50	S	100	1610,00 tZn
M 12 x 55	S	100	1660,00 tZn
M 12 x 60	S	100	1820,00 tZn
M 12 x 70	S	50	2120,00 tZn
M 12 x 80	S	50	2330,00 tZn
M 12 x 90	S	50	2450,00 tZn
M 12 x 100	S	50	2650,00 tZn
M 16 x 40	S	50	990,00 tZn
M 16 x 45	S	50	1020,00 tZn
M 16 x 50	S	50	1050,00 tZn
M 16 x 55	S	50	1070,00 tZn
M 16 x 60	S	50	1110,00 tZn
M 16 x 65	S	25	1130,00 tZn
M 16 x 70	S	25	1150,00 tZn
M 16 x 75	S	25	1180,00 tZn
M 16 x 80	S	25	1210,00 tZn
M 16 x 90	S	25	1260,00 tZn
M 16 x 100	S	25	1750,00 tZn
M 16 x 110	S	25	1920,00 tZn
M 20 x 40	S	25	1210,00 tZn
M 20 x 45	S	25	1250,00 tZn
M 20 x 50	S	25	1310,00 tZn
M 20 x 55	S	25	1360,00 tZn
M 20 x 60	S	25	1380,00 tZn
M 20 x 65	S	25	1430,00 tZn
M 20 x 70	S	25	1470,00 tZn
M 20 x 75	S	25	1510,00 tZn
M 20 x 80	S	25	1530,00 tZn
M 20 x 85	S	25	1660,00 tZn
M 20 x 90	S	25	1630,00 tZn
M 20 x 100	S	25	1710,00 tZn
M 20 x 110	S	25	2150,00 tZn
M 20 x 120	S	25	2260,00 tZn
M 20 x 130	S	25	2460,00 tZn

Achtung!

Feuerverzinkte Schrauben-/Muttern-Garnituren dürfen nur miteinander verschraubt werden, wenn Gewindespiel/-Toleranzen dieser Garnituren entsprechend ISO 10684 passend aufeinander abgestimmt sind. Die Verwendung mit anderen Schrauben-/Muttern-Ausführungen kann zu Verschraubungsproblemen und/oder zum Versagen der Verbindung führen.



Abmessungen	VE	Stück	€/100/Obf.
M 20 x 140	S	25	2600,00 tZn
M 24 x 60	S	25	1530,00 tZn
M 24 x 65	S	25	1570,00 tZn
M 24 x 70	S	25	1610,00 tZn
M 24 x 75	S	25	1650,00 tZn
M 24 x 80	S	25	1700,00 tZn
M 24 x 90	S	10	1770,00 tZn
M 24 x 100	S	10	1860,00 tZn

DIN	07968.804	
7968	Mu 8.8	SB

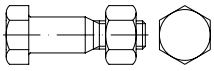

Sechskant-Passschrauben für Stahlkonstruktionen, Mu = mit Sechskantmutter

für nicht planmäßig vorgespannte Verbindungen im Stahlbau

Maße → **TI-57** Anziehmomente → **TI-248**
 Werkstoffeigensch. → **TI-232**



M 12 x 35	S	1	445,00
M 12 x 40	S	1	470,00
M 12 x 45	S	1	510,00
M 12 x 50	S	1	520,00
M 12 x 55	S	1	530,00
M 12 x 60	S	1	530,00
M 12 x 70	S	1	730,00
M 16 x 40	S	1	720,00
M 16 x 45	S	1	740,00
M 16 x 50	S	1	770,00
M 16 x 55	S	1	790,00
M 16 x 60	S	1	830,00
M 16 x 65	S	1	840,00
M 16 x 70	S	1	860,00
M 16 x 80	S	1	910,00
M 20 x 50	S	1	960,00
M 20 x 55	S	1	990,00
M 20 x 60	S	1	1020,00
M 20 x 65	S	1	1030,00
M 20 x 70	S	1	1070,00
M 20 x 75	S	1	1140,00
M 20 x 80	S	1	1140,00
M 20 x 90	S	1	1180,00
M 20 x 100	S	1	1260,00
M 24 x 60	S	1	1410,00
M 24 x 70	S	1	1510,00
M 24 x 80	S	1	1570,00
M 24 x 85	S	1	1740,00
M 24 x 90	S	1	1740,00
M 24 x 100	S	1	1830,00

Abmessungen	VE	Stück	€/100/Obf.
DIN	07969.410		
7969	Mu 4.6		SB
galvanisch verzinkt			

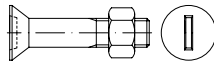

Senkschrauben mit Schlitz für Stahlkonstruktionen, Mu = mit Sechskantmutter

für nicht planmäßig vorgespannte Verbindungen im Stahlbau

Maße → **TI-57** Anziehmomente → **TI-248**
 Werkstoffeigensch. → **TI-232** REACH → **TI-262**
 Korrosionsschutz → **TI-228**



M 12 x 30	S	100	750,00 gal Zn
M 12 x 35	S	100	750,00 gal Zn
M 12 x 40	S	100	710,00 gal Zn
M 12 x 45	S	100	710,00 gal Zn
M 12 x 50	S	100	650,00 gal Zn
M 12 x 55	S	100	580,00 gal Zn
M 12 x 60	S	100	620,00 gal Zn
M 12 x 65	S	50	650,00 gal Zn
M 12 x 70	S	50	690,00 gal Zn
M 12 x 80	S	50	740,00 gal Zn
M 16 x 30	S	50	850,00 gal Zn
M 16 x 35	S	50	850,00 gal Zn
M 16 x 40	S	50	830,00 gal Zn
M 16 x 45	S	50	830,00 gal Zn
M 16 x 50	S	50	820,00 gal Zn
M 16 x 55	S	50	750,00 gal Zn
M 16 x 60	S	50	890,00 gal Zn
M 16 x 65	S	25	1070,00 gal Zn
M 16 x 70	S	25	1150,00 gal Zn
M 16 x 75	S	25	1190,00 gal Zn
M 16 x 80	S	25	1230,00 gal Zn
M 16 x 90	S	25	1300,00 gal Zn
M 16 x 100	S	25	1360,00 gal Zn
M 16 x 140	S	25	1520,00 gal Zn
M 20 x 45	S	25	1320,00 gal Zn
M 20 x 50	S	25	1320,00 gal Zn
M 20 x 55	S	25	1330,00 gal Zn
M 20 x 60	S	25	1360,00 gal Zn
M 20 x 65	S	25	1400,00 gal Zn
M 20 x 70	S	25	1440,00 gal Zn
M 20 x 75	S	25	1450,00 gal Zn
M 20 x 80	S	25	1480,00 gal Zn
M 20 x 90	S	25	1540,00 gal Zn
M 20 x 100	S	25	1580,00 gal Zn
M 24 x 60	S	25	2360,00 gal Zn
M 24 x 70	S	25	2450,00 gal Zn
M 24 x 80	S	25	2600,00 gal Zn
M 24 x 90	S	10	2700,00 gal Zn
M 24 x 100	S	10	2800,00 gal Zn
M 24 x 110	S	10	2900,00 gal Zn
M 24 x 120	S	10	3050,00 gal Zn

Abmessungen	VE	Stück	€/100/Obf.
DIN	07969.420		
7969	Mu 4.6		SB
feuerverzinkt			

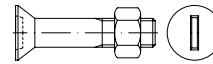

Senkschrauben mit Schlitz für Stahlkonstruktionen, Mu = mit Sechskantmutter

für nicht planmäßig vorgespannte Verbindungen im Stahlbau

Achtung! Infoeinblender beachten.

Maße → **TI-57** Anziehmomente → **TI-248**
 Werkstoffeigensch. → **TI-232** REACH → **TI-262**
 Korrosionsschutz → **TI-231**



M 12 x 35	S	100	760,00 tZn
M 12 x 40	S	100	720,00 tZn
M 12 x 45	S	100	720,00 tZn
M 16 x 45	S	50	850,00 tZn
M 16 x 50	S	50	830,00 tZn

Achtung!

Feuerverzinkte Schrauben-/Mutter-Garnituren dürfen nur miteinander verschraubt werden, wenn Gewindegewinde-Toleranzen dieser Garnituren entsprechend ISO 10684 passend aufeinander abgestimmt sind. Die Verwendung mit anderen Schrauben-/Mutter-Ausführungen kann zu Verschraubungsproblemen und/oder zum Versagen der Verbindung führen.



DIN	07976.013	
7976	Stahl gehärtet	Form C
galvanisch verzinkt		



Sechskant-Blehschrauben, C = mit Spitze gehärtet

Maße → **TI-46** Montage → **TI-251**
 Korrosionsschutz → **TI-228** Normumstellung → **TI-11**

Rostfrei → **S. 575**

DIN 7976 → wird ersetzt durch ISO 1479

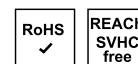

C 2,9 x 6,5	S	2000	5,40 gal Zn
C 2,9 x 9,5	S	2000	5,00 gal Zn
C 2,9 x 13	S	2000	5,30 gal Zn
C 2,9 x 16	S	2000	6,30 gal Zn

Abmessungen	VE	Stück	€/100/Obf.
C 2,9 x 19	S	2000	6,50 gal Zn
C 3,5 x 6,5	S	1000	5,80 gal Zn
C 3,5 x 9,5	S	1000	3,35 gal Zn
C 3,5 x 13	S	1000	3,95 gal Zn
C 3,5 x 16	S	1000	4,20 gal Zn
C 3,5 x 19	S	1000	4,60 gal Zn
C 3,5 x 22	S	1000	4,95 gal Zn
C 3,5 x 25	S	1000	5,20 gal Zn
C 3,9 x 6,5	S	1000	6,50 gal Zn
C 3,9 x 9,5	S	1000	5,00 gal Zn
C 3,9 x 13	S	1000	5,30 gal Zn
C 3,9 x 16	S	1000	6,80 gal Zn
C 3,9 x 19	S	1000	4,95 gal Zn
C 3,9 x 22	S	500	5,70 gal Zn
C 3,9 x 25	S	500	6,20 gal Zn
C 3,9 x 32	S	500	9,10 gal Zn
C 4,2 x 9,5	S	1000	5,40 gal Zn
C 4,2 x 13	S	1000	5,70 gal Zn
C 4,2 x 16	S	1000	6,90 gal Zn
C 4,2 x 19	S	500	7,20 gal Zn
C 4,2 x 22	S	500	7,70 gal Zn
C 4,2 x 25	S	500	8,90 gal Zn
C 4,2 x 32	S	500	9,10 gal Zn
C 4,2 x 38	S	500	10,60 gal Zn
C 4,2 x 45	S	500	15,50 gal Zn
C 4,2 x 50	S	500	20,40 gal Zn
C 4,8 x 9,5	S	500	7,20 gal Zn
C 4,8 x 13	S	500	5,90 gal Zn
C 4,8 x 16	S	500	7,20 gal Zn
C 4,8 x 19	S	500	7,60 gal Zn
C 4,8 x 22	S	500	10,90 gal Zn
C 4,8 x 25	S	500	11,30 gal Zn
C 4,8 x 32	S	250	14,30 gal Zn
C 4,8 x 38	S	250	16,50 gal Zn
C 4,8 x 45	S	250	29,50 gal Zn
C 4,8 x 50	S	250	33,50 gal Zn
C 5,5 x 13	S	500	9,10 gal Zn
C 5,5 x 16	S	500	9,90 gal Zn
C 5,5 x 19	S	500	10,60 gal Zn
C 5,5 x 22	S	500	12,10 gal Zn
C 5,5 x 25	S	250	15,00 gal Zn
C 5,5 x 32	S	250	16,60 gal Zn
C 5,5 x 38	S	250	18,60 gal Zn
C 5,5 x 45	S	250	36,50 gal Zn
C 5,5 x 50	S	250	42,50 gal Zn
C 5,5 x 60	S	250	53,00 gal Zn
C 6,3 x 13	S	250	10,60 gal Zn
C 6,3 x 16	S	250	10,90 gal Zn
C 6,3 x 19	S	250	12,10 gal Zn
C 6,3 x 22	S	250	13,00 gal Zn
C 6,3 x 25	S	250	15,80 gal Zn
C 6,3 x 32	S	250	18,00 gal Zn
C 6,3 x 38	S	250	19,70 gal Zn
C 6,3 x 45	S	250	28,00 gal Zn
C 6,3 x 50	S	250	32,50 gal Zn
C 6,3 x 60	S	250	94,00 gal Zn
C 6,3 x 70	S	250	115,00 gal Zn
C 6,3 x 80	S	250	143,00 gal Zn
C 8,0 x 16	S	250	29,00 gal Zn
C 8,0 x 19	S	250	29,50 gal Zn
C 8,0 x 22	S	250	41,00 gal Zn
C 8,0 x 25	S	250	39,50 gal Zn
C 8,0 x 32	S	250	43,00 gal Zn
C 8,0 x 38	S	250	44,00 gal Zn
C 8,0 x 45	S	250	60,00 gal Zn
C 8,0 x 50	S	250	66,00 gal Zn
C 8,0 x 60	S	200	84,00 gal Zn
C 8,0 x 80	S	200	119,00 gal Zn

Abmessungen VE Stück €/100/Obf.

DIN 07976.015
7976 **Stahl gehärtet** **Form F**
galvanisch verzinkt



Sechskant-Blechsrauben, F = mit Zapfen
 gehärtet

Maße → **TI-46** Montage → **TI-251**
 Korrosionsschutz → **TI-228** Normumstellung → **TI-11**

DIN 7976 → wird ersetzt durch ISO 1479



4,2 x 9,5 -F	S	500	9,70 gal Zn
4,2 x 13 -F	S	500	10,00 gal Zn
4,2 x 16 -F	S	500	10,00 gal Zn
4,2 x 19 -F	S	500	10,00 gal Zn
4,2 x 25 -F	S	500	10,30 gal Zn
4,8 x 9,5 -F	S	500	9,70 gal Zn
4,8 x 13 -F	S	500	8,50 gal Zn
4,8 x 16 -F	S	500	9,70 gal Zn
4,8 x 19 -F	S	250	10,00 gal Zn
4,8 x 22 -F	S	250	10,20 gal Zn
4,8 x 25 -F	S	500	10,30 gal Zn
6,3 x 16 -F	S	250	15,40 gal Zn
6,3 x 19 -F	S	250	17,00 gal Zn
6,3 x 22 -F	S	250	20,40 gal Zn
6,3 x 25 -F	S	250	21,70 gal Zn

DIN 07977.000

7977 **Stahl**

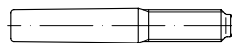

Kegelstifte mit Gewindezapfen und konstanter Zapfenlänge, Kegel 1 : 50

Maße → **TI-117** REACH → **TI-262**
 Normumstellung → **TI-10**

DIN 7977 → wird ersetzt durch ISO 8737, Ausf. mit konstanten Kegellängen → DIN 258



5 x 40	S	25	138,00
5 x 45	S	25	148,00
5 x 50	S	25	155,00
6 x 40	S	25	165,00
6 x 45	S	25	175,00
6 x 50	S	25	175,00
6 x 55	S	10	224,00
6 x 60	S	10	190,00
8 x 50	S	10	235,00
8 x 55	S	10	235,00
8 x 60	S	10	240,00
8 x 65	S	10	250,00
8 x 75	S	10	270,00
8 x 85	S	10	340,00

Abmessungen VE Stück €/100/Obf.

8 x 100	S	10	430,00
10 x 50	S	10	315,00
10 x 60	S	10	330,00
10 x 65	S	10	330,00
10 x 75	S	10	345,00
10 x 85	S	10	385,00
10 x 100	S	10	420,00
10 x 120	S	1	590,00
12 x 75	S	10	455,00
12 x 80	S	10	590,00
12 x 85	S	10	470,00
12 x 100	S	10	540,00
12 x 120	S	10	740,00
12 x 140	S	5	760,00
13 x 75	S	10	680,00
13 x 85	S	10	660,00
13 x 100	S	10	720,00
13 x 140	S	10	1120,00
14 x 85	S	10	540,00
14 x 100	S	10	620,00
16 x 85	S	5	720,00
16 x 100	S	5	760,00
16 x 120	S	5	960,00
16 x 140	S	1	1210,00
16 x 160	S	5	1280,00
20 x 100	S	1	1260,00
20 x 120	S	1	1310,00
20 x 140	S	1	1410,00
20 x 160	S	1	1540,00
20 x 190	S	1	5900,00

DIN 07978.001

7978 **Stahl** **Ausführung A**

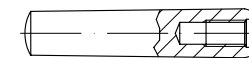

Kegelstifte mit Innengewinde, Kegel 1 : 50, A = geschliffen

Maße → **TI-118** REACH → **TI-262**
 Normumstellung → **TI-10**

DIN 7978 → wird ersetzt durch ISO 8736



A 6 x 16	S	25	155,00
A 6 x 20	S	25	158,00
A 6 x 24	S	25	171,00
A 6 x 26	S	25	172,00
A 6 x 28	S	25	177,00
A 6 x 30	S	25	181,00
A 6 x 32	S	25	183,00
A 6 x 36	S	25	190,00
A 6 x 40	S	25	190,00
A 6 x 45	S	25	197,00
A 6 x 50	S	25	204,00
A 6 x 55	S	25	211,00
A 6 x 60	S	25	265,00
A 6 x 70	S	25	300,00
A 6 x 80	S	25	325,00
A 8 x 20	S	10	204,00
A 8 x 24	S	10	217,00
A 8 x 26	S	10	222,00
A 8 x 28	S	10	224,00
A 8 x 30	S	10	229,00
A 8 x 32	S	10	233,00
A 8 x 36	S	10	241,00

Abmessungen	VE	Stück	€/100/Obf.
A 8 x 40	S	10	244,00
A 8 x 45	S	10	260,00
A 8 x 50	S	10	265,00
A 8 x 55	S	10	275,00
A 8 x 60	S	10	280,00
A 8 x 70	S	10	315,00
A 8 x 80	S	10	335,00
A 8 x 90	S	10	365,00
A 8 x 100	S	10	480,00
A 10 x 28	S	10	275,00
A 10 x 30	S	10	280,00
A 10 x 32	S	10	285,00
A 10 x 36	S	10	295,00
A 10 x 40	S	10	300,00
A 10 x 45	S	10	315,00
A 10 x 50	S	10	325,00
A 10 x 55	S	10	335,00
A 10 x 60	S	10	340,00
A 10 x 70	S	10	395,00
A 10 x 80	S	10	430,00
A 10 x 90	S	10	470,00
A 10 x 100	S	10	510,00
A 10 x 120	S	5	1400,00
A 12 x 36	S	10	370,00
A 12 x 40	S	10	385,00
A 12 x 45	S	10	395,00
A 12 x 50	S	10	415,00
A 12 x 55	S	10	425,00
A 12 x 60	S	10	445,00
A 12 x 70	S	10	480,00
A 12 x 80	S	10	540,00
A 12 x 90	S	10	580,00
A 12 x 100	S	10	620,00
A 16 x 40	S	10	560,00
A 16 x 45	S	10	590,00
A 16 x 50	S	10	620,00
A 16 x 55	S	10	650,00
A 16 x 60	S	10	680,00
A 16 x 70	S	5	730,00
A 16 x 80	S	5	780,00
A 16 x 90	S	5	840,00
A 16 x 100	S	5	920,00
A 16 x 120	S	5	3450,00
A 20 x 50	S	1	1240,00
A 20 x 55	S	1	1310,00
A 20 x 60	S	1	1370,00
A 20 x 70	S	1	1440,00
A 20 x 80	S	1	1540,00
A 20 x 90	S	1	1700,00
A 20 x 100	S	1	1840,00
A 20 x 120	S	1	2160,00

Abmessungen	VE	Stück	€/100/Obf.
DIN 07979.004			

7979 **Stahl** **Form D/m 6**



**Zylinderstifte mit Innengewinde,
D = gehärtet, Toleranzfeld m6**

Maße → **TI-116** REACH → **TI-262**
 Normumstellung → **TI-10**

DIN 7979 → wird ersetzt durch ISO 8735,
 Ø 4 und 5 nicht genormt



D 4 x 10	S	100	385,00
D 4 x 12	S	100	385,00
D 4 x 14	S	100	385,00
D 4 x 16	S	100	280,00
D 4 x 18	S	100	275,00
D 4 x 20	S	100	270,00
D 4 x 24	S	100	440,00
D 5 x 10	S	100	128,00
D 5 x 12	S	100	128,00
D 5 x 14	S	100	128,00
D 5 x 16	S	100	128,00
D 5 x 18	S	100	135,00
D 5 x 20	S	100	135,00
D 5 x 24	S	100	142,00
D 5 x 28	S	100	148,00
D 5 x 30	S	100	155,00
D 5 x 32	S	100	160,00
D 5 x 36	S	100	167,00
D 5 x 40	S	100	176,00
D 5 x 45	S	100	180,00
D 5 x 50	S	100	186,00
D 6 x 10	S	100	244,00
D 6 x 12	S	100	236,00
D 6 x 14	S	100	212,00
D 6 x 16	S	100	135,00
D 6 x 18	S	100	138,00
D 6 x 20	S	100	142,00
D 6 x 22	S	100	146,00
D 6 x 24	S	100	148,00
D 6 x 26	S	100	152,00
D 6 x 28	S	100	155,00
D 6 x 30	S	100	160,00
D 6 x 32	S	100	163,00
D 6 x 36	S	100	171,00
D 6 x 40	S	100	177,00
D 6 x 45	S	100	187,00
D 6 x 50	S	100	195,00
D 6 x 55	S	100	205,00
D 6 x 60	S	100	213,00
D 6 x 70	S	100	355,00
D 6 x 80	S	100	485,00
D 8 x 12	S	100	132,00
D 8 x 16	S	100	187,00
D 8 x 18	S	100	192,00
D 8 x 20	S	100	195,00
D 8 x 24	S	100	205,00
D 8 x 26	S	100	212,00
D 8 x 28	S	100	217,00
D 8 x 30	S	100	224,00
D 8 x 32	S	100	227,00
D 8 x 36	S	100	239,00
D 8 x 40	S	100	249,00
D 8 x 45	S	100	265,00

Abmessungen	VE	Stück	€/100/Obf.
D 8 x 50	S	100	275,00
D 8 x 55	S	100	290,00
D 8 x 60	S	100	325,00
D 8 x 70	S	100	335,00
D 8 x 80	S	100	365,00
D 8 x 90	S	100	480,00
D 8 x 100	S	100	570,00
D 10 x 18	S	100	255,00
D 10 x 20	S	100	235,00
D 10 x 24	S	100	245,00
D 10 x 28	S	100	295,00
D 10 x 30	S	100	295,00
D 10 x 32	S	100	310,00
D 10 x 36	S	100	330,00
D 10 x 40	S	100	340,00
D 10 x 45	S	100	385,00
D 10 x 50	S	100	385,00
D 10 x 55	S	100	410,00
D 10 x 60	S	100	420,00
D 10 x 70	S	100	460,00
D 10 x 80	S	100	510,00
D 10 x 90	S	50	560,00
D 10 x 100	S	50	590,00
D 10 x 120	S	50	680,00
D 12 x 20	S	100	345,00
D 12 x 24	S	100	305,00
D 12 x 28	S	100	325,00
D 12 x 30	S	100	345,00
D 12 x 32	S	100	370,00
D 12 x 36	S	100	395,00
D 12 x 40	S	100	420,00
D 12 x 45	S	100	445,00
D 12 x 50	S	100	470,00
D 12 x 55	S	100	495,00
D 12 x 60	S	100	530,00
D 12 x 70	S	50	570,00
D 12 x 80	S	50	630,00
D 12 x 90	S	50	690,00
D 12 x 100	S	50	730,00
D 12 x 120	S	50	1050,00
D 14 x 32	S	50	295,00
D 14 x 40	S	50	600,00
D 14 x 50	S	50	650,00
D 14 x 60	S	50	680,00
D 14 x 80	S	50	960,00
D 16 x 28	S	50	730,00
D 16 x 30	S	50	730,00
D 16 x 32	S	50	730,00
D 16 x 36	S	50	730,00
D 16 x 40	S	50	730,00
D 16 x 45	S	50	780,00
D 16 x 50	S	50	860,00
D 16 x 55	S	50	950,00
D 16 x 60	S	1	1010,00
D 16 x 70	S	1	1070,00
D 16 x 80	S	1	1170,00
D 16 x 90	S	1	1250,00
D 16 x 100	S	1	1370,00
D 16 x 120	S	1	1540,00
D 20 x 36	S	1	840,00
D 20 x 40	S	1	910,00
D 20 x 45	S	1	950,00
D 20 x 50	S	1	970,00
D 20 x 55	S	1	1070,00
D 20 x 60	S	1	1140,00
D 20 x 70	S	1	1240,00
D 20 x 80	S	1	1300,00
D 20 x 90	S	1	1430,00
D 20 x 100	S	1	1530,00
D 20 x 120	S	1	2000,00
D 20 x 140	S	1	2550,00
D 20 x 150	S	1	2850,00
D 20 x 160	S	1	3150,00
D 20 x 180	S	1	3800,00
D 20 x 200	S	1	4250,00



- ✓ Große Artikelvielfalt
- ✓ Verlässliche Qualität
- ✓ Hohe Lieferbereitschaft

Abmessungen	VE	Stück	€/100/Obf.
D 25 x 50	S	1	1300,00
D 25 x 60	S	1	5400,00
D 25 x 70	S	1	5900,00
D 25 x 80	S	1	6200,00
D 25 x 100	S	1	6600,00
D 25 x 120	S	1	7600,00
D 25 x 130	S	1	8200,00
D 30 x 55	S	1	2600,00
D 30 x 60	S	1	2700,00
D 30 x 70	S	1	2750,00
D 30 x 80	S	1	3000,00
D 30 x 100	S	1	3400,00
D 30 x 120	S	1	3900,00
D 40 x 60	S	1	4850,00
D 40 x 70	S	1	5000,00
D 40 x 80	S	1	5100,00
D 40 x 90	S	1	5400,00
D 40 x 100	S	1	5700,00

~DIN 07980.000

7980 Federstahl



Federringe für Zylinderschrauben

Achtung! Nur für Schrauben mit Festigkeitsklasse < 8.8.

Maße → **TI-100**

Rostfrei → **S. 575**

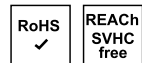

3	S	1000	1,05
3	K	100	3,75
4	S	1000	1,30
4	K	100	4,15
5	S	1000	1,70
5	K	100	4,55
6	S	1000	1,95
6	K	100	4,95
8	S	1000	3,95
8	K	100	7,20
10	S	1000	5,80
10	K	100	8,90
12	S	500	6,90
12	K	100	10,30
14	S	500	10,60
14	K	100	13,80
16	S	250	15,40
16	K	100	19,40
18	S	250	17,00
18	K	100	23,60
20	S	100	31,50
22	S	100	34,00
24	S	100	44,50
27	S	100	51,00
30	S	50	103,00
33	S	50	115,00
36	S	50	151,00
42	S	25	270,00
48	S	25	280,00

Abmessungen	VE	Stück	€/100/Obf.
~DIN	07980.010		
7980	Federstahl galvanisch verzinkt		



Federringe für Zylinderschrauben

Achtung! Nur für Schrauben mit Festigkeitsklasse < 8.8.

Maße → **TI-100**

Korrosionsschutz → **TI-228**

Rostfrei → **S. 575**



3	S	1000	1,05 gal Zn
3	K	100	3,85 gal Zn
4	S	1000	1,55 gal Zn
4	K	100	4,30 gal Zn
5	S	1000	2,15 gal Zn
5	K	100	4,95 gal Zn
6	S	1000	2,30 gal Zn
6	K	100	5,30 gal Zn
8	S	1000	5,00 gal Zn
8	K	100	8,30 gal Zn
10	S	1000	7,70 gal Zn
10	K	100	10,80 gal Zn
12	S	500	9,20 gal Zn
12	K	100	12,80 gal Zn
14	S	500	14,30 gal Zn
14	K	100	18,20 gal Zn
16	S	250	21,30 gal Zn
16	K	100	26,00 gal Zn
18	S	250	23,40 gal Zn
18	K	100	28,50 gal Zn
20	S	100	44,50 gal Zn
22	S	100	48,50 gal Zn
24	S	100	63,00 gal Zn
27	S	100	69,00 gal Zn
30	S	50	141,00 gal Zn
33	S	50	157,00 gal Zn
36	S	50	211,00 gal Zn
42	S	25	330,00 gal Zn
48	S	25	390,00 gal Zn

Abmessungen	VE	Stück	€/100/Obf.
DIN	07981.014		
7981	Stahl Form C-H galvanisch verzinkt		

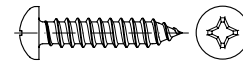

Linsen-Blechschruben mit Phillips-Kreuzschlitz H, C = mit Spitze

gehärtet, Nennlänge ab 60 mm mit Teilgewinde

Maße → **TI-46**

Montage → **TI-251**

Korrosionsschutz → **TI-228**

Normumstellung → **TI-11**

Rostfrei → **S. 575**

DIN 7981 → wird ersetzt durch ISO 7049

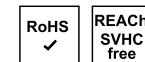

C2,2	x	4,5-H	S	2000	6,30 gal Zn
C2,2	x	6,5-H	S	2000	4,55 gal Zn
C2,2	x	6,5-H	K	100	7,00 gal Zn
C2,2	x	9,5-H	S	2000	4,25 gal Zn
C2,2	x	13 -H	S	2000	4,55 gal Zn
C2,2	x	16 -H	S	2000	5,50 gal Zn
C2,2	x	19 -H	S	2000	7,20 gal Zn
C2,2	x	22 -H	S	2000	8,90 gal Zn
C2,9	x	6,5-H	K	100	5,60 gal Zn
C2,9	x	6,5-H	S	2000	2,60 gal Zn
C2,9	x	9,5-H	S	2000	2,30 gal Zn
C2,9	x	9,5-H	K	100	5,40 gal Zn
C2,9	x	13 -H	S	2000	2,45 gal Zn
C2,9	x	13 -H	K	100	5,50 gal Zn
C2,9	x	16 -H	S	2000	2,60 gal Zn
C2,9	x	16 -H	K	100	5,60 gal Zn
C2,9	x	19 -H	S	2000	3,70 gal Zn
C2,9	x	19 -H	K	100	6,70 gal Zn
C2,9	x	22 -H	S	2000	4,60 gal Zn
C2,9	x	22 -H	K	100	7,70 gal Zn
C2,9	x	25 -H	S	1000	4,95 gal Zn
C2,9	x	25 -H	K	100	7,90 gal Zn
C2,9	x	32 -H	S	1000	5,90 gal Zn
C3,5	x	6,5-H	S	1000	3,60 gal Zn
C3,5	x	6,5-H	K	100	6,60 gal Zn
C3,5	x	9,5-H	S	1000	2,75 gal Zn
C3,5	x	9,5-H	K	100	5,70 gal Zn
C3,5	x	13 -H	S	1000	2,85 gal Zn
C3,5	x	13 -H	K	100	5,90 gal Zn
C3,5	x	16 -H	S	1000	3,00 gal Zn
C3,5	x	16 -H	K	100	6,00 gal Zn
C3,5	x	19 -H	S	1000	3,75 gal Zn
C3,5	x	19 -H	K	100	6,80 gal Zn
C3,5	x	22 -H	S	1000	5,30 gal Zn
C3,5	x	22 -H	K	100	8,30 gal Zn
C3,5	x	25 -H	S	500	5,50 gal Zn
C3,5	x	25 -H	K	100	8,60 gal Zn
C3,5	x	32 -H	S	500	6,00 gal Zn
C3,5	x	32 -H	K	100	9,00 gal Zn
C3,5	x	38 -H	S	500	6,70 gal Zn
C3,5	x	38 -H	K	100	9,60 gal Zn
C3,5	x	45 -H	S	500	10,90 gal Zn
C3,5	x	50 -H	S	500	13,20 gal Zn
C3,9	x	6,5-H	S	2000	6,50 gal Zn
C3,9	x	9,5-H	S	1000	3,25 gal Zn
C3,9	x	9,5-H	K	100	6,20 gal Zn
C3,9	x	13 -H	S	1000	3,30 gal Zn
C3,9	x	13 -H	K	100	6,30 gal Zn
C3,9	x	16 -H	S	1000	3,60 gal Zn
C3,9	x	16 -H	K	100	6,70 gal Zn

Abmessungen	VE	Stück	€/100/Obf.	Abmessungen	VE	Stück	€/100/Obf.	Abmessungen	VE	Stück	€/100/Obf.
C3,9 x 19 -H	S	1000	4,10 gal Zn	C5,5 x 45 -H	S	250	18,00 gal Zn	2,9 x 25 -C-Z	K	100	7,90 gal Zn
C3,9 x 19 -H	K	100	7,10 gal Zn	C5,5 x 45 -H	K	100	21,00 gal Zn	2,9 x 32 -C-Z	S	1000	5,90 gal Zn
C3,9 x 22 -H	S	500	5,40 gal Zn	C5,5 x 50 -H	S	250	21,10 gal Zn	3,5 x 6,5 -C-Z	S	1000	3,60 gal Zn
C3,9 x 22 -H	K	100	8,40 gal Zn	C5,5 x 50 -H	K	100	24,00 gal Zn	3,5 x 6,5 -C-Z	K	100	6,60 gal Zn
C3,9 x 25 -H	S	500	6,00 gal Zn	C5,5 x 60 -H	S	250	40,00 gal Zn	3,5 x 9,5 -C-Z	S	1000	2,75 gal Zn
C3,9 x 25 -H	K	100	9,00 gal Zn	C5,5 x 70 -H	S	250	49,50 gal Zn	3,5 x 9,5 -C-Z	K	100	5,70 gal Zn
C3,9 x 32 -H	S	500	6,20 gal Zn	C5,5 x 80 -H	S	250	59,00 gal Zn	3,5 x 13 -C-Z	K	100	5,90 gal Zn
C3,9 x 32 -H	K	100	9,10 gal Zn	C6,3 x 13 -H	S	250	9,50 gal Zn	3,5 x 16 -C-Z	S	1000	3,00 gal Zn
C3,9 x 38 -H	S	500	8,80 gal Zn	C6,3 x 13 -H	K	100	12,40 gal Zn	3,5 x 16 -C-Z	K	100	6,00 gal Zn
C3,9 x 38 -H	K	100	11,70 gal Zn	C6,3 x 16 -H	S	250	9,70 gal Zn	3,5 x 19 -C-Z	S	1000	3,75 gal Zn
C3,9 x 45 -H	S	1000	9,00 gal Zn	C6,3 x 16 -H	K	100	12,60 gal Zn	3,5 x 19 -C-Z	K	100	6,80 gal Zn
C4,2 x 9,5 -H	S	1000	3,40 gal Zn	C6,3 x 19 -H	S	250	9,90 gal Zn	3,5 x 22 -C-Z	S	1000	5,30 gal Zn
C4,2 x 9,5 -H	K	100	6,50 gal Zn	C6,3 x 19 -H	K	100	12,90 gal Zn	3,5 x 22 -C-Z	K	100	8,30 gal Zn
C4,2 x 13 -H	S	1000	3,45 gal Zn	C6,3 x 22 -H	S	250	11,80 gal Zn	3,5 x 25 -C-Z	S	500	5,50 gal Zn
C4,2 x 13 -H	K	100	6,50 gal Zn	C6,3 x 22 -H	K	100	14,80 gal Zn	3,5 x 25 -C-Z	K	100	8,60 gal Zn
C4,2 x 16 -H	S	1000	3,90 gal Zn	C6,3 x 25 -H	S	250	14,30 gal Zn	3,5 x 32 -C-Z	K	100	9,00 gal Zn
C4,2 x 16 -H	K	100	6,90 gal Zn	C6,3 x 25 -H	K	100	17,40 gal Zn	3,5 x 38 -C-Z	S	500	6,70 gal Zn
C4,2 x 19 -H	S	500	4,15 gal Zn	C6,3 x 32 -H	S	250	15,70 gal Zn	3,5 x 38 -C-Z	K	100	9,60 gal Zn
C4,2 x 19 -H	K	100	7,20 gal Zn	C6,3 x 32 -H	K	100	18,70 gal Zn	3,5 x 45 -C-Z	S	500	10,90 gal Zn
C4,2 x 22 -H	S	500	5,70 gal Zn	C6,3 x 38 -H	S	250	19,50 gal Zn	3,5 x 50 -C-Z	S	500	13,20 gal Zn
C4,2 x 22 -H	K	100	8,80 gal Zn	C6,3 x 38 -H	K	100	22,60 gal Zn	3,9 x 6,5 -C-Z	S	2000	6,50 gal Zn
C4,2 x 25 -H	S	500	6,30 gal Zn	C6,3 x 45 -H	S	250	24,00 gal Zn	3,9 x 9,5 -C-Z	S	1000	3,25 gal Zn
C4,2 x 25 -H	K	100	9,40 gal Zn	C6,3 x 45 -H	K	100	27,00 gal Zn	3,9 x 9,5 -C-Z	K	100	6,20 gal Zn
C4,2 x 32 -H	S	500	6,30 gal Zn	C6,3 x 50 -H	S	250	26,00 gal Zn	3,9 x 13 -C-Z	S	1000	3,30 gal Zn
C4,2 x 32 -H	K	100	9,40 gal Zn	C6,3 x 50 -H	K	100	28,50 gal Zn	3,9 x 13 -C-Z	K	100	6,30 gal Zn
C4,2 x 38 -H	S	500	9,10 gal Zn	C6,3 x 60 -H	S	250	45,50 gal Zn	3,9 x 16 -C-Z	S	1000	3,60 gal Zn
C4,2 x 38 -H	K	100	12,10 gal Zn	C6,3 x 70 -H	S	250	65,00 gal Zn	3,9 x 16 -C-Z	K	100	6,70 gal Zn
C4,2 x 45 -H	S	500	10,60 gal Zn	C6,3 x 80 -H	S	250	83,00 gal Zn	3,9 x 19 -C-Z	S	1000	4,10 gal Zn
C4,2 x 45 -H	K	100	13,50 gal Zn	C6,3 x 90 -H	S	250	101,00 gal Zn	3,9 x 19 -C-Z	K	100	7,10 gal Zn
C4,2 x 50 -H	S	500	11,90 gal Zn	C6,3 x 100 -H	S	250	119,00 gal Zn	3,9 x 22 -C-Z	S	500	5,40 gal Zn
C4,2 x 50 -H	K	100	14,90 gal Zn					3,9 x 22 -C-Z	K	100	8,40 gal Zn
C4,2 x 60 -H	S	250	20,30 gal Zn					3,9 x 25 -C-Z	S	500	6,00 gal Zn
C4,2 x 70 -H	S	250	24,00 gal Zn					3,9 x 25 -C-Z	K	100	9,00 gal Zn
C4,2 x 80 -H	S	250	26,50 gal Zn					3,9 x 32 -C-Z	K	100	9,10 gal Zn
C4,8 x 9,5 -H	S	500	4,80 gal Zn					3,9 x 38 -C-Z	S	500	8,80 gal Zn
C4,8 x 9,5 -H	K	100	7,80 gal Zn					3,9 x 38 -C-Z	K	100	11,70 gal Zn
C4,8 x 13 -H	S	500	4,85 gal Zn					4,2 x 9,5 -C-Z	K	100	6,50 gal Zn
C4,8 x 13 -H	K	100	7,90 gal Zn					4,2 x 13 -C-Z	S	1000	3,45 gal Zn
C4,8 x 16 -H	S	500	5,10 gal Zn					4,2 x 13 -C-Z	K	100	6,50 gal Zn
C4,8 x 16 -H	K	100	8,20 gal Zn					4,2 x 16 -C-Z	S	1000	3,90 gal Zn
C4,8 x 19 -H	S	500	5,80 gal Zn					4,2 x 16 -C-Z	K	100	6,90 gal Zn
C4,8 x 19 -H	K	100	8,80 gal Zn					4,2 x 19 -C-Z	S	500	4,15 gal Zn
C4,8 x 22 -H	S	500	6,20 gal Zn					4,2 x 19 -C-Z	K	100	7,20 gal Zn
C4,8 x 22 -H	K	100	9,20 gal Zn					4,2 x 22 -C-Z	S	500	5,70 gal Zn
C4,8 x 25 -H	S	500	7,30 gal Zn					4,2 x 22 -C-Z	K	100	8,80 gal Zn
C4,8 x 25 -H	K	100	10,30 gal Zn					4,2 x 25 -C-Z	K	100	9,40 gal Zn
C4,8 x 32 -H	S	250	8,40 gal Zn					4,2 x 32 -C-Z	S	500	6,30 gal Zn
C4,8 x 32 -H	K	100	11,40 gal Zn					4,2 x 32 -C-Z	K	100	9,40 gal Zn
C4,8 x 38 -H	S	250	9,70 gal Zn					4,2 x 38 -C-Z	S	500	9,10 gal Zn
C4,8 x 38 -H	K	100	12,60 gal Zn					4,2 x 38 -C-Z	K	100	12,10 gal Zn
C4,8 x 45 -H	S	250	13,10 gal Zn					4,2 x 45 -C-Z	S	500	10,60 gal Zn
C4,8 x 45 -H	K	100	16,10 gal Zn					4,2 x 45 -C-Z	K	100	13,50 gal Zn
C4,8 x 50 -H	S	250	14,60 gal Zn					4,2 x 50 -C-Z	S	500	11,90 gal Zn
C4,8 x 50 -H	K	100	17,60 gal Zn					4,2 x 50 -C-Z	K	100	14,90 gal Zn
C4,8 x 60 -H	S	250	23,30 gal Zn					4,2 x 60 -C-Z	S	250	20,30 gal Zn
C4,8 x 70 -H	S	250	31,00 gal Zn					4,2 x 70 -C-Z	S	250	24,00 gal Zn
C4,8 x 80 -H	S	250	37,00 gal Zn					4,2 x 80 -C-Z	S	250	26,50 gal Zn
C4,8 x 90 -H	S	250	45,00 gal Zn					4,8 x 9,5 -C-Z	S	500	4,80 gal Zn
C4,8 x 100 -H	S	250	54,00 gal Zn					4,8 x 9,5 -C-Z	K	100	7,80 gal Zn
C4,8 x 110 -H	S	250	62,00 gal Zn					4,8 x 13 -C-Z	S	500	4,85 gal Zn
C4,8 x 120 -H	S	250	76,00 gal Zn					4,8 x 13 -C-Z	K	100	7,90 gal Zn
C5,5 x 13 -H	S	500	6,50 gal Zn					4,8 x 16 -C-Z	S	500	5,10 gal Zn
C5,5 x 13 -H	K	100	9,60 gal Zn					4,8 x 16 -C-Z	K	100	8,20 gal Zn
C5,5 x 16 -H	S	500	7,20 gal Zn					4,8 x 19 -C-Z	S	500	5,80 gal Zn
C5,5 x 16 -H	K	100	10,20 gal Zn					4,8 x 19 -C-Z	K	100	8,80 gal Zn
C5,5 x 19 -H	S	500	7,60 gal Zn					4,8 x 22 -C-Z	S	500	6,20 gal Zn
C5,5 x 19 -H	K	100	10,60 gal Zn					4,8 x 22 -C-Z	K	100	9,20 gal Zn
C5,5 x 22 -H	S	500	10,60 gal Zn					4,8 x 25 -C-Z	S	500	7,30 gal Zn
C5,5 x 22 -H	K	100	13,50 gal Zn					4,8 x 25 -C-Z	K	100	10,30 gal Zn
C5,5 x 25 -H	S	250	11,20 gal Zn					4,8 x 32 -C-Z	S	250	8,40 gal Zn
C5,5 x 25 -H	K	100	14,20 gal Zn					4,8 x 32 -C-Z	K	100	11,40 gal Zn
C5,5 x 32 -H	S	250	12,90 gal Zn					4,8 x 38 -C-Z	S	250	9,70 gal Zn
C5,5 x 32 -H	K	100	15,90 gal Zn					4,8 x 38 -C-Z	K	100	12,60 gal Zn
C5,5 x 38 -H	S	250	16,00 gal Zn					4,8 x 45 -C-Z	S	250	13,10 gal Zn
C5,5 x 38 -H	K	100	18,90 gal Zn					4,8 x 45 -C-Z	K	100	16,10 gal Zn
				2,2 x 4,5 -C-Z	S	2000	6,30 gal Zn				
				2,2 x 6,5 -C-Z	S	2000	4,55 gal Zn				
				2,2 x 6,5 -C-Z	K	100	7,00 gal Zn				
				2,2 x 9,5 -C-Z	S	2000	4,25 gal Zn				
				2,2 x 13 -C-Z	S	2000	4,55 gal Zn				
				2,2 x 16 -C-Z	S	2000	5,50 gal Zn				
				2,2 x 19 -C-Z	S	2000	7,20 gal Zn				
				2,2 x 22 -C-Z	S	2000	8,90 gal Zn				
				2,9 x 6,5 -C-Z	S	2000	2,60 gal Zn				
				2,9 x 6,5 -C-Z	K	100	5,60 gal Zn				
				2,9 x 9,5 -C-Z	S	2000	2,30 gal Zn				
				2,9 x 9,5 -C-Z	K	100	5,40 gal Zn				
				2,9 x 13 -C-Z	K	100	5,50 gal Zn				
				2,9 x 16 -C-Z	S	2000	2,60 gal Zn				
				2,9 x 16 -C-Z	K	100	5,60 gal Zn				
				2,9 x 19 -C-Z	S	2000	3,70 gal Zn				
				2,9 x 19 -C-Z	K	100	6,70 gal Zn				
				2,9 x 22 -C-Z	S	1000	4,60 gal Zn				
				2,9 x 22 -C-Z	K	100	7,70 gal Zn				
				2,9 x 25 -C-Z	S	1000	4,95 gal Zn				

DIN 07981.016
7981 Stahl Form C-Z
 galvanisch verzinkt

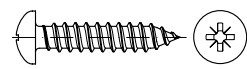

**Linsen-Blehschrauben,
 mit Pozidriv-Kreuzschlitz Z,
 C = mit Spitze**
 gehärtet

Maße → **TI-46** Montage → **TI-251**
 Korrosionsschutz → **TI-228** Normumstellung → **TI-11**

DIN 7981 → wird ersetzt durch ISO 7049

RoHS REACH SVHC free

Abmessungen	VE	Stück	€/100/Obf.
4,8 x 50 -C-Z	S	250	14,60 gal Zn
4,8 x 50 -C-Z	K	100	17,60 gal Zn
4,8 x 60 -C-Z	S	250	23,30 gal Zn
4,8 x 70 -C-Z	S	250	31,00 gal Zn
4,8 x 80 -C-Z	S	250	37,00 gal Zn
4,8 x 90 -C-Z	S	250	45,00 gal Zn
4,8 x 100 -C-Z	S	250	54,00 gal Zn
4,8 x 110 -C-Z	S	250	62,00 gal Zn
4,8 x 120 -C-Z	S	250	76,00 gal Zn
5,5 x 13 -C-Z	S	500	6,50 gal Zn
5,5 x 13 -C-Z	K	100	9,60 gal Zn
5,5 x 16 -C-Z	S	500	7,20 gal Zn
5,5 x 16 -C-Z	K	100	10,20 gal Zn
5,5 x 19 -C-Z	S	500	7,20 gal Zn
5,5 x 19 -C-Z	K	100	10,60 gal Zn
5,5 x 22 -C-Z	S	500	10,60 gal Zn
5,5 x 22 -C-Z	K	100	13,50 gal Zn
5,5 x 25 -C-Z	S	250	11,20 gal Zn
5,5 x 25 -C-Z	K	100	14,20 gal Zn
5,5 x 32 -C-Z	S	250	12,90 gal Zn
5,5 x 32 -C-Z	K	100	15,90 gal Zn
5,5 x 38 -C-Z	S	250	12,90 gal Zn
5,5 x 38 -C-Z	K	100	18,90 gal Zn
5,5 x 45 -C-Z	S	250	18,00 gal Zn
5,5 x 45 -C-Z	K	100	21,00 gal Zn
5,5 x 50 -C-Z	S	250	21,10 gal Zn
5,5 x 50 -C-Z	K	100	24,00 gal Zn
5,5 x 60 -C-Z	S	250	40,00 gal Zn
5,5 x 70 -C-Z	S	250	49,50 gal Zn
5,5 x 80 -C-Z	S	250	59,00 gal Zn
6,3 x 13 -C-Z	S	250	9,50 gal Zn
6,3 x 13 -C-Z	K	100	12,40 gal Zn
6,3 x 16 -C-Z	S	250	9,70 gal Zn
6,3 x 16 -C-Z	K	100	12,60 gal Zn
6,3 x 19 -C-Z	S	250	9,90 gal Zn
6,3 x 19 -C-Z	K	100	12,90 gal Zn
6,3 x 22 -C-Z	S	250	11,80 gal Zn
6,3 x 22 -C-Z	K	100	14,80 gal Zn
6,3 x 25 -C-Z	S	250	14,30 gal Zn
6,3 x 25 -C-Z	K	100	17,40 gal Zn
6,3 x 32 -C-Z	S	250	15,70 gal Zn
6,3 x 32 -C-Z	K	100	18,70 gal Zn
6,3 x 38 -C-Z	S	250	19,50 gal Zn
6,3 x 38 -C-Z	K	100	22,60 gal Zn
6,3 x 45 -C-Z	S	250	24,00 gal Zn
6,3 x 45 -C-Z	K	100	27,00 gal Zn
6,3 x 50 -C-Z	S	250	26,00 gal Zn
6,3 x 50 -C-Z	K	100	28,50 gal Zn
6,3 x 60 -C-Z	S	250	45,50 gal Zn
6,3 x 70 -C-Z	S	250	65,00 gal Zn
6,3 x 80 -C-Z	S	250	83,00 gal Zn
6,3 x 90 -C-Z	S	250	101,00 gal Zn
6,3 x 100 -C-Z	S	250	119,00 gal Zn

Abmessungen VE Stück €/100/Obf.
 ~DIN 07981.308
7981 Stahl Form C-ISR
 galvanisch verzinkt

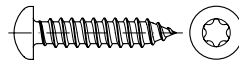

**Linien-Blechschrauben,
 ISR = Innensechsrund
 C = mit Spitze**

gehärtet
 ~ISO 14585

Maße → **TI-46**
 Korrosionsschutz → **TI-228**

Montage → **TI-251**
 Normumstellung → **TI-11**



2,2 x 4,5 -C-T6	S	2000	10,30 gal Zn
2,2 x 6,5 -C-T6	S	2000	9,10 gal Zn
2,2 x 9,5 -C-T6	S	2000	10,90 gal Zn
2,2 x 13 -C-T6	S	2000	11,80 gal Zn
2,2 x 16 -C-T6	S	2000	13,30 gal Zn
2,9 x 6,5 -C-T10	S	2000	3,00 gal Zn
2,9 x 9,5 -C-T10	S	2000	2,70 gal Zn
2,9 x 13 -C-T10	S	2000	2,80 gal Zn
2,9 x 16 -C-T10	S	2000	2,90 gal Zn
2,9 x 19 -C-T10	S	2000	4,25 gal Zn
2,9 x 22 -C-T10	S	2000	5,30 gal Zn
2,9 x 25 -C-T10	S	1000	5,70 gal Zn
3,5 x 9,5 -C-T15	S	1000	3,15 gal Zn
3,5 x 13 -C-T15	S	1000	3,30 gal Zn
3,5 x 16 -C-T15	S	1000	3,40 gal Zn
3,5 x 19 -C-T15	S	1000	4,30 gal Zn
3,5 x 22 -C-T15	S	1000	6,00 gal Zn
3,5 x 25 -C-T15	S	500	6,30 gal Zn
3,5 x 32 -C-T15	S	500	6,80 gal Zn
3,5 x 38 -C-T15	S	500	7,70 gal Zn
3,5 x 45 -C-T15	S	500	11,30 gal Zn
3,5 x 50 -C-T15	S	500	12,30 gal Zn
3,9 x 9,5 -C-T20	S	1000	3,60 gal Zn
3,9 x 13 -C-T20	S	1000	3,75 gal Zn
3,9 x 16 -C-T20	S	1000	4,15 gal Zn
3,9 x 19 -C-T20	S	1000	4,70 gal Zn
3,9 x 22 -C-T20	S	500	6,20 gal Zn
3,9 x 25 -C-T20	S	500	6,80 gal Zn
3,9 x 32 -C-T20	S	500	7,20 gal Zn
3,9 x 38 -C-T20	S	500	10,00 gal Zn
3,9 x 45 -C-T20	S	500	10,20 gal Zn
3,9 x 50 -C-T20	S	500	10,50 gal Zn
4,2 x 9,5 -C-T20	S	1000	3,90 gal Zn
4,2 x 13 -C-T20	S	1000	3,95 gal Zn
4,2 x 16 -C-T20	S	1000	4,45 gal Zn
4,2 x 19 -C-T20	S	500	4,75 gal Zn
4,2 x 22 -C-T20	S	500	6,60 gal Zn
4,2 x 25 -C-T20	S	500	7,20 gal Zn
4,2 x 32 -C-T20	S	500	7,30 gal Zn
4,2 x 38 -C-T20	S	500	10,50 gal Zn
4,2 x 45 -C-T20	S	500	11,90 gal Zn
4,2 x 50 -C-T20	S	500	13,60 gal Zn
4,2 x 60 -C-T20	S	500	23,20 gal Zn
4,2 x 70 -C-T20	S	500	27,50 gal Zn
4,8 x 9,5 -C-T25	S	500	7,90 gal Zn
4,8 x 13 -C-T25	S	500	5,60 gal Zn
4,8 x 16 -C-T25	S	500	5,90 gal Zn
4,8 x 19 -C-T25	S	500	6,70 gal Zn
4,8 x 22 -C-T25	S	500	7,20 gal Zn
4,8 x 25 -C-T25	S	500	8,40 gal Zn
4,8 x 32 -C-T25	S	250	9,60 gal Zn
4,8 x 38 -C-T25	S	250	11,10 gal Zn

Abmessungen	VE	Stück	€/100/Obf.
4,8 x 45 -C-T25	S	250	15,00 gal Zn
4,8 x 50 -C-T25	S	250	16,60 gal Zn
4,8 x 60 -C-T25	S	250	26,50 gal Zn
4,8 x 70 -C-T25	S	250	35,50 gal Zn
4,8 x 80 -C-T25	S	250	42,50 gal Zn
4,8 x 90 -C-T25	S	250	54,00 gal Zn
4,8 x 100 -C-T25	S	250	62,00 gal Zn
5,5 x 13 -C-T25	S	500	15,20 gal Zn
5,5 x 16 -C-T25	S	500	12,80 gal Zn
5,5 x 19 -C-T25	S	500	8,60 gal Zn
5,5 x 22 -C-T25	S	500	15,40 gal Zn
5,5 x 25 -C-T25	S	250	12,80 gal Zn
5,5 x 32 -C-T25	S	250	14,70 gal Zn
5,5 x 38 -C-T25	S	250	18,90 gal Zn
5,5 x 45 -C-T25	S	250	20,40 gal Zn
5,5 x 50 -C-T25	S	250	24,10 gal Zn
5,5 x 60 -C-T25	S	250	45,50 gal Zn
5,5 x 70 -C-T25	S	250	57,00 gal Zn
5,5 x 80 -C-T25	S	250	68,00 gal Zn
5,5 x 90 -C-T25	S	250	73,00 gal Zn
5,5 x 100 -C-T25	S	250	83,00 gal Zn
6,3 x 13 -C-T30	S	250	22,70 gal Zn
6,3 x 16 -C-T30	S	250	17,00 gal Zn
6,3 x 19 -C-T30	S	250	14,20 gal Zn
6,3 x 22 -C-T30	S	250	16,40 gal Zn
6,3 x 25 -C-T30	S	250	16,40 gal Zn
6,3 x 32 -C-T30	S	250	18,00 gal Zn
6,3 x 38 -C-T30	S	250	22,30 gal Zn
6,3 x 45 -C-T30	S	250	27,50 gal Zn
6,3 x 50 -C-T30	S	250	29,50 gal Zn
6,3 x 60 -C-T30	S	250	52,00 gal Zn
6,3 x 70 -C-T30	S	250	73,00 gal Zn
6,3 x 80 -C-T30	S	250	82,00 gal Zn
6,3 x 90 -C-T30	S	250	91,00 gal Zn
6,3 x 100 -C-T30	S	250	99,00 gal Zn

DIN 07981.015
7981 Stahl Form F-H
 galvanisch verzinkt

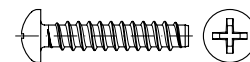

**Linien-Blechschrauben
 mit Phillips-Kreuzschlitz H,
 F = mit Zapfen**

gehärtet

Maße → **TI-46**
 Korrosionsschutz → **TI-228**

Montage → **TI-251**
 Normumstellung → **TI-11**

Rostfrei → **S. 577**

DIN 7981 → wird ersetzt durch ISO 7049

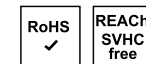

F 2,2 x 4,5 -H	S	2000	7,30 gal Zn
F 2,2 x 6,5 -H	S	2000	7,30 gal Zn
F 2,2 x 9,5 -H	S	2000	7,30 gal Zn
F 2,2 x 13 -H	S	2000	10,30 gal Zn
F 2,2 x 16 -H	S	2000	12,60 gal Zn
F 2,9 x 4,5 -H	S	2000	7,30 gal Zn
F 2,9 x 6,5 -H	S	2000	2,80 gal Zn
F 2,9 x 9,5 -H	K	100	5,60 gal Zn
F 2,9 x 13 -H	S	2000	2,75 gal Zn
F 2,9 x 16 -H	K	100	5,50 gal Zn
F 2,9 x 16 -H	S	2000	2,90 gal Zn
F 2,9 x 16 -H	K	100	5,60 gal Zn

Abmessungen	VE	Stück	€/100/Obf.
F 2,9 x 19 -H	S	2000	4,25 gal Zn
F 2,9 x 22 -H	S	2000	5,90 gal Zn
F 3,5 x 6,5-H	S	1000	2,90 gal Zn
F 3,5 x 9,5-H	S	2000	3,00 gal Zn
F 3,5 x 9,5-H	K	100	5,70 gal Zn
F 3,5 x 13 -H	S	1000	3,10 gal Zn
F 3,5 x 13 -H	K	100	5,90 gal Zn
F 3,5 x 16 -H	S	1000	3,15 gal Zn
F 3,5 x 16 -H	K	100	6,00 gal Zn
F 3,5 x 19 -H	S	1000	3,40 gal Zn
F 3,5 x 22 -H	S	1000	4,25 gal Zn
F 3,5 x 25 -H	S	1000	6,00 gal Zn
F 3,9 x 6,5-H	S	1000	4,25 gal Zn
F 3,9 x 9,5-H	S	1000	3,60 gal Zn
F 3,9 x 9,5-H	K	100	6,20 gal Zn
F 3,9 x 13 -H	S	1000	3,65 gal Zn
F 3,9 x 13 -H	K	100	6,30 gal Zn
F 3,9 x 16 -H	S	1000	3,95 gal Zn
F 3,9 x 16 -H	K	100	6,70 gal Zn
F 3,9 x 19 -H	S	1000	4,85 gal Zn
F 3,9 x 22 -H	S	1000	5,70 gal Zn
F 3,9 x 25 -H	S	1000	6,30 gal Zn
F 4,2 x 6,5-H	S	1000	4,95 gal Zn
F 4,2 x 9,5-H	S	1000	4,55 gal Zn
F 4,2 x 13 -H	S	1000	3,90 gal Zn
F 4,2 x 13 -H	K	100	6,50 gal Zn
F 4,2 x 16 -H	S	1000	3,75 gal Zn
F 4,2 x 19 -H	S	1000	6,10 gal Zn
F 4,2 x 22 -H	S	1000	6,10 gal Zn
F 4,2 x 25 -H	S	1000	7,30 gal Zn
F 4,2 x 32 -H	S	1000	7,30 gal Zn
F 4,8 x 6,5-H	S	1000	6,10 gal Zn
F 4,8 x 9,5-H	S	500	4,80 gal Zn
F 4,8 x 9,5-H	K	100	7,80 gal Zn
F 4,8 x 13 -H	S	500	5,20 gal Zn
F 4,8 x 13 -H	K	100	7,90 gal Zn
F 4,8 x 16 -H	S	500	5,40 gal Zn
F 4,8 x 16 -H	K	100	8,20 gal Zn
F 4,8 x 19 -H	S	500	9,60 gal Zn
F 4,8 x 22 -H	S	500	11,10 gal Zn
F 4,8 x 25 -H	S	500	11,50 gal Zn
F 4,8 x 32 -H	S	500	14,90 gal Zn
F 4,8 x 38 -H	S	500	18,20 gal Zn
F 5,5 x 13 -H	S	500	6,00 gal Zn
F 5,5 x 16 -H	S	500	6,70 gal Zn
F 5,5 x 19 -H	S	500	10,30 gal Zn
F 5,5 x 22 -H	S	500	12,10 gal Zn
F 5,5 x 25 -H	S	250	15,20 gal Zn
F 5,5 x 32 -H	S	250	18,20 gal Zn
F 5,5 x 38 -H	S	250	23,00 gal Zn
F 6,3 x 13 -H	S	250	9,10 gal Zn
F 6,3 x 16 -H	S	250	13,40 gal Zn

Abmessungen	VE	Stück	€/100/Obf.
Artikel	88981.010		
7981	Stahl	Artikel 88981	
	galvanisch verzinkt		



Kappenkopf-Blechschauben mit Phillips-Kreuzschlitz H, C = mit Spitze

gehärtet

Passende Zierkappen → Artikel 88003

Maße → **TI-46**

Montage → **TI-251**

Korrosionsschutz → **TI-228**



3,9 x 9,5 -H	S	1000	7,30 gal Zn
3,9 x 13 -H	S	1000	6,70 gal Zn
3,9 x 16 -H	S	1000	6,80 gal Zn
3,9 x 19 -H	S	1000	8,50 gal Zn
3,9 x 22 -H	S	500	8,50 gal Zn
3,9 x 25 -H	S	500	9,90 gal Zn
3,9 x 32 -H	S	500	11,50 gal Zn
3,9 x 38 -H	S	500	20,60 gal Zn

Artikel	88003.*
---------	---------

88003 Kunststoff



Zierkappen für Kappenschrauben Artikel 88981 Ø 3,9

weiß RAL 9010 (*630),
grau RAL 7001 (*640),
schwarz RAL 9005 (*650)

REACH → **TI-262**

F 3,9	S	1000	8,60
-------	---	------	------

Abmessungen	VE	Stück	€/100/Obf.
DIN	07982.014		
7982	Stahl	Form C-H	
	galvanisch verzinkt		

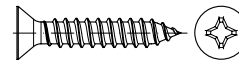

Senk-Blechschauben mit Phillips-Kreuzschlitz H, C = mit Spitze

gehärtet, Nennlänge ab 60 mm mit Teilgewinde, Senk α = 80°

Maße → **TI-47**

Montage → **TI-251**

Korrosionsschutz → **TI-228**

Normumstellung → **TI-11**

Rostfrei → **S. 577**

DIN 7982 → wird ersetzt durch ISO 7050

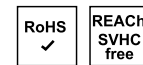

C 2,2 x 6,5-H	S	2000	5,60 gal Zn
C 2,2 x 9,5-H	S	2000	5,30 gal Zn
C 2,2 x 13 -H	S	2000	5,30 gal Zn
C 2,2 x 16 -H	S	2000	7,90 gal Zn
C 2,9 x 6,5-H	S	2000	5,70 gal Zn
C 2,9 x 9,5-H	S	2000	2,30 gal Zn
C 2,9 x 9,5-H	K	100	5,40 gal Zn
C 2,9 x 13 -H	S	2000	2,45 gal Zn
C 2,9 x 13 -H	K	100	5,50 gal Zn
C 2,9 x 16 -H	S	2000	2,60 gal Zn
C 2,9 x 16 -H	K	100	5,60 gal Zn
C 2,9 x 19 -H	S	2000	3,70 gal Zn
C 2,9 x 19 -H	K	100	6,70 gal Zn
C 2,9 x 22 -H	S	2000	4,30 gal Zn
C 2,9 x 22 -H	K	100	7,30 gal Zn
C 2,9 x 25 -H	S	1000	5,30 gal Zn
C 2,9 x 25 -H	K	100	8,40 gal Zn
C 2,9 x 32 -H	S	1000	6,00 gal Zn
C 2,9 x 32 -H	K	100	6,70 gal Zn
C 3,5 x 6,5-H	S	1000	3,65 gal Zn
C 3,5 x 9,5-H	S	1000	2,75 gal Zn
C 3,5 x 9,5-H	K	100	5,70 gal Zn
C 3,5 x 13 -H	S	1000	2,85 gal Zn
C 3,5 x 13 -H	K	100	5,90 gal Zn
C 3,5 x 16 -H	S	1000	3,00 gal Zn
C 3,5 x 16 -H	K	100	6,00 gal Zn
C 3,5 x 19 -H	S	1000	3,90 gal Zn
C 3,5 x 19 -H	K	100	6,90 gal Zn
C 3,5 x 22 -H	S	1000	4,70 gal Zn
C 3,5 x 22 -H	K	100	7,80 gal Zn
C 3,5 x 25 -H	S	500	5,70 gal Zn
C 3,5 x 25 -H	K	100	8,80 gal Zn
C 3,5 x 32 -H	S	500	7,20 gal Zn
C 3,5 x 32 -H	K	100	10,20 gal Zn
C 3,5 x 38 -H	S	500	7,90 gal Zn
C 3,5 x 38 -H	K	100	11,10 gal Zn
C 3,9 x 9,5-H	S	1000	3,25 gal Zn
C 3,9 x 9,5-H	K	100	6,20 gal Zn
C 3,9 x 13 -H	S	1000	3,30 gal Zn
C 3,9 x 13 -H	K	100	6,30 gal Zn
C 3,9 x 16 -H	S	1000	3,60 gal Zn
C 3,9 x 16 -H	K	100	6,70 gal Zn
C 3,9 x 19 -H	S	1000	4,20 gal Zn
C 3,9 x 19 -H	K	100	7,20 gal Zn
C 3,9 x 22 -H	S	500	4,80 gal Zn
C 3,9 x 22 -H	K	100	7,80 gal Zn
C 3,9 x 25 -H	S	500	5,90 gal Zn
C 3,9 x 25 -H	K	100	8,90 gal Zn
C 3,9 x 32 -H	S	500	7,60 gal Zn

Abmessungen	VE	Stück	€/100/Obf.
C 3,9 x 32 -H	K	100	10,60 gal Zn
C 3,9 x 38 -H	S	500	8,80 gal Zn
C 3,9 x 38 -H	K	100	11,80 gal Zn
C 3,9 x 45 -H	S	500	9,40 gal Zn
C 3,9 x 50 -H	S	500	17,70 gal Zn
C 3,9 x 60 -H	S	250	19,50 gal Zn
C 4,2 x 9,5 -H	S	1000	3,40 gal Zn
C 4,2 x 13 -H	S	1000	3,45 gal Zn
C 4,2 x 13 -H	K	100	6,50 gal Zn
C 4,2 x 16 -H	S	1000	3,85 gal Zn
C 4,2 x 16 -H	K	100	6,80 gal Zn
C 4,2 x 19 -H	S	500	4,40 gal Zn
C 4,2 x 19 -H	K	100	7,40 gal Zn
C 4,2 x 22 -H	S	500	5,00 gal Zn
C 4,2 x 22 -H	K	100	8,00 gal Zn
C 4,2 x 25 -H	S	500	6,20 gal Zn
C 4,2 x 25 -H	K	100	9,20 gal Zn
C 4,2 x 32 -H	S	500	7,80 gal Zn
C 4,2 x 32 -H	K	100	10,80 gal Zn
C 4,2 x 38 -H	S	500	9,40 gal Zn
C 4,2 x 38 -H	K	100	12,30 gal Zn
C 4,2 x 45 -H	S	500	10,50 gal Zn
C 4,2 x 45 -H	K	100	13,50 gal Zn
C 4,2 x 50 -H	S	500	19,20 gal Zn
C 4,2 x 50 -H	K	100	22,20 gal Zn
C 4,2 x 60 -H	S	250	22,00 gal Zn
C 4,2 x 70 -H	S	250	26,00 gal Zn
C 4,2 x 80 -H	S	250	28,50 gal Zn
C 4,8 x 9,5 -H	S	500	7,80 gal Zn
C 4,8 x 13 -H	S	500	4,85 gal Zn
C 4,8 x 13 -H	K	100	7,90 gal Zn
C 4,8 x 16 -H	S	500	5,10 gal Zn
C 4,8 x 16 -H	K	100	8,20 gal Zn
C 4,8 x 19 -H	S	500	4,70 gal Zn
C 4,8 x 19 -H	K	100	7,80 gal Zn
C 4,8 x 22 -H	S	500	6,20 gal Zn
C 4,8 x 22 -H	K	100	9,20 gal Zn
C 4,8 x 25 -H	S	500	7,30 gal Zn
C 4,8 x 25 -H	K	100	10,30 gal Zn
C 4,8 x 32 -H	S	250	8,40 gal Zn
C 4,8 x 32 -H	K	100	11,50 gal Zn
C 4,8 x 38 -H	S	250	9,70 gal Zn
C 4,8 x 38 -H	K	100	12,60 gal Zn
C 4,8 x 45 -H	S	250	10,70 gal Zn
C 4,8 x 45 -H	K	100	13,60 gal Zn
C 4,8 x 50 -H	S	250	20,30 gal Zn
C 4,8 x 50 -H	K	100	23,30 gal Zn
C 4,8 x 60 -H	S	250	24,00 gal Zn
C 4,8 x 70 -H	S	250	29,50 gal Zn
C 4,8 x 80 -H	S	250	37,00 gal Zn
C 4,8 x 90 -H	S	250	44,00 gal Zn
C 4,8 x 100 -H	S	250	58,00 gal Zn
C 4,8 x 110 -H	S	100	73,00 gal Zn
C 4,8 x 120 -H	S	100	91,00 gal Zn
C 5,5 x 13 -H	S	500	8,00 gal Zn
C 5,5 x 13 -H	K	100	11,10 gal Zn
C 5,5 x 16 -H	S	500	7,20 gal Zn
C 5,5 x 16 -H	K	100	10,10 gal Zn
C 5,5 x 19 -H	S	500	7,60 gal Zn
C 5,5 x 19 -H	K	100	10,60 gal Zn
C 5,5 x 22 -H	S	500	10,50 gal Zn
C 5,5 x 22 -H	K	100	13,40 gal Zn
C 5,5 x 25 -H	S	250	11,20 gal Zn
C 5,5 x 25 -H	K	100	14,10 gal Zn
C 5,5 x 32 -H	S	250	11,30 gal Zn
C 5,5 x 32 -H	K	100	14,30 gal Zn
C 5,5 x 38 -H	S	250	14,70 gal Zn
C 5,5 x 38 -H	K	100	17,70 gal Zn
C 5,5 x 45 -H	S	250	18,00 gal Zn
C 5,5 x 45 -H	K	100	21,00 gal Zn
C 5,5 x 50 -H	S	250	21,80 gal Zn
C 5,5 x 50 -H	K	100	24,90 gal Zn
C 5,5 x 60 -H	S	250	30,50 gal Zn
C 6,3 x 16 -H	S	250	11,70 gal Zn
C 6,3 x 16 -H	K	100	14,70 gal Zn

Abmessungen	VE	Stück	€/100/Obf.
C 6,3 x 19 -H	S	250	13,20 gal Zn
C 6,3 x 19 -H	K	100	16,10 gal Zn
C 6,3 x 22 -H	S	250	14,70 gal Zn
C 6,3 x 22 -H	K	100	17,70 gal Zn
C 6,3 x 25 -H	S	250	15,70 gal Zn
C 6,3 x 25 -H	K	100	18,70 gal Zn
C 6,3 x 32 -H	S	250	17,20 gal Zn
C 6,3 x 32 -H	K	100	20,30 gal Zn
C 6,3 x 38 -H	S	250	20,90 gal Zn
C 6,3 x 38 -H	K	100	23,90 gal Zn
C 6,3 x 45 -H	S	250	24,00 gal Zn
C 6,3 x 45 -H	K	100	27,00 gal Zn
C 6,3 x 50 -H	S	250	27,50 gal Zn
C 6,3 x 50 -H	K	100	31,00 gal Zn
C 6,3 x 60 -H	S	250	49,50 gal Zn
C 6,3 x 70 -H	S	250	65,00 gal Zn
C 6,3 x 80 -H	S	250	79,00 gal Zn

Artikel 88004.630

88004 Kunststoff H

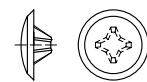

Zierkappen für Senkschrauben mit Phillips-Kreuzschlitz H

weiß RAL 9010 (*630),
hellbraun RAL 8001 (*640),
dunkelbraun RAL 8014 (*650)

REACH → TI-262

Kreuzschlitz-Nr. x Kappen Ø / für Schrauben Ø

2	x 12 / 3,5-5	S 1000	3,10 Kunststoff
---	--------------	--------	-----------------

~DIN 07982.016

7982 Stahl Form C-ISR galvanisch verzinkt

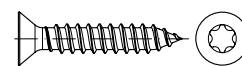

Senk-Blehschrauben, ISR = Innensechsrund C = mit Spitze

gehärtet
Senk <= 80°

Maße → TI-47 Montage → TI-251
Korrosionsschutz → TI-228 Normumstellung → TI-11

mit Senk <= 90° → ISO 14586



2,2	x 4,5-C-T6	S 2000	10,30 gal Zn
2,2	x 6,5-C-T6	S 2000	9,10 gal Zn
2,2	x 9,5-C-T6	S 2000	10,90 gal Zn
2,2	x 13 -C-T6	S 2000	11,80 gal Zn
2,2	x 16 -C-T6	S 2000	13,30 gal Zn
2,9	x 6,5-C-T10	S 2000	6,60 gal Zn
2,9	x 9,5-C-T10	S 2000	2,70 gal Zn
2,9	x 13 -C-T10	S 2000	2,80 gal Zn
2,9	x 16 -C-T10	S 2000	3,00 gal Zn
2,9	x 19 -C-T10	S 2000	4,30 gal Zn
2,9	x 22 -C-T10	S 2000	5,30 gal Zn
2,9	x 25 -C-T10	S 1000	5,70 gal Zn

Abmessungen	VE	Stück	€/100/Obf.
3,5 x 9,5-C-T15	S	1000	3,15 gal Zn
3,5 x 13 -C-T15	S	1000	3,30 gal Zn
3,5 x 16 -C-T15	S	1000	3,40 gal Zn
3,5 x 19 -C-T15	S	1000	4,45 gal Zn
3,5 x 22 -C-T15	S	1000	5,40 gal Zn
3,5 x 25 -C-T15	S	500	6,60 gal Zn
3,5 x 32 -C-T15	S	500	8,20 gal Zn
3,5 x 38 -C-T15	S	500	7,70 gal Zn
3,5 x 45 -C-T15	S	500	11,30 gal Zn
3,5 x 50 -C-T15	S	500	12,30 gal Zn
3,9 x 9,5-C-T20	S	1000	3,70 gal Zn
3,9 x 13 -C-T20	S	1000	3,75 gal Zn
3,9 x 16 -C-T20	S	1000	4,15 gal Zn
3,9 x 19 -C-T20	S	1000	4,80 gal Zn
3,9 x 22 -C-T20	S	500	5,50 gal Zn
3,9 x 25 -C-T20	S	500	4,85 gal Zn
3,9 x 32 -C-T20	S	500	8,60 gal Zn
3,9 x 38 -C-T20	S	500	10,00 gal Zn
3,9 x 45 -C-T20	S	500	10,20 gal Zn
3,9 x 50 -C-T20	S	500	10,50 gal Zn
4,2 x 9,5-C-T20	S	1000	3,90 gal Zn
4,2 x 13 -C-T20	S	1000	3,95 gal Zn
4,2 x 16 -C-T20	S	1000	4,40 gal Zn
4,2 x 19 -C-T20	S	500	5,00 gal Zn
4,2 x 22 -C-T20	S	500	5,70 gal Zn
4,2 x 25 -C-T20	S	500	7,20 gal Zn
4,2 x 32 -C-T20	S	500	8,90 gal Zn
4,2 x 38 -C-T20	S	500	10,70 gal Zn
4,2 x 45 -C-T20	S	500	11,90 gal Zn
4,2 x 50 -C-T20	S	500	13,60 gal Zn
4,2 x 60 -C-T20	S	500	23,20 gal Zn
4,2 x 70 -C-T20	S	500	27,50 gal Zn
4,2 x 80 -C-T20	S	500	39,00 gal Zn
4,8 x 9,5-C-T25	S	500	7,90 gal Zn
4,8 x 13 -C-T25	S	500	5,60 gal Zn
4,8 x 16 -C-T25	S	500	5,90 gal Zn
4,8 x 19 -C-T25	S	500	6,70 gal Zn
4,8 x 22 -C-T25	S	500	7,20 gal Zn
4,8 x 25 -C-T25	S	500	8,40 gal Zn
4,8 x 32 -C-T25	S	250	9,60 gal Zn
4,8 x 38 -C-T25	S	250	11,10 gal Zn
4,8 x 45 -C-T25	S	250	15,00 gal Zn
4,8 x 50 -C-T25	S	250	16,60 gal Zn
4,8 x 60 -C-T25	S	250	26,50 gal Zn
4,8 x 70 -C-T25	S	250	35,50 gal Zn
4,8 x 80 -C-T25	S	250	42,50 gal Zn
4,8 x 90 -C-T25	S	250	54,00 gal Zn
4,8 x 100 -C-T25	S	250	62,00 gal Zn
5,5 x 13 -C-T25	S	500	15,20 gal Zn
5,5 x 16 -C-T25	S	500	12,80 gal Zn
5,5 x 19 -C-T25	S	500	8,60 gal Zn
5,5 x 22 -C-T25	S	500	15,40 gal Zn
5,5 x 25 -C-T25	S	250	12,80 gal Zn
5,5 x 32 -C-T25	S	250	14,70 gal Zn
5,5 x 38 -C-T25	S	250	18,90 gal Zn
5,5 x 45 -C-T25	S	250	20,40 gal Zn
5,5 x 50 -C-T25	S	250	24,10 gal Zn
5,5 x 60 -C-T25	S	250	45,50 gal Zn
5,5 x 70 -C-T25	S	250	57,00 gal Zn
5,5 x 80 -C-T25	S	250	68,00 gal Zn
5,5 x 90 -C-T25	S	250	73,00 gal Zn
5,5 x 100 -C-T25	S	250	83,00 gal Zn
6,3 x 13 -C-T30	S	250	22,70 gal Zn
6,3 x 16 -C-T30	S	250	17,00 gal Zn
6,3 x 19 -C-T30	S	250	14,20 gal Zn
6,3 x 22 -C-T30	S	250	16,40 gal Zn
6,3 x 25 -C-T30	S	250	16,40 gal Zn
6,3 x 32 -C-T30	S	250	18,00 gal Zn
6,3 x 38 -C-T30	S	250	22,30 gal Zn
6,3 x 45 -C-T30	S	250	27,50 gal Zn
6,3 x 50 -C-T30	S	250	29,50 gal Zn
6,3 x 60 -C-T30	S	250	52,00 gal Zn
6,3 x 70 -C-T30	S	250	73,00 gal Zn

Abmessungen	VE	Stück	€/100/Obf.
6,3 x 80 -C-T30	S	250	82,00 gal Zn
6,3 x 90 -C-T30	S	250	91,00 gal Zn
6,3 x 100 -C-T30	S	250	99,00 gal Zn

DIN	07983.014
7983	Stahl Form C-H galvanisch verzinkt

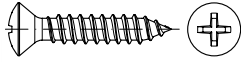

Linsensenk-Blechschraben mit Phillips-Kreuzschlitz H, C = mit Spitze

gehärtet
Senk \sphericalangle = 80°

Maße → **TI-47** Montage → **TI-251**
Korrosionsschutz → **TI-228** Normumstellung → **TI-11**

Rostfrei → **S. 578**

DIN 7983 → wird ersetzt durch ISO 7051
(Senk \sphericalangle = 90°)



C 2,9 x 6,5-H	S	2000	5,60 gal Zn
C 2,9 x 9,5-H	S	2000	2,30 gal Zn
C 2,9 x 9,5-H	K	100	5,40 gal Zn
C 2,9 x 13 -H	S	2000	2,45 gal Zn
C 2,9 x 13 -H	K	100	5,50 gal Zn
C 2,9 x 16 -H	S	2000	2,80 gal Zn
C 2,9 x 16 -H	K	100	5,90 gal Zn
C 2,9 x 19 -H	S	2000	3,70 gal Zn
C 2,9 x 19 -H	K	100	6,70 gal Zn
C 2,9 x 22 -H	S	2000	4,60 gal Zn
C 2,9 x 22 -H	K	100	7,70 gal Zn
C 2,9 x 25 -H	S	1000	4,85 gal Zn
C 2,9 x 25 -H	K	100	7,90 gal Zn
C 3,5 x 9,5-H	S	1000	3,35 gal Zn
C 3,5 x 9,5-H	K	100	6,30 gal Zn
C 3,5 x 13 -H	S	1000	3,90 gal Zn
C 3,5 x 13 -H	K	100	5,90 gal Zn
C 3,5 x 16 -H	S	1000	3,00 gal Zn
C 3,5 x 16 -H	K	100	6,00 gal Zn
C 3,5 x 19 -H	S	1000	3,95 gal Zn
C 3,5 x 19 -H	K	100	6,90 gal Zn
C 3,5 x 22 -H	S	1000	4,70 gal Zn
C 3,5 x 22 -H	K	100	7,80 gal Zn
C 3,5 x 25 -H	S	500	5,30 gal Zn
C 3,5 x 25 -H	K	100	8,30 gal Zn
C 3,5 x 32 -H	S	500	6,70 gal Zn
C 3,5 x 32 -H	K	100	9,60 gal Zn
C 3,5 x 38 -H	S	500	7,30 gal Zn
C 3,5 x 38 -H	K	100	10,30 gal Zn
C 3,9 x 9,5-H	S	1000	3,90 gal Zn
C 3,9 x 9,5-H	K	100	6,90 gal Zn
C 3,9 x 13 -H	S	1000	3,30 gal Zn
C 3,9 x 13 -H	K	100	6,30 gal Zn
C 3,9 x 16 -H	S	1000	3,60 gal Zn
C 3,9 x 16 -H	K	100	6,70 gal Zn
C 3,9 x 19 -H	S	1000	4,20 gal Zn
C 3,9 x 19 -H	K	100	7,20 gal Zn
C 3,9 x 22 -H	S	500	4,80 gal Zn
C 3,9 x 22 -H	K	100	7,80 gal Zn
C 3,9 x 25 -H	S	500	5,40 gal Zn
C 3,9 x 25 -H	K	100	8,50 gal Zn
C 3,9 x 32 -H	S	500	7,10 gal Zn
C 3,9 x 32 -H	K	100	10,10 gal Zn
C 3,9 x 38 -H	S	500	8,00 gal Zn

Abmessungen	VE	Stück	€/100/Obf.
C 3,9 x 38 -H	K	100	11,10 gal Zn
C 4,2 x 9,5-H	S	1000	2,85 gal Zn
C 4,2 x 13 -H	S	1000	3,45 gal Zn
C 4,2 x 13 -H	K	100	6,50 gal Zn
C 4,2 x 16 -H	S	1000	3,85 gal Zn
C 4,2 x 16 -H	K	100	6,80 gal Zn
C 4,2 x 19 -H	S	500	4,45 gal Zn
C 4,2 x 19 -H	K	100	7,60 gal Zn
C 4,2 x 22 -H	S	500	6,20 gal Zn
C 4,2 x 22 -H	K	100	9,20 gal Zn
C 4,2 x 25 -H	S	500	6,30 gal Zn
C 4,2 x 25 -H	K	100	9,40 gal Zn
C 4,2 x 32 -H	S	500	7,30 gal Zn
C 4,2 x 32 -H	K	100	10,30 gal Zn
C 4,2 x 38 -H	S	500	7,40 gal Zn
C 4,2 x 38 -H	K	100	10,30 gal Zn
C 4,2 x 45 -H	S	500	10,50 gal Zn
C 4,2 x 45 -H	K	100	13,50 gal Zn
C 4,2 x 50 -H	S	500	12,90 gal Zn
C 4,2 x 50 -H	K	100	15,90 gal Zn
C 4,8 x 9,5-H	S	500	7,80 gal Zn
C 4,8 x 13 -H	S	500	4,85 gal Zn
C 4,8 x 13 -H	K	100	7,90 gal Zn
C 4,8 x 16 -H	S	500	5,10 gal Zn
C 4,8 x 16 -H	K	100	8,20 gal Zn
C 4,8 x 19 -H	S	500	6,20 gal Zn
C 4,8 x 19 -H	K	100	9,20 gal Zn
C 4,8 x 22 -H	S	500	7,10 gal Zn
C 4,8 x 22 -H	K	100	10,10 gal Zn
C 4,8 x 25 -H	S	500	8,40 gal Zn
C 4,8 x 25 -H	K	100	11,40 gal Zn
C 4,8 x 32 -H	S	250	9,00 gal Zn
C 4,8 x 32 -H	K	100	12,00 gal Zn
C 4,8 x 38 -H	S	250	9,70 gal Zn
C 4,8 x 38 -H	K	100	14,90 gal Zn
C 4,8 x 45 -H	S	250	10,70 gal Zn
C 4,8 x 45 -H	K	100	13,60 gal Zn
C 4,8 x 50 -H	S	250	13,60 gal Zn
C 4,8 x 50 -H	K	100	16,60 gal Zn
C 5,5 x 13 -H	S	500	8,80 gal Zn
C 5,5 x 13 -H	K	100	11,70 gal Zn
C 5,5 x 16 -H	S	500	9,50 gal Zn
C 5,5 x 16 -H	K	100	12,40 gal Zn
C 5,5 x 19 -H	S	500	10,20 gal Zn
C 5,5 x 19 -H	K	100	13,10 gal Zn
C 5,5 x 22 -H	S	500	11,30 gal Zn
C 5,5 x 22 -H	K	100	14,30 gal Zn
C 5,5 x 25 -H	S	250	12,10 gal Zn
C 5,5 x 25 -H	K	100	15,20 gal Zn
C 5,5 x 32 -H	S	250	14,00 gal Zn
C 5,5 x 32 -H	K	100	17,00 gal Zn
C 5,5 x 38 -H	S	250	14,70 gal Zn
C 5,5 x 38 -H	K	100	17,70 gal Zn
C 5,5 x 45 -H	S	250	18,00 gal Zn
C 5,5 x 45 -H	K	100	21,00 gal Zn
C 5,5 x 50 -H	S	250	20,70 gal Zn
C 5,5 x 50 -H	K	100	23,80 gal Zn
C 6,3 x 16 -H	S	250	11,80 gal Zn
C 6,3 x 16 -H	K	100	14,80 gal Zn
C 6,3 x 19 -H	S	250	12,30 gal Zn
C 6,3 x 19 -H	K	100	15,20 gal Zn
C 6,3 x 22 -H	S	250	14,20 gal Zn
C 6,3 x 22 -H	K	100	17,10 gal Zn
C 6,3 x 25 -H	S	250	14,30 gal Zn
C 6,3 x 25 -H	K	100	17,40 gal Zn
C 6,3 x 32 -H	S	250	17,20 gal Zn
C 6,3 x 32 -H	K	100	20,30 gal Zn
C 6,3 x 38 -H	S	250	18,00 gal Zn
C 6,3 x 38 -H	K	100	21,00 gal Zn
C 6,3 x 45 -H	S	250	19,30 gal Zn
C 6,3 x 45 -H	K	100	22,20 gal Zn
C 6,3 x 50 -H	S	250	25,50 gal Zn
C 6,3 x 50 -H	K	100	28,50 gal Zn

Abmessungen	VE	Stück	€/100/Obf.
DIN	07984.800		

7984 08.8

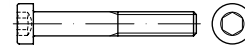

Zylinderschrauben mit Innensechskant, niedriger Kopf

Maße → **TI-13** Anziehmomente → **TI-246**
Werkstoffeigensch. → **TI-232**

Rostfrei → **S. 579**

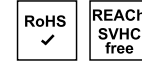

M 3 x 5	S	500	37,00
M 3 x 5	K	100	41,00
M 3 x 6	S	500	31,00
M 3 x 6	K	100	34,50
M 3 x 8	S	500	24,90
M 3 x 8	K	100	28,50
M 3 x 10	S	500	24,90
M 3 x 10	K	100	28,50
M 3 x 12	S	500	26,50
M 3 x 12	K	100	30,50
M 3 x 16	S	500	32,00
M 3 x 16	K	100	35,50
M 3 x 18	S	500	33,50
M 3 x 20	S	500	33,50
M 3 x 20	K	100	37,50
M 3 x 25	S	500	38,50
M 3 x 25	K	100	42,50
M 3 x 30	S	500	44,50
M 4 x 6	S	500	47,50
M 4 x 6	K	100	51,00
M 4 x 8	S	500	27,50
M 4 x 8	K	100	31,50
M 4 x 10	S	500	22,50
M 4 x 10	K	100	26,50
M 4 x 12	S	500	26,00
M 4 x 12	K	100	29,50
M 4 x 16	S	500	23,20
M 4 x 16	K	100	27,50
M 4 x 20	S	500	25,00
M 4 x 20	K	100	29,00
M 4 x 25	S	500	32,50
M 4 x 25	K	100	36,50
M 4 x 30	S	500	38,00
M 4 x 30	K	100	42,00
M 4 x 35	S	500	49,00
M 4 x 40	S	500	56,00
M 4 x 40	K	100	59,00
M 4 x 45	S	500	71,00
M 4 x 50	S	500	75,00
M 5 x 6	S	500	40,00
M 5 x 6	K	100	43,50
M 5 x 8	S	500	29,50
M 5 x 8	K	100	33,00
M 5 x 10	S	500	14,60
M 5 x 10	K	100	18,30
M 5 x 12	S	500	14,10
M 5 x 12	K	100	17,80
M 5 x 14	S	500	32,50
M 5 x 16	S	500	15,60
M 5 x 16	K	100	19,30
M 5 x 18	S	500	34,50
M 5 x 20	S	500	15,70
M 5 x 20	K	100	19,40
M 5 x 25	S	500	19,00

Abmessungen	VE	Stück	€/100/Obf.	Abmessungen	VE	Stück	€/100/Obf.	Abmessungen	VE	Stück	€/100/Obf.
M 5 x 25	K	100	22,60	M 12 x 45	S	100	82,00	M 4 x 6	S	500	48,00 gal Zn
M 5 x 30	S	500	37,00	M 12 x 50	S	100	153,00	M 4 x 8	S	500	28,00 gal Zn
M 5 x 30	K	100	40,50	M 12 x 55	S	100	230,00	M 4 x 10	S	500	23,20 gal Zn
M 5 x 35	S	200	46,50	M 12 x 60	S	100	230,00	M 4 x 12	S	500	26,50 gal Zn
M 5 x 40	S	200	46,50	M 12 x 65	S	50	270,00	M 4 x 16	S	500	23,90 gal Zn
M 5 x 45	S	200	55,00	M 12 x 70	S	50	270,00	M 4 x 20	S	500	26,50 gal Zn
M 5 x 50	S	200	55,00	M 12 x 80	S	50	305,00	M 4 x 25	S	500	34,00 gal Zn
M 5 x 55	S	200	78,00	M 12 x 90	S	50	335,00	M 4 x 30	S	500	39,00 gal Zn
M 5 x 60	S	200	84,00	M 12 x 100	S	50	355,00	M 4 x 35	S	500	50,00 gal Zn
M 6 x 8	S	500	15,30	M 16 x 25	S	50	255,00	M 4 x 40	S	500	58,00 gal Zn
M 6 x 8	K	100	19,00	M 16 x 30	S	50	194,00	M 4 x 50	S	500	79,00 gal Zn
M 6 x 10	S	500	15,70	M 16 x 35	S	50	210,00	M 5 x 6	S	500	41,50 gal Zn
M 6 x 10	K	100	19,40	M 16 x 40	S	50	221,00	M 5 x 8	S	500	30,50 gal Zn
M 6 x 12	S	500	15,70	M 16 x 45	S	50	260,00	M 5 x 10	S	500	15,50 gal Zn
M 6 x 12	K	100	19,40	M 16 x 50	S	50	260,00	M 5 x 12	S	500	15,20 gal Zn
M 6 x 14	S	500	35,50	M 16 x 55	S	50	300,00	M 5 x 14	S	500	33,50 gal Zn
M 6 x 16	S	500	16,00	M 16 x 60	S	50	355,00	M 5 x 16	S	500	16,80 gal Zn
M 6 x 16	K	100	19,60	M 16 x 70	S	25	420,00	M 5 x 20	S	500	17,10 gal Zn
M 6 x 18	S	500	42,50	M 16 x 80	S	25	500,00	M 5 x 25	S	500	21,00 gal Zn
M 6 x 18	K	100	46,00	M 16 x 90	S	25	540,00	M 5 x 30	S	500	40,00 gal Zn
M 6 x 20	S	500	16,10	M 16 x 100	S	25	740,00	M 5 x 35	S	200	49,50 gal Zn
M 6 x 20	K	100	19,90	M 16 x 110	S	25	870,00	M 5 x 40	S	200	49,50 gal Zn
M 6 x 25	S	500	20,00	M 16 x 120	S	25	900,00	M 5 x 45	S	200	59,00 gal Zn
M 6 x 25	K	100	23,70	M 20 x 30	S	25	590,00	M 5 x 50	S	200	59,00 gal Zn
M 6 x 30	S	500	20,60	M 20 x 35	S	25	590,00	M 5 x 55	S	200	83,00 gal Zn
M 6 x 30	K	100	24,30	M 20 x 40	S	25	590,00	M 5 x 60	S	200	90,00 gal Zn
M 6 x 35	S	200	38,00	M 20 x 45	S	25	690,00	M 6 x 8	S	500	16,60 gal Zn
M 6 x 40	S	200	40,50	M 20 x 50	S	25	690,00	M 6 x 10	S	500	17,10 gal Zn
M 6 x 45	S	200	51,00	M 20 x 55	S	25	750,00	M 6 x 12	S	500	17,20 gal Zn
M 6 x 50	S	200	47,50	M 20 x 60	S	25	750,00	M 6 x 14	S	500	36,00 gal Zn
M 6 x 55	S	200	61,00	M 20 x 70	S	25	980,00	M 6 x 16	S	500	17,70 gal Zn
M 6 x 60	S	200	61,00	M 20 x 80	S	25	1030,00	M 6 x 18	S	500	44,50 gal Zn
M 6 x 70	S	200	104,00	M 20 x 90	S	25	1080,00	M 6 x 20	S	500	18,20 gal Zn
M 8 x 10	S	200	58,00	M 20 x 100	S	25	1140,00	M 6 x 25	S	500	21,00 gal Zn
M 8 x 12	S	200	53,00	M 20 x 110	S	1	1220,00	M 6 x 30	S	500	23,60 gal Zn
M 8 x 14	S	200	44,50	M 20 x 120	S	1	1280,00	M 6 x 35	S	200	41,50 gal Zn
M 8 x 16	S	200	23,20	M 24 x 40	S	1	1410,00	M 6 x 40	S	200	44,50 gal Zn
M 8 x 18	S	200	42,50	M 24 x 45	S	1	1450,00	M 6 x 45	S	200	56,00 gal Zn
M 8 x 20	S	200	23,60	M 24 x 50	S	1	1500,00	M 6 x 50	S	200	53,00 gal Zn
M 8 x 25	S	200	23,60	M 24 x 60	S	1	1500,00	M 6 x 55	S	200	66,00 gal Zn
M 8 x 30	S	200	26,50	M 24 x 70	S	1	1630,00	M 6 x 60	S	200	66,00 gal Zn
M 8 x 35	S	200	58,00	M 24 x 80	S	1	1780,00	M 6 x 65	S	200	111,00 gal Zn
M 8 x 40	S	200	59,00	M 24 x 100	S	1	2340,00	M 6 x 70	S	200	109,00 gal Zn
M 8 x 45	S	200	62,00	M 24 x 120	S	1	2800,00	M 6 x 80	S	200	115,00 gal Zn
M 8 x 50	S	200	63,00					M 8 x 10	S	200	62,00 gal Zn
M 8 x 55	S	200	78,00					M 8 x 12	S	200	57,00 gal Zn
M 8 x 60	S	200	78,00					M 8 x 14	S	200	48,50 gal Zn
M 8 x 65	S	200	120,00					M 8 x 16	S	200	27,00 gal Zn
M 8 x 70	S	200	120,00					M 8 x 18	S	200	49,50 gal Zn
M 8 x 80	S	200	143,00					M 8 x 20	S	200	28,00 gal Zn
M 8 x 90	S	100	204,00					M 8 x 22	S	200	55,00 gal Zn
M 8 x 100	S	100	239,00					M 8 x 25	S	200	28,50 gal Zn
M 10 x 12	S	200	59,00					M 8 x 30	S	200	32,00 gal Zn
M 10 x 16	S	200	42,00					M 8 x 35	S	200	64,00 gal Zn
M 10 x 20	S	200	41,00					M 8 x 40	S	200	67,00 gal Zn
M 10 x 25	S	200	40,00					M 8 x 45	S	200	69,00 gal Zn
M 10 x 30	S	200	42,00					M 8 x 50	S	200	72,00 gal Zn
M 10 x 35	S	100	59,00					M 8 x 55	S	200	87,00 gal Zn
M 10 x 40	S	100	65,00					M 8 x 60	S	200	88,00 gal Zn
M 10 x 45	S	100	68,00					M 8 x 65	S	200	131,00 gal Zn
M 10 x 50	S	100	95,00					M 8 x 70	S	200	132,00 gal Zn
M 10 x 55	S	100	121,00					M 8 x 80	S	200	149,00 gal Zn
M 10 x 60	S	100	121,00					M 8 x 90	S	100	210,00 gal Zn
M 10 x 65	S	100	184,00					M 8 x 100	S	100	246,00 gal Zn
M 10 x 70	S	100	184,00					M 10 x 12	S	200	66,00 gal Zn
M 10 x 75	S	100	209,00					M 10 x 16	S	200	47,50 gal Zn
M 10 x 80	S	100	209,00					M 10 x 18	S	200	86,00 gal Zn
M 10 x 90	S	100	227,00					M 10 x 20	S	200	47,50 gal Zn
M 10 x 100	S	100	245,00					M 10 x 25	S	200	47,50 gal Zn
M 10 x 120	S	100	330,00					M 10 x 30	S	200	51,00 gal Zn
M 12 x 20	S	100	57,00					M 10 x 35	S	100	69,00 gal Zn
M 12 x 25	S	100	58,00					M 10 x 40	S	100	73,00 gal Zn
M 12 x 30	S	100	61,00					M 10 x 45	S	100	79,00 gal Zn
M 12 x 35	S	100	67,00					M 10 x 50	S	100	108,00 gal Zn
M 12 x 40	S	100	68,00					M 10 x 55	S	100	136,00 gal Zn
M 3 x 5	S	500	37,50 gal Zn								
M 3 x 6	S	500	31,50 gal Zn								
M 3 x 8	S	500	25,50 gal Zn								
M 3 x 10	S	500	25,50 gal Zn								
M 3 x 12	S	500	27,00 gal Zn								
M 3 x 16	S	500	32,50 gal Zn								
M 3 x 18	S	500	34,00 gal Zn								
M 3 x 20	S	500	34,50 gal Zn								
M 3 x 25	S	500	40,00 gal Zn								

DIN 07984.810
7984 08.8
 galvanisch verzinkt

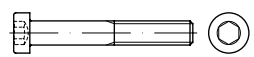

Zylinderschrauben mit Innensechskant, niedriger Kopf

Maße → TI-13 Korrosionsschutz → TI-228
 Werkstoffeigensch. → TI-232 Anziehmomente → TI-246
 Rostfrei → S. 579



Abmessungen	VE	Stück	€/100/Obf.
M 10 x 60	S	100	137,00 gal Zn
M 10 x 65	S	100	204,00 gal Zn
M 10 x 70	S	100	204,00 gal Zn
M 10 x 80	S	100	229,00 gal Zn
M 10 x 90	S	100	246,00 gal Zn
M 10 x 100	S	100	270,00 gal Zn
M 12 x 16	S	100	61,00 gal Zn
M 12 x 20	S	100	67,00 gal Zn
M 12 x 25	S	100	69,00 gal Zn
M 12 x 30	S	100	74,00 gal Zn
M 12 x 35	S	100	79,00 gal Zn
M 12 x 40	S	100	83,00 gal Zn
M 12 x 45	S	100	99,00 gal Zn
M 12 x 50	S	100	171,00 gal Zn
M 12 x 55	S	100	255,00 gal Zn
M 12 x 60	S	100	255,00 gal Zn
M 12 x 70	S	50	300,00 gal Zn
M 12 x 80	S	50	335,00 gal Zn
M 12 x 90	S	50	370,00 gal Zn
M 16 x 20	S	50	375,00 gal Zn
M 16 x 25	S	50	285,00 gal Zn
M 16 x 30	S	50	226,00 gal Zn
M 16 x 35	S	50	240,00 gal Zn
M 16 x 40	S	50	255,00 gal Zn
M 16 x 45	S	50	295,00 gal Zn
M 16 x 50	S	50	300,00 gal Zn
M 16 x 55	S	50	345,00 gal Zn
M 16 x 60	S	50	400,00 gal Zn
M 16 x 70	S	25	475,00 gal Zn
M 16 x 80	S	25	560,00 gal Zn
M 16 x 90	S	25	600,00 gal Zn
M 16 x 100	S	25	690,00 gal Zn
M 16 x 110	S	25	920,00 gal Zn
M 20 x 30	S	25	650,00 gal Zn
M 20 x 35	S	25	640,00 gal Zn
M 20 x 40	S	25	640,00 gal Zn
M 20 x 45	S	25	750,00 gal Zn
M 20 x 50	S	25	750,00 gal Zn
M 20 x 60	S	25	820,00 gal Zn
M 20 x 70	S	25	1060,00 gal Zn
M 20 x 80	S	25	1110,00 gal Zn
M 20 x 90	S	25	1140,00 gal Zn
M 24 x 40	S	1	1470,00 gal Zn
M 24 x 50	S	1	1560,00 gal Zn
M 24 x 60	S	1	1580,00 gal Zn
M 24 x 70	S	1	1700,00 gal Zn
M 24 x 80	S	1	1850,00 gal Zn
M 24 x 100	S	1	2420,00 gal Zn

~DIN	07984.814
7984	08.8 ISR
	galvanisch verzinkt

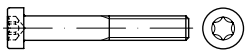

Zylinderschrauben mit niedrigem Kopf, ISR = Innensechsrund

Maße → **TI-13** Korrosionsschutz → **TI-228**
 Werkstoffeigensch. → **TI-232** Anziehmomente → **TI-246**

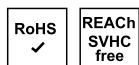

M 3 x 6 -T10	S	500	34,00 gal Zn
M 3 x 8 -T10	S	500	34,50 gal Zn
M 3 x 10 -T10	S	500	34,50 gal Zn
M 3 x 12 -T10	S	500	36,00 gal Zn
M 3 x 16 -T10	S	500	41,50 gal Zn

Abmessungen	VE	Stück	€/100/Obf.
M 4 x 6 -T20	S	500	51,00 gal Zn
M 4 x 8 -T20	S	500	31,50 gal Zn
M 4 x 10 -T20	S	500	26,50 gal Zn
M 4 x 12 -T20	S	500	29,50 gal Zn
M 4 x 16 -T20	S	500	26,50 gal Zn
M 4 x 20 -T20	S	500	29,00 gal Zn
M 5 x 10 -T25	S	500	17,20 gal Zn
M 5 x 12 -T25	S	500	16,80 gal Zn
M 5 x 16 -T25	S	500	18,70 gal Zn
M 5 x 20 -T25	S	500	19,00 gal Zn
M 5 x 25 -T25	S	500	23,30 gal Zn
M 6 x 10 -T30	S	500	19,00 gal Zn
M 6 x 12 -T30	S	500	19,00 gal Zn
M 6 x 16 -T30	S	500	19,70 gal Zn
M 6 x 20 -T30	S	500	20,20 gal Zn
M 6 x 25 -T30	S	500	23,30 gal Zn
M 8 x 12 -T40	S	200	63,00 gal Zn
M 8 x 16 -T40	S	200	30,00 gal Zn
M 8 x 20 -T40	S	100	31,00 gal Zn
M 8 x 25 -T40	S	200	31,50 gal Zn
M 8 x 30 -T40	S	200	35,50 gal Zn

DIN	07984.100
-----	-----------

7984 010.9

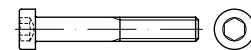

Zylinderschrauben mit Innensechskant, niedriger Kopf

Maße → **TI-13** Anziehmomente → **TI-246**
 Werkstoffeigensch. → **TI-232**

Rostfrei → **S. 579**

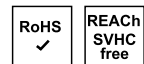

M 4 x 10	S	500	28,00
M 4 x 12	S	500	32,50
M 4 x 16	S	500	33,50
M 4 x 20	S	500	34,00
M 4 x 25	S	500	44,00
M 4 x 30	S	500	48,50
M 5 x 10	S	500	18,60
M 5 x 12	S	500	19,20
M 5 x 16	S	500	20,10
M 5 x 20	S	500	20,60
M 5 x 25	S	500	23,80
M 5 x 30	S	500	40,00
M 6 x 10	S	500	23,60
M 6 x 12	S	500	24,60
M 6 x 16	S	500	25,50
M 6 x 20	S	500	27,00
M 6 x 25	S	500	30,50
M 6 x 30	S	500	34,50
M 8 x 12	S	200	67,00
M 8 x 16	S	200	33,50
M 8 x 20	S	200	38,50
M 8 x 25	S	200	43,00
M 8 x 30	S	200	47,00
M 10 x 16	S	200	59,00
M 10 x 20	S	200	65,00
M 10 x 25	S	200	66,00
M 10 x 30	S	200	71,00
M 10 x 35	S	100	76,00
M 10 x 40	S	100	82,00
M 12 x 20	S	100	80,00
M 12 x 25	S	100	76,00
M 12 x 30	S	100	79,00

Abmessungen	VE	Stück	€/100/Obf.
M 12 x 35	S	100	86,00
M 12 x 40	S	100	91,00

DIN	07985.404
-----	-----------

7985 4.8 H



Linsenschrauben mit Phillips-Kreuzschlitz H

Maße → **TI-40** Normumstellung → **TI-11**
 Werkstoffeigensch. → **TI-232** REACH → **TI-262**

Rostfrei → **S. 580**

DIN 7985 → wird ersetzt durch ISO 7045



M 3 x 5 -H	S	2000	6,10
M 3 x 6 -H	S	2000	3,45
M 3 x 8 -H	S	2000	2,30
M 3 x 10 -H	S	2000	2,40
M 3 x 12 -H	S	2000	2,45
M 3 x 16 -H	S	2000	2,75
M 3 x 20 -H	S	2000	3,10
M 4 x 6 -H	S	2000	5,10
M 4 x 8 -H	S	2000	3,30
M 4 x 10 -H	S	2000	3,40
M 4 x 12 -H	S	2000	3,45
M 4 x 16 -H	S	2000	4,10
M 4 x 20 -H	S	2000	4,20
M 4 x 25 -H	S	1000	4,40
M 4 x 30 -H	S	1000	6,00
M 5 x 8 -H	S	2000	4,80
M 5 x 10 -H	S	2000	4,85
M 5 x 12 -H	S	1000	5,10
M 5 x 16 -H	S	1000	5,60
M 5 x 20 -H	S	1000	6,00
M 5 x 25 -H	S	1000	6,90
M 6 x 10 -H	S	1000	7,20
M 6 x 12 -H	S	1000	7,20
M 6 x 16 -H	S	1000	7,90
M 6 x 20 -H	S	1000	8,20
M 6 x 25 -H	S	500	9,10
M 6 x 40 -H	S	500	13,60
M 8 x 16 -H	S	500	16,70
M 8 x 25 -H	S	200	20,60

Abmessungen	VE Stück	€/100/Obf.
DIN	07985.414	
7985	4.8	H
galvanisch verzinkt		

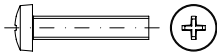

**Linsenschrauben
mit Phillips-Kreuzschlitz H**

Maße → **TI-40** Normumstellung → **TI-11**
 Werkstoffeigensch. → **TI-232** REACH → **TI-262**
 Korrosionsschutz → **TI-238**

Rostfrei → **S. 580**

DIN 7985 → wird ersetzt durch ISO 7045



M 2	x	4 -H	S 2000	8,40 gal Zn
M 2	x	4 -H	K 200	11,30 gal Zn
M 2	x	5 -H	S 2000	8,40 gal Zn
M 2	x	5 -H	K 200	11,30 gal Zn
M 2	x	6 -H	S 2000	4,60 gal Zn
M 2	x	6 -H	K 200	6,30 gal Zn
M 2	x	8 -H	S 2000	4,60 gal Zn
M 2	x	8 -H	K 200	7,60 gal Zn
M 2	x	10 -H	S 2000	4,75 gal Zn
M 2	x	10 -H	K 200	7,70 gal Zn
M 2	x	12 -H	S 2000	4,85 gal Zn
M 2	x	12 -H	K 200	7,80 gal Zn
M 2	x	16 -H	S 2000	5,00 gal Zn
M 2	x	16 -H	K 200	7,90 gal Zn
M 2	x	20 -H	S 2000	5,30 gal Zn
M 2	x	20 -H	K 200	8,20 gal Zn
M 2,5	x	4 -H	S 2000	9,20 gal Zn
M 2,5	x	4 -H	K 200	12,10 gal Zn
M 2,5	x	5 -H	S 2000	9,20 gal Zn
M 2,5	x	5 -H	K 200	12,10 gal Zn
M 2,5	x	6 -H	S 2000	4,70 gal Zn
M 2,5	x	6 -H	K 200	7,70 gal Zn
M 2,5	x	8 -H	S 2000	4,70 gal Zn
M 2,5	x	8 -H	K 200	7,70 gal Zn
M 2,5	x	10 -H	S 2000	4,80 gal Zn
M 2,5	x	10 -H	K 200	7,80 gal Zn
M 2,5	x	12 -H	S 2000	4,95 gal Zn
M 2,5	x	12 -H	K 200	7,90 gal Zn
M 2,5	x	14 -H	S 2000	9,70 gal Zn
M 2,5	x	16 -H	S 2000	5,40 gal Zn
M 2,5	x	16 -H	K 200	8,40 gal Zn
M 2,5	x	20 -H	S 2000	5,80 gal Zn
M 2,5	x	20 -H	K 200	8,70 gal Zn
M 2,5	x	25 -H	S 2000	6,80 gal Zn
M 2,5	x	25 -H	K 200	9,70 gal Zn
M 2,5	x	30 -H	S 2000	14,60 gal Zn
M 2,5	x	30 -H	K 200	17,50 gal Zn
M 3	x	3 -H	S 2000	12,10 gal Zn
M 3	x	3 -H	K 200	14,60 gal Zn
M 3	x	4 -H	S 2000	10,00 gal Zn
M 3	x	4 -H	K 200	12,90 gal Zn
M 3	x	5 -H	S 2000	6,70 gal Zn
M 3	x	5 -H	K 200	9,60 gal Zn
M 3	x	6 -H	S 2000	3,85 gal Zn
M 3	x	6 -H	K 200	6,80 gal Zn
M 3	x	8 -H	S 2000	2,60 gal Zn
M 3	x	8 -H	K 200	5,50 gal Zn
M 3	x	10 -H	S 2000	2,60 gal Zn
M 3	x	10 -H	K 200	5,50 gal Zn
M 3	x	12 -H	S 2000	2,75 gal Zn
M 3	x	12 -H	K 200	5,70 gal Zn
M 3	x	14 -H	S 2000	3,25 gal Zn

M 3	x	14 -H	K 200	6,20 gal Zn
M 3	x	16 -H	S 2000	3,00 gal Zn
M 3	x	16 -H	K 200	5,90 gal Zn
M 3	x	18 -H	S 2000	3,40 gal Zn
M 3	x	18 -H	K 200	6,30 gal Zn
M 3	x	20 -H	S 2000	3,40 gal Zn
M 3	x	20 -H	K 200	6,30 gal Zn
M 3	x	22 -H	S 2000	3,85 gal Zn
M 3	x	22 -H	K 200	6,80 gal Zn
M 3	x	25 -H	S 2000	4,20 gal Zn
M 3	x	25 -H	K 200	7,20 gal Zn
M 3	x	28 -H	S 2000	13,40 gal Zn
M 3	x	28 -H	K 200	16,30 gal Zn
M 3	x	30 -H	S 2000	5,30 gal Zn
M 3	x	30 -H	K 200	8,20 gal Zn
M 3	x	35 -H	S 2000	8,20 gal Zn
M 3	x	35 -H	K 200	11,10 gal Zn
M 3	x	40 -H	S 1000	8,50 gal Zn
M 3	x	40 -H	K 200	11,40 gal Zn
M 3	x	45 -H	S 1000	12,80 gal Zn
M 3	x	45 -H	K 200	15,10 gal Zn
M 3	x	50 -H	S 1000	14,60 gal Zn
M 3	x	50 -H	K 200	17,50 gal Zn
M 3	x	55 -H	S 200	30,50 gal Zn
M 3,5	x	5 -H	S 2000	10,90 gal Zn
M 3,5	x	6 -H	S 2000	11,20 gal Zn
M 4	x	4 -H	S 2000	12,10 gal Zn
M 4	x	4 -H	K 200	15,10 gal Zn
M 4	x	5 -H	S 2000	8,60 gal Zn
M 4	x	5 -H	K 200	11,50 gal Zn
M 4	x	6 -H	S 2000	5,60 gal Zn
M 4	x	6 -H	K 200	8,60 gal Zn
M 4	x	8 -H	S 2000	3,65 gal Zn
M 4	x	8 -H	K 200	6,70 gal Zn
M 4	x	10 -H	S 2000	3,75 gal Zn
M 4	x	10 -H	K 200	6,80 gal Zn
M 4	x	12 -H	S 2000	3,90 gal Zn
M 4	x	12 -H	K 200	6,80 gal Zn
M 4	x	14 -H	S 2000	5,40 gal Zn
M 4	x	14 -H	K 200	8,40 gal Zn
M 4	x	16 -H	S 2000	4,40 gal Zn
M 4	x	16 -H	K 200	7,30 gal Zn
M 4	x	18 -H	S 2000	5,10 gal Zn
M 4	x	18 -H	K 200	8,00 gal Zn
M 4	x	20 -H	S 2000	4,60 gal Zn
M 4	x	20 -H	K 200	7,70 gal Zn
M 4	x	22 -H	S 2000	7,30 gal Zn
M 4	x	25 -H	S 1000	4,85 gal Zn
M 4	x	25 -H	K 200	7,90 gal Zn
M 4	x	30 -H	S 1000	6,70 gal Zn
M 4	x	30 -H	K 200	9,60 gal Zn
M 4	x	35 -H	S 1000	7,80 gal Zn
M 4	x	35 -H	K 200	10,70 gal Zn
M 4	x	40 -H	S 1000	8,80 gal Zn
M 4	x	40 -H	K 200	11,70 gal Zn
M 4	x	45 -H	S 1000	13,50 gal Zn
M 4	x	45 -H	K 200	16,50 gal Zn
M 4	x	50 -H	S 1000	16,10 gal Zn
M 4	x	50 -H	K 200	19,20 gal Zn
M 4	x	55 -H	S 500	23,20 gal Zn
M 4	x	60 -H	S 500	23,20 gal Zn
M 4	x	65 -H	S 500	47,50 gal Zn
M 4	x	70 -H	S 500	30,00 gal Zn
M 4	x	80 -H	S 500	38,50 gal Zn
M 4	x	85 -H	S 500	48,50 gal Zn
M 4	x	90 -H	S 200	67,00 gal Zn
M 4	x	100 -H	S 200	79,00 gal Zn
M 5	x	6 -H	S 2000	10,70 gal Zn
M 5	x	6 -H	K 200	13,60 gal Zn
M 5	x	8 -H	S 2000	5,30 gal Zn
M 5	x	8 -H	K 200	8,20 gal Zn
M 5	x	10 -H	S 2000	5,40 gal Zn
M 5	x	10 -H	K 200	8,40 gal Zn
M 5	x	12 -H	S 1000	5,60 gal Zn
M 5	x	12 -H	K 200	8,60 gal Zn

M 5	x	14 -H	S 1000	6,10 gal Zn
M 5	x	14 -H	K 200	9,00 gal Zn
M 5	x	16 -H	S 1000	6,20 gal Zn
M 5	x	16 -H	K 200	9,10 gal Zn
M 5	x	18 -H	S 1000	7,30 gal Zn
M 5	x	18 -H	K 200	10,20 gal Zn
M 5	x	20 -H	S 1000	6,70 gal Zn
M 5	x	20 -H	K 200	9,60 gal Zn
M 5	x	25 -H	S 1000	7,80 gal Zn
M 5	x	25 -H	K 200	10,70 gal Zn
M 5	x	30 -H	S 1000	9,20 gal Zn
M 5	x	30 -H	K 200	12,10 gal Zn
M 5	x	35 -H	S 500	10,60 gal Zn
M 5	x	35 -H	K 200	13,40 gal Zn
M 5	x	40 -H	S 500	10,60 gal Zn
M 5	x	40 -H	K 200	13,50 gal Zn
M 5	x	45 -H	S 500	12,40 gal Zn
M 5	x	45 -H	K 200	15,40 gal Zn
M 5	x	50 -H	S 500	18,10 gal Zn
M 5	x	50 -H	K 200	21,00 gal Zn
M 5	x	60 -H	S 200	23,90 gal Zn
M 5	x	70 -H	S 200	33,50 gal Zn
M 5	x	80 -H	S 200	42,00 gal Zn
M 5	x	90 -H	S 200	48,50 gal Zn
M 5	x	100 -H	S 200	57,00 gal Zn
M 6	x	8 -H	S 1000	14,10 gal Zn
M 6	x	8 -H	K 200	17,00 gal Zn
M 6	x	10 -H	S 1000	8,00 gal Zn
M 6	x	10 -H	K 200	10,90 gal Zn
M 6	x	12 -H	S 1000	7,80 gal Zn
M 6	x	12 -H	K 200	10,80 gal Zn
M 6	x	14 -H	S 1000	9,70 gal Zn
M 6	x	14 -H	K 200	12,80 gal Zn
M 6	x	16 -H	S 1000	8,80 gal Zn
M 6	x	16 -H	K 200	11,80 gal Zn
M 6	x	18 -H	S 1000	9,70 gal Zn
M 6	x	20 -H	S 1000	9,10 gal Zn
M 6	x	20 -H	K 200	12,00 gal Zn
M 6	x	25 -H	S 500	10,10 gal Zn
M 6	x	25 -H	K 200	13,00 gal Zn
M 6	x	30 -H	S 500	11,80 gal Zn
M 6	x	30 -H	K 200	14,80 gal Zn
M 6	x	35 -H	S 500	14,20 gal Zn
M 6	x	35 -H	K 200	17,10 gal Zn
M 6	x	40 -H	S 500	15,20 gal Zn
M 6	x	40 -H	K 200	18,10 gal Zn
M 6	x	45 -H	S 500	15,80 gal Zn
M 6	x	45 -H	K 200	18,70 gal Zn
M 6	x	50 -H	S 200	18,00 gal Zn
M 6	x	55 -H	S 200	47,50 gal Zn
M 6	x	60 -H	S 200	22,20 gal Zn
M 6	x	70 -H	S 200	35,50 gal Zn
M 6	x	75 -H	S 200	41,00 gal Zn
M 6	x	80 -H	S 200	41,00 gal Zn
M 6	x	90 -H	S 100	49,50 gal Zn
M 6	x	100 -H	S 100	58,00 gal Zn
M 8	x	12 -H	S 500	26,50 gal Zn
M 8	x	12 -H	K 200	29,50 gal Zn
M 8	x	16 -H	S 500	18,60 gal Zn
M 8	x	16 -H	K 200	21,50 gal Zn
M 8	x	20 -H	S 500	19,70 gal Zn
M 8	x	20 -H	K 200	22,70 gal Zn
M 8	x	25 -H	S 200	22,70 gal Zn
M 8	x	30 -H	S 200	24,90 gal Zn
M 8	x	35 -H	S 200	28,00 gal Zn
M 8	x	40 -H	S 100	29,50 gal Zn
M 8	x	45 -H	S 100	34,50 gal Zn
M 8	x	50 -H	S 100	36,00 gal Zn
M 8	x	60 -H	S 100	44,50 gal Zn
M 8	x	70 -H	S 100	54,00 gal Zn
M 8	x	80 -H	S 100	68,00 gal Zn
M 8	x	90 -H	S 100	91,00 gal Zn
M 10	x	25 -H	S 100	115,00 gal Zn

Abmessungen	VE Stück	€/100/Obf.
DIN 07985.415		
7985	4.8	Z
galvanisch verzinkt		



Linsenschrauben mit Pozidriv-Kreuzschlitz Z

Maße → **TI-40** Normumstellung → **TI-11**
 Werkstoffeigensch. → **TI-232** REACH → **TI-262**
 Korrosionsschutz → **TI-228**

Rostfrei → **S. 581**

DIN 7985 → wird ersetzt durch ISO 7045



M 2,5 x 4 -Z	S 2000	9,20 gal Zn
M 2,5 x 5 -Z	S 2000	9,20 gal Zn
M 2,5 x 6 -Z	S 2000	4,70 gal Zn
M 2,5 x 8 -Z	S 2000	4,70 gal Zn
M 2,5 x 10 -Z	S 2000	4,80 gal Zn
M 2,5 x 12 -Z	S 2000	4,95 gal Zn
M 2,5 x 16 -Z	S 2000	5,40 gal Zn
M 3 x 4 -Z	S 2000	10,00 gal Zn
M 3 x 5 -Z	S 2000	6,70 gal Zn
M 3 x 6 -Z	S 2000	3,85 gal Zn
M 3 x 8 -Z	S 2000	2,60 gal Zn
M 3 x 10 -Z	S 2000	2,60 gal Zn
M 3 x 12 -Z	S 2000	2,75 gal Zn
M 3 x 16 -Z	S 2000	3,00 gal Zn
M 3 x 20 -Z	S 2000	3,40 gal Zn
M 3 x 25 -Z	S 2000	4,20 gal Zn
M 3 x 30 -Z	S 2000	5,30 gal Zn
M 3 x 35 -Z	S 2000	8,20 gal Zn
M 3 x 40 -Z	S 1000	8,50 gal Zn
M 4 x 5 -Z	S 2000	8,60 gal Zn
M 4 x 6 -Z	S 2000	5,60 gal Zn
M 4 x 8 -Z	S 2000	3,65 gal Zn
M 4 x 10 -Z	S 2000	3,75 gal Zn
M 4 x 12 -Z	S 2000	3,90 gal Zn
M 4 x 16 -Z	S 2000	4,40 gal Zn
M 4 x 18 -Z	S 2000	5,10 gal Zn
M 4 x 20 -Z	S 2000	4,60 gal Zn
M 4 x 25 -Z	S 1000	4,85 gal Zn
M 4 x 30 -Z	S 1000	6,70 gal Zn
M 4 x 35 -Z	S 1000	7,80 gal Zn
M 4 x 40 -Z	S 1000	8,80 gal Zn
M 4 x 45 -Z	S 1000	13,50 gal Zn
M 4 x 50 -Z	S 1000	16,10 gal Zn
M 4 x 60 -Z	S 500	23,20 gal Zn
M 4 x 70 -Z	S 500	30,00 gal Zn
M 5 x 6 -Z	S 2000	10,70 gal Zn
M 5 x 8 -Z	S 2000	5,30 gal Zn
M 5 x 10 -Z	S 2000	5,40 gal Zn
M 5 x 12 -Z	S 1000	5,60 gal Zn
M 5 x 16 -Z	S 1000	6,20 gal Zn
M 5 x 20 -Z	S 1000	6,70 gal Zn
M 5 x 25 -Z	S 1000	7,80 gal Zn
M 5 x 30 -Z	S 1000	9,20 gal Zn
M 5 x 35 -Z	S 500	10,60 gal Zn
M 5 x 40 -Z	S 500	10,60 gal Zn
M 5 x 45 -Z	S 500	12,40 gal Zn
M 5 x 50 -Z	S 500	18,10 gal Zn
M 5 x 60 -Z	S 200	23,90 gal Zn
M 5 x 70 -Z	S 200	33,50 gal Zn
M 5 x 80 -Z	S 200	42,00 gal Zn
M 6 x 8 -Z	S 1000	14,10 gal Zn
M 6 x 10 -Z	S 1000	8,00 gal Zn

Abmessungen	VE Stück	€/100/Obf.
M 6 x 12 -Z	S 1000	7,80 gal Zn
M 6 x 16 -Z	S 1000	8,80 gal Zn
M 6 x 20 -Z	S 1000	9,10 gal Zn
M 6 x 25 -Z	S 500	10,10 gal Zn
M 6 x 30 -Z	S 500	11,80 gal Zn
M 6 x 35 -Z	S 500	14,20 gal Zn
M 6 x 40 -Z	S 500	15,20 gal Zn
M 6 x 45 -Z	S 500	15,80 gal Zn
M 6 x 50 -Z	S 200	18,00 gal Zn
M 6 x 60 -Z	S 200	22,20 gal Zn

DIN	07985.436
7985	4.8
galv. verz. 8 DiSP*	
	H

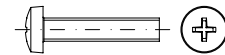

Linsenschrauben mit Phillips-Kreuzschlitz H

* < M 6 Mindestschichtdicke 5µm,
 Korrosionsbeständigkeit NSS: 72h WR, 120h RR

Maße → **TI-40** Normumstellung → **TI-11**
 Werkstoffeigensch. → **TI-232** REACH → **TI-262**
 Korrosionsschutz → **TI-228**

Rostfrei → **S. 580**

DIN 7985 → wird ersetzt durch ISO 7045



M 3 x 6 -H	S 2000	5,10 gal ZnDi
M 3 x 8 -H	S 2000	3,55 gal ZnDi
M 3 x 12 -H	S 2000	4,00 gal ZnDi
M 3 x 16 -H	S 2000	4,10 gal ZnDi
M 4 x 8 -H	S 2000	5,10 gal ZnDi
M 4 x 10 -H	S 2000	5,30 gal ZnDi
M 4 x 12 -H	S 2000	5,50 gal ZnDi
M 4 x 16 -H	S 2000	6,00 gal ZnDi
M 4 x 20 -H	S 2000	6,20 gal ZnDi
M 4 x 25 -H	S 1000	7,60 gal ZnDi
M 4 x 30 -H	S 1000	8,50 gal ZnDi
M 5 x 8 -H	S 2000	6,70 gal ZnDi
M 5 x 10 -H	S 2000	7,30 gal ZnDi
M 5 x 12 -H	S 1000	7,60 gal ZnDi
M 5 x 16 -H	S 1000	8,40 gal ZnDi
M 5 x 20 -H	S 1000	8,70 gal ZnDi
M 6 x 10 -H	S 1000	10,70 gal ZnDi
M 6 x 12 -H	S 1000	10,90 gal ZnDi
M 6 x 25 -H	S 500	13,40 gal ZnDi

Abmessungen	VE Stück	€/100/Obf.
~DIN 07985.416		
7985	4.8	ISR
galvanisch verzinkt		

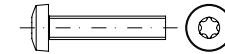

Linsenschrauben, ISR = Innensechsrund

entspricht ISO 14583

Bits → Artikel 88655

Maße → **TI-40** Normumstellung → **TI-6**
 Werkstoffeigensch. → **TI-232** REACH → **TI-262**
 Korrosionsschutz → **TI-228**

Rostfrei → **S. 581**



M 2 x 4 -T6	S 2000	12,90 gal Zn
M 2 x 6 -T6	S 2000	9,10 gal Zn
M 2 x 8 -T6	S 2000	9,10 gal Zn
M 2 x 10 -T6	S 2000	9,20 gal Zn
M 2 x 12 -T6	S 2000	9,40 gal Zn
M 2 x 16 -T6	S 2000	9,50 gal Zn
M 2,5 x 4 -T8	S 2000	13,70 gal Zn
M 2,5 x 5 -T8	S 2000	13,70 gal Zn
M 2,5 x 6 -T8	S 2000	9,20 gal Zn
M 2,5 x 8 -T8	S 2000	9,20 gal Zn
M 2,5 x 10 -T8	S 2000	9,30 gal Zn
M 2,5 x 12 -T8	S 2000	9,40 gal Zn
M 2,5 x 16 -T8	S 2000	9,90 gal Zn
M 2,5 x 20 -T8	S 2000	10,30 gal Zn
M 2,5 x 25 -T8	S 2000	11,30 gal Zn
M 3 x 4 -T10	S 2000	11,20 gal Zn
M 3 x 4 -T10	K 200	14,10 gal Zn
M 3 x 5 -T10	S 2000	11,20 gal Zn
M 3 x 5 -T10	K 200	14,10 gal Zn
M 3 x 6 -T10	S 2000	8,60 gal Zn
M 3 x 6 -T10	K 200	11,50 gal Zn
M 3 x 8 -T10	S 2000	8,60 gal Zn
M 3 x 8 -T10	K 200	11,50 gal Zn
M 3 x 10 -T10	S 2000	8,80 gal Zn
M 3 x 10 -T10	K 200	11,70 gal Zn
M 3 x 12 -T10	S 2000	8,80 gal Zn
M 3 x 12 -T10	K 200	11,70 gal Zn
M 3 x 16 -T10	S 2000	8,90 gal Zn
M 3 x 16 -T10	K 200	11,80 gal Zn
M 3 x 20 -T10	S 2000	9,40 gal Zn
M 3 x 20 -T10	K 200	12,30 gal Zn
M 3 x 25 -T10	S 2000	9,70 gal Zn
M 3 x 25 -T10	K 200	12,60 gal Zn
M 3 x 30 -T10	S 1000	10,30 gal Zn
M 3 x 30 -T10	K 200	13,20 gal Zn
M 3 x 40 -T10	S 1000	11,80 gal Zn
M 3 x 40 -T10	K 200	14,70 gal Zn
M 4 x 5 -T20	S 2000	11,90 gal Zn
M 4 x 5 -T20	K 200	14,80 gal Zn
M 4 x 6 -T20	S 2000	8,90 gal Zn
M 4 x 6 -T20	K 200	11,80 gal Zn
M 4 x 8 -T20	S 2000	9,40 gal Zn
M 4 x 8 -T20	K 200	12,30 gal Zn
M 4 x 10 -T20	S 2000	9,60 gal Zn
M 4 x 10 -T20	K 200	12,50 gal Zn
M 4 x 12 -T20	S 2000	9,70 gal Zn
M 4 x 12 -T20	K 200	12,60 gal Zn
M 4 x 16 -T20	S 2000	10,30 gal Zn
M 4 x 16 -T20	K 200	13,20 gal Zn
M 4 x 20 -T20	S 2000	11,10 gal Zn

Abmessungen	VE	Stück	€/100/Obf.
M 4 x 20 -T20	K	200	14,00 gal Zn
M 4 x 25 -T20	S	1000	11,70 gal Zn
M 4 x 25 -T20	K	200	14,60 gal Zn
M 4 x 30 -T20	S	1000	12,30 gal Zn
M 4 x 30 -T20	K	200	15,20 gal Zn
M 4 x 32 -T20	S	1000	10,40 gal Zn
M 4 x 35 -T20	S	1000	12,80 gal Zn
M 4 x 35 -T20	K	200	15,70 gal Zn
M 5 x 6 -T25	S	2000	11,10 gal Zn
M 5 x 6 -T25	K	200	14,00 gal Zn
M 5 x 8 -T25	S	2000	11,20 gal Zn
M 5 x 8 -T25	K	200	14,10 gal Zn
M 5 x 10 -T25	S	2000	11,40 gal Zn
M 5 x 10 -T25	K	200	14,30 gal Zn
M 5 x 12 -T25	S	1000	11,80 gal Zn
M 5 x 12 -T25	K	200	14,70 gal Zn
M 5 x 16 -T25	S	1000	12,50 gal Zn
M 5 x 16 -T25	K	200	15,40 gal Zn
M 5 x 18 -T25	S	1000	13,60 gal Zn
M 5 x 20 -T25	S	1000	13,60 gal Zn
M 5 x 20 -T25	K	200	16,50 gal Zn
M 5 x 25 -T25	S	1000	14,30 gal Zn
M 5 x 25 -T25	K	200	17,20 gal Zn
M 5 x 30 -T25	S	1000	15,00 gal Zn
M 5 x 30 -T25	K	200	18,00 gal Zn
M 6 x 10 -T30	S	1000	15,20 gal Zn
M 6 x 10 -T30	K	200	18,10 gal Zn
M 6 x 12 -T30	S	1000	15,40 gal Zn
M 6 x 12 -T30	K	200	18,30 gal Zn
M 6 x 16 -T30	S	1000	15,80 gal Zn
M 6 x 16 -T30	K	200	15,80 gal Zn
M 6 x 20 -T30	S	1000	16,70 gal Zn
M 6 x 20 -T30	K	200	19,70 gal Zn
M 6 x 25 -T30	S	500	17,80 gal Zn
M 6 x 25 -T30	K	200	20,70 gal Zn
M 6 x 30 -T30	S	500	19,00 gal Zn
M 6 x 30 -T30	K	200	22,00 gal Zn

DIN 07989.003
7989-1 Stahl 100 HV PK C

Scheiben für Stahlkonstruktionen, Produktklasse C
 (alt: Ausführung A)

Maße → TI-84
 Rostfrei → S. 582



Nennmaß/Innen Ø x Außen Ø x Dicke	· ÜH-Fabrikate
10/11 x 20 x 8	S 100 23,90
12/13,5 x 24 x 8	S 100 28,50
16/17,5 x 30 x 8	S 100 38,00
20/22 x 37 x 8	S 100 47,50
22/24 x 39 x 8	S 100 63,00
24/26 x 44 x 8	S 100 74,00
27/30 x 50 x 8	S 50 126,00
30/33 x 56 x 8	S 50 151,00
33/36 x 60 x 8	S 50 181,00
36/39 x 66 x 8	S 50 206,00

Abmessungen VE Stück €/100/Obf.
 DIN 07989.023
7989-1 Stahl 100 HV PK C
 feuerverzinkt

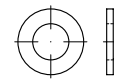

Scheiben für Stahlkonstruktionen, Produktklasse C
 (alt: Ausführung A)

Maße → TI-84
 Rostfrei → S. 582
 Korrosionsschutz → TI-231

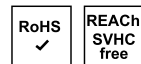

Nennmaß/Innen Ø x Außen Ø x Dicke	· ÜH-Fabrikate
10/11 x 20 x 8	S 100 33,50 tZn
12/13,5 x 24 x 8	S 100 39,50 tZn
16/17,5 x 30 x 8	S 100 54,00 tZn
20/22 x 37 x 8	S 100 74,00 tZn
22/24 x 39 x 8	S 100 92,00 tZn
24/26 x 44 x 8	S 100 112,00 tZn
27/30 x 50 x 8	S 50 183,00 tZn
30/33 x 56 x 8	S 50 223,00 tZn
33/36 x 60 x 8	S 50 265,00 tZn
36/39 x 66 x 8	S 50 310,00 tZn

DIN 07989.004
7989-2 Stahl 100 HV PK A

Scheiben für Stahlkonstruktionen, Produktklasse A

vorzugsweise für DIN 7968,
 (alt: Ausführung B)

Maße → TI-84

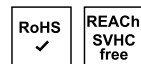

Nennmaß/Innen Ø x Außen Ø x Dicke	· ÜH-Fabrikate
12/13,5 x 24 x 8	S 100 103,00
16/17,5 x 30 x 8	S 100 131,00
20/22 x 37 x 8	S 100 220,00
22/24 x 39 x 8	S 100 280,00
24/26 x 44 x 8	S 100 380,00
27/30 x 50 x 8	S 50 570,00
30/33 x 56 x 8	S 50 840,00

Abmessungen VE Stück €/100/Obf.
 DIN 07989.024
7989-2 Stahl 100 HV PK A
 feuerverzinkt

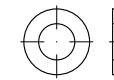

Scheiben für Stahlkonstruktionen, Produktklasse A

vorzugsweise für DIN 7968,
 (alt: Ausführung B)

Maße → TI-84
 Korrosionsschutz → TI-231

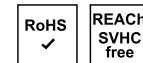

Nennmaß/Innen Ø x Außen Ø x Dicke	· ÜH-Fabrikate
12/13,5 x 24 x 8	S 100 255,00 tZn
16/17,5 x 30 x 8	S 100 265,00 tZn
20/22 x 37 x 8	S 100 360,00 tZn
22/24 x 39 x 8	S 100 410,00 tZn
24/26 x 44 x 8	S 100 420,00 tZn
27/30 x 50 x 8	S 50 1110,00 tZn
30/33 x 56 x 8	S 50 1230,00 tZn

DIN 07990.400
7990 Mu 4.6 SB

Sechskantschrauben für Stahlkonstruktionen, Mu = mit Sechskantmutter

für nicht planmäßig vorgespannte Verbindungen im Stahlbau

Maße → TI-57
 Werkstoffeigensch. → TI-232
 Anziehmomente → TI-248
 REACH → TI-262



M 12 x 30	S 100 33,00
M 12 x 35	S 100 34,00
M 12 x 40	S 100 35,50
M 12 x 45	S 100 38,50
M 12 x 50	S 100 52,00
M 12 x 55	S 100 68,00
M 16 x 35	S 50 68,00
M 16 x 40	S 50 67,00
M 16 x 45	S 50 68,00
M 16 x 50	S 50 74,00
M 16 x 55	S 50 78,00
M 16 x 60	S 50 81,00
M 16 x 65	S 25 120,00
M 16 x 70	S 25 123,00
M 20 x 40	S 25 143,00
M 20 x 45	S 25 141,00
M 20 x 50	S 25 138,00
M 20 x 55	S 25 143,00
M 20 x 60	S 25 143,00
M 20 x 65	S 25 154,00
M 20 x 70	S 25 154,00
M 20 x 75	S 25 205,00
M 20 x 80	S 25 213,00

Abmessungen	VE	Stück	€/100/Obf.
M 24 x 50	S	25	260,00
M 24 x 55	S	25	249,00
M 24 x 60	S	25	249,00
M 24 x 65	S	25	255,00
M 24 x 70	S	25	255,00
M 24 x 75	S	25	350,00
M 24 x 80	S	25	370,00

DIN	07990.420
7990	Mu 4.6 SB feuerverzinkt

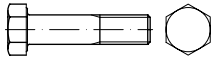

Sechskantschrauben für Stahlkonstruktionen, Mu = mit Sechskantmutter

für nicht planmäßig vorgespannte Verbindungen im Stahlbau

Achtung! Infoeinblender beachten.

Maße → **TI-57** Anziehmomente → **TI-248**
 Werkstoffeigensch. → **TI-232** REACH → **TI-262**
 Korrosionsschutz → **TI-231**



M 12 x 30	S	100	53,00 tzn
M 12 x 35	S	100	55,00 tzn
M 12 x 40	S	100	58,00 tzn
M 12 x 45	S	100	63,00 tzn
M 12 x 50	S	100	79,00 tzn
M 12 x 55	S	100	96,00 tzn
M 12 x 60	S	100	135,00 tzn
M 12 x 65	S	50	147,00 tzn
M 12 x 70	S	50	163,00 tzn
M 12 x 75	S	50	182,00 tzn
M 12 x 80	S	50	183,00 tzn
M 12 x 85	S	50	197,00 tzn
M 12 x 90	S	50	192,00 tzn
M 12 x 95	S	50	220,00 tzn
M 12 x 100	S	50	212,00 tzn
M 12 x 105	S	50	249,00 tzn
M 12 x 110	S	50	232,00 tzn
M 12 x 115	S	50	295,00 tzn
M 12 x 120	S	50	275,00 tzn
M 12 x 130	S	50	325,00 tzn
M 16 x 35	S	50	109,00 tzn
M 16 x 40	S	50	110,00 tzn
M 16 x 45	S	50	114,00 tzn
M 16 x 50	S	50	124,00 tzn
M 16 x 55	S	50	130,00 tzn
M 16 x 60	S	50	136,00 tzn
M 16 x 65	S	25	177,00 tzn
M 16 x 70	S	25	182,00 tzn
M 16 x 75	S	25	255,00 tzn
M 16 x 80	S	25	265,00 tzn
M 16 x 85	S	25	285,00 tzn
M 16 x 90	S	25	325,00 tzn
M 16 x 95	S	25	345,00 tzn
M 16 x 100	S	25	345,00 tzn
M 16 x 105	S	25	395,00 tzn
M 16 x 110	S	25	375,00 tzn
M 16 x 115	S	25	430,00 tzn
M 16 x 120	S	25	410,00 tzn
M 16 x 130	S	25	460,00 tzn
M 16 x 140	S	25	540,00 tzn
M 16 x 150	S	25	580,00 tzn
M 20 x 40	S	25	221,00 tzn

Abmessungen	VE	Stück	€/100/Obf.
M 20 x 45	S	25	221,00 tzn
M 20 x 50	S	25	223,00 tzn
M 20 x 55	S	25	233,00 tzn
M 20 x 60	S	25	236,00 tzn
M 20 x 65	S	25	255,00 tzn
M 20 x 70	S	25	260,00 tzn
M 20 x 75	S	25	315,00 tzn
M 20 x 80	S	25	325,00 tzn
M 20 x 85	S	25	340,00 tzn
M 20 x 90	S	25	455,00 tzn
M 20 x 95	S	25	470,00 tzn
M 20 x 100	S	25	475,00 tzn
M 20 x 105	S	25	640,00 tzn
M 20 x 110	S	25	600,00 tzn
M 20 x 115	S	25	680,00 tzn
M 20 x 120	S	25	640,00 tzn
M 20 x 130	S	25	720,00 tzn
M 20 x 140	S	25	760,00 tzn
M 20 x 150	S	25	880,00 tzn
M 20 x 160	S	10	970,00 tzn
M 24 x 50	S	25	390,00 tzn
M 24 x 55	S	25	390,00 tzn
M 24 x 60	S	25	395,00 tzn
M 24 x 65	S	25	405,00 tzn
M 24 x 70	S	25	410,00 tzn
M 24 x 75	S	25	520,00 tzn
M 24 x 80	S	25	540,00 tzn
M 24 x 85	S	10	750,00 tzn
M 24 x 90	S	10	710,00 tzn
M 24 x 95	S	10	950,00 tzn
M 24 x 100	S	10	900,00 tzn
M 24 x 105	S	10	1040,00 tzn
M 24 x 110	S	10	980,00 tzn
M 24 x 115	S	10	1080,00 tzn
M 24 x 120	S	10	1020,00 tzn
M 24 x 130	S	10	1160,00 tzn
M 24 x 140	S	10	1350,00 tzn
M 24 x 150	S	10	1380,00 tzn
M 24 x 160	S	10	1520,00 tzn
M 27 x 60	S	10	1150,00 tzn
M 27 x 65	S	10	1160,00 tzn
M 27 x 70	S	10	1170,00 tzn
M 27 x 75	S	10	1180,00 tzn
M 27 x 80	S	10	1180,00 tzn
M 27 x 85	S	10	1240,00 tzn
M 27 x 90	S	10	1250,00 tzn
M 27 x 95	S	10	1330,00 tzn
M 27 x 100	S	1	1330,00 tzn
M 27 x 105	S	1	1560,00 tzn
M 27 x 110	S	1	1470,00 tzn
M 27 x 120	S	1	1480,00 tzn
M 27 x 130	S	1	1610,00 tzn
M 30 x 80	S	1	1650,00 tzn
M 30 x 90	S	1	1740,00 tzn
M 30 x 100	S	1	1810,00 tzn
M 30 x 120	S	1	1980,00 tzn

Abmessungen	VE	Stück	€/100/Obf.
DIN	07990.520		
7990	Mu 5.6	SB	
feuerverzinkt			

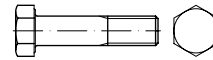

Sechskantschrauben für Stahlkonstruktionen, Mu = mit Sechskantmutter

für nicht planmäßig vorgespannte Verbindungen im Stahlbau

Achtung! Infoeinblender beachten.

Maße → **TI-57** Korrosionsschutz → **TI-231**
 Werkstoffeigensch. → **TI-232** Anziehmomente → **TI-248**

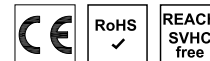

M 12 x 35	S	100	102,00 tzn
M 12 x 40	S	100	107,00 tzn
M 12 x 45	S	100	128,00 tzn
M 12 x 50	S	100	134,00 tzn
M 12 x 55	S	100	182,00 tzn
M 12 x 60	S	100	222,00 tzn
M 16 x 35	S	50	270,00 tzn
M 16 x 40	S	50	234,00 tzn
M 16 x 45	S	50	220,00 tzn
M 16 x 50	S	50	230,00 tzn
M 16 x 55	S	50	265,00 tzn
M 16 x 60	S	50	290,00 tzn
M 16 x 65	S	25	365,00 tzn
M 16 x 70	S	25	345,00 tzn
M 16 x 75	S	25	410,00 tzn
M 16 x 80	S	25	430,00 tzn
M 20 x 40	S	25	475,00 tzn
M 20 x 45	S	25	455,00 tzn
M 20 x 50	S	25	460,00 tzn
M 20 x 55	S	25	500,00 tzn
M 20 x 60	S	25	500,00 tzn
M 20 x 65	S	25	530,00 tzn
M 20 x 70	S	25	540,00 tzn
M 20 x 75	S	25	550,00 tzn
M 20 x 80	S	25	570,00 tzn
M 24 x 55	S	25	990,00 tzn
M 24 x 60	S	25	1010,00 tzn
M 24 x 65	S	25	1020,00 tzn
M 24 x 70	S	25	1030,00 tzn
M 24 x 75	S	25	1050,00 tzn
M 24 x 80	S	25	1060,00 tzn
M 24 x 85	S	10	1180,00 tzn

Achtung!

Feuerverzinkte Schrauben-/Muttern-Garnituren dürfen nur miteinander verschraubt werden, wenn Gewindespieß/-Toleranzen dieser Garnituren entsprechend ISO 10684 passend aufeinander abgestimmt sind. Die Verwendung mit anderen Schrauben-/Muttern-Ausführungen kann zu Verschraubungsproblemen und/oder zum Versagen der Verbindung führen.



Abmessungen	VE Stück	€/100/Obf.
DIN	07993.001	
7993	Federstahl	Form A



Runddraht-Sprengringe, A = für Wellen

Maße → **TI-101**

DIN 7993 A → wird ersetzt durch DIN 9925



Nennmaß = für Wellen Ø

A 4	S 1000	4,75
A 5	S 1000	4,85
A 6	S 500	4,85
A 7	S 500	5,30
A 8	S 500	5,00
A 10	S 500	5,70
A 12	S 500	6,10
A 16	S 250	7,90
A 18	S 250	9,90
A 20	S 100	11,90
A 22	S 100	12,40
A 25	S 100	15,70
A 26	S 100	15,80
A 28	S 100	18,20
A 30	S 100	19,80
A 32	S 100	21,50
A 35	S 100	23,90
A 38	S 100	28,00
A 40	S 100	33,00
A 45	S 50	38,00
A 48	S 50	42,50
A 50	S 50	47,50
A 55	S 50	53,00
A 60	S 50	57,00
A 65	S 50	62,00
A 70	S 50	80,00

Abmessungen	VE Stück	€/100/Obf.
DIN	07993.002	
7993	Federstahl	Form B



Runddraht-Sprengringe, B = für Bohrungen

Maße → **TI-101**

DIN 7993 B → wird ersetzt durch DIN 9926



Nennmaß = für Bohrungs Ø

B 7	S 500	3,90
B 8	S 500	4,40
B 10	S 500	5,00
B 12	S 500	5,60
B 16	S 250	8,80
B 18	S 100	11,50

Abmessungen	VE Stück	€/100/Obf.
ISO	08673.300	
8673	6 AU	

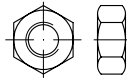

Sechskantmuttern, ISO-Typ 1, mit metrischem Feingewinde

*M 5-M 39 = RAZ 3320 übrige Ø/M = RAZ 411, Kennzeichnung ab Ø M 12

Maße → **TI-62** Normumstellung → **TI-7**
 Werkstoffeigensch. → **TI-233** REACH → **TI-262**

Rostfrei → **S. 582**
 Messing → **S. 642**

ISO 8673 → ersetzt DIN 934 Feingewinde



M 8	x 1	S 100	101,00
M 10	x 1	S 100	163,00
M 10	x 1,25	S 100	163,00
M 12	x 1	S 100	211,00
M 12	x 1,25	S 100	345,00
M 12	x 1,5	S 100	211,00
M 14	x 1,5	S 100	77,00
M 16	x 1,5	S 100	97,00
M 18	x 1,5	S 50	147,00
M 18	x 2	S 50	147,00
M 20	x 1,5	S 50	184,00
M 20	x 2	S 50	184,00
M 22	x 1,5	S 25	246,00
M 22	x 2	S 25	246,00
M 24	x 1,5	S 25	325,00
M 24	x 2	S 25	325,00
M 26	x 1,5	S 25	520,00
M 27	x 1,5	S 25	520,00
M 27	x 2	S 25	520,00
M 28	x 1,5	S 10	740,00
M 30	x 1,5	S 10	740,00
M 30	x 2	S 10	740,00
M 32	x 1,5	S 10	1050,00
M 33	x 1,5	S 10	1050,00
M 33	x 2	S 10	1050,00
M 35	x 1,5	S 5	1250,00
M 36	x 1,5	S 5	1250,00
M 36	x 3	S 5	1250,00
M 38	x 1,5	S 5	1570,00
M 39	x 1,5	S 5	1570,00
M 39	x 3	S 5	1570,00
M 40	x 1,5	S 1	8400,00
M 42	x 1,5	S 1	8400,00
M 42	x 3	S 1	8400,00
M 45	x 1,5	S 1	10400,00
M 45	x 3	S 1	10400,00
M 48	x 1,5	S 1	12400,00
M 48	x 3	S 1	12400,00
M 50	x 1,5	S 1	3850,00
M 52	x 1,5	S 1	12300,00
M 52	x 3	S 1	15300,00
M 56	x 2	S 1	20600,00
M 56	x 4	S 1	20600,00
M 58	x 2	S 1	22200,00
M 60	x 2	S 1	24700,00
M 60	x 4	S 1	24700,00
M 64	x 2	S 1	40700,00
M 64	x 4	S 1	40700,00
M 68	x 2	S 1	10200,00

Abmessungen	VE Stück	€/100/Obf.	
M 68	x 4	S 1	10200,00
M 72	x 2	S 1	12000,00
M 72	x 4	S 1	48000,00
M 72	x 6	S 1	45500,00
M 76	x 2	S 1	12600,00
M 76	x 4	S 1	12600,00
M 76	x 6	S 1	48500,00
M 80	x 2	S 1	57200,00
M 80	x 4	S 1	57200,00
M 80	x 6	S 1	54300,00
M 85	x 2	S 1	16400,00
M 85	x 4	S 1	16400,00
M 85	x 6	S 1	15700,00
M 90	x 2	S 1	19400,00
M 90	x 4	S 1	19400,00
M 90	x 6	S 1	74100,00
M 95	x 2	S 1	26500,00
M 95	x 4	S 1	26500,00
M 95	x 6	S 1	25300,00
M 100	x 2	S 1	27900,00
M 100	x 4	S 1	111400,00
M 100	x 6	S 1	106000,00
M 110	x 4	S 1	37800,00
M 120	x 4	S 1	44000,00

Abmessungen	VE Stück	€/100/Obf.
ISO	08673.304	
8673	6 AU	Links

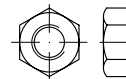

Sechskantmuttern, ISO-Typ 1, mit metrischem Links-Feingewinde

*M 5-M 39 = RAZ 3320 übrige Ø/M = RAZ 411, Kennzeichnung ab Ø M 12

Maße → **TI-62** Normumstellung → **TI-7**
 Werkstoffeigensch. → **TI-233** REACH → **TI-262**

ISO 8673 → ersetzt DIN 934 Feingewinde



M 8	x 1	S 100	146,00
M 10	x 1	S 100	216,00
M 12	x 1,5	S 100	216,00
M 14	x 1,5	S 50	224,00
M 16	x 1,5	S 50	230,00
M 18	x 1,5	S 50	242,00
M 20	x 1,5	S 50	275,00
M 22	x 1,5	S 25	335,00
M 24	x 1,5	S 25	425,00
M 24	x 2	S 25	425,00
M 30	x 1,5	S 10	850,00
M 30	x 2	S 10	850,00

Abmessungen VE Stück €/100/Obf.
ISO 08673.830

8673 8 schwarz**

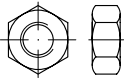

Sechskantmuttern, ISO-Typ 1, mit metrischem Feingewinde

*M 5-M 39 = RAZ 3330 übrige Ø/M = RAZ 412,
**≥ M 22 = grau-schwarz

Maße → [TI-62](#) Anziehmomente → [TI-244](#)
Werkstoffeigensch. → [TI-233](#) Normumstellung → [TI-7](#)
Rostfrei → [S. 582](#)
Messing → [S. 642](#)

ISO 8673 → ersetzt DIN 934 Feingewinde

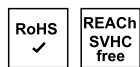

M 8	x 1	S 100	15,30	schwarz
M 10	x 1	S 100	23,50	schwarz
M 12	x 1,25	S 100	31,50	schwarz
M 12	x 1,5	S 100	30,50	schwarz
M 14	x 1,5	S 100	53,00	schwarz
M 16	x 1,5	S 100	66,00	schwarz
M 18	x 1,5	S 100	92,00	schwarz
M 18	x 2	S 100	101,00	schwarz
M 20	x 1,5	S 50	107,00	schwarz
M 20	x 2	S 50	107,00	schwarz
M 22	x 1,5	S 50	113,00	schwarz
M 22	x 2	S 50	113,00	schwarz
M 24	x 1,5	S 50	136,00	schwarz
M 24	x 2	S 50	136,00	schwarz
M 27	x 2	S 50	233,00	schwarz
M 30	x 1,5	S 10	315,00	schwarz
M 30	x 2	S 10	315,00	schwarz
M 33	x 2	S 10	380,00	schwarz
M 36	x 1,5	S 5	790,00	schwarz
M 36	x 3	S 5	790,00	schwarz
M 39	x 3	S 5	950,00	schwarz
M 42	x 1,5	S 1	1360,00	schwarz
M 42	x 3	S 1	1260,00	schwarz
M 45	x 3	S 1	1320,00	schwarz
M 48	x 1,5	S 1	3000,00	schwarz
M 48	x 3	S 1	1820,00	schwarz
M 52	x 3	S 1	2850,00	schwarz
M 56	x 4	S 1	3900,00	schwarz
M 60	x 4	S 1	5200,00	schwarz
M 64	x 4	S 1	6100,00	schwarz
M 68	x 4	S 1	7900,00	schwarz
M 72	x 4	S 1	9400,00	schwarz
M 72	x 6	S 1	8300,00	schwarz
M 80	x 4	S 1	13800,00	schwarz
M 80	x 6	S 1	11500,00	schwarz
M 100	x 6	S 1	25200,00	schwarz

Abmessungen VE Stück €/100/Obf.
ISO 08673.810

8673 8 galvanisch verzinkt

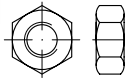

Sechskantmuttern, ISO-Typ 1, mit metrischem Feingewinde

*M 5-M 39 = RAZ 3330 übrige Ø/M = RAZ 412

Maße → [TI-62](#) Anziehmomente → [TI-244](#)
Werkstoffeigensch. → [TI-233](#) Normumstellung → [TI-7](#)
Korrosionsschutz → [TI-228](#)
Rostfrei → [S. 582](#)
Messing → [S. 642](#)

ISO 8673 → ersetzt DIN 934 Feingewinde

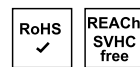

M 10	x 1	S 100	20,50	gal Zn
M 10	x 1,25	S 100	25,50	gal Zn
M 12	x 1	S 500	31,50	gal Zn
M 12	x 1,25	S 100	29,50	gal Zn
M 12	x 1,5	S 100	27,00	gal Zn
M 14	x 1,25	S 100	97,00	gal Zn
M 14	x 1,5	S 100	45,50	gal Zn
M 16	x 1,5	S 100	57,00	gal Zn
M 18	x 1,5	S 100	82,00	gal Zn
M 18	x 2	S 100	86,00	gal Zn
M 20	x 1,5	S 50	96,00	gal Zn
M 20	x 2	S 50	102,00	gal Zn
M 22	x 1,5	S 50	123,00	gal Zn
M 22	x 2	S 50	123,00	gal Zn
M 24	x 1,5	S 50	154,00	gal Zn
M 24	x 2	S 50	154,00	gal Zn
M 27	x 1,5	S 50	365,00	gal Zn
M 27	x 2	S 50	365,00	gal Zn
M 30	x 1,5	S 25	360,00	gal Zn
M 30	x 2	S 25	360,00	gal Zn
M 33	x 2	S 1	550,00	gal Zn
M 36	x 1,5	S 1	840,00	gal Zn
M 36	x 2	S 1	840,00	gal Zn
M 36	x 3	S 1	840,00	gal Zn
M 39	x 3	S 1	1340,00	gal Zn
M 42	x 3	S 1	1340,00	gal Zn
M 45	x 3	S 1	2180,00	gal Zn
M 48	x 1,5	S 1	3050,00	gal Zn
M 48	x 2	S 1	3650,00	gal Zn
M 48	x 3	S 1	1990,00	gal Zn
M 52	x 3	S 1	4250,00	gal Zn
M 72	x 6	S 1	7700,00	gal Zn

Abmessungen VE Stück €/100/Obf.
ISO 08673.100

8673 10

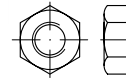

Sechskantmuttern, ISO-Typ 1, mit metrischem Feingewinde

*M 5-M 39 = RAZ 3320 übrige Ø/M = RAZ 411

Maße → [TI-62](#) Anziehmomente → [TI-244](#)
Werkstoffeigensch. → [TI-233](#) Normumstellung → [TI-7](#)
Rostfrei → [S. 582](#)
Messing → [S. 642](#)

ISO 8673 → ersetzt DIN 934 Feingewinde

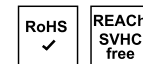

M 8	x 1	S 100	16,40
M 10	x 1	S 100	26,00
M 12	x 1,5	S 100	41,50
M 14	x 1,5	S 100	56,00
M 16	x 1,5	S 100	79,00
M 18	x 1,5	S 100	103,00
M 18	x 2	S 100	103,00
M 20	x 1,5	S 50	121,00
M 20	x 2	S 50	121,00
M 22	x 1,5	S 25	172,00
M 22	x 2	S 25	172,00
M 24	x 1,5	S 25	192,00
M 24	x 2	S 25	192,00
M 30	x 1,5	S 10	425,00
M 30	x 2	S 10	425,00
M 36	x 2	S 1	590,00
M 42	x 3	S 1	1430,00
M 48	x 3	S 1	2650,00

ISO 08673.110
8673 10 galvanisch verzinkt

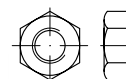

Sechskantmuttern, ISO-Typ 1, mit metrischem Feingewinde

*M 5-M 39 = RAZ 3320 übrige Ø/M = RAZ 411

Maße → [TI-62](#) Anziehmomente → [TI-244](#)
Werkstoffeigensch. → [TI-233](#) Normumstellung → [TI-7](#)
Korrosionsschutz → [TI-228](#)

Rostfrei → [S. 582](#)
Messing → [S. 642](#)

ISO 8673 → ersetzt DIN 934 Feingewinde

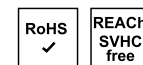

M 8	x 1	S 100	25,50	gal Zn
M 10	x 1	S 100	35,50	gal Zn
M 12	x 1,5	S 100	51,00	gal Zn
M 14	x 1,5	S 100	62,00	gal Zn
M 16	x 1,5	S 100	97,00	gal Zn

Abmessungen	VE	Stück	€/100/Obf.
M 18 x 1,5	S	100	121,00 gal Zn
M 18 x 2	S	100	121,00 gal Zn
M 20 x 1,5	S	50	148,00 gal Zn
M 20 x 2	S	25	148,00 gal Zn
M 24 x 1,5	S	50	230,00 gal Zn
M 24 x 2	S	25	230,00 gal Zn
M 30 x 1,5	S	10	485,00 gal Zn
M 30 x 2	S	10	485,00 gal Zn
M 36 x 3	S	1	660,00 gal Zn
M 42 x 3	S	1	1580,00 gal Zn
M 48 x 3	S	1	2750,00 gal Zn

ISO 08675.400

8675 04

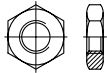

Niedrige Sechskantmutter mit Fasen u. metrischem Feingewinde

*M 10/12/14 RAZ = 3370 übrige Ø RAZ = 170

Maße → **TI-61** Normumstellung → **TI-7**
 Werkstoffeigensch. → **TI-233** REACH → **TI-262**

Rostfrei → **S. 582**
 Messing → **S. 643**

ISO 8675 → ersetzt DIN 439 Feingewinde



M 8 x 1	S	100	13,70
M 10 x 1	S	100	21,10
M 10 x 1,25	S	100	21,10
M 12 x 1	S	100	33,00
M 12 x 1,25	S	100	33,00
M 12 x 1,5	S	100	33,00
M 14 x 1,5	S	100	38,50
M 16 x 1,5	S	50	45,50
M 18 x 1,5	S	50	84,00
M 20 x 1,5	S	50	95,00
M 20 x 2	S	50	95,00
M 24 x 1,5	S	25	190,00
M 24 x 2	S	25	190,00
M 27 x 1,5	S	25	315,00
M 30 x 1,5	S	25	330,00
M 30 x 2	S	25	330,00
M 33 x 1,5	S	10	590,00
M 36 x 1,5	S	10	690,00
M 36 x 3	S	10	690,00
M 39 x 1,5	S	10	1060,00
M 39 x 3	S	10	1060,00
M 42 x 1,5	S	10	1380,00
M 42 x 2	S	10	1380,00
M 42 x 3	S	10	1380,00
M 48 x 1,5	S	10	2440,00
M 48 x 2	S	10	2550,00
M 48 x 3	S	10	2440,00

Abmessungen	VE	Stück	€/100/Obf.
ISO	08675.410		
8675	04	galvanisch verzinkt	

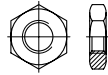

Niedrige Sechskantmutter mit Fasen u. metrischem Feingewinde

*M 10/12/14/22 RAZ = 3370 übrige Ø RAZ = 170

Maße → **TI-61** Normumstellung → **TI-7**
 Werkstoffeigensch. → **TI-233** REACH → **TI-262**
 Korrosionsschutz → **TI-228**

Rostfrei → **S. 582**
 Messing → **S. 643**

ISO 8675 → ersetzt DIN 439 Feingewinde



M 8 x 1	S	100	16,00 gal Zn
M 10 x 1	S	100	23,60 gal Zn
M 10 x 1,25	S	100	23,60 gal Zn
M 12 x 1	S	100	37,00 gal Zn
M 12 x 1,25	S	100	37,00 gal Zn
M 12 x 1,5	S	100	37,00 gal Zn
M 14 x 1,5	S	100	42,50 gal Zn
M 16 x 1	S	100	55,00 gal Zn
M 16 x 1,5	S	50	51,00 gal Zn
M 18 x 1,5	S	50	91,00 gal Zn
M 20 x 1,5	S	50	106,00 gal Zn
M 22 x 1,5	S	50	170,00 gal Zn
M 24 x 1,5	S	25	207,00 gal Zn
M 24 x 2	S	25	230,00 gal Zn
M 27 x 1,5	S	25	425,00 gal Zn
M 30 x 1,5	S	25	370,00 gal Zn
M 30 x 2	S	25	370,00 gal Zn
M 33 x 1,5	S	50	710,00 gal Zn
M 35 x 1,5	S	50	1520,00 gal Zn
M 36 x 1,5	S	10	780,00 gal Zn
M 36 x 2	S	10	780,00 gal Zn
M 36 x 3	S	10	780,00 gal Zn
M 39 x 2	S	10	1180,00 gal Zn
M 42 x 1,5	S	10	1530,00 gal Zn
M 42 x 2	S	10	1530,00 gal Zn
M 42 x 3	S	10	1530,00 gal Zn

Abmessungen	VE	Stück	€/100/Obf.
ISO	08675.500		
8675	05		

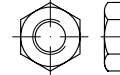

Niedrige Sechskantmutter mit Fasen u. metrischem Feingewinde

Maße → **TI-61** Normumstellung → **TI-7**
 Werkstoffeigensch. → **TI-233**

Rostfrei → **S. 582**
 Messing → **S. 643**

ISO 8675 → ersetzt DIN 439 Feingewinde

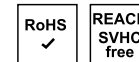

M 10 x 1	S	100	67,00
M 10 x 1,25	S	100	67,00
M 12 x 1	S	100	113,00
M 12 x 1,25	S	100	113,00
M 12 x 1,5	S	100	113,00
M 14 x 1,5	S	100	360,00
M 22 x 1,5	S	50	690,00

ISO	08675.510		
8675	05	galvanisch verzinkt	

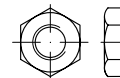

Niedrige Sechskantmutter mit Fasen u. metrischem Feingewinde

Maße → **TI-61** Korrosionsschutz → **TI-228**
 Werkstoffeigensch. → **TI-233** Normumstellung → **TI-7**

Rostfrei → **S. 582**
 Messing → **S. 643**

ISO 8675 → ersetzt DIN 439 Feingewinde

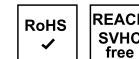

M 10 x 1	S	100	69,00 gal Zn
M 10 x 1,25	S	100	69,00 gal Zn
M 12 x 1,25	S	100	117,00 gal Zn
M 14 x 1,5	S	100	360,00 gal Zn
M 20 x 1,5	S	100	242,00 gal Zn

Abmessungen	VE Stück	€/100/Obf.
ISO 08676.800		

8676 8.8



Sechskantschrauben mit Gewinde bis Kopf, mit metrischem Feingewinde

*M 10/12/14/22 = RAZ 3600 übrige Ø = RAZ 440

Maße → TI-15 Anziehmomente → TI-244
Werkstoffeigensch. → TI-232 Normumstellung → TI-6

ISO 8676 → ersetzt DIN 961

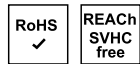

M 8	x	1	x	20	S	200	19,40
M 8	x	1	x	25	S	200	22,90
M 8	x	1	x	30	S	200	24,20
M 8	x	1	x	35	S	200	26,50
M 8	x	1	x	40	S	200	28,50
M 8	x	1	x	45	S	200	32,50
M 8	x	1	x	50	S	200	35,00
M 8	x	1	x	60	S	100	62,00
M 8	x	1	x	70	S	100	81,00
M 8	x	1	x	80	S	100	97,00
M 8	x	1	x	90	S	50	130,00
M 8	x	1	x	100	S	50	147,00
M 10	x	1	x	16	S	200	36,00
M 10	x	1,25	x	16	S	200	36,00
M 10	x	1	x	20	S	200	34,00
M 10	x	1,25	x	20	S	200	34,00
M 10	x	1	x	25	S	200	36,00
M 10	x	1,25	x	25	S	200	36,50
M 10	x	1	x	30	S	200	38,50
M 10	x	1,25	x	30	S	200	39,00
M 10	x	1	x	35	S	100	40,50
M 10	x	1,25	x	35	S	100	43,00
M 10	x	1	x	40	S	100	45,00
M 10	x	1,25	x	40	S	100	47,50
M 10	x	1	x	45	S	100	50,00
M 10	x	1,25	x	45	S	100	51,00
M 10	x	1	x	50	S	100	54,00
M 10	x	1,25	x	50	S	100	55,00
M 10	x	1,25	x	55	S	100	59,00
M 10	x	1	x	60	S	100	98,00
M 10	x	1,25	x	60	S	100	61,00
M 10	x	1	x	70	S	100	136,00
M 10	x	1,25	x	70	S	100	65,00
M 10	x	1	x	80	S	100	147,00
M 10	x	1,25	x	80	S	100	68,00
M 10	x	1	x	90	S	50	182,00
M 10	x	1,25	x	90	S	50	71,00
M 10	x	1	x	100	S	50	194,00
M 10	x	1,25	x	100	S	50	74,00
M 12	x	1,25	x	20	S	100	56,00
M 12	x	1,5	x	20	S	100	54,00
M 12	x	1,25	x	25	S	100	56,00
M 12	x	1,5	x	25	S	100	54,00
M 12	x	1,25	x	30	S	100	57,00
M 12	x	1,5	x	30	S	100	55,00
M 12	x	1,25	x	35	S	100	60,00
M 12	x	1,5	x	35	S	100	59,00
M 12	x	1,25	x	40	S	100	66,00
M 12	x	1,5	x	40	S	100	63,00
M 12	x	1,25	x	45	S	100	73,00
M 12	x	1,5	x	45	S	100	69,00

M 12	x	1,25	x	50	S	100	76,00
M 12	x	1,5	x	50	S	100	74,00
M 12	x	1,5	x	55	S	100	113,00
M 12	x	1,25	x	60	S	100	114,00
M 12	x	1,5	x	60	S	100	113,00
M 12	x	1,25	x	65	S	50	215,00
M 12	x	1,5	x	65	S	50	134,00
M 12	x	1,25	x	70	S	50	152,00
M 12	x	1,5	x	70	S	50	154,00
M 12	x	1,5	x	75	S	50	170,00
M 12	x	1,25	x	80	S	50	184,00
M 12	x	1,5	x	80	S	50	184,00
M 12	x	1,25	x	90	S	50	217,00
M 12	x	1,5	x	90	S	50	234,00
M 12	x	1,25	x	100	S	50	285,00
M 12	x	1,5	x	100	S	50	285,00
M 12	x	1,25	x	110	S	50	285,00
M 12	x	1,5	x	110	S	50	340,00
M 12	x	1,25	x	120	S	50	315,00
M 12	x	1,5	x	120	S	50	390,00
M 12	x	1,25	x	130	S	50	355,00
M 12	x	1,5	x	130	S	50	440,00
M 12	x	1,5	x	140	S	50	485,00
M 14	x	1,5	x	20	S	100	101,00
M 14	x	1,5	x	25	S	100	101,00
M 14	x	1,5	x	30	S	100	101,00
M 14	x	1,5	x	35	S	100	111,00
M 14	x	1,5	x	40	S	100	123,00
M 14	x	1,5	x	45	S	50	126,00
M 14	x	1,5	x	50	S	50	134,00
M 14	x	1,5	x	55	S	50	154,00
M 14	x	1,5	x	60	S	50	154,00
M 14	x	1,5	x	65	S	50	175,00
M 14	x	1,5	x	70	S	50	195,00
M 14	x	1,5	x	75	S	50	234,00
M 14	x	1,5	x	80	S	50	275,00
M 14	x	1,5	x	90	S	50	330,00
M 14	x	1,5	x	100	S	50	400,00
M 14	x	1,5	x	110	S	50	470,00
M 14	x	1,5	x	120	S	50	540,00
M 14	x	1,5	x	130	S	50	610,00
M 14	x	1,5	x	140	S	50	680,00
M 16	x	1,5	x	20	S	50	140,00
M 16	x	1,5	x	25	S	100	123,00
M 16	x	1,5	x	30	S	50	123,00
M 16	x	1,5	x	35	S	50	128,00
M 16	x	1,5	x	40	S	50	128,00
M 16	x	1,5	x	45	S	50	144,00
M 16	x	1,5	x	50	S	50	146,00
M 16	x	1,5	x	55	S	50	165,00
M 16	x	1,5	x	60	S	50	165,00
M 16	x	1,5	x	65	S	50	192,00
M 16	x	1,5	x	70	S	50	209,00
M 16	x	1,5	x	75	S	25	255,00
M 16	x	1,5	x	80	S	25	295,00
M 16	x	1,5	x	85	S	25	370,00
M 16	x	1,5	x	90	S	25	450,00
M 16	x	1,5	x	100	S	25	490,00
M 16	x	1,5	x	110	S	25	530,00
M 16	x	1,5	x	120	S	25	570,00
M 16	x	1,5	x	130	S	25	610,00
M 16	x	1,5	x	140	S	25	650,00
M 16	x	1,5	x	150	S	25	690,00
M 18	x	1,5	x	30	S	50	305,00
M 18	x	1,5	x	35	S	50	310,00
M 18	x	1,5	x	40	S	50	310,00
M 18	x	1,5	x	45	S	50	315,00
M 18	x	1,5	x	50	S	50	320,00
M 18	x	1,5	x	55	S	25	345,00
M 18	x	1,5	x	60	S	25	345,00
M 18	x	1,5	x	65	S	25	360,00
M 18	x	1,5	x	70	S	25	375,00
M 18	x	1,5	x	75	S	25	400,00
M 18	x	1,5	x	80	S	25	425,00
M 18	x	1,5	x	90	S	25	580,00

M 18	x	1,5	x	100	S	25	730,00
M 18	x	1,5	x	120	S	25	1030,00
M 18	x	1,5	x	140	S	25	1320,00
M 18	x	1,5	x	150	S	25	1480,00
M 20	x	1,5	x	30	S	25	290,00
M 20	x	1,5	x	35	S	25	290,00
M 20	x	1,5	x	40	S	25	290,00
M 20	x	1,5	x	45	S	25	290,00
M 20	x	1,5	x	50	S	25	300,00
M 20	x	2	x	50	S	25	410,00
M 20	x	1,5	x	55	S	25	325,00
M 20	x	2	x	55	S	25	530,00
M 20	x	1,5	x	60	S	25	325,00
M 20	x	2	x	60	S	25	530,00
M 20	x	1,5	x	65	S	25	360,00
M 20	x	2	x	65	S	25	590,00
M 20	x	1,5	x	70	S	25	350,00
M 20	x	2	x	70	S	25	660,00
M 20	x	1,5	x	75	S	25	385,00
M 20	x	1,5	x	80	S	25	405,00
M 20	x	2	x	80	S	25	770,00
M 20	x	1,5	x	85	S	25	470,00
M 20	x	1,5	x	90	S	25	530,00
M 20	x	1,5	x	100	S	25	650,00
M 20	x	2	x	100	S	25	1010,00
M 20	x	1,5	x	110	S	25	780,00
M 20	x	1,5	x	120	S	25	910,00
M 20	x	2	x	120	S	25	1240,00
M 20	x	1,5	x	130	S	25	1050,00
M 20	x	1,5	x	140	S	25	1180,00
M 20	x	1,5	x	150	S	25	1340,00
M 22	x	1,5	x	50	S	25	660,00
M 22	x	1,5	x	60	S	25	700,00
M 22	x	1,5	x	70	S	25	770,00
M 24	x	1,5	x	50	S	25	690,00
M 24	x	2	x	50	S	25	690,00
M 24	x	1,5	x	55	S	25	910,00
M 24	x	1,5	x	60	S	25	990,00
M 24	x	2	x	60	S	25	990,00
M 24	x	1,5	x	70	S	25	1090,00
M 24	x	2	x	70	S	25	1090,00
M 24	x	1,5	x	80	S	25	1170,00
M 24	x	2	x	80	S	25	1170,00
M 24	x	1,5	x	90	S	10	1220,00
M 24	x	2	x	90	S	10	1220,00
M 24	x	1,5	x	100	S	10	1310,00
M 24	x	2	x	100	S	10	1310,00
M 24	x	1,5	x	110	S	10	1400,00
M 24	x	2	x	110	S	10	1400,00
M 24	x	1,5	x	120	S	10	1470,00
M 24	x	2	x	120	S	10	1470,00
M 24	x	1,5	x	130	S	1	1550,00
M 24	x	2	x	130	S	1	1550,00
M 24	x	1,5	x	140	S	1	1640,00
M 24	x	2	x	150	S	1	1720,00
M 30	x	2	x	60	S	1	1310,00
M 30	x	2	x	70	S	1	1430,00
M 30	x	2	x	80	S	1	1540,00
M 30	x	2	x	90	S	1	1630,00
M 30	x	2	x	100	S	1	1750,00
M 30	x	2	x	110	S	1	1870,00
M 30	x	2	x	120	S	1	1990,00
M 30	x	2	x	130	S	1	2130,00
M 30	x	2	x	140	S	1	2270,00
M 30	x	2	x	150	S	1	2390,00
M 30							

Abmessungen	VE	Stück	€/100/Obf.
M 42 x 3 x 140 S 1			5400,00
M 42 x 3 x 160 S 1			5900,00
M 42 x 3 x 180 S 1			6400,00
M 42 x 3 x 200 S 1			6900,00

ISO	08676.810
8676	8.8
	galvanisch verzinkt

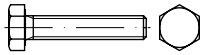

Sechskantschrauben mit Gewinde bis Kopf, mit metrischem Feingewinde

*M 10/12/14/22 = RAZ 3600 übrige Ø = RAZ 440

Maße → TI-15 Anziehmomente → TI-244
 Werkstoffeigensch. → TI-232 Normumstellung → TI-6
 Korrosionsschutz → TI-228

ISO 8676 → ersetzt DIN 961

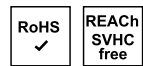

M 8 x 1 x 20 S 200			29,00 gal Zn
M 10 x 1 x 16 S 200			42,50 gal Zn
M 10 x 1 x 20 S 200			42,50 gal Zn
M 10 x 1,25 x 20 S 200			42,50 gal Zn
M 10 x 1 x 25 S 200			43,50 gal Zn
M 10 x 1,25 x 25 S 200			43,00 gal Zn
M 10 x 1 x 30 S 200			47,00 gal Zn
M 10 x 1,25 x 30 S 200			46,50 gal Zn
M 10 x 1,25 x 35 S 100			52,00 gal Zn
M 10 x 1 x 40 S 100			59,00 gal Zn
M 10 x 1,25 x 40 S 100			59,00 gal Zn
M 10 x 1,25 x 45 S 100			63,00 gal Zn
M 10 x 1 x 50 S 100			67,00 gal Zn
M 10 x 1,25 x 50 S 100			67,00 gal Zn
M 12 x 1,25 x 20 S 100			66,00 gal Zn
M 12 x 1,5 x 20 S 100			65,00 gal Zn
M 12 x 1,25 x 25 S 100			67,00 gal Zn
M 12 x 1,5 x 25 S 100			65,00 gal Zn
M 12 x 1,25 x 30 S 100			67,00 gal Zn
M 12 x 1,5 x 30 S 100			66,00 gal Zn
M 12 x 1,25 x 35 S 100			72,00 gal Zn
M 12 x 1,5 x 35 S 100			72,00 gal Zn
M 12 x 1,25 x 40 S 100			80,00 gal Zn
M 12 x 1,5 x 40 S 100			75,00 gal Zn
M 12 x 1,25 x 45 S 100			88,00 gal Zn
M 12 x 1,5 x 45 S 100			86,00 gal Zn
M 12 x 1,5 x 50 S 100			92,00 gal Zn
M 12 x 1,5 x 55 S 100			131,00 gal Zn
M 12 x 1,5 x 60 S 100			132,00 gal Zn
M 12 x 1,25 x 65 S 50			236,00 gal Zn
M 12 x 1,25 x 70 S 50			174,00 gal Zn
M 12 x 1,5 x 80 S 50			209,00 gal Zn
M 14 x 1,5 x 25 S 100			117,00 gal Zn
M 14 x 1,5 x 30 S 100			123,00 gal Zn
M 14 x 1,5 x 35 S 100			138,00 gal Zn
M 14 x 1,5 x 40 S 100			144,00 gal Zn
M 14 x 1,5 x 45 S 50			148,00 gal Zn
M 14 x 1,5 x 50 S 50			158,00 gal Zn
M 14 x 1,5 x 60 S 50			182,00 gal Zn
M 14 x 1,5 x 70 S 50			227,00 gal Zn
M 14 x 1,5 x 80 S 50			310,00 gal Zn
M 14 x 1,5 x 90 S 50			440,00 gal Zn
M 14 x 1,5 x 100 S 50			445,00 gal Zn
M 16 x 1,5 x 30 S 50			146,00 gal Zn
M 16 x 1,5 x 35 S 50			154,00 gal Zn
M 16 x 1,5 x 40 S 50			153,00 gal Zn

Abmessungen	VE	Stück	€/100/Obf.
M 16 x 1,5 x 45 S 50			172,00 gal Zn
M 16 x 1,5 x 50 S 50			175,00 gal Zn
M 16 x 1,5 x 60 S 50			194,00 gal Zn
M 16 x 1,5 x 70 S 50			249,00 gal Zn
M 16 x 1,5 x 80 S 25			295,00 gal Zn
M 16 x 1,5 x 90 S 25			500,00 gal Zn
M 16 x 1,5 x 100 S 25			540,00 gal Zn
M 18 x 1,5 x 40 S 50			355,00 gal Zn
M 18 x 1,5 x 50 S 50			365,00 gal Zn
M 18 x 1,5 x 55 S 25			390,00 gal Zn
M 18 x 1,5 x 60 S 25			365,00 gal Zn
M 18 x 1,5 x 70 S 25			425,00 gal Zn
M 18 x 1,5 x 80 S 25			485,00 gal Zn
M 20 x 1,5 x 30 S 50			330,00 gal Zn
M 20 x 1,5 x 35 S 50			335,00 gal Zn
M 20 x 1,5 x 40 S 50			340,00 gal Zn
M 20 x 1,5 x 45 S 50			345,00 gal Zn
M 20 x 1,5 x 50 S 25			375,00 gal Zn
M 20 x 1,5 x 55 S 25			380,00 gal Zn
M 20 x 1,5 x 60 S 25			410,00 gal Zn
M 20 x 1,5 x 70 S 25			440,00 gal Zn
M 20 x 1,5 x 80 S 25			500,00 gal Zn
M 20 x 1,5 x 90 S 25			610,00 gal Zn
M 20 x 1,5 x 100 S 25			740,00 gal Zn
M 20 x 1,5 x 110 S 10			850,00 gal Zn
M 24 x 2 x 50 S 25			820,00 gal Zn
M 24 x 1,5 x 60 S 25			1130,00 gal Zn
M 24 x 1,5 x 80 S 25			1340,00 gal Zn
M 24 x 2 x 90 S 25			1400,00 gal Zn
M 24 x 2 x 100 S 25			1520,00 gal Zn

ISO	08676.100
8676	10.9

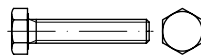

Sechskantschrauben mit Gewinde bis Kopf, mit metrischem Feingewinde

*M 10/12/14/22 = RAZ 3600 übrige Ø = RAZ 440

Maße → TI-15 Anziehmomente → TI-244
 Werkstoffeigensch. → TI-232 Normumstellung → TI-6

ISO 8676 → ersetzt DIN 961

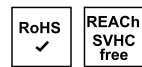

M 8 x 1 x 20 S 200			29,00
M 8 x 1 x 25 S 200			30,50
M 8 x 1 x 30 S 200			31,50
M 8 x 1 x 35 S 200			37,50
M 8 x 1 x 40 S 200			40,00
M 8 x 1 x 45 S 200			44,50
M 8 x 1 x 50 S 200			48,50
M 8 x 1 x 60 S 200			57,00
M 8 x 1 x 70 S 200			66,00
M 8 x 1 x 80 S 200			62,00
M 8 x 1 x 80 S 200			42,00
M 10 x 1,25 x 16 S 200			97,00
M 10 x 1 x 20 S 200			45,00
M 10 x 1,25 x 20 S 200			102,00
M 10 x 1 x 25 S 200			47,50
M 10 x 1,25 x 25 S 200			107,00
M 10 x 1 x 30 S 200			50,00
M 10 x 1,25 x 30 S 200			110,00
M 10 x 1 x 35 S 100			54,00
M 10 x 1,25 x 35 S 100			115,00

Abmessungen	VE	Stück	€/100/Obf.
M 10 x 1 x 40 S 100			57,00
M 10 x 1,25 x 40 S 100			123,00
M 10 x 1 x 45 S 100			81,00
M 10 x 1,25 x 45 S 100			140,00
M 10 x 1 x 50 S 100			103,00
M 10 x 1,25 x 50 S 100			158,00
M 10 x 1,25 x 55 S 100			176,00
M 10 x 1 x 60 S 100			137,00
M 10 x 1,25 x 60 S 100			212,00
M 10 x 1 x 70 S 100			171,00
M 10 x 1,25 x 70 S 100			249,00
M 10 x 1 x 80 S 100			205,00
M 10 x 1,25 x 80 S 100			285,00
M 10 x 1 x 90 S 100			239,00
M 10 x 1,25 x 90 S 100			325,00
M 10 x 1 x 100 S 100			275,00
M 10 x 1,25 x 100 S 100			360,00
M 12 x 1,25 x 20 S 100			84,00
M 12 x 1,5 x 20 S 100			82,00
M 12 x 1,25 x 25 S 100			78,00
M 12 x 1,5 x 25 S 100			76,00
M 12 x 1,25 x 30 S 100			81,00
M 12 x 1,5 x 30 S 100			82,00
M 12 x 1,25 x 35 S 100			86,00
M 12 x 1,5 x 35 S 100			85,00
M 12 x 1,25 x 40 S 100			90,00
M 12 x 1,5 x 40 S 100			90,00
M 12 x 1,25 x 45 S 100			103,00
M 12 x 1,5 x 45 S 100			100,00
M 12 x 1,25 x 50 S 100			107,00
M 12 x 1,5 x 50 S 100			107,00
M 12 x 1,5 x 55 S 100			98,00
M 12 x 1,25 x 60 S 100			117,00
M 12 x 1,5 x 60 S 100			116,00
M 12 x 1,25 x 65 S 50			125,00
M 12 x 1,5 x 65 S 50			129,00
M 12 x 1,25 x 70 S 50			131,00
M 12 x 1,5 x 70 S 50			124,00
M 12 x 1,5 x 75 S 50			152,00
M 12 x 1,25 x 80 S 50			146,00
M 12 x 1,5 x 80 S 50			129,00
M 12 x 1,25 x 90 S 50			160,00
M 12 x 1,5 x 90 S 50			175,00
M 12 x 1,25 x 100 S 50			174,00
M 12 x 1,5 x 100 S 50			188,00
M 12 x 1,25 x 110 S 50			188,00
M 12 x 1,5 x 110 S 50			199,00
M 12 x 1,25 x 120 S 50			203,00
M 12 x 1,5 x 120 S 50			210,00
M 12 x 1,25 x 130 S 50			216,00
M 12 x 1,5 x 130 S 50			223,00
M 12 x 1,5 x 140 S 50			236,00
M 14 x 1,5 x 25 S 100			153,00
M 14 x 1,5 x 30 S 100			138,00
M 14 x 1,5 x 35 S 100			144,00
M 14 x 1,5 x 40 S 100			148,00
M 14 x 1,5 x 45 S 50			154,00
M 14 x 1,5 x 50 S 50			160,00
M 14 x 1,5 x 55 S 50			209,00
M 14 x 1,5 x 60 S 50			209,00
M 14 x 1,5 x 65 S 50			335,00
M 14 x 1,5 x 70 S 50			450,00
M 14 x 1,5 x 75 S 50			485,00
M 14 x 1,5 x 80 S 50			520,00
M 14 x 1,5 x 90 S 50			590,00
M 14 x 1,5 x 100 S 50			660,00
M 14 x 1,5 x 110 S 50			730,00
M 14 x 1,5 x 120 S 50			790,00
M 14 x 1,5 x 130 S 50			860,00
M 14 x 1,5 x 140 S 50			940,00
M 16 x 1,5 x 25 S 50			161,00
M 16 x 1,5 x 30 S 50			164,00
M 16 x 1,5 x 35 S 50			165,00
M 16 x 1,5 x 40 S 50			174,00
M 16 x 1,5 x 45 S 50			182,00

Abmessungen	VE	Stück	€/100/Obf.
M 16 x 1,5 x 50 S 50			192,00
M 16 x 1,5 x 55 S 50			212,00
M 16 x 1,5 x 60 S 50			212,00
M 16 x 1,5 x 65 S 50			300,00
M 16 x 1,5 x 70 S 50			300,00
M 16 x 1,5 x 75 S 25			365,00
M 16 x 1,5 x 80 S 25			430,00
M 16 x 1,5 x 85 S 25			455,00
M 16 x 1,5 x 90 S 25			470,00
M 16 x 1,5 x 100 S 25			510,00
M 16 x 1,5 x 110 S 25			540,00
M 16 x 1,5 x 120 S 25			570,00
M 16 x 1,5 x 130 S 25			600,00
M 16 x 1,5 x 140 S 25			650,00
M 16 x 1,5 x 150 S 25			670,00
M 18 x 1,5 x 30 S 50			470,00
M 18 x 1,5 x 35 S 50			480,00
M 18 x 1,5 x 40 S 50			485,00
M 18 x 1,5 x 45 S 50			510,00
M 18 x 1,5 x 50 S 50			530,00
M 18 x 1,5 x 55 S 25			570,00
M 18 x 1,5 x 60 S 25			570,00
M 18 x 1,5 x 65 S 25			330,00
M 18 x 1,5 x 55 S 25			650,00
M 18 x 1,5 x 75 S 25			680,00
M 18 x 1,5 x 80 S 25			750,00
M 18 x 1,5 x 90 S 25			820,00
M 18 x 1,5 x 100 S 25			880,00
M 18 x 1,5 x 120 S 25			960,00
M 18 x 1,5 x 140 S 25			1030,00
M 18 x 1,5 x 150 S 25			1120,00
M 20 x 1,5 x 30 S 50			395,00
M 20 x 1,5 x 35 S 50			400,00
M 20 x 1,5 x 40 S 50			410,00
M 20 x 1,5 x 45 S 25			435,00
M 20 x 1,5 x 50 S 25			445,00
M 20 x 2 x 50 S 50			670,00
M 20 x 1,5 x 55 S 25			460,00
M 20 x 2 x 55 S 25			690,00
M 20 x 1,5 x 60 S 25			485,00
M 20 x 2 x 60 S 25			415,00
M 20 x 1,5 x 65 S 25			610,00
M 20 x 2 x 65 S 25			520,00
M 20 x 1,5 x 70 S 25			640,00
M 20 x 2 x 70 S 25			960,00
M 20 x 1,5 x 75 S 25			690,00
M 20 x 1,5 x 80 S 25			760,00
M 20 x 2 x 80 S 25			1140,00
M 20 x 1,5 x 85 S 25			780,00
M 20 x 1,5 x 90 S 25			810,00
M 20 x 1,5 x 100 S 25			890,00
M 20 x 2 x 100 S 25			1340,00
M 20 x 1,5 x 110 S 25			305,00
M 20 x 1,5 x 120 S 25			960,00
M 20 x 2 x 120 S 25			1440,00
M 20 x 1,5 x 130 S 25			1420,00
M 20 x 1,5 x 140 S 25			1900,00
M 20 x 1,5 x 150 S 25			2650,00
M 24 x 1,5 x 50 S 25			850,00
M 24 x 2 x 50 S 25			1000,00
M 24 x 1,5 x 55 S 25			880,00
M 24 x 1,5 x 60 S 25			910,00
M 24 x 2 x 60 S 25			1150,00
M 24 x 1,5 x 70 S 25			970,00
M 24 x 2 x 70 S 25			1310,00
M 24 x 1,5 x 80 S 25			1060,00
M 24 x 2 x 80 S 25			1460,00
M 24 x 1,5 x 90 S 10			1150,00
M 24 x 2 x 90 S 10			1610,00
M 24 x 1,5 x 100 S 10			1280,00
M 24 x 2 x 100 S 10			1760,00
M 24 x 1,5 x 110 S 10			1460,00
M 24 x 2 x 110 S 10			1920,00
M 24 x 1,5 x 120 S 10			1640,00
M 24 x 2 x 120 S 10			2060,00

Abmessungen	VE	Stück	€/100/Obf.
M 24 x 1,5 x 130 S 10			1880,00
M 24 x 2 x 130 S 10			2220,00
M 24 x 1,5 x 140 S 10			2120,00
M 24 x 2 x 150 S 10			2360,00
M 30 x 2 x 60 S 1			1580,00
M 30 x 2 x 70 S 1			1710,00
M 30 x 2 x 80 S 1			1850,00
M 30 x 2 x 90 S 1			1960,00
M 30 x 2 x 100 S 1			2090,00
M 30 x 2 x 110 S 1			2250,00
M 30 x 2 x 120 S 1			2380,00
M 30 x 2 x 130 S 1			2550,00
M 30 x 2 x 140 S 1			2750,00
M 30 x 2 x 150 S 1			2900,00
M 30 x 2 x 160 S 1			3050,00
M 36 x 3 x 80 S 1			2900,00
M 36 x 3 x 90 S 1			3100,00
M 36 x 3 x 100 S 1			3300,00
M 36 x 3 x 110 S 1			3450,00
M 36 x 3 x 120 S 1			3650,00
M 36 x 3 x 130 S 1			3950,00
M 36 x 3 x 140 S 1			4150,00
M 36 x 3 x 150 S 1			4450,00
M 36 x 3 x 160 S 1			4750,00
M 36 x 3 x 140 S 1			5800,00
M 36 x 3 x 160 S 1			6700,00
M 36 x 3 x 180 S 1			7600,00
M 36 x 3 x 200 S 1			8400,00

Abmessungen	VE	Stück	€/100/Obf.
M 12 x 1,5 x 60 S 100			170,00 gal Zn
M 12 x 1,5 x 70 S 100			194,00 gal Zn
M 12 x 1,5 x 80 S 200			242,00 gal Zn
M 14 x 1,5 x 25 S 100			176,00 gal Zn
M 14 x 1,5 x 30 S 100			177,00 gal Zn
M 14 x 1,5 x 35 S 100			177,00 gal Zn
M 14 x 1,5 x 40 S 100			184,00 gal Zn
M 14 x 1,5 x 45 S 50			203,00 gal Zn
M 14 x 1,5 x 50 S 50			211,00 gal Zn
M 14 x 1,5 x 55 S 50			275,00 gal Zn
M 14 x 1,5 x 60 S 50			249,00 gal Zn
M 14 x 1,5 x 70 S 50			495,00 gal Zn
M 14 x 1,5 x 80 S 50			570,00 gal Zn
M 16 x 1,5 x 25 S 50			199,00 gal Zn
M 16 x 1,5 x 30 S 50			199,00 gal Zn
M 16 x 1,5 x 35 S 50			201,00 gal Zn
M 16 x 1,5 x 40 S 50			216,00 gal Zn
M 16 x 1,5 x 45 S 50			227,00 gal Zn
M 16 x 1,5 x 50 S 50			239,00 gal Zn
M 16 x 1,5 x 55 S 50			270,00 gal Zn
M 16 x 1,5 x 60 S 50			275,00 gal Zn
M 16 x 1,5 x 70 S 25			370,00 gal Zn
M 16 x 1,5 x 80 S 25			495,00 gal Zn
M 16 x 1,5 x 90 S 25			550,00 gal Zn
M 20 x 1,5 x 40 S 50			485,00 gal Zn
M 20 x 1,5 x 45 S 25			520,00 gal Zn
M 20 x 1,5 x 50 S 25			550,00 gal Zn
M 20 x 1,5 x 55 S 25			570,00 gal Zn
M 20 x 1,5 x 60 S 25			600,00 gal Zn

ISO	08676.110
8676	10.9 galvanisch verzinkt

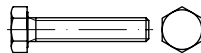

Sechskantschrauben mit Gewinde bis Kopf, mit metrischem Feingewinde

getempert, *M 10/12/14/22 = RAZ 3600 übrige Ø = RAZ 440

Achtung! Warneinblender zu Wasserstoffversprödung beachten.

Maße → TI-15 Anziehmomente → TI-244
 Werkstoffeigensch. → TI-232 Normumstellung → TI-6
 Korrosionsschutz → TI-228

ISO 8676 → ersetzt DIN 961



M 8 x 1 x 20 S 200			63,00 gal Zn
M 8 x 1 x 25 S 200			66,00 gal Zn
M 8 x 1 x 30 S 200			67,00 gal Zn
M 8 x 1 x 35 S 200			70,00 gal Zn
M 10 x 1 x 20 S 200			58,00 gal Zn
M 10 x 1 x 30 S 200			61,00 gal Zn
M 10 x 1,25 x 30 S 200			124,00 gal Zn
M 10 x 1 x 35 S 100			66,00 gal Zn
M 10 x 1 x 40 S 200			74,00 gal Zn
M 10 x 1 x 45 S 100			81,00 gal Zn
M 12 x 1,5 x 30 S 100			100,00 gal Zn
M 12 x 1,25 x 35 S 100			104,00 gal Zn
M 12 x 1,5 x 35 S 100			104,00 gal Zn
M 12 x 1,25 x 40 S 100			110,00 gal Zn
M 12 x 1,5 x 40 S 100			110,00 gal Zn
M 12 x 1,5 x 45 S 100			131,00 gal Zn
M 12 x 1,5 x 50 S 100			142,00 gal Zn
M 12 x 1,5 x 55 S 100			155,00 gal Zn

Wichtiger Hinweis!



Bei galvanischen Überzügen auf hochfesten und federharten Teilen (≥1000 N/mm² oder ≥320 HV) ist die Gefahr einer Wasserstoffversprödung (Spröbruchgefahr) nicht mit Sicherheit auszuschließen (ISO 4042). Durch eine rechtzeitig eingeleitete thermische Nachbehandlung (Tempern) kann die Gefahr eines wasserstoffinduzierten Spröbruchs im Regelfall verringert werden. Da aber ein Restrisiko nicht mit Sicherheit auszuschließen ist, erfolgen galvanische Überzüge auf derartigen Teilen nur auf ausdrücklichen Wunsch und auf Risiko des Auftraggebers.

ISO	08734.001
8734	Stahl gehärtet Typ A

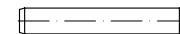

Zylinderstifte, Toleranzfeld m6, A = durchgehärtet

Maße → TI-116 REACH → TI-262
 Normumstellung → TI-10

ISO 8734 → ersetzt DIN 6325



1 m6 x 4 S 1000			24,40
1 m6 x 5 S 1000			25,50
1 m6 x 6 S 1000			26,00
1 m6 x 8 S 1000			26,50

Abmessungen	VE	Stück	€/100/Obf.	Abmessungen	VE	Stück	€/100/Obf.	Abmessungen	VE	Stück	€/100/Obf.
1 m6 x 10	S	1000	27,00	5 m6 x 16	S	500	37,00	10 m6 x 60	S	100	246,00
1 m6 x 12	S	1000	28,00	5 m6 x 18	S	500	39,50	10 m6 x 70	S	100	280,00
1,5 m6 x 4	S	1000	21,00	5 m6 x 20	S	500	41,50	10 m6 x 80	S	100	310,00
1,5 m6 x 5	S	1000	21,00	5 m6 x 22	S	500	61,00	10 m6 x 90	S	100	345,00
1,5 m6 x 6	S	1000	21,50	5 m6 x 24	S	500	46,00	10 m6 x 100	S	100	380,00
1,5 m6 x 8	S	1000	22,30	5 m6 x 26	S	500	47,50	10 m6 x 110	S	100	425,00
1,5 m6 x 10	S	1000	23,00	5 m6 x 28	S	500	51,00	10 m6 x 120	S	100	520,00
1,5 m6 x 12	S	1000	23,90	5 m6 x 30	S	500	53,00	12 m6 x 20	S	100	184,00
1,5 m6 x 14	S	1000	24,40	5 m6 x 32	S	500	54,00	12 m6 x 24	S	100	200,00
1,5 m6 x 16	S	1000	25,50	5 m6 x 36	S	500	58,00	12 m6 x 26	S	100	200,00
1,5 m6 x 20	S	1000	26,50	5 m6 x 40	S	500	63,00	12 m6 x 28	S	100	200,00
2 m6 x 4	S	1000	22,10	5 m6 x 45	S	500	68,00	12 m6 x 30	S	100	205,00
2 m6 x 5	S	1000	22,10	5 m6 x 50	S	500	82,00	12 m6 x 32	S	100	213,00
2 m6 x 6	S	1000	22,30	5 m6 x 55	S	500	89,00	12 m6 x 36	S	100	229,00
2 m6 x 8	S	1000	22,60	5 m6 x 60	S	500	96,00	12 m6 x 40	S	100	244,00
2 m6 x 10	S	1000	23,30	5 m6 x 70	S	500	112,00	12 m6 x 45	S	100	265,00
2 m6 x 12	S	1000	24,10	6 m6 x 8	S	200	38,00	12 m6 x 50	S	100	285,00
2 m6 x 14	S	1000	24,60	6 m6 x 10	S	200	38,00	12 m6 x 55	S	100	305,00
2 m6 x 16	S	1000	26,00	6 m6 x 12	S	200	38,00	12 m6 x 60	S	100	325,00
2 m6 x 18	S	1000	26,50	6 m6 x 14	S	200	41,00	12 m6 x 70	S	100	410,00
2 m6 x 20	S	1000	27,00	6 m6 x 16	S	200	43,00	12 m6 x 80	S	100	445,00
2 m6 x 24	S	1000	32,50	6 m6 x 18	S	200	46,00	12 m6 x 90	S	100	485,00
2 m6 x 30	S	1000	47,00	6 m6 x 20	S	200	48,50	12 m6 x 100	S	100	530,00
2 m6 x 32	S	500	48,00	6 m6 x 22	S	200	51,00	12 m6 x 110	S	100	590,00
2,5 m6 x 6	S	1000	22,60	6 m6 x 24	S	200	54,00	12 m6 x 120	S	100	630,00
2,5 m6 x 8	S	1000	23,00	6 m6 x 26	S	200	57,00	14 m6 x 50	S	50	590,00
2,5 m6 x 10	S	1000	23,90	6 m6 x 28	S	200	60,00	14 m6 x 60	S	50	680,00
2,5 m6 x 12	S	1000	24,40	6 m6 x 30	S	200	63,00	14 m6 x 70	S	50	790,00
2,5 m6 x 14	S	1000	25,50	6 m6 x 32	S	200	67,00	14 m6 x 80	S	50	950,00
2,5 m6 x 16	S	1000	26,50	6 m6 x 36	S	200	73,00	14 m6 x 100	S	50	1110,00
2,5 m6 x 18	S	1000	27,00	6 m6 x 40	S	200	77,00	14 m6 x 120	S	50	1310,00
2,5 m6 x 20	S	1000	28,00	6 m6 x 45	S	200	84,00	16 m6 x 30	S	50	540,00
2,5 m6 x 24	S	1000	38,50	6 m6 x 50	S	200	92,00	16 m6 x 40	S	50	570,00
2,5 m6 x 26	S	1000	41,00	6 m6 x 55	S	200	105,00	16 m6 x 45	S	50	610,00
2,5 m6 x 28	S	1000	44,00	6 m6 x 60	S	200	112,00	16 m6 x 50	S	50	650,00
3 m6 x 6	S	500	23,30	6 m6 x 70	S	200	125,00	16 m6 x 55	S	50	680,00
3 m6 x 8	S	500	23,30	6 m6 x 80	S	200	166,00	16 m6 x 60	S	50	740,00
3 m6 x 10	S	500	24,10	6 m6 x 90	S	200	189,00	16 m6 x 70	S	50	850,00
3 m6 x 12	S	500	24,60	6 m6 x 100	S	200	211,00	16 m6 x 80	S	50	990,00
3 m6 x 14	S	500	26,00	8 m6 x 10	S	100	77,00	16 m6 x 90	S	50	1050,00
3 m6 x 16	S	500	27,00	8 m6 x 12	S	100	71,00	16 m6 x 100	S	1	1140,00
3 m6 x 18	S	500	27,50	8 m6 x 14	S	100	71,00	16 m6 x 110	S	1	1260,00
3 m6 x 20	S	500	28,50	8 m6 x 16	S	100	77,00	16 m6 x 120	S	1	1350,00
3 m6 x 22	S	500	29,50	8 m6 x 18	S	100	82,00	20 m6 x 40	S	25	890,00
3 m6 x 24	S	500	31,00	8 m6 x 20	S	100	85,00	20 m6 x 50	S	25	910,00
3 m6 x 26	S	500	31,50	8 m6 x 22	S	100	90,00	20 m6 x 60	S	25	990,00
3 m6 x 28	S	500	32,50	8 m6 x 24	S	100	94,00	20 m6 x 80	S	25	1260,00
3 m6 x 30	S	500	33,50	8 m6 x 26	S	100	96,00	20 m6 x 100	S	25	1470,00
3 m6 x 32	S	500	34,00	8 m6 x 28	S	100	101,00	20 m6 x 120	S	25	1720,00
3 m6 x 40	S	500	49,50	8 m6 x 30	S	100	106,00				
3 m6 x 45	S	500	57,00	8 m6 x 32	S	100	111,00				
3 m6 x 50	S	500	67,00	8 m6 x 36	S	100	117,00				
4 m6 x 6	S	500	23,30	8 m6 x 40	S	100	125,00				
4 m6 x 8	S	500	25,50	8 m6 x 45	S	100	136,00				
4 m6 x 10	S	500	27,00	8 m6 x 50	S	100	146,00				
4 m6 x 12	S	500	29,00	8 m6 x 55	S	100	155,00				
4 m6 x 14	S	500	31,00	8 m6 x 60	S	100	166,00				
4 m6 x 16	S	500	31,50	8 m6 x 70	S	100	190,00				
4 m6 x 18	S	500	33,50	8 m6 x 80	S	100	207,00				
4 m6 x 20	S	500	34,50	8 m6 x 90	S	100	229,00				
4 m6 x 22	S	500	36,00	8 m6 x 100	S	100	250,00				
4 m6 x 24	S	500	38,00	8 m6 x 120	S	100	295,00				
4 m6 x 26	S	500	39,00	10 m6 x 16	S	100	124,00				
4 m6 x 28	S	500	41,50	10 m6 x 20	S	100	126,00				
4 m6 x 30	S	500	42,50	10 m6 x 22	S	100	130,00				
4 m6 x 32	S	500	44,00	10 m6 x 24	S	100	131,00				
4 m6 x 36	S	500	47,00	10 m6 x 26	S	100	137,00				
4 m6 x 40	S	500	53,00	10 m6 x 28	S	100	143,00				
4 m6 x 45	S	500	63,00	10 m6 x 30	S	100	148,00				
4 m6 x 50	S	500	76,00	10 m6 x 32	S	100	155,00				
4 m6 x 60	S	500	106,00	10 m6 x 36	S	100	176,00				
5 m6 x 8	S	500	33,50	10 m6 x 40	S	100	186,00				
5 m6 x 10	S	500	33,50	10 m6 x 45	S	100	205,00				
5 m6 x 12	S	500	33,50	10 m6 x 50	S	100	216,00				
5 m6 x 14	S	500	34,50	10 m6 x 55	S	100	234,00				

Abmessungen VE Stück €/100/Obf.
ISO 08736.001

8736

Stahl

Typ A



**Kegelstifte mit Innengewinde,
Kegel 1 : 50,
A = geschliffen**

ISO 8736 = EN 28736

Maße → **Ti-118** REACH → **Ti-262**
Normumstellung → **Ti-10**

ISO 8736 → ersetzt DIN 7978 (austauschbar)



A 6	x	16	S	25	155,00
A 6	x	20	S	25	158,00
A 6	x	24	S	25	171,00
A 6	x	26	S	25	172,00
A 6	x	28	S	25	177,00
A 6	x	30	S	25	181,00
A 6	x	32	S	25	183,00
A 6	x	36	S	25	190,00
A 6	x	40	S	25	190,00
A 6	x	45	S	25	197,00
A 6	x	50	S	25	204,00
A 6	x	55	S	25	211,00
A 6	x	60	S	25	265,00
A 6	x	70	S	25	300,00
A 6	x	80	S	25	325,00
A 8	x	20	S	10	204,00
A 8	x	24	S	10	217,00
A 8	x	26	S	10	222,00
A 8	x	28	S	10	224,00
A 8	x	30	S	10	229,00
A 8	x	32	S	10	233,00
A 8	x	36	S	10	241,00
A 8	x	40	S	10	244,00
A 8	x	45	S	10	260,00
A 8	x	50	S	10	265,00
A 8	x	55	S	10	275,00
A 8	x	60	S	10	280,00
A 8	x	70	S	10	315,00
A 8	x	80	S	10	335,00
A 8	x	90	S	10	365,00
A 8	x	100	S	10	480,00
A 10	x	28	S	10	275,00
A 10	x	30	S	10	280,00
A 10	x	32	S	10	285,00
A 10	x	36	S	10	295,00
A 10	x	40	S	10	300,00
A 10	x	45	S	10	315,00
A 10	x	50	S	10	325,00
A 10	x	55	S	10	335,00
A 10	x	60	S	10	340,00
A 10	x	70	S	10	395,00
A 10	x	80	S	10	430,00
A 10	x	90	S	10	470,00
A 10	x	100	S	10	510,00
A 10	x	120	S	5	1400,00
A 12	x	36	S	10	370,00
A 12	x	40	S	10	385,00
A 12	x	45	S	10	395,00
A 12	x	50	S	10	415,00
A 12	x	55	S	10	425,00
A 12	x	60	S	10	445,00

Abmessungen VE Stück €/100/Obf.

A 12	x	70	S	10	480,00
A 12	x	80	S	10	540,00
A 12	x	90	S	10	580,00
A 12	x	100	S	10	620,00
A 16	x	40	S	10	560,00
A 16	x	45	S	10	590,00
A 16	x	50	S	10	620,00
A 16	x	55	S	10	650,00
A 16	x	60	S	10	680,00
A 16	x	70	S	5	730,00
A 16	x	80	S	5	780,00
A 16	x	90	S	5	840,00
A 16	x	100	S	5	920,00
A 16	x	120	S	5	3450,00
A 20	x	50	S	1	1240,00
A 20	x	55	S	1	1310,00
A 20	x	60	S	1	1370,00
A 20	x	70	S	1	1440,00
A 20	x	80	S	1	1540,00
A 20	x	90	S	1	1700,00
A 20	x	100	S	1	1840,00
A 20	x	120	S	1	2160,00

ISO 08737.000

8737

Stahl ungehärtet



**Kegelstifte mit Gewindezapfen
und konstanten Zapfenlängen,
Kegel 1 : 50**

ISO 8737 = EN 28373

Maße → **Ti-117** REACH → **Ti-262**
Normumstellung → **Ti-10**

ISO 8737 → ersetzt DIN 7977 (austauschbar)
Ausführung mit konstanten Kegellängen → DIN 258



5	x	40	S	25	138,00
5	x	45	S	25	148,00
5	x	50	S	25	155,00
6	x	40	S	25	165,00
6	x	45	S	25	175,00
6	x	50	S	25	175,00
6	x	55	S	10	224,00
6	x	60	S	10	190,00
8	x	50	S	10	235,00
8	x	55	S	10	235,00
8	x	60	S	10	240,00
8	x	65	S	10	250,00
8	x	75	S	10	270,00
8	x	85	S	10	340,00
8	x	100	S	10	430,00
10	x	50	S	10	315,00
10	x	60	S	10	330,00
10	x	65	S	10	330,00
10	x	75	S	10	345,00
10	x	85	S	10	385,00
10	x	100	S	10	420,00
10	x	120	S	1	590,00
12	x	75	S	10	455,00
12	x	80	S	10	590,00
12	x	85	S	10	470,00
12	x	100	S	10	540,00
12	x	120	S	10	740,00
12	x	140	S	5	760,00

Abmessungen VE Stück €/100/Obf.

13	x	75	S	10	680,00
13	x	85	S	10	660,00
13	x	100	S	10	720,00
13	x	140	S	10	1120,00
14	x	85	S	10	540,00
14	x	100	S	10	620,00
16	x	85	S	5	720,00
16	x	100	S	5	760,00
16	x	120	S	5	960,00
16	x	140	S	1	1210,00
16	x	160	S	5	1280,00
20	x	100	S	1	1260,00
20	x	120	S	1	1310,00
20	x	140	S	1	1410,00
20	x	160	S	1	1540,00
20	x	190	S	1	5900,00

ISO 08738.000

8738

Stahl 160 HV

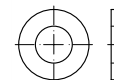

**Scheiben für Bolzen,
Produktklasse A**

ISO 8738 = EN 28738,
für Bolzen nach ISO 2340 und ISO 2341

Maße → **Ti-85** Normumstellung → **Ti-10**

Rostfrei → **S. 583**

ISO 8738 → ersetzt DIN 1440



Nenngröße

3	S	1000	13,40
4	S	1000	35,00
5	S	1000	19,30
6	S	1000	29,00
8	S	1000	55,00
10	S	1000	70,00
12	S	500	104,00
14	S	500	126,00
16	S	500	167,00
18	S	200	207,00
20	S	200	247,00
22	S	200	285,00
30	S	100	750,00
33	S	100	910,00
36	S	100	1160,00
40	S	50	1340,00
45	S	50	1620,00
50	S	50	2470,00
55	S	10	3500,00
60	S	10	4050,00
70	S	1	11100,00
80	S	1	20400,00
90	S	1	23300,00
100	S	1	26200,00

Abmessungen	VE Stück	€/100/Obf.
ISO 08738.011		
8738	Stahl 160 HV	
	galvanisch verzinkt	

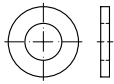

Scheiben für Bolzen, Produktklasse A

ISO 8738 = EN 28738, für Bolzen nach ISO 2340 und ISO 2341

Maße → **TI-85** Normumstellung → **TI-10**
 Korrosionsschutz → **TI-228**

Rostfrei → **S. 583**

ISO 8738 → ersetzt DIN 1440

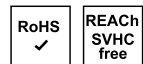

Nenngröße

3	S	1000	17,10
4	S	1000	18,60
5	S	1000	20,00
6	S	1000	32,00
8	S	1000	59,00
10	S	1000	81,00
12	S	500	126,00
14	S	500	153,00
16	S	500	199,00
18	S	200	244,00
20	S	200	285,00
22	S	200	325,00
30	S	100	850,00
33	S	100	990,00
36	S	100	1240,00
40	S	50	1460,00
45	S	50	1760,00
50	S	50	2650,00
55	S	10	3700,00
60	S	10	4200,00
70	S	1	11400,00
80	S	1	20600,00
100	S	1	26700,00

Abmessungen	VE Stück	€/100/Obf.
ISO 08740.000		
8740	Stahl	

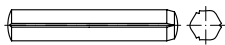

Zylinderkerbstifte mit Fase

Maße → **TI-119** REACH → **TI-262**
 Normumstellung → **TI-10**

Rostfrei → **S. 583**

ISO 8740 → ersetzt DIN 1473



1,5	x	6	S	250	8,90
1,5	x	8	S	250	8,90
1,5	x	10	S	250	8,90
1,5	x	12	S	250	9,10
1,5	x	16	S	250	9,10

1,5	x	20	S	250	15,20
2	x	4	S	250	9,60
2	x	6	S	250	9,60
2	x	8	S	250	9,60
2	x	10	S	250	9,60
2	x	12	S	250	9,90
2	x	14	S	250	9,90
2	x	16	S	250	9,90
2	x	18	S	250	9,90
2	x	20	S	250	11,10
2	x	24	S	250	11,90
2	x	30	S	250	11,90
2,5	x	6	S	250	11,10
2,5	x	8	S	250	11,10
2,5	x	10	S	250	11,10
2,5	x	12	S	250	11,20
2,5	x	14	S	250	11,20
2,5	x	16	S	250	11,20
2,5	x	20	S	250	11,40
2,5	x	24	S	250	11,40
2,5	x	30	S	250	11,80
3	x	6	S	250	11,20
3	x	8	S	250	11,20
3	x	10	S	250	11,20
3	x	12	S	250	11,50
3	x	14	S	250	11,50
3	x	16	S	250	11,50
3	x	18	S	250	11,50
3	x	20	S	250	12,30
3	x	22	S	250	12,30
3	x	24	S	250	12,30
3	x	26	S	250	12,60
3	x	28	S	250	14,40
3	x	30	S	100	14,40
3	x	32	S	100	14,80
3	x	36	S	100	15,20
3	x	40	S	100	15,30
4	x	6	S	100	14,20
4	x	8	S	100	14,20
4	x	10	S	100	14,20
4	x	12	S	100	14,30
4	x	14	S	100	14,30
4	x	16	S	100	14,30
4	x	18	S	100	14,30
4	x	20	S	100	14,40
4	x	22	S	100	14,40
4	x	24	S	100	14,80
4	x	26	S	100	15,20
4	x	28	S	100	15,20
4	x	30	S	100	15,20
4	x	32	S	100	15,30
4	x	36	S	100	16,10
4	x	40	S	100	16,50
4	x	45	S	100	18,30
4	x	50	S	100	19,00
4	x	60	S	100	36,00
5	x	8	S	100	16,10
5	x	10	S	100	16,10
5	x	12	S	100	16,10
5	x	14	S	100	16,10
5	x	16	S	100	16,10
5	x	18	S	100	17,10
5	x	20	S	100	17,10
5	x	22	S	100	17,20
5	x	24	S	100	17,60
5	x	26	S	100	18,30
5	x	28	S	100	18,30
5	x	30	S	100	18,70
5	x	32	S	100	19,20
5	x	36	S	100	19,80
5	x	40	S	100	20,70
5	x	45	S	100	22,10
5	x	50	S	100	23,00
5	x	55	S	100	42,50
5	x	60	S	100	44,50

6	x	10	S	100	21,20
6	x	12	S	100	21,20
6	x	14	S	100	21,20
6	x	16	S	100	21,50
6	x	18	S	100	21,60
6	x	20	S	100	21,60
6	x	22	S	100	22,00
6	x	24	S	100	22,10
6	x	26	S	100	22,70
6	x	28	S	100	22,70
6	x	30	S	100	23,00
6	x	32	S	100	23,60
6	x	36	S	100	26,00
6	x	40	S	100	26,50
6	x	45	S	100	29,00
6	x	50	S	100	30,00
6	x	55	S	100	31,50
6	x	60	S	100	34,00
6	x	65	S	100	89,00
6	x	70	S	100	92,00
6	x	80	S	100	96,00
8	x	12	S	100	31,50
8	x	14	S	100	31,50
8	x	16	S	100	32,50
8	x	20	S	100	32,50
8	x	22	S	100	33,50
8	x	24	S	100	33,50
8	x	26	S	100	33,50
8	x	28	S	100	33,50
8	x	30	S	100	34,50
8	x	32	S	100	36,00
8	x	36	S	100	38,50
8	x	40	S	100	39,50
8	x	45	S	100	44,00
8	x	50	S	100	47,00
8	x	55	S	100	47,00
8	x	60	S	100	53,00
8	x	70	S	100	60,00
8	x	80	S	100	92,00
8	x	90	S	25	146,00
10	x	16	S	25	213,00
10	x	20	S	25	216,00
10	x	24	S	25	222,00
10	x	26	S	25	224,00
10	x	30	S	25	229,00
10	x	32	S	25	230,00
10	x	36	S	25	235,00
10	x	40	S	25	239,00
10	x	45	S	25	245,00
10	x	50	S	25	250,00
10	x	60	S	25	265,00
10	x	65	S	25	265,00
10	x	70	S	25	275,00
10	x	80	S	25	285,00
10	x	90	S	25	300,00
10	x	100	S	25	300,00
12	x	20	S	25	239,00
12	x	24	S	25	245,00
12	x	26	S	25	249,00
12	x	28	S	25	255,00
12	x	30	S	25	255,00
12	x	32	S	25	260,00
12	x	36	S	25	265,00
12	x	40	S	25	270,00
12	x	45	S	25	275,00
12	x	50	S	25	285,00
12	x	55	S	25	295,00
12	x	60	S	25	300,00
12	x	70	S	25	315,00
12	x	80	S	25	335,00
12	x	90	S	25	345,00
12	x	100	S	25	365,00

Abmessungen VE Stück €/100/Obf.

ISO 08741.000

8741 Stahl

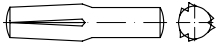

Steckerbstifte

Maße → **TI-118** REACH → **TI-262**
 Normumstellung → **TI-10**

ISO 8741 → ersetzt DIN 1474



1,5	x	5	S	250	8,90
1,5	x	6	S	250	8,90
2	x	6	S	250	9,60
2	x	8	S	250	9,60
2	x	10	S	250	9,60
2	x	12	S	250	9,90
2	x	16	S	250	9,90
2	x	20	S	250	11,10
2,5	x	10	S	250	11,10
2,5	x	12	S	250	11,20
2,5	x	16	S	250	11,20
3	x	8	S	2000	11,20
3	x	10	S	250	11,20
3	x	12	S	250	11,50
3	x	16	S	250	11,50
3	x	20	S	250	12,30
3	x	30	S	100	14,40
4	x	8	S	100	14,20
4	x	10	S	100	14,20
4	x	12	S	100	14,30
4	x	16	S	100	14,30
4	x	18	S	100	14,30
4	x	20	S	100	14,40
4	x	24	S	100	14,80
4	x	30	S	100	15,20
4	x	40	S	100	16,50
5	x	10	S	100	16,10
5	x	12	S	100	16,10
5	x	14	S	100	16,10
5	x	16	S	100	16,10
5	x	20	S	100	17,10
5	x	24	S	100	17,60
5	x	28	S	100	18,30
5	x	36	S	100	19,80
5	x	40	S	100	20,70
6	x	12	S	100	21,20
6	x	14	S	100	21,20
6	x	16	S	100	21,50
6	x	20	S	100	21,60
6	x	22	S	100	22,00
6	x	24	S	100	22,10
6	x	26	S	100	22,70
6	x	28	S	100	22,70
6	x	30	S	100	23,00
6	x	32	S	100	23,60
6	x	40	S	100	26,50
6	x	60	S	100	34,00
6	x	70	S	100	92,00
8	x	16	S	100	32,50
8	x	20	S	100	32,50
8	x	24	S	100	33,50
8	x	26	S	100	33,50
8	x	30	S	100	34,50
8	x	32	S	100	36,00
8	x	40	S	100	39,50

Abmessungen VE Stück €/100/Obf.

8	x	45	S	100	44,00
8	x	50	S	100	47,00
10	x	20	S	25	216,00
10	x	24	S	25	222,00
10	x	25	S	25	224,00
10	x	30	S	25	229,00
10	x	36	S	25	235,00
10	x	40	S	25	239,00
10	x	45	S	25	245,00
10	x	60	S	25	265,00
12	x	32	S	25	260,00
12	x	40	S	25	270,00
12	x	50	S	25	285,00
12	x	55	S	25	295,00

ISO 08742.000

8742 Stahl



Knebelkerbstifte mit kurzen Kerben

Maße → **TI-119** REACH → **TI-262**
 Normumstellung → **TI-10**

ISO 8742 → ersetzt DIN 1475



1,5	x	8	S	250	8,90
2	x	10	S	250	9,60
2	x	12	S	250	9,90
2	x	24	S	250	11,90
2,5	x	12	S	250	11,20
2,5	x	16	S	250	11,20
3	x	6	S	250	11,20
3	x	10	S	250	11,20
3	x	12	S	250	11,50
3	x	14	S	250	11,50
3	x	16	S	250	11,50
3	x	20	S	250	12,30
3	x	28	S	100	14,40
3	x	30	S	100	14,40
3	x	40	S	100	15,30
4	x	10	S	100	14,20
4	x	14	S	100	14,30
4	x	16	S	100	14,30
4	x	18	S	100	14,30
4	x	20	S	100	14,40
4	x	22	S	100	14,40
4	x	24	S	100	14,80
4	x	26	S	100	15,20
4	x	28	S	100	15,20
4	x	30	S	100	15,20
4	x	32	S	100	15,30
4	x	36	S	100	16,10
4	x	40	S	100	16,50
4	x	50	S	100	19,00
4	x	60	S	100	36,00
5	x	12	S	100	16,10
5	x	20	S	100	17,10
5	x	22	S	100	17,20
5	x	24	S	100	17,60
5	x	30	S	100	18,70
5	x	36	S	100	19,80
5	x	40	S	100	20,70
5	x	50	S	100	23,00
5	x	60	S	100	44,50
6	x	10	S	100	21,20

Abmessungen VE Stück €/100/Obf.

6	x	20	S	100	21,60
6	x	24	S	100	22,10
6	x	26	S	100	22,70
6	x	28	S	100	22,70
6	x	30	S	100	23,00
6	x	32	S	100	23,60
6	x	36	S	100	26,00
6	x	40	S	100	26,50
6	x	50	S	100	30,00
6	x	60	S	100	34,00
6	x	70	S	100	92,00
8	x	16	S	100	32,50
8	x	24	S	100	33,50
8	x	30	S	100	34,50
8	x	32	S	100	36,00
8	x	36	S	100	38,50
8	x	40	S	100	39,50
8	x	50	S	100	47,00
8	x	55	S	100	49,50
8	x	60	S	100	53,00
8	x	80	S	100	140,00
8	x	100	S	25	160,00
10	x	36	S	25	235,00
10	x	45	S	25	245,00
10	x	50	S	25	250,00
10	x	55	S	25	255,00
10	x	60	S	25	265,00
10	x	70	S	25	275,00
10	x	80	S	25	285,00
12	x	40	S	25	270,00
12	x	45	S	25	275,00
12	x	60	S	25	300,00
12	x	100	S	25	365,00

ISO 08744.000

8744 Stahl

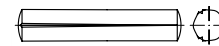

Kegelkerbstifte

Maße → **TI-119** REACH → **TI-262**
 Normumstellung → **TI-10**

Rostfrei → **S. 583**

ISO 8744 → ersetzt DIN 1471



1,5	x	6	S	250	8,90
1,5	x	8	S	250	8,90
1,5	x	16	S	250	9,60
2	x	6	S	250	9,60
2	x	8	S	250	9,60
2	x	10	S	250	9,60
2	x	12	S	250	9,90
2	x	16	S	250	9,90
2	x	20	S	250	11,10
2	x	24	S	250	11,90
2	x	30	S	250	11,90
2,5	x	6	S	250	11,10
2,5	x	12	S	250	11,20
2,5	x	16	S	250	11,20
2,5	x	20	S	250	11,40
2,5	x	30	S	250	11,80
3	x	6	S	250	11,20
3	x	8	S	250	11,20
3	x	10	S	250	11,20
3	x	12	S	250	11,50

Abmessungen	VE	Stück	€/100/Obf.
3 x 14	S	250	11,50
3 x 16	S	250	11,50
3 x 18	S	250	11,50
3 x 20	S	250	12,30
3 x 24	S	250	12,30
3 x 26	S	250	12,60
3 x 30	S	100	14,40
3 x 40	S	100	15,30
4 x 6	S	100	14,20
4 x 8	S	100	14,20
4 x 10	S	100	14,20
4 x 12	S	100	14,30
4 x 14	S	100	14,30
4 x 16	S	100	14,30
4 x 18	S	100	14,30
4 x 20	S	100	14,40
4 x 22	S	100	14,40
4 x 24	S	100	14,80
4 x 26	S	100	15,20
4 x 28	S	100	15,20
4 x 30	S	100	15,20
4 x 32	S	100	15,30
4 x 36	S	100	16,10
4 x 40	S	100	16,50
4 x 50	S	100	19,00
4 x 60	S	100	72,00
5 x 8	S	100	16,10
5 x 10	S	100	16,10
5 x 12	S	100	16,10
5 x 14	S	100	16,10
5 x 16	S	100	16,10
5 x 18	S	100	17,10
5 x 20	S	100	17,10
5 x 24	S	100	17,60
5 x 26	S	100	18,30
5 x 30	S	100	18,70
5 x 32	S	100	19,20
5 x 36	S	100	19,80
5 x 40	S	100	20,70
5 x 45	S	100	22,10
5 x 50	S	100	23,00
5 x 60	S	100	44,50
6 x 10	S	100	21,20
6 x 12	S	100	21,20
6 x 16	S	100	21,20
6 x 20	S	100	21,60
6 x 22	S	100	22,00
6 x 24	S	100	22,10
6 x 26	S	100	22,70
6 x 28	S	100	22,70
6 x 30	S	100	23,00
6 x 32	S	100	23,60
6 x 36	S	100	26,00
6 x 40	S	100	26,50
6 x 45	S	100	29,00
6 x 50	S	100	30,00
6 x 55	S	100	31,50
6 x 60	S	100	34,00
6 x 70	S	100	92,00
6 x 80	S	100	96,00
8 x 12	S	100	31,50
8 x 16	S	100	32,50
8 x 20	S	100	32,50
8 x 24	S	100	33,50
8 x 26	S	100	33,50
8 x 28	S	100	33,50
8 x 30	S	100	34,50
8 x 32	S	100	36,00
8 x 36	S	100	38,50
8 x 40	S	100	39,50
8 x 45	S	100	44,00
8 x 50	S	100	47,00
8 x 55	S	100	49,50
8 x 60	S	100	53,00
8 x 70	S	100	60,00

Abmessungen	VE	Stück	€/100/Obf.
8 x 80	S	100	125,00
10 x 20	S	25	216,00
10 x 30	S	25	229,00
10 x 32	S	25	230,00
10 x 36	S	25	235,00
10 x 40	S	25	239,00
10 x 45	S	25	245,00
10 x 50	S	25	250,00
10 x 60	S	25	265,00
10 x 70	S	25	275,00
10 x 80	S	25	285,00
10 x 90	S	25	300,00
10 x 100	S	25	300,00
12 x 26	S	25	249,00
12 x 60	S	25	300,00
12 x 70	S	25	315,00
12 x 90	S	25	345,00
12 x 100	S	25	365,00

ISO 08745.000

8745 Stahl

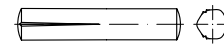

Passkerbstifte

Maße → **TI-118** REACH → **TI-262**
 Normumstellung → **TI-10**
 Rostfrei → **S. 584**
 ISO 8745 → ersetzt DIN 1472



1,5 x 6	S	250	8,90
1,5 x 8	S	250	8,90
1,5 x 10	S	250	8,90
1,5 x 12	S	250	9,10
1,5 x 16	S	250	9,10
2 x 6	S	250	9,60
2 x 8	S	250	9,60
2 x 10	S	250	9,60
2 x 12	S	250	9,90
2 x 14	S	250	9,90
2 x 16	S	250	9,90
2 x 20	S	250	11,10
2 x 30	S	250	11,90
2,5 x 6	S	250	11,10
2,5 x 8	S	250	11,10
2,5 x 10	S	250	11,10
2,5 x 12	S	250	11,20
2,5 x 16	S	250	11,20
2,5 x 18	S	250	11,20
2,5 x 20	S	250	11,40
3 x 6	S	250	11,20
3 x 8	S	250	11,20
3 x 10	S	250	11,20
3 x 12	S	250	11,50
3 x 14	S	250	11,50
3 x 16	S	250	11,50
3 x 18	S	250	11,50
3 x 20	S	250	12,30
3 x 22	S	250	12,30
3 x 24	S	250	12,30
3 x 26	S	250	12,60
3 x 28	S	100	14,40
3 x 30	S	100	14,40
3 x 32	S	100	14,80
3 x 40	S	100	15,30

Abmessungen	VE	Stück	€/100/Obf.
4 x 6	S	100	14,20
4 x 8	S	100	14,20
4 x 10	S	100	14,20
4 x 12	S	100	14,30
4 x 14	S	100	14,30
4 x 16	S	100	14,30
4 x 18	S	100	14,30
4 x 20	S	100	14,40
4 x 22	S	100	14,40
4 x 24	S	100	14,80
4 x 26	S	100	15,20
4 x 28	S	100	15,20
4 x 30	S	100	15,20
4 x 32	S	100	15,30
4 x 36	S	100	16,10
4 x 40	S	100	16,50
4 x 50	S	100	19,00
4 x 60	S	100	72,00
5 x 8	S	100	16,10
5 x 10	S	100	16,10
5 x 12	S	100	16,10
5 x 14	S	100	16,10
5 x 16	S	100	16,10
5 x 18	S	100	17,10
5 x 20	S	100	17,10
5 x 22	S	100	17,20
5 x 24	S	100	17,60
5 x 26	S	100	18,30
5 x 28	S	100	18,30
5 x 30	S	100	18,70
5 x 32	S	100	19,20
5 x 36	S	100	19,80
5 x 40	S	100	20,70
5 x 50	S	100	23,00
5 x 60	S	100	44,50
6 x 10	S	100	21,20
6 x 12	S	100	21,20
6 x 14	S	100	21,20
6 x 16	S	100	21,50
6 x 18	S	100	21,60
6 x 20	S	100	21,60
6 x 22	S	100	22,00
6 x 24	S	100	22,10
6 x 26	S	100	22,70
6 x 28	S	100	22,70
6 x 30	S	100	23,00
6 x 32	S	100	23,60
6 x 36	S	100	26,00
6 x 40	S	100	26,50
6 x 45	S	100	29,00
6 x 50	S	100	30,00
6 x 60	S	100	34,00
6 x 80	S	100	96,00
8 x 12	S	100	31,50
8 x 14	S	100	31,50
8 x 16	S	100	32,50
8 x 18	S	100	32,50
8 x 20	S	100	32,50
8 x 22	S	100	33,50
8 x 24	S	100	33,50
8 x 26	S	100	33,50
8 x 28	S	100	33,50
8 x 30	S	100	34,50
8 x 32	S	100	36,00
8 x 36	S	100	38,50
8 x 40	S	100	39,50
8 x 45	S	100	44,00
8 x 50	S	100	47,00
8 x 55	S	100	49,50
8 x 60	S	100	53,00
8 x 70	S	100	60,00
8 x 80	S	100	92,00
8 x 100	S	25	160,00
10 x 16	S	25	213,00
10 x 20	S	25	216,00

Abmessungen	VE	Stück	€/100/Obf.
10 x 24	S	25	222,00
10 x 26	S	25	224,00
10 x 30	S	25	229,00
10 x 32	S	25	230,00
10 x 36	S	25	235,00
10 x 40	S	25	239,00
10 x 45	S	25	245,00
10 x 50	S	25	250,00
10 x 55	S	25	255,00
10 x 60	S	25	265,00
10 x 70	S	25	275,00
10 x 80	S	25	285,00
10 x 90	S	25	300,00
12 x 20	S	25	239,00
12 x 30	S	25	255,00
12 x 32	S	25	260,00
12 x 36	S	25	265,00
12 x 40	S	25	270,00
12 x 45	S	25	275,00
12 x 50	S	25	285,00
12 x 55	S	25	295,00
12 x 60	S	25	300,00
12 x 70	S	25	315,00
12 x 80	S	25	335,00

ISO 08746.000

8746

Stahl Form A

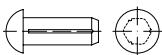

Halbrundkerbnägel, A = mit Fase

Maße → TI-120 REACH → TI-262
 Normumstellung → TI-10
 Rostfrei → S. 584
 Messing, Aluminium → S. 643

ISO 8746 → ersetzt DIN 1476 (austauschbar)



1,4 x 3	K	500	4,25
1,4 x 4	K	500	4,25
1,4 x 5	K	500	6,50
1,4 x 6	K	500	4,75
1,6 x 3	K	500	4,40
1,6 x 4	K	500	4,40
1,6 x 6	K	500	4,55
2 x 3	S	5000	3,40
2 x 3	K	500	4,40
2 x 4	S	5000	3,40
2 x 4	K	500	4,40
2 x 5	S	5000	3,40
2 x 5	K	500	4,40
2 x 6	S	5000	4,55
2 x 6	K	500	4,55
2 x 8	S	5000	3,45
2 x 8	K	500	4,55
2 x 10	K	500	4,70
2,3 x 4	K	500	4,55
2,3 x 5	K	500	4,55
2,3 x 6	K	500	4,55
2,3 x 8	K	500	4,70
2,3 x 10	K	500	4,85
2,5 x 3	K	500	4,70
2,5 x 4	K	500	4,70
2,5 x 5	K	500	4,70
2,5 x 6	S	5000	3,65

Abmessungen	VE	Stück	€/100/Obf.
2,5 x 6	K	500	4,70
2,5 x 7	K	500	4,85
2,5 x 8	K	500	4,85
2,5 x 10	K	500	5,00
3 x 4	S	5000	3,95
3 x 4	K	500	5,00
3 x 5	S	5000	3,95
3 x 5	K	500	5,00
3 x 6	S	5000	3,95
3 x 6	K	500	5,00
3 x 7	K	500	5,20
3 x 8	S	5000	4,20
3 x 8	K	500	5,20
3 x 10	S	5000	4,20
3 x 10	K	500	5,20
3 x 12	S	2000	4,60
3 x 12	K	500	5,50
3 x 15	S	2000	4,60
3 x 15	K	500	5,50
3 x 18	K	500	6,60
4 x 6	S	2000	5,70
4 x 6	K	500	6,60
4 x 8	S	2000	5,70
4 x 8	K	500	6,60
4 x 10	S	2000	5,80
4 x 10	K	500	6,70
4 x 12	K	500	7,20
4 x 15	S	2000	6,60
4 x 15	K	500	7,60
4 x 20	K	500	15,80
5 x 8	K	250	9,20
5 x 10	S	1000	8,30
5 x 10	K	250	9,60
5 x 12	S	1000	9,10
5 x 12	K	250	10,50
5 x 15	S	1000	9,70
5 x 15	K	250	10,80
5 x 18	K	250	11,10
5 x 20	K	250	11,70
5 x 25	K	250	12,30
6 x 8	K	250	11,80
6 x 10	K	250	12,10
6 x 12	K	250	13,20
6 x 15	K	250	14,40
6 x 20	K	250	15,70
6 x 25	K	250	17,00
6 x 30	K	250	19,40

ISO 08747.000

8747

Stahl Form A

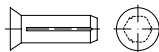

Senkkerbnägel, A = mit Fase

Maße → TI-120 REACH → TI-262
 Normumstellung → TI-10

ISO 8747 → ersetzt DIN 1477 (austauschbar)



2 x 6	K	500	5,00
2 x 8	K	500	5,00
2 x 10	K	500	5,30
3 x 6	K	500	5,60
3 x 8	K	500	5,70
3 x 10	K	500	5,70

Abmessungen	VE	Stück	€/100/Obf.
3 x 12	K	500	6,20
3 x 18	K	500	7,30
4 x 10	K	500	7,60
4 x 12	K	500	7,80
4 x 15	K	500	8,50
5 x 10	K	250	10,70
5 x 15	K	250	12,10
5 x 20	K	250	12,90
6 x 15	K	250	16,10
6 x 20	K	250	17,50

ISO 08748.000

8748

Federstahl

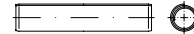

Spiralspannstifte, schwere Ausführung

Maße → TI-121 Normumstellung → TI-10

ISO 8748 → ersetzt DIN 7344 (austauschbar)

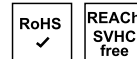

1,5 x 14	S	1000	8,30
2 x 8	S	1000	7,90
2 x 10	S	1000	8,20
2 x 12	S	1000	8,30
2 x 16	S	1000	8,50
2 x 18	S	1000	8,60
2,5 x 12	S	1000	8,50
2,5 x 14	S	1000	8,80
2,5 x 16	S	1000	8,80
2,5 x 20	S	1000	8,90
2,5 x 24	S	1000	9,10
3 x 8	S	1000	9,60
3 x 10	S	1000	9,90
3 x 12	S	1000	9,90
3 x 14	S	1000	10,10
3 x 16	S	1000	10,50
3 x 18	S	1000	10,70
3 x 20	S	1000	10,80
3 x 24	S	1000	11,30
3 x 30	S	1000	12,10
3 x 32	S	1000	11,70
4 x 12	S	1000	11,30
4 x 16	S	1000	11,80
4 x 18	S	500	12,30
4 x 20	S	500	12,90
4 x 24	S	500	13,80
4 x 26	S	500	15,50
4 x 30	S	500	16,00
5 x 12	S	1000	8,80
5 x 14	S	500	10,80
5 x 18	S	500	14,00
5 x 20	S	500	16,00
5 x 22	S	500	17,40
5 x 24	S	500	18,20
5 x 26	S	500	20,40
5 x 28	S	500	20,70
5 x 30	S	500	21,20
5 x 35	S	500	24,60
6 x 16	S	500	22,70
6 x 20	S	500	23,60
6 x 24	S	500	27,50
6 x 30	S	500	32,50
6 x 40	S	250	41,50
6 x 50	S	250	51,00

Abmessungen	VE	Stück	€/100/Obf.
8 x 20	S	500	103,00
8 x 40	S	500	144,00
8 x 50	S	250	146,00

ISO 08750.000

8750 Federstahl

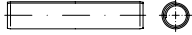

Spiralspannstifte, Regelausführung

Maße → **TI-121** Normumstellung → **TI-10**
 Rostfrei → **S. 584**
 ISO 8750 → ersetzt DIN 7343 (austauschbar)



1,5 x 5	S	1000	6,50
1,5 x 6	S	1000	6,50
1,5 x 8	S	1000	6,90
1,5 x 10	S	1000	7,20
1,5 x 12	S	1000	7,20
2 x 6	S	1000	7,30
2 x 8	S	1000	7,40
2 x 10	S	1000	7,60
2 x 12	S	1000	7,70
2 x 14	S	1000	7,70
2 x 16	S	1000	7,70
2 x 18	S	1000	7,80
2 x 20	S	1000	8,60
2,5 x 10	S	1000	8,20
2,5 x 12	S	1000	8,40
2,5 x 16	S	1000	8,50
2,5 x 20	S	1000	9,10
3 x 8	S	1000	8,20
3 x 10	S	1000	8,50
3 x 12	S	1000	8,80
3 x 14	S	1000	8,90
3 x 16	S	1000	9,10
3 x 18	S	1000	9,40
3 x 20	S	1000	9,60
3 x 24	S	1000	10,10
3 x 26	S	1000	10,50
3 x 30	S	1000	10,50
3,5 x 20	S	1000	10,50
3,5 x 24	S	1000	11,30
4 x 10	S	500	10,50
4 x 12	S	500	10,50
4 x 14	S	500	10,70
4 x 16	S	500	11,10
4 x 18	S	500	11,30
4 x 20	S	500	11,50
4 x 24	S	500	12,10
4 x 26	S	500	12,50
4 x 30	S	500	13,60
4 x 32	S	500	14,80
4 x 36	S	500	16,00
4 x 40	S	500	17,10
4 x 50	S	500	20,40
5 x 20	S	500	15,50
5 x 22	S	500	16,30
5 x 24	S	500	16,60
5 x 26	S	500	17,50
5 x 30	S	500	18,70
5 x 32	S	500	19,40
5 x 40	S	500	22,00

Abmessungen	VE	Stück	€/100/Obf.
6 x 14	S	500	19,40
6 x 18	S	500	20,00
6 x 20	S	500	20,60
6 x 24	S	500	23,50
6 x 26	S	500	22,70
6 x 30	S	500	28,00
6 x 35	S	500	31,50
6 x 40	S	250	33,50
6 x 45	S	250	37,00
6 x 50	S	250	41,00
8 x 20	S	500	39,00
8 x 24	S	500	41,00
8 x 30	S	250	51,00
8 x 35	S	250	57,00
8 x 40	S	500	60,00
8 x 45	S	500	67,00
8 x 50	S	250	72,00
10 x 40	S	250	92,00
10 x 50	S	250	113,00
10 x 70	S	100	164,00
12 x 40	S	50	211,00
12 x 50	S	100	226,00
12 x 60	S	50	240,00
12 x 80	S	50	285,00
14 x 50	S	25	270,00
14 x 70	S	25	310,00
16 x 60	S	25	305,00
16 x 90	S	25	690,00

ISO 08752.000

8752 Federstahl

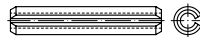

Spannstifte (-hülsen), geschlitzt, schwere Ausführung

Maße → **TI-121** Normumstellung → **TI-10**
 Rostfrei → **S. 585**
 ISO 8752 → ersetzt DIN 1481

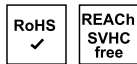

1 x 4	K	200	10,10
1 x 5	K	200	10,50
1 x 6	K	200	10,50
1 x 8	K	200	10,60
1 x 10	K	200	10,70
1 x 12	K	200	10,70
1 x 14	K	200	11,10
1 x 16	K	200	11,40
1 x 20	K	200	8,50
1,5 x 4	K	200	8,60
1,5 x 5	S	1000	7,80
1,5 x 5	K	200	8,60
1,5 x 6	S	1000	7,90
1,5 x 6	K	200	8,80
1,5 x 8	S	1000	8,30
1,5 x 8	K	200	9,10
1,5 x 10	S	1000	8,40
1,5 x 10	K	200	9,10
1,5 x 12	S	1000	8,40
1,5 x 12	K	200	9,20
1,5 x 14	S	1000	8,50
1,5 x 14	K	200	9,40
1,5 x 16	K	200	9,60
1,5 x 18	K	200	10,50

Abmessungen	VE	Stück	€/100/Obf.
1,5 x 20	K	200	10,70
2 x 4	S	1000	7,80
2 x 4	K	200	8,60
2 x 5	S	1000	8,40
2 x 5	K	200	9,20
2 x 6	S	1000	8,50
2 x 6	K	200	9,40
2 x 8	S	1000	8,80
2 x 8	K	200	9,50
2 x 10	S	1000	8,80
2 x 10	K	200	9,60
2 x 12	S	1000	8,80
2 x 12	K	200	9,60
2 x 14	S	1000	8,90
2 x 14	K	200	9,70
2 x 16	S	1000	8,90
2 x 16	K	200	9,90
2 x 18	S	1000	8,90
2 x 18	K	200	9,90
2 x 20	S	1000	9,90
2 x 20	K	200	10,60
2 x 22	K	200	10,80
2 x 24	S	1000	10,30
2 x 24	K	200	11,20
2 x 26	S	1000	10,80
2 x 26	K	200	11,70
2 x 28	K	200	12,40
2 x 30	S	1000	11,90
2 x 30	K	200	12,90
2,5 x 4	S	1000	8,80
2,5 x 4	K	200	9,60
2,5 x 5	S	1000	8,90
2,5 x 5	K	200	9,70
2,5 x 6	S	1000	9,00
2,5 x 6	K	200	9,90
2,5 x 8	S	1000	9,20
2,5 x 8	K	200	10,10
2,5 x 10	S	1000	9,50
2,5 x 10	K	200	10,30
2,5 x 12	S	1000	9,50
2,5 x 12	K	200	10,30
2,5 x 14	S	1000	9,60
2,5 x 14	K	200	10,50
2,5 x 16	S	1000	9,90
2,5 x 16	K	200	10,70
2,5 x 18	S	1000	10,00
2,5 x 18	K	200	10,70
2,5 x 20	S	1000	10,10
2,5 x 20	K	200	10,80
2,5 x 22	K	200	11,10
2,5 x 24	K	200	11,70
2,5 x 26	K	200	12,30
2,5 x 28	K	200	12,90
2,5 x 30	S	1000	13,00
2,5 x 30	K	200	13,70
3 x 4	K	200	7,80
3 x 5	S	1000	6,20
3 x 5	K	200	7,80
3 x 6	S	1000	6,50
3 x 6	K	200	8,20
3 x 8	S	1000	6,50
3 x 8	K	200	8,20
3 x 10	S	1000	6,60
3 x 10	K	200	8,30
3 x 12	S	1000	6,60
3 x 12	K	200	8,30
3 x 14	S	1000	6,70
3 x 14	K	200	8,40
3 x 16	S	1000	6,90
3 x 16	K	200	8,60
3 x 18	S	1000	7,20
3 x 18	K	200	8,80
3 x 20	S	1000	7,40
3 x 20	K	200	9,10
3 x 22	S	1000	5,90

Abmessungen	VE	Stück	€/100/Obf.	Abmessungen	VE	Stück	€/100/Obf.	Abmessungen	VE	Stück	€/100/Obf.
3 x 22	K	200	7,60	4 x 50	S	500	15,40	6 x 18	S	500	13,20
3 x 24	S	1000	7,70	4 x 50	K	100	17,70	6 x 18	K	100	15,70
3 x 24	K	200	9,40	4 x 55	S	500	22,30	6 x 20	S	500	14,30
3 x 25	S	1000	9,40	4 x 55	K	100	24,70	6 x 20	K	100	16,70
3 x 26	S	1000	7,80	4 x 60	S	500	22,20	6 x 22	S	500	15,30
3 x 26	K	200	9,50	4 x 60	K	100	24,50	6 x 22	K	100	17,60
3 x 28	S	1000	8,40	4,5 x 10	K	100	11,80	6 x 24	S	500	16,10
3 x 28	K	200	10,10	4,5 x 12	K	100	12,40	6 x 24	K	100	18,60
3 x 30	S	1000	8,80	4,5 x 20	S	500	12,10	6 x 26	S	500	17,40
3 x 30	K	200	10,50	4,5 x 20	K	100	14,40	6 x 26	K	100	19,70
3 x 32	S	1000	9,10	4,5 x 22	K	100	14,70	6 x 28	S	500	18,40
3 x 32	K	100	12,50	4,5 x 24	K	100	15,30	6 x 28	K	100	20,70
3 x 36	S	1000	10,30	4,5 x 26	K	100	15,80	6 x 30	S	500	19,40
3 x 36	K	100	13,70	4,5 x 28	K	100	16,40	6 x 30	K	100	21,70
3 x 40	S	1000	11,10	4,5 x 30	S	500	14,40	6 x 32	S	500	20,50
3 x 40	K	100	14,30	4,5 x 30	K	100	16,70	6 x 32	K	100	22,90
3 x 50	S	1000	14,20	4,5 x 32	K	100	17,20	6 x 36	S	500	21,60
3 x 50	K	100	17,50	4,5 x 36	K	100	18,30	6 x 36	K	100	24,10
3,5 x 4	K	200	9,10	4,5 x 40	S	500	17,00	6 x 40	S	250	22,90
3,5 x 5	K	200	9,10	4,5 x 40	K	100	19,30	6 x 40	K	100	25,50
3,5 x 6	K	200	9,20	4,5 x 45	K	100	20,70	6 x 45	S	250	26,00
3,5 x 8	K	200	9,50	4,5 x 50	K	100	22,00	6 x 45	K	100	28,50
3,5 x 10	K	200	9,50	5 x 5	K	100	11,70	6 x 50	S	250	27,50
3,5 x 12	K	200	9,70	5 x 6	S	500	9,50	6 x 50	K	100	30,50
3,5 x 14	K	200	10,10	5 x 6	K	100	11,80	6 x 55	S	250	30,00
3,5 x 16	S	1000	8,60	5 x 8	S	500	9,50	6 x 55	K	100	33,00
3,5 x 16	K	200	10,10	5 x 8	K	100	11,80	6 x 60	S	250	33,00
3,5 x 18	K	200	10,30	5 x 10	S	500	9,50	6 x 60	K	100	36,00
3,5 x 20	S	1000	9,10	5 x 10	K	100	11,80	6 x 65	K	100	38,50
3,5 x 20	K	200	10,60	5 x 12	S	500	10,10	6 x 70	S	250	39,00
3,5 x 22	K	200	10,60	5 x 12	K	100	12,40	6 x 70	K	100	42,00
3,5 x 24	K	200	10,70	5 x 14	S	500	10,50	6 x 75	K	100	44,50
3,5 x 26	K	200	11,40	5 x 14	K	100	12,80	6 x 80	S	250	45,50
3,5 x 28	K	200	12,10	5 x 16	S	500	11,10	6 x 80	K	100	48,00
3,5 x 30	K	200	12,60	5 x 16	K	100	13,40	6 x 85	K	100	54,00
3,5 x 32	K	100	14,40	5 x 18	S	500	11,70	6 x 90	K	50	63,00
3,5 x 36	K	100	14,80	5 x 18	K	100	14,10	6 x 100	K	50	73,00
3,5 x 40	K	100	16,10	5 x 20	S	500	11,90	7 x 10	K	100	21,00
4 x 4	S	500	7,60	5 x 20	K	100	14,30	7 x 14	K	100	21,20
4 x 4	K	200	8,90	5 x 22	S	500	12,90	7 x 16	K	100	21,50
4 x 5	K	200	9,10	5 x 22	K	100	15,30	7 x 20	K	100	23,90
4 x 6	S	500	7,80	5 x 24	S	500	12,90	7 x 24	K	100	27,00
4 x 6	K	200	9,20	5 x 24	K	100	15,30	7 x 30	K	100	33,00
4 x 8	S	500	7,90	5 x 26	S	500	13,50	7 x 32	K	100	34,50
4 x 8	K	200	8,80	5 x 26	K	100	15,80	7 x 36	K	100	37,00
4 x 10	S	500	8,20	5 x 28	S	500	14,10	7 x 40	K	100	39,50
4 x 10	K	200	9,40	5 x 28	K	100	16,40	7 x 45	K	100	42,50
4 x 12	S	500	8,30	5 x 30	S	500	14,40	7 x 50	K	100	46,00
4 x 12	K	200	9,60	5 x 30	K	100	16,70	7 x 55	K	100	52,00
4 x 14	S	500	8,50	5 x 32	S	500	14,80	7 x 60	K	50	60,00
4 x 14	K	200	9,90	5 x 32	K	100	18,40	7 x 65	K	50	66,00
4 x 16	S	500	8,60	5 x 36	S	500	16,00	7 x 70	K	50	69,00
4 x 16	K	200	10,10	5 x 36	K	100	18,30	7 x 75	K	50	79,00
4 x 18	S	500	8,80	5 x 40	S	500	17,00	7 x 80	K	50	88,00
4 x 18	K	200	10,10	5 x 40	K	100	19,30	7 x 90	K	50	96,00
4 x 20	S	500	8,90	5 x 45	S	500	18,40	7 x 100	K	50	111,00
4 x 20	K	200	10,20	5 x 45	K	100	20,70	8 x 10	K	100	21,00
4 x 22	S	500	9,20	5 x 50	S	250	19,40	8 x 12	S	500	18,10
4 x 22	K	200	10,60	5 x 50	K	100	22,00	8 x 12	K	100	21,10
4 x 24	S	500	9,40	5 x 55	K	100	24,50	8 x 14	S	500	18,20
4 x 24	K	200	10,70	5 x 60	S	250	23,90	8 x 14	K	100	21,20
4 x 26	S	500	9,50	5 x 60	K	100	26,50	8 x 16	S	500	18,40
4 x 26	K	200	10,80	5 x 65	K	100	28,50	8 x 16	K	100	21,50
4 x 28	S	500	10,20	5 x 70	S	250	29,00	8 x 18	S	500	19,40
4 x 28	K	200	11,50	5 x 70	K	100	31,50	8 x 18	K	100	22,40
4 x 30	S	500	10,80	5 x 75	K	100	34,50	8 x 20	S	500	21,50
4 x 30	K	200	11,90	5 x 80	K	100	38,50	8 x 20	K	100	23,90
4 x 32	S	500	11,30	6 x 10	S	500	11,20	8 x 22	S	500	22,30
4 x 32	K	200	12,50	6 x 10	K	100	13,50	8 x 22	K	100	25,50
4 x 36	S	500	11,80	6 x 12	S	500	11,40	8 x 24	S	500	24,50
4 x 36	K	200	13,10	6 x 12	K	100	13,70	8 x 24	K	100	27,00
4 x 40	S	500	12,90	6 x 14	S	500	11,70	8 x 26	S	250	26,50
4 x 40	K	200	14,30	6 x 14	K	100	14,10	8 x 26	K	100	29,50
4 x 45	S	500	15,00	6 x 16	S	500	12,50	8 x 28	S	250	28,50
4 x 45	K	100	16,40	6 x 16	K	100	14,80	8 x 28	K	100	31,00

Abmessungen	VE	Stück	€/100/Obf.	Abmessungen	VE	Stück	€/100/Obf.	Abmessungen	VE	Stück	€/100/Obf.
8 x 30	S	250	30,50	10 x 75	K	50	112,00	14 x 20	S	25	183,00
8 x 30	K	100	33,00	10 x 80	S	100	113,00	14 x 24	S	25	190,00
8 x 32	S	250	32,50	10 x 80	K	50	118,00	14 x 28	S	25	201,00
8 x 32	K	100	34,50	10 x 85	S	100	119,00	14 x 30	S	25	205,00
8 x 36	S	250	34,50	10 x 85	K	50	124,00	14 x 32	S	25	207,00
8 x 36	K	100	37,00	10 x 90	S	100	128,00	14 x 36	S	25	212,00
8 x 40	S	250	37,00	10 x 90	K	50	134,00	14 x 40	S	25	215,00
8 x 40	K	100	39,50	10 x 95	K	50	141,00	14 x 45	S	25	220,00
8 x 45	S	250	41,00	10 x 100	S	100	144,00	14 x 50	S	25	226,00
8 x 45	K	100	42,50	10 x 100	K	50	151,00	14 x 55	S	25	230,00
8 x 50	S	250	44,00	10 x 110	K	50	590,00	14 x 60	S	25	236,00
8 x 50	K	100	46,00	10 x 120	S	50	590,00	14 x 65	S	25	255,00
8 x 55	S	250	47,50	10 x 120	K	25	590,00	14 x 70	S	25	260,00
8 x 55	K	100	49,50	10 x 140	S	50	750,00	14 x 75	S	25	265,00
8 x 60	S	250	56,00	10 x 140	K	25	760,00	14 x 80	S	25	285,00
8 x 60	K	50	60,00	10 x 160	S	50	810,00	14 x 85	S	25	460,00
8 x 65	S	250	61,00	10 x 160	K	25	820,00	14 x 90	S	25	540,00
8 x 65	K	50	66,00	12 x 10	S	25	310,00	14 x 100	S	10	720,00
8 x 70	S	250	66,00	12 x 12	S	25	300,00	14 x 120	S	10	940,00
8 x 70	K	50	69,00	12 x 14	S	25	290,00	14 x 140	S	10	1110,00
8 x 75	K	50	79,00	12 x 16	S	25	280,00	14 x 160	S	10	1250,00
8 x 80	S	250	84,00	12 x 18	S	25	270,00	14 x 200	S	10	1470,00
8 x 80	K	50	88,00	12 x 20	S	25	144,00	16 x 10	S	25	360,00
8 x 85	K	50	94,00	12 x 22	S	25	148,00	16 x 16	S	25	315,00
8 x 90	S	100	92,00	12 x 24	S	25	153,00	16 x 18	S	25	310,00
8 x 90	K	50	96,00	12 x 26	S	25	155,00	16 x 20	S	25	210,00
8 x 95	K	50	102,00	12 x 28	S	25	160,00	16 x 22	S	25	213,00
8 x 100	S	100	107,00	12 x 30	S	25	153,00	16 x 24	S	25	217,00
8 x 100	K	50	111,00	12 x 32	S	25	180,00	16 x 26	S	25	222,00
8 x 110	K	50	335,00	12 x 36	S	25	170,00	16 x 28	S	25	224,00
8 x 120	S	100	340,00	12 x 40	S	25	176,00	16 x 30	S	25	232,00
8 x 120	K	25	340,00	12 x 45	S	25	181,00	16 x 32	S	25	235,00
9 x 40	K	100	59,00	12 x 50	S	25	184,00	16 x 36	S	25	240,00
9 x 50	K	100	74,00	12 x 55	S	25	193,00	16 x 40	S	25	244,00
9 x 60	K	50	88,00	12 x 60	S	25	200,00	16 x 45	S	25	246,00
9 x 70	K	50	106,00	12 x 65	S	25	212,00	16 x 50	S	25	255,00
9 x 80	K	50	118,00	12 x 70	S	25	220,00	16 x 55	S	25	255,00
9 x 90	K	50	134,00	12 x 75	S	25	229,00	16 x 60	S	25	265,00
10 x 10	K	100	77,00	12 x 80	S	25	234,00	16 x 65	S	25	275,00
10 x 12	K	100	77,00	12 x 85	S	25	330,00	16 x 70	S	25	305,00
10 x 14	S	500	27,00	12 x 90	S	25	415,00	16 x 75	S	25	330,00
10 x 14	K	100	29,50	12 x 95	S	25	485,00	16 x 80	S	25	345,00
10 x 16	S	500	27,00	12 x 100	S	25	570,00	16 x 85	S	25	510,00
10 x 16	K	100	29,50	12 x 120	S	10	720,00	16 x 90	S	25	600,00
10 x 18	K	100	34,50	12 x 130	S	10	840,00	16 x 100	S	10	760,00
10 x 20	S	500	31,50	12 x 140	S	10	840,00	16 x 110	S	10	1020,00
10 x 20	K	100	34,50	12 x 160	S	10	960,00	16 x 120	S	10	1020,00
10 x 22	K	100	37,00	12 x 180	S	10	1070,00	16 x 130	S	10	1180,00
10 x 24	S	500	37,00	13 x 20	S	25	153,00	16 x 140	S	10	1180,00
10 x 24	K	100	39,50	13 x 24	S	25	160,00	16 x 150	S	10	1360,00
10 x 26	S	500	39,00	13 x 26	S	25	165,00	16 x 160	S	10	1360,00
10 x 26	K	100	42,00	13 x 28	S	25	166,00	16 x 180	S	10	1530,00
10 x 28	S	500	41,50	13 x 30	S	25	174,00	16 x 200	S	10	1700,00
10 x 28	K	100	44,50	13 x 32	S	25	176,00	18 x 24	S	25	229,00
10 x 30	S	500	44,50	13 x 36	S	25	181,00	18 x 30	S	25	240,00
10 x 30	K	100	47,00	13 x 40	S	25	184,00	18 x 36	S	25	246,00
10 x 32	S	500	49,50	13 x 45	S	25	187,00	18 x 40	S	25	250,00
10 x 32	K	100	52,00	13 x 50	S	25	193,00	18 x 45	S	25	255,00
10 x 36	S	250	53,00	13 x 55	S	25	200,00	18 x 50	S	25	260,00
10 x 36	K	100	56,00	13 x 60	S	25	207,00	18 x 55	S	25	275,00
10 x 40	S	250	57,00	13 x 65	S	25	220,00	18 x 60	S	25	300,00
10 x 40	K	100	59,00	13 x 70	S	25	229,00	18 x 65	S	25	335,00
10 x 45	S	250	63,00	13 x 75	S	25	236,00	18 x 70	S	25	360,00
10 x 45	K	100	66,00	13 x 80	S	25	275,00	18 x 75	S	25	390,00
10 x 50	S	250	69,00	13 x 85	S	25	360,00	18 x 80	S	25	415,00
10 x 50	K	100	73,00	13 x 90	S	25	455,00	18 x 90	S	10	650,00
10 x 55	S	250	76,00	13 x 95	S	25	540,00	18 x 100	S	10	820,00
10 x 55	K	100	77,00	13 x 100	S	10	620,00	18 x 120	S	10	1150,00
10 x 60	S	200	84,00	13 x 120	S	10	850,00	18 x 140	S	10	1360,00
10 x 60	K	50	88,00	13 x 130	S	10	990,00	18 x 160	S	10	1540,00
10 x 65	S	200	94,00	13 x 140	S	10	990,00	20 x 20	S	25	246,00
10 x 65	K	50	97,00	13 x 160	S	10	1140,00	20 x 30	S	25	295,00
10 x 70	S	100	101,00	13 x 180	S	10	1320,00	20 x 32	S	25	300,00
10 x 70	K	50	106,00	14 x 12	S	25	315,00	20 x 36	S	25	310,00
10 x 75	S	100	107,00	14 x 18	S	25	295,00	20 x 40	S	25	330,00

Abmessungen	VE	Stück	€/100/Obf.
20 x 45	S	25	360,00
20 x 50	S	25	380,00
20 x 55	S	25	410,00
20 x 60	S	25	425,00
20 x 65	S	25	455,00
20 x 70	S	25	480,00
20 x 75	S	25	510,00
20 x 80	S	25	540,00
20 x 85	S	10	660,00
20 x 90	S	10	740,00
20 x 100	S	10	910,00
20 x 120	S	10	1320,00
20 x 130	S	10	1540,00
20 x 140	S	10	1540,00
20 x 160	S	10	1760,00
20 x 180	S	10	2290,00
20 x 200	S	10	2850,00
21 x 16	S	25	680,00
21 x 20	S	25	370,00
21 x 24	S	25	410,00
21 x 26	S	25	420,00
21 x 30	S	25	455,00
21 x 32	S	25	460,00
21 x 36	S	25	485,00
21 x 40	S	25	520,00
21 x 45	S	25	530,00
21 x 50	S	25	560,00
21 x 55	S	25	590,00
21 x 60	S	25	610,00
21 x 65	S	10	650,00
21 x 70	S	10	670,00
21 x 75	S	10	690,00
21 x 80	S	10	730,00
21 x 85	S	10	790,00
21 x 90	S	10	880,00
21 x 95	S	10	960,00
21 x 100	S	10	970,00
21 x 120	S	10	1360,00
21 x 130	S	10	2400,00
21 x 140	S	10	1540,00
21 x 200	S	10	3200,00
25 x 32	S	10	1180,00
25 x 36	S	10	1200,00
25 x 40	S	10	1210,00
25 x 50	S	10	1280,00
25 x 55	S	10	1300,00
25 x 60	S	10	1320,00
25 x 65	S	10	1360,00
25 x 70	S	10	1410,00
25 x 80	S	10	1480,00
25 x 85	S	10	1670,00
25 x 90	S	10	1890,00
25 x 100	S	10	2270,00
25 x 120	S	1	2550,00
25 x 140	S	1	2800,00
25 x 160	S	1	3050,00
25 x 200	S	1	4150,00
28 x 20	S	10	2200,00
28 x 22	S	10	1400,00
28 x 26	S	10	1260,00
28 x 28	S	10	1380,00
28 x 30	S	10	1340,00
28 x 32	S	10	1360,00
28 x 36	S	10	1410,00
28 x 40	S	10	1430,00
28 x 45	S	10	1480,00
28 x 50	S	10	1530,00
28 x 55	S	10	1570,00
28 x 60	S	10	1630,00
28 x 65	S	10	1750,00
28 x 70	S	10	1870,00
28 x 75	S	10	1990,00
28 x 80	S	10	2110,00
28 x 90	S	10	2650,00
28 x 100	S	1	3250,00

Abmessungen	VE	Stück	€/100/Obf.
28 x 120	S	1	3600,00
28 x 140	S	1	3950,00
28 x 160	S	1	4300,00
28 x 200	S	1	5700,00
30 x 30	S	10	1510,00
30 x 32	S	10	1520,00
30 x 36	S	10	1580,00
30 x 40	S	10	1640,00
30 x 45	S	10	1720,00
30 x 50	S	10	1770,00
30 x 60	S	10	2040,00
30 x 65	S	10	2060,00
30 x 70	S	10	2220,00
30 x 80	S	10	2550,00
30 x 90	S	1	3100,00
30 x 100	S	1	3700,00
30 x 120	S	1	4300,00
30 x 140	S	1	4950,00
30 x 160	S	1	5600,00
30 x 180	S	1	6300,00
30 x 200	S	1	6900,00
35 x 50	S	1	2070,00
35 x 60	S	1	2270,00
35 x 80	S	1	3900,00
35 x 90	S	1	4400,00
35 x 100	S	1	4850,00
40 x 50	S	1	2400,00
40 x 55	S	1	2650,00
40 x 60	S	1	2650,00
40 x 70	S	1	2950,00
40 x 80	S	1	3250,00
40 x 90	S	1	3600,00
40 x 100	S	1	3950,00

ISO	08752.010
8752	Federstahl galvanisch verzinkt

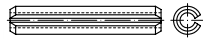

Spannstifte (-hülsen), geschlitzt, schwere Ausführung

Maße → **TI-121** Normumstellung → **TI-10**
 Korrosionsschutz → **TI-228**
 Rostfrei → **S. 585**

ISO 8752 → ersetzt DIN 1481

RoHS	REACH SVHC free
✓	

3 x 10	S	200	33,50 gal Zn
3 x 12	S	200	33,50 gal Zn
3 x 14	S	200	34,00 gal Zn
3 x 16	S	200	34,50 gal Zn
3 x 20	S	1000	35,00 gal Zn
4 x 10	S	200	38,00 gal Zn
4 x 12	S	200	39,00 gal Zn
4 x 16	S	200	41,00 gal Zn
4 x 20	S	200	41,50 gal Zn
4 x 24	S	200	43,00 gal Zn
4 x 28	S	500	9,60 gal Zn
5 x 16	S	100	54,00 gal Zn
5 x 20	S	500	12,10 gal Zn
5 x 22	S	100	62,00 gal Zn
5 x 24	S	100	62,00 gal Zn
5 x 26	S	100	63,00 gal Zn
5 x 30	S	500	13,70 gal Zn
5 x 36	S	500	15,20 gal Zn

Abmessungen	VE	Stück	€/100/Obf.
6 x 10	S	100	54,00 gal Zn
6 x 12	S	100	56,00 gal Zn
6 x 14	S	500	14,60 gal Zn
6 x 16	S	500	14,30 gal Zn
6 x 20	S	100	68,00 gal Zn
6 x 22	S	100	71,00 gal Zn
6 x 24	S	100	76,00 gal Zn
6 x 26	S	100	79,00 gal Zn
6 x 30	S	100	88,00 gal Zn
6 x 32	S	100	92,00 gal Zn
6 x 36	S	100	22,30 gal Zn
6 x 40	S	100	102,00 gal Zn
8 x 10	S	100	85,00 gal Zn
8 x 12	S	100	85,00 gal Zn
8 x 16	S	100	86,00 gal Zn
8 x 20	S	100	96,00 gal Zn
8 x 24	S	100	19,80 gal Zn
8 x 30	S	100	23,80 gal Zn

ISO	08765.800
-----	-----------

8765 8.8

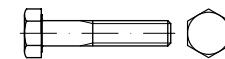

Sechskantschrauben mit Schaft, mit metrischem Feingewinde

kurze Abmessungen z. T. Gewinde bis Kopf,
 *M 10/12/14/22 = RAZ 3600 übrige Ø = RAZ 440

Maße → **TI-15** Anziehmomente → **TI-244**
 Werkstoffeigensch. → **TI-232** Normumstellung → **TI-6**

ISO 8765 → ersetzt DIN 960

RoHS	REACH SVHC free
✓	

M 8 x 1 x 30	S	200	25,50
M 8 x 1 x 35	S	200	28,50
M 8 x 1 x 40	S	200	32,00
M 8 x 1 x 45	S	200	35,50
M 8 x 1 x 50	S	200	42,00
M 8 x 1 x 60	S	200	48,50
M 8 x 1 x 70	S	200	56,00
M 8 x 1 x 80	S	200	62,00
M 10 x 1 x 35	S	100	45,50
M 10 x 1,25 x 35	S	100	48,50
M 10 x 1 x 40	S	100	50,00
M 10 x 1,25 x 40	S	100	53,00
M 10 x 1 x 45	S	100	54,00
M 10 x 1,25 x 45	S	100	55,00
M 10 x 1 x 50	S	100	59,00
M 10 x 1,25 x 50	S	100	59,00
M 10 x 1,25 x 55	S	100	63,00
M 10 x 1 x 60	S	100	63,00
M 10 x 1,25 x 60	S	100	64,00
M 10 x 1 x 65	S	100	70,00
M 10 x 1 x 70	S	100	70,00
M 10 x 1,25 x 70	S	100	70,00
M 10 x 1 x 80	S	100	79,00
M 10 x 1,25 x 80	S	100	78,00
M 10 x 1 x 90	S	100	88,00
M 10 x 1,25 x 90	S	100	90,00
M 10 x 1 x 100	S	100	97,00
M 10 x 1,25 x 100	S	100	104,00
M 10 x 1,25 x 110	S	50	143,00
M 10 x 1,25 x 120	S	50	158,00
M 10 x 1,25 x 130	S	50	200,00
M 12 x 1,25 x 35	S	100	78,00
M 12 x 1,5 x 35	S	100	69,00

Abmessungen	VE	Stück	€/100/Obf.
M 20 x 1,5 x 120 S 25	690,00 gal Zn		
M 20 x 1,5 x 140 S 25	830,00 gal Zn		
M 20 x 1,5 x 150 S 25	860,00 gal Zn		
M 20 x 1,5 x 160 S 10	1540,00 gal Zn		
M 20 x 1,5 x 180 S 10	1640,00 gal Zn		
M 20 x 1,5 x 200 S 10	1880,00 gal Zn		
M 24 x 2 x 80 S 25	840,00 gal Zn		
M 24 x 2 x 90 S 25	910,00 gal Zn		
M 24 x 2 x 100 S 10	970,00 gal Zn		
M 24 x 2 x 120 S 10	1110,00 gal Zn		
M 24 x 2 x 130 S 10	1290,00 gal Zn		
M 24 x 2 x 140 S 10	1410,00 gal Zn		
M 24 x 2 x 150 S 10	1530,00 gal Zn		
M 24 x 2 x 160 S 10	1690,00 gal Zn		
M 24 x 2 x 170 S 10	1820,00 gal Zn		

ISO 08765.100

8765 10.9

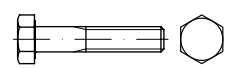

Sechskantschrauben mit Schaft, mit metrischem Feingewinde

kurze Abmessungen z. T. Gewinde bis Kopf,
 *M 10/12/14/22 = RAZ 3600 übrige Ø = RAZ 440

Maße → TI-15 Anziehmomente → TI-244
 Werkstoffeigensch. → TI-232 Normumstellung → TI-6

ISO 8765 → ersetzt DIN 960



M 8 x 1 x 30 S 200	31,50
M 8 x 1 x 35 S 200	37,50
M 8 x 1 x 40 S 200	40,00
M 8 x 1 x 45 S 200	44,50
M 8 x 1 x 50 S 200	48,50
M 8 x 1 x 60 S 200	57,00
M 8 x 1 x 70 S 200	66,00
M 8 x 1 x 80 S 200	74,00
M 10 x 1 x 35 S 100	67,00
M 10 x 1,25 x 35 S 100	109,00
M 10 x 1 x 40 S 100	69,00
M 10 x 1,25 x 40 S 100	112,00
M 10 x 1 x 45 S 100	116,00
M 10 x 1,25 x 45 S 100	116,00
M 10 x 1 x 50 S 100	74,00
M 10 x 1,25 x 50 S 100	75,00
M 10 x 1 x 55 S 100	76,00
M 10 x 1,25 x 55 S 100	77,00
M 10 x 1 x 60 S 100	79,00
M 10 x 1,25 x 60 S 100	79,00
M 10 x 1 x 70 S 100	124,00
M 10 x 1,25 x 70 S 100	124,00
M 10 x 1 x 80 S 100	144,00
M 10 x 1,25 x 80 S 100	158,00
M 10 x 1 x 90 S 100	163,00
M 10 x 1,25 x 90 S 100	170,00
M 10 x 1 x 100 S 100	200,00
M 10 x 1,25 x 100 S 100	200,00
M 10 x 1,25 x 110 S 100	216,00
M 12 x 1,25 x 35 S 100	78,00
M 12 x 1,5 x 35 S 100	83,00
M 12 x 1,25 x 40 S 100	86,00
M 12 x 1,5 x 40 S 100	89,00
M 12 x 1,25 x 45 S 100	97,00
M 12 x 1,5 x 45 S 100	97,00
M 12 x 1,25 x 50 S 100	105,00

Abmessungen	VE	Stück	€/100/Obf.
M 12 x 1,5 x 50 S 100	104,00		
M 12 x 1,5 x 55 S 100	107,00		
M 12 x 1,25 x 60 S 100	114,00		
M 12 x 1,5 x 60 S 100	114,00		
M 12 x 1,25 x 65 S 50	117,00		
M 12 x 1,5 x 65 S 50	116,00		
M 12 x 1,25 x 70 S 50	123,00		
M 12 x 1,5 x 70 S 50	123,00		
M 12 x 1,5 x 75 S 50	143,00		
M 12 x 1,25 x 80 S 50	144,00		
M 12 x 1,5 x 80 S 50	144,00		
M 12 x 1,25 x 90 S 50	211,00		
M 12 x 1,5 x 90 S 50	211,00		
M 12 x 1,25 x 100 S 50	233,00		
M 12 x 1,5 x 100 S 50	233,00		
M 12 x 1,25 x 110 S 50	265,00		
M 12 x 1,5 x 110 S 50	265,00		
M 12 x 1,25 x 120 S 50	295,00		
M 12 x 1,5 x 120 S 25	295,00		
M 12 x 1,25 x 130 S 50	305,00		
M 12 x 1,5 x 130 S 50	305,00		
M 12 x 1,5 x 140 S 50	325,00		
M 14 x 1,5 x 50 S 50	144,00		
M 14 x 1,5 x 55 S 50	152,00		
M 14 x 1,5 x 60 S 50	157,00		
M 14 x 1,5 x 65 S 50	183,00		
M 14 x 1,5 x 70 S 50	183,00		
M 14 x 1,5 x 75 S 50	201,00		
M 14 x 1,5 x 80 S 50	201,00		
M 14 x 1,5 x 90 S 50	295,00		
M 14 x 1,5 x 100 S 25	305,00		
M 14 x 1,5 x 110 S 25	340,00		
M 14 x 1,5 x 120 S 25	370,00		
M 14 x 1,5 x 130 S 25	410,00		
M 14 x 1,5 x 140 S 25	425,00		
M 14 x 1,5 x 160 S 25	470,00		
M 16 x 1,5 x 50 S 25	204,00		
M 16 x 1,5 x 55 S 50	212,00		
M 16 x 1,5 x 60 S 50	227,00		
M 16 x 1,5 x 65 S 25	246,00		
M 16 x 1,5 x 70 S 25	260,00		
M 16 x 1,5 x 75 S 25	285,00		
M 16 x 1,5 x 80 S 25	285,00		
M 16 x 1,5 x 85 S 25	285,00		
M 16 x 1,5 x 90 S 25	285,00		
M 16 x 1,5 x 100 S 25	305,00		
M 16 x 1,5 x 110 S 25	390,00		
M 16 x 1,5 x 115 S 25	405,00		
M 16 x 1,5 x 120 S 25	405,00		
M 16 x 1,5 x 130 S 25	445,00		
M 16 x 1,5 x 140 S 25	470,00		
M 16 x 1,5 x 150 S 25	495,00		
M 16 x 1,5 x 160 S 25	550,00		
M 18 x 1,5 x 60 S 25	510,00		
M 18 x 1,5 x 65 S 25	510,00		
M 18 x 1,5 x 70 S 25	510,00		
M 18 x 1,5 x 75 S 25	510,00		
M 18 x 1,5 x 80 S 25	510,00		
M 18 x 1,5 x 90 S 25	590,00		
M 18 x 1,5 x 100 S 25	620,00		
M 18 x 1,5 x 120 S 10	720,00		
M 18 x 1,5 x 140 S 10	830,00		
M 18 x 1,5 x 150 S 10	960,00		
M 20 x 1,5 x 60 S 25	510,00		
M 20 x 2 x 60 S 25	510,00		
M 20 x 1,5 x 65 S 25	510,00		
M 20 x 2 x 65 S 25	510,00		
M 20 x 1,5 x 70 S 25	510,00		
M 20 x 2 x 70 S 25	510,00		
M 20 x 1,5 x 75 S 25	570,00		
M 20 x 1,5 x 80 S 25	560,00		
M 20 x 2 x 80 S 25	560,00		
M 20 x 1,5 x 85 S 25	640,00		
M 20 x 1,5 x 90 S 25	620,00		
M 20 x 1,5 x 100 S 25	650,00		

Abmessungen	VE	Stück	€/100/Obf.
M 20 x 1,5 x 110 S 10	670,00		
M 20 x 1,5 x 120 S 10	700,00		
M 20 x 2 x 120 S 10	700,00		
M 20 x 1,5 x 130 S 10	840,00		
M 20 x 1,5 x 140 S 10	930,00		
M 20 x 1,5 x 150 S 10	1520,00		
M 20 x 1,5 x 160 S 10	1660,00		
M 20 x 1,5 x 170 S 10	1800,00		
M 20 x 1,5 x 180 S 10	1840,00		
M 20 x 1,5 x 200 S 10	2340,00		
M 22 x 1,5 x 70 S 25	810,00		
M 22 x 2 x 70 S 25	1070,00		
M 22 x 1,5 x 80 S 25	820,00		
M 22 x 1,5 x 90 S 10	900,00		
M 22 x 1,5 x 100 S 10	930,00		
M 22 x 1,5 x 110 S 10	1010,00		
M 22 x 1,5 x 120 S 10	1080,00		
M 22 x 1,5 x 130 S 10	1120,00		
M 22 x 1,5 x 140 S 10	1130,00		
M 24 x 1,5 x 70 S 25	740,00		
M 24 x 2 x 70 S 25	1290,00		
M 24 x 1,5 x 80 S 25	820,00		
M 24 x 2 x 80 S 25	1550,00		
M 24 x 1,5 x 90 S 10	900,00		
M 24 x 2 x 90 S 25	1800,00		
M 24 x 1,5 x 100 S 10	930,00		
M 24 x 2 x 100 S 10	1850,00		
M 24 x 1,5 x 110 S 10	1010,00		
M 24 x 2 x 110 S 10	1970,00		
M 24 x 1,5 x 120 S 10	1250,00		
M 24 x 2 x 120 S 10	2130,00		
M 24 x 1,5 x 130 S 10	2240,00		
M 24 x 2 x 130 S 10	2240,00		
M 24 x 1,5 x 140 S 10	2750,00		
M 24 x 2 x 150 S 10	3250,00		
M 30 x 2 x 90 S 1	2160,00		
M 30 x 2 x 100 S 1	2300,00		
M 30 x 2 x 110 S 1	2490,00		
M 30 x 2 x 120 S 1	2700,00		
M 30 x 2 x 130 S 1	2850,00		
M 30 x 2 x 140 S 1	3050,00		
M 30 x 2 x 150 S 1	3250,00		
M 30 x 2 x 160 S 1	3450,00		
M 36 x 3 x 110 S 1	2950,00		
M 36 x 3 x 120 S 1	3250,00		
M 36 x 3 x 130 S 1	3500,00		
M 36 x 3 x 140 S 1	3800,00		
M 36 x 3 x 150 S 1	4100,00		
M 36 x 3 x 160 S 1	4350,00		
M 42 x 3 x 140 S 1	4450,00		
M 42 x 3 x 160 S 1	5100,00		
M 42 x 3 x 180 S 1	5800,00		
M 42 x 3 x 200 S 1	6400,00		

Abmessungen	VE Stück	€/100/Obf.
ISO	08765.110	
8765	10.9	galvanisch verzinkt

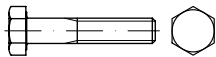

Sechskantschrauben mit Schaft, mit metrischem Feingewinde

kurze Abmessungen z. T. Gewinde bis Kopf, getempert, *M 10/12/14/22 = RAZ 3600 übrige Ø = RAZ 440

Achtung! Warneinblender zu Wasserstoffversprödung beachten.

Maße → **TI-15** Anziehungsmomente → **TI-244**
 Werkstoffeigensch. → **TI-232** Normumstellung → **TI-6**
 Korrosionsschutz → **TI-228**

ISO 8765 → ersetzt DIN 960

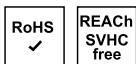

M 10	x	1	x	45	S	100	134,00 gal Zn
M 12	x	1,5	x	45	S	100	122,00 gal Zn
M 12	x	1,5	x	50	S	100	136,00 gal Zn
M 12	x	1,5	x	60	S	100	148,00 gal Zn
M 12	x	1,5	x	65	S	50	149,00 gal Zn
M 12	x	1,5	x	70	S	50	167,00 gal Zn
M 14	x	1,5	x	50	S	50	205,00 gal Zn
M 14	x	1,5	x	55	S	50	210,00 gal Zn
M 14	x	1,5	x	60	S	50	216,00 gal Zn
M 14	x	1,5	x	65	S	50	229,00 gal Zn
M 14	x	1,5	x	70	S	50	250,00 gal Zn
M 14	x	1,5	x	75	S	50	255,00 gal Zn
M 14	x	1,5	x	80	S	50	270,00 gal Zn
M 14	x	1,5	x	90	S	50	300,00 gal Zn
M 14	x	1,5	x	100	S	50	370,00 gal Zn
M 14	x	1,5	x	110	S	25	410,00 gal Zn
M 16	x	1,5	x	60	S	50	285,00 gal Zn
M 16	x	1,5	x	70	S	25	155,00 gal Zn
M 16	x	1,5	x	75	S	25	350,00 gal Zn
M 16	x	1,5	x	80	S	25	360,00 gal Zn
M 16	x	1,5	x	90	S	25	375,00 gal Zn
M 16	x	1,5	x	100	S	25	400,00 gal Zn
M 16	x	1,5	x	110	S	25	500,00 gal Zn
M 16	x	1,5	x	120	S	25	510,00 gal Zn
M 16	x	1,5	x	130	S	25	560,00 gal Zn
M 20	x	1,5	x	80	S	25	690,00 gal Zn
M 20	x	1,5	x	90	S	25	770,00 gal Zn
M 20	x	1,5	x	100	S	25	800,00 gal Zn
M 20	x	1,5	x	120	S	10	880,00 gal Zn

Abmessungen	VE Stück	€/100/Obf.
DIN	09021.000	
9021	Stahl 140/100 HV**	

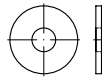

Scheiben, Außen Ø ≈ 3 x Schrauben Ø, Produktklasse A/C*

*Ø ≤ 8,4 = A/Ø > 8,4 = C,
 **Ø ≤ 17 = 140 HV/Ø > 17 = 100 HV

Maße → **TI-85** Normumstellung → **TI-84**

Rostfrei → **S. 586**
 Messing, Kunststoff → **S. 643**

DIN 9021 → wird ersetzt durch ISO 7093



Innen Ø x Außen Ø x Dicke

2,7	x	8	x	0,8	S	10000	0,65
3,2	x	9	x	0,8	S	10000	0,70
3,2	x	9	x	0,8	K	500	0,95
4,3	x	12	x	1	S	5000	1,05
4,3	x	12	x	1	K	500	1,50
5,3	x	15	x	1,2	S	2500	1,95
5,3	x	15	x	1,2	K	250	2,25
6,4	x	18	x	1,6	S	2500	2,60
6,4	x	18	x	1,6	K	250	2,90
7,4	x	22	x	2	K	100	6,90
8,4	x	24	x	2	S	500	5,30
8,4	x	24	x	2	K	100	6,20
10,5	x	30	x	2,5	S	250	8,80
10,5	x	30	x	2,5	K	100	10,80
13	x	37	x	3	S	100	20,10
15	x	44	x	3	S	100	27,50
17	x	50	x	3	S	100	29,50
20	x	56	x	4	S	100	61,00
22	x	60	x	4	S	100	62,00
33	x	92	x	7	S	25	270,00

Abmessungen	VE Stück	€/100/Obf.
DIN	09021.010	
9021	Stahl 140/100 HV**	
	galvanisch verzinkt	

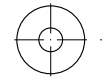

Scheiben, Außen Ø ≈ 3 x Schrauben Ø, Produktklasse A/C*

*Ø ≤ 8,4 = A/Ø > 8,4 = C,
 **Ø ≤ 17 = 140 HV/Ø > 17 = 100 HV

Maße → **TI-85** Normumstellung → **TI-84**

Korrosionsschutz → **TI-228**

Rostfrei → **S. 586**
 Messing, Kunststoff → **S. 643**

DIN 9021 → wird ersetzt durch ISO 7093

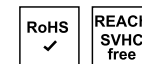

Innen Ø x Außen Ø x Dicke

3,2	x	9	x	0,8	S	10000	0,80 gal Zn
3,2	x	9	x	0,8	K	500	1,05 gal Zn
4,3	x	12	x	1	S	5000	1,30 gal Zn
4,3	x	12	x	1	K	500	1,70 gal Zn
5,3	x	15	x	1,2	S	2500	2,50 gal Zn
5,3	x	15	x	1,2	K	250	2,80 gal Zn
6,4	x	18	x	1,6	S	2500	3,40 gal Zn
6,4	x	18	x	1,6	K	250	3,75 gal Zn
7,4	x	22	x	2	K	100	9,40 gal Zn
8,4	x	24	x	2	S	500	7,40 gal Zn
8,4	x	24	x	2	K	100	8,40 gal Zn
10,5	x	30	x	2,5	S	250	12,40 gal Zn
10,5	x	30	x	2,5	K	100	15,00 gal Zn
13	x	37	x	3	S	100	29,50 gal Zn
15	x	44	x	3	S	100	39,00 gal Zn
17	x	50	x	3	S	100	44,00 gal Zn
20	x	56	x	4	S	100	84,00 gal Zn
22	x	60	x	4	S	100	88,00 gal Zn
26	x	72	x	5	S	50	345,00 gal Zn
33	x	92	x	6	S	25	455,00 gal Zn
39	x	110	x	8	S	25	440,00 gal Zn

Wichtiger Hinweis!



Bei galvanischen Überzügen auf hochfesten und federharten Teilen (≥1000 N/mm² oder ≥320 HV) ist die Gefahr einer Wasserstoffversprödung (Sprödbruchgefahr) nicht mit Sicherheit auszuschließen (ISO 4042). Durch eine rechtzeitig eingeleitete thermische Nachbehandlung (Tempern) kann die Gefahr eines wasserstoffinduzierten Sprödbruches im Regelfall verringert werden. Da aber ein Restrisiko nicht mit Sicherheit auszuschließen ist, erfolgen galvanische Überzüge auf derartigen Teilen nur auf ausdrücklichen Wunsch und auf Risiko des Auftraggebers.

Abmessungen	VE Stück	€/100/Obf.
DIN 09021.020		
9021	Stahl 140/100 HV**	
	feuerverzinkt	

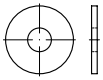

Scheiben, Außen Ø ≈ 3 x Schrauben Ø, Produktklasse A/C*

*Ø ≤ 8,4 = A/Ø > 8,4 = C,
**Ø ≤ 17 = 140 HV/Ø > 17 = 100 HV

Maße → **TI-85** Normumstellung → **TI-84**
Korrosionsschutz → **TI-231**

Rostfrei → **S. 586**
Messing, Kunststoff → **S. 643**

DIN 9021 → wird ersetzt durch ISO 7093

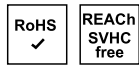

Innen Ø x Außen Ø x Dicke

6,4	x	18	x	1,6	S	1000	7,80 tZn
8,4	x	24	x	2	S	500	17,70 tZn
10,5	x	30	x	2,5	S	250	21,30 tZn
13	x	37	x	3	S	100	38,00 tZn
17	x	50	x	3	S	100	73,00 tZn
20	x	56	x	4	S	100	126,00 tZn
22	x	60	x	4	S	100	151,00 tZn
26	x	72	x	5	S	100	260,00 tZn

DIN	09925.000
9925	Federstahl



Runddraht-Sprengringe für Wellen

Maße → **TI-101**

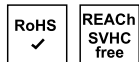

Nennmaß = für Wellen Ø

4	S	5000	4,75
5	S	5000	4,85
6	S	5000	4,85
7	S	2500	5,30
8	S	2500	5,00
10	S	2000	5,70
12	S	2000	6,10
16	S	1000	7,90
18	S	1000	9,90
20	S	1000	11,90
22	S	500	12,40
25	S	500	15,70
26	S	500	15,80
28	S	500	18,20
30	S	500	19,80
32	S	250	21,50
35	S	250	23,90
38	S	250	28,00
40	S	250	33,00
45	S	250	38,00
48	S	200	42,50

Abmessungen	VE Stück	€/100/Obf.	
50	S	200	47,50
55	S	200	53,00
60	S	200	57,00
65	S	200	62,00
70	S	200	80,00

DIN	09926.000
9926	Federstahl



Runddraht-Sprengringe für Bohrungen

Maße → **TI-101**

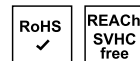

Nennmaß = für Bohrungs Ø

7	S	5000	3,90
8	S	5000	4,40
10	S	5000	5,00
12	S	2500	5,60
16	S	2000	8,80
18	S	2000	11,50

Artikel	10105.130
10105	10.9 zinklamellenbesch.

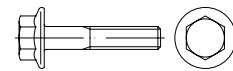

Sechskantschrauben mit Flansch nach MBN 10105

Oberfläche gemäß DBL 9440.40

Zugehörige Flanschmutter → Artikel 13023

Maße → **TI-17** Korrosionsschutz → **TI-230**
Werkstoffeigensch. → **TI-232** Anziehungsmomente → **TI-245**



Gewinde M x Steigung x Länge

M 10	x	1,5	x	25	S	100	151,00 flZn
M 10	x	1,5	x	30	S	100	164,00 flZn
M 10	x	1,5	x	40	S	100	167,00 flZn
M 12	x	1,5	x	35	S	100	330,00 flZn
M 12	x	1,5	x	40	S	100	330,00 flZn
M 12	x	1,5	x	45	S	100	340,00 flZn
M 12	x	1,5	x	50	S	100	350,00 flZn
M 12	x	1,5	x	60	S	100	420,00 flZn
M 12	x	1,5	x	70	S	100	425,00 flZn
M 12	x	1,5	x	80	S	100	460,00 flZn
M 12	x	1,5	x	90	S	100	395,00 flZn
M 12	x	1,5	x	100	S	50	540,00 flZn
M 12	x	1,5	x	110	S	50	560,00 flZn
M 12	x	1,5	x	120	S	50	600,00 flZn
M 12	x	1,5	x	130	S	50	630,00 flZn
M 12	x	1,5	x	140	S	50	670,00 flZn
M 12	x	1,5	x	150	S	50	710,00 flZn
M 14	x	1,5	x	30	S	50	410,00 flZn
M 14	x	1,5	x	35	S	50	370,00 flZn
M 14	x	1,5	x	40	S	50	360,00 flZn
M 14	x	1,5	x	45	S	50	380,00 flZn
M 14	x	1,5	x	50	S	50	395,00 flZn

Abmessungen	VE Stück	€/100/Obf.					
M 14	x	1,5	x	55	S	50	405,00 flZn
M 14	x	1,5	x	60	S	50	420,00 flZn
M 14	x	1,5	x	65	S	50	445,00 flZn
M 14	x	1,5	x	70	S	50	460,00 flZn
M 14	x	1,5	x	80	S	50	510,00 flZn
M 14	x	1,5	x	90	S	50	530,00 flZn
M 14	x	1,5	x	100	S	50	455,00 flZn
M 16	x	1,5	x	40	S	50	550,00 flZn
M 16	x	1,5	x	45	S	50	570,00 flZn
M 16	x	1,5	x	50	S	50	610,00 flZn
M 16	x	1,5	x	55	S	50	620,00 flZn
M 16	x	1,5	x	60	S	50	860,00 flZn
M 16	x	1,5	x	120	S	25	790,00 flZn
M 16	x	1,5	x	130	S	25	830,00 flZn
M 16	x	1,5	x	140	S	25	880,00 flZn
M 16	x	1,5	x	150	S	25	960,00 flZn
M 16	x	1,5	x	160	S	25	1050,00 flZn

ISO	10511.410
10511	04 galvanisch verzinkt

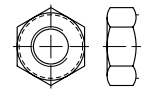

Sechskantmutter mit Klemmteil, mit nichtmetallischem Einsatz, niedrige Form

für Temperatur-Einsatz von -50 bis +120 °C

Maße → **TI-9** Normumstellung → **TI-9**
Werkstoffeigensch. → **TI-233** REACH → **TI-262**
Korrosionsschutz → **TI-228**

Rostfrei → **S. 587**
Messing → **S. 643**

ISO 10511 → ersetzt DIN 985

M 3	S	1000	7,40 gal Zn
M 4	S	1000	7,40 gal Zn
M 5	S	1000	7,40 gal Zn
M 6	S	1000	8,60 gal Zn
M 8	S	500	13,40 gal Zn
M 10	S	500	26,00 gal Zn
M 12	S	250	36,50 gal Zn
M 14	S	100	61,00 gal Zn
M 16	S	100	73,00 gal Zn
M 18	S	50	117,00 gal Zn
M 20	S	50	141,00 gal Zn
M 22	S	25	216,00 gal Zn
M 24	S	25	260,00 gal Zn
M 30	S	10	540,00 gal Zn
M 36	S	10	1010,00 gal Zn

Abmessungen	VE Stück	€/100/Obf.
ISO	10511.411	
10511	04	galv. verz. 8 DiSP*

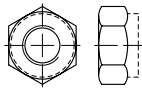

Sechskantmutter mit Klemmteil, mit nichtmetallischem Einsatz, niedrige Form

für Temperatur-Einsatz von -50 bis +120 °C,
* < M 6 Mindestschichtdicke 5µm,
Korrosionsbeständigkeit NSS: 72h WR, 120h RR

Maße → **TI-9** Normumstellung → **TI-9**
Werkstoffeigensch. → **TI-233** REACH → **TI-262**
Korrosionsschutz → **TI-228**
Rostfrei → **S. 587**
Messing → **S. 643**
ISO 10511 → ersetzt DIN 985

M 4	S 1000	10,50 gal ZnDi
M 5	S 1000	10,50 gal ZnDi
M 6	S 1000	13,80 gal ZnDi
M 8	S 1000	20,90 gal ZnDi
M 10	S 500	36,50 gal ZnDi
M 12	S 250	51,00 gal ZnDi
M 14	S 100	88,00 gal ZnDi
M 16	S 100	103,00 gal ZnDi
M 20	S 50	198,00 gal ZnDi
M 24	S 25	365,00 gal ZnDi

ISO	10511.510
10511	05
	galvanisch verzinkt

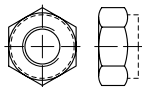

Sechskantmutter mit Klemmteil, mit nichtmetallischem Einsatz, niedrige Form

für Temperatur-Einsatz von -50 bis +120 °C

Maße → **TI-9** Normumstellung → **TI-9**
Werkstoffeigensch. → **TI-233** REACH → **TI-262**
Korrosionsschutz → **TI-228**
Rostfrei → **S. 587**
Messing → **S. 643**
ISO 10511 → ersetzt DIN 985

M 6	S 1000	670,00 gal Zn
M 8	S 1000	520,00 gal Zn
M 10	S 500	51,00 gal Zn
M 12	S 250	73,00 gal Zn
M 14	S 100	114,00 gal Zn
M 16	S 100	1240,00 gal Zn
M 18	S 50	205,00 gal Zn
M 20	S 50	234,00 gal Zn
M 22	S 25	315,00 gal Zn
M 24	S 25	395,00 gal Zn
M 30	S 1	990,00 gal Zn
M 36	S 1	2120,00 gal Zn

Abmessungen	VE Stück	€/100/Obf.
ISO	10512.110	
10512	10	galvanisch verzinkt

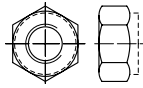

Sechskantmutter mit Klemmteil, mit nichtmetallischem Einsatz, hohe Form, mit metr. Feingewinde

für Temperatur-Einsatz von -50 bis +120 °C,
* M 10/12/14 RAZ = 3395, übrige Ø RAZ = 480

Maße → **TI-9** Korrosionsschutz → **TI-228**
Werkstoffeigensch. → **TI-233** Normumstellung → **TI-9**
ISO 10512 → ersetzt DIN 982



M 10	x 1	S 100	84,00 gal Zn
M 12	x 1,5	S 100	120,00 gal Zn
M 14	x 1,5	S 100	161,00 gal Zn
M 16	x 1,5	S 50	216,00 gal Zn
M 20	x 1,5	S 50	390,00 gal Zn
M 24	x 2	S 25	570,00 gal Zn

ISO	10513.810
10513	8
	galvanisch verzinkt

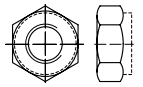

Sechskantmutter mit Klemmteil, mit metrischem Feingewinde, Ganzmetallmuttern

* M 10/12/14/22 RAZ = 3395, übrige Ø RAZ = 480

Maße → **TI-9** Korrosionsschutz → **TI-228**
Werkstoffeigensch. → **TI-233** Normumstellung → **TI-9**
ISO 10513 → ersetzt DIN 980

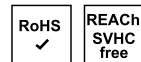

M 8	x 1	S 100	30,00 gal Zn
M 10	x 1	S 100	34,50 gal Zn
M 12	x 1,5	S 100	42,00 gal Zn
M 14	x 1,5	S 100	60,00 gal Zn
M 16	x 1,5	S 100	79,00 gal Zn
M 18	x 1,5	S 50	136,00 gal Zn
M 20	x 1,5	S 50	131,00 gal Zn
M 24	x 1,5	S 25	239,00 gal Zn
M 24	x 2	S 25	239,00 gal Zn
M 30	x 2	S 10	620,00 gal Zn

Abmessungen	VE Stück	€/100/Obf.
ISO	10513.110	
10513	10	galvanisch verzinkt

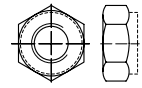

Sechskantmutter mit Klemmteil, mit metrischem Feingewinde, Ganzmetallmuttern

* M 10/12/14/22 RAZ = 3395, übrige Ø RAZ = 480

Maße → **TI-9** Korrosionsschutz → **TI-228**
Werkstoffeigensch. → **TI-233** Normumstellung → **TI-9**
ISO 10513 → ersetzt DIN 980



M 8	x 1	S 100	34,00 gal Zn
M 10	x 1	S 100	54,00 gal Zn
M 10	x 1,25	S 100	53,00 gal Zn
M 12	x 1,25	S 100	65,00 gal Zn
M 12	x 1,5	S 100	65,00 gal Zn
M 14	x 1,5	S 100	92,00 gal Zn
M 16	x 1,5	S 50	112,00 gal Zn
M 18	x 1,5	S 50	170,00 gal Zn
M 20	x 1,5	S 50	197,00 gal Zn
M 24	x 1,5	S 25	315,00 gal Zn
M 24	x 2	S 25	315,00 gal Zn

ISO	10642.800
10642	08.8

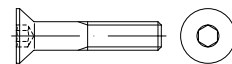

Senkschrauben mit Innensechskant

Ø > M 20: Kopfgeometrie nach DIN 7991, eine Fabrikate Gewinde bis Kopf

Achtung! Schrauben nur eingeschränkt belastbar.

Maße → **TI-14** Anziehmomente → **TI-246**
Werkstoffeigensch. → **TI-232**

Rostfrei → **S. 587**



M 3	x 6	S 500	62,00
M 3	x 6	K 100	67,00
M 3	x 8	S 500	37,00
M 3	x 8	K 100	42,00
M 3	x 10	S 500	31,50
M 3	x 10	K 100	37,00
M 3	x 12	S 500	31,50
M 3	x 12	K 100	37,00
M 3	x 16	S 500	31,50
M 3	x 16	K 100	37,00
M 3	x 18	S 500	34,00
M 3	x 20	S 500	40,50
M 3	x 20	K 100	45,50

Abmessungen	VE	Stück	€/100/Obf.	Abmessungen	VE	Stück	€/100/Obf.	Abmessungen	VE	Stück	€/100/Obf.
M 3 x 22	S	500	46,50	M 6 x 45	S	200	49,00	M 14 x 30	S	50	365,00
M 3 x 25	S	500	39,50	M 6 x 50	S	200	55,00	M 14 x 35	S	50	365,00
M 3 x 25	K	100	44,50	M 6 x 55	S	200	68,00	M 14 x 40	S	50	355,00
M 3 x 30	S	500	42,50	M 6 x 60	S	200	68,00	M 14 x 45	S	50	380,00
M 3 x 30	K	100	47,50	M 6 x 70	S	200	130,00	M 14 x 50	S	50	380,00
M 4 x 6	S	500	43,50	M 6 x 80	S	200	183,00	M 14 x 55	S	50	400,00
M 4 x 6	K	100	48,00	M 8 x 10	S	200	130,00	M 14 x 60	S	50	400,00
M 4 x 8	S	500	35,50	M 8 x 12	S	200	38,00	M 14 x 70	S	50	400,00
M 4 x 8	K	100	40,00	M 8 x 14	S	200	23,50	M 14 x 80	S	50	400,00
M 4 x 10	S	500	27,50	M 8 x 16	S	200	23,90	M 16 x 20	S	50	550,00
M 4 x 10	K	100	32,00	M 8 x 18	S	200	20,70	M 16 x 25	S	50	550,00
M 4 x 12	S	500	27,50	M 8 x 20	S	200	20,70	M 16 x 30	S	50	157,00
M 4 x 12	K	100	32,50	M 8 x 22	S	200	48,50	M 16 x 35	S	50	155,00
M 4 x 16	S	500	31,00	M 8 x 25	S	200	21,90	M 16 x 40	S	50	152,00
M 4 x 16	K	100	36,00	M 8 x 30	S	200	24,00	M 16 x 45	S	50	161,00
M 4 x 18	S	500	32,00	M 8 x 35	S	200	27,50	M 16 x 50	S	50	161,00
M 4 x 20	S	500	32,00	M 8 x 40	S	200	28,50	M 16 x 55	S	50	280,00
M 4 x 20	K	100	36,50	M 8 x 45	S	200	33,50	M 16 x 60	S	50	174,00
M 4 x 22	S	500	39,00	M 8 x 50	S	200	58,00	M 16 x 70	S	25	380,00
M 4 x 25	S	500	35,50	M 8 x 55	S	200	69,00	M 16 x 80	S	25	400,00
M 4 x 25	K	100	40,00	M 8 x 60	S	200	78,00	M 16 x 90	S	25	425,00
M 4 x 30	S	500	40,00	M 8 x 70	S	200	143,00	M 16 x 100	S	25	460,00
M 4 x 30	K	100	44,50	M 8 x 80	S	200	183,00	M 16 x 110	S	25	660,00
M 4 x 35	S	500	46,00	M 8 x 90	S	100	204,00	M 16 x 120	S	25	720,00
M 4 x 35	K	100	51,00	M 8 x 100	S	100	244,00	M 16 x 130	S	25	850,00
M 4 x 40	S	500	77,00	M 8 x 110	S	100	285,00	M 16 x 140	S	25	1000,00
M 4 x 40	K	100	82,00	M 8 x 120	S	100	355,00	M 16 x 150	S	25	1070,00
M 4 x 45	S	500	78,00	M 8 x 130	S	100	510,00	M 16 x 160	S	25	1190,00
M 4 x 50	S	500	78,00	M 8 x 140	S	100	610,00	M 16 x 180	S	25	1320,00
M 5 x 6	S	500	35,50	M 8 x 150	S	100	810,00	M 16 x 200	S	25	1560,00
M 5 x 8	S	500	31,50	M 8 x 160	S	100	1020,00	M 20 x 40	S	25	580,00
M 5 x 8	K	100	36,00	M 10 x 12	S	200	143,00	M 20 x 45	S	25	610,00
M 5 x 10	S	500	16,20	M 10 x 16	S	200	55,00	M 20 x 50	S	25	610,00
M 5 x 10	K	100	21,00	M 10 x 18	S	200	47,50	M 20 x 60	S	25	690,00
M 5 x 12	S	500	17,30	M 10 x 20	S	200	47,50	M 20 x 65	S	25	730,00
M 5 x 12	K	100	22,10	M 10 x 25	S	200	48,00	M 20 x 70	S	25	730,00
M 5 x 16	S	500	17,80	M 10 x 30	S	200	49,50	M 20 x 80	S	25	800,00
M 5 x 16	K	100	22,60	M 10 x 35	S	100	57,00	M 20 x 90	S	25	1010,00
M 5 x 18	S	500	18,30	M 10 x 40	S	100	57,00	M 20 x 100	S	25	1050,00
M 5 x 18	K	100	23,00	M 10 x 45	S	100	61,00	M 20 x 110	S	25	1080,00
M 5 x 20	S	500	18,30	M 10 x 50	S	100	80,00	M 20 x 120	S	25	1220,00
M 5 x 20	K	100	23,00	M 10 x 55	S	100	90,00	M 20 x 130	S	25	1300,00
M 5 x 22	S	500	43,50	M 10 x 60	S	100	124,00	M 20 x 140	S	25	1330,00
M 5 x 25	S	500	21,20	M 10 x 70	S	100	158,00	M 20 x 180	S	10	1980,00
M 5 x 25	K	100	26,00	M 10 x 80	S	100	170,00	M 24 x 40	S	25	1150,00
M 5 x 30	S	500	22,50	M 10 x 90	S	100	255,00	M 24 x 50	S	25	1220,00
M 5 x 30	K	100	27,50	M 10 x 100	S	100	305,00	M 24 x 60	S	25	1300,00
M 5 x 35	S	200	47,00	M 10 x 110	S	100	460,00	M 24 x 70	S	25	1350,00
M 5 x 40	S	200	47,00	M 10 x 120	S	100	510,00	M 24 x 80	S	25	1440,00
M 5 x 45	S	200	55,00	M 10 x 130	S	50	610,00	M 24 x 90	S	1	1480,00
M 5 x 50	S	200	56,00	M 10 x 140	S	50	710,00	M 24 x 100	S	1	1550,00
M 5 x 55	S	200	87,00	M 10 x 150	S	50	1020,00				
M 5 x 60	S	200	95,00	M 10 x 160	S	50	1120,00				
M 5 x 70	S	200	123,00	M 12 x 20	S	100	69,00				
M 6 x 8	S	500	58,00	M 12 x 25	S	100	59,00				
M 6 x 8	K	100	63,00	M 12 x 30	S	100	59,00				
M 6 x 10	S	500	17,80	M 12 x 35	S	100	64,00				
M 6 x 10	K	100	22,60	M 12 x 40	S	100	68,00				
M 6 x 12	S	500	15,90	M 12 x 45	S	100	77,00				
M 6 x 12	K	100	20,70	M 12 x 50	S	100	83,00				
M 6 x 14	S	500	27,00	M 12 x 55	S	100	93,00				
M 6 x 16	S	500	15,50	M 12 x 60	S	100	137,00				
M 6 x 16	K	100	20,20	M 12 x 65	S	100	194,00				
M 6 x 18	S	500	16,50	M 12 x 70	S	50	223,00				
M 6 x 18	K	100	21,30	M 12 x 80	S	50	260,00				
M 6 x 20	S	500	16,50	M 12 x 90	S	50	305,00				
M 6 x 20	K	100	21,30	M 12 x 100	S	50	355,00				
M 6 x 22	S	500	58,00	M 12 x 110	S	50	405,00				
M 6 x 22	K	100	63,00	M 12 x 120	S	50	440,00				
M 6 x 25	S	500	18,30	M 12 x 130	S	50	570,00				
M 6 x 25	K	100	23,00	M 12 x 140	S	50	630,00				
M 6 x 30	S	500	20,10	M 12 x 150	S	50	690,00				
M 6 x 30	K	100	24,90	M 12 x 160	S	50	1380,00				
M 6 x 35	S	200	24,20	M 12 x 180	S	50	1440,00				
M 6 x 40	S	200	48,50	M 12 x 200	S	50	1500,00				



- ✓ Große Artikelvielfalt
- ✓ Verlässliche Qualität
- ✓ Hohe Lieferbereitschaft

Abmessungen	VE Stück	€/100/Obf.
ISO 10642.810		
10642	08.8	galvanisch verzinkt



Senkschrauben mit Innensechskant

Ø > M 20: Kopfgeometrie nach DIN 7991, einige Fabrikate Gewinde bis Kopf

Achtung! Schrauben nur eingeschränkt belastbar.

Maße → **TI-14** Korrosionsschutz → **TI-228**
 Werkstoffeigensch. → **TI-232** Anziehmomente → **TI-246**

Rostfrei → **S. 587**



M 3	x	5	S	500	62,00 gal Zn
M 3	x	6	S	500	62,00 gal Zn
M 3	x	8	S	500	37,50 gal Zn
M 3	x	10	S	500	32,00 gal Zn
M 3	x	12	S	500	32,00 gal Zn
M 3	x	16	S	500	32,50 gal Zn
M 3	x	18	S	500	34,50 gal Zn
M 3	x	20	S	500	41,50 gal Zn
M 3	x	25	S	500	40,50 gal Zn
M 3	x	30	S	500	43,50 gal Zn
M 4	x	6	S	500	44,50 gal Zn
M 4	x	8	S	500	36,00 gal Zn
M 4	x	8	K	100	40,50 gal Zn
M 4	x	10	S	500	28,00 gal Zn
M 4	x	10	K	100	32,50 gal Zn
M 4	x	12	S	500	28,00 gal Zn
M 4	x	12	K	100	33,00 gal Zn
M 4	x	14	S	500	28,00 gal Zn
M 4	x	16	S	500	32,00 gal Zn
M 4	x	16	K	100	36,50 gal Zn
M 4	x	18	S	500	32,50 gal Zn
M 4	x	20	S	500	32,50 gal Zn
M 4	x	22	S	500	40,00 gal Zn
M 4	x	25	S	500	36,50 gal Zn
M 4	x	30	S	500	41,50 gal Zn
M 4	x	35	S	500	48,00 gal Zn
M 4	x	40	S	500	79,00 gal Zn
M 4	x	45	S	500	81,00 gal Zn
M 4	x	50	S	100	83,00 gal Zn
M 5	x	6	S	500	36,50 gal Zn
M 5	x	8	S	500	32,00 gal Zn
M 5	x	8	K	100	37,00 gal Zn
M 5	x	10	S	500	17,00 gal Zn
M 5	x	10	K	100	21,70 gal Zn
M 5	x	12	S	500	18,10 gal Zn
M 5	x	12	K	100	23,20 gal Zn
M 5	x	14	S	500	18,60 gal Zn
M 5	x	16	S	500	18,70 gal Zn
M 5	x	16	K	100	23,60 gal Zn
M 5	x	18	S	500	19,50 gal Zn
M 5	x	20	S	500	19,50 gal Zn
M 5	x	20	K	100	24,30 gal Zn
M 5	x	22	S	500	46,00 gal Zn
M 5	x	25	S	500	22,90 gal Zn
M 5	x	30	S	500	24,30 gal Zn
M 5	x	35	S	200	50,00 gal Zn
M 5	x	40	S	200	51,00 gal Zn
M 5	x	45	S	200	58,00 gal Zn
M 5	x	50	S	200	61,00 gal Zn

M 5	x	55	S	200	93,00 gal Zn
M 5	x	60	S	200	101,00 gal Zn
M 5	x	70	S	200	130,00 gal Zn
M 5	x	80	S	100	146,00 gal Zn
M 6	x	8	S	500	60,00 gal Zn
M 6	x	10	S	500	18,70 gal Zn
M 6	x	10	K	100	23,60 gal Zn
M 6	x	12	S	500	17,00 gal Zn
M 6	x	12	K	100	22,10 gal Zn
M 6	x	14	S	500	28,50 gal Zn
M 6	x	16	S	500	16,90 gal Zn
M 6	x	16	K	100	21,70 gal Zn
M 6	x	18	S	500	18,10 gal Zn
M 6	x	20	S	500	18,20 gal Zn
M 6	x	20	K	100	23,20 gal Zn
M 6	x	22	S	500	60,00 gal Zn
M 6	x	25	S	500	20,30 gal Zn
M 6	x	25	K	100	25,00 gal Zn
M 6	x	30	S	500	22,50 gal Zn
M 6	x	30	K	100	27,50 gal Zn
M 6	x	35	S	200	27,00 gal Zn
M 6	x	40	S	200	53,00 gal Zn
M 6	x	45	S	200	55,00 gal Zn
M 6	x	50	S	200	61,00 gal Zn
M 6	x	55	S	200	75,00 gal Zn
M 6	x	60	S	200	75,00 gal Zn
M 6	x	65	S	200	89,00 gal Zn
M 6	x	70	S	200	141,00 gal Zn
M 6	x	75	S	100	195,00 gal Zn
M 6	x	80	S	200	195,00 gal Zn
M 6	x	90	S	200	250,00 gal Zn
M 6	x	100	S	100	305,00 gal Zn
M 6	x	120	S	100	415,00 gal Zn
M 8	x	10	S	200	134,00 gal Zn
M 8	x	12	S	200	40,50 gal Zn
M 8	x	14	S	200	26,50 gal Zn
M 8	x	16	S	200	27,00 gal Zn
M 8	x	18	S	200	23,90 gal Zn
M 8	x	20	S	200	24,30 gal Zn
M 8	x	22	S	200	26,00 gal Zn
M 8	x	25	S	200	26,00 gal Zn
M 8	x	30	S	200	29,00 gal Zn
M 8	x	35	S	200	33,00 gal Zn
M 8	x	40	S	200	34,50 gal Zn
M 8	x	45	S	200	40,50 gal Zn
M 8	x	50	S	200	69,00 gal Zn
M 8	x	55	S	200	81,00 gal Zn
M 8	x	60	S	200	91,00 gal Zn
M 8	x	65	S	100	105,00 gal Zn
M 8	x	70	S	200	160,00 gal Zn
M 8	x	80	S	200	206,00 gal Zn
M 8	x	90	S	200	229,00 gal Zn
M 8	x	100	S	200	275,00 gal Zn
M 8	x	110	S	100	320,00 gal Zn
M 8	x	120	S	100	390,00 gal Zn
M 8	x	130	S	100	540,00 gal Zn
M 8	x	140	S	100	640,00 gal Zn
M 8	x	150	S	100	850,00 gal Zn
M 10	x	12	S	200	151,00 gal Zn
M 10	x	16	S	200	60,00 gal Zn
M 10	x	18	S	200	53,00 gal Zn
M 10	x	20	S	200	53,00 gal Zn
M 10	x	25	S	200	55,00 gal Zn
M 10	x	30	S	200	57,00 gal Zn
M 10	x	35	S	100	65,00 gal Zn
M 10	x	40	S	100	66,00 gal Zn
M 10	x	45	S	100	72,00 gal Zn
M 10	x	50	S	100	95,00 gal Zn
M 10	x	55	S	100	109,00 gal Zn
M 10	x	60	S	100	144,00 gal Zn
M 10	x	70	S	100	181,00 gal Zn
M 10	x	80	S	100	195,00 gal Zn
M 10	x	90	S	100	285,00 gal Zn
M 10	x	100	S	100	345,00 gal Zn
M 10	x	110	S	100	500,00 gal Zn

M 10	x	120	S	100	560,00 gal Zn
M 10	x	130	S	50	660,00 gal Zn
M 10	x	140	S	50	760,00 gal Zn
M 10	x	150	S	50	1070,00 gal Zn
M 10	x	160	S	50	1180,00 gal Zn
M 12	x	20	S	100	78,00 gal Zn
M 12	x	25	S	100	68,00 gal Zn
M 12	x	30	S	100	69,00 gal Zn
M 12	x	35	S	100	77,00 gal Zn
M 12	x	40	S	100	81,00 gal Zn
M 12	x	45	S	100	91,00 gal Zn
M 12	x	50	S	100	99,00 gal Zn
M 12	x	55	S	100	111,00 gal Zn
M 12	x	60	S	100	171,00 gal Zn
M 12	x	65	S	100	229,00 gal Zn
M 12	x	70	S	50	260,00 gal Zn
M 12	x	80	S	50	300,00 gal Zn
M 12	x	90	S	50	350,00 gal Zn
M 12	x	100	S	50	410,00 gal Zn
M 12	x	110	S	50	465,00 gal Zn
M 12	x	120	S	50	500,00 gal Zn
M 12	x	130	S	50	640,00 gal Zn
M 12	x	140	S	50	700,00 gal Zn
M 12	x	150	S	50	770,00 gal Zn
M 12	x	160	S	50	1460,00 gal Zn
M 12	x	180	S	50	1530,00 gal Zn
M 12	x	200	S	50	1600,00 gal Zn
M 14	x	30	S	50	390,00 gal Zn
M 14	x	35	S	50	390,00 gal Zn
M 14	x	40	S	50	385,00 gal Zn
M 14	x	45	S	50	415,00 gal Zn
M 14	x	50	S	50	415,00 gal Zn
M 14	x	55	S	50	420,00 gal Zn
M 14	x	60	S	50	420,00 gal Zn
M 16	x	20	S	50	570,00 gal Zn
M 16	x	25	S	50	580,00 gal Zn
M 16	x	30	S	50	170,00 gal Zn
M 16	x	35	S	50	177,00 gal Zn
M 16	x	40	S	50	176,00 gal Zn
M 16	x	45	S	50	189,00 gal Zn
M 16	x	50	S	50	193,00 gal Zn
M 16	x	55	S	50	325,00 gal Zn
M 16	x	60	S	50	195,00 gal Zn
M 16	x	65	S	25	390,00 gal Zn
M 16	x	70	S	25	445,00 gal Zn
M 16	x	80	S	25	475,00 gal Zn
M 16	x	90	S	25	500,00 gal Zn
M 16	x	100	S	25	550,00 gal Zn
M 16	x	110	S	25	760,00 gal Zn
M 16	x	120	S	25	830,00 gal Zn
M 16	x	130	S	25	970,00 gal Zn
M 16	x	140	S	25	1140,00 gal Zn
M 16	x	150	S	25	1210,00 gal Zn
M 16	x	160	S	25	1340,00 gal Zn
M 16	x	180	S	25	1480,00 gal Zn
M 16	x	200	S	25	1750,00 gal Zn
M 20	x	35	S	25	660,00 gal Zn
M 20	x	40	S	25	640,00 gal Zn
M 20	x	45	S	25	670,00 gal Zn
M 20	x	50	S	25	680,00 gal Zn
M 20	x	55	S	25	770,00 gal Zn
M 20	x	60	S	25	770,00 gal Zn
M 20	x	70	S	25	830,00 gal Zn
M 20	x	80	S	25	910,00 gal Zn
M 20	x	90	S	25	1130,00 gal Zn
M 20	x	100	S	25	1190,00 gal Zn
M 20	x	110	S	25	1270,00 gal Zn
M 20	x	120	S	25	1430,00 gal Zn
M 20	x	130	S	25	1520,00 gal Zn
M 20	x	140	S	25	1570,00 gal Zn
M 20	x	150	S	25	1740,00 gal Zn
M 20	x	160	S	10	2100,00 gal Zn
M 20	x	180	S	10	2320,00 gal Zn
M 20	x	200	S	10	2460,00 gal Zn
M 24	x	40	S	25	1250,00 gal Zn

Abmessungen	VE	Stück	€/100/Obf.
M 24 x 50	S	25	1340,00 gal Zn
M 24 x 60	S	25	1450,00 gal Zn
M 24 x 70	S	25	1510,00 gal Zn
M 24 x 80	S	25	1620,00 gal Zn
M 24 x 90	S	1	1690,00 gal Zn
M 24 x 100	S	1	1800,00 gal Zn

ISO	10642.316
10642	08.8 galv. verz. 8 DiSP*

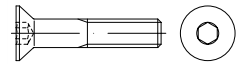

Senkschrauben mit Innensechskant

Ø > M 20: Kopfgeometrie nach DIN 7991, einige Fabrikate Gewinde bis Kopf, * < M 6 Mindestschichtdicke 5µm, Korrosionsbeständigkeit NSS: 72h WR, 120h RR

Achtung! Schrauben nur eingeschränkt belastbar.

Maße → **TI-14** Korrosionsschutz → **TI-228**
 Werkstoffeigensch. → **TI-232** Anziehmomente → **TI-246**

Rostfrei → **S. 587**

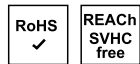

M 4 x 10	S	500	35,00 gal ZnDi
M 4 x 12	S	500	35,50 gal ZnDi
M 4 x 16	S	500	40,50 gal ZnDi
M 5 x 10	S	500	21,30 gal ZnDi
M 5 x 12	S	500	23,00 gal ZnDi
M 5 x 16	S	500	24,00 gal ZnDi
M 5 x 20	S	500	24,90 gal ZnDi
M 6 x 10	S	500	24,00 gal ZnDi
M 6 x 12	S	500	21,60 gal ZnDi
M 6 x 16	S	500	21,30 gal ZnDi
M 6 x 20	S	500	22,80 gal ZnDi
M 6 x 25	S	500	26,00 gal ZnDi
M 8 x 12	S	200	52,00 gal ZnDi
M 8 x 16	S	200	34,00 gal ZnDi
M 8 x 20	S	200	30,50 gal ZnDi
M 8 x 25	S	200	32,50 gal ZnDi
M 8 x 30	S	200	36,00 gal ZnDi
M 8 x 35	S	200	41,50 gal ZnDi
M 8 x 40	S	200	43,50 gal ZnDi
M 10 x 12	S	200	188,00 gal ZnDi
M 10 x 20	S	200	67,00 gal ZnDi
M 10 x 25	S	200	68,00 gal ZnDi
M 10 x 30	S	200	71,00 gal ZnDi
M 10 x 35	S	100	81,00 gal ZnDi
M 10 x 40	S	100	82,00 gal ZnDi
M 12 x 20	S	100	97,00 gal ZnDi
M 12 x 25	S	100	85,00 gal ZnDi
M 12 x 30	S	100	87,00 gal ZnDi
M 12 x 35	S	100	96,00 gal ZnDi
M 12 x 40	S	100	101,00 gal ZnDi
M 12 x 50	S	100	107,00 gal ZnDi

Abmessungen	VE	Stück	€/100/Obf.
~ISO	10642.814		
10642	08.8		ISR
galvanisch verzinkt			

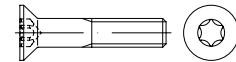

Senkschrauben, ISR = Innensechsrund

~ISO 14581

Achtung! Schrauben nur eingeschränkt belastbar.

Maße → **TI-14** Korrosionsschutz → **TI-228**
 Werkstoffeigensch. → **TI-232** Anziehmomente → **TI-246**

Weitere Abmessung mit ISR → ISO 14581

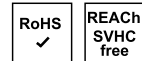

M 4 x 8-T20	S	500	30,50 gal Zn
M 4 x 10-T20	S	500	31,00 gal Zn
M 4 x 12-T20	S	500	31,00 gal Zn
M 4 x 16-T20	S	500	35,50 gal Zn
M 4 x 20-T20	S	500	36,00 gal Zn
M 4 x 22-T20	S	500	38,00 gal Zn
M 4 x 25-T20	S	500	37,00 gal Zn
M 5 x 8-T25	S	500	18,20 gal Zn
M 5 x 10-T25	S	500	19,00 gal Zn
M 5 x 12-T25	S	500	20,10 gal Zn
M 5 x 16-T25	S	500	20,80 gal Zn
M 5 x 20-T25	S	500	21,60 gal Zn
M 5 x 25-T25	S	500	25,50 gal Zn
M 6 x 10-T30	S	500	20,80 gal Zn
M 6 x 12-T30	S	500	18,90 gal Zn
M 6 x 16-T30	S	500	18,70 gal Zn
M 6 x 20-T30	S	500	20,20 gal Zn
M 6 x 25-T30	S	500	22,50 gal Zn
M 6 x 30-T30	S	200	24,90 gal Zn
M 6 x 35-T30	S	200	27,50 gal Zn
M 8 x 16-T40	S	200	30,00 gal Zn
M 8 x 20-T40	S	200	27,00 gal Zn
M 8 x 25-T40	S	200	29,00 gal Zn
M 8 x 30-T40	S	200	32,00 gal Zn

Abmessungen	VE	Stück	€/100/Obf.
ISO	10642.100		
10642	010.9		

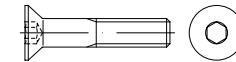

Senkschrauben mit Innensechskant

Ø > M 20: Kopfgeometrie nach DIN 7991, einige Fabrikate mit Gewinde bis Kopf

Achtung! Schrauben nur eingeschränkt belastbar.

Maße → **TI-14** Korrosionsschutz → **TI-228**
 Werkstoffeigensch. → **TI-232** Anziehmomente → **TI-246**

Rostfrei → **S. 587**

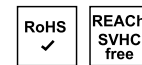

M 3 x 6	S	500	62,00
M 3 x 8	S	500	37,00
M 3 x 10	S	500	31,50
M 3 x 12	S	500	31,50
M 3 x 16	S	500	31,50
M 3 x 20	S	500	40,50
M 3 x 25	S	500	39,50
M 3 x 30	S	500	42,50
M 4 x 6	S	500	43,50
M 4 x 8	S	500	35,50
M 4 x 10	S	500	27,50
M 4 x 12	S	500	27,50
M 4 x 14	S	500	31,00
M 4 x 16	S	500	31,00
M 4 x 20	S	500	32,00
M 4 x 25	S	500	35,50
M 4 x 30	S	500	40,00
M 4 x 35	S	500	46,00
M 4 x 40	S	500	77,00
M 5 x 8	S	500	31,50
M 5 x 10	S	500	16,20
M 5 x 12	S	500	17,30
M 5 x 14	S	500	31,00
M 5 x 16	S	500	17,80
M 5 x 18	S	500	18,30
M 5 x 20	S	500	18,30
M 5 x 22	S	500	43,50
M 5 x 25	S	500	21,20
M 5 x 30	S	500	22,50
M 5 x 35	S	200	47,00
M 5 x 40	S	200	47,00
M 5 x 45	S	200	55,00
M 5 x 50	S	200	56,00
M 6 x 8	S	500	58,00
M 6 x 10	S	500	17,80
M 6 x 12	S	500	15,90
M 6 x 14	S	500	27,00
M 6 x 16	S	500	15,50
M 6 x 18	S	500	16,50
M 6 x 20	S	500	16,50
M 6 x 22	S	500	58,00
M 6 x 25	S	500	18,30
M 6 x 30	S	500	20,10
M 6 x 35	S	200	24,20
M 6 x 40	S	200	48,50
M 6 x 45	S	200	49,00
M 6 x 50	S	200	55,00
M 6 x 55	S	200	68,00
M 6 x 60	S	200	68,00

Abmessungen	VE	Stück	€/100/Obf.
M 6 x 70	S	200	130,00
M 6 x 80	S	200	183,00
M 8 x 10	S	200	130,00
M 8 x 12	S	200	38,00
M 8 x 14	S	200	23,90
M 8 x 16	S	200	23,90
M 8 x 18	S	200	20,70
M 8 x 20	S	200	20,70
M 8 x 22	S	200	48,50
M 8 x 25	S	200	21,90
M 8 x 30	S	200	24,00
M 8 x 35	S	200	27,50
M 8 x 40	S	200	28,50
M 8 x 45	S	200	33,50
M 8 x 50	S	200	58,00
M 8 x 55	S	200	69,00
M 8 x 60	S	200	78,00
M 8 x 70	S	200	143,00
M 8 x 80	S	200	183,00
M 8 x 90	S	200	204,00
M 8 x 100	S	200	244,00
M 8 x 120	S	200	355,00
M 8 x 130	S	100	510,00
M 8 x 140	S	100	610,00
M 8 x 160	S	100	1020,00
M 10 x 12	S	200	143,00
M 10 x 16	S	200	55,00
M 10 x 18	S	200	47,50
M 10 x 20	S	200	47,50
M 10 x 25	S	200	48,00
M 10 x 30	S	200	49,50
M 10 x 35	S	100	57,00
M 10 x 40	S	100	57,00
M 10 x 45	S	100	61,00
M 10 x 50	S	100	80,00
M 10 x 55	S	100	90,00
M 10 x 60	S	100	124,00
M 10 x 70	S	100	158,00
M 10 x 80	S	100	170,00
M 10 x 90	S	100	255,00
M 10 x 100	S	100	305,00
M 10 x 110	S	100	460,00
M 10 x 120	S	50	510,00
M 10 x 130	S	50	610,00
M 10 x 140	S	50	710,00
M 10 x 150	S	50	1020,00
M 12 x 20	S	100	69,00
M 12 x 25	S	100	59,00
M 12 x 30	S	100	59,00
M 12 x 35	S	100	64,00
M 12 x 40	S	100	68,00
M 12 x 45	S	100	77,00
M 12 x 50	S	100	83,00
M 12 x 55	S	100	93,00
M 12 x 60	S	100	182,00
M 12 x 70	S	50	223,00
M 12 x 80	S	50	260,00
M 12 x 90	S	50	305,00
M 12 x 100	S	50	355,00
M 12 x 110	S	50	405,00
M 12 x 120	S	50	440,00
M 12 x 130	S	50	570,00
M 12 x 140	S	50	630,00
M 12 x 160	S	50	1380,00
M 12 x 180	S	50	1440,00
M 12 x 200	S	50	1500,00
M 14 x 30	S	50	365,00
M 14 x 35	S	50	365,00
M 14 x 40	S	50	355,00
M 14 x 45	S	50	380,00
M 14 x 50	S	50	380,00
M 14 x 55	S	50	400,00
M 14 x 60	S	50	400,00
M 14 x 80	S	50	400,00
M 16 x 20	S	50	550,00

Abmessungen	VE	Stück	€/100/Obf.
M 16 x 25	S	50	550,00
M 16 x 30	S	50	157,00
M 16 x 35	S	50	155,00
M 16 x 40	S	50	152,00
M 16 x 45	S	50	161,00
M 16 x 50	S	50	161,00
M 16 x 55	S	50	280,00
M 16 x 60	S	50	174,00
M 16 x 70	S	25	380,00
M 16 x 80	S	25	400,00
M 16 x 90	S	25	425,00
M 16 x 100	S	25	460,00
M 16 x 110	S	25	660,00
M 16 x 120	S	25	720,00
M 16 x 130	S	25	850,00
M 16 x 140	S	25	1000,00
M 16 x 180	S	25	1320,00
M 20 x 30	S	25	1220,00
M 20 x 35	S	25	610,00
M 20 x 40	S	25	580,00
M 20 x 45	S	25	610,00
M 20 x 50	S	25	610,00
M 20 x 55	S	25	690,00
M 20 x 60	S	25	690,00
M 20 x 70	S	25	730,00
M 20 x 80	S	25	800,00
M 20 x 90	S	25	1010,00
M 20 x 100	S	25	1050,00
M 20 x 110	S	25	1080,00
M 20 x 120	S	25	1220,00
M 20 x 130	S	25	1300,00
M 20 x 140	S	25	1330,00
M 20 x 150	S	25	1480,00
M 20 x 160	S	10	1790,00
M 20 x 170	S	10	1980,00
M 20 x 180	S	10	1980,00
M 20 x 200	S	1	2100,00
M 20 x 220	S	1	2430,00
M 20 x 240	S	1	2800,00
M 22 x 60	S	25	4250,00
M 22 x 80	S	25	4750,00
M 22 x 100	S	10	5300,00
M 24 x 40	S	25	1150,00
M 24 x 50	S	25	1220,00
M 24 x 60	S	25	1300,00
M 24 x 70	S	25	1350,00
M 24 x 80	S	25	1440,00
M 24 x 90	S	1	1480,00
M 24 x 100	S	1	1550,00
M 24 x 110	S	1	1950,00
M 24 x 120	S	1	2040,00
M 24 x 130	S	1	2260,00
M 24 x 140	S	1	2410,00
M 24 x 150	S	1	2550,00
M 24 x 160	S	1	2750,00
M 24 x 170	S	1	3100,00
M 24 x 180	S	1	3100,00

Abmessungen	VE	Stück	€/100/Obf.
M 24 x 200	S	1	3400,00
M 24 x 240	S	1	4750,00

ISO	10642.110
10642	010.9
	galvanisch verzinkt

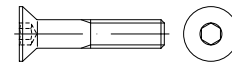

Senkschrauben mit Innensechskant

Ø > M 20: Kopfgeometrie nach DIN 7991, einige Fabrikate mit Gewinde bis Kopf, getempert

Achtung!

- Schrauben nur eingeschränkt belastbar.
- Warneinblender zu Wasserstoffversprödung beachten.

Maße → TI-14 Korrosionsschutz → TI-228
 Werkstoffeigensch. → TI-232 Anziehmomente → TI-246

Rostfrei → S. 587

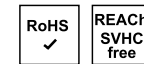

M 3 x 6	S	500	62,00 gal Zn
M 3 x 8	S	500	37,50 gal Zn
M 3 x 10	S	500	32,50 gal Zn
M 3 x 12	S	500	32,50 gal Zn
M 3 x 16	S	500	32,50 gal Zn
M 3 x 20	S	500	41,00 gal Zn
M 3 x 25	S	500	40,50 gal Zn
M 3 x 30	S	500	44,50 gal Zn
M 4 x 6	S	500	44,00 gal Zn
M 4 x 8	S	500	36,00 gal Zn
M 4 x 10	S	500	28,00 gal Zn
M 4 x 12	S	500	28,50 gal Zn
M 4 x 14	S	500	32,00 gal Zn
M 4 x 16	S	500	32,00 gal Zn
M 4 x 20	S	500	33,00 gal Zn
M 4 x 25	S	500	37,50 gal Zn
M 4 x 30	S	500	42,00 gal Zn
M 4 x 35	S	500	61,00 gal Zn
M 4 x 40	S	500	79,00 gal Zn
M 5 x 8	S	500	32,50 gal Zn
M 5 x 10	S	500	17,50 gal Zn
M 5 x 12	S	500	18,50 gal Zn
M 5 x 14	S	500	32,50 gal Zn
M 5 x 16	S	500	19,30 gal Zn
M 5 x 20	S	500	20,10 gal Zn
M 5 x 25	S	500	23,40 gal Zn
M 5 x 30	S	500	25,50 gal Zn
M 5 x 35	S	200	50,00 gal Zn
M 5 x 40	S	200	51,00 gal Zn
M 5 x 45	S	200	59,00 gal Zn
M 6 x 8	S	500	59,00 gal Zn
M 6 x 10	S	500	19,20 gal Zn
M 6 x 12	S	500	17,70 gal Zn
M 6 x 14	S	500	29,00 gal Zn
M 6 x 16	S	500	18,10 gal Zn
M 6 x 18	S	500	18,90 gal Zn
M 6 x 20	S	500	19,00 gal Zn
M 6 x 22	S	500	60,00 gal Zn
M 6 x 25	S	500	21,40 gal Zn
M 6 x 30	S	500	23,60 gal Zn
M 6 x 35	S	200	28,50 gal Zn
M 6 x 40	S	200	54,00 gal Zn
M 6 x 45	S	200	54,00 gal Zn
M 6 x 50	S	200	60,00 gal Zn

Wichtiger Hinweis!

Bei galvanischen Überzügen auf hochfesten und federharten Teilen (≥1000 N/mm² oder ≥320 HV) ist die Gefahr einer Wasserstoffversprödung (Sprödbruchgefahr) nicht mit Sicherheit auszuschließen (ISO 4042). Durch eine rechtzeitig eingeleitete thermische Nachbehandlung (Tempern) kann die Gefahr eines wasserstoffinduzierten Sprödbruchs im Regelfall verringert werden. Da aber ein Restrisiko nicht mit Sicherheit auszuschließen ist, erfolgen galvanische Überzüge auf derartigen Teilen nur auf ausdrücklichen Wunsch und auf Risiko des Auftraggebers.



Abmessungen	VE	Stück	€/100/Obf.
M 6 x 55	S	200	73,00 gal Zn
M 6 x 60	S	200	91,00 gal Zn
M 6 x 70	S	200	158,00 gal Zn
M 6 x 80	S	200	201,00 gal Zn
M 8 x 10	S	200	135,00 gal Zn
M 8 x 12	S	200	42,00 gal Zn
M 8 x 16	S	200	29,00 gal Zn
M 8 x 18	S	200	27,00 gal Zn
M 8 x 20	S	200	27,00 gal Zn
M 8 x 25	S	200	29,00 gal Zn
M 8 x 30	S	200	32,50 gal Zn
M 8 x 35	S	200	36,50 gal Zn
M 8 x 40	S	200	38,50 gal Zn
M 8 x 45	S	200	45,50 gal Zn
M 8 x 50	S	200	72,00 gal Zn
M 8 x 55	S	200	84,00 gal Zn
M 8 x 60	S	200	95,00 gal Zn
M 8 x 70	S	200	160,00 gal Zn
M 8 x 80	S	200	200,00 gal Zn
M 10 x 16	S	200	63,00 gal Zn
M 10 x 20	S	200	58,00 gal Zn
M 10 x 25	S	200	60,00 gal Zn
M 10 x 30	S	200	63,00 gal Zn
M 10 x 35	S	100	71,00 gal Zn
M 10 x 40	S	100	73,00 gal Zn
M 10 x 45	S	100	79,00 gal Zn
M 10 x 50	S	100	100,00 gal Zn
M 10 x 60	S	100	148,00 gal Zn
M 10 x 70	S	100	182,00 gal Zn
M 10 x 80	S	100	194,00 gal Zn
M 10 x 90	S	100	280,00 gal Zn
M 10 x 100	S	100	345,00 gal Zn
M 10 x 110	S	100	520,00 gal Zn
M 12 x 20	S	100	84,00 gal Zn
M 12 x 25	S	100	76,00 gal Zn
M 12 x 30	S	100	78,00 gal Zn
M 12 x 35	S	100	86,00 gal Zn
M 12 x 40	S	100	92,00 gal Zn
M 12 x 45	S	100	103,00 gal Zn
M 12 x 50	S	100	112,00 gal Zn
M 12 x 60	S	100	218,00 gal Zn
M 12 x 65	S	50	230,00 gal Zn
M 12 x 70	S	50	265,00 gal Zn
M 12 x 80	S	50	310,00 gal Zn
M 12 x 90	S	50	355,00 gal Zn
M 16 x 25	S	50	590,00 gal Zn
M 16 x 30	S	50	194,00 gal Zn
M 16 x 35	S	50	200,00 gal Zn
M 16 x 40	S	50	200,00 gal Zn
M 16 x 45	S	50	212,00 gal Zn
M 16 x 50	S	50	218,00 gal Zn
M 16 x 55	S	50	340,00 gal Zn
M 16 x 60	S	50	242,00 gal Zn
M 16 x 70	S	25	455,00 gal Zn
M 16 x 80	S	25	485,00 gal Zn
M 16 x 90	S	25	530,00 gal Zn
M 16 x 100	S	25	570,00 gal Zn
M 16 x 110	S	25	770,00 gal Zn
M 20 x 30	S	25	1290,00 gal Zn
M 20 x 35	S	25	680,00 gal Zn
M 20 x 40	S	25	650,00 gal Zn
M 20 x 50	S	25	700,00 gal Zn
M 20 x 60	S	25	790,00 gal Zn
M 20 x 70	S	25	850,00 gal Zn
M 20 x 80	S	25	940,00 gal Zn
M 20 x 90	S	25	560,00 gal Zn
M 20 x 100	S	25	1230,00 gal Zn
M 20 x 110	S	25	1260,00 gal Zn
M 20 x 120	S	25	1390,00 gal Zn
M 20 x 130	S	25	1480,00 gal Zn

Abmessungen	VE	Stück	€/100/Obf.
ISO			10642.397
10642			010.9
			flZnL480h

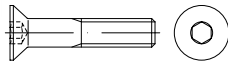

Senkschrauben mit Innensechskant

flZnL = int. Schmierstoff mit $\mu = 0,12 - 0,18$,
 Korrosionsbeständigkeit NSS: 480h RR,
 Chrom(VI)-frei,
 einige Fabrikate mit Gewinde bis Kopf

Achtung! Schrauben nur eingeschränkt belastbar.

Maße → **TI-14** Korrosionsschutz → **TI-230**
 Werkstoffeigensch. → **TI-232** Anziehmomente → **TI-246**

Rostfrei → **S. 587**

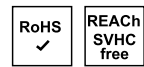

M 6 x 10	S	200	103,00 flZn
M 8 x 20	S	200	120,00 flZn
M 8 x 22	S	200	135,00 flZn
M 8 x 25	S	200	141,00 flZn
M 8 x 30	S	200	164,00 flZn
M 8 x 35	S	200	180,00 flZn
M 8 x 40	S	200	199,00 flZn
M 8 x 45	S	200	226,00 flZn
M 8 x 50	S	200	247,00 flZn
M 8 x 60	S	200	300,00 flZn
M 10 x 20	S	200	203,00 flZn
M 10 x 25	S	200	217,00 flZn
M 10 x 30	S	200	260,00 flZn
M 10 x 35	S	100	310,00 flZn
M 10 x 40	S	100	340,00 flZn
M 10 x 45	S	100	365,00 flZn
M 10 x 50	S	100	420,00 flZn
M 10 x 60	S	100	520,00 flZn
M 12 x 20	S	100	330,00 flZn
M 12 x 25	S	100	345,00 flZn
M 12 x 30	S	100	415,00 flZn
M 12 x 35	S	100	420,00 flZn
M 12 x 40	S	100	480,00 flZn
M 12 x 45	S	100	560,00 flZn
M 12 x 50	S	100	570,00 flZn
M 12 x 60	S	100	710,00 flZn
M 12 x 70	S	50	770,00 flZn
M 12 x 80	S	50	970,00 flZn
M 16 x 30	S	50	770,00 flZn
M 16 x 35	S	50	780,00 flZn
M 16 x 40	S	50	780,00 flZn
M 16 x 45	S	50	1000,00 flZn
M 16 x 50	S	50	1010,00 flZn
M 16 x 60	S	50	1020,00 flZn
M 16 x 70	S	25	1420,00 flZn
M 16 x 80	S	25	1520,00 flZn
M 16 x 100	S	25	1700,00 flZn

Abmessungen	VE	Stück	€/100/Obf.
DIN			11023.080
11023			Stahl
			galv. verz. 8 DiSP

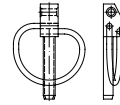

Klappstecker ("Klappsplinte"), mit drittem Loch für Sicherungskette

Maße → **TI-123**

Korrosionsschutz → **TI-228**

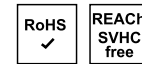

5	x	32	S	50	96,00 gal ZnDi
6	x	42	S	50	99,00 gal ZnDi
8	x	42	S	50	105,00 gal ZnDi
10	x	45	S	50	112,00 gal ZnDi
12	x	45	S	50	140,00 gal ZnDi
12	x	55	S	50	146,00 gal ZnDi
17	x	60	S	50	255,00 gal ZnDi

~DIN				
				11023.010
11023				Stahl
				galvanisch verzinkt

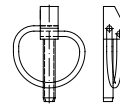

Klappstecker ("Klappsplinte"), ohne drittes Loch

Maße → **TI-123**

Korrosionsschutz → **TI-228**

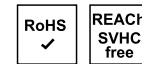

4,5	x	42	S	50	79,00 gal Zn
6	x	42	S	50	85,00 gal Zn
8	x	42	S	50	86,00 gal Zn
10	x	42	S	50	92,00 gal Zn

Artikel				
				88023.010
88023				Stahl
				galvanisch verzinkt

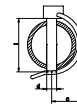

Rohrklappstecker

Maße → **TI-123**

Korrosionsschutz → **TI-228**

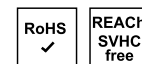

Splint \varnothing A x Splintlänge B X C

6	x	40	x	22	S	50	305,00 gal Zn
6	x	45	x	22	S	50	310,00 gal Zn
8	x	40	x	22	S	50	315,00 gal Zn

Abmessungen	VE	Stück	€/100/Obf.
8 x 50 x 25 S 50			325,00 gal Zn
10 x 50 x 25 S 50			335,00 gal Zn
10 x 60 x 32 S 25			345,00 gal Zn

DIN	11024.010
11024	Stahl galvanisch verzinkt

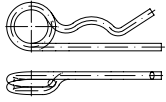

Federstecker

Maße → **TI-123**

Korrosionsschutz → **TI-228**

Rostfrei → **S. 589**



Für Bohrungs Ø (Tol.H13) / Wellen Ø von - bis

2,5 / 9 -11,2	S 200	31,50 gal Zn
3,2 / 11,3-14	S 200	42,00 gal Zn
4 / 14,1-20	S 100	57,00 gal Zn
5 / 20,1-26	S 100	89,00 gal Zn
6,3 / 26,1-34	S 50	146,00 gal Zn
7 / 34,1-45	S 25	221,00 gal Zn
8 / 45,1-56	S 25	280,00 gal Zn

~DIN	11024.012
11024	Stahl galvanisch verzinkt



Federstecker, einfach

~DIN 11024

Maße → **TI-123**

Korrosionsschutz → **TI-228**

Rostfrei → **S. 589**



Draht Ø

2	S 200	34,00 gal Zn
3	S 200	38,00 gal Zn
4	S 100	45,00 gal Zn
5	S 100	65,00 gal Zn
6	S 50	89,00 gal Zn
7	S 25	108,00 gal Zn
8	S 25	128,00 gal Zn

Abmessungen	VE	Stück	€/100/Obf.
ISO 12474.800			

12474 8.8

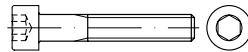

Zylinderschrauben mit Innensechskant, mit metrischem Feingewinde

Maße → **TI-12**

Anziehmomente → **TI-244**

Werkstoffeigensch. → **TI-232**

Normumstellung → **TI-6**

ISO 12474 → ersetzt DIN 912 Feingew. (austauschbar)

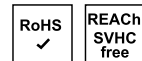

M 8	x 1	x 12	S 200	138,00
M 8	x 1	x 16	S 200	143,00
M 8	x 1	x 20	S 200	148,00
M 8	x 1	x 25	S 200	152,00
M 8	x 1	x 30	S 200	158,00
M 10	x 1	x 16	S 200	102,00
M 10	x 1	x 20	S 200	110,00
M 10	x 1,25	x 20	S 200	85,00
M 10	x 1	x 25	S 200	121,00
M 10	x 1,25	x 25	S 200	121,00
M 10	x 1	x 30	S 200	126,00
M 10	x 1,25	x 30	S 200	126,00
M 10	x 1	x 40	S 100	138,00
M 10	x 1,25	x 40	S 100	138,00
M 10	x 1	x 50	S 100	149,00
M 10	x 1	x 60	S 100	160,00
M 10	x 1	x 70	S 100	171,00
M 10	x 1	x 80	S 100	184,00
M 10	x 1	x 90	S 100	199,00
M 10	x 1	x 100	S 100	209,00
M 12	x 1,5	x 20	S 100	140,00
M 12	x 1,5	x 25	S 100	157,00
M 12	x 1,5	x 30	S 100	167,00
M 12	x 1,5	x 35	S 100	182,00
M 12	x 1,25	x 40	S 100	242,00
M 12	x 1,5	x 40	S 100	195,00
M 12	x 1,5	x 50	S 100	212,00
M 14	x 1,5	x 30	S 100	223,00
M 14	x 1,5	x 35	S 100	255,00
M 14	x 1,5	x 40	S 100	270,00
M 14	x 1,5	x 45	S 50	285,00
M 16	x 1,5	x 30	S 50	335,00
M 16	x 1,5	x 35	S 50	355,00
M 16	x 1,5	x 40	S 50	390,00
M 16	x 1,5	x 45	S 50	410,00
M 16	x 1,5	x 50	S 50	450,00
M 16	x 1,5	x 55	S 50	485,00
M 16	x 1,5	x 60	S 50	520,00
M 16	x 1,5	x 70	S 25	580,00

Abmessungen	VE	Stück	€/100/Obf.
ISO 12474.200			

12474 12.9

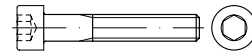

Zylinderschrauben mit Innensechskant, mit metrischem Feingewinde

Maße → **TI-12**

Anziehmomente → **TI-244**

Werkstoffeigensch. → **TI-232**

Normumstellung → **TI-6**

ISO 12474 → ersetzt DIN 912 Feingew. (austauschbar)

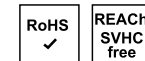

M 8	x 1,25	x 20	S 200	165,00
M 8	x 1,25	x 25	S 200	170,00
M 8	x 1	x 30	S 200	204,00
M 8	x 1	x 35	S 200	236,00
M 10	x 1,25	x 20	S 200	128,00
M 10	x 1,25	x 25	S 200	134,00
M 10	x 1	x 30	S 200	163,00
M 10	x 1,25	x 30	S 200	163,00
M 10	x 1	x 35	S 100	213,00
M 10	x 1	x 40	S 100	205,00
M 10	x 1,25	x 40	S 100	205,00
M 10	x 1	x 45	S 100	223,00
M 10	x 1	x 50	S 100	235,00
M 10	x 1,25	x 50	S 100	235,00
M 10	x 1	x 60	S 100	255,00
M 10	x 1,25	x 60	S 100	285,00
M 10	x 1	x 70	S 100	265,00
M 10	x 1	x 80	S 100	275,00
M 10	x 1	x 90	S 100	280,00
M 10	x 1	x 100	S 100	355,00
M 12	x 1,5	x 30	S 100	205,00
M 12	x 1,5	x 35	S 100	223,00
M 12	x 1,5	x 40	S 100	235,00
M 12	x 1,5	x 50	S 100	275,00
M 12	x 1,5	x 60	S 100	320,00
M 10	x 1,5	x 65	S 100	345,00
M 12	x 1,5	x 70	S 50	345,00
M 12	x 1,5	x 80	S 50	370,00
M 14	x 1,5	x 35	S 100	300,00
M 14	x 1,5	x 40	S 100	325,00
M 14	x 1,5	x 45	S 50	355,00
M 14	x 1,5	x 50	S 50	385,00
M 14	x 1,5	x 60	S 50	415,00
M 14	x 1,5	x 80	S 50	445,00
M 14	x 1,5	x 100	S 25	485,00
M 16	x 1,5	x 30	S 50	390,00
M 16	x 1,5	x 35	S 50	410,00
M 16	x 1,5	x 40	S 50	450,00
M 16	x 1,5	x 45	S 50	485,00
M 16	x 1,5	x 50	S 50	520,00
M 16	x 1,5	x 60	S 50	580,00
M 16	x 1,5	x 70	S 25	610,00
M 16	x 1,5	x 80	S 25	700,00
M 16	x 1,5	x 90	S 25	760,00
M 16	x 1,5	x 100	S 25	860,00
M 16	x 1,5	x 110	S 25	910,00
M 16	x 1,5	x 120	S 25	940,00
M 16	x 1,5	x 130	S 25	1010,00
M 16	x 1,5	x 140	S 25	1060,00
M 16	x 1,5	x 150	S 25	1110,00
M 16	x 1,5	x 160	S 25	1150,00
M 20	x 1,5	x 40	S 25	760,00
M 20	x 1,5	x 45	S 25	850,00
M 20	x 1,5	x 50	S 25	850,00

Abmessungen	VE	Stück	€/100/Obf.
M 20 x 1,5 x 55 S 25			940,00
M 20 x 1,5 x 60 S 25			940,00
M 20 x 1,5 x 70 S 25			1050,00
M 20 x 1,5 x 80 S 25			1140,00
M 20 x 1,5 x 90 S 25			1280,00
M 20 x 1,5 x 100 S 25			1410,00
M 24 x 2 x 50 S 25			1630,00
M 24 x 2 x 55 S 25			1190,00
M 24 x 2 x 55 S 25			1360,00
M 24 x 1,5 x 60 S 25			1980,00
M 24 x 2 x 60 S 25			1360,00
M 24 x 1,5 x 70 S 25			2230,00
M 24 x 2 x 70 S 25			1510,00
M 24 x 2 x 80 S 25			1670,00
M 24 x 2 x 90 S 10			1840,00
M 24 x 2 x 100 S 10			2040,00

Artikel 13023.130
13023 10
 zinklamellenbesch.

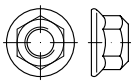

Sechskantmuttern mit Flansch, mit Klemmteil (Ganzmetallmutter) nach MBN 13023

Oberfläche gemäß DBL 9440.40

Zugehörige Flanschschrauben → Artikel 10105

Maße → **TI-69** Korrosionsschutz → **TI-230**
 Werkstoffeigensch. → **TI-232**

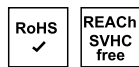

M 12 x 1,5 S 200	141,00 flZn
M 14 x 1,5 S 50	199,00 flZn
M 16 x 1,5 S 50	275,00 flZn

Artikel 13024.130
13024 10
 zinklamellenbesch.

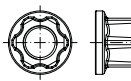

Leichtbaumuttern mit Flansch

Oberfläche gemäß DBL 9440.89

Maße → **TI-65** Korrosionsschutz → **TI-230**
 Werkstoffeigensch. → **TI-232**

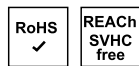

M 16 x 1,5 S 300	345,00 flZn
------------------	-------------

Abmessungen	VE	Stück	€/100/Obf.
-------------	----	-------	------------

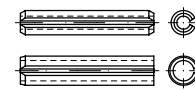
ISO 13337.000
13337 Federstahl

Spannstifte (-hülsen), geschlitzt, leichte Ausführung

Maße → **TI-122** Normumstellung → **TI-10**

ISO 13337 → ersetzt DIN 7346

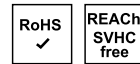

2 x 4 S 200	7,80
2 x 5 S 200	8,30
2 x 6 S 200	8,40
2 x 8 S 200	8,50
2 x 10 S 200	8,60
2 x 12 S 200	8,60
2 x 14 S 200	8,60
2 x 16 S 200	8,80
2 x 18 S 200	8,80
2 x 20 S 200	9,50
2 x 22 S 200	9,70
2 x 24 S 200	9,90
2 x 30 S 200	11,40
2,5 x 5 S 200	8,80
2,5 x 6 S 200	8,80
2,5 x 8 S 200	8,90
2,5 x 10 S 200	9,20
2,5 x 12 S 200	9,20
2,5 x 14 S 200	9,20
2,5 x 16 S 200	9,50
2,5 x 18 S 200	9,60
2,5 x 20 S 200	9,70
2,5 x 24 S 200	10,50
2,5 x 26 S 200	10,80
2,5 x 30 S 200	12,30
3 x 4 S 200	7,40
3 x 5 S 200	7,60
3 x 6 S 200	7,70
3 x 8 S 200	7,70
3 x 10 S 200	7,80
3 x 12 S 200	7,90
3 x 14 S 200	7,90
3 x 16 S 200	8,30
3 x 18 S 200	8,40
3 x 20 S 200	8,60
3 x 22 S 200	8,80
3 x 24 S 200	8,90
3 x 26 S 200	9,20
3 x 28 S 200	9,70
3 x 30 S 200	10,10
3 x 32 S 200	10,50
3 x 36 S 200	11,30
3 x 40 S 200	12,40
4 x 6 S 200	8,50
4 x 8 S 200	8,60
4 x 10 S 200	8,60
4 x 12 S 200	8,80
4 x 14 S 200	9,20
4 x 16 S 200	9,20
4 x 18 S 200	9,20
4 x 20 S 200	9,60
4 x 22 S 200	9,60
4 x 24 S 200	9,90
4 x 26 S 200	10,20
4 x 28 S 200	10,70
4 x 30 S 200	11,20
4 x 32 S 200	11,70
4 x 36 S 200	13,20
4 x 40 S 200	14,30
4 x 45 S 200	15,30
4 x 50 S 200	16,50
5 x 5 S 200	9,90
5 x 6 S 200	9,90
5 x 8 S 200	10,10
5 x 10 S 200	10,10
5 x 12 S 200	9,90
5 x 14 S 200	11,10
5 x 16 S 200	11,40
5 x 18 S 200	12,10
5 x 20 S 200	13,40
5 x 22 S 200	14,60
5 x 24 S 200	15,00
5 x 26 S 200	15,50
5 x 28 S 200	15,30
5 x 30 S 200	15,50
5 x 32 S 200	16,10
5 x 36 S 200	17,10
5 x 40 S 200	18,00
5 x 45 S 200	19,40
5 x 50 S 200	20,40
5 x 60 S 200	24,50
5 x 70 S 200	29,50
5 x 80 S 200	36,00
6 x 10 S 200	12,50
6 x 12 S 200	12,80
6 x 14 S 200	13,60
6 x 16 S 200	13,80
6 x 18 S 200	14,60
6 x 20 S 200	15,50
6 x 22 S 200	16,40
6 x 24 S 200	17,20
6 x 26 S 200	18,30
6 x 28 S 200	19,30
6 x 30 S 200	20,30
6 x 32 S 200	21,30
6 x 36 S 200	22,30
6 x 40 S 200	23,50
6 x 45 S 200	26,50
6 x 50 S 200	28,00
6 x 55 S 200	30,50
6 x 60 S 200	33,00
6 x 70 S 200	39,00
6 x 80 S 200	44,50
6 x 100 S 200	72,00
8 x 10 S 200	19,50
8 x 12 S 200	19,50
8 x 14 S 200	19,70
8 x 16 S 200	20,00
8 x 18 S 200	21,00
8 x 20 S 200	22,20
8 x 22 S 200	23,50
8 x 24 S 200	25,50
8 x 26 S 200	27,00
8 x 28 S 200	28,50
8 x 30 S 200	32,50
8 x 32 S 200	32,50
8 x 36 S 200	34,50
8 x 40 S 200	37,00
8 x 45 S 200	39,00
8 x 50 S 200	42,50
8 x 55 S 200	48,00
8 x 60 S 200	54,00
8 x 65 S 200	58,00
8 x 70 S 200	62,00
8 x 80 S 200	79,00
8 x 100 S 50	102,00
10 x 10 S 50	74,00
10 x 12 S 50	74,00
10 x 14 S 100	26,00
10 x 16 S 100	27,50

Abmessungen	VE	Stück	€/100/Obf.
10 x 20	S	100	32,50
10 x 22	S	100	34,00
10 x 24	S	100	37,00
10 x 26	S	100	39,00
10 x 30	S	100	43,00
10 x 36	S	100	51,00
10 x 40	S	100	54,00
10 x 45	S	50	63,00
10 x 50	S	50	69,00
10 x 60	S	50	83,00
10 x 70	S	50	97,00
10 x 80	S	50	111,00
10 x 90	S	50	124,00
10 x 100	S	50	138,00
12 x 10	S	50	310,00
12 x 16	S	50	265,00
12 x 20	S	50	148,00
12 x 24	S	50	157,00
12 x 26	S	50	160,00
12 x 28	S	50	164,00
12 x 30	S	50	157,00
12 x 32	S	50	174,00
12 x 36	S	50	174,00
12 x 40	S	50	181,00
12 x 45	S	50	184,00
12 x 50	S	50	189,00
12 x 55	S	50	197,00
12 x 60	S	50	204,00
12 x 65	S	50	216,00
12 x 70	S	50	223,00
12 x 80	S	50	239,00
12 x 100	S	25	580,00
13 x 10	S	25	300,00
13 x 12	S	25	290,00
13 x 14	S	25	285,00
13 x 16	S	25	275,00
13 x 18	S	25	275,00
13 x 20	S	50	157,00
13 x 22	S	50	160,00
13 x 24	S	50	164,00
13 x 26	S	50	167,00
13 x 28	S	50	171,00
13 x 30	S	50	177,00
13 x 36	S	50	184,00
13 x 40	S	50	200,00
13 x 50	S	50	197,00
13 x 70	S	50	232,00
16 x 10	S	25	335,00
16 x 12	S	25	320,00
16 x 14	S	25	310,00
16 x 16	S	25	300,00
16 x 18	S	25	295,00
16 x 20	S	50	197,00
16 x 22	S	50	200,00
16 x 24	S	50	204,00
16 x 26	S	50	206,00
16 x 28	S	50	210,00
16 x 30	S	50	216,00
16 x 32	S	50	221,00
16 x 36	S	50	223,00
16 x 40	S	50	227,00
16 x 45	S	50	230,00
16 x 50	S	50	233,00
16 x 55	S	50	236,00
16 x 60	S	25	249,00
16 x 70	S	25	285,00
16 x 120	S	25	950,00
21 x 30	S	50	440,00
21 x 36	S	25	445,00
21 x 40	S	25	475,00
21 x 45	S	25	510,00
21 x 50	S	25	510,00
21 x 60	S	25	560,00
21 x 85	S	25	730,00

Abmessungen	VE	Stück	€/100/Obf.
EN 14399 -4/-6			

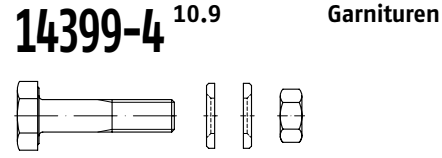

HV-Schrauben-Garnituren für HV-Verbindungen im Stahlbau, mit je 1 Mutter EN 14399-4 und je 2 Scheiben EN 14399-6

k-Klasse: K1, Fabrikat Peiner

Maße → TI-58 Anziehmomente → TI-248
Werkstoffeigensch. → TI-232

Abmessungen M 39-M 48 nach DAST-Richtlinie 021 auf Anfrage



M 12 x 30	S	1	161,00
M 12 x 35	S	1	168,00
M 12 x 40	S	1	170,00
M 12 x 45	S	1	175,00
M 12 x 50	S	1	180,00
M 12 x 55	S	1	187,00
M 12 x 60	S	1	192,00
M 12 x 65	S	1	223,00
M 12 x 70	S	1	230,00
M 12 x 75	S	1	420,00
M 12 x 80	S	1	420,00
M 12 x 85	S	1	590,00
M 12 x 90	S	1	590,00
M 12 x 100	S	1	680,00
M 16 x 40	S	1	260,00
M 16 x 45	S	1	270,00
M 16 x 50	S	1	280,00
M 16 x 55	S	1	290,00
M 16 x 60	S	1	295,00
M 16 x 65	S	1	305,00
M 16 x 70	S	1	315,00
M 16 x 75	S	1	330,00
M 16 x 80	S	1	335,00
M 16 x 85	S	1	360,00
M 16 x 90	S	1	360,00
M 16 x 95	S	1	430,00
M 16 x 100	S	1	430,00
M 16 x 105	S	1	680,00
M 16 x 110	S	1	680,00
M 16 x 115	S	1	760,00
M 16 x 125	S	1	1010,00
M 16 x 130	S	1	1010,00
M 16 x 140	S	1	1070,00
M 16 x 150	S	1	1200,00
M 20 x 40	S	1	455,00
M 20 x 45	S	1	455,00
M 20 x 50	S	1	445,00
M 20 x 55	S	1	445,00
M 20 x 60	S	1	455,00
M 20 x 65	S	1	470,00
M 20 x 70	S	1	480,00
M 20 x 75	S	1	490,00
M 20 x 80	S	1	500,00
M 20 x 85	S	1	530,00
M 20 x 90	S	1	530,00
M 20 x 95	S	1	540,00
M 20 x 100	S	1	540,00
M 20 x 105	S	1	580,00
M 20 x 110	S	1	580,00

Abmessungen	VE	Stück	€/100/Obf.
M 20 x 115	S	1	600,00
M 20 x 120	S	1	680,00
M 20 x 125	S	1	710,00
M 20 x 130	S	1	710,00
M 20 x 135	S	1	1040,00
M 20 x 140	S	1	1040,00
M 20 x 150	S	1	1370,00
M 20 x 160	S	1	1480,00
M 20 x 170	S	1	1590,00
M 20 x 180	S	1	1700,00
M 20 x 190	S	1	1820,00
M 20 x 200	S	1	2050,00
M 20 x 240	S	1	2550,00
M 20 x 250	S	1	2650,00
M 22 x 50	S	1	800,00
M 22 x 55	S	1	800,00
M 22 x 60	S	1	800,00
M 22 x 65	S	1	820,00
M 22 x 70	S	1	840,00
M 22 x 75	S	1	860,00
M 22 x 80	S	1	880,00
M 22 x 85	S	1	920,00
M 22 x 90	S	1	920,00
M 22 x 95	S	1	950,00
M 22 x 100	S	1	950,00
M 22 x 105	S	1	990,00
M 22 x 110	S	1	990,00
M 22 x 120	S	1	1040,00
M 24 x 50	S	1	720,00
M 24 x 55	S	1	720,00
M 24 x 60	S	1	710,00
M 24 x 65	S	1	710,00
M 24 x 65	S	1	730,00
M 24 x 75	S	1	740,00
M 24 x 80	S	1	750,00
M 24 x 85	S	1	780,00
M 24 x 90	S	1	780,00
M 24 x 95	S	1	810,00
M 24 x 100	S	1	810,00
M 24 x 105	S	1	830,00
M 24 x 110	S	1	830,00
M 24 x 115	S	1	870,00
M 24 x 120	S	1	870,00
M 24 x 125	S	1	900,00
M 24 x 130	S	1	900,00
M 24 x 135	S	1	940,00
M 24 x 140	S	1	1060,00
M 24 x 145	S	1	1100,00
M 24 x 150	S	1	1100,00
M 24 x 155	S	1	1540,00
M 24 x 160	S	1	1540,00
M 24 x 165	S	1	1650,00
M 24 x 170	S	1	1990,00
M 24 x 180	S	1	2130,00
M 24 x 190	S	1	2260,00
M 24 x 200	S	1	2390,00
M 24 x 210	S	1	2700,00
M 24 x 220	S	1	2850,00
M 27 x 65	S	1	1200,00
M 27 x 70	S	1	1210,00
M 27 x 75	S	1	1220,00
M 27 x 80	S	1	1240,00
M 27 x 85	S	1	1280,00
M 27 x 90	S	1	1280,00
M 27 x 95	S	1	1320,00
M 27 x 100	S	1	1320,00
M 27 x 105	S	1	1360,00
M 27 x 110	S	1	1360,00
M 27 x 115	S	1	1400,00
M 27 x 120	S	1	1400,00
M 27 x 125	S	1	1410,00
M 27 x 130	S	1	1410,00
M 27 x 135	S	1	1460,00
M 27 x 140	S	1	1460,00
M 27 x 145	S	1	1710,00

Abmessungen	VE	Stück	€/100/Obf.	Abmessungen	VE	Stück	€/100/Obf.	Abmessungen	VE	Stück	€/100/Obf.
M 27 x 150	S	1	1710,00	M 16 x 40	S	1	315,00 tzn	M 22 x 105	S	1	1180,00 tzn
M 27 x 160	S	1	1760,00	M 16 x 45	S	1	330,00 tzn	M 22 x 110	S	1	1180,00 tzn
M 27 x 165	S	1	2340,00	M 16 x 50	S	1	345,00 tzn	M 22 x 115	S	1	1240,00 tzn
M 27 x 170	S	1	2340,00	M 16 x 55	S	1	355,00 tzn	M 22 x 120	S	1	1240,00 tzn
M 27 x 180	S	1	3000,00	M 16 x 60	S	1	365,00 tzn	M 22 x 125	S	1	1290,00 tzn
M 27 x 190	S	1	3200,00	M 16 x 65	S	1	375,00 tzn	M 22 x 130	S	1	1290,00 tzn
M 27 x 200	S	1	3400,00	M 16 x 70	S	1	385,00 tzn	M 22 x 140	S	1	1850,00 tzn
M 30 x 80	S	1	1890,00	M 16 x 75	S	1	400,00 tzn	M 22 x 150	S	1	1990,00 tzn
M 30 x 85	S	1	1930,00	M 16 x 80	S	1	410,00 tzn	M 22 x 160	S	1	2140,00 tzn
M 30 x 90	S	1	1950,00	M 16 x 85	S	1	440,00 tzn	M 22 x 170	S	1	2330,00 tzn
M 30 x 95	S	1	1980,00	M 16 x 90	S	1	445,00 tzn	M 22 x 180	S	1	2480,00 tzn
M 30 x 100	S	1	2010,00	M 16 x 95	S	1	520,00 tzn	M 22 x 190	S	1	2650,00 tzn
M 30 x 105	S	1	2050,00	M 16 x 100	S	1	520,00 tzn	M 22 x 200	S	1	3000,00 tzn
M 30 x 110	S	1	2100,00	M 16 x 105	S	1	770,00 tzn	M 24 x 50	S	1	890,00 tzn
M 30 x 115	S	1	2140,00	M 16 x 110	S	1	780,00 tzn	M 24 x 55	S	1	890,00 tzn
M 30 x 120	S	1	2140,00	M 16 x 115	S	1	850,00 tzn	M 24 x 60	S	1	890,00 tzn
M 30 x 125	S	1	2200,00	M 16 x 120	S	1	1020,00 tzn	M 24 x 65	S	1	890,00 tzn
M 30 x 130	S	1	2200,00	M 16 x 125	S	1	1110,00 tzn	M 24 x 70	S	1	920,00 tzn
M 30 x 135	S	1	2250,00	M 16 x 130	S	1	1110,00 tzn	M 24 x 75	S	1	940,00 tzn
M 30 x 140	S	1	2250,00	M 16 x 140	S	1	1170,00 tzn	M 24 x 80	S	1	960,00 tzn
M 30 x 145	S	1	2600,00	M 16 x 150	S	1	1310,00 tzn	M 24 x 85	S	1	990,00 tzn
M 30 x 150	S	1	2600,00	M 16 x 160	S	1	1410,00 tzn	M 24 x 90	S	1	990,00 tzn
M 30 x 155	S	1	2650,00	M 16 x 170	S	1	1510,00 tzn	M 24 x 95	S	1	1020,00 tzn
M 30 x 160	S	1	2650,00	M 16 x 180	S	1	1610,00 tzn	M 24 x 100	S	1	1030,00 tzn
M 30 x 165	S	1	3300,00	M 16 x 190	S	1	1710,00 tzn	M 24 x 105	S	1	1060,00 tzn
M 30 x 170	S	1	3300,00	M 16 x 200	S	1	1920,00 tzn	M 24 x 110	S	1	1070,00 tzn
M 30 x 180	S	1	4050,00	M 16 x 210	S	1	2030,00 tzn	M 24 x 115	S	1	1100,00 tzn
M 30 x 190	S	1	4250,00	M 16 x 220	S	1	2360,00 tzn	M 24 x 120	S	1	1110,00 tzn
M 30 x 200	S	1	4400,00	M 20 x 40	S	1	550,00 tzn	M 24 x 125	S	1	1150,00 tzn
				M 20 x 45	S	1	550,00 tzn	M 24 x 130	S	1	1160,00 tzn
				M 20 x 50	S	1	540,00 tzn	M 24 x 135	S	1	1200,00 tzn
				M 20 x 55	S	1	550,00 tzn	M 24 x 140	S	1	1330,00 tzn
				M 20 x 60	S	1	560,00 tzn	M 24 x 145	S	1	1370,00 tzn
				M 20 x 65	S	1	580,00 tzn	M 24 x 150	S	1	1380,00 tzn
				M 20 x 70	S	1	600,00 tzn	M 24 x 155	S	1	1830,00 tzn
				M 20 x 75	S	1	610,00 tzn	M 24 x 165	S	1	1950,00 tzn
				M 20 x 80	S	1	630,00 tzn	M 24 x 170	S	1	2300,00 tzn
				M 20 x 85	S	1	660,00 tzn	M 24 x 175	S	1	2440,00 tzn
				M 20 x 90	S	1	660,00 tzn	M 24 x 180	S	1	2450,00 tzn
				M 20 x 95	S	1	670,00 tzn	M 24 x 190	S	1	2600,00 tzn
				M 20 x 100	S	1	680,00 tzn	M 24 x 200	S	1	2750,00 tzn
				M 20 x 105	S	1	720,00 tzn	M 24 x 210	S	1	3050,00 tzn
				M 20 x 110	S	1	730,00 tzn	M 24 x 220	S	1	3200,00 tzn
				M 20 x 115	S	1	750,00 tzn	M 24 x 230	S	1	3400,00 tzn
				M 20 x 120	S	1	830,00 tzn	M 24 x 240	S	1	3550,00 tzn
				M 20 x 125	S	1	860,00 tzn	M 24 x 250	S	1	3700,00 tzn
				M 20 x 130	S	1	860,00 tzn	M 24 x 260	S	1	3850,00 tzn
				M 20 x 135	S	1	1210,00 tzn	M 27 x 60	S	1	1450,00 tzn
				M 20 x 140	S	1	1210,00 tzn	M 27 x 65	S	1	1460,00 tzn
				M 20 x 145	S	1	1310,00 tzn	M 27 x 70	S	1	1470,00 tzn
				M 20 x 150	S	1	1550,00 tzn	M 27 x 75	S	1	1490,00 tzn
				M 20 x 155	S	1	1670,00 tzn	M 27 x 80	S	1	1520,00 tzn
				M 20 x 160	S	1	1670,00 tzn	M 27 x 85	S	1	1560,00 tzn
				M 20 x 165	S	1	1780,00 tzn	M 27 x 90	S	1	1570,00 tzn
				M 20 x 170	S	1	1790,00 tzn	M 27 x 95	S	1	1620,00 tzn
				M 20 x 180	S	1	1910,00 tzn	M 27 x 100	S	1	1620,00 tzn
				M 20 x 190	S	1	2030,00 tzn	M 27 x 105	S	1	1670,00 tzn
				M 20 x 200	S	1	2270,00 tzn	M 27 x 110	S	1	1680,00 tzn
				M 20 x 210	S	1	2400,00 tzn	M 27 x 115	S	1	1730,00 tzn
				M 20 x 220	S	1	2550,00 tzn	M 27 x 120	S	1	1740,00 tzn
				M 20 x 230	S	1	2650,00 tzn	M 27 x 125	S	1	1760,00 tzn
				M 20 x 240	S	1	2800,00 tzn	M 27 x 130	S	1	1760,00 tzn
				M 20 x 250	S	1	2950,00 tzn	M 27 x 135	S	1	1810,00 tzn
				M 20 x 260	S	1	3050,00 tzn	M 27 x 140	S	1	1820,00 tzn
				M 22 x 50	S	1	930,00 tzn	M 27 x 145	S	1	2080,00 tzn
				M 22 x 55	S	1	940,00 tzn	M 27 x 150	S	1	2080,00 tzn
				M 22 x 60	S	1	940,00 tzn	M 27 x 155	S	1	2140,00 tzn
				M 22 x 65	S	1	970,00 tzn	M 27 x 160	S	1	2150,00 tzn
				M 22 x 70	S	1	990,00 tzn	M 27 x 165	S	1	2750,00 tzn
				M 22 x 75	S	1	1020,00 tzn	M 27 x 170	S	1	2800,00 tzn
				M 22 x 80	S	1	1040,00 tzn	M 27 x 175	S	1	2950,00 tzn
				M 22 x 85	S	1	1080,00 tzn	M 27 x 180	S	1	3450,00 tzn
				M 22 x 90	S	1	1090,00 tzn	M 27 x 190	S	1	3650,00 tzn
				M 22 x 95	S	1	1130,00 tzn	M 27 x 200	S	1	3850,00 tzn
				M 22 x 100	S	1	1130,00 tzn	M 27 x 210	S	1	4250,00 tzn

EN 14399-4/1-6
14399-4 10.9 Garnituren
 feuerverzinkt

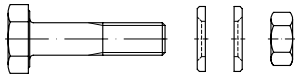

HV-Schrauben-Garnituren für HV-Verbindungen im Stahlbau, mit je 1 Mutter EN 14399-4 und je 2 Scheiben EN 14399-6

k-Klasse: K1,
 Gewindetoleranz der Bolzen 6g + tzn,
 Fabrikat Peiner oder Friedberg

Maße → TI-58 Korrosionsschutz → TI-231
 Werkstoffeigensch. → TI-232 Anziehmomente → TI-248

Abmessungen M 39-M 48 nach DAST-Richtlinie 021 auf Anfrage

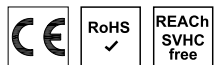

M 12 x 30	S	1	186,00 tzn
M 12 x 35	S	1	197,00 tzn
M 12 x 40	S	1	200,00 tzn
M 12 x 45	S	1	206,00 tzn
M 12 x 50	S	1	213,00 tzn
M 12 x 55	S	1	221,00 tzn
M 12 x 60	S	1	228,00 tzn
M 12 x 65	S	1	260,00 tzn
M 12 x 70	S	1	270,00 tzn
M 12 x 75	S	1	460,00 tzn
M 12 x 80	S	1	460,00 tzn
M 12 x 85	S	1	640,00 tzn
M 12 x 90	S	1	640,00 tzn
M 12 x 95	S	1	730,00 tzn
M 12 x 100	S	1	730,00 tzn
M 12 x 110	S	1	880,00 tzn
M 12 x 120	S	1	990,00 tzn
M 16 x 35	S	1	315,00 tzn

Abmessungen	VE	Stück	€/100/Obf.
M 27 x 220	S	1	4450,00 tzn
M 27 x 230	S	1	4650,00 tzn
M 27 x 240	S	1	4850,00 tzn
M 27 x 250	S	1	5100,00 tzn
M 27 x 260	S	1	5300,00 tzn
M 30 x 70	S	1	2200,00 tzn
M 30 x 75	S	1	2230,00 tzn
M 30 x 80	S	1	2250,00 tzn
M 30 x 85	S	1	2300,00 tzn
M 30 x 90	S	1	2330,00 tzn
M 30 x 95	S	1	2370,00 tzn
M 30 x 100	S	1	2400,00 tzn
M 30 x 105	S	1	2450,00 tzn
M 30 x 110	S	1	2550,00 tzn
M 30 x 115	S	1	2600,00 tzn
M 30 x 120	S	1	2600,00 tzn
M 30 x 125	S	1	2650,00 tzn
M 30 x 130	S	1	2650,00 tzn
M 30 x 135	S	1	2750,00 tzn
M 30 x 140	S	1	2750,00 tzn
M 30 x 145	S	1	3100,00 tzn
M 30 x 150	S	1	3100,00 tzn
M 30 x 155	S	1	3150,00 tzn
M 30 x 160	S	1	3150,00 tzn
M 30 x 165	S	1	3850,00 tzn
M 30 x 170	S	1	3850,00 tzn
M 30 x 180	S	1	4600,00 tzn
M 30 x 190	S	1	4800,00 tzn
M 30 x 200	S	1	5000,00 tzn
M 30 x 210	S	1	5500,00 tzn
M 30 x 220	S	1	5500,00 tzn
M 30 x 230	S	1	5900,00 tzn
M 30 x 240	S	1	5900,00 tzn
M 30 x 260	S	1	6400,00 tzn
M 36 x 100	S	1	6300,00 tzn
M 36 x 105	S	1	6500,00 tzn
M 36 x 110	S	1	6500,00 tzn
M 36 x 115	S	1	6700,00 tzn
M 36 x 120	S	1	6700,00 tzn
M 36 x 125	S	1	6800,00 tzn
M 36 x 130	S	1	6800,00 tzn
M 36 x 135	S	1	7000,00 tzn
M 36 x 140	S	1	7000,00 tzn
M 36 x 145	S	1	7100,00 tzn
M 36 x 150	S	1	7100,00 tzn
M 36 x 155	S	1	7300,00 tzn
M 36 x 160	S	1	7300,00 tzn
M 36 x 165	S	1	8900,00 tzn
M 36 x 170	S	1	8900,00 tzn
M 36 x 175	S	1	9100,00 tzn
M 36 x 180	S	1	9100,00 tzn
M 36 x 185	S	1	9300,00 tzn
M 36 x 190	S	1	9300,00 tzn
M 36 x 195	S	1	9500,00 tzn
M 36 x 200	S	1	9500,00 tzn
M 36 x 205	S	1	9600,00 tzn
M 36 x 210	S	1	9700,00 tzn
M 36 x 215	S	1	9800,00 tzn
M 36 x 220	S	1	9900,00 tzn
M 36 x 240	S	1	10200,00 tzn
M 36 x 250	S	1	10400,00 tzn
M 36 x 260	S	1	10600,00 tzn

Abmessungen	VE	Stück	€/100/Obf.
EN 14399.104			

14399-4 10.9

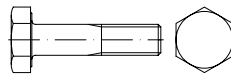

Sechskantschrauben mit großer SW für HV-Verbindungen im Stahlbau

Fabrikat Peiner

Maße → TI-58 Anziehmomente → TI-248
Werkstoffeigensch. → TI-232

Abmessungen M 36-M 64 nach DAST-Richtlinie 021 auf Anfrage



M 12 x 30	S	1	82,00
M 12 x 35	S	1	89,00
M 12 x 40	S	1	91,00
M 12 x 45	S	1	96,00
M 12 x 50	S	1	101,00
M 12 x 55	S	1	108,00
M 12 x 60	S	1	113,00
M 12 x 65	S	1	174,00
M 12 x 70	S	1	250,00
M 12 x 75	S	1	340,00
M 12 x 80	S	1	340,00
M 12 x 85	S	1	520,00
M 12 x 90	S	1	520,00
M 12 x 100	S	1	600,00
M 16 x 40	S	1	142,00
M 16 x 45	S	1	152,00
M 16 x 50	S	1	162,00
M 16 x 55	S	1	169,00
M 16 x 60	S	1	176,00
M 16 x 65	S	1	185,00
M 16 x 70	S	1	197,00
M 16 x 75	S	1	210,00
M 16 x 80	S	1	215,00
M 16 x 85	S	1	243,00
M 16 x 90	S	1	243,00
M 16 x 95	S	1	315,00
M 16 x 100	S	1	315,00
M 16 x 105	S	1	570,00
M 16 x 110	S	1	570,00
M 16 x 115	S	1	640,00
M 16 x 125	S	1	890,00
M 16 x 130	S	1	890,00
M 16 x 140	S	1	950,00
M 16 x 150	S	1	1080,00
M 20 x 40	S	1	285,00
M 20 x 45	S	1	285,00
M 20 x 50	S	1	275,00
M 20 x 55	S	1	275,00
M 20 x 60	S	1	285,00
M 20 x 65	S	1	300,00
M 20 x 70	S	1	310,00
M 20 x 75	S	1	320,00
M 20 x 80	S	1	330,00
M 20 x 85	S	1	355,00
M 20 x 90	S	1	355,00
M 20 x 95	S	1	370,00
M 20 x 100	S	1	370,00
M 20 x 105	S	1	410,00
M 20 x 110	S	1	410,00
M 20 x 115	S	1	430,00
M 20 x 120	S	1	510,00
M 20 x 125	S	1	530,00

Abmessungen	VE	Stück	€/100/Obf.
M 20 x 130	S	1	530,00
M 20 x 135	S	1	870,00
M 20 x 140	S	1	870,00
M 20 x 150	S	1	1200,00
M 20 x 160	S	1	1310,00
M 20 x 170	S	1	1420,00
M 20 x 180	S	1	1530,00
M 20 x 190	S	1	1650,00
M 20 x 200	S	1	1880,00
M 20 x 240	S	1	2350,00
M 20 x 250	S	1	2470,00
M 22 x 50	S	1	590,00
M 22 x 55	S	1	590,00
M 22 x 60	S	1	590,00
M 22 x 65	S	1	610,00
M 22 x 70	S	1	630,00
M 22 x 75	S	1	650,00
M 22 x 80	S	1	670,00
M 22 x 85	S	1	710,00
M 22 x 90	S	1	710,00
M 22 x 95	S	1	740,00
M 22 x 100	S	1	740,00
M 22 x 105	S	1	780,00
M 22 x 110	S	1	780,00
M 22 x 120	S	1	840,00
M 24 x 50	S	1	455,00
M 24 x 55	S	1	455,00
M 24 x 60	S	1	445,00
M 24 x 65	S	1	445,00
M 24 x 70	S	1	465,00
M 24 x 75	S	1	475,00
M 24 x 80	S	1	490,00
M 24 x 85	S	1	520,00
M 24 x 90	S	1	520,00
M 24 x 95	S	1	550,00
M 24 x 100	S	1	550,00
M 24 x 105	S	1	570,00
M 24 x 110	S	1	570,00
M 24 x 115	S	1	610,00
M 24 x 120	S	1	610,00
M 24 x 125	S	1	640,00
M 24 x 130	S	1	640,00
M 24 x 135	S	1	670,00
M 24 x 140	S	1	800,00
M 24 x 145	S	1	840,00
M 24 x 150	S	1	840,00
M 24 x 155	S	1	1280,00
M 24 x 160	S	1	1280,00
M 24 x 165	S	1	1390,00
M 24 x 170	S	1	1730,00
M 24 x 180	S	1	1870,00
M 24 x 190	S	1	2000,00
M 24 x 200	S	1	2130,00
M 24 x 210	S	1	2420,00
M 24 x 220	S	1	2600,00
M 27 x 65	S	1	770,00
M 27 x 70	S	1	770,00
M 27 x 75	S	1	780,00
M 27 x 80	S	1	810,00
M 27 x 85	S	1	840,00
M 27 x 90	S	1	840,00
M 27 x 95	S	1	880,00
M 27 x 100	S	1	880,00
M 27 x 105	S	1	920,00
M 27 x 110	S	1	920,00
M 27 x 115	S	1	970,00
M 27 x 120	S	1	970,00
M 27 x 125	S	1	980,00
M 27 x 130	S	1	980,00
M 27 x 135	S	1	1030,00
M 27 x 140	S	1	1030,00
M 27 x 145	S	1	1280,00
M 27 x 150	S	1	1280,00
M 27 x 160	S	1	1330,00
M 27 x 165	S	1	1910,00

Abmessungen	VE	Stück	€/100/Obf.
M 27 x 170	S	1	1910,00
M 27 x 180	S	1	2600,00
M 27 x 190	S	1	2750,00
M 27 x 200	S	1	2950,00
M 30 x 80	S	1	1070,00
M 30 x 85	S	1	1110,00
M 30 x 90	S	1	1130,00
M 30 x 95	S	1	1160,00
M 30 x 100	S	1	1190,00
M 30 x 105	S	1	1230,00
M 30 x 110	S	1	1280,00
M 30 x 115	S	1	1320,00
M 30 x 120	S	1	1320,00
M 30 x 125	S	1	1380,00
M 30 x 130	S	1	1380,00
M 30 x 135	S	1	1430,00
M 30 x 140	S	1	1430,00
M 30 x 145	S	1	1770,00
M 30 x 150	S	1	1770,00
M 30 x 155	S	1	1830,00
M 30 x 160	S	1	1830,00
M 30 x 165	S	1	2460,00
M 30 x 170	S	1	2460,00
M 30 x 180	S	1	3250,00
M 30 x 190	S	1	3400,00
M 30 x 200	S	1	3600,00

EN 14399.*
14399-4 10.9
 feuerverzinkt

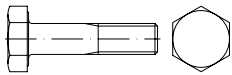

Sechskantschrauben mit großer SW für HV-Verbindungen im Stahlbau

Gewindetoleranz 6g + tZn,
 *Fabrikat Peiner = 124, Fabrikat Friedberg = 125

Maße → TI-58 Korrosionsschutz → TI-231
 Werkstoffeigensch. → TI-232 Anziehmomente → TI-248

Abmessungen M 39-M 64 nach DAST-Richtlinie 021 auf Anfrage

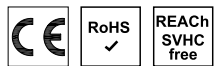

M 12 x 30	S	1	95,00 tZn
M 12 x 35	S	1	106,00 tZn
M 12 x 40	S	1	109,00 tZn
M 12 x 45	S	1	115,00 tZn
M 12 x 50	S	1	122,00 tZn
M 12 x 55	S	1	130,00 tZn
M 12 x 60	S	1	137,00 tZn
M 12 x 65	S	1	168,00 tZn
M 12 x 70	S	1	177,00 tZn
M 12 x 75	S	1	370,00 tZn
M 12 x 80	S	1	370,00 tZn
M 12 x 85	S	1	550,00 tZn
M 12 x 90	S	1	550,00 tZn
M 12 x 95	S	1	640,00 tZn
M 12 x 100	S	1	640,00 tZn
M 12 x 110	S	1	790,00 tZn
M 12 x 120	S	1	900,00 tZn
M 12 x 130	S	1	1010,00 tZn
M 16 x 35	S	1	174,00 tZn
M 16 x 40	S	1	175,00 tZn
M 16 x 45	S	1	188,00 tZn
M 16 x 50	S	1	201,00 tZn
M 16 x 55	S	1	211,00 tZn
M 16 x 60	S	1	221,00 tZn

Abmessungen	VE	Stück	€/100/Obf.
M 16 x 65	S	1	231,00 tZn
M 16 x 70	S	1	245,00 tZn
M 16 x 75	S	1	260,00 tZn
M 16 x 80	S	1	270,00 tZn
M 16 x 85	S	1	300,00 tZn
M 16 x 90	S	1	305,00 tZn
M 16 x 95	S	1	375,00 tZn
M 16 x 100	S	1	380,00 tZn
M 16 x 105	S	1	630,00 tZn
M 16 x 110	S	1	640,00 tZn
M 16 x 115	S	1	710,00 tZn
M 16 x 120	S	1	880,00 tZn
M 16 x 125	S	1	970,00 tZn
M 16 x 130	S	1	970,00 tZn
M 16 x 135	S	1	1020,00 tZn
M 16 x 140	S	1	1030,00 tZn
M 16 x 145	S	1	1120,00 tZn
M 16 x 150	S	1	1170,00 tZn
M 16 x 155	S	1	1210,00 tZn
M 16 x 160	S	1	1270,00 tZn
M 16 x 165	S	1	1310,00 tZn
M 16 x 170	S	1	1370,00 tZn
M 16 x 180	S	1	1470,00 tZn
M 16 x 190	S	1	1570,00 tZn
M 16 x 200	S	1	1780,00 tZn
M 16 x 210	S	1	1890,00 tZn
M 16 x 220	S	1	2220,00 tZn
M 20 x 40	S	1	340,00 tZn
M 20 x 45	S	1	340,00 tZn
M 20 x 50	S	1	335,00 tZn
M 20 x 55	S	1	340,00 tZn
M 20 x 60	S	1	355,00 tZn
M 20 x 65	S	1	370,00 tZn
M 20 x 70	S	1	385,00 tZn
M 20 x 75	S	1	400,00 tZn
M 20 x 80	S	1	420,00 tZn
M 20 x 85	S	1	445,00 tZn
M 20 x 90	S	1	450,00 tZn
M 20 x 95	S	1	465,00 tZn
M 20 x 100	S	1	470,00 tZn
M 20 x 105	S	1	520,00 tZn
M 20 x 110	S	1	520,00 tZn
M 20 x 115	S	1	540,00 tZn
M 20 x 120	S	1	630,00 tZn
M 20 x 125	S	1	650,00 tZn
M 20 x 130	S	1	660,00 tZn
M 20 x 135	S	1	1000,00 tZn
M 20 x 140	S	1	1010,00 tZn
M 20 x 145	S	1	1100,00 tZn
M 20 x 150	S	1	1340,00 tZn
M 20 x 155	S	1	1460,00 tZn
M 20 x 160	S	1	1460,00 tZn
M 20 x 165	S	1	1580,00 tZn
M 20 x 170	S	1	1580,00 tZn
M 20 x 180	S	1	1700,00 tZn
M 20 x 190	S	1	1820,00 tZn
M 20 x 200	S	1	2070,00 tZn
M 20 x 210	S	1	2190,00 tZn
M 20 x 220	S	1	2320,00 tZn
M 20 x 230	S	1	2450,00 tZn
M 20 x 240	S	1	2600,00 tZn
M 20 x 250	S	1	2700,00 tZn
M 20 x 260	S	1	2850,00 tZn
M 22 x 50	S	1	680,00 tZn
M 22 x 55	S	1	680,00 tZn
M 22 x 60	S	1	690,00 tZn
M 22 x 65	S	1	710,00 tZn
M 22 x 70	S	1	730,00 tZn
M 22 x 75	S	1	760,00 tZn
M 22 x 80	S	1	780,00 tZn
M 22 x 85	S	1	830,00 tZn
M 22 x 90	S	1	830,00 tZn
M 22 x 95	S	1	870,00 tZn
M 22 x 100	S	1	870,00 tZn
M 22 x 105	S	1	920,00 tZn

Abmessungen	VE	Stück	€/100/Obf.
M 22 x 110	S	1	920,00 tZn
M 22 x 115	S	1	980,00 tZn
M 22 x 120	S	1	990,00 tZn
M 22 x 125	S	1	1030,00 tZn
M 22 x 130	S	1	1040,00 tZn
M 22 x 135	S	1	1240,00 tZn
M 22 x 140	S	1	1590,00 tZn
M 22 x 145	S	1	1660,00 tZn
M 22 x 150	S	1	1740,00 tZn
M 22 x 155	S	1	1820,00 tZn
M 22 x 160	S	1	1890,00 tZn
M 22 x 165	S	1	1980,00 tZn
M 22 x 170	S	1	2080,00 tZn
M 22 x 175	S	1	2150,00 tZn
M 22 x 180	S	1	2220,00 tZn
M 22 x 190	S	1	2380,00 tZn
M 22 x 200	S	1	2750,00 tZn
M 24 x 50	S	1	560,00 tZn
M 24 x 55	S	1	570,00 tZn
M 24 x 60	S	1	560,00 tZn
M 24 x 65	S	1	570,00 tZn
M 24 x 70	S	1	590,00 tZn
M 24 x 75	S	1	610,00 tZn
M 24 x 80	S	1	630,00 tZn
M 24 x 85	S	1	660,00 tZn
M 24 x 90	S	1	660,00 tZn
M 24 x 95	S	1	690,00 tZn
M 24 x 100	S	1	700,00 tZn
M 24 x 105	S	1	730,00 tZn
M 24 x 110	S	1	740,00 tZn
M 24 x 115	S	1	780,00 tZn
M 24 x 120	S	1	780,00 tZn
M 24 x 125	S	1	820,00 tZn
M 24 x 130	S	1	830,00 tZn
M 24 x 135	S	1	870,00 tZn
M 24 x 140	S	1	1000,00 tZn
M 24 x 145	S	1	1040,00 tZn
M 24 x 150	S	1	1050,00 tZn
M 24 x 155	S	1	1510,00 tZn
M 24 x 160	S	1	1510,00 tZn
M 24 x 165	S	1	1620,00 tZn
M 24 x 170	S	1	1980,00 tZn
M 24 x 175	S	1	2120,00 tZn
M 24 x 180	S	1	2120,00 tZn
M 24 x 190	S	1	2260,00 tZn
M 24 x 200	S	1	2410,00 tZn
M 24 x 210	S	1	2750,00 tZn
M 24 x 220	S	1	2900,00 tZn
M 24 x 230	S	1	3050,00 tZn
M 24 x 240	S	1	3200,00 tZn
M 24 x 250	S	1	3350,00 tZn
M 24 x 260	S	1	3500,00 tZn
M 27 x 60	S	1	910,00 tZn
M 27 x 65	S	1	920,00 tZn
M 27 x 70	S	1	940,00 tZn
M 27 x 75	S	1	950,00 tZn
M 27 x 80	S	1	980,00 tZn
M 27 x 85	S	1	1030,00 tZn
M 27 x 90	S	1	1030,00 tZn
M 27 x 95	S	1	1080,00 tZn
M 27 x 100	S	1	1090,00 tZn
M 27 x 105	S	1	1130,00 tZn
M 27 x 110	S	1	1140,00 tZn
M 27 x 115	S	1	1190,00 tZn
M 27 x 120	S	1	1200,00 tZn
M 27 x 125	S	1	1220,00 tZn
M 27 x 130	S	1	1230,00 tZn
M 27 x 135	S	1	1280,00 tZn
M 27 x 140	S	1	1280,00 tZn
M 27 x 145	S	1	1540,00 tZn
M 27 x 150	S	1	1550,00 tZn
M 27 x 155	S	1	1610,00 tZn
M 27 x 160	S	1	1610,00 tZn
M 27 x 165	S	1	2220,00 tZn
M 27 x 170	S	1	2220,00 tZn

Abmessungen	VE	Stück	€/100/Obf.
M 27 x 175	S	1	2370,00 tZn
M 27 x 180	S	1	2900,00 tZn
M 27 x 190	S	1	3100,00 tZn
M 27 x 200	S	1	3300,00 tZn
M 27 x 210	S	1	3700,00 tZn
M 27 x 220	S	1	3950,00 tZn
M 27 x 230	S	1	4100,00 tZn
M 27 x 240	S	1	4300,00 tZn
M 27 x 250	S	1	4550,00 tZn
M 27 x 260	S	1	4750,00 tZn
M 27 x 280	S	1	5100,00 tZn
M 27 x 290	S	1	5900,00 tZn
M 30 x 70	S	1	1250,00 tZn
M 30 x 75	S	1	1270,00 tZn
M 30 x 80	S	1	1300,00 tZn
M 30 x 85	S	1	1350,00 tZn
M 30 x 90	S	1	1380,00 tZn
M 30 x 95	S	1	1420,00 tZn
M 30 x 100	S	1	1450,00 tZn
M 30 x 105	S	1	1500,00 tZn
M 30 x 110	S	1	1560,00 tZn
M 30 x 115	S	1	1610,00 tZn
M 30 x 120	S	1	1620,00 tZn
M 30 x 125	S	1	1690,00 tZn
M 30 x 130	S	1	1690,00 tZn
M 30 x 135	S	1	1760,00 tZn
M 30 x 140	S	1	1770,00 tZn
M 30 x 145	S	1	2110,00 tZn
M 30 x 150	S	1	2120,00 tZn
M 30 x 155	S	1	2190,00 tZn
M 30 x 160	S	1	2200,00 tZn
M 30 x 165	S	1	2900,00 tZn
M 30 x 170	S	1	2900,00 tZn
M 30 x 175	S	1	3350,00 tZn
M 30 x 180	S	1	3650,00 tZn
M 30 x 190	S	1	3850,00 tZn
M 30 x 200	S	1	4050,00 tZn
M 30 x 210	S	1	4500,00 tZn
M 30 x 220	S	1	4550,00 tZn
M 30 x 230	S	1	4950,00 tZn
M 30 x 240	S	1	4950,00 tZn
M 30 x 250	S	1	5100,00 tZn
M 30 x 260	S	1	5400,00 tZn
M 36 x 85	S	1	3700,00 tZn
M 36 x 90	S	1	3850,00 tZn
M 36 x 95	S	1	4000,00 tZn
M 36 x 100	S	1	4150,00 tZn
M 36 x 105	S	1	4300,00 tZn
M 36 x 110	S	1	4300,00 tZn
M 36 x 115	S	1	4500,00 tZn
M 36 x 120	S	1	4500,00 tZn
M 36 x 125	S	1	4650,00 tZn
M 36 x 130	S	1	4650,00 tZn
M 36 x 135	S	1	4800,00 tZn
M 36 x 140	S	1	4800,00 tZn
M 36 x 145	S	1	4950,00 tZn
M 36 x 150	S	1	4950,00 tZn
M 36 x 155	S	1	5100,00 tZn
M 36 x 160	S	1	5200,00 tZn
M 36 x 165	S	1	6800,00 tZn
M 36 x 170	S	1	6800,00 tZn
M 36 x 175	S	1	6900,00 tZn
M 36 x 180	S	1	7000,00 tZn
M 36 x 185	S	1	7100,00 tZn
M 36 x 190	S	1	7100,00 tZn
M 36 x 195	S	1	7300,00 tZn
M 36 x 200	S	1	7300,00 tZn
M 36 x 205	S	1	7400,00 tZn
M 36 x 210	S	1	7500,00 tZn
M 36 x 215	S	1	7600,00 tZn
M 36 x 220	S	1	7700,00 tZn
M 36 x 230	S	1	8000,00 tZn
M 36 x 240	S	1	8100,00 tZn
M 36 x 250	S	1	8300,00 tZn
M 36 x 260	S	1	8500,00 tZn

Abmessungen	VE	Stück	€/100/Obf.
EN		14399.106	

14399-4¹⁰

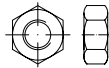

Sechskantmuttern mit großer SW für HV-Verbindungen im Stahlbau

Fabrikat Peiner

Maße → **TI-58** Werkstoffeigensch. → **TI-233**

Abmessungen M 39-M 64 nach DAST-Richtlinie 021 auf Anfrage

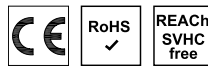

M 12	S	1	43,00
M 16	S	1	82,00
M 20	S	1	101,00
M 22	S	1	152,00
M 24	S	1	165,00
M 27	S	1	255,00
M 30	S	1	395,00
M 36	S	1	1230,00

EN	14399.*
14399-4¹⁰	feuerverzinkt

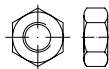

Sechskantmuttern mit großer SW für HV-Verbindungen im Stahlbau

Gewindetoleranz 6AZ, Abmessungen M 42 nach DAST-Richtlinie 021, *Fabrikat Peiner = 126, Fabrikat Friedberg = 127

Maße → **TI-58** Korrosionsschutz → **TI-231** Werkstoffeigensch. → **TI-233**

Abmessungen M 39-M 64 nach DAST-Richtlinie 021 auf Anfrage

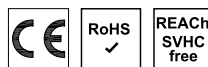

M 12	S	1	51,00 tZn
M 16	S	1	77,00 tZn
M 20	S	1	124,00 tZn
M 22	S	1	157,00 tZn
M 24	S	1	214,00 tZn
M 27	S	1	330,00 tZn
M 30	S	1	490,00 tZn
M 36	S	1	1400,00 tZn
M 42	S	1	3350,00 tZn

Abmessungen	VE	Stück	€/100/Obf.
EN		14399.004	

14399-6¹⁰ Stahl 300 HV



Scheiben, rund, für HV-Verbindungen im Stahlbau

Fabrikat Peiner, Ø 33 nicht CE

Maße → **TI-59**

Abmessungen M 39-M 64 nach DAST-Richtlinie 021 auf Anfrage

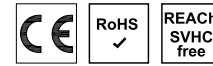

12 (13 x 24 x 3)	S	1	18,10
16 (17 x 30 x 4)	S	1	27,50
20 (21 x 37 x 4)	S	1	35,50
22 (23 x 39 x 4)	S	1	43,50
24 (25 x 44 x 4)	S	1	59,00
27 (28 x 50 x 5)	S	1	90,00
30 (31 x 56 x 5)	S	1	214,00
33 (34 x 60 x 5)	S	1	345,00
36 (37 x 66 x 6)	S	1	345,00

EN	14399.*
14399-6	Stahl 300 HV feuerverzinkt



Scheiben, rund, für HV-Verbindungen im Stahlbau

Abmessungen M 42 nach DAST-Richtlinie 021, *Fabrikat Peiner = 024, Fabrikat Friedberg = 025

Maße → **TI-59** Korrosionsschutz → **TI-231**

Abmessungen M 39-M 64 nach DAST-Richtlinie 021 auf Anfrage

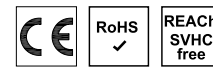

12 (13 x 24 x 3)	S	1	20,40 tZn
16 (17 x 30 x 4)	S	1	32,50 tZn
20 (21 x 37 x 4)	S	1	41,50 tZn
22 (23 x 39 x 4)	S	1	51,00 tZn
24 (25 x 44 x 4)	S	1	58,00 tZn
27 (28 x 50 x 5)	S	1	106,00 tZn
30 (31 x 56 x 5)	S	1	234,00 tZn
36 (37 x 66 x 6)	S	1	385,00 tZn
42 (43 x 78 x 8)	S	1	1410,00 tZn

Abmessungen	VE Stück	€/100/Obf.
EN 14399.034		
14399-6	Stahl 300 HV	tZn + geschmied



Scheiben, rund, für HV-Verbindungen im Stahlbau

zur Anwendung bei Montage mit Schraubenanzug über Kopf, Fabrikat Peiner

Maße → **TI-59**

- Abmessungen M 39-M 64 nach DAST-Richtlinie 021 auf Anfrage
- Jede Verpackungseinheit enthält die Dokumentation der Verfahrensprüfung

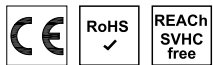

12 (13 x 24 x 3)	S	20	560,00 tZn
16 (17 x 30 x 4)	S	20	580,00 tZn
20 (21 x 37 x 4)	S	20	590,00 tZn
22 (23 x 39 x 4)	S	20	620,00 tZn
24 (25 x 44 x 4)	S	20	620,00 tZn
27 (28 x 50 x 5)	S	20	700,00 tZn
30 (31 x 56 x 5)	S	20	720,00 tZn
36 (37 x 66 x 6)	S	20	890,00 tZn

Artikel	88916.000
---------	-----------

88916 Stahl

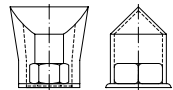

Sicherungsmuffe für Stahlbauerschraubungen, HV-Schrauben

Maße → **TI-59**

REACH → **TI-262**



M 12	S	10	2150,00
M 16	S	10	2150,00
M 20	S	10	2150,00
M 24	S	10	2350,00
M 27	S	5	2550,00
M 30	S	5	2650,00
M 36	S	5	4650,00

Abmessungen	VE Stück	€/100/Obf.
EN 14399.138		
14399-8	10.9	feuerverzinkt

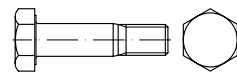

Sechskant-Passschrauben für HV-Verbindungen im Stahlbau, mit großer SW

Gewindetoleranz 6g + tZn

- Muttern → EN 14399-4
- Scheiben → EN 14399-6

Maße → **TI-58**
Werkstoffeigensch. → **TI-232**

Korrosionsschutz → **TI-231**
Anziehmomente → **TI-248**

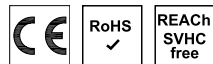

M 16 x 45	S	1	1190,00 tZn
M 16 x 50	S	1	1190,00 tZn
M 16 x 55	S	1	1250,00 tZn
M 16 x 60	S	1	1290,00 tZn
M 16 x 65	S	1	1340,00 tZn
M 16 x 70	S	1	1380,00 tZn
M 16 x 75	S	1	1430,00 tZn
M 16 x 80	S	1	1480,00 tZn
M 16 x 85	S	1	1530,00 tZn
M 16 x 90	S	1	1560,00 tZn
M 20 x 50	S	1	1220,00 tZn
M 20 x 55	S	1	1280,00 tZn
M 20 x 60	S	1	1320,00 tZn
M 20 x 65	S	1	1380,00 tZn
M 20 x 70	S	1	1420,00 tZn
M 20 x 75	S	1	1470,00 tZn
M 20 x 80	S	1	1520,00 tZn
M 20 x 85	S	1	1560,00 tZn
M 20 x 90	S	1	1610,00 tZn
M 20 x 95	S	1	1650,00 tZn
M 20 x 100	S	1	1700,00 tZn
M 20 x 105	S	1	1740,00 tZn
M 20 x 110	S	1	1740,00 tZn
M 20 x 115	S	1	1750,00 tZn
M 20 x 130	S	1	1930,00 tZn
M 22 x 55	S	1	1790,00 tZn
M 22 x 60	S	1	1860,00 tZn
M 22 x 65	S	1	1930,00 tZn
M 22 x 70	S	1	2000,00 tZn
M 22 x 75	S	1	2040,00 tZn
M 22 x 80	S	1	2110,00 tZn
M 22 x 85	S	1	2190,00 tZn
M 22 x 90	S	1	2260,00 tZn
M 22 x 95	S	1	2340,00 tZn
M 22 x 100	S	1	2420,00 tZn
M 22 x 110	S	1	2600,00 tZn
M 22 x 120	S	1	2700,00 tZn
M 24 x 60	S	1	1890,00 tZn
M 24 x 65	S	1	1960,00 tZn
M 24 x 70	S	1	2040,00 tZn
M 24 x 75	S	1	2080,00 tZn
M 24 x 80	S	1	2150,00 tZn
M 24 x 85	S	1	2230,00 tZn
M 24 x 90	S	1	2300,00 tZn
M 24 x 95	S	1	2380,00 tZn
M 24 x 100	S	1	2450,00 tZn
M 24 x 105	S	1	2550,00 tZn
M 24 x 110	S	1	2550,00 tZn
M 24 x 115	S	1	2700,00 tZn
M 24 x 120	S	1	2700,00 tZn
M 24 x 130	S	1	2850,00 tZn

Abmessungen	VE Stück	€/100/Obf.	
M 24 x 135	S	1	2950,00 tZn
M 24 x 140	S	1	2950,00 tZn
M 24 x 150	S	1	3100,00 tZn
M 27 x 65	S	1	2330,00 tZn
M 27 x 70	S	1	2750,00 tZn
M 27 x 75	S	1	2850,00 tZn
M 27 x 80	S	1	2900,00 tZn
M 27 x 85	S	1	3050,00 tZn
M 27 x 90	S	1	3100,00 tZn
M 27 x 95	S	1	3200,00 tZn
M 27 x 100	S	1	3300,00 tZn
M 27 x 105	S	1	3450,00 tZn
M 27 x 110	S	1	3450,00 tZn
M 27 x 115	S	1	3600,00 tZn
M 27 x 120	S	1	3650,00 tZn
M 27 x 130	S	1	3850,00 tZn
M 27 x 140	S	1	4100,00 tZn
M 27 x 150	S	1	4250,00 tZn
M 27 x 160	S	1	4350,00 tZn
M 27 x 180	S	1	4850,00 tZn
M 30 x 75	S	1	3250,00 tZn
M 30 x 80	S	1	3450,00 tZn
M 30 x 85	S	1	3650,00 tZn
M 30 x 90	S	1	3750,00 tZn
M 30 x 95	S	1	3850,00 tZn
M 30 x 100	S	1	3950,00 tZn
M 30 x 105	S	1	4150,00 tZn
M 30 x 110	S	1	4150,00 tZn
M 30 x 115	S	1	4250,00 tZn
M 30 x 120	S	1	4300,00 tZn
M 30 x 125	S	1	4450,00 tZn
M 30 x 130	S	1	4500,00 tZn
M 30 x 135	S	1	4600,00 tZn
M 30 x 140	S	1	4650,00 tZn
M 30 x 145	S	1	4750,00 tZn
M 30 x 150	S	1	4800,00 tZn

ISO	14579.810
14579	8.8
	galvanisch verzinkt

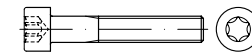

Zylinderschrauben mit Innensechsrund

Maße → **TI-12**

Korrosionsschutz → **TI-228**

Werkstoffeigensch. → **TI-232**

Anziehmomente → **TI-244**

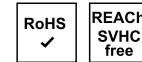

M 6 x 16	S	200	8,80 gal Zn
M 6 x 20	S	200	9,60 gal Zn
M 8 x 20	S	200	15,50 gal Zn
M 8 x 25	S	200	16,90 gal Zn
M 8 x 30	S	200	18,10 gal Zn
M 8 x 35	S	200	19,80 gal Zn

Abmessungen	VE Stück	€/100/Obf.
ISO 14581.410		
14581	04.8	galvanisch verzinkt

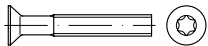

Senkschrauben mit Innensechsrund

Achtung! Schrauben nur eingeschränkt belastbar.

Maße → **TI-15** Korrosionsschutz → **TI-228**
 Werkstoffeigensch. → **TI-232** REACH → **TI-262**



M 3 x 4	S 2000	7,60 gal Zn
M 3 x 5	S 2000	7,60 gal Zn
M 3 x 6	S 2000	5,00 gal Zn
M 3 x 8	S 2000	2,65 gal Zn
M 3 x 10	S 2000	2,80 gal Zn
M 3 x 12	S 2000	2,85 gal Zn
M 3 x 16	S 2000	3,60 gal Zn
M 3 x 20	S 2000	3,80 gal Zn
M 3 x 25	S 2000	4,00 gal Zn
M 4 x 6	S 2000	6,90 gal Zn
M 4 x 8	S 2000	3,75 gal Zn
M 4 x 10	S 2000	3,90 gal Zn
M 4 x 12	S 2000	4,00 gal Zn
M 4 x 16	S 2000	4,45 gal Zn
M 4 x 20	S 2000	4,75 gal Zn
M 4 x 25	S 1000	5,50 gal Zn
M 4 x 30	S 1000	7,10 gal Zn
M 4 x 35	S 1000	8,90 gal Zn
M 4 x 40	S 1000	10,30 gal Zn
M 5 x 8	S 2000	9,80 gal Zn
M 5 x 10	S 2000	5,10 gal Zn
M 5 x 12	S 1000	5,30 gal Zn
M 5 x 16	S 1000	5,90 gal Zn
M 5 x 20	S 1000	6,60 gal Zn
M 5 x 25	S 1000	7,40 gal Zn
M 5 x 30	S 1000	9,40 gal Zn
M 5 x 35	S 500	10,40 gal Zn
M 5 x 40	S 500	11,20 gal Zn
M 5 x 45	S 500	13,10 gal Zn
M 5 x 50	S 500	18,20 gal Zn
M 6 x 10	S 1000	13,00 gal Zn
M 6 x 12	S 1000	7,60 gal Zn
M 6 x 16	S 1000	8,60 gal Zn
M 6 x 20	S 1000	9,50 gal Zn
M 6 x 25	S 500	10,60 gal Zn
M 6 x 30	S 500	12,10 gal Zn
M 6 x 35	S 500	14,10 gal Zn
M 6 x 40	S 500	15,80 gal Zn
M 6 x 50	S 200	21,10 gal Zn
M 6 x 60	S 200	25,50 gal Zn

Abmessungen	VE Stück	€/100/Obf.
ISO 14581.810		
14581	08.8	galvanisch verzinkt

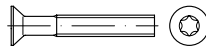

Senkschrauben mit Innensechsrund

Achtung! Schrauben nur eingeschränkt belastbar.

Maße → **TI-15** Korrosionsschutz → **TI-228**
 Werkstoffeigensch. → **TI-232**



M 4 x 8	S 500	30,50 gal Zn
M 4 x 10	S 500	31,00 gal Zn
M 4 x 12	S 500	31,00 gal Zn
M 4 x 16	S 500	35,50 gal Zn
M 4 x 20	S 500	36,00 gal Zn
M 4 x 25	S 500	37,00 gal Zn
M 5 x 8	S 500	18,20 gal Zn
M 5 x 10	S 500	19,00 gal Zn
M 5 x 12	S 500	20,10 gal Zn
M 5 x 16	S 500	20,80 gal Zn
M 5 x 20	S 500	21,60 gal Zn
M 5 x 25	S 500	25,50 gal Zn
M 6 x 10	S 500	20,80 gal Zn
M 6 x 12	S 500	18,90 gal Zn
M 6 x 16	S 500	18,70 gal Zn
M 6 x 20	S 500	20,20 gal Zn
M 6 x 25	S 500	22,50 gal Zn
M 6 x 30	S 200	24,90 gal Zn
M 6 x 35	S 200	27,50 gal Zn
M 8 x 16	S 200	30,00 gal Zn
M 8 x 20	S 200	27,00 gal Zn
M 8 x 25	S 200	29,00 gal Zn
M 8 x 30	S 200	32,00 gal Zn

Abmessungen	VE Stück	€/100/Obf.
ISO 14583.410		
14583	4.8	galvanisch verzinkt

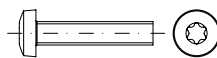

Flachkopfschrauben mit Innensechsrund

Maße → **TI-40** Korrosionsschutz → **TI-228**
 Werkstoffeigensch. → **TI-232** REACH → **TI-262**

Rostfrei → **S. 590**



M 2 x 4	S 2000	12,90 gal Zn
M 2 x 6	S 2000	9,10 gal Zn
M 2 x 8	S 2000	9,10 gal Zn
M 2 x 10	S 2000	9,20 gal Zn
M 2 x 12	S 2000	9,40 gal Zn
M 2 x 16	S 2000	9,50 gal Zn
M 2,5 x 4	S 2000	13,70 gal Zn

M 2,5 x 5	S 2000	13,70 gal Zn
M 2,5 x 6	S 2000	9,20 gal Zn
M 2,5 x 8	S 2000	9,20 gal Zn
M 2,5 x 10	S 2000	9,30 gal Zn
M 2,5 x 12	S 2000	9,40 gal Zn
M 2,5 x 16	S 2000	9,90 gal Zn
M 3 x 4	S 2000	11,20 gal Zn
M 3 x 4	K 200	14,10 gal Zn
M 3 x 5	S 2000	11,20 gal Zn
M 3 x 5	K 200	14,10 gal Zn
M 3 x 6	S 2000	8,60 gal Zn
M 3 x 6	K 200	11,50 gal Zn
M 3 x 8	S 2000	8,60 gal Zn
M 3 x 8	K 200	11,50 gal Zn
M 3 x 10	S 2000	8,80 gal Zn
M 3 x 10	K 200	11,70 gal Zn
M 3 x 12	S 2000	8,80 gal Zn
M 3 x 12	K 200	11,70 gal Zn
M 3 x 16	S 2000	8,90 gal Zn
M 3 x 16	K 200	11,80 gal Zn
M 3 x 20	S 2000	9,40 gal Zn
M 3 x 20	K 200	12,30 gal Zn
M 3 x 25	S 2000	9,70 gal Zn
M 3 x 25	K 200	12,60 gal Zn
M 3 x 30	S 1000	10,30 gal Zn
M 3 x 30	K 200	13,20 gal Zn
M 3 x 40	S 1000	11,80 gal Zn
M 3 x 40	K 200	14,70 gal Zn
M 4 x 5	S 2000	11,90 gal Zn
M 4 x 5	K 200	14,80 gal Zn
M 4 x 6	S 2000	8,90 gal Zn
M 4 x 6	K 200	11,80 gal Zn
M 4 x 8	S 2000	9,40 gal Zn
M 4 x 8	K 200	12,30 gal Zn
M 4 x 10	S 2000	9,60 gal Zn
M 4 x 10	K 200	12,50 gal Zn
M 4 x 12	S 2000	9,70 gal Zn
M 4 x 12	K 200	12,60 gal Zn
M 4 x 16	S 2000	10,30 gal Zn
M 4 x 16	K 200	13,20 gal Zn
M 4 x 20	S 2000	11,10 gal Zn
M 4 x 20	K 200	14,00 gal Zn
M 4 x 25	S 1000	11,70 gal Zn
M 4 x 25	K 200	14,60 gal Zn
M 4 x 30	S 1000	12,30 gal Zn
M 4 x 30	K 200	15,20 gal Zn
M 4 x 32	S 1000	10,40 gal Zn
M 4 x 35	S 1000	12,80 gal Zn
M 4 x 35	K 200	15,70 gal Zn
M 5 x 6	S 2000	11,10 gal Zn
M 5 x 6	K 200	14,00 gal Zn
M 5 x 8	S 2000	11,20 gal Zn
M 5 x 8	K 200	14,10 gal Zn
M 5 x 10	S 2000	11,40 gal Zn
M 5 x 10	K 200	14,30 gal Zn
M 5 x 12	S 1000	11,80 gal Zn
M 5 x 12	K 200	14,70 gal Zn
M 5 x 16	S 1000	12,50 gal Zn
M 5 x 16	K 200	15,40 gal Zn
M 5 x 18	S 1000	13,60 gal Zn
M 5 x 20	S 1000	13,60 gal Zn
M 5 x 20	K 200	16,50 gal Zn
M 5 x 25	S 1000	14,30 gal Zn
M 5 x 25	K 200	17,20 gal Zn
M 5 x 30	S 1000	15,00 gal Zn
M 5 x 30	K 200	18,00 gal Zn
M 6 x 10	S 1000	15,20 gal Zn
M 6 x 10	K 200	18,10 gal Zn
M 6 x 12	S 1000	15,40 gal Zn
M 6 x 12	K 200	18,30 gal Zn
M 6 x 16	S 1000	15,80 gal Zn
M 6 x 16	K 200	15,80 gal Zn
M 6 x 20	S 1000	16,70 gal Zn
M 6 x 20	K 200	19,70 gal Zn

Abmessungen	VE	Stück	€/100/Obf.
M 6 x 25	S	500	17,80 gal Zn
M 6 x 25	K	200	20,70 gal Zn
M 6 x 30	S	500	19,00 gal Zn
M 6 x 30	K	200	22,00 gal Zn

ISO 14585.013

14585 Stahl gehärtet Form C
galvanisch verzinkt

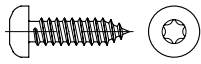

Flachkopf-Blehschrauben mit Innensechsrund, C = mit Spitze

Maße → **TI-46** Montage → **TI-251**
 Korrosionsschutz → **TI-228**
 Rostfrei → **S. 590**

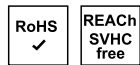

2,2 x 4,5-C	S	2000	10,30 gal Zn
2,2 x 6,5-C	S	2000	9,10 gal Zn
2,2 x 9,5-C	S	2000	10,90 gal Zn
2,2 x 13 -C	S	2000	11,80 gal Zn
2,2 x 16 -C	S	2000	13,30 gal Zn
2,9 x 6,5-C	S	2000	3,00 gal Zn
2,9 x 9,5-C	S	2000	2,70 gal Zn
2,9 x 13 -C	S	2000	2,80 gal Zn
2,9 x 16 -C	S	2000	2,90 gal Zn
2,9 x 19 -C	S	2000	4,25 gal Zn
2,9 x 22 -C	S	2000	5,30 gal Zn
2,9 x 25 -C	S	1000	5,70 gal Zn
3,5 x 9,5-C	S	1000	3,15 gal Zn
3,5 x 13 -C	S	1000	3,30 gal Zn
3,5 x 16 -C	S	1000	3,40 gal Zn
3,5 x 19 -C	S	1000	4,30 gal Zn
3,5 x 22 -C	S	1000	6,00 gal Zn
3,5 x 25 -C	S	500	6,30 gal Zn
3,5 x 32 -C	S	500	6,80 gal Zn
3,5 x 38 -C	S	500	7,70 gal Zn
3,5 x 45 -C	S	500	11,30 gal Zn
3,5 x 50 -C	S	500	12,30 gal Zn
3,9 x 9,5-C	S	1000	3,60 gal Zn
3,9 x 13 -C	S	1000	3,75 gal Zn
3,9 x 16 -C	S	1000	4,15 gal Zn
3,9 x 19 -C	S	1000	4,70 gal Zn
3,9 x 22 -C	S	500	6,20 gal Zn
3,9 x 25 -C	S	500	6,80 gal Zn
3,9 x 32 -C	S	500	7,20 gal Zn
3,9 x 38 -C	S	500	10,00 gal Zn
3,9 x 45 -C	S	500	10,20 gal Zn
3,9 x 50 -C	S	500	10,50 gal Zn
4,2 x 9,5-C	S	1000	3,90 gal Zn
4,2 x 13 -C	S	1000	3,95 gal Zn
4,2 x 16 -C	S	1000	4,45 gal Zn
4,2 x 19 -C	S	500	4,75 gal Zn
4,2 x 22 -C	S	500	6,60 gal Zn
4,2 x 25 -C	S	500	7,20 gal Zn
4,2 x 32 -C	S	500	7,30 gal Zn
4,2 x 38 -C	S	500	10,50 gal Zn
4,2 x 45 -C	S	500	11,90 gal Zn
4,2 x 50 -C	S	500	13,60 gal Zn
4,2 x 60 -C	S	500	23,20 gal Zn
4,2 x 70 -C	S	500	27,50 gal Zn
4,8 x 9,5-C	S	500	7,90 gal Zn
4,8 x 13 -C	S	500	5,60 gal Zn
4,8 x 16 -C	S	500	5,90 gal Zn
4,8 x 19 -C	S	500	6,70 gal Zn

Abmessungen	VE	Stück	€/100/Obf.
4,8 x 22 -C	S	500	7,20 gal Zn
4,8 x 25 -C	S	500	8,40 gal Zn
4,8 x 32 -C	S	250	9,60 gal Zn
4,8 x 38 -C	S	250	11,10 gal Zn
4,8 x 45 -C	S	250	15,00 gal Zn
4,8 x 50 -C	S	250	16,60 gal Zn
4,8 x 60 -C	S	250	26,50 gal Zn
4,8 x 70 -C	S	250	35,50 gal Zn
4,8 x 80 -C	S	250	42,50 gal Zn
4,8 x 90 -C	S	250	54,00 gal Zn
4,8 x 100 -C	S	250	62,00 gal Zn
5,5 x 13 -C	S	500	15,20 gal Zn
5,5 x 16 -C	S	500	12,80 gal Zn
5,5 x 19 -C	S	500	8,60 gal Zn
5,5 x 22 -C	S	500	15,40 gal Zn
5,5 x 25 -C	S	250	12,80 gal Zn
5,5 x 32 -C	S	250	14,70 gal Zn
5,5 x 38 -C	S	250	18,90 gal Zn
5,5 x 45 -C	S	250	20,40 gal Zn
5,5 x 50 -C	S	250	24,10 gal Zn
5,5 x 60 -C	S	250	45,50 gal Zn
5,5 x 70 -C	S	250	57,00 gal Zn
5,5 x 80 -C	S	250	68,00 gal Zn
5,5 x 90 -C	S	250	73,00 gal Zn
5,5 x 100 -C	S	250	83,00 gal Zn
6,3 x 13 -C	S	250	22,70 gal Zn
6,3 x 16 -C	S	250	17,00 gal Zn
6,3 x 19 -C	S	250	14,20 gal Zn
6,3 x 22 -C	S	250	16,40 gal Zn
6,3 x 25 -C	S	250	16,40 gal Zn
6,3 x 32 -C	S	250	18,00 gal Zn
6,3 x 38 -C	S	250	22,30 gal Zn
6,3 x 45 -C	S	250	27,50 gal Zn
6,3 x 50 -C	S	250	29,50 gal Zn
6,3 x 60 -C	S	250	52,00 gal Zn
6,3 x 70 -C	S	250	73,00 gal Zn
6,3 x 80 -C	S	250	82,00 gal Zn
6,3 x 90 -C	S	250	91,00 gal Zn
6,3 x 100 -C	S	250	99,00 gal Zn

ISO 14585.014

14585 Stahl gehärtet Form F
galvanisch verzinkt



Linsenkopf-Blehschrauben mit Innensechsrund, F = mit Zapfen

Maße → **TI-46** Montage → **TI-251**
 Korrosionsschutz → **TI-228**



2,9 x 4,5 -F	S	2000	6,30 gal Zn
2,9 x 6,5 -F	S	1000	5,60 gal Zn
2,9 x 9,5 -F	S	1000	5,00 gal Zn
2,9 x 13 -F	S	1000	5,30 gal Zn
2,9 x 16 -F	S	1000	6,70 gal Zn
2,9 x 19 -F	S	1000	7,90 gal Zn
2,9 x 22 -F	S	1000	9,80 gal Zn
2,9 x 25 -F	S	1000	10,50 gal Zn
3,5 x 9,5 -F	S	1000	5,90 gal Zn
3,5 x 13 -F	S	1000	6,10 gal Zn
3,5 x 16 -F	S	1000	6,30 gal Zn
3,5 x 19 -F	S	1000	8,00 gal Zn
3,5 x 22 -F	S	1000	11,10 gal Zn
3,5 x 25 -F	S	1000	11,70 gal Zn

Abmessungen	VE	Stück	€/100/Obf.
3,5 x 32 -F	S	1000	12,80 gal Zn
3,5 x 38 -F	S	1000	14,30 gal Zn
3,5 x 45 -F	S	500	20,90 gal Zn
3,5 x 50 -F	S	500	22,70 gal Zn
3,9 x 9,5 -F	S	1000	6,70 gal Zn
3,9 x 13 -F	S	1000	7,00 gal Zn
3,9 x 16 -F	S	1000	7,70 gal Zn
3,9 x 19 -F	S	1000	8,80 gal Zn
3,9 x 22 -F	S	500	11,50 gal Zn
3,9 x 25 -F	S	500	12,60 gal Zn
3,9 x 32 -F	S	500	13,40 gal Zn
3,9 x 38 -F	S	500	18,40 gal Zn
3,9 x 45 -F	S	500	18,90 gal Zn
3,9 x 50 -F	S	500	19,30 gal Zn
4,2 x 9,5 -F	S	1000	7,30 gal Zn
4,2 x 13 -F	S	1000	7,40 gal Zn
4,2 x 16 -F	S	1000	8,20 gal Zn
4,2 x 19 -F	S	500	8,80 gal Zn
4,2 x 22 -F	S	500	12,10 gal Zn
4,2 x 25 -F	S	500	13,40 gal Zn
4,2 x 32 -F	S	500	14,80 gal Zn
4,2 x 38 -F	S	500	19,40 gal Zn
4,2 x 45 -F	S	500	22,10 gal Zn
4,2 x 50 -F	S	500	25,50 gal Zn
4,2 x 60 -F	S	500	44,00 gal Zn
4,2 x 70 -F	S	250	51,00 gal Zn
4,2 x 80 -F	S	250	67,00 gal Zn
4,8 x 9,5 -F	S	500	15,20 gal Zn
4,8 x 13 -F	S	500	10,60 gal Zn
4,8 x 16 -F	S	500	10,90 gal Zn
4,8 x 19 -F	S	500	12,80 gal Zn
4,8 x 22 -F	S	500	13,40 gal Zn
4,8 x 25 -F	S	500	15,80 gal Zn
4,8 x 32 -F	S	250	18,00 gal Zn
4,8 x 38 -F	S	250	20,60 gal Zn
4,8 x 45 -F	S	250	28,00 gal Zn
4,8 x 50 -F	S	250	31,00 gal Zn
4,8 x 55 -F	S	250	50,00 gal Zn
4,8 x 60 -F	S	250	54,00 gal Zn
4,8 x 70 -F	S	250	66,00 gal Zn
4,8 x 80 -F	S	250	79,00 gal Zn
4,8 x 90 -F	S	100	101,00 gal Zn
4,8 x 100 -F	S	100	115,00 gal Zn
5,5 x 13 -F	S	500	28,50 gal Zn
5,5 x 16 -F	S	500	24,20 gal Zn
5,5 x 19 -F	S	500	18,20 gal Zn
5,5 x 22 -F	S	500	28,00 gal Zn
5,5 x 25 -F	S	500	29,50 gal Zn
5,5 x 32 -F	S	250	31,00 gal Zn
5,5 x 38 -F	S	250	35,50 gal Zn
5,5 x 45 -F	S	250	38,50 gal Zn
5,5 x 50 -F	S	250	45,00 gal Zn
5,5 x 60 -F	S	250	85,00 gal Zn
5,5 x 70 -F	S	250	105,00 gal Zn
5,5 x 80 -F	S	100	126,00 gal Zn
5,5 x 90 -F	S	100	135,00 gal Zn
5,5 x 100 -F	S	100	153,00 gal Zn
6,3 x 13 -F	S	500	42,50 gal Zn
6,3 x 16 -F	S	500	31,50 gal Zn
6,3 x 19 -F	S	500	27,00 gal Zn
6,3 x 22 -F	S	500	30,50 gal Zn
6,3 x 25 -F	S	500	31,50 gal Zn
6,3 x 32 -F	S	250	33,50 gal Zn
6,3 x 38 -F	S	250	41,50 gal Zn
6,3 x 45 -F	S	250	51,00 gal Zn
6,3 x 50 -F	S	250	56,00 gal Zn
6,3 x 60 -F	S	250	96,00 gal Zn
6,3 x 70 -F	S	100	135,00 gal Zn
6,3 x 80 -F	S	100	151,00 gal Zn
6,3 x 90 -F	S	100	170,00 gal Zn
6,3 x 100 -F	S	100	188,00 gal Zn

Abmessungen	VE Stück	€/100/Obf.
ISO 14586.013		
14586	Stahl gehärtet	Form C
	galvanisch verzinkt	



Senkkopf-Blechschauben mit Innensechsrund, C = mit Spitze

Senk \sphericalangle = 90°

Maße → **TI-47** Montage → **TI-251**
 Korrosionsschutz → **TI-228**

Rostfrei → **S. 591**

Senk \sphericalangle = 80° → DIN 7982 ISR

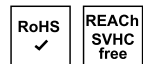

2,9	x	6,5 -C	S	1000	12,10 gal Zn
2,9	x	9,5 -C	S	1000	5,10 gal Zn
2,9	x	13 -C	S	1000	5,50 gal Zn
2,9	x	16 -C	S	1000	6,10 gal Zn
2,9	x	19 -C	S	1000	8,00 gal Zn
2,9	x	22 -C	S	1000	9,90 gal Zn
2,9	x	25 -C	S	1000	10,50 gal Zn
3,5	x	9,5 -C	S	1000	5,90 gal Zn
3,5	x	13 -C	S	1000	6,10 gal Zn
3,5	x	16 -C	S	1000	6,30 gal Zn
3,5	x	19 -C	S	1000	8,20 gal Zn
3,5	x	22 -C	S	1000	9,90 gal Zn
3,5	x	25 -C	S	1000	12,10 gal Zn
3,5	x	32 -C	S	1000	15,00 gal Zn
3,5	x	38 -C	S	1000	14,30 gal Zn
3,5	x	45 -C	S	1000	20,90 gal Zn
3,5	x	50 -C	S	1000	22,70 gal Zn
3,9	x	9,5 -C	S	1000	6,90 gal Zn
3,9	x	13 -C	S	1000	7,00 gal Zn
3,9	x	16 -C	S	1000	7,70 gal Zn
3,9	x	19 -C	S	1000	8,90 gal Zn
3,9	x	22 -C	S	500	10,20 gal Zn
3,9	x	25 -C	S	500	12,10 gal Zn
3,9	x	32 -C	S	500	12,10 gal Zn
3,9	x	38 -C	S	500	18,40 gal Zn
3,9	x	45 -C	S	500	21,80 gal Zn
3,9	x	50 -C	S	500	27,00 gal Zn
4,2	x	9,5 -C	S	1000	7,30 gal Zn
4,2	x	13 -C	S	1000	7,40 gal Zn
4,2	x	16 -C	S	1000	8,20 gal Zn
4,2	x	19 -C	S	500	9,70 gal Zn
4,2	x	22 -C	S	500	10,60 gal Zn
4,2	x	25 -C	S	500	13,40 gal Zn
4,2	x	32 -C	S	500	17,00 gal Zn
4,2	x	38 -C	S	500	20,60 gal Zn
4,2	x	45 -C	S	500	24,90 gal Zn
4,2	x	50 -C	S	500	29,50 gal Zn
4,2	x	60 -C	S	500	48,50 gal Zn
4,2	x	70 -C	S	500	60,00 gal Zn
4,2	x	80 -C	S	500	76,00 gal Zn
4,8	x	9,5 -C	S	500	14,70 gal Zn
4,8	x	13 -C	S	500	10,90 gal Zn
4,8	x	16 -C	S	500	11,10 gal Zn
4,8	x	19 -C	S	500	12,40 gal Zn
4,8	x	22 -C	S	500	13,40 gal Zn
4,8	x	25 -C	S	500	15,80 gal Zn
4,8	x	32 -C	S	250	18,20 gal Zn
4,8	x	38 -C	S	250	20,60 gal Zn
4,8	x	45 -C	S	250	28,00 gal Zn
4,8	x	50 -C	S	250	31,50 gal Zn

Abmessungen	VE Stück	€/100/Obf.			
4,8	x	55 -C	S	250	47,50 gal Zn
4,8	x	60 -C	S	250	51,00 gal Zn
4,8	x	70 -C	S	250	66,00 gal Zn
4,8	x	80 -C	S	250	79,00 gal Zn
4,8	x	90 -C	S	100	101,00 gal Zn
4,8	x	100 -C	S	100	115,00 gal Zn
5,5	x	13 -C	S	500	28,50 gal Zn
5,5	x	16 -C	S	500	23,60 gal Zn
5,5	x	19 -C	S	500	21,80 gal Zn
5,5	x	22 -C	S	500	28,50 gal Zn
5,5	x	25 -C	S	500	29,50 gal Zn
5,5	x	32 -C	S	250	34,00 gal Zn
5,5	x	38 -C	S	250	38,00 gal Zn
5,5	x	45 -C	S	250	42,50 gal Zn
5,5	x	50 -C	S	250	48,50 gal Zn
5,5	x	60 -C	S	250	85,00 gal Zn
5,5	x	70 -C	S	250	105,00 gal Zn
5,5	x	80 -C	S	250	128,00 gal Zn
5,5	x	90 -C	S	250	140,00 gal Zn
5,5	x	100 -C	S	250	158,00 gal Zn
6,3	x	13 -C	S	500	42,50 gal Zn
6,3	x	16 -C	S	500	31,50 gal Zn
6,3	x	19 -C	S	500	27,00 gal Zn
6,3	x	22 -C	S	500	30,50 gal Zn
6,3	x	25 -C	S	500	31,50 gal Zn
6,3	x	32 -C	S	250	35,50 gal Zn
6,3	x	38 -C	S	250	42,50 gal Zn
6,3	x	45 -C	S	250	51,00 gal Zn
6,3	x	50 -C	S	250	68,00 gal Zn
6,3	x	60 -C	S	250	97,00 gal Zn
6,3	x	70 -C	S	250	140,00 gal Zn
6,3	x	80 -C	S	250	152,00 gal Zn
6,3	x	90 -C	S	250	170,00 gal Zn
6,3	x	100 -C	S	250	188,00 gal Zn

Abmessungen	VE Stück	€/100/Obf.
ISO 14586.014		
14586	Stahl gehärtet	Form F
	galvanisch verzinkt	



Senkkopf-Blechschauben mit Innensechsrund, F = mit Zapfen

Senk \sphericalangle = 90°

Maße → **TI-47** Montage → **TI-251**
 Korrosionsschutz → **TI-228**



2,9	x	6,5 -F	S	1000	12,10 gal Zn
2,9	x	9,5 -F	S	1000	5,10 gal Zn
2,9	x	13 -F	S	1000	5,50 gal Zn
2,9	x	16 -F	S	1000	6,10 gal Zn
2,9	x	19 -F	S	1000	8,00 gal Zn
2,9	x	22 -F	S	1000	9,90 gal Zn
2,9	x	25 -F	S	1000	10,50 gal Zn
3,5	x	9,5 -F	S	1000	5,90 gal Zn
3,5	x	13 -F	S	1000	6,10 gal Zn
3,5	x	16 -F	S	1000	6,30 gal Zn
3,5	x	19 -F	S	1000	8,20 gal Zn
3,5	x	22 -F	S	1000	9,90 gal Zn
3,5	x	25 -F	S	1000	12,10 gal Zn
3,5	x	32 -F	S	1000	15,00 gal Zn
3,5	x	38 -F	S	1000	14,30 gal Zn
3,5	x	45 -F	S	1000	20,90 gal Zn
3,5	x	50 -F	S	500	22,70 gal Zn
3,9	x	9,5 -F	S	1000	6,90 gal Zn

Abmessungen	VE Stück	€/100/Obf.			
3,9	x	13 -F	S	1000	7,00 gal Zn
3,9	x	16 -F	S	1000	7,70 gal Zn
3,9	x	19 -F	S	1000	8,90 gal Zn
3,9	x	22 -F	S	500	10,20 gal Zn
3,9	x	25 -F	S	500	12,10 gal Zn
3,9	x	32 -F	S	500	16,40 gal Zn
3,9	x	38 -F	S	500	18,40 gal Zn
3,9	x	45 -F	S	500	21,80 gal Zn
3,9	x	50 -F	S	500	27,00 gal Zn
4,2	x	9,5 -F	S	1000	7,30 gal Zn
4,2	x	13 -F	S	1000	7,40 gal Zn
4,2	x	16 -F	S	1000	8,20 gal Zn
4,2	x	19 -F	S	500	9,70 gal Zn
4,2	x	22 -F	S	500	10,60 gal Zn
4,2	x	25 -F	S	500	13,40 gal Zn
4,2	x	32 -F	S	500	17,00 gal Zn
4,2	x	38 -F	S	500	20,60 gal Zn
4,2	x	45 -F	S	500	24,90 gal Zn
4,2	x	50 -F	S	500	29,50 gal Zn
4,2	x	60 -F	S	500	48,50 gal Zn
4,2	x	70 -F	S	250	60,00 gal Zn
4,2	x	80 -F	S	250	76,00 gal Zn
4,8	x	9,5 -F	S	500	14,70 gal Zn
4,8	x	13 -F	S	500	10,90 gal Zn
4,8	x	16 -F	S	500	11,10 gal Zn
4,8	x	19 -F	S	500	12,40 gal Zn
4,8	x	22 -F	S	500	13,40 gal Zn
4,8	x	25 -F	S	500	15,80 gal Zn
4,8	x	32 -F	S	250	18,20 gal Zn
4,8	x	38 -F	S	250	20,60 gal Zn
4,8	x	45 -F	S	250	28,00 gal Zn
4,8	x	50 -F	S	250	31,50 gal Zn
4,8	x	55 -F	S	250	47,50 gal Zn
4,8	x	60 -F	S	250	51,00 gal Zn
4,8	x	70 -F	S	250	66,00 gal Zn
4,8	x	80 -F	S	250	79,00 gal Zn
4,8	x	90 -F	S	100	101,00 gal Zn
4,8	x	100 -F	S	100	115,00 gal Zn
5,5	x	13 -F	S	500	28,50 gal Zn
5,5	x	16 -F	S	500	23,60 gal Zn
5,5	x	19 -F	S	500	21,80 gal Zn
5,5	x	22 -F	S	500	28,50 gal Zn
5,5	x	25 -F	S	500	29,50 gal Zn
5,5	x	32 -F	S	250	34,00 gal Zn
5,5	x	38 -F	S	250	38,00 gal Zn
5,5	x	45 -F	S	250	42,50 gal Zn
5,5	x	50 -F	S	250	48,50 gal Zn
5,5	x	60 -F	S	250	85,00 gal Zn
5,5	x	70 -F	S	250	105,00 gal Zn
5,5	x	80 -F	S	100	128,00 gal Zn
5,5	x	90 -F	S	100	140,00 gal Zn
5,5	x	100 -F	S	100	158,00 gal Zn
6,3	x	13 -F	S	500	42,50 gal Zn
6,3	x	16 -F	S	500	31,50 gal Zn
6,3	x	19 -F	S	500	27,00 gal Zn
6,3	x	22 -F	S	500	30,50 gal Zn
6,3	x	25 -F	S	500	31,50 gal Zn
6,3	x	32 -F	S	250	35,50 gal Zn
6,3	x	38 -F	S	250	42,50 gal Zn
6,3	x	45 -F	S	250	51,00 gal Zn
6,3	x	50 -F	S	250	68,00 gal Zn
6,3	x	60 -F	S	250	97,00 gal Zn
6,3	x	70 -F	S	250	140,00 gal Zn
6,3	x	80 -F	S	100	152,00 gal Zn
6,3	x	90 -F	S	100	170,00 gal Zn
6,3	x	100 -F	S	100	188,00 gal Zn

Abmessungen	VE Stück	€/100/Obf.
~ISO	15480.010	
15480 Stahl gehärtet galvanisch verzinkt		

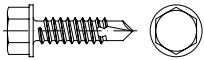

Sechskant-Bohrschrauben mit Bund, mit Blechschraubengewinde

Maße → **TI-42** Korrosionsschutz → **TI-228**
 ISO 15480 → ersetzt DIN 7504 Form K

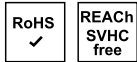

ST 3,5 x 9,5	S	1000	9,50 gal Zn
ST 3,5 x 13	S	1000	9,70 gal Zn
ST 3,5 x 16	S	1000	10,70 gal Zn
ST 3,5 x 19	S	1000	11,20 gal Zn
ST 3,5 x 22	S	1000	17,20 gal Zn
ST 3,5 x 25	S	1000	22,20 gal Zn
ST 3,9 x 13	S	1000	10,30 gal Zn
ST 3,9 x 16	S	1000	11,30 gal Zn
ST 3,9 x 19	S	1000	12,30 gal Zn
ST 3,9 x 22	S	1000	19,40 gal Zn
ST 3,9 x 25	S	1000	25,50 gal Zn
ST 3,9 x 32	S	1000	35,00 gal Zn
ST 4,2 x 13	S	1000	11,70 gal Zn
ST 4,2 x 13	K	100	16,50 gal Zn
ST 4,2 x 16	S	1000	12,30 gal Zn
ST 4,2 x 19	S	1000	12,50 gal Zn
ST 4,2 x 22	S	1000	14,30 gal Zn
ST 4,2 x 25	S	1000	15,20 gal Zn
ST 4,2 x 32	S	500	21,50 gal Zn
ST 4,2 x 38	S	500	28,00 gal Zn
ST 4,8 x 13	S	1000	14,30 gal Zn
ST 4,8 x 16	S	1000	15,00 gal Zn
ST 4,8 x 19	S	1000	15,70 gal Zn
ST 4,8 x 22	S	1000	18,00 gal Zn
ST 4,8 x 25	S	1000	19,20 gal Zn
ST 4,8 x 32	S	500	21,50 gal Zn
ST 4,8 x 38	S	500	24,00 gal Zn
ST 4,8 x 45	S	500	27,00 gal Zn
ST 4,8 x 50	S	500	28,50 gal Zn
ST 4,8 x 60	S	500	33,50 gal Zn
ST 4,8 x 70	S	250	37,00 gal Zn
ST 4,8 x 80	S	250	42,50 gal Zn
ST 5,5 x 16	S	500	21,50 gal Zn
ST 5,5 x 19	S	500	20,30 gal Zn
ST 5,5 x 22	S	500	22,90 gal Zn
ST 5,5 x 25	S	500	23,60 gal Zn
ST 5,5 x 32	S	250	26,50 gal Zn
ST 5,5 x 38	S	250	26,50 gal Zn
ST 5,5 x 45	S	250	27,00 gal Zn
ST 5,5 x 50	S	250	27,00 gal Zn
ST 5,5 x 60	S	250	39,00 gal Zn
ST 5,5 x 70	S	100	46,00 gal Zn
ST 5,5 x 80	S	100	55,00 gal Zn
ST 5,5 x 90	S	100	63,00 gal Zn
ST 5,5 x 100	S	100	78,00 gal Zn
ST 6,3 x 16	S	500	27,00 gal Zn
ST 6,3 x 19	S	500	28,50 gal Zn
ST 6,3 x 22	S	500	30,50 gal Zn
ST 6,3 x 25	S	500	31,50 gal Zn
ST 6,3 x 32	S	250	37,00 gal Zn
ST 6,3 x 38	S	250	39,50 gal Zn
ST 6,3 x 45	S	250	44,50 gal Zn
ST 6,3 x 50	S	250	49,50 gal Zn
ST 6,3 x 60	S	250	54,00 gal Zn
ST 6,3 x 70	S	100	60,00 gal Zn

Abmessungen	VE Stück	€/100/Obf.	
ST 6,3 x 80	S	100	68,00 gal Zn
ST 6,3 x 90	S	100	83,00 gal Zn
ST 6,3 x 100	S	100	100,00 gal Zn
ST 6,3 x 110	S	100	119,00 gal Zn
ST 6,3 x 120	S	100	141,00 gal Zn
ST 6,3 x 130	S	100	165,00 gal Zn
ST 6,3 x 140	S	100	194,00 gal Zn
ST 6,3 x 150	S	100	230,00 gal Zn
ST 6,3 x 160	S	100	295,00 gal Zn

ISO	15481.014
15481 Stahl gehärtet galvanisch verzinkt H	

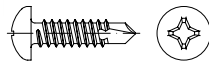

Flachkopf-Bohrschrauben mit Blechschraubengewinde, H = mit Phillips-Kreuzschlitz H

Maße → **TI-42** Korrosionsschutz → **TI-228**
 ISO 15481 → ersetzt DIN 7504 Form N (austauschbar)

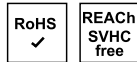

ST 2,9 x 9,5 -H	S	1000	8,60 gal Zn
ST 2,9 x 13 -H	S	1000	8,80 gal Zn
ST 2,9 x 16 -H	S	1000	8,90 gal Zn
ST 2,9 x 19 -H	S	1000	9,60 gal Zn
ST 3,5 x 9,5 -H	S	1000	9,90 gal Zn
ST 3,5 x 13 -H	S	1000	10,10 gal Zn
ST 3,5 x 16 -H	S	1000	10,30 gal Zn
ST 3,5 x 19 -H	S	1000	10,70 gal Zn
ST 3,5 x 22 -H	S	1000	11,70 gal Zn
ST 3,5 x 25 -H	S	1000	12,00 gal Zn
ST 3,5 x 32 -H	S	1000	13,40 gal Zn
ST 3,9 x 9,5 -H	S	1000	10,10 gal Zn
ST 3,9 x 13 -H	S	1000	10,20 gal Zn
ST 3,9 x 16 -H	S	1000	10,80 gal Zn
ST 3,9 x 19 -H	S	1000	11,30 gal Zn
ST 3,9 x 22 -H	S	1000	11,70 gal Zn
ST 3,9 x 25 -H	S	1000	12,10 gal Zn
ST 3,9 x 32 -H	S	1000	12,90 gal Zn
ST 3,9 x 38 -H	S	500	13,70 gal Zn
ST 3,9 x 45 -H	S	500	14,60 gal Zn
ST 3,9 x 50 -H	S	500	16,00 gal Zn
ST 4,2 x 13 -H	S	1000	12,30 gal Zn
ST 4,2 x 16 -H	S	1000	12,60 gal Zn
ST 4,2 x 19 -H	S	1000	12,90 gal Zn
ST 4,2 x 22 -H	S	1000	14,40 gal Zn
ST 4,2 x 25 -H	S	1000	15,30 gal Zn
ST 4,2 x 32 -H	S	500	16,50 gal Zn
ST 4,2 x 38 -H	S	500	17,80 gal Zn
ST 4,2 x 45 -H	S	500	19,30 gal Zn
ST 4,2 x 50 -H	S	500	20,90 gal Zn
ST 4,8 x 13 -H	S	1000	14,90 gal Zn
ST 4,8 x 16 -H	S	1000	15,30 gal Zn
ST 4,8 x 19 -H	S	1000	16,00 gal Zn
ST 4,8 x 22 -H	S	1000	17,00 gal Zn
ST 4,8 x 25 -H	S	1000	18,70 gal Zn
ST 4,8 x 32 -H	S	500	18,80 gal Zn
ST 4,8 x 38 -H	S	500	20,60 gal Zn
ST 4,8 x 45 -H	S	500	22,20 gal Zn
ST 4,8 x 50 -H	S	500	23,60 gal Zn
ST 4,8 x 60 -H	S	250	26,50 gal Zn
ST 4,8 x 70 -H	S	250	29,00 gal Zn
ST 4,8 x 80 -H	S	250	32,00 gal Zn
ST 4,8 x 90 -H	S	250	51,00 gal Zn
ST 4,8 x 100 -H	S	250	80,00 gal Zn

Abmessungen	VE Stück	€/100/Obf.	
ST 4,8 x 110 -H	S	100	119,00 gal Zn
ST 4,8 x 120 -H	S	250	170,00 gal Zn
ST 5,5 x 16 -H	S	500	18,60 gal Zn
ST 5,5 x 19 -H	S	500	19,40 gal Zn
ST 5,5 x 22 -H	S	500	21,50 gal Zn
ST 5,5 x 25 -H	S	500	29,00 gal Zn
ST 5,5 x 32 -H	S	500	31,50 gal Zn
ST 5,5 x 38 -H	S	500	34,00 gal Zn
ST 5,5 x 45 -H	S	500	36,50 gal Zn
ST 5,5 x 50 -H	S	500	39,50 gal Zn
ST 5,5 x 60 -H	S	250	43,50 gal Zn
ST 5,5 x 70 -H	S	250	49,00 gal Zn
ST 5,5 x 80 -H	S	250	54,00 gal Zn
ST 6,3 x 16 -H	S	500	32,50 gal Zn
ST 6,3 x 19 -H	S	500	34,00 gal Zn
ST 6,3 x 22 -H	S	500	37,00 gal Zn
ST 6,3 x 25 -H	S	500	40,00 gal Zn
ST 6,3 x 32 -H	S	500	43,00 gal Zn
ST 6,3 x 38 -H	S	500	46,50 gal Zn
ST 6,3 x 45 -H	S	500	50,00 gal Zn
ST 6,3 x 50 -H	S	500	54,00 gal Zn
ST 6,3 x 60 -H	S	250	60,00 gal Zn
ST 6,3 x 70 -H	S	250	66,00 gal Zn
ST 6,3 x 80 -H	S	250	72,00 gal Zn
ST 6,3 x 90 -H	S	100	81,00 gal Zn
ST 6,3 x 100 -H	S	100	91,00 gal Zn

ISO	15482.014
15482 Stahl gehärtet galvanisch verzinkt H	

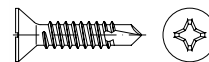

Senkkopf-Bohrschrauben mit Blechschraubengewinde H = mit Phillips-Kreuzschlitz H

Senk α = 90°

Maße → **TI-42** Korrosionsschutz → **TI-228**
 ISO 15482 → ersetzt DIN 7504 Form P

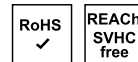

ST 2,9 x 13 -H	S	1000	8,20 gal Zn
ST 2,9 x 16 -H	S	1000	8,40 gal Zn
ST 2,9 x 19 -H	S	1000	8,90 gal Zn
ST 3,5 x 13 -H	S	1000	9,40 gal Zn
ST 3,5 x 16 -H	S	1000	9,60 gal Zn
ST 3,5 x 19 -H	S	1000	9,90 gal Zn
ST 3,5 x 22 -H	S	1000	10,80 gal Zn
ST 3,5 x 25 -H	S	1000	11,20 gal Zn
ST 4,2 x 13 -H	S	1000	11,30 gal Zn
ST 4,2 x 16 -H	S	1000	11,70 gal Zn
ST 4,2 x 19 -H	S	1000	11,90 gal Zn
ST 4,2 x 22 -H	S	1000	13,50 gal Zn
ST 4,2 x 25 -H	S	1000	14,20 gal Zn
ST 4,2 x 32 -H	S	500	15,20 gal Zn
ST 4,2 x 38 -H	S	500	17,00 gal Zn
ST 4,2 x 45 -H	S	500	18,90 gal Zn
ST 4,2 x 50 -H	S	500	23,60 gal Zn
ST 4,8 x 16 -H	S	1000	12,10 gal Zn
ST 4,8 x 19 -H	S	1000	14,00 gal Zn
ST 4,8 x 22 -H	S	1000	14,70 gal Zn
ST 4,8 x 25 -H	S	500	14,80 gal Zn
ST 4,8 x 32 -H	S	500	16,10 gal Zn
ST 4,8 x 38 -H	S	500	17,70 gal Zn
ST 4,8 x 45 -H	S	500	21,10 gal Zn
ST 4,8 x 50 -H	S	250	24,10 gal Zn

Abmessungen	VE	Stück	€/100/Obf.
ST 5,5 x 25 -H	S	250	18,10 gal Zn
ST 5,5 x 32 -H	S	250	19,70 gal Zn
ST 5,5 x 38 -H	S	250	21,20 gal Zn
ST 5,5 x 45 -H	S	250	23,80 gal Zn
ST 5,5 x 50 -H	S	250	26,50 gal Zn
ST 6,3 x 25 -H	S	250	26,00 gal Zn
ST 6,3 x 32 -H	S	250	27,50 gal Zn
ST 6,3 x 38 -H	S	250	29,50 gal Zn
ST 6,3 x 45 -H	S	250	33,50 gal Zn
ST 6,3 x 50 -H	S	250	36,50 gal Zn
ST 6,3 x 60 -H	S	250	38,50 gal Zn
ST 6,3 x 70 -H	S	250	65,00 gal Zn
ST 6,3 x 80 -H	S	250	88,00 gal Zn

DIN 15058.000

15058 Stahl

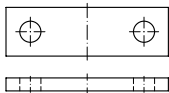

Achshalter (für Hebezeuge)

Maße → TI-137



Breite x Dicke

20	x	5	S	50	520,00
25	x	6	S	50	590,00
30	x	8	S	25	720,00
40	x	10	S	25	1350,00
50	x	12	S	10	2010,00

DIN 15237.000

15237 Mu 3.6

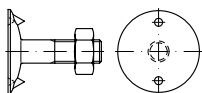

Tellerschrauben mit Tellerscheibe, Mu = mit Sechskantmutter

zur Befestigung von Bauteilen an Gurten

Maße → TI-35



M 6	x	20	S	200	99,00
M 8	x	20	S	100	105,00
M 8	x	25	S	100	107,00
M 8	x	30	S	100	114,00
M 8	x	35	S	100	117,00
M 8	x	40	S	100	120,00
M 8	x	50	S	100	126,00
M 10	x	30	S	100	132,00
M 10	x	35	S	100	132,00
M 10	x	40	S	100	134,00
M 10	x	45	S	100	141,00
M 10	x	50	S	100	143,00
M 12	x	35	S	100	265,00
M 12	x	40	S	100	275,00
M 12	x	50	S	100	285,00
M 12	x	60	S	100	305,00

Abmessungen VE Stück €/100/Obf. EN 16983.000

16983 Federstahl

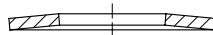

Tellerfedern

Produktinformation → TI-141

Rostfrei → S. 592

EN 16983 → ersetzt DIN 2093

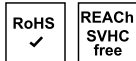

Außen Ø x Innen Ø x Dicke

8	x	3,2	x	0,3	S	200	12,90
8	x	3,2	x	0,4	S	200	13,20
8	x	3,2	x	0,5	S	200	13,60
8	x	4,2	x	0,2	S	200	11,10
8	x	4,2	x	0,3	S	200	12,90
8	x	4,2	x	0,4	S	200	13,20
10	x	3,2	x	0,3	S	200	13,70
10	x	3,2	x	0,4	S	200	14,20
10	x	3,2	x	0,5	S	200	14,30
10	x	4,2	x	0,4	S	200	14,20
10	x	4,2	x	0,5	S	200	14,30
10	x	4,2	x	0,6	S	200	14,30
10	x	5,2	x	0,25	S	200	13,60
10	x	5,2	x	0,4	S	200	14,20
10	x	5,2	x	0,5	S	200	14,30
10	x	5,2	x	0,6	S	200	14,30
10	x	5,2	x	0,7	S	200	14,30
12	x	4,2	x	0,4	S	200	15,40
12	x	4,2	x	0,5	S	200	15,50
12	x	4,2	x	0,6	S	200	15,70
12	x	5,2	x	0,5	S	200	15,50
12	x	5,2	x	0,6	S	200	15,70
12	x	6,2	x	0,5	S	200	15,50
12	x	6,2	x	0,6	S	200	15,70
12,5	x	6,2	x	0,35	S	200	15,30
12,5	x	6,2	x	0,5	S	200	15,50
12,5	x	6,2	x	0,7	S	200	16,30
14	x	7,2	x	0,35	S	200	16,00
14	x	7,2	x	0,5	S	200	16,10
14	x	7,2	x	0,8	S	200	17,50
15	x	5,2	x	0,4	S	200	16,10
15	x	5,2	x	0,5	S	200	16,60
15	x	5,2	x	0,6	S	200	17,00
15	x	5,2	x	0,7	S	200	17,10
15	x	6,2	x	0,5	S	200	16,60
15	x	6,2	x	0,6	S	200	17,00
15	x	6,2	x	0,7	S	200	17,10
15	x	8,2	x	0,7	S	200	17,10
15	x	8,2	x	0,8	S	200	17,70
16	x	8,2	x	0,4	S	200	16,60
16	x	8,2	x	0,6	S	200	17,20
16	x	8,2	x	0,9	S	200	18,70
18	x	6,2	x	0,4	S	200	17,40
18	x	6,2	x	0,5	S	200	17,60
18	x	6,2	x	0,6	S	200	18,00
18	x	6,2	x	0,7	S	200	18,10
18	x	6,2	x	0,8	S	200	18,70
18	x	8,2	x	0,7	S	200	18,10
18	x	8,2	x	0,8	S	200	18,70
18	x	8,2	x	1,0	S	200	20,60
18	x	9,2	x	0,45	S	200	17,40
18	x	9,2	x	0,7	S	200	18,10
18	x	9,2	x	1,0	S	200	20,60
20	x	8,2	x	0,5	S	200	18,60
20	x	8,2	x	0,6	S	200	18,80
20	x	8,2	x	0,7	S	200	19,30

Abmessungen VE Stück €/100/Obf.

20	x	8,2	x	0,8	S	200	19,70
20	x	8,2	x	0,9	S	200	20,00
20	x	8,2	x	1,0	S	200	22,10
20	x	10,2	x	0,4	S	200	18,20
20	x	10,2	x	0,5	S	200	18,60
20	x	10,2	x	0,8	S	200	19,70
20	x	10,2	x	0,9	S	200	20,00
20	x	10,2	x	1,0	S	200	22,10
20	x	10,2	x	1,1	S	200	23,20
22,5	x	11,2	x	0,6	S	200	19,40
22,5	x	11,2	x	0,8	S	200	21,20
22,5	x	11,2	x	1,25	S	200	52,00
23	x	8,2	x	0,7	S	200	20,00
23	x	8,2	x	0,8	S	200	21,60
23	x	8,2	x	0,9	S	200	22,10
23	x	10,2	x	0,9	S	200	22,10
23	x	10,2	x	1,0	S	200	26,00
23	x	12,2	x	1,0	S	200	26,00
23	x	12,2	x	1,25	S	200	52,00
23	x	12,2	x	1,5	S	200	56,00
25	x	12,2	x	0,7	S	200	22,10
25	x	12,2	x	0,9	S	200	24,00
25	x	12,2	x	1,25	S	200	51,00
25	x	12,2	x	1,5	S	200	59,00
28	x	10,2	x	0,8	S	200	27,50
28	x	10,2	x	1,0	S	200	29,00
28	x	10,2	x	1,25	S	200	60,00
28	x	10,2	x	1,5	S	200	65,00
28	x	12,2	x	1,0	S	200	29,00
28	x	12,2	x	1,25	S	200	60,00
28	x	12,2	x	1,5	S	200	65,00
28	x	14,2	x	0,8	S	200	27,50
28	x	14,2	x	1,0	S	200	29,00
28	x	14,2	x	1,25	S	200	60,00
28	x	14,2	x	1,5	S	200	65,00
31,5	x	16,3	x	0,8	S	100	31,00
31,5	x	16,3	x	1,25	S	100	67,00
31,5	x	16,3	x	1,5	S	100	72,00
31,5	x	16,3	x	1,75	S	100	77,00
31,5	x	16,3	x	2,0	S	100	85,00
31,7	x	20,4	x	0,4	S	100	89,00
34	x	12,3	x	1,0	S	100	34,00
34	x	12,3	x	1,25	S	100	73,00
34	x	12,3	x	1,5	S	100	83,00
34	x	14,3	x	1,25	S	100	73,00
34	x	14,3	x	1,5	S	100	83,00
34	x	16,3	x	1,5	S	100	83,00
34	x	16,3	x	2,0	S	100	91,00
35,5	x	18,3	x	0,9	S	100	36,50
35,5	x	18,3	x	1,25	S	100	72,00
35,5	x	18,3	x	2,0	S	100	99,00
40	x	14,3	x	1,25	S	100	102,00
40	x	14,3	x	1,5	S	100	111,00
40	x	14,3	x	1,75	S	100	115,00
40	x	14,3	x	2,0	S	100	117,00
40	x	16,3	x	1,5	S	100	111,00
40	x	16,3	x	1,75	S	100	115,00
40	x	16,3	x	2,0	S	100	117,00
40	x	18,3	x	2,0	S	100	117,00
40	x	20,4	x	1,0	S	100	53,00
40	x	20,4	x	1,5	S	100	111,00
40	x	20,4	x	2,0	S	100	117,00
40	x	20,4	x	2,25	S	100	130,00
40	x	20,4	x	2,5	S	100	141,00
45	x	22,4	x	1,25	S	200	136,00
45	x	22,4	x	1,75	S	200	152,00
45	x	22,4	x	2,5	S	200	166,00
46,5	x	30,5	x	0,6	S	100	128,00
48	x	16,3	x	1,5	S	100	147,00
50	x	18,4	x	1,25	S	100	144,00
50	x	18,4	x	1,5	S	100	151,00
50	x	18,4	x	2,0	S	100	181,00
50	x	18,4	x	2,5	S	100	210,00
50	x	18,4	x	3,0	S	100	244,00
50	x	20,4	x	2,0	S	100	181,00

Abmessungen	VE	Stück	€/100/Obf.
50 x 20,4 x 2,5 S	100		210,00
50 x 22,4 x 2,0 S	100		181,00
50 x 22,4 x 2,5 S	100		210,00
50 x 25,4 x 1,25 S	100		144,00
50 x 25,4 x 1,5 S	100		135,00
50 x 25,4 x 2,0 S	100		181,00
50 x 25,4 x 2,25 S	100		194,00
50 x 25,4 x 2,5 S	100		210,00
50 x 25,4 x 3,0 S	100		244,00
56 x 28,5 x 1,5 S	100		183,00
56 x 28,5 x 2,0 S	100		212,00
56 x 28,5 x 2,5 S	100		260,00
56 x 28,5 x 3,0 S	100		300,00
60 x 20,5 x 2,0 S	100		241,00
60 x 20,5 x 2,5 S	100		280,00
60 x 20,5 x 3,0 S	100		330,00
60 x 25,5 x 2,5 S	100		280,00
60 x 25,5 x 3,0 S	100		330,00
60 x 30,5 x 2,5 S	100		280,00
60 x 30,5 x 2,75 S	100		305,00
60 x 30,5 x 3,0 S	100		330,00
60 x 30,5 x 3,5 S	100		370,00
63 x 31,0 x 1,8 S	100		275,00
63 x 31,0 x 2,5 S	100		295,00
63 x 31,0 x 3,0 S	100		365,00
63 x 31,0 x 3,5 S	100		395,00
70 x 24,5 x 3,0 S	100		470,00
70 x 24,5 x 3,5 S	100		540,00
70 x 25,5 x 2,0 S	100		370,00
70 x 30,5 x 2,5 S	100		395,00
70 x 30,5 x 3,0 S	100		460,00
70 x 35,5 x 3,0 S	100		460,00
70 x 35,5 x 3,5 S	100		540,00
70 x 35,5 x 4,0 S	100		670,00
70 x 40,5 x 4,0 S	100		670,00
70 x 40,5 x 5,0 S	100		840,00
71 x 36,0 x 2,0 S	100		380,00
71 x 36,0 x 2,5 S	100		420,00
71 x 36,0 x 4,0 S	100		680,00
80 x 30,5 x 2,5 S	100		510,00
80 x 31,0 x 3,0 S	100		570,00
80 x 31,0 x 4,0 S	100		840,00
80 x 36,0 x 3,0 S	100		570,00
80 x 41,0 x 3,0 S	100		570,00
80 x 41,0 x 4,0 S	50		840,00
80 x 41,0 x 5,0 S	50		1010,00
90 x 46,0 x 2,5 S	10		670,00
90 x 46,0 x 3,5 S	10		790,00
90 x 46,0 x 5,0 S	10		1180,00
100 x 41,0 x 4,0 S	10		1180,00
100 x 41,0 x 5,0 S	10		1480,00
100 x 51,0 x 2,7 S	10		850,00
100 x 51,0 x 3,5 S	10		950,00
100 x 51,0 x 4,0 S	10		1180,00
100 x 51,0 x 5,0 S	10		1480,00
100 x 51,0 x 6,0 S	1		1900,00
100 x 51,0 x 7,0 S	1		2700,00
112 x 57,0 x 3,0 S	1		1320,00
112 x 57,0 x 4,0 S	1		1520,00
112 x 57,0 x 6,0 S	1		2100,00
125 x 51,0 x 4,0 S	1		1800,00
125 x 51,0 x 5,0 S	1		2070,00
125 x 51,0 x 6,0 S	1		2900,00
125 x 61,0 x 5,0 S	1		2070,00
125 x 61,0 x 6,0 S	1		2900,00
125 x 61,0 x 8,0 S	1		4100,00
125 x 64,0 x 3,5 S	1		1540,00
125 x 64,0 x 5,0 S	1		2070,00
125 x 64,0 x 6,0 S	1		2900,00
125 x 64,0 x 7,0 S	1		3800,00
125 x 64,0 x 8,0 S	1		4100,00
125 x 71,0 x 6,0 S	1		2900,00
125 x 71,0 x 8,0 S	1		4100,00
125 x 71,0 x 10,0 S	1		4700,00
140 x 72,0 x 3,8 S	1		2270,00

Abmessungen	VE	Stück	€/100/Obf.
140 x 72,0 x 5,0 S	1		2950,00
140 x 72,0 x 8,0 S	1		5100,00
150 x 61,0 x 5,0 S	1		3250,00
150 x 61,0 x 6,0 S	1		4300,00
150 x 61,0 x 7,0 S	1		5200,00
150 x 71,0 x 6,0 S	1		4300,00
150 x 71,0 x 8,0 S	1		5800,00
150 x 81,0 x 8,0 S	1		5800,00
150 x 81,0 x 10,0 S	1		6500,00
160 x 82,0 x 4,3 S	1		3950,00
160 x 82,0 x 6,0 S	1		4750,00
160 x 82,0 x 10,0 S	5		6800,00
160 x 82,0 x 11,0 S	1		6800,00
180 x 92,0 x 4,8 S	1		5400,00
180 x 92,0 x 6,0 S	1		5700,00
180 x 92,0 x 10,0 S	1		8600,00
180 x 92,0 x 13,0 S	1		10500,00
200 x 82,0 x 8,0 S	1		9400,00
200 x 82,0 x 10,0 S	1		10500,00
200 x 82,0 x 12,0 S	1		11800,00
200 x 92,0 x 10,0 S	1		10500,00
200 x 92,0 x 12,0 S	1		11800,00
200 x 92,0 x 14,0 S	1		12800,00
200 x 102 x 5,5 S	1		7700,00
200 x 102 x 8,0 S	1		9400,00
200 x 102 x 10,0 S	1		10500,00
200 x 102 x 12,0 S	1		11800,00
200 x 102 x 14,0 S	1		12800,00
200 x 112 x 12,0 S	1		11800,00
200 x 112 x 14,0 S	1		12800,00
200 x 112 x 16,0 S	1		13800,00
225 x 112 x 6,5 S	1		11700,00
225 x 112 x 8,0 S	1		12000,00
225 x 112 x 12,0 S	1		15200,00
250 x 127 x 10,0 S	1		16700,00
250 x 127 x 14,0 S	1		20100,00

DIN	22424.801
-----	-----------

22424 8.8 Form A

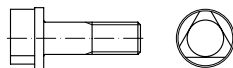

Dreikantschrauben, A = mit Vollschaft

Maße → TI-35 Werkstoffeigensch. → TI-232



AM 8 x 25	S	100	192,00
AM 8 x 30	S	100	203,00
AM 10 x 30	S	100	285,00

Abmessungen	VE	Stück	€/100/Obf.
DIN	28129.014		
28129	C35E	AD W7	galvanisch verzinkt

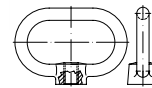

Bügelmuttern

für Druckbehälterbau nach AD-Regelwerk, TÜV-anerkannte Fabrikate

Maße → TI-129 Korrosionsschutz → TI-228

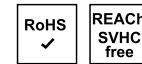

M 16	S	1	9800,00 gal Zn
M 20	S	1	10800,00 gal Zn
M 24	S	1	11400,00 gal Zn
M 27	S	1	11800,00 gal Zn

DIN	70852.800
-----	-----------

70852 17 H

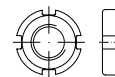

Nutmuttern

Maße → TI-76 REACH → TI-262
Werkstoffeigensch. → TI-233

Nutmuttern mit Klemmring "GUK" → Artikel 88081



M 10 x 1	S	25	590,00
M 12 x 1,5	S	25	630,00
M 14 x 1,5	S	25	650,00
M 16 x 1,5	S	25	720,00
M 18 x 1,5	S	10	760,00
M 20 x 1,5	S	10	780,00
M 22 x 1,5	S	10	860,00
M 24 x 1,5	S	10	890,00
M 26 x 1,5	S	10	950,00
M 28 x 1,5	S	1	1030,00
M 30 x 1,5	S	1	1030,00
M 32 x 1,5	S	1	1200,00
M 35 x 1,5	S	1	1240,00
M 38 x 1,5	S	1	1420,00
M 40 x 1,5	S	1	1430,00
M 42 x 1,5	S	1	1650,00
M 45 x 1,5	S	1	1720,00
M 48 x 1,5	S	1	1860,00
M 50 x 1,5	S	1	1920,00
M 52 x 1,5	S	1	2150,00
M 55 x 1,5	S	1	2270,00
M 60 x 1,5	S	1	2550,00
M 65 x 1,5	S	1	2850,00
M 70 x 1,5	S	1	3250,00
M 75 x 1,5	S	1	3600,00
M 80 x 1,5	S	1	4100,00
M 85 x 1,5	S	1	4450,00
M 90 x 1,5	S	1	4750,00
M 95 x 1,5	S	1	5400,00

Abmessungen	VE Stück	€/100/Obf.
DIN	70952.001	
70952	Stahl	Form A

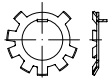

Sicherungsbleche
für Nutmuttern DIN 70852

Maße → **TI-102**

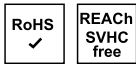

A 10	S	100	125,00
A 12	S	50	137,00
A 14	S	50	138,00
A 16	S	50	144,00
A 18	S	50	146,00
A 20	S	50	151,00
A 22	S	50	154,00
A 24	S	50	157,00
A 26	S	50	166,00
A 28	S	50	172,00
A 30	S	50	186,00
A 32	S	50	190,00
A 35	S	50	195,00
A 38	S	25	204,00
A 40	S	25	211,00
A 42	S	25	221,00
A 45	S	25	224,00
A 48	S	25	241,00
A 50	S	25	260,00
A 52	S	25	270,00
A 55	S	25	280,00
A 60	S	25	325,00
A 65	S	25	365,00
A 70	S	25	390,00
A 75	S	10	430,00
A 80	S	10	620,00
A 90	S	10	660,00

DIN	71412.511
71412	5.8 galvanisch verzinkt
	Form A-M



Kegelschmiernippel, kurz, mit Sechskant, A = Kegelpfopf gerade/axial M = mit metrischem Kegelpgewinde

Maße → **TI-25** REACH → **TI-262**
Korrosionsschutz → **TI-228**

Rostfrei → **S. 592**

Flach-Schmiernippel → DIN 3404



Kegelpgewinde M x Steigung / Schlüsselweite SW

AM 6	x 1	SW 7	S	100	83,00 gal Zn
AM 8	x 1	SW 9	S	100	102,00 gal Zn

Abmessungen	VE Stück	€/100/Obf.
AM 8	x 1,25 SW 9	S 100 119,00 gal Zn
AM 10	x 1 SW11	S 100 131,00 gal Zn

DIN	71412.514
71412	5.8 galvanisch verzinkt
	Form A-R



Kegelschmiernippel, kurz, mit Sechskant, A = Kegelpfopf gerade/axial R = mit zölligem Rohrgewinde

Maße → **TI-25** REACH → **TI-262**
Korrosionsschutz → **TI-228**

Flach-Schmiernippel → DIN 3404



Kegel-Rohrgewinde R x Steigung / Schlüsselweite SW

AR 1/8	SW11	S	100	105,00 gal Zn
AR 1/4	SW14	S	50	207,00 gal Zn

DIN	71412.512
71412	5.8 galvanisch verzinkt
	Form B-M



Kegelschmiernippel, kurz, mit Sechskant oder Vierkant, B = Kegelpfopf 45° abgewinkelt M = mit metrischem Kegelpgewinde,

Maße → **TI-25** REACH → **TI-262**
Korrosionsschutz → **TI-228**

Flach-Schmiernippel → DIN 3404



Kegelpgewinde M x Steigung / Schlüsselweite SW

BM 6	x 1 SW 9	S	100	229,00 gal Zn
BM 8	x 1 SW 9	S	100	229,00 gal Zn
BM 10	x 1 SW11	S	100	232,00 gal Zn

Abmessungen	VE Stück	€/100/Obf.
DIN	71412.513	
71412	5.8 galvanisch verzinkt	Form C-M

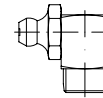

Kegelschmiernippel, kurz, mit Sechskant oder Vierkant, C = Kegelpfopf 90° abgewinkelt M = mit metrischem Kegelpgewinde

Maße → **TI-25** REACH → **TI-262**
Korrosionsschutz → **TI-228**

Flach-Schmiernippel → DIN 3404



Kegelpgewinde M x Steigung / Schlüsselweite SW

CM 6	x 1 SW 9	S	100	229,00 gal Zn
CM 8	x 1 SW 9	S	100	229,00 gal Zn
CM 8	x 1,25 SW 9	S	100	182,00 gal Zn
CM10	x 1 SW11	S	100	232,00 gal Zn

DIN	71752.014
71752	Stahl galvanisch verzinkt
	Form G

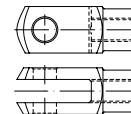

Gabelgelenke, für Federklappbolzen (Artikel 88752), G = Gabelköpfe

Bolzen → DIN 1444

Maße → **TI-124** Korrosionsschutz → **TI-228**



Bohrung Ø x Schlitztiefe g (bis Mitte Bohrung)

G 6	x	12	S	10	226,00 gal Zn
G 6	x	24	S	10	260,00 gal Zn
G 8	x	16	S	10	285,00 gal Zn
G 8	x	32	S	10	385,00 gal Zn
G 10	x	20	S	10	430,00 gal Zn
G 10	x	40	S	10	620,00 gal Zn
G 12	x	24	S	10	660,00 gal Zn
G 12	x	48	S	10	1050,00 gal Zn
G 16	x	32	S	5	1540,00 gal Zn
G 16	x	64	S	5	2290,00 gal Zn
G 20	x	40	S	5	3050,00 gal Zn

Abmessungen	VE Stück	€/100/Obf.
~DIN	88752.010	
71752	Stahl	Artikel 88752
	galvanisch verzinkt	

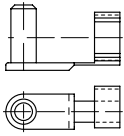

Federklapp-Bolzen ("ES-Bolzen") für Gabelköpfe DIN 71752

Bolzen → DIN 1444

Maße → TI-124

REACH → TI-262

Korrosionsschutz → TI-228



Nennmaß = passend zu Gabelkopf DIN 71752

ES 6	x	12	S	10	107,00 gal Zn
ES 6	x	24	S	10	143,00 gal Zn
ES 8	x	16	S	10	125,00 gal Zn
ES 8	x	32	S	10	134,00 gal Zn
ES 10	x	20	S	10	158,00 gal Zn
ES 10	x	40	S	10	174,00 gal Zn
ES 12	x	24	S	10	221,00 gal Zn
ES 12	x	48	S	10	265,00 gal Zn
ES 16	x	32	S	5	395,00 gal Zn
ES 16	x	64	S	5	770,00 gal Zn
ES 20	x	40	S	5	690,00 gal Zn

DIN	71802.014
71802	Stahl
	Form AS
	galvanisch verzinkt

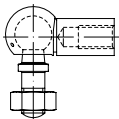

Winkelgelenke mit Gewindezapfen, Sechskantmutter und Sicherungsbügel

Korrosionsschutz → TI-228

REACH → TI-262



Kugel Ø x Gewinde-Zapfen Ø = Innengewinde

AS 8-M 5	S	25	380,00 gal Zn
AS 10-M 6	S	25	415,00 gal Zn
AS 13-M 8	S	25	590,00 gal Zn
AS 16-M 10	S	10	960,00 gal Zn
AS 16-M 12	S	10	1070,00 gal Zn
AS 19-M 14	x 1,5	S 10	2170,00 gal Zn

Abmessungen	VE Stück	€/100/Obf.
DIN	74361.801	
74361	8	Form A
	phosphatiert	

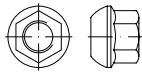

Kugelbundmuttern

Maße → TI-65

Werkstoffeigensch. → TI-233



Gewinde M x Feingewinde/Schlüsselweite SW

AM 14	x	1,5 SW19	S	100	242,00
AM 18	x	1,5 SW24	S	100	340,00
AM 20	x	1,5 SW27	S	100	445,00

DIN	74361.102
-----	-----------

74361	10	Form B
	phosphatiert	



Flachbundmuttern

Maße → TI-65

Werkstoffeigensch. → TI-233

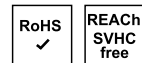

Gewinde M x Feingewinde/Schlüsselweite SW

M14	x	1,5 SW19	S	100	236,00
M18	x	1,5 SW24	S	100	325,00
M20	x	1,5 SW27	S	100	340,00
M22	x	1,5 SW30	S	100	395,00

DIN	74361.013
-----	-----------

74361	Federstahl	Form C
	galvanisch verzinkt	

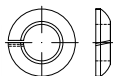

Federringe ("Limesringe")

Maße → TI-102

Korrosionsschutz → TI-228

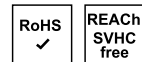

Innen Ø

C 12,5	S	100	34,00 gal Zn
C 14,5	S	100	48,00 gal Zn
C 16,5	S	100	46,00 gal Zn
C 18,5	S	100	56,00 gal Zn
C 20,5	S	100	78,00 gal Zn
C 22,5	S	100	77,00 gal Zn

Abmessungen	VE Stück	€/100/Obf.
DIN	82101.011	
82101	Stahl	Form A
	galvanisch verzinkt	

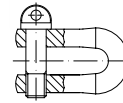

Schüssel, geschmiedet

Maße → TI-134

Korrosionsschutz → TI-228

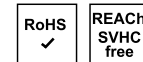

Nenngröße (= Tragfähigkeit - WLL in t)

A 0,16	S	50	385,00 gal Zn
A 0,25	S	50	420,00 gal Zn
A 0,4	S	25	620,00 gal Zn
A 0,6	S	25	830,00 gal Zn
A 1	S	25	1280,00 gal Zn

ASME B	83931.804
--------	-----------

18.2.1	Grade 5 (~8.8)	UNC
---------------	-----------------------	------------

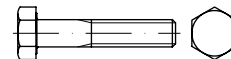

Hex cap screws Sechskantschrauben mit Schaft, mit UNC-Gewinde

Maße → TI-16

Anziehmomente → TI-246

Werkstoffeigensch. → TI-235

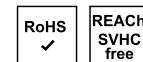

Ø in Inch x Länge in Inch

1/4	x	1 1/4	S	100	59,00
1/4	x	1 1/2	S	100	63,00
1/4	x	1 3/4	S	100	80,00
1/4	x	2	S	100	85,00
1/4	x	2 1/4	S	100	102,00
1/4	x	2 1/2	S	100	109,00
1/4	x	3	S	200	117,00
1/4	x	3 1/4	S	200	126,00
1/4	x	3 1/2	S	200	136,00
1/4	x	4	S	100	146,00
1/4	x	4 1/2	S	100	158,00
1/4	x	5	S	100	176,00
1/4	x	5 1/2	S	100	194,00
1/4	x	6	S	100	212,00
5/16	x	1 1/2	S	100	85,00
5/16	x	1 3/4	S	100	92,00
5/16	x	2	S	100	100,00
5/16	x	2 1/4	S	100	107,00
5/16	x	2 1/2	S	100	117,00
5/16	x	3	S	100	126,00
5/16	x	3 1/4	S	100	140,00
5/16	x	3 1/2	S	100	152,00
5/16	x	4	S	100	170,00
3/8	x	1 1/2	S	100	115,00
3/8	x	1 3/4	S	100	124,00
3/8	x	2	S	100	134,00
3/8	x	2 1/4	S	100	146,00
3/8	x	2 1/2	S	100	160,00
3/8	x	3	S	100	186,00

Abmessungen	VE	Stück	€/100/Obf.
3/8 x 3 1/4	S	100	200,00
3/8 x 3 1/2	S	100	213,00
3/8 x 4	S	100	236,00
3/8 x 4 1/2	S	100	265,00
3/8 x 5	S	100	305,00
7/16 x 1 3/4	S	100	180,00
7/16 x 2	S	100	188,00
7/16 x 2 1/4	S	100	209,00
7/16 x 2 1/2	S	50	228,00
7/16 x 3	S	50	290,00
7/16 x 3 1/4	S	50	315,00
7/16 x 3 1/2	S	50	325,00
7/16 x 4	S	50	375,00
1/2 x 2	S	50	223,00
1/2 x 2 1/4	S	50	246,00
1/2 x 2 1/2	S	50	270,00
1/2 x 3	S	50	340,00
1/2 x 3 1/4	S	50	370,00
1/2 x 3 1/2	S	50	395,00
1/2 x 4	S	50	440,00
1/2 x 4 1/2	S	50	480,00
1/2 x 5	S	50	520,00
1/2 x 5 1/2	S	50	560,00
1/2 x 6	S	50	600,00
5/8 x 2 1/4	S	25	425,00
5/8 x 2 1/2	S	25	445,00
5/8 x 3	S	25	520,00
5/8 x 3 1/2	S	25	580,00
5/8 x 4	S	25	670,00
5/8 x 4 1/2	S	25	730,00
5/8 x 5	S	25	790,00
5/8 x 5 1/2	S	25	850,00
5/8 x 6	S	25	910,00
3/4 x 3	S	25	820,00
3/4 x 3 1/2	S	25	910,00
3/4 x 4	S	25	1030,00
7/8 x 3	S	25	940,00
7/8 x 3 1/2	S	25	1060,00
7/8 x 4	S	10	1180,00
1 x 3 1/2	S	10	1150,00
1 x 4	S	10	1280,00
1 x 4 1/2	S	10	1430,00
1 x 5	S	1	1580,00
1 1/4 x 4	S	1	2120,00
1 1/4 x 5	S	1	3050,00
1 1/2 x 5	S	1	3950,00
1 1/2 x 5 1/2	S	1	4550,00
1 1/2 x 6	S	1	5200,00

ASME B	83931.814
--------	-----------

18.2.1 Grade 5 (~8.8) **UNC**
galvanisch verzinkt

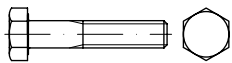

**Hex cap screws
Sechskantschrauben mit Schaft,
mit UNC-Gewinde**

Maße → TI-16 Korrosionsschutz → TI-228
Werkstoffeigensch. → TI-235 Anziehmomente → TI-246



∅ in Inch x Länge in Inch

1/4 x 1 1/4	S	100	77,00 gal Zn
1/4 x 1 1/2	S	100	83,00 gal Zn
1/4 x 1 3/4	S	100	105,00 gal Zn
1/4 x 2	S	100	112,00 gal Zn
1/4 x 2 1/2	S	100	143,00 gal Zn

Abmessungen	VE	Stück	€/100/Obf.
5/16 x 1 1/2	S	100	112,00 gal Zn
5/16 x 1 3/4	S	100	120,00 gal Zn
5/16 x 2	S	100	130,00 gal Zn
5/16 x 2 1/4	S	100	140,00 gal Zn
5/16 x 2 1/2	S	100	152,00 gal Zn
3/8 x 1 1/2	S	100	151,00 gal Zn
3/8 x 1 3/4	S	100	161,00 gal Zn
3/8 x 2	S	100	175,00 gal Zn
3/8 x 2 1/4	S	100	190,00 gal Zn
3/8 x 2 1/2	S	100	209,00 gal Zn
3/8 x 3	S	100	241,00 gal Zn
1/2 x 2	S	50	295,00 gal Zn
1/2 x 2 1/4	S	50	325,00 gal Zn
1/2 x 2 1/2	S	50	355,00 gal Zn
1/2 x 2 3/4	S	50	415,00 gal Zn
1/2 x 3	S	50	445,00 gal Zn
1/2 x 3 1/4	S	50	480,00 gal Zn
1/2 x 3 1/2	S	50	520,00 gal Zn
1/2 x 4	S	50	570,00 gal Zn
5/8 x 2 1/4	S	25	560,00 gal Zn
5/8 x 2 1/2	S	25	580,00 gal Zn
5/8 x 2 3/4	S	25	660,00 gal Zn
5/8 x 3	S	25	680,00 gal Zn
5/8 x 3 1/4	S	25	740,00 gal Zn
5/8 x 3 1/2	S	25	760,00 gal Zn
5/8 x 4	S	25	880,00 gal Zn
5/8 x 4 1/2	S	25	960,00 gal Zn
3/4 x 2 3/4	S	25	1030,00 gal Zn
3/4 x 3	S	25	1070,00 gal Zn
3/4 x 3 1/4	S	25	1130,00 gal Zn
3/4 x 3 1/2	S	25	1190,00 gal Zn
3/4 x 4	S	25	1350,00 gal Zn
3/4 x 4 1/2	S	25	1480,00 gal Zn
3/4 x 5	S	25	1570,00 gal Zn
3/4 x 5 1/2	S	25	1800,00 gal Zn
3/4 x 6	S	25	2010,00 gal Zn

ASME B	83931.805
--------	-----------

18.2.1 Grade 5 (~8.8) **UNF**

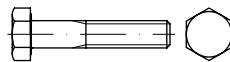

**Hex cap screws
Sechskantschrauben mit Schaft,
mit UNF-Gewinde**

Maße → TI-16 Anziehmomente → TI-246
Werkstoffeigensch. → TI-235



∅ in Inch x Länge in Inch

1/4 x 1 1/4	S	100	88,00
1/4 x 1 1/2	S	100	95,00
1/4 x 1 3/4	S	100	120,00
1/4 x 2	S	100	128,00
1/4 x 2 1/4	S	100	153,00
1/4 x 2 1/2	S	100	164,00
1/4 x 3	S	200	175,00
1/4 x 3 1/4	S	200	189,00
1/4 x 3 1/2	S	200	204,00
1/4 x 4	S	100	218,00
1/4 x 4 1/2	S	100	236,00
1/4 x 5	S	100	265,00
1/4 x 5 1/2	S	100	295,00
1/4 x 6	S	100	320,00
5/16 x 1 1/2	S	100	128,00
5/16 x 1 3/4	S	100	138,00
5/16 x 2	S	100	149,00

Abmessungen	VE	Stück	€/100/Obf.
5/16 x 2 1/4	S	100	160,00
5/16 x 2 1/2	S	100	175,00
5/16 x 3	S	100	189,00
5/16 x 3 1/4	S	100	209,00
5/16 x 3 1/2	S	100	228,00
3/8 x 1 1/2	S	100	173,00
3/8 x 1 3/4	S	100	186,00
3/8 x 2	S	100	200,00
3/8 x 2 1/4	S	100	218,00
3/8 x 2 1/2	S	100	240,00
3/8 x 3	S	100	280,00
3/8 x 3 1/4	S	100	300,00
3/8 x 3 1/2	S	100	320,00
3/8 x 4	S	100	355,00
7/16 x 1 3/4	S	100	270,00
7/16 x 2	S	100	285,00
7/16 x 2 1/4	S	100	315,00
7/16 x 2 1/2	S	50	345,00
7/16 x 3	S	50	435,00
7/16 x 3 1/4	S	50	470,00
7/16 x 3 1/2	S	50	485,00
7/16 x 4	S	50	560,00
1/2 x 2	S	50	335,00
1/2 x 2 1/4	S	50	370,00
1/2 x 2 1/2	S	50	405,00
1/2 x 3	S	50	510,00
1/2 x 3 1/4	S	50	550,00
1/2 x 3 1/2	S	50	590,00
1/2 x 4	S	50	660,00
1/2 x 4 1/2	S	50	720,00
1/2 x 5	S	50	780,00
1/2 x 5 1/2	S	50	830,00
1/2 x 6	S	50	890,00
5/8 x 2 1/2	S	25	670,00
5/8 x 3	S	25	780,00
5/8 x 3 1/2	S	25	870,00
5/8 x 4	S	25	1000,00
5/8 x 4 1/2	S	25	1090,00
3/4 x 3	S	25	1230,00
3/4 x 3 1/2	S	25	1370,00
1 x 3 1/2	S	10	1610,00
1 x 4	S	10	1790,00
1 x 4 1/2	S	10	2000,00
1 1/4 x 4	S	1	3000,00
1 1/2 x 5	S	1	4550,00

ASME B	83931.104
--------	-----------

18.2.1 Grade 8 (~10.9) **UNC**

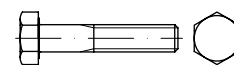

**Hex cap screws
Sechskantschrauben mit Schaft,
mit UNC-Gewinde**

Maße → TI-16 Anziehmomente → TI-246
Werkstoffeigensch. → TI-235

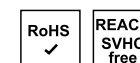

∅ in Inch x Länge in Inch

1/4 x 1 1/4	S	100	102,00
1/4 x 1 1/2	S	100	111,00
1/4 x 1 3/4	S	100	141,00
1/4 x 2	S	100	149,00
1/4 x 2 1/4	S	100	178,00
1/4 x 2 1/2	S	100	192,00
1/4 x 3	S	200	204,00
1/4 x 3 1/4	S	200	221,00

Abmessungen	VE	Stück	€/100/Obf.
1/4 x 3 1/2	S	200	238,00
1/4 x 4	S	100	255,00
1/4 x 4 1/2	S	100	280,00
1/4 x 5	S	100	310,00
1/4 x 5 1/2	S	100	340,00
1/4 x 6	S	100	375,00
5/16 x 1 1/2	S	100	148,00
5/16 x 1 3/4	S	100	161,00
5/16 x 2	S	100	174,00
5/16 x 2 1/4	S	100	187,00
5/16 x 2 1/2	S	100	204,00
5/16 x 3	S	100	221,00
5/16 x 3 1/4	S	100	245,00
5/16 x 3 1/2	S	100	270,00
3/8 x 1 1/2	S	100	173,00
3/8 x 1 3/4	S	100	186,00
3/8 x 2	S	100	200,00
3/8 x 2 1/4	S	100	218,00
3/8 x 2 1/2	S	100	240,00
3/8 x 3	S	100	280,00
3/8 x 3 1/4	S	100	300,00
3/8 x 3 1/2	S	100	320,00
3/8 x 4	S	100	355,00
7/16 x 1 3/4	S	100	270,00
7/16 x 2	S	100	285,00
7/16 x 2 1/4	S	100	315,00
7/16 x 2 1/2	S	50	345,00
7/16 x 3	S	50	435,00
7/16 x 3 1/2	S	50	485,00
7/16 x 4	S	50	560,00
1/2 x 2	S	50	335,00
1/2 x 2 1/4	S	50	370,00
1/2 x 2 1/2	S	50	405,00
1/2 x 3	S	50	510,00
1/2 x 3 1/4	S	50	550,00
1/2 x 3 1/2	S	50	590,00
1/2 x 4	S	50	660,00
1/2 x 4 1/2	S	50	720,00
1/2 x 5	S	50	780,00
1/2 x 5 1/2	S	50	830,00
1/2 x 6	S	50	890,00
5/8 x 2 1/2	S	25	670,00
5/8 x 3	S	25	780,00
5/8 x 3 1/2	S	25	870,00
5/8 x 4	S	25	1000,00
5/8 x 4 1/2	S	25	1090,00
3/4 x 3	S	25	1230,00
3/4 x 3 1/2	S	25	1370,00
3/4 x 4	S	25	1550,00
3/4 x 4 1/2	S	25	1730,00
3/4 x 5	S	25	1940,00
7/8 x 3	S	25	1320,00
7/8 x 3 1/2	S	25	1490,00
7/8 x 4	S	10	1660,00
1 x 3 1/2	S	10	1610,00
1 x 4	S	10	1790,00
1 x 4 1/2	S	10	2000,00
1 1/4 x 4	S	1	3000,00
1 1/4 x 4 1/2	S	1	3400,00
1 1/4 x 5	S	1	4250,00
1 1/2 x 5	S	1	4550,00
1 1/2 x 5 1/2	S	1	5200,00
1 1/2 x 6	S	1	5800,00

Abmessungen VE Stück €/100/Obf.

ASME B 83931.105

18.2.1 Grade 8 (~10.9) UNF

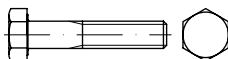

Hex cap screws Sechskantschrauben mit Schaft, mit UNF-Gewinde

Maße → TI-16 Anziehmomente → TI-246
Werkstoffeigensch. → TI-235



Ø in Inch x Länge in Inch

1/4 x 1 1/4	S	100	153,00
1/4 x 1 1/2	S	100	165,00
1/4 x 1 3/4	S	100	211,00
1/4 x 2	S	100	223,00
1/4 x 2 1/4	S	100	270,00
1/4 x 2 1/2	S	100	290,00
1/4 x 3	S	200	305,00
1/4 x 3 1/4	S	200	335,00
1/4 x 3 1/2	S	200	360,00
1/4 x 4	S	100	385,00
1/4 x 4 1/2	S	100	415,00
1/4 x 5	S	100	460,00
1/4 x 5 1/2	S	100	510,00
1/4 x 6	S	100	560,00
5/16 x 1 1/2	S	100	224,00
5/16 x 1 3/4	S	100	242,00
5/16 x 2	S	100	265,00
5/16 x 2 1/4	S	100	280,00
5/16 x 2 1/2	S	100	305,00
5/16 x 3	S	100	335,00
5/16 x 3 1/4	S	100	370,00
5/16 x 3 1/2	S	100	395,00
5/16 x 4	S	100	425,00
3/8 x 1 1/2	S	100	260,00
3/8 x 1 3/4	S	100	280,00
3/8 x 2	S	100	300,00
3/8 x 2 1/4	S	100	330,00
3/8 x 2 1/2	S	100	360,00
3/8 x 3	S	100	420,00
3/8 x 3 1/4	S	100	450,00
3/8 x 3 1/2	S	100	480,00
3/8 x 4	S	100	540,00
7/16 x 1 3/4	S	100	405,00
7/16 x 2	S	100	425,00
7/16 x 2 1/4	S	100	470,00
7/16 x 2 1/2	S	50	520,00
7/16 x 3	S	50	650,00
7/16 x 3 1/4	S	50	710,00
7/16 x 3 1/2	S	50	730,00
1/2 x 2	S	50	510,00
1/2 x 2 1/4	S	50	560,00
1/2 x 2 1/2	S	50	610,00
1/2 x 3	S	50	770,00
1/2 x 3 1/4	S	50	830,00
1/2 x 3 1/2	S	50	890,00
1/2 x 4	S	50	990,00
5/8 x 2 1/2	S	25	1000,00
5/8 x 3	S	25	1160,00
5/8 x 3 1/2	S	25	1300,00
5/8 x 4	S	25	1500,00
5/8 x 4 1/2	S	25	1640,00
3/4 x 3 1/2	S	25	2040,00
3/4 x 4	S	25	2320,00
3/4 x 4 1/2	S	25	2600,00

Abmessungen VE Stück €/100/Obf.

ASME B 83933.804

18.2.1 Grade 5 (~8.8) UNC

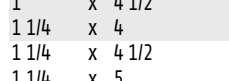

Hex cap screws Sechskantschrauben mit Vollgewinde, mit UNC-Gewinde

Maße → TI-16 Anziehmomente → TI-246
Werkstoffeigensch. → TI-235

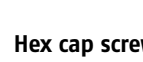

Ø in Inch x Länge in Inch

3/4 x 5	S	25	2950,00
1 x 3 1/2	S	10	2240,00
1 x 4	S	10	2490,00
1 x 4 1/2	S	10	2800,00
1 1/4 x 4	S	1	3350,00
1 1/4 x 4 1/2	S	1	3950,00
1 1/4 x 5	S	1	4850,00
1/4 x 1/2	S	100	44,00
1/4 x 5/8	S	100	46,00
1/4 x 3/4	S	100	48,50
1/4 x 7/8	S	100	51,00
1/4 x 1	S	100	54,00
5/16 x 1/2	S	100	48,50
5/16 x 5/8	S	100	51,00
5/16 x 3/4	S	100	56,00
5/16 x 7/8	S	100	61,00
5/16 x 1	S	100	68,00
5/16 x 1 1/4	S	100	78,00
3/8 x 1/2	S	100	85,00
3/8 x 5/8	S	100	79,00
3/8 x 3/4	S	100	83,00
3/8 x 7/8	S	100	88,00
3/8 x 1	S	100	92,00
3/8 x 1 1/4	S	100	100,00
7/16 x 3/4	S	100	121,00
7/16 x 7/8	S	100	128,00
7/16 x 1	S	100	134,00
7/16 x 1 1/4	S	100	146,00
7/16 x 1 1/2	S	100	170,00
1/2 x 3/4	S	50	151,00
1/2 x 7/8	S	50	155,00
1/2 x 1	S	50	158,00
1/2 x 1 1/4	S	50	165,00
1/2 x 1 1/2	S	50	182,00
1/2 x 1 3/4	S	50	212,00
5/8 x 1	S	25	242,00
5/8 x 1 1/4	S	25	275,00
5/8 x 1 1/2	S	25	305,00
5/8 x 1 3/4	S	25	355,00
5/8 x 2	S	25	415,00
3/4 x 1	S	25	365,00
3/4 x 1 1/4	S	25	425,00
3/4 x 1 1/2	S	25	485,00
3/4 x 1 3/4	S	25	580,00
3/4 x 2	S	25	670,00
3/4 x 2 1/2	S	25	760,00
7/8 x 5	S	10	1820,00
1 x 1 1/2	S	25	670,00
1 x 1 3/4	S	25	730,00
1 x 2	S	25	790,00
1 x 2 1/4	S	25	850,00
1 x 2 1/2	S	25	910,00
1 x 3	S	25	1060,00

Abmessungen	VE	Stück	€/100/Obf.
1 1/2 x 2 1/2	S	1	2700,00
1 1/2 x 4	S	1	4250,00

ASME B	83933.814
18.2.1	Grade 5 (~8.8) UNC
galvanisch verzinkt	



**Hex cap screws
Sechskantschrauben mit Vollgewinde,
mit UNC-Gewinde**

Maße → **TI-16** Korrosionsschutz → **TI-228**
Werkstoffeigensch. → **TI-235** Anziehmomente → **TI-246**



Ø in Inch x Länge in Inch

1/4	x	1/2	S	100	57,00 gal Zn
1/4	x	5/8	S	100	60,00 gal Zn
1/4	x	3/4	S	100	65,00 gal Zn
1/4	x	7/8	S	100	67,00 gal Zn
1/4	x	1	S	100	71,00 gal Zn
5/16	x	1/2	S	100	65,00 gal Zn
5/16	x	5/8	S	100	67,00 gal Zn
5/16	x	3/4	S	100	73,00 gal Zn
5/16	x	7/8	S	100	80,00 gal Zn
5/16	x	1	S	100	89,00 gal Zn
5/16	x	1 1/4	S	100	102,00 gal Zn
3/8	x	1/2	S	100	112,00 gal Zn
3/8	x	5/8	S	100	103,00 gal Zn
3/8	x	3/4	S	100	108,00 gal Zn
3/8	x	7/8	S	100	114,00 gal Zn
3/8	x	1	S	100	120,00 gal Zn
3/8	x	1 1/4	S	100	130,00 gal Zn
1/2	x	3/4	S	50	197,00 gal Zn
1/2	x	7/8	S	50	203,00 gal Zn
1/2	x	1	S	50	206,00 gal Zn
1/2	x	1 1/4	S	50	215,00 gal Zn
1/2	x	1 1/2	S	50	238,00 gal Zn
1/2	x	1 3/4	S	50	280,00 gal Zn
5/8	x	1	S	25	315,00 gal Zn
5/8	x	1 1/4	S	25	360,00 gal Zn
5/8	x	1 1/2	S	25	395,00 gal Zn
5/8	x	1 3/4	S	25	460,00 gal Zn
5/8	x	2	S	25	540,00 gal Zn
3/4	x	1 1/2	S	25	650,00 gal Zn
3/4	x	1 3/4	S	25	760,00 gal Zn
3/4	x	2	S	25	880,00 gal Zn
3/4	x	2 1/4	S	25	920,00 gal Zn
3/4	x	2 1/2	S	25	1000,00 gal Zn

Abmessungen	VE	Stück	€/100/Obf.
ASME B	83933.805		

18.2.1 Grade 5 (~8.8) UNF

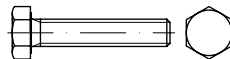

**Hex cap screws
Sechskantschrauben mit Vollgewinde,
mit UNF-Gewinde**

Maße → **TI-16** Anziehmomente → **TI-246**
Werkstoffeigensch. → **TI-235**



Ø in Inch x Länge in Inch

1/4	x	1/2	S	100	66,00
1/4	x	5/8	S	100	69,00
1/4	x	3/4	S	100	73,00
1/4	x	7/8	S	100	77,00
1/4	x	1	S	100	80,00
5/16	x	1/2	S	100	73,00
5/16	x	5/8	S	100	77,00
5/16	x	3/4	S	100	84,00
5/16	x	7/8	S	100	91,00
5/16	x	1	S	100	102,00
3/8	x	1/2	S	100	128,00
3/8	x	5/8	S	100	119,00
3/8	x	3/4	S	100	124,00
3/8	x	7/8	S	100	131,00
3/8	x	1	S	100	138,00
3/8	x	1 1/4	S	100	149,00
7/16	x	3/4	S	100	182,00
7/16	x	7/8	S	100	192,00
7/16	x	1	S	100	200,00
7/16	x	1 1/4	S	100	218,00
7/16	x	1 1/2	S	100	255,00
1/2	x	3/4	S	50	226,00
1/2	x	7/8	S	50	233,00
1/2	x	1	S	50	236,00
1/2	x	1 1/4	S	50	247,00
1/2	x	1 1/2	S	50	275,00
1/2	x	1 3/4	S	50	320,00
5/8	x	1	S	25	365,00
5/8	x	1 1/2	S	25	620,00
3/4	x	1	S	25	550,00
7/8	x	2	S	25	910,00

Abmessungen	VE	Stück	€/100/Obf.
ASME B	83933.104		

18.2.1 Grade 8 (~10.9) UNC

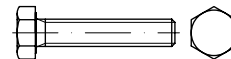

**Hex cap screws
Sechskantschrauben mit Vollgewinde,
mit UNC-Gewinde**

Maße → **TI-16** Anziehmomente → **TI-246**
Werkstoffeigensch. → **TI-235**



Ø in Inch x Länge in Inch

1/4	x	1/2	S	100	77,00
1/4	x	5/8	S	100	81,00
1/4	x	3/4	S	100	85,00
1/4	x	7/8	S	100	89,00
1/4	x	1	S	100	94,00
5/16	x	1/2	S	100	85,00
5/16	x	3/4	S	100	98,00
5/16	x	7/8	S	100	106,00
5/16	x	1	S	100	119,00
3/8	x	1/2	S	100	148,00
3/8	x	5/8	S	100	138,00
3/8	x	3/4	S	100	144,00
3/8	x	7/8	S	100	153,00
3/8	x	1	S	100	161,00
3/8	x	1 1/4	S	100	175,00
7/16	x	3/4	S	100	182,00
7/16	x	7/8	S	100	192,00
7/16	x	1	S	100	200,00
7/16	x	1 1/4	S	100	218,00
7/16	x	1 1/2	S	100	255,00
1/2	x	3/4	S	50	226,00
1/2	x	7/8	S	50	233,00
1/2	x	1	S	50	236,00
1/2	x	1 1/4	S	50	247,00
1/2	x	1 1/2	S	50	275,00
1/2	x	1 3/4	S	50	320,00
5/8	x	1	S	25	365,00
5/8	x	1 1/2	S	25	455,00
5/8	x	2	S	25	620,00
3/4	x	1	S	25	550,00
3/4	x	1 1/4	S	25	640,00
3/4	x	1 1/2	S	25	730,00
3/4	x	1 3/4	S	25	870,00
3/4	x	2	S	25	1000,00
3/4	x	2 1/4	S	25	1050,00
3/4	x	2 1/2	S	25	1140,00
7/8	x	2	S	25	790,00
7/8	x	2 1/2	S	25	1150,00
1	x	1 1/2	S	25	1000,00
1	x	1 3/4	S	25	1090,00
1	x	2	S	25	1180,00
1	x	2 1/4	S	25	1280,00
1	x	2 1/2	S	25	1370,00
1	x	3	S	25	1590,00
1 1/2	x	3	S	1	4250,00
1 1/2	x	4	S	1	6100,00

Abmessungen VE Stück €/100/Obf.

ASME B	83933.105
--------	-----------

18.2.1 Grade 8 (~10.9) UNF

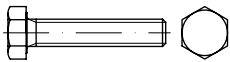

Hex cap screws
Sechskantschrauben mit Vollgewinde,
mit UNF-Gewinde

Maße → [TI-16](#) Anziehmomente → [TI-246](#)
 Werkstoffeigensch. → [TI-235](#)

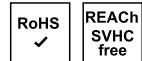

∅ in Inch x Länge in Inch

1/4	x	1/2	S	100	115,00
1/4	x	5/8	S	100	121,00
1/4	x	3/4	S	100	128,00
1/4	x	7/8	S	100	134,00
1/4	x	1	S	100	140,00
5/16	x	3/4	S	100	147,00
5/16	x	1	S	100	178,00
3/8	x	1/2	S	100	222,00
3/8	x	5/8	S	100	209,00
3/8	x	3/4	S	100	218,00
3/8	x	7/8	S	100	229,00
3/8	x	1	S	100	242,00
3/8	x	1 1/4	S	100	265,00
7/16	x	3/4	S	100	275,00
7/16	x	7/8	S	100	290,00
7/16	x	1	S	100	305,00
7/16	x	1 1/4	S	100	330,00
7/16	x	1 1/2	S	100	385,00
1/2	x	3/4	S	50	340,00
1/2	x	7/8	S	50	350,00
1/2	x	1	S	50	355,00
1/2	x	1 1/4	S	50	375,00
1/2	x	1 1/2	S	50	410,00
1/2	x	1 3/4	S	50	480,00
5/8	x	1	S	25	550,00
5/8	x	1 1/2	S	25	690,00
5/8	x	2	S	25	930,00
3/4	x	1	S	25	820,00
3/4	x	1 1/2	S	25	1090,00
3/4	x	2	S	25	1500,00
3/4	x	2 1/2	S	25	1700,00

ASME B	83934.804
--------	-----------

18.2.2 Grade 5 (~8) UNC

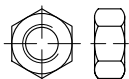

Hex nuts
Sechskantmuttern mit UNC-Gewinde

Maße → [TI-61](#) Anziehmomente → [TI-246](#)
 Werkstoffeigensch. → [TI-235](#)



∅ in Inch

1/4	S	100	9,50
5/16	S	100	10,90

Abmessungen VE Stück €/100/Obf.

3/8	S	100	13,00
7/16	S	100	21,70
1/2	S	100	26,00
9/16	S	50	43,50
5/8	S	50	49,50
3/4	S	50	83,00
7/8	S	25	138,00
1	S	25	170,00
1 1/8	S	10	260,00
1 1/4	S	10	375,00
1 1/2	S	5	1180,00
1 3/4	S	1	990,00

ASME B	83934.814
--------	-----------

18.2.2 Grade 5 (~8) UNC galvanisch verzinkt

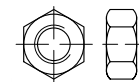

Hex nuts
Sechskantmuttern mit UNC-Gewinde

Maße → [TI-61](#) Korrosionsschutz → [TI-228](#)
 Werkstoffeigensch. → [TI-235](#) Anziehmomente → [TI-246](#)



∅ in Inch

1/4	S	100	12,40 gal Zn
5/16	S	100	14,20 gal Zn
3/8	S	100	17,00 gal Zn
7/16	S	100	28,50 gal Zn
1/2	S	100	33,50 gal Zn
5/8	S	50	65,00 gal Zn
3/4	S	50	108,00 gal Zn

ASME B	83934.805
--------	-----------

18.2.2 Grade 5 (~8) UNF

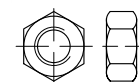

Hex nuts
Sechskantmuttern mit UNF-Gewinde

Maße → [TI-61](#) Anziehmomente → [TI-246](#)
 Werkstoffeigensch. → [TI-235](#)



∅ in Inch

1/4	S	100	9,50
5/16	S	100	10,90
3/8	S	100	13,00
7/16	S	100	21,70
1/2	S	100	26,00
9/16	S	50	43,50
5/8	S	50	49,50
3/4	S	50	83,00
7/8	S	25	138,00
1	S	25	170,00
1 1/8	S	10	260,00
1 1/4	S	10	375,00
1 1/2	S	5	1180,00
1 3/4	S	1	990,00

Abmessungen VE Stück €/100/Obf.

ASME B	83934.104
--------	-----------

18.2.2 Grade 8 (~10) UNC

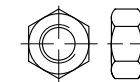

Hex nuts
Sechskantmuttern mit UNC-Gewinde

Maße → [TI-61](#) Anziehmomente → [TI-246](#)
 Werkstoffeigensch. → [TI-235](#)

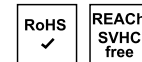

∅ in Inch

1/4	S	100	14,60
5/16	S	100	16,70
3/8	S	100	20,00
7/16	S	100	33,50
1/2	S	100	39,50
9/16	S	50	67,00
5/8	S	50	76,00
3/4	S	50	128,00
7/8	S	25	212,00
1	S	25	265,00
1 1/8	S	10	395,00
1 1/4	S	10	580,00
1 1/2	S	5	1820,00
1 3/4	S	1	1520,00

ASME B	83934.105
--------	-----------

18.2.2 Grade 8 (~10) UNF



Hex nuts
Sechskantmuttern mit UNF-Gewinde

Maße → [TI-61](#) Anziehmomente → [TI-246](#)
 Werkstoffeigensch. → [TI-235](#)

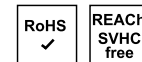

∅ in Inch

1/4	S	100	14,60
5/16	S	100	16,70
3/8	S	100	20,00
7/16	S	100	33,50
1/2	S	100	39,50
9/16	S	50	67,00
5/8	S	50	76,00
3/4	S	50	128,00
7/8	S	25	212,00
1	S	25	265,00
1 1/8	S	10	395,00
1 1/4	S	10	580,00
1 1/2	S	5	1820,00
1 3/4	S	1	1520,00

Abmessungen VE Stück €/100/Obf.
ASME B 83936.804

18.2.2 Grade 5 (~04) UNC

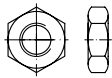

Hex jam nuts
Niedrige Sechskantmuttern
mit UNC-Gewinde

Maße → TI-61 Werkstoffeigensch. → TI-235



Ø in Inch

1/4	S	100	27,50
5/16	S	50	33,00
3/8	S	50	44,00
7/16	S	50	66,00
1/2	S	50	89,00
9/16	S	50	177,00
5/8	S	50	219,00
3/4	S	25	275,00

ASME B 83936.805

18.2.2 Grade 5 (~04) UNF

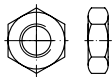

Hex jam nuts
Niedrige Sechskantmuttern
mit UNF-Gewinde

Maße → TI-61 Werkstoffeigensch. → TI-235

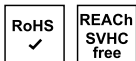

Ø in Inch

1/4	S	100	27,50
5/16	S	50	33,00
3/8	S	50	44,00
7/16	S	50	66,00
1/2	S	50	89,00
9/16	S	50	177,00
5/8	S	50	219,00
3/4	S	25	275,00

Abmessungen VE Stück €/100/Obf.
ANSI B 83125.004

18.22.1 Stahl Typ A-N

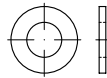

Plain washers
Scheiben für Schraubverbindungen
mit UNC-/UNF-Gewinde
N = narrow (kleine Ausführung/SAE)

Maße → TI-85

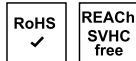

für Schrauben Ø x Außen Ø in Inch

1/4	x	0,625	S	500	12,10
5/16	x	0,688	S	500	18,20
3/8	x	0,812	S	500	24,20
7/16	x	0,922	S	200	42,50
1/2	x	1,062	S	200	51,00
9/16	x	1,156	S	200	59,00
5/8	x	1,312	S	100	66,00
3/4	x	1,469	S	100	73,00

ANSI B 83125.005

18.22.1 Stahl Typ A-W

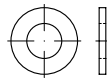

Plain washers
Scheiben für Schraubverbindungen
mit UNC-/UNF-Gewinde
W = wide (große Ausführung)

Maße → TI-85



für Schrauben Ø x Außen Ø in Inch

1/4	x	0,734	S	500	15,20
5/16	x	0,875	S	500	21,20
3/8	x	1,000	S	500	30,50
7/16	x	1,250	S	200	48,50
1/2	x	1,375	S	200	59,00
9/16	x	1,469	S	200	66,00
5/8	x	1,750	S	100	73,00
3/4	x	2,000	S	100	88,00

Abmessungen VE Stück €/100/Obf.
ASME B 83912.204

18.3 ASTM A 574* UNC



Hexagon socket head cap screws
Zylinderschrauben mit UNC-Gew.,
mit Innensechskant

*~Fkl.12.9

Maße → TI-13 Anziehmomente → TI-246
Werkstoffeigensch. → TI-235

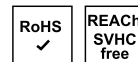

Ø in Inch/Nr. x Länge in Inch

#2	x	1/4	S	200	76,00
#2	x	3/8	S	200	76,00
#2	x	1/2	S	200	77,00
#4	x	3/16	S	200	53,00
#4	x	1/4	S	200	46,00
#4	x	5/16	S	200	41,50
#4	x	3/8	S	200	43,00
#4	x	1/2	S	200	47,50
#4	x	5/8	S	200	53,00
#4	x	3/4	S	200	56,00
#4	x	7/8	S	200	60,00
#4	x	1	S	100	68,00
#4	x	1 1/4	S	100	71,00
#4	x	1 1/2	S	100	86,00
#4	x	2	S	100	193,00
#5	x	1/4	S	200	49,50
#5	x	5/16	S	200	49,50
#5	x	3/8	S	200	49,50
#5	x	1/2	S	200	51,00
#5	x	5/8	S	200	54,00
#5	x	3/4	S	200	56,00
#5	x	7/8	S	200	65,00
#5	x	1	S	100	77,00
#5	x	1 1/4	S	200	80,00
#6	x	1/4	S	200	51,00
#6	x	5/16	S	200	51,00
#6	x	3/8	S	200	51,00
#6	x	1/2	S	200	54,00
#6	x	5/8	S	200	56,00
#6	x	3/4	S	200	57,00
#6	x	7/8	S	200	60,00
#6	x	1	S	200	62,00
#6	x	1 1/4	S	100	67,00
#6	x	1 1/2	S	100	86,00
#6	x	2	S	100	123,00
#8	x	1/4	S	200	54,00
#8	x	3/8	S	200	54,00
#8	x	1/2	S	200	57,00
#8	x	5/8	S	200	60,00
#8	x	3/4	S	200	60,00
#8	x	7/8	S	100	65,00
#8	x	1	S	200	65,00
#8	x	1 1/4	S	200	72,00
#8	x	1 1/2	S	200	99,00
#8	x	1 3/4	S	100	108,00
#8	x	2	S	100	134,00
#8	x	2 1/2	S	100	380,00
#10	x	3/8	S	200	56,00
#10	x	1/2	S	200	51,00
#10	x	5/8	S	200	59,00
#10	x	3/4	S	200	65,00
#10	x	1	S	200	67,00
#10	x	1 1/4	S	200	86,00

Abmessungen	VE	Stück	€/100/Obf.
#10 x 1 1/2	S	200	99,00
#10 x 2	S	200	141,00
1/4 x 1/2	S	100	53,00
1/4 x 5/8	S	100	62,00
1/4 x 3/4	S	100	65,00
1/4 x 7/8	S	100	76,00
1/4 x 1	S	100	77,00
1/4 x 1 1/4	S	100	88,00
1/4 x 1 1/2	S	100	105,00
1/4 x 1 3/4	S	100	115,00
1/4 x 2	S	100	138,00
1/4 x 2 1/4	S	100	161,00
1/4 x 2 1/2	S	100	183,00
1/4 x 2 3/4	S	100	198,00
1/4 x 3	S	100	215,00
5/16 x 3/8	S	100	151,00
5/16 x 1/2	S	100	135,00
5/16 x 5/8	S	100	134,00
5/16 x 3/4	S	100	119,00
5/16 x 7/8	S	100	149,00
5/16 x 1	S	100	155,00
5/16 x 1 1/4	S	100	159,00
5/16 x 1 1/2	S	100	194,00
5/16 x 1 3/4	S	100	244,00
5/16 x 2	S	100	270,00
5/16 x 2 1/2	S	100	335,00
5/16 x 2 3/4	S	100	385,00
5/16 x 3	S	100	415,00
5/16 x 3 1/2	S	100	460,00
5/16 x 4	S	100	530,00
5/16 x 4 1/2	S	100	730,00
5/16 x 5	S	50	800,00
3/8 x 3/4	S	100	190,00
3/8 x 7/8	S	100	199,00
3/8 x 1	S	100	201,00
3/8 x 1 1/4	S	100	226,00
3/8 x 1 1/2	S	100	260,00
3/8 x 1 3/4	S	100	295,00
3/8 x 2	S	100	330,00
3/8 x 2 1/4	S	100	395,00
3/8 x 2 1/2	S	100	395,00
3/8 x 3	S	100	470,00
1/2 x 1	S	50	335,00
1/2 x 1 1/4	S	50	365,00
1/2 x 1 1/2	S	50	395,00
1/2 x 1 3/4	S	50	445,00
1/2 x 2	S	50	475,00
1/2 x 2 1/4	S	50	540,00
1/2 x 2 1/2	S	50	620,00
1/2 x 2 3/4	S	50	670,00
1/2 x 3	S	50	680,00
1/2 x 3 1/4	S	50	830,00
1/2 x 3 1/2	S	50	850,00
1/2 x 4	S	50	880,00
5/8 x 1	S	25	690,00
5/8 x 1 1/4	S	25	710,00
5/8 x 1 1/2	S	25	710,00
5/8 x 1 3/4	S	25	780,00
5/8 x 2	S	25	790,00
5/8 x 2 1/4	S	25	900,00
5/8 x 2 1/2	S	25	990,00
5/8 x 2 3/4	S	25	1200,00
5/8 x 3	S	25	1230,00
5/8 x 3 1/4	S	25	1370,00
5/8 x 3 1/2	S	25	1430,00
5/8 x 4	S	25	1480,00
5/8 x 4 1/2	S	25	1770,00
5/8 x 5	S	25	1980,00
5/8 x 6	S	25	2350,00
5/8 x 7	S	25	3550,00
7/8 x 2	S	10	2090,00
7/8 x 2 1/4	S	10	2750,00
7/8 x 2 1/2	S	10	2950,00
7/8 x 2 3/4	S	10	3100,00
7/8 x 3	S	10	3250,00

Abmessungen	VE	Stück	€/100/Obf.
7/8 x 3 1/4	S	10	3450,00
7/8 x 3 1/2	S	10	3700,00
7/8 x 4	S	10	4200,00
7/8 x 4 1/2	S	10	4500,00
7/8 x 5	S	10	4800,00
7/8 x 6	S	10	5600,00
7/8 x 7	S	10	6800,00
1 x 2	S	10	3300,00
1 x 2 1/4	S	10	3800,00
1 x 2 1/2	S	10	4100,00
1 x 2 3/4	S	10	4200,00
1 x 3	S	10	4400,00
1 x 3 1/4	S	10	4700,00
1 x 3 1/2	S	10	4600,00
1 x 4	S	10	4750,00
1 x 4 1/2	S	10	5300,00
1 x 5	S	10	5700,00
1 x 5 1/2	S	10	6800,00
1 x 6	S	10	7300,00
1 x 7	S	10	8400,00
1 x 8	S	10	10000,00
1 1/4 x 2 1/2	S	10	8500,00
1 1/4 x 3	S	10	9100,00
1 1/4 x 3 1/2	S	10	9600,00
1 1/4 x 4	S	10	10200,00
1 1/4 x 4 1/2	S	10	11300,00
1 1/4 x 5	S	10	11900,00
1 1/4 x 5 1/2	S	10	13200,00
1 1/4 x 6	S	10	14200,00
1 1/4 x 7	S	10	17200,00
1 1/4 x 8	S	10	19200,00
1 1/2 x 2 1/2	S	10	14200,00
1 1/2 x 3	S	10	15900,00
1 1/2 x 3 1/2	S	10	17600,00
1 1/2 x 4	S	10	18900,00
1 1/2 x 4 1/2	S	5	19400,00
1 1/2 x 5	S	5	21300,00
1 1/2 x 5 1/2	S	5	23000,00
1 1/2 x 6	S	5	24500,00
1 1/2 x 7	S	5	26300,00
1 1/2 x 8	S	5	31000,00

Artikel 88081.010
88081 14 H GUK
 galvanisch verzinkt



Nutmutter mit nichtmetallischem Klemmteil

Maße → TI-76 Korrosionsschutz → TI-228
 Werkstoffeigensch. → TI-233 REACH → TI-262



Typ-Nr./ Nennmaß

GUK 1/M 12 x 1	S	10	425,00 gal Zn
GUK 2/M 15 x 1	S	10	460,00 gal Zn
GUK 3/M 17 x 1	S	10	520,00 gal Zn
GUK 4/M 20 x 1	S	10	600,00 gal Zn
GUK 5/M 25 x 1,5	S	10	770,00 gal Zn
GUK 6/M 30 x 1,5	S	10	950,00 gal Zn
GUK 7/M 35 x 1,5	S	10	1130,00 gal Zn
GUK 8/M 40 x 1,5	S	10	1440,00 gal Zn
GUK 9/M 45 x 1,5	S	1	1750,00 gal Zn
GUK10/M 50 x 1,5	S	1	2040,00 gal Zn
GUK11/M 55 x 2	S	1	3350,00 gal Zn
GUK12/M 60 x 2	S	1	3600,00 gal Zn

Abmessungen	VE	Stück	€/100/Obf.
-------------	----	-------	------------

Artikel 88086.010
88086 Stahl
 galvanisch verzinkt

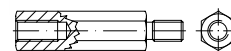

Abstands-/Distanz-Bolzen, mit Sechskant, mit Innen- und Außengewinde

Maße → TI-35 REACH → TI-262
 Korrosionsschutz → TI-228



I-/A-Gew. M x Sechskantlänge/Länge Gewindezapfen

M 3 x 5/ 6	S	100	57,00 gal Zn
M 3 x 6/ 6	S	100	57,00 gal Zn
M 3 x 8/ 6	S	100	59,00 gal Zn
M 3 x 10/ 6	S	100	60,00 gal Zn
M 3 x 12/ 6	S	100	65,00 gal Zn
M 3 x 14/ 6	S	100	66,00 gal Zn
M 3 x 16/ 6	S	100	68,00 gal Zn
M 3 x 20/ 6	S	100	74,00 gal Zn
M 3 x 25/ 6	S	100	74,00 gal Zn
M 3 x 30/ 6	S	100	82,00 gal Zn
M 3 x 35/ 6	S	100	84,00 gal Zn
M 3 x 40/ 6	S	100	89,00 gal Zn
M 3 x 45/ 6	S	100	101,00 gal Zn
M 3 x 50/ 6	S	100	112,00 gal Zn
M 3 x 60/ 6	S	100	134,00 gal Zn
M 4 x 5/ 8	S	100	67,00 gal Zn
M 4 x 6/ 8	S	100	69,00 gal Zn
M 4 x 8/ 8	S	100	73,00 gal Zn
M 4 x 10/ 8	S	100	76,00 gal Zn
M 4 x 12/ 8	S	100	78,00 gal Zn
M 4 x 14/ 8	S	100	82,00 gal Zn
M 4 x 16/ 8	S	100	86,00 gal Zn
M 4 x 18/ 8	S	100	92,00 gal Zn
M 4 x 20/ 8	S	100	95,00 gal Zn
M 4 x 25/ 8	S	100	101,00 gal Zn
M 4 x 30/ 8	S	100	106,00 gal Zn
M 4 x 35/ 8	S	100	112,00 gal Zn
M 4 x 40/ 8	S	100	118,00 gal Zn
M 4 x 45/ 8	S	100	132,00 gal Zn
M 4 x 50/ 8	S	100	136,00 gal Zn
M 4 x 55/ 8	S	100	153,00 gal Zn
M 4 x 60/ 8	S	100	160,00 gal Zn
M 5 x 8/10	S	100	92,00 gal Zn
M 5 x 10/10	S	100	97,00 gal Zn
M 5 x 12/10	S	100	103,00 gal Zn
M 5 x 14/10	S	100	106,00 gal Zn
M 5 x 16/10	S	100	112,00 gal Zn
M 5 x 18/10	S	100	114,00 gal Zn
M 5 x 20/10	S	100	118,00 gal Zn
M 5 x 25/10	S	100	132,00 gal Zn
M 5 x 30/10	S	100	144,00 gal Zn
M 5 x 35/10	S	100	157,00 gal Zn
M 5 x 40/10	S	100	167,00 gal Zn
M 5 x 45/10	S	100	176,00 gal Zn
M 5 x 50/10	S	100	184,00 gal Zn
M 5 x 55/10	S	100	203,00 gal Zn
M 5 x 60/10	S	100	213,00 gal Zn
M 5 x 70/10	S	100	242,00 gal Zn
M 5 x 80/10	S	100	275,00 gal Zn
M 6 x 10/12	S	100	182,00 gal Zn
M 6 x 12/12	S	100	184,00 gal Zn
M 6 x 14/12	S	100	187,00 gal Zn
M 6 x 16/12	S	100	193,00 gal Zn
M 6 x 18/12	S	100	194,00 gal Zn

Abmessungen	VE	Stück	€/100/Obf.
M 6 x 20/12	S	100	201,00 gal Zn
M 6 x 25/12	S	100	205,00 gal Zn
M 6 x 30/12	S	100	217,00 gal Zn
M 6 x 35/12	S	100	236,00 gal Zn
M 6 x 40/12	S	100	246,00 gal Zn
M 6 x 45/12	S	100	260,00 gal Zn
M 6 x 50/12	S	100	275,00 gal Zn
M 6 x 55/12	S	100	285,00 gal Zn
M 6 x 60/12	S	100	300,00 gal Zn
M 6 x 70/12	S	100	340,00 gal Zn
M 6 x 80/12	S	100	380,00 gal Zn
M 6 x 100/12	S	100	480,00 gal Zn

Artikel 88087.010
88087 Stahl galvanisch verzinkt

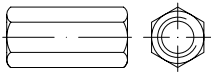

Verbindungs-muffen, Sechskant, durchgehendes Innengewinde

Produktklasse C (g),
 Gewindeeinschraubtiefe: Gruppe N = max. 1,5d

Maße → TI-66 REACH → TI-262
 Korrosionsschutz → TI-228



Innengewinde x Länge/Schlüsselweite (SW)

M 6 x 20 SW10	S	100	85,00 gal Zn
M 6 x 25 SW10	S	100	77,00 gal Zn
M 6 x 30 SW10	S	100	97,00 gal Zn
M 6 x 40 SW10	S	100	115,00 gal Zn
M 8 x 30 SW13	S	100	138,00 gal Zn
M 10 x 30 SW17	S	100	203,00 gal Zn
M 10 x 40 SW13	S	100	212,00 gal Zn
M 10 x 40 SW17	S	100	203,00 gal Zn
M 12 x 40 SW19	S	50	360,00 gal Zn
M 12 x 50 SW19	S	50	390,00 gal Zn
M 16 x 50 SW24	S	25	630,00 gal Zn
M 20 x 50 SW30	S	25	950,00 gal Zn
M 24 x 50 SW36	S	10	1240,00 gal Zn
M 30 x 60 SW46	S	10	2700,00 gal Zn
M 30 x 90 SW46	S	5	4250,00 gal Zn

Abmessungen VE Stück €/100/Obf.
 Artikel 88088.010
88088 Stahl galvanisch verzinkt

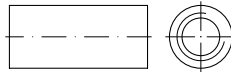

Verbindungs-muffen, rund, durchgehendes Innengewinde

Produktklasse C (g),
 Gewindeeinschraubtiefe: Gruppe N = max. 1,5d

Maße → TI-77 REACH → TI-262
 Korrosionsschutz → TI-228



Innengewinde x Länge x Außen Ø

M 6 x 20 x 10	S	100	47,50 gal Zn
M 6 x 25 x 10	S	100	52,00 gal Zn
M 6 x 30 x 10	S	100	60,00 gal Zn
M 6 x 40 x 10	S	100	84,00 gal Zn
M 8 x 20 x 11	S	100	52,00 gal Zn
M 8 x 25 x 11	S	100	56,00 gal Zn
M 8 x 30 x 11	S	100	65,00 gal Zn
M 8 x 40 x 11	S	100	92,00 gal Zn
M 8 x 50 x 11	S	100	153,00 gal Zn
M 10 x 25 x 13	S	100	79,00 gal Zn
M 10 x 30 x 13	S	100	88,00 gal Zn
M 10 x 40 x 13	S	50	120,00 gal Zn
M 10 x 50 x 13	S	50	154,00 gal Zn
M 12 x 30 x 15	S	50	165,00 gal Zn
M 12 x 40 x 15	S	50	210,00 gal Zn
M 12 x 50 x 15	S	50	305,00 gal Zn
M 16 x 40 x 20	S	25	340,00 gal Zn
M 20 x 50 x 25	S	25	590,00 gal Zn

Artikel 88089.004
88089 Stahl

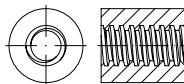

Rundmuttern mit Trapezgewinde, Höhe = 1,5 d

Gewindestangen TR → DIN 975 Trapez

Maße → TI-77 REACH → TI-262



Gewinde x Steigung x Außen Ø

TR 12 x 3 -22	S	1	890,00
TR 14 x 4 -36	S	1	1300,00
TR 16 x 4 -36	S	1	1430,00
TR 18 x 4 -36	S	1	2950,00
TR 20 x 4 -36	S	1	1660,00
TR 22 x 5 -50	S	1	2400,00
TR 24 x 5 -50	S	1	2400,00
TR 26 x 5 -50	S	1	2460,00
TR 28 x 5 -60	S	1	3150,00
TR 30 x 6 -60	S	1	3400,00
TR 32 x 6 -60	S	1	5300,00
TR 36 x 6 -75	S	1	6700,00
TR 40 x 7 -75	S	1	7200,00
TR 44 x 7 -75	S	1	10500,00

Abmessungen VE Stück €/100/Obf.
 Artikel 88090.004
88090 Stahl

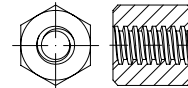

Sechskantmuttern mit Trapezgewinde, Höhe = 1,5 d

Gewindestangen TR → DIN 975 = Trapez

Maße → TI-66 REACH → TI-262



Gewinde x Steigung x SW x Höhe

TR16 x 4-SW27	x	24	S	1	1210,00
TR20 x 4-SW30	x	30	S	1	1300,00
TR24 x 5-SW36	x	36	S	1	1700,00
TR30 x 6-SW46	x	45	S	1	4550,00

Artikel 88091.010
88091 Stahl SPAX Seko-T WIROX



SPAX Universalschrauben mit SPAX 4CUT-Spitze, Seko = SPAX MULTI-Senkopf T = T-STAR plus

gehärtet, gleitbeschichtet

Bits → Artikel 88663, 88654,
 Zierkappen → Artikel 88006

Zulassungen: Z-9.1-235, ETA-12/0114



Nenn Ø x Nennlänge / Gewindelänge ca. - Bit-Größe

3 x 12/10-T10	S	1000	1,90 gal Zn
3 x 12/10-T10	K	200	2,25 gal Zn
3 x 16/13-T10	S	1000	2,15 gal Zn
3 x 16/13-T10	K	200	2,35 gal Zn
3 x 20/16-T10	S	1000	2,30 gal Zn
3 x 20/16-T10	K	200	2,50 gal Zn
3 x 25/21-T10	S	1000	2,40 gal Zn
3 x 25/21-T10	K	200	2,70 gal Zn
3 x 30/26-T10	S	1000	3,15 gal Zn
3 x 30/26-T10	K	200	3,65 gal Zn
3,5 x 15/11-T20*	S	1000	2,40 gal Zn
3,5 x 16/12-T20*	S	1000	2,40 gal Zn
3,5 x 16/12-T20*	K	200	2,70 gal Zn
3,5 x 20/15-T20*	S	1000	2,75 gal Zn
3,5 x 20/15-T20*	K	200	3,05 gal Zn
3,5 x 25/20-T20*	S	1000	3,00 gal Zn
3,5 x 25/20-T20*	K	200	3,35 gal Zn
3,5 x 30/25-T20*	S	1000	3,25 gal Zn
3,5 x 30/25-T20*	K	200	3,75 gal Zn
3,5 x 35/30-T20*	S	1000	4,05 gal Zn
3,5 x 35/30-T20*	K	200	4,50 gal Zn
3,5 x 40/35-T20*	S	1000	4,65 gal Zn
3,5 x 40/35-T20*	K	200	5,20 gal Zn

i

- ✓ Große Artikelvielfalt
- ✓ Verlässliche Qualität
- ✓ Hohe Lieferbereitschaft

Abmessungen	VE	Stück	€/100/Obf.
3,5 x 45/40-T20*	S	1000	7,00 gal Zn
3,5 x 45/40-T20*	K	200	8,00 gal Zn
4 x 15/11-T20	S	1000	2,95 gal Zn
4 x 16/12-T20	S	1000	2,90 gal Zn
4 x 20/15-T20	S	1000	3,15 gal Zn
4 x 25/20-T20	S	1000	3,75 gal Zn
4 x 25/20-T20	K	200	4,05 gal Zn
4 x 30/25-T20	S	1000	3,85 gal Zn
4 x 30/25-T20	K	200	4,30 gal Zn
4 x 35/30-T20	S	1000	4,45 gal Zn
4 x 35/30-T20	K	200	5,10 gal Zn
4 x 40/35-T20	S	1000	5,40 gal Zn
4 x 40/35-T20	K	200	6,00 gal Zn
4 x 45/40-T20	S	500	6,00 gal Zn
4 x 45/40-T20	K	200	6,80 gal Zn
4 x 50/45-T20	S	500	6,70 gal Zn
4 x 50/45-T20	K	200	7,30 gal Zn
4,5 x 16/13-T20	S	1000	3,85 gal Zn
4,5 x 20/16-T20	S	1000	4,20 gal Zn
4,5 x 25/21-T20	S	1000	4,70 gal Zn
4,5 x 30/25-T20	S	1000	5,50 gal Zn
4,5 x 35/29-T20	S	500	5,90 gal Zn
4,5 x 35/29-T20	K	200	6,70 gal Zn
4,5 x 40/34-T20	S	500	6,40 gal Zn
4,5 x 40/34-T20	K	200	7,10 gal Zn
4,5 x 45/39-T20	S	500	8,30 gal Zn
4,5 x 45/39-T20	K	200	9,30 gal Zn
4,5 x 50/44-T20	S	500	8,50 gal Zn
4,5 x 50/44-T20	K	200	9,50 gal Zn
4,5 x 60/54-T20	S	500	10,90 gal Zn
4,5 x 60/54-T20	K	100	12,10 gal Zn
4,5 x 70/59-T20	S	500	17,60 gal Zn
4,5 x 70/59-T20	K	100	20,00 gal Zn
5 x 20/16-T20	S	1000	5,70 gal Zn
5 x 25/21-T20	S	1000	5,70 gal Zn
5 x 30/20-T20	S	500	6,80 gal Zn
5 x 35/30-T20	S	500	7,60 gal Zn
5 x 40/34-T20	S	500	8,30 gal Zn
5 x 40/34-T20	K	200	9,30 gal Zn
5 x 45/39-T20	S	500	9,30 gal Zn
5 x 45/39-T20	K	200	10,40 gal Zn
5 x 50/44-T20	S	500	9,80 gal Zn
5 x 50/44-T20	K	200	11,00 gal Zn
5 x 60/54-T20	S	500	11,80 gal Zn
5 x 60/54-T20	K	100	13,30 gal Zn
5 x 70/60-T20	S	200	16,80 gal Zn
5 x 70/60-T20	K	100	18,50 gal Zn
5 x 80/60-T20	S	200	20,00 gal Zn
5 x 80/60-T20	K	100	21,60 gal Zn
6 x 50/43-T30	S	200	14,30 gal Zn
6 x 50/43-T30	K	100	15,90 gal Zn
6 x 60/53-T30	S	200	16,80 gal Zn
6 x 60/53-T30	K	100	19,10 gal Zn
6 x 70/60-T30	S	200	20,80 gal Zn
6 x 70/60-T30	K	100	23,10 gal Zn
6 x 80/60-T30	S	200	23,10 gal Zn
6 x 80/60-T30	K	100	25,50 gal Zn

Abmessungen	VE	Stück	€/100/Obf.
Artikel	88091.019		
88091	Stahl	SPAX Seko-T-Tg	
	WIROX		

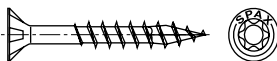

SPAX Universalschrauben mit SPAX 4CUT-Spitze, Seko = SPAX MULTI-Senkkopf T = T-STAR plus Tg = Teilgewinde

gehärtet, gleitbeschichtet ab 6 x 160 mit 4CUT-Fräser

Bits → Artikel 88663, 88654, Zierkappen → Artikel 88006

Zulassungen: Z-9.1-235, ETA-12/0114



Nenn Ø x Nennlänge / Gewindelänge ca. - Bit-Größe

3 x 30/18-T10	S	1000	3,15 gal Zn
3 x 35/23-T10	S	1000	3,75 gal Zn
3 x 40/23-T10	S	1000	5,00 gal Zn
3,5 x 30/17-T20*	S	1000	3,25 gal Zn
3,5 x 30/17-T20*	K	200	3,75 gal Zn
3,5 x 35/22-T20*	S	1000	4,05 gal Zn
3,5 x 35/22-T20*	K	200	4,50 gal Zn
3,5 x 40/22-T20*	S	1000	4,65 gal Zn
3,5 x 40/22-T20*	K	200	5,20 gal Zn
3,5 x 45/30-T20*	S	1000	7,00 gal Zn
3,5 x 45/30-T20*	K	200	8,00 gal Zn
3,5 x 50/32-T20*	S	500	7,60 gal Zn
3,5 x 50/32-T20*	K	200	8,60 gal Zn
4 x 30/17-T20	S	1000	3,85 gal Zn
4 x 30/17-T20	K	200	4,30 gal Zn
4 x 35/22-T20	S	1000	4,45 gal Zn
4 x 35/22-T20	K	200	5,10 gal Zn
4 x 40/22-T20	S	1000	5,40 gal Zn
4 x 40/22-T20	K	200	6,00 gal Zn
4 x 45/30-T20	S	500	6,00 gal Zn
4 x 45/30-T20	K	200	6,80 gal Zn
4 x 50/32-T20	S	500	6,70 gal Zn
4 x 50/32-T20	K	200	7,30 gal Zn
4 x 60/35-T20	S	500	11,10 gal Zn
4 x 60/35-T20	K	100	12,40 gal Zn
4 x 70/42-T20	S	500	17,60 gal Zn
4 x 70/42-T20	K	100	20,00 gal Zn
4 x 80/37-T20	S	200	20,00 gal Zn
4,5 x 30/17-T20	S	1000	5,40 gal Zn
4,5 x 30/17-T20	K	200	5,90 gal Zn
4,5 x 35/24-T20	S	500	5,90 gal Zn
4,5 x 35/24-T20	K	200	6,70 gal Zn
4,5 x 40/24-T20	S	500	6,40 gal Zn
4,5 x 40/24-T20	K	200	7,10 gal Zn
4,5 x 45/29-T20	S	500	8,30 gal Zn
4,5 x 45/29-T20	K	200	9,30 gal Zn
4,5 x 50/32-T20	S	500	8,50 gal Zn
4,5 x 50/32-T20	K	200	9,50 gal Zn
4,5 x 60/37-T20	S	500	10,90 gal Zn
4,5 x 60/37-T20	K	100	12,10 gal Zn
4,5 x 70/42-T20	S	500	17,60 gal Zn
4,5 x 70/42-T20	K	100	20,00 gal Zn
4,5 x 80/49-T20	S	200	20,00 gal Zn
4,5 x 80/49-T20	K	100	22,30 gal Zn
5 x 30/17-T20	S	500	6,80 gal Zn
5 x 30/17-T20	K	200	7,40 gal Zn
5 x 35/24-T20	S	500	7,60 gal Zn
5 x 40/27-T20	S	500	8,30 gal Zn

Abmessungen	VE	Stück	€/100/Obf.
5 x 40/27-T20	K	200	9,30 gal Zn
5 x 45/29-T20	S	500	9,30 gal Zn
5 x 50/32-T20	S	500	9,80 gal Zn
5 x 50/32-T20	K	200	11,00 gal Zn
5 x 55/36-T20	S	500	11,10 gal Zn
5 x 60/36-T20	S	500	11,80 gal Zn
5 x 60/36-T20	K	100	13,30 gal Zn
5 x 70/41-T20	S	200	16,80 gal Zn
5 x 70/41-T20	K	100	18,50 gal Zn
5 x 80/46-T20	S	200	20,00 gal Zn
5 x 80/46-T20	K	100	21,60 gal Zn
5 x 90/60-T20	S	200	25,50 gal Zn
5 x 90/60-T20	K	100	28,50 gal Zn
5 x 100/60-T20	S	200	28,50 gal Zn
5 x 100/60-T20	K	100	31,50 gal Zn
5 x 120/69-T20	S	200	55,00 gal Zn
6 x 40/23-T30	S	500	12,60 gal Zn
6 x 50/32-T30	S	200	14,30 gal Zn
6 x 50/32-T30	K	100	15,90 gal Zn
6 x 60/36-T30	S	200	16,80 gal Zn
6 x 60/36-T30	K	100	19,10 gal Zn
6 x 70/41-T30	S	200	20,80 gal Zn
6 x 70/41-T30	K	100	23,10 gal Zn
6 x 80/46-T30	S	200	23,10 gal Zn
6 x 80/46-T30	K	100	25,50 gal Zn
6 x 90/60-T30	S	200	26,50 gal Zn
6 x 90/60-T30	K	100	29,50 gal Zn
6 x 100/60-T30	S	100	30,00 gal Zn
6 x 110/68-T30	S	100	40,50 gal Zn
6 x 120/68-T30	S	100	46,00 gal Zn
6 x 130/68-T30	S	100	51,00 gal Zn
6 x 140/68-T30	S	100	59,00 gal Zn
6 x 150/68-T30	S	100	67,00 gal Zn
6 x 160/68-T30	S	100	80,00 gal Zn
6 x 180/68-T30	S	100	107,00 gal Zn
6 x 200/68-T30	S	100	131,00 gal Zn
6 x 220/68-T30	S	100	167,00 gal Zn
6 x 240/68-T30	S	100	176,00 gal Zn
6 x 260/68-T30	S	100	191,00 gal Zn
6 x 280/68-T30	S	100	204,00 gal Zn
6 x 300/68-T30	S	100	229,00 gal Zn

Abmessungen	VE	Stück	€/100/Obf.
Artikel	88091.060		
88091	Stahl	SPAX Seko-T	
	YELLOW		



SPAX Universalschrauben mit SPAX 4CUT-Spitze, Seko = SPAX MULTI-Senkkopf T = T-STAR plus

gehärtet, gleitbeschichtet ab 6 x 160 mit 4CUT-Fräser

Bits → Artikel 88663, 88654, Zierkappen → Artikel 88006

Zulassungen: Z-9.1-235, ETA-12/0114 ab Ø8 Z-9.1-449, Z-9.1-511, ETA-12/0114



Nenn Ø x Nennlänge / Gewindelänge ca. - Bit-Größe

3 x 12/10-T10	S	1000	1,90 YELLOW
3 x 12/10-T10	K	200	2,25 YELLOW
3 x 16/13-T10	S	1000	2,15 YELLOW
3 x 16/13-T10	K	200	2,35 YELLOW
3 x 20/16-T10	S	1000	2,30 YELLOW
3 x 20/16-T10	K	200	2,50 YELLOW
3 x 25/21-T10	S	1000	2,40 YELLOW

Abmessungen	VE	Stück	€/100/Obf.
3 x 25/ 21-T10	K	200	2,70 YELLOX
3,5 x 16/ 12-T20*	S	1000	2,40 YELLOX
3,5 x 20/ 15-T20*	S	1000	2,75 YELLOX
3,5 x 25/ 20-T20*	S	1000	3,00 YELLOX
3,5 x 25/ 20-T20*	K	200	3,35 YELLOX
4 x 20/ 15-T20	S	1000	3,15 YELLOX
4 x 20/ 15-T20	K	200	3,45 YELLOX
4 x 25/ 20-T20	S	1000	3,75 YELLOX
4 x 25/ 20-T20	K	200	4,05 YELLOX

Artikel 88091.069
88091 Stahl SPAX Seko-T-Tg
 YELLOX

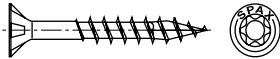

SPAX Universalschrauben mit SPAX 4CUT-Spitze, Seko = SPAX MULTI-Senkkopf T = T-STAR plus Tg = Teilgewinde

gehärtet, gleitbeschichtet
 ab 6x160 mit 4CUT-Fräser

Bits → Artikel 88663, 88654,
 Zierkappen → Artikel 88006

Zulassungen: Z-9.1-235, ETA-12/0114
 ab Ø8 Z-9.1-449, Z-9.1-511, ETA-12/0114



Nenn Ø x Nennlänge / Gewindelänge ca. - Bit-Größe

3 x 30/ 18-T10	S	1000	3,15 YELLOX
3 x 30/ 18-T10	K	200	3,65 YELLOX
3 x 35/ 23-T10	S	1000	3,75 YELLOX
3 x 35/ 23-T10	K	200	4,05 YELLOX
3 x 40/ 23-T10	S	1000	5,00 YELLOX
3 x 40/ 23-T10	K	200	5,60 YELLOX
3,5 x 30/ 18-T20*	S	1000	3,25 YELLOX
3,5 x 30/ 17-T20*	K	200	3,75 YELLOX
3,5 x 35/ 23-T20*	S	1000	4,05 YELLOX
3,5 x 35/ 22-T20*	K	200	4,50 YELLOX
3,5 x 40/ 23-T20*	S	1000	4,65 YELLOX
3,5 x 40/ 22-T20*	K	200	5,20 YELLOX
3,5 x 45/ 30-T20*	S	1000	7,00 YELLOX
3,5 x 50/ 32-T20*	S	500	7,60 YELLOX
3,5 x 50/ 32-T20*	K	200	8,60 YELLOX
4 x 30/ 18-T20	S	1000	3,85 YELLOX
4 x 30/ 17-T20	K	200	4,30 YELLOX
4 x 35/ 23-T20	S	1000	4,45 YELLOX
4 x 35/ 22-T20	K	200	5,10 YELLOX
4 x 40/ 23-T20	S	1000	5,40 YELLOX
4 x 40/ 22-T20	K	200	6,00 YELLOX
4 x 45/ 30-T20	S	500	6,00 YELLOX
4 x 45/ 30-T20	K	200	6,80 YELLOX
4 x 50/ 32-T20	S	500	6,70 YELLOX
4 x 50/ 32-T20	K	200	7,30 YELLOX
4 x 60/ 35-T20	S	500	11,10 YELLOX
4 x 60/ 35-T20	K	100	12,40 YELLOX
4 x 70/ 37-T20	S	500	17,60 YELLOX
4 x 70/ 42-T20	K	100	20,00 YELLOX
4 x 50/ 37-T20	S	200	20,00 YELLOX
4,5 x 30/ 17-T20	S	1000	5,40 YELLOX
4,5 x 30/ 17-T20	K	200	5,90 YELLOX
4,5 x 35/ 25-T20	S	500	5,90 YELLOX
4,5 x 35/ 24-T20	K	200	6,70 YELLOX
4,5 x 40/ 25-T20	S	500	6,40 YELLOX
4,5 x 40/ 24-T20	K	200	7,10 YELLOX
4,5 x 45/ 30-T20	S	500	8,30 YELLOX

Abmessungen	VE	Stück	€/100/Obf.
4,5 x 45/ 29-T20	K	200	9,30 YELLOX
4,5 x 50/ 32-T20	S	500	8,50 YELLOX
4,5 x 50/ 32-T20	K	200	9,50 YELLOX
4,5 x 60/ 37-T20	S	500	10,90 YELLOX
4,5 x 60/ 37-T20	K	100	12,10 YELLOX
4,5 x 70/ 42-T20	S	500	17,60 YELLOX
4,5 x 70/ 42-T20	K	100	20,00 YELLOX
4,5 x 80/ 47-T20	S	200	20,00 YELLOX
4,5 x 80/ 49-T20	K	100	22,30 YELLOX
5 x 30/ 17-T20	S	500	6,80 YELLOX
5 x 30/ 17-T20	K	200	7,40 YELLOX
5 x 35/ 25-T20	S	500	7,60 YELLOX
5 x 40/ 27-T20	S	500	8,30 YELLOX
5 x 40/ 27-T20	K	200	9,30 YELLOX
5 x 45/ 30-T20	S	500	9,30 YELLOX
5 x 50/ 32-T20	S	500	9,80 YELLOX
5 x 50/ 32-T20	K	200	11,00 YELLOX
5 x 55/ 37-T20	S	500	11,10 YELLOX
5 x 60/ 37-T20	S	500	11,80 YELLOX
5 x 60/ 36-T20	K	100	13,30 YELLOX
5 x 70/ 41-T20	S	200	16,80 YELLOX
5 x 70/ 41-T20	K	100	18,50 YELLOX
5 x 80/ 46-T20	S	200	20,00 YELLOX
5 x 80/ 46-T20	K	100	21,60 YELLOX
5 x 90/ 61-T20	S	200	25,50 YELLOX
5 x 90/ 60-T20	K	100	28,50 YELLOX
5 x 100/ 61-T20	S	200	28,50 YELLOX
5 x 100/ 60-T20	K	100	31,50 YELLOX
5 x 120/ 69-T20	S	200	55,00 YELLOX
6 x 40/ 24-T30	S	500	12,60 YELLOX
6 x 50/ 32-T30	S	200	14,30 YELLOX
6 x 50/ 32-T30	K	100	15,90 YELLOX
6 x 60/ 37-T30	S	200	16,80 YELLOX
6 x 60/ 36-T30	K	100	19,10 YELLOX
6 x 70/ 41-T30	S	200	20,80 YELLOX
6 x 70/ 41-T30	K	100	23,10 YELLOX
6 x 80/ 46-T30	S	200	23,10 YELLOX
6 x 80/ 46-T30	K	100	25,50 YELLOX
6 x 90/ 61-T30	S	200	26,50 YELLOX
6 x 100/ 61-T30	S	100	30,00 YELLOX
6 x 110/ 68-T30	S	100	40,50 YELLOX
6 x 120/ 68-T30	S	100	46,00 YELLOX
6 x 130/ 68-T30	S	100	51,00 YELLOX
6 x 140/ 68-T30	S	100	59,00 YELLOX
6 x 150/ 68-T30	S	100	67,00 YELLOX
6 x 160/ 68-T30	S	100	80,00 YELLOX
6 x 180/ 68-T30	S	100	107,00 YELLOX
6 x 200/ 68-T30	S	100	131,00 YELLOX
6 x 220/ 68-T30	S	100	167,00 YELLOX
6 x 240/ 68-T30	S	100	176,00 YELLOX
6 x 260/ 68-T30	S	100	191,00 YELLOX
6 x 280/ 68-T30	S	100	204,00 YELLOX
6 x 300/ 68-T30	S	100	229,00 YELLOX

Abmessungen	VE	Stück	€/100/Obf.
Artikel	88091.039		
88091	Stahl	SPAX Seko-T-Tg	
	WIROX		



SPAX Universalschrauben mit SPAX 4CUT-Spitze, Seko = SPAX MULTI-Senkkopf T = T-STAR plus Tg = Teilgewinde

gehärtet, gleitbeschichtet,
 ab 8x160 mit 4CUT-Fräser

Bits → Artikel 88663, 88654

Zulassungen: Z-9.1-449, Z-9.1-551, ETA-12/0114



Nenn Ø x Nennlänge / Gewindelänge ca. - Bit-Größe

8 x 80/47-T40	S	50	46,50 gal Zn
8 x 100/57-T40	S	50	56,00 gal Zn
8 x 120/70-T40	S	50	72,00 gal Zn
8 x 140/80-T40	S	50	84,00 gal Zn
8 x 160/80-T40	S	50	111,00 gal Zn
8 x 180/80-T40	S	50	126,00 gal Zn
8 x 200/80-T40	S	50	150,00 gal Zn
8 x 220/80-T40	S	50	195,00 gal Zn
8 x 240/80-T40	S	50	208,00 gal Zn
8 x 260/80-T40	S	50	226,00 gal Zn
8 x 280/80-T40	S	50	237,00 gal Zn
8 x 300/80-T40	S	50	268,00 gal Zn
8 x 320/80-T40	S	50	281,00 gal Zn
8 x 340/80-T40	S	50	307,00 gal Zn
8 x 360/80-T40	S	50	332,00 gal Zn
8 x 380/80-T40	S	50	347,00 gal Zn
8 x 400/80-T40	S	50	365,00 gal Zn
8 x 450/80-T40	S	50	559,00 gal Zn
10 x 80/50-T50	S	50	72,00 gal Zn
10 x 100/60-T50	S	50	80,00 gal Zn
10 x 120/70-T50	S	50	90,00 gal Zn
10 x 140/70-T50	S	50	103,00 gal Zn
10 x 160/80-T50	S	50	120,00 gal Zn
10 x 180/80-T50	S	50	133,00 gal Zn
10 x 200/80-T50	S	50	176,00 gal Zn
10 x 220/80-T50	S	50	226,00 gal Zn
10 x 240/80-T50	S	50	246,00 gal Zn
10 x 260/80-T50	S	50	297,00 gal Zn
10 x 280/80-T50	S	50	328,00 gal Zn
10 x 300/80-T50	S	50	349,00 gal Zn
10 x 320/80-T50	S	50	369,00 gal Zn
10 x 340/80-T50	S	50	405,00 gal Zn
10 x 360/80-T50	S	50	430,00 gal Zn
10 x 400/80-T50	S	50	491,00 gal Zn
10 x 450/80-T50	S	50	645,00 gal Zn
12 x 280/100-T50	S	25	395,00 gal Zn

Abmessungen	VE Stück	€/100/Obf.
Artikel 89021.030		
89021 Sortiment L-BOXX		
Stahl, geh. WIROX		

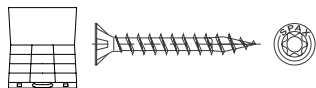

SPAX-Sortiment L-BOXX / L-BOXX mini, mit Senkkopf und Innensechsrund T

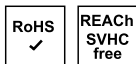

Montagekoffer	S	1	31400,00 gal Zn
Montagekoffer	S	1	8300,00 gal Zn

Abmessungen	VE Stück	€/100/Obf.
Artikel 89021.050		
89021 Sortiment L-BOXX		
Stahl, geh. YELLOX		



SPAX-Sortiment L-BOXX, mit Senkkopf und Kreuzschlitz Z

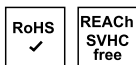

Montagekoffer	S	1	13500,00 YELLOX
---------------	---	---	-----------------

Abmessungen	VE Stück	€/100/Obf.
Artikel 88196.030		
88196 Stahl SPAX Seko-T		
WIROX		

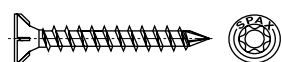

SPAX Schrauben mit Vollgewinde, mit SPAX CUT-Spitze, Seko = SPAX MULTI-Senkkopf T = T-STAR plus/T-STAR

gehärtet, gleitbeschichtet, Ø 10/12 = Senkkopf mit Fräsrippen und T-STAR

Bits → Artikel 88663, 88654

Zulassungen: Z-9.1-519, ETA-12/0114



Nenn Ø x Nennlänge - Bit-Größe

8	x	160 -T40	S	50	262,00 gal Zn
8	x	180 -T40	S	50	277,00 gal Zn
8	x	200 -T40	S	50	284,00 gal Zn
8	x	220 -T40	S	50	315,00 gal Zn
8	x	240 -T40	S	50	330,00 gal Zn
8	x	260 -T40	S	50	372,00 gal Zn
8	x	280 -T40	S	50	378,00 gal Zn
8	x	300 -T40	S	50	440,00 gal Zn

Abmessungen	VE Stück	€/100/Obf.			
8	x	350 -T40	S	50	505,00 gal Zn
8	x	400 -T40	S	50	536,00 gal Zn
8	x	450 -T40	S	50	896,00 gal Zn
8	x	500 -T40	S	25	1006,00 gal Zn
8	x	550 -T40	S	25	1115,00 gal Zn
8	x	600 -T40	S	25	1225,00 gal Zn
10	x	200 -T50	S	50	297,00 gal Zn
10	x	220 -T50	S	50	361,00 gal Zn
10	x	240 -T50	S	50	393,00 gal Zn
10	x	260 -T50	S	50	470,00 gal Zn
10	x	280 -T50	S	50	529,00 gal Zn
10	x	300 -T50	S	50	559,00 gal Zn
10	x	350 -T50	S	50	660,00 gal Zn
10	x	400 -T50	S	50	786,00 gal Zn
10	x	450 -T50	S	50	1070,00 gal Zn
10	x	500 -T50	S	25	1382,00 gal Zn
10	x	550 -T50	S	25	1539,00 gal Zn
12	x	200 -T50	S	25	299,00 gal Zn
12	x	240 -T50	S	25	440,00 gal Zn
12	x	300 -T50	S	25	613,00 gal Zn
12	x	350 -T50	S	25	771,00 gal Zn
12	x	400 -T50	S	25	896,00 gal Zn
12	x	450 -T50	S	25	1132,00 gal Zn
12	x	500 -T50	S	25	1413,00 gal Zn
12	x	550 -T50	S	20	1650,00 gal Zn
12	x	600 -T50	S	20	2200,00 gal Zn

Abmessungen	VE Stück	€/100/Obf.
Artikel 88006.*		
88006 Kunststoff ISR		



Zierkappen für Senkschrauben mit Innensechsrund

weiß RAL 9010 (*630), hellbraun RAL 8001 (*640), dunkelbraun RAL 8014 (*650), rehbraun RAL 8007 (*660)

REACH → TI-262

ISR-Nummer x Kappen Ø/für Schrauben Ø

15	x	12 / 3,5	S	1000	3,45
20	x	12 / 4-4,5	S	1000	3,45
25	x	13,5 / 5	S	1000	3,45
30	x	16,5 / 6	S	1000	3,45

Abmessungen	VE Stück	€/100/Obf.
Artikel 88092.010		
88092 Stahl SPAX Liko-Z		
WIROX		

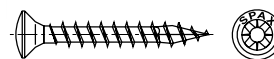

SPAX Universalschrauben mit SPAX 4CUT-Spitze, Liko = SPAX MULTI-Linsensenkopf Z = Pozidriv-Kreuzschlitz

gehärtet, gleitbeschichtet, Bit-Größe: Ø 3,5 - 5,0 → Z2

Zulassungen: Z-9.1-235, ETA-12/0114



Nenn Ø x Nennlänge / Gewindelänge ca.

3,5	x	15/11-Z	S	1000	2,80 gal Zn
3,5	x	16/12-Z	S	1000	2,80 gal Zn
3,5	x	20/15-Z	S	1000	3,15 gal Zn
3,5	x	25/20-Z	S	1000	3,45 gal Zn
3,5	x	30/25-Z	S	1000	3,80 gal Zn
4	x	16/12-Z	S	1000	3,45 gal Zn
4	x	20/15-Z	S	1000	3,75 gal Zn
4	x	25/20-Z	S	1000	4,25 gal Zn
4	x	30/25-Z	S	1000	4,45 gal Zn
4	x	35/30-Z	S	1000	5,20 gal Zn

Abmessungen	VE Stück	€/100/Obf.
Artikel 88092.030		
88092 Stahl SPAX Liko-Z		
galvanisch vernickelt		

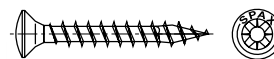

SPAX Universalschrauben mit SPAX 4CUT-Spitze, Liko = SPAX MULTI-Linsensenkopf Z = Pozidriv-Kreuzschlitz

gehärtet, gleitbeschichtet, Bit-Größen: Ø 3 → Z1, Ø 3,5 - 5,0 → Z2

Zulassungen: Z-9.1-235, ETA-12/0114



Nenn Ø x Nennlänge / Gewindelänge ca.

3,5	x	16/12-Z	S	1000	3,60 gal Ni
3,5	x	20/15-Z	S	1000	4,25 gal Ni
3,5	x	25/20-Z	S	1000	4,50 gal Ni
3,5	x	30/25-Z	S	1000	5,00 gal Ni
4	x	16/12-Z	S	1000	4,45 gal Ni
4	x	20/15-Z	S	1000	4,85 gal Ni
4	x	25/20-Z	S	1000	5,50 gal Ni
4	x	30/25-Z	S	1000	5,70 gal Ni
4	x	35/30-Z	S	1000	6,80 gal Ni

Abmessungen	VE Stück	€/100/Obf.
Artikel 88093.010		
88093 Stahl WIROX	SPAX Ruko-Z	



SPAX Universalschrauben mit SPAX 4CUT-Spitze, Ruko = Halbrundkopf Z = Pozidriv-Kreuzschlitz

gehärtet, gleitbeschichtet, Bit-Größen: Ø 3 → Z1, Ø 3,5 - 5,0 → Z2, Ø 6 → 3

Zulassungen: Z-9.1-235, ETA-12/0114



Nenn Ø x Nennlänge / Gewindelänge ca.

3	x	10/ 8-Z	S	1000	2,35 gal Zn
3	x	12/11-Z	S	1000	2,35 gal Zn
3	x	13/11-Z	S	1000	2,40 gal Zn
3	x	15/13-Z	S	1000	2,40 gal Zn
3	x	16/15-Z	S	1000	2,50 gal Zn
3	x	20/18-Z	S	1000	2,70 gal Zn
3	x	25/23-Z	S	1000	2,95 gal Zn
3	x	30/28-Z	S	1000	3,85 gal Zn
3,5	x	12/11-Z	S	1000	2,95 gal Zn
3,5	x	15/12-Z	S	1000	2,95 gal Zn
3,5	x	16/14-Z	S	1000	2,95 gal Zn
3,5	x	20/17-Z	S	1000	3,35 gal Zn
3,5	x	25/22-Z	S	1000	3,60 gal Zn
3,5	x	30/27-Z	S	1000	3,95 gal Zn
3,5	x	35/32-Z	S	1000	4,95 gal Zn
3,5	x	40/37-Z	S	1000	5,60 gal Zn
4	x	12/10-Z	S	1000	3,75 gal Zn
4	x	15/12-Z	S	1000	3,55 gal Zn
4	x	16/14-Z	S	1000	3,55 gal Zn
4	x	20/17-Z	S	1000	3,85 gal Zn
4	x	25/22-Z	S	1000	4,45 gal Zn
4	x	30/27-Z	S	1000	4,65 gal Zn
4	x	35/32-Z	S	1000	5,40 gal Zn
4	x	40/37-Z	S	500	6,40 gal Zn
4	x	45/42-Z	S	500	7,20 gal Zn
4	x	50/47-Z	S	500	7,90 gal Zn
4	x	60/50-Z	S	500	13,30 gal Zn
4,5	x	12/10-Z	S	1000	4,95 gal Zn
4,5	x	15/12-Z	S	1000	4,95 gal Zn
4,5	x	16/14-Z	S	1000	4,95 gal Zn
4,5	x	20/17-Z	S	1000	5,40 gal Zn
4,5	x	25/22-Z	S	1000	5,90 gal Zn
4,5	x	30/27-Z	S	500	6,40 gal Zn
4,5	x	35/32-Z	S	500	7,00 gal Zn
4,5	x	40/37-Z	S	500	7,80 gal Zn
4,5	x	45/42-Z	S	500	9,90 gal Zn
4,5	x	50/47-Z	S	500	10,20 gal Zn
4,5	x	60/57-Z	S	500	12,90 gal Zn
5	x	15/12-Z	S	1000	7,10 gal Zn
5	x	16/14-Z	S	1000	7,10 gal Zn
5	x	20/17-Z	S	1000	7,10 gal Zn
5	x	25/21-Z	S	500	7,30 gal Zn
5	x	30/26-Z	S	500	8,00 gal Zn
5	x	35/31-Z	S	500	9,20 gal Zn
5	x	40/36-Z	S	500	9,90 gal Zn
5	x	45/41-Z	S	200	11,10 gal Zn
5	x	50/46-Z	S	200	11,70 gal Zn
5	x	60/56-Z	S	200	14,30 gal Zn
5	x	70/60-Z	S	200	20,00 gal Zn
5	x	80/60-Z	S	200	23,90 gal Zn
5	x	90/60-Z	S	200	30,00 gal Zn
6	x	25/21-Z	S	500	13,80 gal Zn

Abmessungen	VE Stück	€/100/Obf.			
6	x	30/26-Z	S	500	15,20 gal Zn
6	x	35/31-Z	S	500	15,20 gal Zn
6	x	40/36-Z	S	500	15,20 gal Zn
6	x	50/46-Z	S	200	16,80 gal Zn
6	x	60/56-Z	S	200	20,80 gal Zn
6	x	70/60-Z	S	200	24,80 gal Zn
6	x	80/60-Z	S	200	27,00 gal Zn
6	x	90/60-Z	S	200	31,00 gal Zn

Abmessungen	VE Stück	€/100/Obf.
Artikel 88093.014		
88093 Stahl WIROX	SPAX Ruko-T	



SPAX Universalschrauben mit SPAX 4CUT-Spitze, Ruko = Halbrundkopf T = T-STAR plus

gehärtet, gleitbeschichtet

Bits → Artikel 88663, 88654, Zierkappen → Artikel 88006

Zulassungen: Z-9.1-235, ETA-12/0114



Nenn Ø x Nennlänge / Gewindelänge ca. - Bit-Größe

3	x	12/11-T10	K	200	2,70 gal Zn
3	x	16/15-T10	K	200	2,75 gal Zn
3	x	20/18-T10	K	200	3,00 gal Zn
3,5	x	12/11-T15	S	1000	2,95 gal Zn
3,5	x	15/12-T15	S	1000	2,95 gal Zn
3,5	x	16/14-T15	S	1000	2,95 gal Zn
3,5	x	20/17-T15	S	1000	3,35 gal Zn
3,5	x	25/22-T15	S	1000	3,60 gal Zn
3,5	x	30/27-T15	S	1000	3,95 gal Zn
3,5	x	35/32-T15	S	1000	4,95 gal Zn
4	x	12/10-T20	S	1000	3,75 gal Zn
4	x	15/12-T20	S	1000	3,55 gal Zn
4	x	16/14-T20	S	1000	3,55 gal Zn
4	x	20/17-T20	K	200	4,00 gal Zn
4	x	25/22-T20	S	1000	4,45 gal Zn
4	x	30/27-T20	S	1000	4,65 gal Zn
4	x	35/32-T20	S	1000	5,40 gal Zn
4	x	40/37-T20	S	500	6,40 gal Zn
4	x	45/42-T20	K	200	7,20 gal Zn
4	x	50/47-T20	S	500	7,90 gal Zn
4	x	60/50-T20	S	500	13,30 gal Zn
4,5	x	12/10-T20	S	1000	4,95 gal Zn
4,5	x	15/12-T20	S	1000	4,95 gal Zn
4,5	x	16/14-T20	S	1000	4,95 gal Zn
4,5	x	20/17-T20	S	1000	5,40 gal Zn
4,5	x	25/22-T20	K	200	6,00 gal Zn
4,5	x	30/27-T20	S	1000	6,40 gal Zn
4,5	x	35/32-T20	S	1000	7,00 gal Zn
4,5	x	40/37-T20	S	500	7,80 gal Zn
4,5	x	45/42-T20	K	200	8,00 gal Zn
4,5	x	50/47-T20	S	500	7,90 gal Zn
4,5	x	60/50-T20	S	500	13,30 gal Zn
4,5	x	70/60-T20	S	200	20,00 gal Zn
4,5	x	80/60-T20	S	200	23,90 gal Zn
4,5	x	90/60-T20	S	200	30,00 gal Zn
4,5	x	100/60-T30	S	100	37,00 gal Zn

Abmessungen	VE Stück	€/100/Obf.			
4,5	x	45/42-T20	S	500	9,90 gal Zn
4,5	x	45/42-T20	K	200	11,10 gal Zn
4,5	x	50/47-T20	S	500	10,20 gal Zn
4,5	x	50/47-T20	K	200	11,30 gal Zn
4,5	x	60/57-T20	S	500	12,90 gal Zn
5	x	16/14-T20	S	1000	7,10 gal Zn
5	x	20/17-T20	S	1000	7,10 gal Zn
5	x	20/17-T20	K	200	8,00 gal Zn
5	x	25/21-T20	S	500	7,30 gal Zn
5	x	25/22-T20	K	200	8,10 gal Zn
5	x	30/26-T20	S	500	8,00 gal Zn
5	x	30/27-T20	K	200	8,90 gal Zn
5	x	35/31-T20	S	500	9,20 gal Zn
5	x	35/32-T20	K	200	10,30 gal Zn
5	x	40/36-T20	S	500	9,90 gal Zn
5	x	40/37-T20	K	200	11,10 gal Zn
5	x	50/46-T20	S	200	11,70 gal Zn
5	x	50/46-T20	K	100	13,20 gal Zn
5	x	60/56-T20	S	200	14,30 gal Zn
5	x	60/56-T20	K	100	15,90 gal Zn
5	x	70/60-T20	S	200	20,00 gal Zn
5	x	70/61-T20	K	100	22,30 gal Zn
5	x	80/60-T20	S	200	23,90 gal Zn
5	x	80/61-T20	K	100	26,50 gal Zn
5	x	90/60-T20	S	200	30,00 gal Zn
6	x	20/16-T30	S	500	13,80 gal Zn
6	x	25/21-T30	S	500	13,80 gal Zn
6	x	30/26-T30	S	500	15,20 gal Zn
6	x	35/31-T30	S	500	15,20 gal Zn
6	x	40/36-T30	S	500	15,20 gal Zn
6	x	40/37-T30	K	200	16,80 gal Zn
6	x	50/46-T30	S	200	16,80 gal Zn
6	x	50/46-T30	K	100	19,10 gal Zn
6	x	60/56-T30	S	200	20,80 gal Zn
6	x	70/60-T30	S	200	24,80 gal Zn
6	x	80/60-T30	S	200	27,00 gal Zn
6	x	90/60-T30	S	200	31,00 gal Zn
6	x	100/60-T30	S	100	37,00 gal Zn

Abmessungen	VE Stück	€/100/Obf.
Artikel 88094.040		
88094 Stahl brüniert	SPAX Seko-Z	



SPAX Universalschrauben mit SPAX 4CUT-Spitze, Seko = SPAX MULTI-Senkopf Z = Pozidriv-Kreuzschlitz

gehärtet, gleitbeschichtet, Bit-Größen: Ø 2,5 - 3 → Z1, Ø 3,5 - 5,0 → Z2, Ø 6 → 3

Zulassungen: Z-9.1-235, ETA-12/0114



Nenn Ø x Nennlänge / Gewindelänge ca.

2,5	x	12/10-Z	S	1000	2,55 brün
2,5	x	16/14-Z	S	1000	2,55 brün
2,5	x	20/17-Z	S	1000	2,90 brün
3	x	12/10-Z	S	1000	2,55 brün
3	x	16/13-Z	S	1000	2,70 brün
3	x	20/16-Z	S	1000	2,95 brün
3	x	25/21-Z	S	1000	3,15 brün
3	x	30/26-Z	S	1000	4,30 brün
3	x	35/31-Z	S	1000	4,70 brün
3	x	40/36-Z	S	1000	8,00 brün
3,5	x	12/ 9-Z	S	1000	3,15 brün
3,5	x	16/12-Z	S	1000	3,15 brün

Abmessungen	VE	Stück	€/100/Obf.	Abmessungen	VE	Stück	€/100/Obf.	Abmessungen	VE	Stück	€/100/Obf.
3,5 x 20/15-Z	S	1000	3,60 brün	3 x 13/10-Z	S	1000	1,90 gal Zn	4,5 x 45/39-Z	S	500	8,30 gal Zn
3,5 x 25/20-Z	S	1000	3,95 brün	3 x 15/12-Z	S	1000	1,95 gal Zn	4,5 x 45/39-Z	K	200	9,30 gal Zn
3,5 x 30/25-Z	S	1000	4,30 brün	3 x 16/13-Z	S	1000	2,15 gal Zn	4,5 x 50/44-Z	S	500	8,50 gal Zn
3,5 x 35/30-Z	S	1000	5,30 brün	3 x 16/13-Z	K	200	2,35 gal Zn	4,5 x 50/44-Z	K	200	9,50 gal Zn
3,5 x 40/35-Z	S	1000	6,00 brün	3 x 17/13-Z	S	1000	2,15 gal Zn	4,5 x 55/49-Z	S	500	10,30 gal Zn
3,5 x 45/40-Z	S	1000	9,20 brün	3 x 20/16-Z	S	1000	2,30 gal Zn	4,5 x 60/54-Z	S	500	10,90 gal Zn
3,5 x 50/40-Z	S	500	9,90 brün	3 x 20/16-Z	K	200	2,50 gal Zn	4,5 x 60/54-Z	K	100	12,10 gal Zn
4 x 16/12-Z	S	1000	3,85 brün	3 x 25/21-Z	S	1000	2,40 gal Zn	4,5 x 70/59-Z	S	500	17,60 gal Zn
4 x 20/15-Z	S	1000	4,15 brün	3 x 25/21-Z	K	200	2,70 gal Zn	4,5 x 70/59-Z	K	100	20,00 gal Zn
4 x 25/20-Z	S	1000	4,65 brün	3 x 30/26-Z	S	1000	3,15 gal Zn	4,5 x 80/59-Z	S	200	20,00 gal Zn
4 x 30/25-Z	S	1000	5,10 brün	3 x 30/26-Z	K	200	3,65 gal Zn	4,5 x 80/59-Z	K	100	22,30 gal Zn
4 x 35/30-Z	S	1000	5,90 brün	3 x 35/31-Z	S	1000	3,75 gal Zn	5 x 16/12-Z	S	1000	5,60 gal Zn
4 x 40/35-Z	S	1000	7,00 brün	3 x 35/31-Z	K	200	4,05 gal Zn	5 x 20/14-Z	S	1000	5,70 gal Zn
4 x 45/40-Z	S	500	7,80 brün	3 x 40/36-Z	S	1000	5,00 gal Zn	5 x 20/14-Z	K	200	6,80 gal Zn
4 x 50/45-Z	S	500	8,50 brün	3 x 40/36-Z	K	200	5,60 gal Zn	5 x 25/19-Z	S	1000	5,70 gal Zn
4 x 60/50-Z	S	500	14,40 brün	3 x 45/36-Z	S	1000	6,80 gal Zn	5 x 25/19-Z	K	200	6,90 gal Zn
4 x 70/50-Z	S	500	23,10 brün	3,5 x 12/ 9-Z	S	1000	2,40 gal Zn	5 x 30/24-Z	S	500	6,80 gal Zn
4,5 x 25/19-Z	S	1000	6,30 brün	3,5 x 12/ 9-Z	K	200	2,70 gal Zn	5 x 30/24-Z	K	200	7,40 gal Zn
4,5 x 30/24-Z	S	1000	6,90 brün	3,5 x 13/ 9-Z	S	1000	2,40 gal Zn	5 x 35/29-Z	S	500	7,60 gal Zn
4,5 x 35/29-Z	S	500	7,60 brün	3,5 x 15/11-Z	S	1000	2,40 gal Zn	5 x 35/29-Z	K	200	8,60 gal Zn
4,5 x 40/34-Z	S	500	8,30 brün	3,5 x 16/12-Z	S	1000	2,40 gal Zn	5 x 40/34-Z	S	500	8,30 gal Zn
4,5 x 45/39-Z	S	500	10,70 brün	3,5 x 16/12-Z	K	200	2,70 gal Zn	5 x 40/34-Z	K	200	9,30 gal Zn
4,5 x 50/44-Z	S	500	11,10 brün	3,5 x 17/12-Z	S	1000	2,40 gal Zn	5 x 45/39-Z	S	500	9,30 gal Zn
4,5 x 60/54-Z	S	500	13,90 brün	3,5 x 20/15-Z	S	1000	2,75 gal Zn	5 x 45/39-Z	K	200	10,40 gal Zn
4,5 x 70/59-Z	S	500	23,10 brün	3,5 x 20/15-Z	K	200	3,05 gal Zn	5 x 50/44-Z	S	500	9,80 gal Zn
4,5 x 80/59-Z	S	200	25,50 brün	3,5 x 25/20-Z	S	1000	3,00 gal Zn	5 x 50/44-Z	K	200	11,00 gal Zn
5 x 30/24-Z	S	500	8,60 brün	3,5 x 25/20-Z	K	200	3,35 gal Zn	5 x 55/49-Z	S	500	11,10 gal Zn
5 x 35/29-Z	S	500	9,90 brün	3,5 x 30/25-Z	S	1000	3,25 gal Zn	5 x 60/54-Z	S	500	11,80 gal Zn
5 x 40/34-Z	S	500	10,80 brün	3,5 x 30/25-Z	K	200	3,75 gal Zn	5 x 60/54-Z	K	100	13,30 gal Zn
5 x 45/39-Z	S	500	12,10 brün	3,5 x 35/30-Z	S	1000	4,05 gal Zn	5 x 65/59-Z	S	200	16,90 gal Zn
5 x 50/44-Z	S	500	12,60 brün	3,5 x 35/30-Z	K	200	4,50 gal Zn	5 x 70/60-Z	S	200	16,80 gal Zn
5 x 60/54-Z	S	500	15,30 brün	3,5 x 40/35-Z	S	1000	4,65 gal Zn	5 x 70/60-Z	K	100	18,50 gal Zn
5 x 70/60-Z	S	200	22,30 brün	3,5 x 40/35-Z	K	200	5,20 gal Zn	5 x 80/60-Z	S	200	20,00 gal Zn
5 x 80/60-Z	S	200	25,50 brün	3,5 x 45/40-Z	S	1000	7,00 gal Zn	5 x 80/60-Z	K	100	21,60 gal Zn
5 x 90/60-Z	S	200	33,50 brün	3,5 x 45/40-Z	K	200	8,00 gal Zn	5 x 90/60-Z	S	200	25,50 gal Zn
6 x 50/43-Z	S	200	18,50 brün	3,5 x 50/40-Z	S	500	7,60 gal Zn	5 x 90/60-Z	K	100	29,00 gal Zn
6 x 60/53-Z	S	200	22,30 brün	3,5 x 50/40-Z	K	200	8,60 gal Zn	5 x 100/60-Z	S	200	28,50 gal Zn
6 x 70/60-Z	S	200	26,50 brün	4 x 12/ 9-Z	S	1000	2,95 gal Zn	5 x 100/60-Z	K	100	32,00 gal Zn
6 x 80/60-Z	S	200	29,50 brün	4 x 12/ 9-Z	K	200	3,45 gal Zn	5 x 110/69-Z	S	200	51,00 gal Zn
6 x 90/60-Z	S	200	32,50 brün	4 x 15/10-Z	S	1000	2,95 gal Zn	5 x 120/69-Z	S	200	55,00 gal Zn
6 x 100/60-Z	S	100	40,00 brün	4 x 16/12-Z	S	1000	2,90 gal Zn	6 x 30/23-Z	S	500	12,60 gal Zn
6 x 120/68-Z	S	100	59,00 brün	4 x 16/12-Z	K	200	3,25 gal Zn	6 x 35/28-Z	S	500	12,60 gal Zn
				4 x 17/12-Z	S	1000	2,90 gal Zn	6 x 40/33-Z	S	500	12,60 gal Zn
				4 x 20/15-Z	S	1000	3,15 gal Zn	6 x 40/33-Z	K	200	14,10 gal Zn
				4 x 20/15-Z	K	200	3,45 gal Zn	6 x 45/38-Z	S	500	13,50 gal Zn
				4 x 25/20-Z	S	1000	3,75 gal Zn	6 x 50/43-Z	S	200	14,30 gal Zn
				4 x 25/20-Z	K	200	4,05 gal Zn	6 x 50/43-Z	K	100	15,90 gal Zn
				4 x 30/25-Z	S	1000	3,85 gal Zn	6 x 60/53-Z	S	200	16,80 gal Zn
				4 x 30/25-Z	K	200	4,30 gal Zn	6 x 60/53-Z	K	100	19,10 gal Zn
				4 x 35/30-Z	S	1000	4,45 gal Zn	6 x 70/60-Z	S	200	20,80 gal Zn
				4 x 35/30-Z	K	200	5,10 gal Zn	6 x 70/60-Z	K	100	23,10 gal Zn
				4 x 40/35-Z	S	1000	5,40 gal Zn	6 x 80/60-Z	S	200	23,10 gal Zn
				4 x 40/35-Z	K	200	6,00 gal Zn	6 x 80/60-Z	K	100	25,50 gal Zn
				4 x 45/40-Z	S	500	6,00 gal Zn	6 x 90/60-Z	S	200	26,50 gal Zn
				4 x 45/40-Z	K	200	6,80 gal Zn	6 x 90/60-Z	K	100	30,00 gal Zn
				4 x 50/45-Z	S	500	6,70 gal Zn	6 x 100/60-Z	S	100	30,00 gal Zn
				4 x 50/45-Z	K	200	7,30 gal Zn	6 x 120/68-Z	S	100	46,00 gal Zn
				4 x 55/50-Z	S	500	11,10 gal Zn	6 x 140/68-Z	S	100	59,00 gal Zn
				4 x 60/50-Z	S	500	11,10 gal Zn	6 x 160/68-Z	S	100	80,00 gal Zn
				4 x 60/50-Z	K	100	12,40 gal Zn				
				4 x 70/50-Z	S	500	17,60 gal Zn				
				4 x 70/50-Z	K	100	20,00 gal Zn				
				4 x 80/50-Z	S	200	20,00 gal Zn				
				4,5 x 16/12-Z	S	1000	3,85 gal Zn				
				4,5 x 16/12-Z	K	200	4,50 gal Zn				
				4,5 x 20/14-Z	S	1000	4,20 gal Zn				
				4,5 x 20/14-Z	K	200	5,00 gal Zn				
				4,5 x 25/19-Z	S	1000	4,70 gal Zn				
				4,5 x 25/19-Z	K	200	5,50 gal Zn				
				4,5 x 30/24-Z	S	1000	5,40 gal Zn				
				4,5 x 30/24-Z	K	200	5,90 gal Zn				
				4,5 x 35/29-Z	S	500	5,90 gal Zn				
				4,5 x 35/29-Z	K	200	6,70 gal Zn				
				4,5 x 40/34-Z	S	500	6,40 gal Zn				
				4,5 x 40/34-Z	K	200	7,10 gal Zn				

Artikel 88094.010
88094 Stahl SPAX Seko-Z
 WIROX

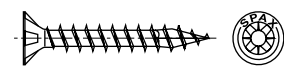

SPAX Universalschrauben, mit SPAX 4CUT-Spitze, Seko = SPAX MULTI-Senkkopf Z = Pozidriv-Kreuzschlitz

gehärtet, gleitbeschichtet,
 Bit-Größen: Ø 2,5 - 3 → Z1, Ø 3,5 - 5,0 → Z2,
 Ø 6 → 3

Zulassungen: Z-9.1-235, ETA-12/0114



Nenn Ø x Nennlänge / Gewindelänge ca.

2,5 x 10/ 8-Z	S	1000	1,90 gal Zn
2,5 x 12/10-Z	S	1000	1,90 gal Zn
2,5 x 16/14-Z	S	1000	1,95 gal Zn
2,5 x 20/17-Z	S	1000	2,25 gal Zn
2,5 x 25/22-Z	S	1000	2,35 gal Zn
3 x 10/ 7-Z	S	1000	1,90 gal Zn
3 x 12/10-Z	S	1000	1,90 gal Zn
3 x 12/10-Z	K	200	2,25 gal Zn

Abmessungen	VE Stück	€/100/Obf.
Artikel	88094.060	
88094	Stahl	SPAX Seko-Z
	YELLOX	



SPAX Universalschrauben mit SPAX 4CUT-Spitze, Seko = SPAX MULTI-Senkopf Z = Pozidriv-Kreuzschlitz

gehärtet, gleitbeschichtet,
Bit-Größen: Ø 2 - 3 → Z1, Ø 3,5 - 5,0 → Z2,
Ø 6 → 3



Nenn Ø x Nennlänge / Gewindelänge ca.

2	x	10/ 8-Z	S	1000	3,95 YELLOX
2	x	12/11-Z	S	1000	4,30 YELLOX
2	x	16/15-Z	S	1000	4,60 YELLOX
2,5	x	10/ 8-Z	S	1000	1,90 YELLOX
2,5	x	12/10-Z	S	1000	1,90 YELLOX
2,5	x	16/14-Z	S	1000	1,95 YELLOX
2,5	x	20/17-Z	S	1000	2,25 YELLOX
2,5	x	25/22-Z	S	1000	2,35 YELLOX
3	x	10/ 7-Z	S	1000	1,90 YELLOX
3	x	12/10-Z	S	1000	1,90 YELLOX
3	x	12/10-Z	K	200	2,25 YELLOX
3	x	16/13-Z	S	1000	2,15 YELLOX
3	x	16/13-Z	K	200	2,35 YELLOX
3	x	20/16-Z	S	1000	2,30 YELLOX
3	x	20/16-Z	K	200	2,50 YELLOX
3	x	25/21-Z	S	1000	2,40 YELLOX
3	x	25/21-Z	K	200	2,70 YELLOX
3	x	30/26-Z	S	1000	3,15 YELLOX
3	x	30/26-Z	K	200	3,65 YELLOX
3	x	35/31-Z	S	1000	3,75 YELLOX
3	x	35/31-Z	K	200	4,05 YELLOX
3	x	40/36-Z	S	1000	5,00 YELLOX
3	x	40/36-Z	K	200	5,60 YELLOX
3	x	45/36-Z	S	1000	6,80 YELLOX
3,5	x	12/ 9-Z	S	1000	2,40 YELLOX
3,5	x	12/ 9-Z	K	200	2,75 YELLOX
3,5	x	15/11-Z	S	1000	2,40 YELLOX
3,5	x	16/12-Z	S	1000	2,40 YELLOX
3,5	x	16/12-Z	K	200	2,70 YELLOX
3,5	x	20/15-Z	S	1000	2,75 YELLOX
3,5	x	20/15-Z	K	200	3,05 YELLOX
3,5	x	25/20-Z	S	1000	3,00 YELLOX
3,5	x	25/20-Z	K	200	3,35 YELLOX
3,5	x	30/25-Z	S	1000	3,25 YELLOX
3,5	x	30/25-Z	K	200	3,75 YELLOX
3,5	x	35/30-Z	S	1000	4,05 YELLOX
3,5	x	35/30-Z	K	200	4,50 YELLOX
3,5	x	40/35-Z	S	1000	4,65 YELLOX
3,5	x	40/35-Z	K	200	5,20 YELLOX
3,5	x	45/40-Z	S	1000	7,00 YELLOX
3,5	x	45/40-Z	K	200	8,00 YELLOX
3,5	x	50/40-Z	S	500	7,60 YELLOX
3,5	x	50/40-Z	K	200	8,60 YELLOX
4	x	12/ 9-Z	S	1000	2,95 YELLOX
4	x	15/11-Z	S	1000	2,95 YELLOX
4	x	16/12-Z	S	1000	2,90 YELLOX
4	x	16/12-Z	K	200	3,25 YELLOX
4	x	20/15-Z	S	1000	3,15 YELLOX
4	x	20/15-Z	K	200	3,45 YELLOX
4	x	25/20-Z	S	1000	3,75 YELLOX
4	x	25/20-Z	K	200	4,05 YELLOX
4	x	30/25-Z	S	1000	3,85 YELLOX

Abmessungen	VE Stück	€/100/Obf.			
4	x	30/25-Z	K	200	4,30 YELLOX
4	x	35/30-Z	S	1000	4,45 YELLOX
4	x	35/30-Z	K	200	5,10 YELLOX
4	x	40/35-Z	S	1000	5,40 YELLOX
4	x	40/35-Z	K	200	6,00 YELLOX
4	x	45/40-Z	S	500	6,00 YELLOX
4	x	45/40-Z	K	200	6,80 YELLOX
4	x	50/45-Z	S	500	6,70 YELLOX
4	x	50/45-Z	K	200	7,30 YELLOX
4	x	55/50-Z	S	500	11,10 YELLOX
4	x	60/50-Z	S	500	11,10 YELLOX
4	x	60/50-Z	K	100	12,40 YELLOX
4	x	70/50-Z	S	500	17,60 YELLOX
4	x	70/50-Z	K	100	20,00 YELLOX
4	x	80/50-Z	S	200	20,00 YELLOX
4,5	x	16/12-Z	S	1000	3,85 YELLOX
4,5	x	16/12-Z	K	200	4,50 YELLOX
4,5	x	20/14-Z	S	1000	4,20 YELLOX
4,5	x	20/14-Z	K	200	5,00 YELLOX
4,5	x	25/19-Z	S	1000	4,70 YELLOX
4,5	x	25/19-Z	K	200	5,50 YELLOX
4,5	x	30/24-Z	S	1000	5,40 YELLOX
4,5	x	30/24-Z	K	200	5,90 YELLOX
4,5	x	35/29-Z	S	500	5,90 YELLOX
4,5	x	35/29-Z	K	200	6,70 YELLOX
4,5	x	40/34-Z	S	500	6,40 YELLOX
4,5	x	40/34-Z	K	200	7,10 YELLOX
4,5	x	45/39-Z	S	500	8,30 YELLOX
4,5	x	45/39-Z	K	200	9,30 YELLOX
4,5	x	50/44-Z	S	500	8,50 YELLOX
4,5	x	50/44-Z	K	200	9,50 YELLOX
4,5	x	60/54-Z	S	500	10,90 YELLOX
4,5	x	60/54-Z	K	100	12,10 YELLOX
4,5	x	70/59-Z	S	500	17,60 YELLOX
4,5	x	70/59-Z	K	100	20,00 YELLOX
4,5	x	80/59-Z	S	200	20,00 YELLOX
4,5	x	80/59-Z	K	100	22,30 YELLOX
5	x	20/14-Z	S	1000	5,70 YELLOX
5	x	20/14-Z	K	200	6,80 YELLOX
5	x	25/19-Z	S	1000	5,70 YELLOX
5	x	25/19-Z	K	200	6,90 YELLOX
5	x	30/24-Z	S	500	6,80 YELLOX
5	x	30/24-Z	K	200	7,40 YELLOX
5	x	35/29-Z	S	500	7,60 YELLOX
5	x	35/29-Z	K	200	8,60 YELLOX
5	x	40/34-Z	S	500	8,30 YELLOX
5	x	40/34-Z	K	200	9,30 YELLOX
5	x	45/39-Z	S	500	9,30 YELLOX
5	x	45/39-Z	K	200	10,40 YELLOX
5	x	50/44-Z	S	500	9,80 YELLOX
5	x	50/44-Z	K	200	11,00 YELLOX
5	x	60/54-Z	S	500	11,80 YELLOX
5	x	60/54-Z	K	100	13,30 YELLOX
5	x	70/60-Z	S	200	16,80 YELLOX
5	x	70/60-Z	K	100	18,50 YELLOX
5	x	80/60-Z	S	200	20,00 YELLOX
5	x	80/60-Z	K	100	21,60 YELLOX
5	x	90/60-Z	S	200	25,50 YELLOX
5	x	100/60-Z	S	200	28,50 YELLOX
5	x	100/60-Z	K	100	31,50 YELLOX
5	x	110/69-Z	S	200	51,00 YELLOX
5	x	120/69-Z	S	200	55,00 YELLOX
6	x	30/23-Z	S	500	12,60 YELLOX
6	x	35/28-Z	S	500	12,60 YELLOX
6	x	40/33-Z	S	500	12,60 YELLOX
6	x	40/33-Z	K	200	14,10 YELLOX
6	x	50/43-Z	S	200	14,30 YELLOX
6	x	50/43-Z	K	100	15,90 YELLOX
6	x	60/53-Z	S	200	16,80 YELLOX
6	x	60/53-Z	K	100	19,10 YELLOX
6	x	70/60-Z	S	200	20,80 YELLOX
6	x	70/60-Z	K	100	23,10 YELLOX
6	x	80/60-Z	S	200	23,10 YELLOX
6	x	80/60-Z	K	100	25,50 YELLOX
6	x	90/60-Z	S	200	26,50 YELLOX

Abmessungen	VE Stück	€/100/Obf.			
6	x	100/60-Z	S	100	30,00 YELLOX
6	x	120/68-Z	S	100	46,00 YELLOX
6	x	140/68-Z	S	100	59,00 YELLOX
6	x	160/68-Z	S	100	80,00 YELLOX

Abmessungen	VE Stück	€/100/Obf.
Artikel	88094.019	
88094	Stahl	SPAX Seko-Z-Tg
	WIROX	



SPAX Universalschrauben mit SPAX 4CUT-Spitze, Seko = SPAX MULTI-Senkopf Z = Pozidriv-Kreuzschlitz Tg = Teilgewinde

gehärtet, gleitbeschichtet,
Bit-Größen: Ø 3,5 - 5,0 → Z2, Ø 6 → 3

Zulassungen: Z-9.1-235, ETA-12/0114



Nenn Ø x Nennlänge / Gewindelänge ca.

3,5	x	30/17-Z	S	1000	3,25 gal Zn
3,5	x	35/22-Z	S	1000	4,05 gal Zn
3,5	x	40/22-Z	S	1000	4,65 gal Zn
3,5	x	45/30-Z	S	1000	7,00 gal Zn
3,5	x	50/32-Z	S	1000	7,60 gal Zn
4	x	30/17-Z	S	1000	3,85 gal Zn
4	x	35/22-Z	S	1000	4,45 gal Zn
4	x	40/22-Z	S	1000	5,40 gal Zn
4	x	45/30-Z	S	500	6,00 gal Zn
4	x	50/35-Z	S	500	6,70 gal Zn
4	x	55/32-Z	S	500	11,10 gal Zn
4	x	60/35-Z	S	500	11,10 gal Zn
4,5	x	35/24-Z	S	500	5,90 gal Zn
4,5	x	40/24-Z	S	500	6,40 gal Zn
4,5	x	45/29-Z	S	500	8,30 gal Zn
4,5	x	50/32-Z	S	500	8,50 gal Zn
4,5	x	55/37-Z	S	500	10,30 gal Zn
4,5	x	60/37-Z	S	500	10,90 gal Zn
4,5	x	70/42-Z	S	500	17,60 gal Zn
5	x	40/27-Z	S	500	8,30 gal Zn
5	x	45/29-Z	S	500	9,30 gal Zn
5	x	50/32-Z	S	500	9,80 gal Zn
5	x	55/36-Z	S	500	11,10 gal Zn
5	x	60/37-Z	S	500	11,80 gal Zn
5	x	65/41-Z	S	200	16,80 gal Zn
5	x	70/41-Z	S	200	16,80 gal Zn
5	x	80/46-Z	S	200	20,00 gal Zn
6	x	60/36-Z	S	200	16,80 gal Zn
6	x	70/41-Z	S	200	20,80 gal Zn
6	x	80/46-Z	S	200	23,10 gal Zn

Abmessungen VE Stück €/100/Obf.

Artikel	88094.069	
88094	Stahl	SPAX Seko-Z-Tg
	YELLOX	



SPAX Universalschrauben mit SPAX 4CUT-Spitze, Seko = SPAX MULTI-Senkopf Z = Pozidriv-Kreuzschlitz Tg = Teilgewinde

gehärtet, gleitbeschichtet, Bit-Größen: Ø 3,5 - 5,0 → Z2, Ø 6 → 3

Zulassungen: Z-9.1-235, ETA-12/0114



Nenn Ø x Nennlänge / Gewindelänge ca.

3,5	x 35/22-Z	S 1000	4,05 YELLOX
3,5	x 40/22-Z	S 1000	4,65 YELLOX
3,5	x 45/30-Z	S 1000	7,00 YELLOX
3,5	x 50/32-Z	S 500	7,60 YELLOX
4	x 35/22-Z	S 1000	4,45 YELLOX
4	x 40/22-Z	S 1000	5,40 YELLOX
4	x 45/30-Z	S 500	6,00 YELLOX
4	x 50/32-Z	S 500	6,70 YELLOX
4	x 55/35-Z	S 500	11,10 YELLOX
4	x 60/35-Z	S 500	11,10 YELLOX
4,5	x 40/24-Z	S 500	6,40 YELLOX
4,5	x 45/29-Z	S 500	8,30 YELLOX
4,5	x 50/32-Z	S 500	8,50 YELLOX
4,5	x 60/37-Z	S 500	10,90 YELLOX
4,5	x 70/42-Z	S 500	17,60 YELLOX
5	x 45/29-Z	S 500	9,40 YELLOX
5	x 50/32-Z	S 500	9,80 YELLOX
5	x 60/36-Z	S 500	11,80 YELLOX
5	x 70/41-Z	S 200	16,80 YELLOX
5	x 80/46-Z	S 200	20,00 YELLOX
5	x 80/46-Z	K 100	21,60 YELLOX
6	x 60/36-Z	S 200	16,80 YELLOX
6	x 70/41-Z	S 200	20,80 YELLOX
6	x 80/46-Z	S 200	23,10 YELLOX
6	x 90/61-Z	K 100	29,50 YELLOX

Artikel	88094.014	
88094	Stahl	SPAX kl. Seko-Z
	WIROX	



SPAX Universalschrauben, kl. Seko = kleiner Senkkopf Z = Pozidriv-Kreuzschlitz

gehärtet, gleitbeschichtet, Senkkopf Ø = 5mm, Bit-Größe: Ø 3 → 1



3	x 10/ 7-Z	S 1000	2,25 gal Zn
3	x 12/10-Z	S 1000	2,25 gal Zn
3	x 15/12-Z	S 1000	2,25 gal Zn

Abmessungen VE Stück €/100/Obf.

Artikel	88094.064	
88094	Stahl	SPAX kl. Seko-Z
	YELLOX	

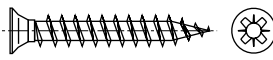

SPAX Universalschrauben, kl. Seko = kleiner Senkkopf Z = Pozidriv-Kreuzschlitz

gehärtet, gleitbeschichtet, Senkkopf Ø = 5mm, Bit-Größe: Ø 3 → 1



Nenn Ø x Nennlänge / Gewindelänge ca.

3	x 10/ 7-Z	S 1000	2,25 YELLOX
3	x 12/10-Z	S 1000	2,25 YELLOX
3	x 15/12-Z	S 1000	2,25 YELLOX

Artikel	88099.014	
88099	Stahl	SPAX Seko-Z-Kb
	WIROX	



SPAX-Universalschrauben, Seko = Senkkopf Z = Pozidriv-Kreuzschlitz Kb = mit Kopfbohrung für Zierkappen

gehärtet, gleitbeschichtet, Kopfbohrung Ø = 2,5mm, Bit-Größen: Ø 4,5 - 5 → 2, Ø 6 → 3

Zierkappen → Artikel 88001, 89013

Korrosionsschutz → TI-228

Zulassungen: Z-9.1-235, ETA-12/0114



Nenn Ø x Nennlänge / Gewindelänge ca.

4,5	x 20/10-Z	S 1000	12,90 gal Zn
4,5	x 25/14-Z	S 1000	13,40 gal Zn
4,5	x 30/19-Z	S 1000	14,10 gal Zn
4,5	x 35/24-Z	S 500	14,90 gal Zn
4,5	x 40/29-Z	S 500	15,90 gal Zn
4,5	x 45/34-Z	S 500	17,40 gal Zn
4,5	x 50/39-Z	S 500	17,80 gal Zn
4,5	x 55/44-Z	S 500	19,00 gal Zn
4,5	x 60/49-Z	S 500	20,80 gal Zn
4,5	x 70/59-Z	S 500	33,50 gal Zn
4,5	x 80/59-Z	S 200	36,00 gal Zn
5	x 60/49-Z	S 500	31,50 gal Zn
5	x 70/60-Z	S 200	39,00 gal Zn
5	x 80/60-Z	S 200	43,00 gal Zn

Abmessungen VE Stück €/100/Obf.

Artikel	88001(*)	
88001	Kunststoff	IL

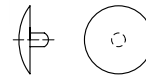

Zierkappen mit Stift

für Spanplatten-Schrauben mit Innenloch, weiß RAL 9010 (*630), hellbraun RAL 8001 (*640), dunkelbraun RAL 8014 (*650)

REACH → TI-262

Stift Ø x Kappen Ø

2,5	x 12	S 1000	2,40 Kunstst
2,5	x 15	S 1000	2,40 Kunstst

Artikel	89013.(*)	
---------	-----------	--

89013 Kunststoff

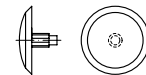

SPAX-Zierkappen mit Stift

für alle SPAX Schrauben mit Kopfbohrung, weiß (*630), schwarz (*631), grau (*632), beige (*633), ocker (*634), rehbraun (*635), mahagoni (*636)

REACH → TI-262

Weiss	S 500	4,85 Kunstst
-------	-------	--------------

Artikel	88193.034	
---------	-----------	--

88193 Stahl SPAX-T-T WIROX



SPAX Schrauben mit SPAX 4CUT-Spitze/Fräser*, T = Tellerkopf T = T-STAR plus

gehärtet, gleitbeschichtet, *ab Länge 160mm mit 4CUT-Fräser

Bits → Artikel 88663, 88654

Zulassungen: Z-9.1-235, Z-9.1-511, ETA-12/0114



Nenn Ø x Nennlänge / Gewindelänge ca. - Bit-Größe

6	x 60/56 -T30	S 200	18,70 gal Zn
6	x 80/61 -T30	S 100	25,50 gal Zn
6	x 100/61 -T30	S 100	33,50 gal Zn
6	x 120/68 -T30	S 100	50,00 gal Zn
6	x 140/68 -T30	S 100	64,00 gal Zn
6	x 160/65 -T30	S 100	88,00 gal Zn
6	x 180/65 -T30	S 100	120,00 gal Zn

Abmessungen	VE	Stück	€/100/Obf.
8 x 80/70 -T40	S	50	52,00 gal Zn
8 x 100/80 -T40	S	50	63,00 gal Zn
8 x 120/80 -T40	S	50	80,00 gal Zn
8 x 140/80 -T40	S	50	93,00 gal Zn
8 x 160/80 -T40	S	50	123,00 gal Zn
8 x 180/80 -T40	S	50	141,00 gal Zn
8 x 200/80 -T40	S	50	169,00 gal Zn
8 x 220/80 -T40	S	50	219,00 gal Zn
8 x 240/80 -T40	S	50	230,00 gal Zn
8 x 260/80 -T40	S	50	246,00 gal Zn
8 x 280/80 -T40	S	50	261,00 gal Zn
8 x 300/80 -T40	S	50	295,00 gal Zn
8 x 320/80 -T40	S	50	314,00 gal Zn
8 x 340/80 -T40	S	50	341,00 gal Zn
8 x 360/80 -T40	S	50	369,00 gal Zn
8 x 380/80 -T40	S	50	385,00 gal Zn
8 x 400/80 -T40	S	50	407,00 gal Zn
8 x 450/80 -T40	S	25	629,00 gal Zn
10 x 80/70 -T50	S	50	80,00 gal Zn
10 x 100/80 -T50	S	50	89,00 gal Zn
10 x 120/80 -T50	S	50	101,00 gal Zn
10 x 140/80 -T50	S	50	111,00 gal Zn
10 x 160/80 -T50	S	25	129,00 gal Zn
10 x 180/80 -T50	S	25	147,00 gal Zn
10 x 200/80 -T50	S	25	189,00 gal Zn
10 x 220/80 -T50	S	25	236,00 gal Zn
10 x 240/80 -T50	S	25	265,00 gal Zn
10 x 260/80 -T50	S	25	315,00 gal Zn
10 x 280/80 -T50	S	25	355,00 gal Zn
10 x 300/80 -T50	S	25	376,00 gal Zn
10 x 320/80 -T50	S	25	393,00 gal Zn
10 x 360/80 -T50	S	25	462,00 gal Zn
10 x 380/80 -T50	S	25	512,00 gal Zn
10 x 400/80 -T50	S	25	532,00 gal Zn
10 x 450/80 -T50	S	25	693,00 gal Zn

Artikel 88195.030
88195 Stahl SPAX-MF-T
 WIROX

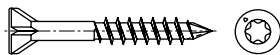

SPAX Schrauben mit SPAX CUT-Spitze, mit kleinem 60° Fräskopf, MF = für Massivholzfußböden T = T-STAR plus
 gehärtet, gleitbeschichtet

Bits → Artikel 88663, 88654

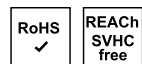

Nenn Ø x Nennlänge / Gewindelänge ca. - Bit-Größe

3,5 x 45/25-T10	S	500	12,80 gal Zn
3,5 x 55/36-T10	S	500	18,40 gal Zn

Abmessungen VE Stück €/100/Obf.
 Artikel 88197.014
88197 Stahl SPAX R-Z
 WIROX



SPAX Rückwandschrauben mit SPAX 4CUT-Spitze, R = Rückwandkopf Z = Pozidriv Kreuzschlitz
 gehärtet, gleitbeschichtet,
 Bit-Größen: Ø 3,5 - 5,0 → Z2

Zulassungen: Z-9.1-235, ETA-12/0114



Nenn Ø x Nennlänge / Gewindelänge ca.

3,5 x 17/14-Z	S	3000	4,85 gal Zn
3,5 x 20/17-Z	S	3000	4,95 gal Zn
3,5 x 25/22-Z	S	2000	5,10 gal Zn
3,5 x 30/27-Z	S	3000	5,60 gal Zn
3,5 x 35/32-Z	S	2000	6,80 gal Zn
4 x 13/10-Z	S	3000	4,95 gal Zn
4 x 17/14-Z	S	2000	5,00 gal Zn
4 x 20/17-Z	S	2000	5,20 gal Zn
4 x 25/22-Z	S	3000	5,70 gal Zn
4 x 30/27-Z	S	2000	6,60 gal Zn
4 x 35/32-Z	S	2000	7,40 gal Zn
4 x 40/37-Z	S	1500	8,00 gal Zn
4 x 45/42-Z	S	1000	8,80 gal Zn
4,5 x 20/17-Z	S	3000	6,80 gal Zn
4,5 x 25/22-Z	S	2000	7,30 gal Zn
4,5 x 30/27-Z	S	2000	8,10 gal Zn
4,5 x 35/32-Z	S	1500	9,50 gal Zn
4,5 x 40/37-Z	S	1000	9,90 gal Zn
4,5 x 45/42-Z	S	1000	11,20 gal Zn
4,5 x 50/47-Z	S	1000	13,30 gal Zn
5 x 20/17-Z	S	2000	7,10 gal Zn
5 x 25/21-Z	S	1000	8,60 gal Zn
5 x 30/26-Z	S	1000	9,40 gal Zn
5 x 35/31-Z	S	1000	11,60 gal Zn
5 x 40/36-Z	S	1000	12,60 gal Zn
5 x 45/41-Z	S	1000	14,40 gal Zn
5 x 50/46-Z	S	1000	15,20 gal Zn
5 x 60/56-Z	S	500	17,60 gal Zn

Abmessungen VE Stück €/100/Obf.
 Artikel 88198.010
88198 Stahl SPAX M-T
 WIROX



SPAX Schrauben M für MDF-Materialien, mit SPAX CUT-Spitze, mit kleinem 75° Fräskopf, T = T-STAR plus
 gehärtet, gleitbeschichtet

Bits → Artikel 88663, 88654

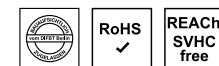

Nenn Ø x Nennlänge / Gewindelänge ca. - Bit-Größe

3,5 x 40/28-T15	K	200	10,60 gal Zn
3,5 x 45/30-T15	K	200	12,30 gal Zn
3,5 x 50/35-T15	K	200	13,40 gal Zn
4 x 40/28-T20	K	200	9,00 gal Zn
4 x 45/30-T20	K	200	9,90 gal Zn
4 x 50/35-T20	K	200	10,90 gal Zn
4 x 60/40-T20	K	100	17,70 gal Zn
4,5 x 45/30-T20	K	200	13,70 gal Zn
4,5 x 50/35-T20	K	200	14,10 gal Zn

Artikel 88190.064
88190 Stahl SPAX Seko-Z
 YELLOX



SPAX Glasleistenschrauben mit SPAX CUT-Spitze und Fräsrippen, Seko = Senkkopf Z = Pozidriv Kreuzschlitz
 gleitbeschichtet

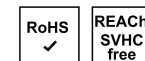

Nenn Ø x Nennlänge / Gewindelänge ca. - Bit-Größe

3,5 x 40/23-Z2	S	200	16,50 YELLOX
----------------	---	-----	--------------



- ✓ Große Artikelvielfalt
- ✓ Verlässliche Qualität
- ✓ Hohe Lieferbereitschaft

Abmessungen VE Stück €/100/Obf.

Artikel	88187.014		
88187	Stahl	SPAX FEX-A	Sonderoberfl. silber



SPAX Fensterbohrschrauben FEX-A, Senkkopf mit Fräsrippen und Bohrspitze, mit Phillips-Kreuzschlitz H2

gehärtet, gleitbeschichtet



Nenn Ø x Nennlänge

3,9	x 13 -H	S 1000	5,50 gal Zn
3,9	x 19 -H	S 1000	6,50 gal Zn
3,9	x 32 -H	S 1000	8,30 gal Zn
3,9	x 38 -H	S 1000	8,60 gal Zn

Artikel	88188.014		
88188	Stahl	SPAX FEX-KS	Sonderoberfl. silber

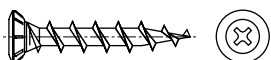

SPAX Beschlagschrauben FEX-KS, Senkkopf mit Bremsrippen, mit Phillips-Kreuzschlitz H2

gehärtet, gleitbeschichtet



Nenn Ø x Nennlänge

4	x 25 -H	S 1000	4,15 gal Zn
4	x 30 -H	S 1000	5,20 gal Zn

Artikel	88189.015		
88189	Stahl	SPAX FEX-H	Sonderoberfl. silber

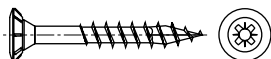

SPAX Holzfensterschrauben FEX-H mit SPAX 4CUT-Spitze, Senkkopf mit Bremsrippen, mit Pozidriv-Kreuzschlitz Z2

gehärtet, gleitbeschichtet



Nenn Ø x Nennlänge

4	x 30 -Z	S 1000	4,50 gal Zn
4	x 35 -Z	S 1000	5,30 gal Zn
4	x 40 -Z	S 1000	6,30 gal Zn

Abmessungen VE Stück €/100/Obf.

Artikel	88189.014		
88189	Stahl	SPAX FEX-H	Sonderoberfl. silber

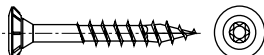

SPAX Holzfensterschrauben FEX-H mit SPAX 4CUT-Spitze, Senkkopf mit Bremsrippen, mit T-STAR plus

gehärtet, gleitbeschichtet

Bits → Artikel 88663, 88654

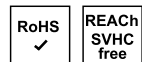

Nenn Ø x Nennlänge - Bit-Größe

4	x 30 -T15	S 1000	4,95 gal Zn
4	x 35 -T15	S 1000	5,60 gal Zn
4	x 40 -T15	S 1000	6,10 gal Zn

Artikel	89010.010		
89010	Stahl	SPAX RA-Fsk-T	WIROX



SPAX Rahmenanker RA, Fsk = Flachsenkopff T = T-STAR plus

gehärtet, gleitbeschichtet

Bits → Artikel 88663, 88654, Zierkappen → Artikel 89012

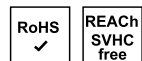

Nenn Ø x Länge x Bit-Größe

7,5	x 40 -T30	S 100	20,30 gal Zn
7,5	x 80 -T30	S 100	30,00 gal Zn
7,5	x 100 -T30	S 100	47,50 gal Zn
7,5	x 120 -T30	S 100	55,00 gal Zn
7,5	x 150 -T30	S 100	72,00 gal Zn

Abmessungen VE Stück €/100/Obf.

Artikel	89011.010		
89011	Stahl	SPAX RA-Zyko-T	WIROX



SPAX Rahmenanker RA, Zyko = Zylinderkopf T = T-STAR plus

gehärtet, gleitbeschichtet

Bits → Artikel 88663, 88654, Zierkappen → Artikel 89012



Nenn Ø x Länge x Bit-Größe

7,5	x 110 -T30	S 100	51,00 gal Zn
7,5	x 210 -T30	S 100	137,00 gal Zn

Artikel	89012.(*)		
---------	-----------	--	--

89012 Kunststoff

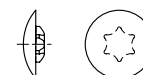

Zierkappen für SPAX Rahmenanker RA, für Zylinder- und Senkköpfe mit Innensechsrund

weiß (*630), schwarz (*631)

REACH → TI-262

weiss	S 500	4,85 Kunstst
-------	-------	--------------

Artikel	89014.034		
89014	Stahl	SPAX Zyko-T	WIROX

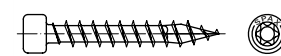

SPAX Schrauben für Holz, Glas und Fassaden, mit SPAX 4CUT-Spitze, Zyko = Zylinderkopf T = T-STAR plus

gehärtet, gleitbeschichtet

Bits → Artikel 88663, 88654

Zulassungen: Z-9.1-519, ETA-12/0114



Nenn Ø x Länge - Bit-Größe

6	x 80 -T30	S 200	33,50 gal Zn
6	x 100 -T30	S 100	44,00 gal Zn
6	x 120 -T30	S 100	64,00 gal Zn
6	x 140 -T30	S 100	84,00 gal Zn

Abmessungen	VE	Stück	€/100/Obf.
6 x 160 -T30	S	100	114,00 gal Zn
6 x 180 -T30	S	100	153,00 gal Zn
6 x 200 -T30	S	100	205,00 gal Zn
8 x 200 -T40	S	50	283,00 gal Zn
8 x 220 -T40	S	50	315,00 gal Zn
8 x 240 -T40	S	50	330,00 gal Zn
8 x 260 -T40	S	50	372,00 gal Zn
8 x 280 -T40	S	50	378,00 gal Zn
8 x 300 -T40	S	50	440,00 gal Zn
8 x 350 -T40	S	50	505,00 gal Zn
8 x 400 -T40	S	50	536,00 gal Zn
8 x 450 -T40	S	50	895,00 gal Zn

Abmessungen	VE	Stück	€/100/Obf.
Artikel 88002.*			
88002	Kunststoff	Z	



Zierkappen für Senkschrauben mit Pozidriv-Kreuzschlitz Z

weiß RAL 9010 (*630),
hellbraun RAL 8001 (*640),
dunkelbraun RAL 8014 (*650)

REACH → TI-262

Z-Kreuzschlitz-Nummer x Kappen Ø/für Schrauben Ø

1	x	8 /	3	S	1000	2,10 Kunstst
2	x	12 / 3,5-5		S	1000	2,10 Kunstst
3	x	13 / 5,5-6		S	1000	2,25 Kunstst

Artikel	88100.000
---------	-----------

88100 **Stahl**

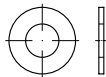

Scheiben "Artikel 1" (~ DIN 134), Produktklasse C (g)

Maße → TI-84



Innen Ø x Außen Ø x Dicke (grobe Zirka-Maße)

3,2	x	8	x	0,5	S	200	3,20
4,3	x	10	x	0,8	S	200	3,20
5,3	x	12	x	1	S	200	3,20
6,5	x	13	x	1,25	S	200	2,80
8	x	16	x	1,25	S	200	3,70
10	x	20	x	1,5	S	200	15,00
11,5	x	23	x	1,5	S	200	5,80
14,5	x	29	x	1,75	S	200	9,70
16	x	32	x	2	S	200	15,80
17,5	x	35	x	2	S	200	16,40
19,5	x	39	x	2,5	S	100	26,50
21	x	42	x	2,5	S	100	26,00
23	x	46	x	3	S	100	135,00
24,5	x	49	x	3	S	100	39,50
27,5	x	55	x	3,5	S	100	54,00
29	x	58	x	3,5	S	100	77,00
31	x	62	x	3,5	S	100	88,00
34	x	68	x	4	S	100	250,00
36	x	72	x	5	S	50	170,00
40	x	80	x	5	S	50	216,00
43	x	85	x	5	S	50	234,00
46	x	90	x	6	S	50	320,00
50	x	97	x	6	S	50	365,00
54	x	105	x	7	S	25	510,00

Abmessungen	VE	Stück	€/100/Obf.
Artikel 88100.010			
88100	Stahl		galvanisch verzinkt

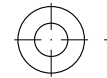

Scheiben "Artikel 1" (~ DIN 134), Produktklasse C (g)

Maße → TI-84

Korrosionsschutz → TI-228

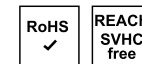

Innen Ø x Außen Ø x Dicke (grobe Zirka-Maße)

3,2	x	8	x	0,5	S	200	3,40 gal Zn
4,3	x	10	x	0,8	S	200	3,40 gal Zn
5,3	x	12	x	1	S	200	3,50 gal Zn
6,5	x	13	x	1,25	S	200	3,40 gal Zn
8	x	16	x	1,25	S	200	4,60 gal Zn
10	x	20	x	1,5	S	200	6,80 gal Zn
10	x	20	x	1	S	200	5,70 gal Zn
11,5	x	23	x	1,5	S	200	7,90 gal Zn
13	x	26	x	1,75	S	200	10,80 gal Zn
14,5	x	29	x	1,75	S	200	13,60 gal Zn
16	x	32	x	2	S	200	21,20 gal Zn
17,5	x	35	x	2	S	200	23,00 gal Zn
19,5	x	39	x	2,5	S	100	37,00 gal Zn
21	x	42	x	2,5	S	100	37,50 gal Zn
23	x	46	x	3	S	100	53,00 gal Zn
24,5	x	49	x	3	S	100	60,00 gal Zn
27,5	x	55	x	3,5	S	100	84,00 gal Zn
29	x	58	x	3,5	S	100	108,00 gal Zn
31	x	62	x	3,5	S	100	126,00 gal Zn
34	x	68	x	4	S	100	168,00 gal Zn
36	x	72	x	5	S	50	240,00 gal Zn
40	x	80	x	5	S	50	310,00 gal Zn
43	x	85	x	5	S	50	330,00 gal Zn
46	x	90	x	6	S	50	455,00 gal Zn
50	x	97	x	6	S	50	520,00 gal Zn
54	x	105	x	7	S	25	730,00 gal Zn

Artikel	88102.010
---------	-----------

88102 **Stahl**

galvanisch verzinkt

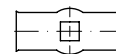

Fugenscheiben

zur Verwendung mit Flachrundschraben nach DIN 603

Maße → TI-113

Korrosionsschutz → TI-228

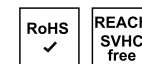

Vierkantlochmaß

9	S	100	126,00 gal Zn
11	S	100	85,00 gal Zn

Spanlattenschrauben

Weitere Spanlattenschrauben mit CE nach EN 14592

- Artikel 89096
- Artikel 89097
- Artikel 89098



Artikel	89015.034
---------	-----------

89015 **Stahl** **SPAX Seko-T**
WIROX

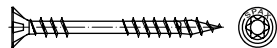

SPAX Verlegeschrauben mit Fixiergewinde und SPAX 4CUT-Spitze, Seko = SPAX MULTI-Senkkopf T = T-STAR plus

gehärtet, gleitbeschichtet

Bits → Artikel 88663, 88654

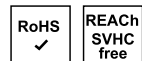

Nenn Ø x Länge - Bit-Größe

4,5	x	50 -T20	S	500	11,00 gal Zn
4,5	x	60 -T20	S	500	14,20 gal Zn
4,5	x	70 -T20	S	500	18,80 gal Zn
4,5	x	80 -T20	S	200	21,30 gal Zn

Abmessungen VE Stück €/100/Obf.
 Artikel 88104.000

88104 Stahl



Kotflügelscheiben, Produktklasse C (g)

Maße → TI-85

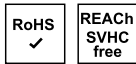

Innen Ø x Außen Ø x Dicke (grobe Zirka-Maße)

5,3	x	20	x	1,5	S	200	3,25
5,3	x	25	x	1,5	S	200	4,60
5,3	x	30	x	1,5	S	200	6,90
6,4	x	20	x	1,5	S	200	3,40
6,4	x	25	x	1,5	S	200	4,60
6,4	x	30	x	1,5	S	200	6,90
6,4	x	35	x	1,5	S	200	8,80
8,4	x	20	x	1,5	S	200	3,40
8,4	x	25	x	1,5	S	200	4,60
8,4	x	30	x	1,5	S	200	6,90
8,4	x	35	x	1,5	S	200	8,80
10,5	x	30	x	1,5	S	200	6,90
10,5	x	35	x	1,5	S	200	8,80
12,5	x	30	x	1,5	S	200	6,90
12,5	x	35	x	1,5	S	200	8,80

Artikel 88104.010
88104 Stahl galvanisch verzinkt



Kotflügelscheiben, Produktklasse C (g)

Maße → TI-85

Korrosionsschutz → TI-228



Innen Ø x Außen Ø x Dicke (grobe Zirka-Maße)

3,2	x	20	x	1,25	S	200	4,30 gal Zn
4,3	x	15	x	1,25	S	200	3,45 gal Zn
4,3	x	20	x	1,25	S	200	4,30 gal Zn
4,3	x	25	x	1,25	S	200	6,20 gal Zn
5,3	x	20	x	1,5	S	200	4,20 gal Zn
5,3	x	25	x	1,5	S	200	6,10 gal Zn
5,3	x	30	x	1,5	S	200	9,10 gal Zn
6,4	x	20	x	1,5	S	200	4,45 gal Zn
6,4	x	25	x	1,5	S	200	6,10 gal Zn
6,4	x	30	x	1,5	S	200	9,10 gal Zn
6,4	x	35	x	1,5	S	200	11,40 gal Zn
8,4	x	20	x	1,5	S	200	4,15 gal Zn
8,4	x	25	x	1,5	S	200	6,00 gal Zn
8,4	x	30	x	1,5	S	200	9,10 gal Zn
8,4	x	35	x	1,5	S	200	11,50 gal Zn
8,4	x	40	x	1,5	S	200	25,50 gal Zn
10,5	x	25	x	1,5	S	200	6,30 gal Zn
10,5	x	30	x	1,5	S	200	8,90 gal Zn
10,5	x	35	x	1,5	S	200	11,50 gal Zn
10,5	x	40	x	1,5	S	200	25,50 gal Zn
12,5	x	30	x	1,5	S	200	8,80 gal Zn

Abmessungen VE Stück €/100/Obf.
 12,5 x 35 x 1,5 S 200 11,40 gal Zn
 12,5 x 40 x 1,5 S 200 25,50 gal Zn

Artikel 88106.010
88106 Stahl gehärtet galvanisch verzinkt

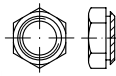

Setzmuttern

Maße → TI-78

Korrosionsschutz → TI-228

andere Kragenhöhe auf Anfrage

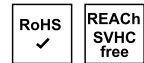

Gewinde M / Kragenhöhe

M 3 / 0,9	S	1000	21,20 gal Zn
M 3 / 0,9	K	100	24,60 gal Zn
M 4 / 0,9	S	1000	24,20 gal Zn
M 4 / 0,9	K	100	28,00 gal Zn
M 5 / 0,9	S	1000	33,00 gal Zn
M 5 / 0,9	K	100	37,00 gal Zn
M 6 / 0,9	S	1000	39,50 gal Zn
M 6 / 0,9	K	100	44,50 gal Zn
M 8 / 1,9	S	500	49,50 gal Zn
M 8 / 1,9	K	100	54,00 gal Zn
M 10 / 1,9	S	100	123,00 gal Zn
M 12 / 2,9	S	100	166,00 gal Zn
M 16 / 2,4	S	100	325,00 gal Zn

Artikel 88107.410
88107 Stahl galvanisch verzinkt



Flachrundschaublen mit Schlitz "Bordwandschaublen", mit Gewinde bis Kopf

Muttern → DIN 934/ISO 4032

Maße → TI-41

REACH → TI-262

Korrosionsschutz → TI-228



M 6	x	10	S	500	12,90 gal Zn
M 6	x	16	S	500	13,40 gal Zn
M 6	x	20	S	500	14,10 gal Zn
M 6	x	25	S	500	14,80 gal Zn
M 6	x	30	S	500	17,10 gal Zn
M 6	x	35	S	200	19,00 gal Zn
M 6	x	40	S	200	20,50 gal Zn
M 6	x	45	S	200	22,60 gal Zn
M 6	x	50	S	200	25,50 gal Zn
M 8	x	16	S	200	27,50 gal Zn
M 8	x	20	S	200	29,00 gal Zn
M 8	x	25	S	200	30,00 gal Zn
M 8	x	30	S	200	31,50 gal Zn
M 8	x	35	S	200	33,50 gal Zn
M 8	x	40	S	200	37,00 gal Zn
M 8	x	45	S	200	41,00 gal Zn
M 8	x	50	S	200	42,50 gal Zn

Abmessungen VE Stück €/100/Obf.
 M 8 x 55 S 200 47,00 gal Zn
 M 8 x 60 S 200 40,00 gal Zn

Artikel 88108.010
88108 Stahl galvanisch verzinkt

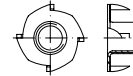

Einschlagmuttern

Maße → TI-78

Korrosionsschutz → TI-228



Innengewinde x Gesamthöhe x Hals (~ Bohr) Ø

M 4	x	6	x	5	S	200	33,00 gal Zn
M 5	x	8	x	6,3	S	200	41,00 gal Zn
M 6	x	9	x	7,3	S	200	51,00 gal Zn
M 6	x	12	x	7,5	S	200	57,00 gal Zn
M 8	x	11	x	9,7	S	100	73,00 gal Zn
M 8	x	15	x	9,9	S	100	83,00 gal Zn
M 10	x	13	x	11,9	S	100	91,00 gal Zn

Artikel 88109.010
88109 Stahl galvanisch verzinkt

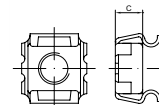

Käfigmuttern

Maße → TI-78

Korrosionsschutz → TI-228

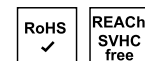

Innengewinde-Indexnummer (~Käfighöhe c) / Vierkantloch Ø

M 4 - 8 / 9,5	S	1000	57,00 gal Zn
M 5 - 8 / 9,5	S	1000	56,00 gal Zn
M 6 - 6 / 9,5	S	1000	57,00 gal Zn
M 6 - 8 / 9,5	S	1000	57,00 gal Zn
M 8 - 8 / 12,5	S	1000	69,00 gal Zn
M 10 - 8 / 12,5	S	1000	68,00 gal Zn

Abmessungen	VE Stück	€/100/Obf.
Artikel 88110.010		
88110	Stahl	
	galvanisch verzinkt	

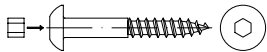

Diebstahlhemmende Schrauben, Halbrund-Holzschrauben mit Innensechskant und Vernietungsstift (nicht lösbar)

Korrosionsschutz → **TI-228**



8	x	50	S	50	630,00 gal Zn
8	x	70	S	50	660,00 gal Zn
8	x	80	S	50	670,00 gal Zn
8	x	90	S	50	670,00 gal Zn
10	x	80	S	50	690,00 gal Zn
10	x	100	S	50	740,00 gal Zn
10	x	130	S	50	850,00 gal Zn

Abmessungen	VE Stück	€/100/Obf.
Artikel 88120.004		
88120	Federstahl	
	Form S	

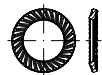

SCHNORR-Sperrzahnscheiben, beidseitig gezahnt, für Schrauben mit Fkl. ≤ 5.8, S = Standard

Maße → **TI-104** Schraubensicherung → **TI-256**
Anziehmomente → **TI-247**



Für Schrauben M x Außen Ø x Dicke

S 2	x	4	x	0,35	S	2000	0,95
S 2	x	4	x	0,35	K	500	1,45
S 2,5	x	4,8	x	0,45	S	2000	0,80
S 2,5	x	4,8	x	0,45	K	500	1,45
S 3	x	5,5	x	0,45	S	2000	0,80
S 3	x	5,5	x	0,45	K	500	1,45
S 3,5	x	6	x	0,45	K	500	1,45
S 4	x	7	x	0,5	S	1000	0,85
S 4	x	7	x	0,5	K	250	2,10
S 5	x	9	x	0,6	S	1000	1,20
S 5	x	9	x	0,6	K	250	2,45
S 6	x	10	x	0,7	S	1000	1,35
S 6	x	10	x	0,7	K	250	2,55
S 7	x	12	x	0,7	K	250	2,80
S 8	x	13	x	0,8	S	1000	1,85
S 8	x	13	x	0,8	K	250	3,00
S 10	x	16	x	1	S	1000	2,70
S 10	x	16	x	1	K	250	3,95
S 12	x	18	x	1,1	S	500	3,65
S 12	x	18	x	1,1	K	100	6,20
S 14	x	22	x	1,2	S	500	4,95
S 14	x	22	x	1,2	K	100	7,50
S 16	x	24	x	1,3	S	500	6,40
S 16	x	24	x	1,3	K	100	8,80

Abmessungen	VE Stück	€/100/Obf.					
S18	x	27	x	1,5	S	250	12,40
S18	x	27	x	1,5	K	100	14,80
S20	x	30	x	1,5	S	250	14,00
S20	x	30	x	1,5	K	100	16,60
S22	x	33	x	1,5	S	100	16,60
S24	x	36	x	1,8	S	100	22,70
S27	x	39	x	2	S	100	26,50
S30	x	45	x	2	S	100	37,00
S36	x	54	x	2,5	S	50	71,00

Abmessungen	VE Stück	€/100/Obf.
Artikel 88120.014		
88120	Federstahl	
	Form S	
	mechanisch verz.*	



SCHNORR-Sperrzahnscheiben, beidseitig gezahnt, für Schrauben mit Fkl. ≤ 5.8, S = Standard

*bis Nennmaß 3,5 → galvanisch verzinkt

Maße → **TI-104** Anziehmomente → **TI-247**
Korrosionsschutz → **TI-228** Schraubensicherung → **TI-256**



Für Schrauben M x Außen Ø x Dicke

S 2,5	x	4,8	x	0,45	S	2000	0,85 mech Zn
S 2,5	x	4,8	x	0,45	K	500	1,50 mech Zn
S 3	x	5,5	x	0,45	S	2000	0,85 mech Zn
S 3	x	5,5	x	0,45	K	500	1,50 mech Zn
S 4	x	7	x	0,5	S	1000	1,00 mech Zn
S 4	x	7	x	0,5	K	250	2,20 mech Zn
S 5	x	9	x	0,6	S	1000	1,35 mech Zn
S 5	x	9	x	0,6	K	250	2,55 mech Zn
S 6	x	10	x	0,7	S	1000	1,55 mech Zn
S 6	x	10	x	0,7	K	250	2,80 mech Zn
S 8	x	13	x	0,8	S	1000	2,15 mech Zn
S 8	x	13	x	0,8	K	250	3,35 mech Zn
S 10	x	16	x	1	S	1000	3,25 mech Zn
S 10	x	16	x	1	K	250	4,45 mech Zn
S 12	x	18	x	1,1	S	500	4,30 mech Zn
S 12	x	18	x	1,1	K	100	6,80 mech Zn
S 14	x	22	x	1,2	S	500	6,20 mech Zn
S 14	x	22	x	1,2	K	100	8,60 mech Zn
S 16	x	24	x	1,3	S	500	7,60 mech Zn
S 16	x	24	x	1,3	K	100	10,10 mech Zn
S 18	x	27	x	1,5	S	250	14,10 mech Zn
S 18	x	27	x	1,5	K	100	16,70 mech Zn
S 20	x	30	x	1,5	S	250	16,70 mech Zn
S 20	x	30	x	1,5	K	100	19,20 mech Zn
S 22	x	33	x	1,5	S	100	19,50 mech Zn
S 24	x	36	x	1,8	S	100	27,00 mech Zn
S 27	x	39	x	2	S	100	31,50 mech Zn
S 30	x	45	x	2	S	100	44,00 mech Zn

Abmessungen	VE Stück	€/100/Obf.
Artikel 88121.004		
88121	Federstahl	
	Form VS	



SCHNORR-Sperrzahnscheiben, beidseitig gezahnt, für Schrauben mit Fkl. 8.8/10.9, VS = verstärkt

Maße → **TI-105** Schraubensicherung → **TI-256**
Anziehmomente → **TI-247**

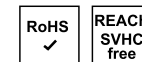

Für Schrauben M x Außen Ø x Dicke

VS 5	x	9	x	1	S	1000	1,65
VS 5	x	9	x	1	K	250	2,85
VS 6	x	10	x	1	S	1000	1,95
VS 6	x	10	x	1	K	250	3,20
VS 8	x	13	x	1,2	S	1000	2,70
VS 8	x	13	x	1,2	K	250	3,85
VS 10	x	16	x	1,5	S	1000	4,15
VS 10	x	16	x	1,5	K	250	5,40
VS 12	x	18	x	1,5	S	500	5,40
VS 12	x	18	x	1,5	K	100	7,80
VS 14	x	22	x	1,5	S	500	7,10
VS 14	x	22	x	1,5	K	100	9,50
VS 16	x	24	x	2	S	250	10,80
VS 16	x	24	x	2	K	100	13,30
VS 18	x	27	x	2	S	250	18,10
VS 18	x	27	x	2	K	100	20,60
VS 20	x	30	x	2	S	250	21,30
VS 20	x	30	x	2	K	100	23,70
VS 22	x	33	x	2	S	100	25,50
VS 24	x	36	x	2,5	S	100	36,00
VS 27	x	39	x	2,5	S	100	42,50
VS 30	x	45	x	2,5	S	100	52,00

Abmessungen	VE Stück	€/100/Obf.
Artikel 88121.014		
88121	Federstahl	
	Form VS	
	mechanisch verz.*	



SCHNORR-Sperrzahnscheiben, beidseitig gezahnt, für Schrauben mit Fkl. 8.8/10.9, VS = verstärkt

*bis Nennmaß 4 → galvanisch verzinkt

Maße → **TI-105** Anziehmomente → **TI-247**
Korrosionsschutz → **TI-228** Schraubensicherung → **TI-256**

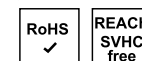

Für Schrauben M x Außen Ø x Dicke

VS 5	x	9	x	1	S	1000	1,90 mech Zn
VS 5	x	9	x	1	K	250	3,10 mech Zn
VS 6	x	10	x	1	S	1000	2,20 mech Zn
VS 6	x	10	x	1	K	250	3,45 mech Zn
VS 8	x	13	x	1,2	S	1000	3,00 mech Zn
VS 8	x	13	x	1,2	K	250	4,30 mech Zn
VS 10	x	16	x	1,5	S	1000	4,90 mech Zn

Abmessungen	VE	Stück	€/100/Obf.
VS 10 x 16 x 1,5 K 250	6,20	mech Zn	
VS 12 x 18 x 1,5 S 500	6,20	mech Zn	
VS 12 x 18 x 1,5 K 100	8,60	mech Zn	
VS 14 x 22 x 1,5 S 500	8,40	mech Zn	
VS 14 x 22 x 1,5 K 100	10,80	mech Zn	
VS 16 x 24 x 2 S 250	12,50	mech Zn	
VS 16 x 24 x 2 K 100	15,00	mech Zn	
VS 18 x 27 x 2 S 250	20,60	mech Zn	
VS 18 x 27 x 2 K 100	23,00	mech Zn	
VS 20 x 30 x 2 S 250	24,20	mech Zn	
VS 20 x 30 x 2 K 100	27,00	mech Zn	
VS 22 x 33 x 2 S 100	29,00	mech Zn	
VS 24 x 36 x 2,5 S 100	41,50	mech Zn	
VS 27 x 39 x 2,5 S 100	47,50	mech Zn	
VS 30 x 45 x 2,5 S 100	64,00	mech Zn	

Artikel 88122.030

88122 Federstahl brüniert

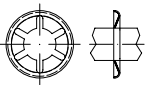

Achsen-Klemmringe (Schnellbefestigungs-Elemente)

Maße → TI-114 Schraubensicherung → TI-256

Andere Maße/Ausführungen auf Anfrage

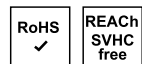

Für Wellen Ø d x Außen Ø D x Höhe H

FF 3 x 11,2 x 1,5 S 1000	8,60
FF 4 x 11,2 x 1,5 S 1000	9,00
FF 5 x 11,2 x 1,5 S 1000	9,60
FC 6 x 15,0 x 1,4 S 1000	10,10
FC 8 x 15,0 x 1,4 S 500	10,70
FD 10 x 18,0 x 1,8 S 500	12,90
FE 12 x 21,0 x 1,8 S 250	20,90

Artikel 88123.030

88123 Federstahl SK-S zinklamellenbesch.



TECKENTRUP-Sperrkantscheiben, für Schrauben mit Fkl. ≤ 5,8, S (schmal) = für normale und kleine Kopfauflagen

Maße → TI-105 Anziehmomente → TI-247
Korrosionsschutz → TI-230 Schraubensicherung → TI-256

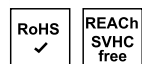

Für Schrauben x Außen Ø x Dicke

S 4 x 8,2 x 0,8 S 1000	3,70	fZn
S 4 x 8,2 x 0,8 K 250	4,25	fZn
S 5 x 10,2 x 1 S 1000	4,60	fZn
S 5 x 10,2 x 1 K 250	5,40	fZn
S 6 x 12,2 x 1,2 S 1000	5,20	fZn
S 6 x 12,2 x 1,2 K 250	5,90	fZn
S 8 x 16,2 x 1,4 S 1000	8,20	fZn
S 8 x 16,2 x 1,4 K 250	8,90	fZn
S 10 x 20,25 x 1,6 S 1000	12,90	fZn

Abmessungen	VE	Stück	€/100/Obf.
S 10 x 20,25 x 1,6 K 250	13,50	fZn	
S 12 x 24,25 x 1,6 S 500	21,30	fZn	
S 12 x 24,25 x 1,6 K 100	22,80	fZn	

Artikel 88123.037

88123 Federstahl NSK-S zinklamellenbesch.



TECKENTRUP-Sperrkantscheiben, für Schrauben mit Fkl. ≤ 5,8, S (schmal) = für normale und kleine Kopfauflagen

Maße → TI-105 Anziehmomente → TI-247
Korrosionsschutz → TI-230 Schraubensicherung → TI-256

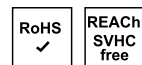

Für Schrauben M

NSK-S 4 S 1000	3,70	fZn
NSK-S 5 S 1000	4,60	fZn
NSK-S 6 S 1000	5,20	fZn
NSK-S 8 S 1000	8,20	fZn
NSK-S 10 S 1000	12,90	fZn
NSK-S 12 S 500	21,30	fZn

Artikel 88124.030

88124 Federstahl SK-M zinklamellenbesch.

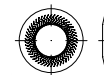

TECKENTRUP-Sperrkantscheiben, für Schrauben mit Fkl. 8.8/10.9, M (mittel) = für normale Kopfauflagen

Maße → TI-105 Anziehmomente → TI-247
Korrosionsschutz → TI-230 Schraubensicherung → TI-256

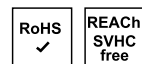

Für Schrauben x Außen Ø x Dicke

M 4 x 10,2 x 1 S 1000	4,60	fZn
M 4 x 10,2 x 1 K 250	5,20	fZn
M 5 x 12,2 x 1,2 S 1000	5,50	fZn
M 5 x 12,2 x 1,2 K 250	6,30	fZn
M 6 x 14,2 x 1,4 S 1000	6,30	fZn
M 6 x 14,2 x 1,4 K 250	7,40	fZn
M 8 x 18,2 x 1,4 S 1000	9,80	fZn
M 8 x 18,2 x 1,4 K 250	10,40	fZn
M 10 x 22,25 x 1,6 S 1000	17,20	fZn
M 10 x 22,25 x 1,6 K 250	17,70	fZn
M 12 x 27,25 x 1,8 S 500	28,00	fZn
M 12 x 27,25 x 1,8 K 100	29,50	fZn
M 14 x 30,25 x 2,4 S 500	49,50	fZn
M 14 x 30,25 x 2,4 K 100	51,00	fZn
M 16 x 32,5 x 2,5 S 500	57,00	fZn
M 16 x 32,5 x 2,5 K 100	58,00	fZn
M 18 x 35 x 3 S 100	98,00	fZn
M 20 x 40 x 3 S 100	127,00	fZn
M 24 x 50 x 3,5 S 100	209,00	fZn

Abmessungen	VE	Stück	€/100/Obf.
-------------	----	-------	------------

Artikel 88124.037

88124 Federstahl NSK-M zinklamellenbesch.

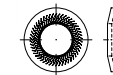

TECKENTRUP-Sperrkantscheiben, für Schrauben mit Fkl. 8.8/10.9, M (mittel) = für normale Kopfauflagen

Maße → TI-105 Anziehmomente → TI-247
Korrosionsschutz → TI-230 Schraubensicherung → TI-256

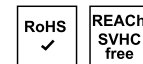

Für Schrauben M

NSK-M 4 S 1000	4,60	fZn
NSK-M 5 S 1000	5,50	fZn
NSK-M 6 S 1000	6,30	fZn
NSK-M 8 S 1000	9,80	fZn
NSK-M 10 S 1000	17,20	fZn
NSK-M 12 S 500	28,00	fZn
NSK-M 14 S 500	49,50	fZn
NSK-M 16 S 500	57,00	fZn
NSK-M 18 S 100	98,00	fZn
NSK-M 20 S 100	127,00	fZn
NSK-M 24 S 100	209,00	fZn

Artikel 88125.030

88125 Federstahl SK-B zinklamellenbesch.



TECKENTRUP-Sperrkantscheiben, für Schrauben mit Fkl. 10.9/12.9, B (breit) = für große Druckflächen

Maße → TI-106 Anziehmomente → TI-247
Korrosionsschutz → TI-230 Schraubensicherung → TI-256

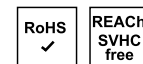

Für Schrauben x Außen Ø x Dicke

B 6 x 18,2 x 1,4 S 1000	9,80	fZnnc
B 6 x 18,2 x 1,4 K 250	10,40	fZnnc
B 8 x 22,25 x 1,9 S 1000	17,20	fZnnc
B 8 x 22,25 x 1,9 K 250	17,90	fZnnc
B 10 x 27,25 x 2,4 S 1000	33,00	fZnnc
B 10 x 27,25 x 2,4 K 250	34,00	fZnnc
B 12 x 32,3 x 2,8 S 500	53,00	fZnnc
B 12 x 32,3 x 2,8 K 100	54,00	fZnnc

Abmessungen	VE Stück	€/100/Obf.
Artikel	88125.037	
88125	Federstahl	NSK-B
	zinklamellenbesch.	

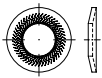

TECKENTRUP-Sperrkantscheiben, für Schrauben mit Fkl. 10.9/12.9, B (breit) = für große Druckflächen

Maße → [TI-106](#) Anziehungsmomente → [TI-247](#)
 Korrosionsschutz → [TI-230](#) Schraubensicherung → [TI-256](#)

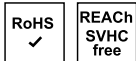

Für Schrauben M

NSK-B 6	S 1000	9,80 flZnnc
NSK-B 8	S 1000	17,20 flZnnc
NSK-B 10	S 1000	33,00 flZnnc
NSK-B 12	S 500	53,00 flZnnc

Artikel	88126.030
88126	Federstahl
	zinklamellenbesch.
	SK-Z

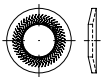

TECKENTRUP-Sperrkantscheiben, für Schrauben mit Fkl. 8.8/10.9, Z = für Zylinderschrauben

Maße → [TI-106](#) Anziehungsmomente → [TI-247](#)
 Korrosionsschutz → [TI-230](#) Schraubensicherung → [TI-256](#)



Für Schrauben x Außen Ø x Dicke

Z 6	x 9,9	x 1,4	S 1000	5,50 flZn
Z 6	x 9,9	x 1,4	K 250	6,30 flZn
Z 8	x 12,7	x 1,4	S 1000	8,20 flZn
Z 8	x 12,7	x 1,4	K 250	8,90 flZn
Z 10	x 16,1	x 1,6	S 1000	12,50 flZn
Z 10	x 16,1	x 1,6	K 250	13,20 flZn
Z 12	x 18,3	x 1,8	S 500	21,10 flZn
Z 12	x 18,3	x 1,8	K 100	22,40 flZn
Z 16	x 24,6	x 2,5	S 500	47,00 flZn
Z 16	x 24,6	x 2,5	K 100	48,50 flZn

Abmessungen	VE Stück	€/100/Obf.
Artikel	88129.030	
88129	Federstahl	SK-K
	zinklamellenbesch.	



TECKENTRUP-Sperrkantscheiben, für Schrauben mit Fkl. ≤ 10.9, K = mit Kontaktzähnen

Maße → [TI-106](#) Anziehungsmomente → [TI-247](#)
 Korrosionsschutz → [TI-230](#) Schraubensicherung → [TI-256](#)

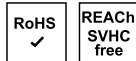

Für Schrauben x Außen Ø x Dicke

K 4	x 8,2	x 0,8	S 1000	4,70 flZnnc
K 4	x 8,2	x 0,8	K 250	5,40 flZnnc
K 5	x 10,2	x 1	S 1000	5,40 flZnnc
K 5	x 10,2	x 1	K 250	5,90 flZnnc
K 6	x 12,2	x 1,2	S 1000	5,90 flZnnc
K 6	x 12,2	x 1,2	K 250	6,50 flZnnc
K 8	x 16,2	x 1,4	S 1000	9,20 flZnnc
K 8	x 16,2	x 1,4	K 250	9,80 flZnnc
K 10	x 20,25	x 1,6	S 1000	13,90 flZnnc
K 10	x 20,25	x 1,6	K 250	14,50 flZnnc
K 12	x 24,25	x 1,6	S 500	25,50 flZnnc
K 12	x 24,25	x 1,6	K 100	27,00 flZnnc

Artikel	88129.047
88129	Federstahl
	zinklamellenbesch.
	NSK-K



TECKENTRUP-Sperrkantscheiben, für Schrauben mit Fkl. ≤ 10.9, K = mit Kontaktzähnen

Maße → [TI-106](#) Anziehungsmomente → [TI-247](#)
 Korrosionsschutz → [TI-230](#) Schraubensicherung → [TI-256](#)



Für Schrauben M

NSK-K 4	S 1000	4,70 flZn
NSK-K 5	S 1000	5,40 flZn
NSK-K 6	S 1000	5,90 flZn
NSK-K 8	S 1000	9,20 flZn
NSK-K 10	S 1000	13,90 flZn
NSK-K 12	S 500	25,50 flZn

Abmessungen	VE Stück	€/100/Obf.
Artikel	88130.030	
88130	Federstahl	VSK
	zinklamellenbesch.	

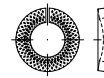

Sperrkantringe, für Schrauben mit Fkl. ≤ 8.8, VSK = Standardausführung

Maße → [TI-107](#) Schraubensicherung → [TI-256](#)
 Korrosionsschutz → [TI-230](#)

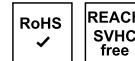

Für Schrauben M x Außen Ø x Dicke

4	x 7,6	x 0,8	S 10000	2,60 flZnnc
5	x 9,2	x 1	S 5000	3,10 flZnnc
6	x 11,8	x 1,3	S 2000	4,95 flZnnc
8	x 14,8	x 1,6	S 1000	8,50 flZnnc
10	x 18,1	x 1,8	S 500	12,40 flZnnc
12	x 21,1	x 2,1	S 500	18,50 flZnnc
14	x 24,1	x 2,4	S 250	24,80 flZnnc
16	x 27,4	x 2,8	S 200	37,50 flZnnc
18	x 29,4	x 2,8	S 150	54,00 flZnnc
20	x 33,6	x 3,2	S 100	63,00 flZnnc
22	x 35,9	x 3,2	S 100	96,00 flZnnc
24	x 40	x 4	S 50	106,00 flZnnc
27	x 43	x 4	S 50	116,00 flZnnc
30	x 48,2	x 6	S 25	187,00 flZnnc

Artikel	88131.030
88131	Federstahl
	zinklamellenbesch.
	VSK-Z

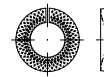

Sperrkantringe, für Schrauben mit Fkl. ≤ 8.8, VSK-Z = für Zylinderschrauben

Maße → [TI-107](#) Schraubensicherung → [TI-256](#)
 Korrosionsschutz → [TI-228](#)

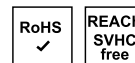

Für Schrauben M x Außen Ø x Dicke

4	x 7	x 1,2	S 10000	2,80 flZn
5	x 8,8	x 1,6	S 5000	3,75 flZn
6	x 9,9	x 1,6	S 2000	4,30 flZn
8	x 12,7	x 2	S 1000	8,60 flZn
10	x 16,1	x 2,5	S 500	12,90 flZn
12	x 18,3	x 2,5	S 500	15,70 flZn
16	x 24,6	x 3,5	S 200	34,00 flZn
20	x 30,6	x 4,5	S 100	72,00 flZn

Abmessungen	VE Stück	€/100/Obf.
Artikel	88119.030	
88119	Stahl gehärtet	
	galv. Zink-Nickel	



LOCKTIX-Scheiben

zur Sicherung von Schraubverbindungen aller Festigkeitsklassen

Maße → **TI-104** Schraubensicherung → **TI-256**
 Korrosionsschutz → **TI-228**



für Schrauben Ø

8	S	200	52,00 gal ZnNi
10	S	200	68,00 gal ZnNi
12	S	200	95,00 gal ZnNi
14	S	100	335,00 gal ZnNi
16	S	100	154,00 gal ZnNi
18	S	100	400,00 gal ZnNi
20	S	50	275,00 gal ZnNi
24	S	50	700,00 gal ZnNi

Artikel	88132.030
88132	Stahl vergütet
	zinklamellenbesch.



NORD-LOCK-Scheiben, Standard, paarweise verbunden

für Schrauben mit Fkl. ≤ 12.9

Achtung! Bei Montage auf richtige Lage der Scheibenpaare achten.

Maße → **TI-107** Anziehmomente → **TI-247**
 Korrosionsschutz → **TI-230** Schraubensicherung → **TI-256**

Montagehinweis: bei Einsatz mit Schrauben der Fkl.12.9 nicht wiederverwendbar!

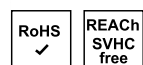

für Schrauben M

NL 3	S	200	67,00
NL 4	S	200	72,00
NL 5	S	200	77,00
NL 6	S	200	77,00
NL 8	S	200	98,00
NL 10	S	200	106,00
NL 12	S	200	179,00
NL 14	S	100	260,00
NL 16	S	100	270,00
NL 18	S	100	430,00
NL 20	S	100	395,00
NL 22	S	100	590,00
NL 24	S	100	630,00
NL 27	S	50	1100,00
NL 30	S	50	1170,00
NL 33	S	25	1190,00
NL 36	S	25	1650,00

Abmessungen	VE Stück	€/100/Obf.
Artikel	88132.034	
88132	Stahl vergütet	SP
	zinklamellenbesch.	



NORD-LOCK-Scheiben, paarweise verbunden, SP = mit großer Auflagefläche

für Schrauben mit Fkl. ≤ 12.9

Achtung! Bei Montage auf richtige Lage der Scheibenpaare achten.

Maße → **TI-107** Anziehmomente → **TI-247**
 Korrosionsschutz → **TI-230** Schraubensicherung → **TI-256**

Montagehinweis: bei Einsatz mit Schrauben der Fkl.12.9 nicht wiederverwendbar!



für Schrauben M

NL 4 SP	S	200	74,00 flZn
NL 5 SP	S	200	87,00 flZn
NL 6 SP	S	200	109,00 flZn
NL 8 SP	S	200	116,00 flZn
NL 10 SP	S	200	200,00 flZn
NL 12 SP	S	100	300,00 flZn
NL 14 SP	S	100	440,00 flZn
NL 16 SP	S	100	445,00 flZn
NL 18 SP	S	100	630,00 flZn
NL 20 SP	S	100	630,00 flZn
NL 22 SP	S	50	1050,00 flZn
NL 24 SP	S	50	1300,00 flZn
NL 27 SP	S	25	1320,00 flZn
NL 30 SP	S	25	1880,00 flZn
NL 33 SP	S	25	1890,00 flZn
NL 36 SP	S	25	1950,00 flZn

Artikel	88132.035
88132	Stahl vergütet
	zinklamellenbesch.
	SC



NORD-LOCK-Scheiben, paarweise verbunden, SC = für HV-Verbindungen nach EN 14399-4

Achtung! Bei Montage auf richtige Lage der Scheibenpaare achten.

Maße → **TI-107** Anziehmomente → **TI-247**
 Korrosionsschutz → **TI-230** Schraubensicherung → **TI-256**

Baufichtliche Zulassung Z-14.4-629



für Schrauben M

NL 12 SC	S	100	248,00
NL 16 SC	S	100	375,00
NL 20 SC	S	100	650,00
NL 22 SC	S	50	970,00
NL 24 SC	S	50	1150,00

Abmessungen	VE Stück	€/100/Obf.	
NL 27 SC	S	25	1250,00
NL 30 SC	S	25	1580,00
NL 36 SC	S	25	1680,00

Artikel	88132.044
88132	Stahl vergütet
	zinklamellenbesch.
	NL X

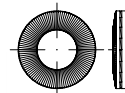

NORD-LOCK Keilsicherungsfederscheiben® X-series, paarweise verbunden

Korrosionsbeständigkeit NSS: 600h RR, Temperaturbereich -40 bis +150 °C, für Schrauben ≤ Fkl. 12.9

Achtung! Bei Montage auf richtige Lage der Scheibenpaare achten.

Maße → **TI-107** Anziehmomente → **TI-247**
 Korrosionsschutz → **TI-230** Schraubensicherung → **TI-256**

Montagehinweis: bei Einsatz mit Schrauben der Fkl.12.9 nicht wiederverwendbar!

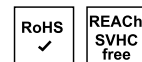

für Schrauben M

NLX 6	S	200	137,00 flZn
NLX 8	S	200	148,00 flZn
NLX 10	S	200	158,00 flZn
NLX 12	S	200	265,00 flZn
NLX 14	S	100	350,00 flZn
NLX 16	S	100	380,00 flZn
NLX 20	S	100	580,00 flZn

Artikel	88132.045
88132	Stahl vergütet
	zinklamellenbesch.
	NL X-SP

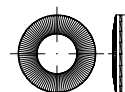

NORD-LOCK Keilsicherungsfederscheiben® X-series, paarweise verbunden, SP = mit großer Auflagefläche

Korrosionsbeständigkeit NSS: 600h RR, Temperaturbereich -40 bis +150 °C, für Schrauben ≤ Fkl. 12.9

Achtung! Bei Montage auf richtige Lage der Scheibenpaare achten.

Maße → **TI-107** Anziehmomente → **TI-247**
 Korrosionsschutz → **TI-230** Schraubensicherung → **TI-256**

Montagehinweis: bei Einsatz mit Schrauben der Fkl.12.9 nicht wiederverwendbar!

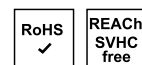

für Schrauben M

NLX 6 SP	S	200	148,00 flZn
NLX 8 SP	S	200	148,00 flZn
NLX 10 SP	S	200	275,00 flZn
NLX 12 SP	S	100	380,00 flZn

Abmessungen	VE	Stück	€/100/Obf.
NLX 16 SP	S	100	580,00 flZn
NLX 20 SP	S	50	990,00 flZn

Artikel	88032.030
88032	Stahl HLS zinklamellenbesch.

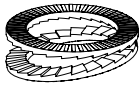

HEICO-LOCK Keilsicherungsscheiben, paarweise verbunden, HLS = Standard

für Schrauben mit Fkl. ≤ 12.9

Achtung! Bei Montage auf richtige Lage der Scheibenpaare achten.

Maße → **TI-103** Anziehmomente → **TI-247**
 Korrosionsschutz → **TI-230** Schraubensicherung → **TI-256**

Montagehinweis: bei Einsatz mit Schrauben der Fkl.12.9 wird eine Wiederverwendung nicht empfohlen!

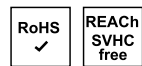

für Schrauben M

HLS-3	S	200	40,50 flZnnc
HLS-3,5	S	200	45,00 flZnnc
HLS-4	S	200	45,50 flZnnc
HLS-5	S	200	41,00 flZnnc
HLS-6	S	200	58,00 flZnnc
HLS-8	S	200	70,00 flZnnc
HLS-10	S	200	78,00 flZnnc
HLS-12	S	200	130,00 flZnnc
HLS-14	S	100	184,00 flZnnc
HLS-16	S	100	184,00 flZnnc
HLS-18	S	100	285,00 flZnnc
HLS-20	S	100	295,00 flZnnc
HLS-22	S	100	395,00 flZnnc
HLS-24	S	100	410,00 flZnnc
HLS-27	S	50	720,00 flZnnc
HLS-30	S	50	810,00 flZnnc
HLS-33	S	25	880,00 flZnnc
HLS-36	S	25	1030,00 flZnnc
HLS-39	S	25	1220,00 flZnnc
HLS-42	S	25	1260,00 flZnnc

Abmessungen	VE	Stück	€/100/Obf.
Artikel	88032.034		

88032	Stahl HLB zinklamellenbesch.
--------------	--

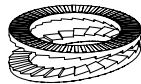

HEICO-LOCK Keilsicherungsscheiben, paarweise verbunden, HLB = mit großer Auflagefläche

für Schrauben mit Fkl. ≤ 12.9

Achtung! Bei Montage auf richtige Lage der Scheibenpaare achten.

Maße → **TI-103** Anziehmomente → **TI-247**
 Korrosionsschutz → **TI-230** Schraubensicherung → **TI-256**

Montagehinweis: bei Einsatz mit Schrauben der Fkl.12.9 wird eine Wiederverwendung nicht empfohlen!



für Schrauben M

HLB-3,5	S	200	65,00 flZnnc
HLB-4	S	200	65,00 flZnnc
HLB-5	S	200	65,00 flZnnc
HLB-6	S	200	78,00 flZnnc
HLB-8	S	200	84,00 flZnnc
HLB-10	S	200	134,00 flZnnc
HLB-12	S	100	197,00 flZnnc
HLB-14	S	100	255,00 flZnnc
HLB-16	S	100	305,00 flZnnc
HLB-18	S	100	430,00 flZnnc
HLB-20	S	100	430,00 flZnnc
HLB-22	S	50	710,00 flZnnc
HLB-24	S	50	790,00 flZnnc
HLB-27	S	25	870,00 flZnnc

Artikel	88032.036
88032	Stahl HLK zinklamellenbesch.



HEICO-LOCK Keilsicherungsscheiben, paarweise verbunden, HLK = für HV-Verbindungen nach EN 14399-4

für Schrauben mit Fkl. ≤ 12.9

Achtung! Bei Montage auf richtige Lage der Scheibenpaare achten.

Maße → **TI-103** Anziehmomente → **TI-247**
 Korrosionsschutz → **TI-230** Schraubensicherung → **TI-256**

Montagehinweis: bei Einsatz mit Schrauben der Fkl.12.9 wird eine Wiederverwendung nicht empfohlen!



für Schrauben M

HLK-12	S	200	189,00 flZnnc
HLK-16	S	100	300,00 flZnnc
HLK-20	S	100	510,00 flZnnc

Abmessungen	VE	Stück	€/100/Obf.
HLK-22	S	50	650,00 flZnnc
HLK-24	S	50	750,00 flZnnc
HLK-27	S	25	860,00 flZnnc
HLK-30	S	25	1100,00 flZnnc
HLK-36	S	25	1240,00 flZnnc

Artikel	88033.030
88033	Stahl zinklamellenbesch.

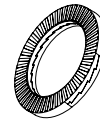

HEICO-LOCK Ringsicherungsscheiben, Standard, paarweise verbunden, mit Sicherungsring aus Kunststoff

Maße → **TI-103** Schraubensicherung → **TI-256**
 Korrosionsschutz → **TI-230**

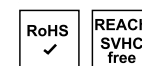

für Schrauben M

HLRS-5	S	200	85,00 flZnnc
HLRS-6	S	200	90,00 flZnnc
HLRS-8	S	200	100,00 flZnnc
HLRS-10	S	200	111,00 flZnnc
HLRS-12	S	200	188,00 flZnnc
HLRS-16	S	100	270,00 flZnnc

Artikel	88033.034
88033	Stahl B zinklamellenbesch.

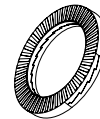

HEICO-LOCK Ringsicherungsscheiben, paarweise verbunden, mit Sicherungsring aus Kunststoff, B = mit großer Auflagefläche

Maße → **TI-103** Schraubensicherung → **TI-256**
 Korrosionsschutz → **TI-230**

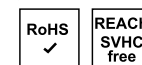

für Schrauben M

HLRB-4	S	200	94,00 flZnnc
HLRB-5	S	200	100,00 flZnnc
HLRB-6	S	200	112,00 flZnnc
HLRB-8	S	200	121,00 flZnnc
HLRB-10	S	200	193,00 flZnnc
HLRB-12	S	100	285,00 flZnnc
HLRB-14	S	100	365,00 flZnnc
HLRB-16	S	100	440,00 flZnnc

Abmessungen	VE Stück	€/100/Obf.
Artikel	88034.130	
88034	10	zinklamellenbesch.

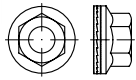

HEICO-LOCK Keilsicherungsmuttern mit unverlierbarer Keilsicherungs-scheibe

Maße → [TI-69](#) Schraubensicherung → [TI-256](#)
Korrosionsschutz → [TI-230](#)

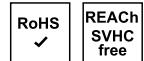

HLM-6	S	100	237,00 flZnnc
HLM-8	S	100	305,00 flZnnc
HLM-10	S	50	465,00 flZnnc
HLM-12	S	50	590,00 flZnnc
HLM-16	S	25	1160,00 flZnnc

Artikel	88035.030
88035	Stahl
	zinklamellenbesch.

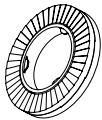

HEICO-LOCK Kombi-Scheiben, Standard, paarweise verbunden, mit Sicherungsring aus Kunststoff

Maße → [TI-104](#) Schraubensicherung → [TI-256](#)
Korrosionsschutz → [TI-230](#)



für Schrauben M

HKS-8	S	200	77,00 flZnnc
HKS-10	S	200	86,00 flZnnc
HKS-12	S	200	144,00 flZnnc
HKS-16	S	100	204,00 flZnnc

Abmessungen	VE Stück	€/100/Obf.
Artikel	88035.034	
88035	Stahl	B
	zinklamellenbesch.	

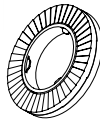

HEICO-LOCK Kombi-Scheiben, paarweise verbunden, mit Sicherungsring aus Kunststoff, B = mit großer Auflagefläche

Maße → [TI-104](#) Schraubensicherung → [TI-256](#)
Korrosionsschutz → [TI-230](#)

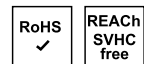

für Schrauben M

HKB-8	S	200	92,00 flZnnc
HKB-10	S	200	149,00 flZnnc
HKB-12	S	100	216,00 flZnnc
HKB-16	S	100	335,00 flZnnc

Artikel	88133.010
88133	Stahl
	galvanisch verzinkt
	Typ 1

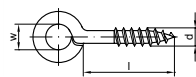

Ringschraubösen Typ 1, mit Holzschrauben-Gewinde

Maße → [TI-54](#) Korrosionsschutz → [TI-228](#)

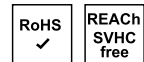

I x D (d/für Dübel)

6	x	3(1,8/4)	S	100	18,60 gal Zn
8	x	3(1,8/4)	S	100	18,60 gal Zn
8	x	4(2,3/4)	S	100	19,30 gal Zn
10	x	3(1,8/4)	S	100	18,60 gal Zn
10	x	4(2,3/4)	S	100	19,30 gal Zn
10	x	6(2,9/4)	S	100	22,00 gal Zn
12	x	3(1,8/4)	S	100	18,60 gal Zn
12	x	4(2,3/4)	S	100	19,30 gal Zn
12	x	6(2,9/4)	S	100	22,20 gal Zn
12	x	8(3,3/5)	S	100	27,00 gal Zn
12	x	10(3,5/5)	S	100	29,00 gal Zn
16	x	4(2,3/4)	S	100	19,70 gal Zn
16	x	6(2,9/4)	S	100	22,20 gal Zn
16	x	8(3,3/5)	S	100	28,00 gal Zn
16	x	10(3,3/5)	S	100	29,50 gal Zn
16	x	12(3,8/6)	S	100	34,00 gal Zn
20	x	6(2,9/4)	S	100	24,50 gal Zn
20	x	8(3,3/5)	S	100	28,00 gal Zn
20	x	10(3,3/5)	S	100	30,50 gal Zn
20	x	12(3,8/6)	S	100	34,00 gal Zn
25	x	8(3,3/5)	S	100	13,40 gal Zn
25	x	10(3,3/5)	S	100	31,50 gal Zn
25	x	12(3,8/6)	S	100	36,00 gal Zn
25	x	16(4,3/6)	S	100	47,00 gal Zn
30	x	8(3,3/5)	S	100	29,50 gal Zn
30	x	10(3,3/5)	S	100	31,50 gal Zn
30	x	12(3,8/6)	S	100	36,50 gal Zn
30	x	14(3,8/6)	S	100	38,50 gal Zn

Abmessungen	VE Stück	€/100/Obf.			
30	x	16(4,3/6)	S	100	51,00 gal Zn
30	x	18(4,7/6)	S	100	57,00 gal Zn
40	x	12(3,8/6)	S	100	38,50 gal Zn
40	x	14(3,8/6)	S	100	43,00 gal Zn
40	x	16(4,3/6)	S	100	54,00 gal Zn
40	x	18(4,7/6)	S	100	62,00 gal Zn
40	x	20(5,2/7)	S	100	68,00 gal Zn
50	x	14(3,9/6)	S	100	47,50 gal Zn
50	x	16(4,3/6)	S	100	57,00 gal Zn
50	x	18(4,7/6)	S	100	67,00 gal Zn
50	x	20(5,2/7)	S	100	84,00 gal Zn

Artikel	88135.010
88135	Stahl
	galvanisch verzinkt
	Typ 45

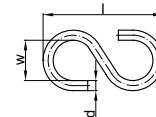

S-Haken Typ 45

Maße → [TI-137](#) Korrosionsschutz → [TI-228](#)

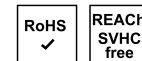

I x w x d

25	x	8	x	2,3	S	100	29,50 gal Zn
30	x	9	x	2,8	S	100	30,50 gal Zn
40	x	11	x	3,8	S	100	41,50 gal Zn
50	x	16	x	4,7	S	100	64,00 gal Zn
60	x	18	x	5,8	S	100	99,00 gal Zn
70	x	20	x	6,8	S	100	160,00 gal Zn
80	x	22	x	7,6	S	100	255,00 gal Zn

Artikel	88136.010
88136	Stahl
	galvanisch verzinkt
	Typ 48

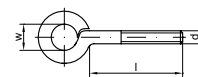

Gewindeösen Typ 48, mit metrischem Gewinde

Maße → [TI-36](#) Korrosionsschutz → [TI-228](#)

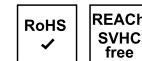

d x I x D

M 3	x	10 D 5	S	100	21,20 gal Zn
M 3	x	15 D 5	S	100	21,60 gal Zn
M 4	x	10 D 6	S	100	21,70 gal Zn
M 4	x	15 D 6	S	100	25,50 gal Zn
M 4	x	20 D 6	S	100	28,00 gal Zn
M 4	x	25 D 6	S	100	28,00 gal Zn
M 4	x	30 D 6	S	100	29,50 gal Zn
M 4	x	40 D 6	S	100	30,50 gal Zn
M 5	x	15 D 8	S	100	36,00 gal Zn
M 5	x	20 D 8	S	100	36,50 gal Zn
M 5	x	25 D 8	S	100	38,50 gal Zn
M 5	x	30 D 8	S	100	39,50 gal Zn
M 5	x	40 D 8	S	100	42,00 gal Zn
M 5	x	50 D 8	S	100	44,00 gal Zn
M 5	x	60 D 8	S	100	46,00 gal Zn
M 6	x	10 D 10	S	100	43,00 gal Zn
M 6	x	15 D 10	S	100	44,50 gal Zn

Abmessungen	VE	Stück	€/100/Obf.
M 6 x 20 D 10	S	100	45,50 gal Zn
M 6 x 25 D 10	S	100	48,00 gal Zn
M 6 x 30 D 10	S	100	49,50 gal Zn
M 6 x 40 D 10	S	100	54,00 gal Zn
M 6 x 50 D 10	S	100	59,00 gal Zn
M 6 x 60 D 10	S	100	62,00 gal Zn
M 6 x 70 D 10	S	100	67,00 gal Zn
M 6 x 80 D 10	S	100	73,00 gal Zn
M 8 x 20 D 12	S	50	83,00 gal Zn
M 8 x 25 D 12	S	50	86,00 gal Zn
M 8 x 30 D 12	S	50	94,00 gal Zn
M 8 x 40 D 12	S	50	101,00 gal Zn
M 8 x 50 D 12	S	50	107,00 gal Zn
M 8 x 60 D 12	S	50	120,00 gal Zn
M 8 x 80 D 12	S	50	120,00 gal Zn
M 8 x 100 D 12	S	50	132,00 gal Zn
M 10 x 30 D 14	S	50	158,00 gal Zn
M 10 x 40 D 14	S	50	164,00 gal Zn
M 10 x 50 D 14	S	50	181,00 gal Zn
M 10 x 60 D 14	S	50	194,00 gal Zn
M 10 x 80 D 14	S	50	224,00 gal Zn
M 10 x 100 D 14	S	50	260,00 gal Zn
M 12 x 100 D 18	S	25	475,00 gal Zn

Artikel 88137.010
88137 Stahl Typ 4
 galvanisch verzinkt

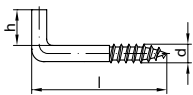

Gerade Schraubhaken Typ 4, mit Holzschrauben-Gewinde

Maße → TI-54 Korrosionsschutz → TI-228

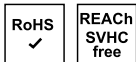

l x d x h

20	x	2,8	x	8	S	200	15,30 gal Zn
25	x	2,8	x	10	S	100	16,50 gal Zn
30	x	3,3	x	11	S	100	20,70 gal Zn
40	x	4,1	x	11	S	100	24,50 gal Zn
50	x	4,8	x	13	S	100	27,50 gal Zn
60	x	4,8	x	13	S	100	33,00 gal Zn
80	x	5,5	x	18	S	100	59,00 gal Zn
100	x	6,0	x	18	S	100	91,00 gal Zn

Artikel 88138.010
88138 Stahl Typ 4E
 galvanisch verzinkt

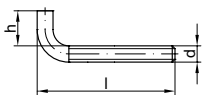

Gerade Schraubhaken Typ 4E, mit metrischem Gewinde

Maße → TI-36 Korrosionsschutz → TI-228

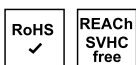

d x l x h

M 4	x	40	x	10	S	100	54,00 gal Zn
M 5	x	50	x	12	S	100	78,00 gal Zn
M 6	x	60	x	14	S	100	109,00 gal Zn
M 8	x	60	x	18	S	100	197,00 gal Zn

Abmessungen VE Stück €/100/Obf.
 Artikel 88139.010
88139 Stahl Typ 7
 galvanisch verzinkt

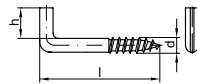

Schlitzschraubhaken Typ 7, mit Holzschrauben-Gewinde

Maße → TI-55 Korrosionsschutz → TI-228

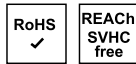

l x d

40	x	4,4	x	9	S	100	38,00 gal Zn
50	x	4,4	x	9	S	100	39,50 gal Zn
30	x	5,2	x	10	S	100	42,50 gal Zn
40	x	5,2	x	10	S	100	46,00 gal Zn
50	x	5,2	x	10	S	100	50,00 gal Zn
60	x	5,2	x	10	S	100	53,00 gal Zn
80	x	5,8	x	12	S	100	64,00 gal Zn
100	x	5,8	x	12	S	100	72,00 gal Zn

Artikel 88140.010
88140 Stahl Typ 11
 galvanisch verzinkt

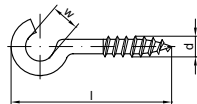

Gebogene Schraubhaken Typ 11, mit Holzschrauben-Gewinde

Maße → TI-55 Korrosionsschutz → TI-228

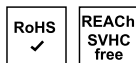

l x d x D

20	x	2,3	x	6	S	100	18,20 gal Zn
25	x	2,3	x	8	S	100	20,50 gal Zn
30	x	2,3	x	10	S	100	21,30 gal Zn
40	x	2,9	x	12	S	100	24,50 gal Zn
50	x	3,3	x	16	S	100	28,50 gal Zn
60	x	3,3	x	16	S	100	33,00 gal Zn
70	x	3,8	x	22	S	100	57,00 gal Zn
80	x	4,3	x	25	S	100	66,00 gal Zn
100	x	4,8	x	25	S	100	89,00 gal Zn

Abmessungen VE Stück €/100/Obf.
 Artikel 88141.030
88141 Stahl Typ 11 K
 weiß beschichtet

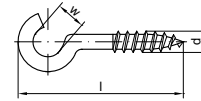

Gebogene Schraubhaken Typ 11 K, mit Holzschrauben-Gewinde

Maße → TI-55 Korrosionsschutz → TI-228



l x d x D

25	x	2,3	x	8	S	100	83,00
30	x	2,3	x	10	S	100	83,00
40	x	2,9	x	12	S	100	89,00
50	x	3,3	x	16	S	100	96,00
60	x	3,3	x	16	S	100	105,00
80	x	4,3	x	25	S	100	114,00

Artikel 88142.010
88142 Stahl Typ 11 E
 galvanisch verzinkt

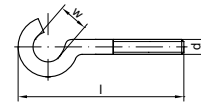

Gebogene Schraubhaken Typ 11 E, mit metrischem Gewinde

Maße → TI-36 Korrosionsschutz → TI-228



d x l x D

M 4	x	40	D	16	S	100	32,50 gal Zn
M 4	x	50	D	16	S	100	33,50 gal Zn
M 5	x	50	D	16	S	100	47,50 gal Zn
M 5	x	60	D	16	S	100	48,50 gal Zn
M 6	x	50	D	18	S	100	65,00 gal Zn
M 6	x	60	D	18	S	100	68,00 gal Zn
M 8	x	70	D	22	S	100	112,00 gal Zn
M 8	x	80	D	22	S	100	118,00 gal Zn



- ✓ Große Artikelvielfalt
- ✓ Verlässliche Qualität
- ✓ Hohe Lieferbereitschaft

Abmessungen VE Stück €/100/Obf.

Artikel	88143.010		
88143	Stahl	Typ 10	galvanisch verzinkt

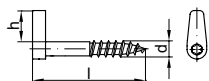

Winkelraubhaken Typ 10, mit Holzschrauben-Gewinde, mit Innensechsrund-Antrieb

Maße → TI-55 Korrosionsschutz → TI-228

Zur maschinellen Montage geeignet



l x d						
50	x	5,2	x	9	S	100 82,00 gal Zn
65	x	5,8	x	10	S	100 95,00 gal Zn
80	x	5,8	x	10	S	100 104,00 gal Zn

Artikel	88144.010		
88144	Stahl	Typ 18	galvanisch verzinkt

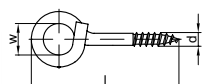

Starke Deckenhaken Typ 18, gewundene Form, mit Holzschrauben-Gewinde

Nicht für Schaukeln geeignet.

Maße → TI-56 Korrosionsschutz → TI-228



l x d x w						
100	x	8,2	x	22	S	20 530,00 gal Zn
120	x	8,9	x	22	S	20 640,00 gal Zn
140	x	8,9	x	22	S	20 680,00 gal Zn
140	x	9,9	x	22	S	20 800,00 gal Zn

Artikel	88145.010		
88145	Stahl	Typ 18E	galvanisch verzinkt

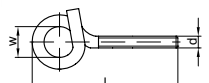

Starke Deckenhaken Typ 18E, gewundene Form, mit metrischem Gewinde

Maße → TI-37 Korrosionsschutz → TI-228

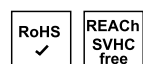

d x l x w						
M 10	x	120	x	22	S	20 870,00 gal Zn
M 10	x	140	x	22	S	20 910,00 gal Zn
M 12	x	160	x	22	S	10 1340,00 gal Zn
M 12	x	180	x	22	S	10 1460,00 gal Zn

Abmessungen VE Stück €/100/Obf.

Artikel	88149.010		
88149	Stahl	Typ 23 E	galvanisch verzinkt

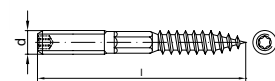

Stockschrauben mit metrischem und Holzschraubengewinde

Korrosionsschutz → TI-228



Ø M x Gesamtlänge

M 5	x	40	S	100	42,50 gal Zn
M 5	x	50	S	100	48,50 gal Zn
M 6	x	40	S	100	56,00 gal Zn
M 6	x	50	S	100	56,00 gal Zn
M 6	x	60	S	100	62,00 gal Zn
M 6	x	70	S	100	65,00 gal Zn
M 6	x	80	S	100	66,00 gal Zn
M 6	x	100	S	100	69,00 gal Zn
M 6	x	120	S	100	73,00 gal Zn
M 8	x	50	S	100	72,00 gal Zn
M 8	x	60	S	100	77,00 gal Zn
M 8	x	70	S	100	84,00 gal Zn
M 8	x	80	S	100	95,00 gal Zn
M 8	x	100	S	100	107,00 gal Zn
M 8	x	120	S	100	143,00 gal Zn
M 8	x	140	S	100	165,00 gal Zn
M 8	x	150	S	100	186,00 gal Zn
M 8	x	160	S	100	199,00 gal Zn
M 8	x	180	S	100	232,00 gal Zn
M 8	x	200	S	50	255,00 gal Zn
M 10	x	60	S	100	120,00 gal Zn
M 10	x	80	S	50	120,00 gal Zn
M 10	x	100	S	50	137,00 gal Zn
M 10	x	120	S	50	155,00 gal Zn
M 10	x	130	S	50	167,00 gal Zn
M 10	x	140	S	50	175,00 gal Zn
M 10	x	180	S	50	260,00 gal Zn
M 12	x	80	S	50	155,00 gal Zn
M 12	x	100	S	50	171,00 gal Zn
M 12	x	120	S	50	206,00 gal Zn
M 12	x	160	S	50	410,00 gal Zn
M 12	x	200	S	50	520,00 gal Zn

Artikel	88200.016		
88200	Stahl gehärtet	RST-Z	galvanisch verzinkt



Gewindefurchende Schrauben mit LIKO für Kunststoffe (Thermoplaste), Z = Pozidriv-Kreuzschlitz

Maße → TI-48

Korrosionsschutz → TI-228



2,2	x	6-Z	S	1000	8,90 gal Zn
2,2	x	8-Z	S	1000	9,10 gal Zn
2,5	x	8-Z	S	1000	9,20 gal Zn

Abmessungen VE Stück €/100/Obf.

2,5	x	10-Z	S	1000	7,90 gal Zn
3	x	6-Z	S	1000	8,90 gal Zn
3	x	8-Z	S	1000	8,00 gal Zn
3	x	10-Z	S	1000	9,50 gal Zn
3	x	12-Z	S	1000	9,50 gal Zn
3,5	x	10-Z	S	500	8,90 gal Zn
3,5	x	12-Z	S	500	8,80 gal Zn
3,5	x	16-Z	S	500	10,50 gal Zn
4	x	12-Z	S	500	10,10 gal Zn
4	x	16-Z	S	500	11,10 gal Zn
4	x	20-Z	S	500	11,90 gal Zn
5	x	12-Z	S	500	11,40 gal Zn
5	x	16-Z	S	500	12,80 gal Zn
5	x	20-Z	S	500	16,40 gal Zn
6	x	16-Z	S	250	20,90 gal Zn
6	x	20-Z	S	250	19,30 gal Zn
6	x	25-Z	S	250	20,70 gal Zn

Artikel	88200.014		
88200	Stahl gehärtet	RST-ISR	galvanisch verzinkt



Gewindefurchende Schrauben mit LIKO für Kunststoffe (Thermoplaste), ISR = Innensechsrund

Maße → TI-48

Korrosionsschutz → TI-228

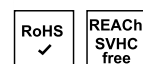

2,2	x	5-T6	S	1000	9,50 gal Zn
2,2	x	6-T6	S	1000	8,90 gal Zn
2,2	x	8-T6	S	1000	9,10 gal Zn
2,2	x	10-T6	S	1000	7,80 gal Zn
2,5	x	5-T8	S	1000	8,90 gal Zn
2,5	x	6-T8	S	1000	9,00 gal Zn
2,5	x	8-T8	S	1000	9,20 gal Zn
2,5	x	10-T8	S	1000	7,90 gal Zn
2,5	x	12-T8	S	1000	9,00 gal Zn
3	x	6-T10	S	1000	7,90 gal Zn
3	x	8-T10	S	1000	8,00 gal Zn
3	x	10-T10	S	1000	8,20 gal Zn
3	x	12-T10	S	1000	9,50 gal Zn
3	x	14-T10	S	1000	9,40 gal Zn
3	x	16-T10	S	1000	9,50 gal Zn
3,5	x	8-T10	S	500	9,60 gal Zn
3,5	x	10-T10	S	500	8,90 gal Zn
3,5	x	12-T10	S	500	10,50 gal Zn
3,5	x	16-T10	S	500	10,50 gal Zn
4	x	8-T20	S	500	10,50 gal Zn
4	x	10-T20	S	500	9,50 gal Zn
4	x	12-T20	S	500	10,10 gal Zn
4	x	14-T20	S	500	11,10 gal Zn
4	x	16-T20	S	500	11,10 gal Zn
4	x	20-T20	S	500	11,90 gal Zn
5	x	10-T20	S	500	12,00 gal Zn
5	x	12-T20	S	500	12,60 gal Zn
5	x	14-T20	S	500	13,10 gal Zn
5	x	16-T20	S	500	13,80 gal Zn
5	x	20-T20	S	500	14,40 gal Zn
6	x	16-T25	S	250	18,30 gal Zn
6	x	20-T25	S	250	20,70 gal Zn
6	x	25-T25	S	250	20,70 gal Zn

Abmessungen	VE Stück	€/100/Obf.
Artikel 88202.016		
88202 Stahl gehärtet RST-Z galvanisch verzinkt		



Gewindefurchende Schrauben mit Liko und angepresster Scheibe für Kunststoff (Thermoplaste), Z = Pozidriv-Kreuzschlitz

Maße → TI-49 Korrosionsschutz → TI-228



2,2 x 6-Z	S 1000	9,00 gal Zn
2,2 x 8-Z	S 1000	9,20 gal Zn
2,5 x 8-Z	S 1000	9,90 gal Zn
2,5 x 10-Z	S 1000	9,90 gal Zn
3 x 8-Z	S 1000	8,60 gal Zn
3 x 10-Z	S 1000	8,80 gal Zn
3 x 12-Z	S 1000	9,90 gal Zn
3,5 x 10-Z	S 500	9,50 gal Zn
3,5 x 12-Z	S 500	9,20 gal Zn
3,5 x 16-Z	S 500	10,90 gal Zn
4 x 12-Z	S 500	10,70 gal Zn
4 x 16-Z	S 500	11,80 gal Zn
4 x 20-Z	S 500	12,50 gal Zn
5 x 12-Z	S 500	12,00 gal Zn
5 x 16-Z	S 500	13,40 gal Zn
5 x 20-Z	S 500	15,30 gal Zn
6 x 16-Z	S 250	18,40 gal Zn
6 x 20-Z	S 250	19,40 gal Zn
6 x 25-Z	S 250	20,90 gal Zn

Artikel	88202.014
88202 Stahl gehärtet RST-ISR galvanisch verzinkt	



Gewindefurchende Schrauben mit Liko und angepresster Scheibe für Kunststoff (Thermoplaste), ISR = Innensechsrund

Maße → TI-49 Korrosionsschutz → TI-228



2,2 x 6-T6	S 1000	8,90 gal Zn
2,2 x 8-T6	S 1000	9,10 gal Zn
2,5 x 8-T8	S 1000	9,20 gal Zn
2,5 x 10-T6	S 1000	12,80 gal Zn
3 x 8-T10	S 1000	8,00 gal Zn
3 x 10-T10	S 1000	8,20 gal Zn
3 x 12-T10	S 1000	9,50 gal Zn
3,5 x 10-T10	S 500	8,90 gal Zn
3,5 x 12-T10	S 500	8,80 gal Zn
3,5 x 16-T10	S 500	10,50 gal Zn
3,5 x 20-T10	S 500	16,40 gal Zn
4 x 12-T20	S 500	10,10 gal Zn
4 x 16-T20	S 500	11,10 gal Zn

Abmessungen	VE Stück	€/100/Obf.
4 x 20-T20	S 500	16,40 gal Zn
5 x 12-T20	S 500	18,40 gal Zn
5 x 20-T20	S 500	14,80 gal Zn
6 x 16-T25	S 250	18,40 gal Zn
6 x 20-T25	S 250	19,40 gal Zn
6 x 25-T25	S 250	20,90 gal Zn

Artikel	88203.014
88203 Stahl geh. RSTplus-ISR galvanisch verzinkt	



Gewindefurchende Schrauben mit Liko für Kunstst. (Thermoplaste), RSTplus = höhere Vorspannkraft, ISR = Innensechsrund

Maße → TI-49 Korrosionsschutz → TI-228

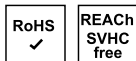

2,2 x 6-T6	S 1000	11,10 gal Zn
2,2 x 8-T6	S 1000	11,40 gal Zn
2,5 x 8-T8	S 1000	10,80 gal Zn
2,5 x 10-T8	S 1000	10,90 gal Zn
3 x 8-T10	S 1000	9,20 gal Zn
3 x 10-T10	S 1000	9,50 gal Zn
3 x 12-T10	S 1000	10,80 gal Zn
3,5 x 10-T15	S 500	10,20 gal Zn
3,5 x 12-T15	S 500	10,10 gal Zn
3,5 x 16-T15	S 500	12,00 gal Zn
4 x 12-T20	S 500	11,70 gal Zn
4 x 16-T20	S 500	12,90 gal Zn
4 x 20-T20	S 500	16,30 gal Zn
5 x 12-T25	S 500	13,70 gal Zn
5 x 16-T25	S 500	15,70 gal Zn
5 x 20-T25	S 500	18,20 gal Zn
6 x 16-T30	S 250	19,70 gal Zn
6 x 20-T30	S 250	21,30 gal Zn
6 x 25-T30	S 250	22,90 gal Zn

Artikel	88204.014
88204 Stahl geh. RSTplus-ISR galvanisch verzinkt	



Gewindefurchende Schrauben mit Liko und angepresster Scheibe für Kunststoff (Thermoplaste), RSTplus = höhere Vorspannkraft, ISR = Innensechsrund

Maße → TI-49 Korrosionsschutz → TI-228



2,2 x 6-T6	S 1000	11,10 gal Zn
2,2 x 8-T6	S 1000	11,40 gal Zn
2,5 x 8-T8	S 1000	10,80 gal Zn
2,5 x 10-T8	S 1000	10,90 gal Zn
3 x 8-T10	S 1000	9,20 gal Zn

Abmessungen	VE Stück	€/100/Obf.
3 x 10-T10	S 1000	9,50 gal Zn
3 x 12-T10	S 1000	10,80 gal Zn
3,5 x 10-T15	S 500	10,20 gal Zn
3,5 x 12-T15	S 500	10,10 gal Zn
3,5 x 16-T15	S 500	12,00 gal Zn
4 x 12-T20	S 500	11,70 gal Zn
4 x 16-T20	S 500	12,90 gal Zn
4 x 20-T20	S 500	16,30 gal Zn
5 x 12-T25	S 500	13,70 gal Zn
5 x 16-T25	S 500	15,70 gal Zn
5 x 20-T25	S 500	18,20 gal Zn
6 x 16-T30	S 250	20,60 gal Zn
6 x 20-T30	S 250	22,00 gal Zn
6 x 25-T30	S 250	23,50 gal Zn

Artikel	88301.000
88301 Stahl Typ 610	

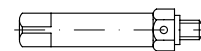

ENSAT-Eindreh-Werkzeug Typ 610, für Handmontage, oberflächenbündig

REACH → TI-262



Für Innen-Nutzgewinde

M 3	S 1	9800,00
M 4	S 1	10100,00
M 5	S 1	10600,00
M 6	S 1	10900,00
M 8	S 1	11300,00
M 10	S 1	14500,00
M 12	S 1	17400,00
M 14	S 1	21700,00

Artikel	88305.000
88305 Stahl Typ 620	

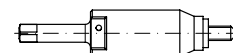

ENSAT-Eindreh-Werkzeuge Typ 620, für Maschinenmontage, oberflächenbündig



Für Innen-Nutzgewinde

M 3	S 1	24600,00
M 4	S 1	24600,00
M 5	S 1	31200,00
M 6	S 1	31200,00
M 8	S 1	31200,00
M 10	S 1	40200,00
M 12	S 1	40200,00
M 14	S 1	72300,00
M 16	S 1	72300,00
M 20	S 1	132300,00

Abmessungen VE Stück €/100/Obf.

Artikel	88912.100
88912	100 RIPP

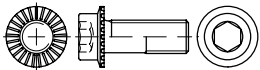

Zylinder-Flanschschrauben mit Innensechskant, mit Sperr-Rippen unter dem Flansch, oberflächengehärtet

Maße → **TI-28** Anziehmomente → **TI-247**

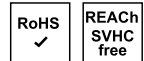

M 5	x	10	S	500	39,00
M 5	x	12	S	500	39,50
M 5	x	16	S	500	40,00
M 5	x	20	S	500	42,00
M 6	x	10	S	500	37,50
M 6	x	12	S	500	38,50
M 6	x	16	S	500	39,00
M 6	x	20	S	500	40,00
M 6	x	25	S	500	44,00
M 6	x	30	S	500	47,50
M 8	x	12	S	200	55,00
M 8	x	16	S	200	55,00
M 8	x	20	S	200	57,00
M 8	x	25	S	200	60,00
M 8	x	30	S	200	63,00
M 8	x	40	S	200	69,00
M 10	x	20	S	200	90,00
M 10	x	25	S	200	91,00
M 10	x	30	S	200	95,00
M 10	x	35	S	100	101,00
M 10	x	40	S	100	105,00
M 12	x	20	S	100	124,00
M 12	x	25	S	100	129,00
M 12	x	30	S	100	135,00
M 12	x	35	S	100	143,00
M 12	x	40	S	100	152,00
M 12	x	45	S	100	160,00
M 12	x	50	S	100	165,00

Abmessungen VE Stück €/100/Obf.

Artikel	88912.110
88912	100 RIPP galvanisch verzinkt

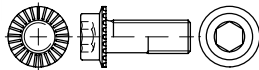

Zylinder-Flanschschrauben mit Innensechskant, mit Sperr-Rippen unter dem Flansch, oberflächengehärtet

Achtung! Warneinblender zu Wasserstoffversprödung beachten.

Maße → **TI-28** Anziehmomente → **TI-247**
Korrosionsschutz → **TI-228**

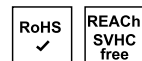

M 6	x	10	S	500	43,00 gal Zn
M 6	x	12	S	500	43,00 gal Zn
M 6	x	16	S	500	43,50 gal Zn
M 6	x	20	S	500	45,00 gal Zn
M 8	x	12	S	200	62,00 gal Zn
M 8	x	16	S	200	63,00 gal Zn
M 8	x	20	S	200	65,00 gal Zn
M 8	x	25	S	200	69,00 gal Zn
M 10	x	20	S	200	103,00 gal Zn
M 10	x	25	S	200	105,00 gal Zn
M 10	x	30	S	200	110,00 gal Zn
M 12	x	30	S	100	157,00 gal Zn
M 12	x	40	S	100	175,00 gal Zn
M 12	x	45	S	100	186,00 gal Zn
M 12	x	50	S	100	195,00 gal Zn

Wichtiger Hinweis!

Bei galvanischen Überzügen auf hochfesten und federharten Teilen ($\geq 1000 \text{ N/mm}^2$ oder $\geq 320 \text{ HV}$) ist die Gefahr einer Wasserstoffversprödung (Sprödbruchgefahr) nicht mit Sicherheit auszuschließen (ISO 4042). Durch eine rechtzeitig eingeleitete thermische Nachbehandlung (Tempern) kann die Gefahr eines wasserstoffinduzierten Sprödbruchs im Regelfall verringert werden. Da aber ein Restrisiko nicht mit Sicherheit auszuschließen ist, erfolgen galvanische Überzüge auf derartigen Teilen nur auf ausdrücklichen Wunsch und auf Risiko des Auftraggebers.



Abmessungen VE Stück €/100/Obf.

Artikel	88912.191
88912	100 RIPP fiZn/TL480h

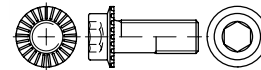

Zylinder-Flanschschrauben mit Innensechskant, mit Sperr-Rippen unter dem Flansch, oberflächengehärtet

TL = Schmierstoff im Topcoat mit $\mu = 0,09 - 0,14$, Korrosionsbeständigkeit NSS: 480h RR, Chrom(VI)-frei

Maße → **TI-28** Anziehmomente → **TI-247**
Korrosionsschutz → **TI-230**

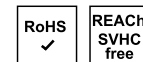

M 6	x	12	S	500	41,00 fiZn
M 6	x	16	S	500	41,50 fiZn
M 6	x	20	S	500	43,00 fiZn
M 8	x	12	S	200	59,00 fiZn
M 8	x	16	S	200	60,00 fiZn
M 8	x	20	S	200	62,00 fiZn
M 8	x	25	S	200	66,00 fiZn
M 10	x	20	S	200	98,00 fiZn
M 10	x	25	S	200	100,00 fiZn
M 10	x	30	S	200	105,00 fiZn
M 12	x	30	S	100	149,00 fiZn
M 12	x	40	S	100	166,00 fiZn
M 12	x	45	S	100	176,00 fiZn
M 12	x	50	S	100	186,00 fiZn

Artikel 88913.100

88913	100 RIPP
--------------	------------------------

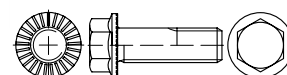

Sechskant-Flanschschrauben mit Sperr-Rippen unter dem Flansch, mit Gewinde bis Kopf, oberflächengehärtet

Maße → **TI-28** Anziehmomente → **TI-247**

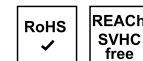

M 5	x	10	S	500	26,00
M 5	x	12	S	500	26,50
M 5	x	16	S	500	26,50
M 5	x	20	S	500	30,00
M 6	x	10	S	500	25,50
M 6	x	12	S	500	25,50
M 6	x	14	S	500	26,00
M 6	x	16	S	500	26,00
M 6	x	20	S	500	27,00
M 6	x	25	S	500	29,50
M 8	x	12	S	200	37,00
M 8	x	16	S	200	37,00
M 8	x	20	S	200	37,50
M 8	x	25	S	200	40,00

Abmessungen	VE	Stück	€/100/Obf.
M 8 x 30	S	200	42,00
M 8 x 35	S	200	47,50
M 8 x 40	S	200	47,50
M 10 x 16	S	200	59,00
M 10 x 20	S	200	59,00
M 10 x 25	S	200	59,00
M 10 x 30	S	200	62,00
M 10 x 35	S	100	72,00
M 10 x 40	S	100	72,00
M 10 x 45	S	100	79,00
M 10 x 50	S	100	103,00
M 12 x 20	S	100	81,00
M 12 x 25	S	100	85,00
M 12 x 30	S	100	88,00
M 12 x 35	S	100	95,00
M 12 x 40	S	100	99,00
M 12 x 45	S	100	111,00
M 12 x 50	S	100	114,00
M 12 x 55	S	100	212,00
M 12 x 60	S	100	229,00
M 12 x 75	S	50	425,00
M 16 x 25	S	50	240,00
M 16 x 30	S	50	240,00
M 16 x 35	S	50	245,00
M 16 x 40	S	50	255,00
M 16 x 45	S	50	275,00
M 16 x 50	S	50	285,00
M 16 x 55	S	50	345,00
M 16 x 60	S	50	355,00
M 16 x 65	S	50	820,00
M 16 x 70	S	50	385,00

Artikel 88913.105

88913 100 RIPP-Fein

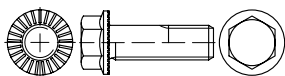

Sechskant-Flanschschrauben mit Sperr-Rippen unter dem Flansch, mit metrischem Feingew. bis Kopf, oberflächengehärtet

Maße → TI-28 Anziehmomente → TI-247

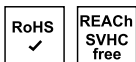

M 14 x 1,5 x 30	S	100	239,00
M 14 x 1,5 x 35	S	100	245,00
M 14 x 1,5 x 40	S	100	260,00
M 14 x 1,5 x 45	S	100	270,00
M 14 x 1,5 x 50	S	100	280,00
M 14 x 1,5 x 55	S	50	300,00
M 14 x 1,5 x 60	S	50	330,00

Abmessungen VE Stück €/100/Obf.

Artikel 88913.110

88913 100 RIPP galvanisch verzinkt

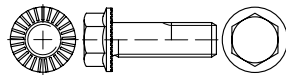

Sechskant-Flanschschrauben mit Sperr-Rippen unter dem Flansch, mit Gewinde bis Kopf, oberflächengehärtet

Achtung! Warneinblender zu Wasserstoffversprödung beachten.

Maße → TI-28 Anziehmomente → TI-247
Korrosionsschutz → TI-228



M 5 x 10	S	500	28,50 gal Zn
M 5 x 12	S	500	28,50 gal Zn
M 5 x 16	S	500	29,00 gal Zn
M 5 x 20	S	500	32,00 gal Zn
M 6 x 10	S	500	29,00 gal Zn
M 6 x 12	S	500	29,50 gal Zn
M 6 x 14	S	500	30,00 gal Zn
M 6 x 16	S	500	30,00 gal Zn
M 6 x 20	S	500	31,50 gal Zn
M 6 x 25	S	500	34,00 gal Zn
M 8 x 12	S	200	43,50 gal Zn
M 8 x 16	S	200	44,50 gal Zn
M 8 x 20	S	200	46,00 gal Zn
M 8 x 25	S	200	48,00 gal Zn
M 8 x 30	S	200	52,00 gal Zn
M 8 x 40	S	200	58,00 gal Zn
M 8 x 50	S	200	63,00 gal Zn
M 10 x 16	S	200	70,00 gal Zn
M 10 x 20	S	200	72,00 gal Zn
M 10 x 25	S	200	73,00 gal Zn
M 10 x 30	S	200	78,00 gal Zn
M 10 x 35	S	100	89,00 gal Zn
M 10 x 40	S	100	90,00 gal Zn
M 10 x 50	S	100	121,00 gal Zn
M 12 x 20	S	100	100,00 gal Zn
M 12 x 25	S	100	107,00 gal Zn
M 12 x 30	S	100	110,00 gal Zn
M 12 x 35	S	100	118,00 gal Zn
M 12 x 40	S	100	125,00 gal Zn
M 12 x 45	S	100	137,00 gal Zn
M 12 x 50	S	100	142,00 gal Zn
M 12 x 60	S	100	265,00 gal Zn
M 12 x 75	S	50	470,00 gal Zn

Wichtiger Hinweis!

Bei galvanischen Überzügen auf hochfesten und federharten Teilen ($\geq 1000 \text{ N/mm}^2$ oder $\geq 320 \text{ HV}$) ist die Gefahr einer Wasserstoffversprödung (Sprödbruchgefahr) nicht mit Sicherheit auszuschließen (ISO 4042). Durch eine rechtzeitig eingeleitete thermische Nachbehandlung (Tempern) kann die Gefahr eines wasserstoffinduzierten Sprödbruches im Regelfall verringert werden. Da aber ein Restrisiko nicht mit Sicherheit auszuschließen ist, erfolgen galvanische Überzüge auf derartigen Teilen nur auf ausdrücklichen Wunsch und auf Risiko des Auftraggebers.



Abmessungen VE Stück €/100/Obf.

M 16 x 25	S	50	290,00 gal Zn
M 16 x 35	S	50	300,00 gal Zn
M 16 x 40	S	50	310,00 gal Zn
M 16 x 45	S	50	340,00 gal Zn
M 16 x 50	S	50	350,00 gal Zn
M 16 x 55	S	50	410,00 gal Zn
M 16 x 60	S	50	430,00 gal Zn
M 16 x 70	S	50	460,00 gal Zn

Artikel 88913.115

88913 100 RIPP-Fein galvanisch verzinkt

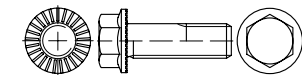

Sechskant-Flanschschrauben mit Sperr-Rippen unter dem Flansch, mit metrischem Feingew. bis Kopf, oberflächengehärtet

Achtung! Warneinblender zu Wasserstoffversprödung beachten.

Maße → TI-28 Anziehmomente → TI-247
Korrosionsschutz → TI-228

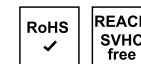

M 14 x 1,5 x 30	S	100	265,00 gal Zn
M 14 x 1,5 x 35	S	100	275,00 gal Zn
M 14 x 1,5 x 40	S	100	285,00 gal Zn
M 14 x 1,5 x 45	S	100	300,00 gal Zn
M 14 x 1,5 x 50	S	100	315,00 gal Zn
M 14 x 1,5 x 60	S	100	375,00 gal Zn

Abmessungen VE Stück €/100/Obf.

Artikel	88913.191	
88913	100	RIPP
	fiZn/TL480h	

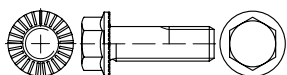

Sechskant-Flanschschrauben mit Sperr-Rippen unter dem Flansch, mit Gewinde bis Kopf, oberflächengehärtet

TL = Schmierstoff im Topcoat mit $\mu = 0,09 - 0,14$, Korrosionsbeständigkeit NSS: 480h RR, Chrom(VI)-frei

Maße → **TI-28** Anziehmomente → **TI-247**
Korrosionsschutz → **TI-230**



M 5	x	10	S	500	27,50 flZn
M 5	x	12	S	500	27,00 flZn
M 5	x	16	S	500	27,50 flZn
M 5	x	20	S	500	30,50 flZn
M 6	x	10	S	500	27,50 flZn
M 6	x	12	S	500	28,00 flZn
M 6	x	14	S	500	28,50 flZn
M 6	x	16	S	500	29,00 flZn
M 6	x	20	S	500	30,00 flZn
M 6	x	25	S	500	32,50 flZn
M 8	x	12	S	200	41,50 flZn
M 8	x	16	S	200	42,00 flZn
M 8	x	20	S	200	43,50 flZn
M 8	x	25	S	200	46,00 flZn
M 8	x	30	S	200	49,50 flZn
M 8	x	40	S	200	55,00 flZn
M 8	x	45	S	200	60,00 flZn
M 10	x	16	S	200	67,00 flZn
M 10	x	20	S	200	68,00 flZn
M 10	x	25	S	200	69,00 flZn
M 10	x	30	S	200	74,00 flZn
M 10	x	35	S	100	84,00 flZn
M 10	x	40	S	100	86,00 flZn
M 10	x	50	S	100	115,00 flZn
M 12	x	20	S	100	95,00 flZn
M 12	x	25	S	100	104,00 flZn
M 12	x	30	S	100	106,00 flZn
M 12	x	35	S	100	114,00 flZn
M 12	x	40	S	100	121,00 flZn
M 12	x	45	S	100	133,00 flZn
M 12	x	50	S	100	138,00 flZn
M 12	x	60	S	100	255,00 flZn
M 12	x	75	S	50	455,00 flZn
M 16	x	25	S	50	285,00 flZn
M 16	x	30	S	50	285,00 flZn
M 16	x	35	S	50	290,00 flZn
M 16	x	40	S	50	300,00 flZn
M 16	x	45	S	50	330,00 flZn
M 16	x	50	S	50	340,00 flZn
M 16	x	55	S	50	395,00 flZn
M 16	x	60	S	50	415,00 flZn
M 16	x	70	S	50	445,00 flZn

Abmessungen VE Stück €/100/Obf.

Artikel	88913.192	
88913	100	RIPP-Fein
	fiZn/TL480h	

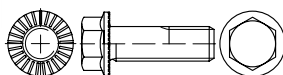

Sechskant-Flanschschrauben mit Sperr-Rippen unter dem Flansch, mit metrischem Feingew. bis Kopf, oberflächengehärtet

TL = Schmierstoff im Topcoat mit $\mu = 0,09 - 0,14$, Korrosionsbeständigkeit NSS: 480h RR, Chrom(VI)-frei

Maße → **TI-28** Anziehmomente → **TI-247**
Korrosionsschutz → **TI-230**



M 14	x	1,5	x	30	S	100	255,00 flZn
M 14	x	1,5	x	35	S	100	265,00 flZn
M 14	x	1,5	x	40	S	100	280,00 flZn
M 14	x	1,5	x	45	S	100	290,00 flZn
M 14	x	1,5	x	50	S	100	305,00 flZn
M 14	x	1,5	x	60	S	100	365,00 flZn

Artikel	88914.100	
88914	10	RIPP

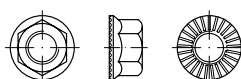

Sechskant-Flanschmuttern mit Sperr-Rippen unter dem Flansch, oberflächengehärtet

Maße → **TI-70** Anziehmomente → **TI-247**

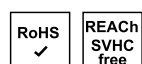

M 5	S	500	18,00
M 6	S	500	20,10
M 8	S	200	27,50
M 10	S	200	35,50
M 12	S	100	59,00
M 16	S	50	101,00

Abmessungen VE Stück €/100/Obf.

Artikel	88914.110	
88914	10	RIPP
	galvanisch verzinkt	

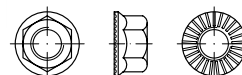

Sechskant-Flanschmuttern mit Sperr-Rippen unter dem Flansch, oberflächengehärtet

Maße → **TI-70** Anziehmomente → **TI-247**
Korrosionsschutz → **TI-228**



M 5	S	500	19,20 gal Zn
M 6	S	500	22,70 gal Zn
M 8	S	200	33,00 gal Zn
M 10	S	200	43,50 gal Zn
M 12	S	100	71,00 gal Zn
M 16	S	50	124,00 gal Zn

Artikel	88914.105	
88914	10	RIPP-Fein

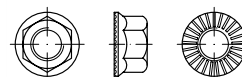

Sechskant-Flanschmuttern mit Sperr-Rippen unter dem Flansch, mit metrischem Feingewinde, oberflächengehärtet

Maße → **TI-70** Anziehmomente → **TI-247**



M 14	x	1,5	S	100	470,00
------	---	-----	---	-----	--------

Artikel	88914.115	
88914	10	RIPP-Fein
	galvanisch verzinkt	

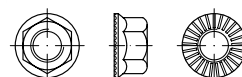

Sechskant-Flanschmuttern mit Sperr-Rippen unter dem Flansch, mit metrischem Feingewinde, oberflächengehärtet

Maße → **TI-70** Anziehmomente → **TI-247**
Korrosionsschutz → **TI-228**



M 14	x	1,5	S	100	510,00 gal Zn
------	---	-----	---	-----	---------------

Abmessungen	VE Stück	€/100/Obf.
Artikel	88914.170	
88914	10	RIPP
fiZn/TL480h		

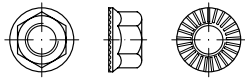

Sechskant-Flanschnuttern mit Sperr-Rippen unter dem Flansch, oberflächengehärtet

TL = Schmierstoff im Topcoat mit $\mu = 0,09 - 0,14$, Korrosionsbeständigkeit NSS: 480h RR, Chrom(VI)-frei

Maße → **TI-70** Anziehmomente → **TI-247**
Korrosionsschutz → **TI-230**

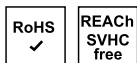

M 5	S	500	18,20 fiZn
M 6	S	500	21,20 fiZn
M 8	S	200	30,00 fiZn
M 10	S	200	39,50 fiZn
M 12	S	100	67,00 fiZn
M 16	S	50	115,00 fiZn

Artikel	88914.145
88914	10
fiZn/TL480h	
RIPP-Fein	

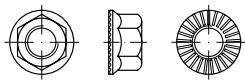

Sechskant-Flanschnuttern mit Sperr-Rippen unter dem Flansch, mit metrischem Feingewinde, oberflächengehärtet

TL = Schmierstoff im Topcoat mit $\mu = 0,09 - 0,14$, Korrosionsbeständigkeit NSS: 480h RR, Chrom(VI)-frei

Maße → **TI-70** Anziehmomente → **TI-247**
Korrosionsschutz → **TI-230**

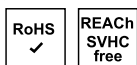

M 14	x	1,5	S	100	455,00 fiZn
------	---	-----	---	-----	-------------

Abmessungen	VE Stück	€/100/Obf.
Artikel	88933.*	
88933	90/100*	Sperrzahn

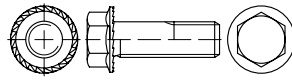

Sechskant-Flanschschrauben mit Sperrzähnen unter dem Flansch, mit Gewinde bis zum Kopf, oberflächengehärtet

*Festigkeitsklasse $90 \leq M 10$ (*800),
*Festigkeitsklasse $100 \geq M 12$ (*100)

Maße → **TI-28** Anziehmomente → **TI-245**

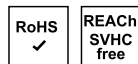

M 5	x	8	S	500	20,40
M 5	x	10	S	500	20,40
M 5	x	12	S	500	21,00
M 5	x	14	S	500	21,30
M 5	x	16	S	500	21,30
M 5	x	20	S	500	24,10
M 6	x	10	S	500	19,30
M 6	x	12	S	500	19,30
M 6	x	14	S	500	20,40
M 6	x	16	S	500	20,40
M 6	x	18	S	500	21,20
M 6	x	20	S	500	21,20
M 6	x	25	S	500	24,80
M 6	x	30	S	500	29,00
M 8	x	12	S	200	29,00
M 8	x	14	S	200	30,50
M 8	x	16	S	200	30,50
M 8	x	18	S	200	32,00
M 8	x	20	S	200	32,00
M 8	x	25	S	200	34,50
M 8	x	30	S	200	39,00
M 8	x	35	S	200	40,50
M 8	x	40	S	200	46,00
M 10	x	16	S	200	48,50
M 10	x	20	S	200	49,50
M 10	x	22	S	200	53,00
M 10	x	25	S	200	53,00
M 10	x	30	S	200	56,00
M 10	x	35	S	100	63,00
M 10	x	40	S	100	66,00
M 12	x	20	S	100	74,00
M 12	x	25	S	100	77,00
M 12	x	30	S	100	79,00
M 12	x	35	S	100	85,00
M 12	x	40	S	100	92,00
M 12	x	45	S	100	101,00
M 12	x	50	S	100	108,00
M 16	x	25	S	50	234,00
M 16	x	30	S	50	234,00
M 16	x	35	S	50	240,00
M 16	x	40	S	50	249,00
M 16	x	45	S	50	270,00
M 16	x	50	S	50	275,00
M 16	x	55	S	50	340,00
M 16	x	60	S	50	350,00
M 16	x	70	S	50	375,00

Abmessungen	VE Stück	€/100/Obf.
Artikel	88933.*	
88933	90/100*	Sperrzahn
galvanisch verzinkt		

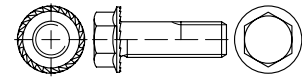

Sechskant-Flanschschrauben mit Sperrzähnen unter dem Flansch, mit Gewinde bis zum Kopf, oberflächengehärtet

*Festigkeitsklasse $90 \leq M 10$ (*810),
*Festigkeitsklasse $100 \geq M 12$ (*110)

Achtung! Warneinblender zu Wasserstoffversprödung beachten.

Maße → **TI-28** Anziehmomente → **TI-245**
Korrosionsschutz → **TI-228**

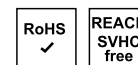

M 5	x	8	S	500	22,50 gal Zn
M 5	x	10	S	500	22,60 gal Zn
M 5	x	12	S	500	23,70 gal Zn
M 5	x	14	S	500	24,10 gal Zn
M 5	x	16	S	500	24,10 gal Zn
M 5	x	20	S	500	27,50 gal Zn
M 6	x	10	S	500	21,60 gal Zn
M 6	x	12	S	500	21,70 gal Zn
M 6	x	16	S	500	23,00 gal Zn
M 6	x	20	S	500	24,10 gal Zn
M 6	x	25	S	500	28,00 gal Zn
M 8	x	12	S	200	33,50 gal Zn
M 8	x	16	S	200	35,50 gal Zn
M 8	x	20	S	200	37,50 gal Zn
M 8	x	25	S	200	41,00 gal Zn
M 8	x	30	S	200	45,50 gal Zn
M 10	x	16	S	200	56,00 gal Zn
M 10	x	20	S	200	59,00 gal Zn
M 10	x	25	S	200	63,00 gal Zn
M 10	x	30	S	200	68,00 gal Zn
M 12	x	20	S	100	94,00 gal Zn
M 12	x	25	S	100	97,00 gal Zn
M 12	x	30	S	100	100,00 gal Zn
M 12	x	35	S	100	111,00 gal Zn
M 12	x	40	S	100	116,00 gal Zn
M 12	x	45	S	100	128,00 gal Zn
M 12	x	50	S	100	137,00 gal Zn
M 16	x	25	S	50	275,00 gal Zn
M 16	x	30	S	50	280,00 gal Zn
M 16	x	35	S	50	285,00 gal Zn
M 16	x	40	S	50	300,00 gal Zn

Abmessungen	VE Stück	€/100/Obf.
Artikel	88933.(*)	
88933	90/100*	Sperrzahn
	fiZn/TL480h	

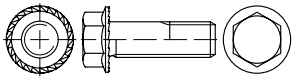

Sechskant-Flanschsrauben mit Sperrzähnen unter dem Flansch, mit Gewinde bis zum Kopf, oberflächengehärtet

TL = Schmierstoff im Topcoat mit $\mu = 0,09 - 0,14$, Korrosionsbeständigkeit NSS: 480h RR, Chrom(VI)-frei,
*Festigkeitsklasse 90 \leq M 10 (*891),
*Festigkeitsklasse 100 \geq M 12 (*191)

Maße \rightarrow TI-28 Anziehmomente \rightarrow TI-245
Korrosionsschutz \rightarrow TI-230

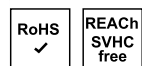

M 5	x	8	S	500	21,80 flZn
M 5	x	10	S	500	22,00 flZn
M 5	x	16	S	500	23,40 flZn
M 5	x	20	S	500	26,50 flZn
M 6	x	10	S	500	21,00 flZn
M 6	x	12	S	500	21,10 flZn
M 6	x	16	S	500	22,30 flZn
M 6	x	20	S	500	23,40 flZn
M 6	x	25	S	500	27,50 flZn
M 8	x	12	S	200	33,00 flZn
M 8	x	16	S	200	34,50 flZn
M 8	x	20	S	200	36,50 flZn
M 8	x	25	S	200	40,00 flZn
M 8	x	30	S	200	44,50 flZn
M 10	x	16	S	200	54,00 flZn
M 10	x	20	S	200	58,00 flZn
M 10	x	25	S	200	61,00 flZn
M 10	x	30	S	200	66,00 flZn
M 12	x	20	S	100	91,00 flZn
M 12	x	25	S	100	94,00 flZn
M 12	x	30	S	100	97,00 flZn
M 12	x	35	S	100	108,00 flZn
M 12	x	40	S	100	113,00 flZn
M 12	x	45	S	100	124,00 flZn
M 12	x	50	S	100	133,00 flZn
M 16	x	25	S	50	265,00 flZn
M 16	x	30	S	50	270,00 flZn
M 16	x	35	S	50	280,00 flZn
M 16	x	40	S	50	290,00 flZn

Abmessungen	VE Stück	€/100/Obf.
Artikel	88934.(*)	
88934	8/10*	Sperrzahn

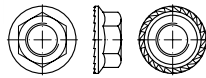

Sechskant-Flanschnuttern mit Sperrzähnen unter dem Flansch, oberflächengehärtet

*Festigkeitsklasse 8 \leq M 10 (*800),
*Festigkeitsklasse 10 \geq M 12 (*100)

Maße \rightarrow TI-70 Anziehmomente \rightarrow TI-245

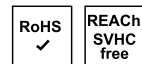

M 5	S	500	15,10
M 6	S	500	15,50
M 8	S	200	22,10
M 10	S	200	28,50
M 12	S	100	53,00
M 16	S	50	93,00

Artikel	88934.(*)
88934	8/10*
	Sperrzahn
	galvanisch verzinkt

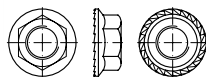

Sechskant-Flanschnuttern mit Sperrzähnen unter dem Flansch, oberflächengehärtet

*Festigkeitsklasse 8 \leq M 10 (*810),
*Festigkeitsklasse 10 \geq M 12 (*110)

Maße \rightarrow TI-70 Anziehmomente \rightarrow TI-245
Korrosionsschutz \rightarrow TI-228



M 5	S	500	15,70 gal Zn
M 6	S	500	17,10 gal Zn
M 8	S	200	25,50 gal Zn
M 10	S	200	36,00 gal Zn
M 12	S	100	54,00 gal Zn
M 16	S	50	113,00 gal Zn

Abmessungen	VE Stück	€/100/Obf.
Artikel	88934.(*)	
88934	8/10*	Sperrzahn
	fiZn/TL480h	

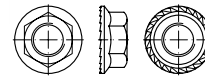

Sechskant-Flanschnuttern mit Sperrzähnen unter dem Flansch, oberflächengehärtet

TL = Schmierstoff im Topcoat mit $\mu = 0,09 - 0,14$, Korrosionsbeständigkeit NSS: 480h RR, Chrom(VI)-frei,
*Festigkeitsklasse 8 \leq M 10 (*850),
*Festigkeitsklasse 10 \geq M 12 (*130)

Maße \rightarrow TI-70 Anziehmomente \rightarrow TI-245
Korrosionsschutz \rightarrow TI-230

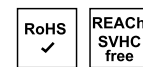

M 5	S	500	14,60 flZn
M 6	S	500	16,40 flZn
M 8	S	200	22,40 flZn
M 10	S	200	32,50 flZn
M 12	S	100	51,00 flZn
M 16	S	50	103,00 flZn

Artikel	88928.410
88928	Mu 4.6
	HS 28/15
	galvanisch verzinkt

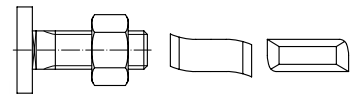

Hammerkopf-/Halben-Schrauben, Mu = mit Sechskantmutter

für Profile 28/15, 28/12, 28/28, 26/26, Kopfformen: Lieferausführung freibleibend, Kopfänge ~22,5 mm

Werkstoffeigensch. \rightarrow TI-232 REACH \rightarrow TI-262
Korrosionsschutz \rightarrow TI-228

Rostfrei \rightarrow S. 606



M 6	x	15	S	100	124,00 gal Zn
M 6	x	20	S	100	128,00 gal Zn
M 6	x	25	S	100	131,00 gal Zn
M 6	x	30	S	100	132,00 gal Zn
M 6	x	40	S	100	136,00 gal Zn
M 8	x	15	S	100	108,00 gal Zn
M 8	x	20	S	100	113,00 gal Zn
M 8	x	25	S	100	114,00 gal Zn
M 8	x	30	S	100	117,00 gal Zn
M 8	x	40	S	100	124,00 gal Zn
M 8	x	50	S	100	132,00 gal Zn
M 8	x	60	S	100	152,00 gal Zn
M 8	x	80	S	100	265,00 gal Zn
M 8	x	100	S	100	335,00 gal Zn
M 10	x	15	S	100	141,00 gal Zn
M 10	x	20	S	100	144,00 gal Zn
M 10	x	25	S	100	148,00 gal Zn
M 10	x	30	S	100	152,00 gal Zn



- ✓ Große Artikelvielfalt
- ✓ Verlässliche Qualität
- ✓ Hohe Lieferbereitschaft

Abmessungen	VE	Stück	€/100/Obf.
M 10 x 40	S	100	163,00 gal Zn
M 10 x 50	S	100	193,00 gal Zn
M 10 x 60	S	100	207,00 gal Zn
M 10 x 80	S	100	270,00 gal Zn
M 10 x 100	S	50	365,00 gal Zn
M 10 x 125	S	50	540,00 gal Zn
M 10 x 150	S	50	660,00 gal Zn
M 12 x 30	S	100	270,00 gal Zn
M 12 x 50	S	50	290,00 gal Zn

Artikel	88938.410
88938	Mu 4.6 HS 38/17 galvanisch verzinkt

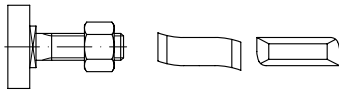

Hammerkopf-/Halben-Schrauben, Mu = mit Sechskantmutter

für Profile 38/17, 36/20, 36/36, 35/50, Kopfformen: Lieferausführung freibleibend, Kopflänge ~30,5 mm

Werkstoffeigensch. → **TI-232** REACH → **TI-262**
Korrosionsschutz → **TI-228**

Rostfrei → **S. 606**



M 10 x 20	S	100	227,00 gal Zn
M 10 x 30	S	100	232,00 gal Zn
M 10 x 40	S	100	244,00 gal Zn
M 10 x 50	S	100	260,00 gal Zn
M 10 x 60	S	100	270,00 gal Zn
M 10 x 80	S	50	300,00 gal Zn
M 10 x 100	S	50	380,00 gal Zn
M 10 x 150	S	50	650,00 gal Zn
M 12 x 20	S	100	234,00 gal Zn
M 12 x 30	S	100	249,00 gal Zn
M 12 x 40	S	50	265,00 gal Zn
M 12 x 50	S	50	270,00 gal Zn
M 12 x 60	S	50	285,00 gal Zn
M 12 x 80	S	50	315,00 gal Zn
M 12 x 100	S	50	440,00 gal Zn
M 16 x 30	S	50	325,00 gal Zn
M 16 x 40	S	50	340,00 gal Zn
M 16 x 50	S	50	365,00 gal Zn
M 16 x 60	S	50	385,00 gal Zn
M 16 x 80	S	25	425,00 gal Zn
M 16 x 100	S	25	540,00 gal Zn
M 16 x 125	S	25	760,00 gal Zn
M 16 x 150	S	25	890,00 gal Zn
M 16 x 200	S	25	1320,00 gal Zn

Abmessungen	VE	Stück	€/100/Obf.
Artikel	88940.410		
88940	Mu 4.6 HS 40/22 galvanisch verzinkt		

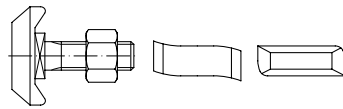

Hammerkopf-/Halben-Schrauben Mu = mit Sechskantmutter

für Profile 40/22, 40/25, 422, Kopfformen: Lieferausführung freibleibend, Kopflänge ~32,5 mm

Werkstoffeigensch. → **TI-232** REACH → **TI-262**
Korrosionsschutz → **TI-228**

Rostfrei → **S. 606**



M 10 x 20	S	100	255,00 gal Zn
M 10 x 30	S	100	270,00 gal Zn
M 10 x 40	S	100	275,00 gal Zn
M 10 x 60	S	100	310,00 gal Zn
M 10 x 80	S	50	590,00 gal Zn
M 10 x 100	S	50	630,00 gal Zn
M 12 x 20	S	100	275,00 gal Zn
M 12 x 30	S	100	285,00 gal Zn
M 12 x 40	S	50	310,00 gal Zn
M 12 x 50	S	50	335,00 gal Zn
M 12 x 60	S	50	365,00 gal Zn
M 12 x 80	S	50	420,00 gal Zn
M 12 x 100	S	50	485,00 gal Zn
M 12 x 125	S	50	630,00 gal Zn
M 12 x 150	S	50	790,00 gal Zn
M 12 x 200	S	25	880,00 gal Zn
M 16 x 30	S	50	380,00 gal Zn
M 16 x 40	S	50	395,00 gal Zn
M 16 x 50	S	50	420,00 gal Zn
M 16 x 60	S	25	440,00 gal Zn
M 16 x 80	S	25	510,00 gal Zn
M 16 x 100	S	25	610,00 gal Zn
M 16 x 125	S	25	790,00 gal Zn
M 16 x 150	S	25	940,00 gal Zn
M 16 x 200	S	25	1170,00 gal Zn

Abmessungen	VE	Stück	€/100/Obf.
Artikel	88941.820		
88941	Mu 8.8 HZS 41/22 feuerverzinkt		

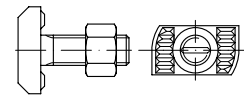

Hammerkopf-/Halben-Schrauben Mu = mit Sechskantmutter

für Profile HZA/HZM 41/22, Kopflänge ~34,5 mm

Werkstoffeigensch. → **TI-232** Korrosionsschutz → **TI-231**

Rostfrei → **S. 606**

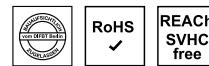

M 12 x 35	S	100	670,00 tZn
M 12 x 50	S	100	730,00 tZn
M 16 x 50	S	25	1120,00 tZn
M 16 x 100	S	25	1670,00 tZn

Artikel	88943.810
88943	Mu 8.8 HZS 38/23 galvanisch verzinkt

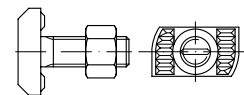

Hammerkopf-/Halben-Schrauben, Mu = mit Sechskantmutter

für Profil 38/23 DYNAGRIP, Kopflänge ~28,8 mm

Werkstoffeigensch. → **TI-232** Korrosionsschutz → **TI-228**

Rostfrei → **S. 606**

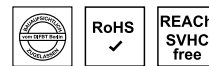

M 16 x 80	S	25	990,00 gal Zn
M 16 x 100	S	25	1050,00 gal Zn
M 16 x 125	S	25	1390,00 gal Zn
M 16 x 150	S	25	2650,00 gal Zn



Wir versorgen Sie mit Verbindungselementen und Befestigungstechnik!

Abmessungen VE Stück €/100/Obf.

Artikel	88943.820	
88943	Mu 8.8	HZS 38/23
	feuerverzinkt	

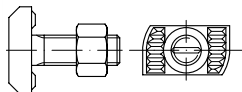

Hammerkopf-/Halben-Schrauben, Mu = mit Sechskantmutter

für Profil 38/23 DYNAGRIP, Kopflänge ~28,8 mm

Achtung! Infoeinblender beachten.

Werkstoffeigensch. → **TI-232** Korrosionsschutz → **TI-231**

Rostfrei → **S. 606**

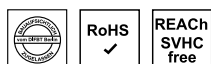

M 16	x	60	S	25	900,00 tZn
------	---	----	---	----	------------

Artikel	88944.810	
88944	Mu 8.8	HZS 53/34
	galvanisch verzinkt	

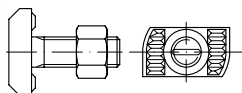

Hammerkopf-/Halben-Schrauben, Mu = mit Sechskantmutter

für Profil HZA 53/34, Kopflänge ~41,6 mm

Werkstoffeigensch. → **TI-232** Korrosionsschutz → **TI-228**

Rostfrei → **S. 606**

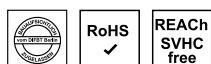

M 16	x	60	S	25	2470,00 gal Zn
M 16	x	100	S	25	2600,00 gal Zn
M 20	x	65	S	25	2850,00 gal Zn
M 20	x	100	S	25	3050,00 gal Zn

Abmessungen VE Stück €/100/Obf.

Artikel	88950.410	
88950	Mu 4.6	HS 50/30
	galvanisch verzinkt	

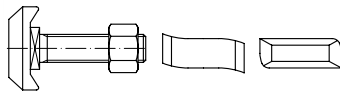

Hammerkopf-/Halben-Schrauben Mu = mit Sechskantmutter

für Profile 50/30, 50/40, 49/30, 52/34, 54/33, 486, Kopfformen: Lieferausführung freibleibend, Kopflänge ~41 mm

Werkstoffeigensch. → **TI-232** REACH → **TI-262**

Korrosionsschutz → **TI-228**

Rostfrei → **S. 607**



M 10	x	30	S	100	430,00 gal Zn
M 10	x	40	S	100	440,00 gal Zn
M 10	x	50	S	100	445,00 gal Zn
M 12	x	30	S	100	385,00 gal Zn
M 12	x	40	S	50	395,00 gal Zn
M 12	x	50	S	50	415,00 gal Zn
M 12	x	60	S	50	430,00 gal Zn
M 12	x	80	S	50	495,00 gal Zn
M 12	x	100	S	50	600,00 gal Zn
M 12	x	125	S	50	860,00 gal Zn
M 16	x	30	S	50	460,00 gal Zn
M 16	x	40	S	50	480,00 gal Zn
M 16	x	50	S	50	510,00 gal Zn
M 16	x	60	S	25	530,00 gal Zn
M 16	x	80	S	25	590,00 gal Zn
M 16	x	100	S	25	720,00 gal Zn
M 16	x	125	S	25	890,00 gal Zn
M 16	x	150	S	25	1010,00 gal Zn
M 16	x	200	S	25	1280,00 gal Zn
M 16	x	300	S	25	1640,00 gal Zn
M 20	x	45	S	25	620,00 gal Zn
M 20	x	55	S	25	670,00 gal Zn
M 20	x	65	S	25	720,00 gal Zn
M 20	x	75	S	25	760,00 gal Zn
M 20	x	100	S	25	860,00 gal Zn
M 20	x	125	S	25	1060,00 gal Zn

Artikel	88972.420	
88972	Mu 4.6	HS 72/48
	feuerverzinkt	

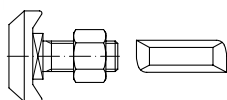

Hammerkopf-/Halben-Schrauben Mu = mit Sechskantmutter

für Profile 72/48, 72/49, Kopflänge ~58 mm

Werkstoffeigensch. → **TI-232** REACH → **TI-262**

Korrosionsschutz → **TI-231**



M 20	x	50	S	20	1260,00 tZn
M 20	x	75	S	20	1360,00 tZn

Abmessungen VE Stück €/100/Obf.

M 20	x	100	S	15	1550,00 tZn
M 24	x	75	S	15	1320,00 tZn
M 24	x	100	S	10	1480,00 tZn

Artikel	88951.010	
88951	Stahl	Typ 28/15
	galvanisch verzinkt	

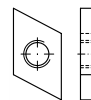

Hammerkopf-Gewindeplatten (Gleitmutter)

für Profile 28/15, 28/12, 28/28, 26/26, 26/18

Maße → **TI-79**

Korrosionsschutz → **TI-228**



M 6	S	100	78,00 gal Zn
M 8	S	100	78,00 gal Zn
M 10	S	100	157,00 gal Zn

Artikel	88952.010	
88952	Stahl	Typ 38/17
	galvanisch verzinkt	

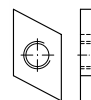

Hammerkopf-Gewindeplatten (Gleitmutter)

für Profile 38/17, 36/20, 35/50, 36/36

Maße → **TI-80**

Korrosionsschutz → **TI-228**



M 6	S	100	157,00 gal Zn
M 8	S	100	157,00 gal Zn
M 10	S	100	157,00 gal Zn
M 12	S	100	157,00 gal Zn

Abmessungen	VE Stück	€/100/Obf.
Artikel	88953.010	
88953	Stahl	Typ 50/40
	galvanisch verzinkt	

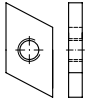

Hammerkopf-Gewindeplatten (Gleitmuttern)

für Profile 50/40, 486

Maße → **TI-80**

Korrosionsschutz → **TI-228**

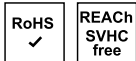

M 6	S	100	157,00 gal Zn
M 8	S	100	194,00 gal Zn
M 10	S	100	194,00 gal Zn
M 12	S	100	194,00 gal Zn
M 16	S	100	194,00 gal Zn

Artikel	88954.010
88954	Stahl
	Typ 40/22
	galvanisch verzinkt



Hakenkopf-Gewindeplatten (Gleitmuttern)

für Profile 40/22, 40/25

Maße → **TI-80**

Korrosionsschutz → **TI-228**



M 5	S	100	340,00 gal Zn
M 6	S	100	340,00 gal Zn
M 8	S	100	340,00 gal Zn
M 10	S	100	340,00 gal Zn
M 12	S	100	385,00 gal Zn

Abmessungen	VE Stück	€/100/Obf.
Artikel	88955.010	
88955	Stahl	Typ 50/30
	galvanisch verzinkt	



Hakenkopf-Gewindeplatten (Gleitmuttern)

für Profile 50/30, 50/40, 52/34, 54/33, 49/30

Maße → **TI-80**

Korrosionsschutz → **TI-228**

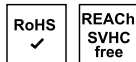

M 8	S	50	430,00 gal Zn
M 10	S	50	430,00 gal Zn
M 12	S	50	430,00 gal Zn
M 16	S	50	460,00 gal Zn

Artikel	87010.011
87010	Stahl
	galvanisch verzinkt

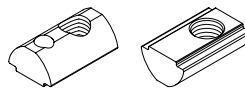

Muttern für T-Nuten, Profil 5 mm, mit Führungssteg, Fixierhilfe: Kugel

Produktinformation → **TI-154**



für Profil, Gewinde M

5 mm, M 4	S	1000	67,00 gal Zn
5 mm, M 4	K	100	86,00 gal Zn
5 mm, M 5	S	1000	71,00 gal Zn
5 mm, M 5	K	100	91,00 gal Zn

Artikel	87010.012
87010	Stahl
	galvanisch verzinkt

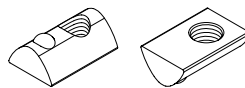

Muttern für T-Nuten, Profil 5 mm, ohne Führungssteg, Fixierhilfe: Kugel

Produktinformation → **TI-154**



für Profil, Gewinde M

5 mm, M 4	S	1000	65,00 gal Zn
5 mm, M 4	K	100	83,00 gal Zn
5 mm, M 5	S	1000	68,00 gal Zn
5 mm, M 5	K	100	88,00 gal Zn

Abmessungen	VE Stück	€/100/Obf.
Artikel	87011.013	
87011	Stahl	
	galvanisch verzinkt	

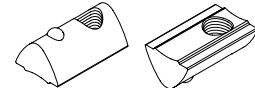

Muttern für T-Nuten, Profil 6 mm, mit außenliegendem Führungssteg, Fixierhilfe: Kugel

Produktinformation → **TI-154**

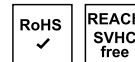

für Profil, Gewinde M

6 mm, M 5	S	1000	71,00 gal Zn
6 mm, M 5	K	100	91,00 gal Zn
6 mm, M 6	S	1000	74,00 gal Zn
6 mm, M 6	K	100	96,00 gal Zn

Artikel	87012.011
87012	Stahl
	galvanisch verzinkt

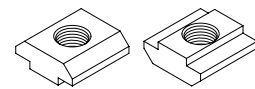

Muttern für T-Nuten, Profil 8 mm, mit Führungssteg

Produktinformation → **TI-154**

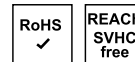

für Profil, Gewinde M

8 mm, M 6	S	1000	82,00 gal Zn
8 mm, M 6	K	100	106,00 gal Zn
8 mm, M 8	S	1000	86,00 gal Zn
8 mm, M 8	K	100	112,00 gal Zn

Artikel	87012.015
87012	Stahl
	galvanisch verzinkt

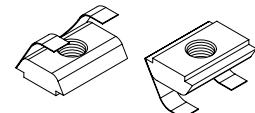

Muttern für T-Nuten, Profil 8 mm, mit Führungssteg, ohne Potentialausgleich, Fixierhilfe: Feder

Produktinformation → **TI-154**

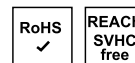

für Profil, Gewinde M

8 mm, M 6	S	1000	91,00 gal Zn
8 mm, M 6	K	100	118,00 gal Zn
8 mm, M 8	S	1000	99,00 gal Zn
8 mm, M 8	K	100	128,00 gal Zn

Abmessungen VE Stück €/100/Obf.

Artikel	87012.012
87012	Stahl galvanisch verzinkt

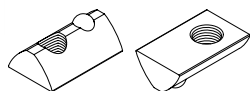

Muttern für T-Nuten, Profil 8 mm, ohne Führungssteg, Fixierhilfe: Kugel

Produktinformation → [TI-154](#)

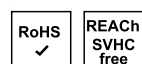

für Profil, Gewinde M

8 mm, M 6	S 1000	74,00 gal Zn
8 mm, M 6	K 100	96,00 gal Zn
8 mm, M 8	S 1000	79,00 gal Zn
8 mm, M 8	K 100	102,00 gal Zn

Artikel	87012.016
87012	Stahl galvanisch verzinkt

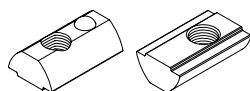

Muttern für T-Nuten, Profil 8 mm, mit Führungssteg, Fixierhilfe: Kugel

Produktinformation → [TI-154](#)



für Profil, Gewinde M

8 mm, M 6	S 1000	78,00 gal Zn
8 mm, M 6	K 100	101,00 gal Zn
8 mm, M 8	S 1000	83,00 gal Zn
8 mm, M 8	K 100	107,00 gal Zn

Artikel	87012.017
87012	Stahl galvanisch verzinkt

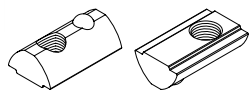

Muttern für T-Nuten, Profil 8 mm, mit Führungssteg, ohne Potentialausgleich, Fixierhilfe: Kugel

Produktinformation → [TI-154](#)

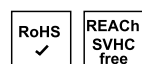

für Profil, Gewinde M

8 mm, M 6	S 1000	86,00 gal Zn
8 mm, M 6	K 100	112,00 gal Zn
8 mm, M 8	S 1000	91,00 gal Zn
8 mm, M 8	K 100	118,00 gal Zn

Abmessungen VE Stück €/100/Obf.

Artikel	87013.011
87013	Stahl galvanisch verzinkt

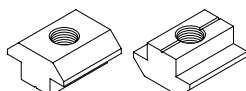

Muttern für T-Nuten, Profil 10 mm, mit Führungssteg

Produktinformation → [TI-154](#)



für Profil, Gewinde M

10 mm, M 6	S 250	76,00 gal Zn
10 mm, M 6	K 100	97,00 gal Zn
10 mm, M 8	S 250	79,00 gal Zn
10 mm, M 8	K 100	102,00 gal Zn

Artikel	87013.015
87013	Stahl galvanisch verzinkt

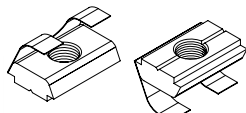

Muttern für T-Nuten, Profil 10 mm, mit Führungssteg, ohne Potentialausgleich, Fixierhilfe: Feder

Produktinformation → [TI-154](#)

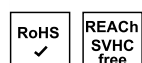

für Profil, Gewinde M

10 mm, M 6	S 250	106,00 gal Zn
10 mm, M 6	K 100	137,00 gal Zn
10 mm, M 8	S 250	112,00 gal Zn
10 mm, M 8	K 100	144,00 gal Zn

Artikel	87014.011
87014	Stahl galvanisch verzinkt

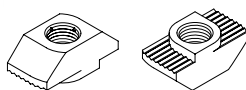

Hammermuttern für T-Nuten, Profil 8 mm, mit Bremsmoment, niedrige Form

Produktinformation → [TI-154](#)

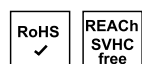

für Profil, Gewinde M

8 mm, M 5	S 2500	50,00 gal Zn
8 mm, M 5	K 100	65,00 gal Zn
8 mm, M 6	S 2500	55,00 gal Zn
8 mm, M 6	K 100	71,00 gal Zn

Abmessungen VE Stück €/100/Obf.

Artikel	87014.012
87014	Stahl galvanisch verzinkt

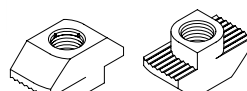

Hammermuttern für T-Nuten, Profil 8 mm, mit Bremsmoment, hohe Form

Produktinformation → [TI-154](#)

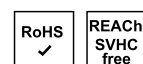

für Profil, Gewinde M

8 mm, M 5	S 1000	56,00 gal Zn
8 mm, M 5	K 100	72,00 gal Zn
8 mm, M 6	S 1000	62,00 gal Zn
8 mm, M 6	K 100	80,00 gal Zn

Artikel	87015.011
87015	Stahl galvanisch verzinkt

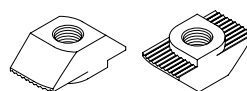

Hammermuttern für T-Nuten, Profil 10 mm, ohne Bremsmoment, niedrige Form

Produktinformation → [TI-154](#)



für Profil, Gewinde M

10 mm, M 6	S 1000	59,00 gal Zn
10 mm, M 6	K 100	76,00 gal Zn
10 mm, M 8	S 1000	62,00 gal Zn
10 mm, M 8	K 100	80,00 gal Zn

Artikel	89091.010	
89091	Stahl galvanisch verzinkt	Seko



Holzbauschrauben, Senkkopf mit Fräsrippen, mit Schafffräser und Schabenut

CE gemäß ETA-12/0276

Maße → [TI-52](#)

Korrosionsschutz → [TI-228](#)

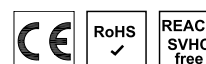

3,5	x	20 -T15	S 1000	2,55 gal Zn
3,5	x	25 -T15	S 1000	2,70 gal Zn
3,5	x	30 -T15	S 1000	2,80 gal Zn
3,5	x	35 -T15	S 1000	3,15 gal Zn

Abmessungen	VE	Stück	€/100/Obf.
3,5 x 40 -T15	S	500	3,45 gal Zn
3,5 x 50 -T15	S	500	4,05 gal Zn
4 x 25 -T20	S	1000	3,60 gal Zn
4 x 30 -T20	S	1000	3,65 gal Zn
4 x 35 -T20	S	1000	3,75 gal Zn
4 x 40 -T20	S	1000	4,05 gal Zn
4 x 45 -T20	S	500	4,65 gal Zn
4 x 50 -T20	S	500	5,10 gal Zn
4 x 60 -T20	S	200	6,50 gal Zn
4 x 70 -T20	S	200	6,90 gal Zn
4 x 80 -T20	S	200	7,70 gal Zn
4,5 x 30 -T25	S	500	3,95 gal Zn
4,5 x 35 -T25	S	500	4,40 gal Zn
4,5 x 40 -T25	S	500	5,10 gal Zn
4,5 x 45 -T25	S	500	5,60 gal Zn
4,5 x 50 -T25	S	500	6,10 gal Zn
4,5 x 60 -T25	S	200	7,40 gal Zn
4,5 x 70 -T25	S	200	8,60 gal Zn
4,5 x 80 -T25	S	200	9,80 gal Zn
5 x 30 -T25	S	200	5,30 gal Zn
5 x 35 -T25	S	200	5,70 gal Zn
5 x 40 -T25	S	200	6,10 gal Zn
5 x 50 -T25	S	200	7,90 gal Zn
5 x 60 -T25	S	200	9,20 gal Zn
5 x 70 -T25	S	200	9,80 gal Zn
5 x 80 -T25	S	200	12,10 gal Zn
5 x 90 -T25	S	200	13,60 gal Zn
5 x 100 -T25	S	200	15,70 gal Zn
5 x 120 -T25	S	200	20,40 gal Zn
6 x 60 -T30	S	200	12,10 gal Zn
6 x 70 -T30	S	200	13,40 gal Zn
6 x 80 -T30	S	200	15,80 gal Zn
6 x 90 -T30	S	100	17,00 gal Zn
6 x 100 -T30	S	100	19,40 gal Zn
6 x 110 -T30	S	100	23,00 gal Zn
6 x 120 -T30	S	100	24,20 gal Zn
6 x 130 -T30	S	100	27,00 gal Zn
6 x 140 -T30	S	100	30,50 gal Zn
6 x 160 -T30	S	100	39,00 gal Zn
6 x 180 -T30	S	100	55,00 gal Zn
6 x 200 -T30	S	100	65,00 gal Zn
6 x 220 -T30	S	100	80,00 gal Zn
6 x 240 -T30	S	100	107,00 gal Zn
6 x 260 -T30	S	100	125,00 gal Zn
6 x 280 -T30	S	100	147,00 gal Zn
6 x 300 -T30	S	100	176,00 gal Zn
8 x 70 -T40	S	50	24,20 gal Zn
8 x 80 -T40	S	50	27,00 gal Zn
8 x 90 -T40	S	50	30,50 gal Zn
8 x 100 -T40	S	50	34,00 gal Zn
8 x 120 -T40	S	50	44,00 gal Zn
8 x 140 -T40	S	50	56,00 gal Zn
8 x 160 -T40	S	50	68,00 gal Zn
8 x 180 -T40	S	50	83,00 gal Zn
8 x 200 -T40	S	50	96,00 gal Zn
8 x 220 -T40	S	50	111,00 gal Zn
8 x 240 -T40	S	50	135,00 gal Zn
8 x 260 -T40	S	50	158,00 gal Zn
8 x 280 -T40	S	50	181,00 gal Zn
8 x 300 -T40	S	50	200,00 gal Zn
8 x 320 -T40	S	50	234,00 gal Zn
8 x 340 -T40	S	50	255,00 gal Zn
8 x 360 -T40	S	50	275,00 gal Zn
8 x 380 -T40	S	50	305,00 gal Zn
8 x 400 -T40	S	50	330,00 gal Zn
10 x 100 -T40	S	50	58,00 gal Zn
10 x 120 -T40	S	50	73,00 gal Zn
10 x 140 -T40	S	50	85,00 gal Zn
10 x 160 -T40	S	25	100,00 gal Zn
10 x 180 -T40	S	25	121,00 gal Zn
10 x 200 -T40	S	25	140,00 gal Zn
10 x 220 -T40	S	25	169,00 gal Zn
10 x 240 -T40	S	25	197,00 gal Zn
10 x 260 -T40	S	25	233,00 gal Zn
10 x 280 -T40	S	25	255,00 gal Zn

Abmessungen	VE	Stück	€/100/Obf.
10 x 300 -T40	S	25	280,00 gal Zn
10 x 320 -T40	S	25	330,00 gal Zn
10 x 340 -T40	S	25	380,00 gal Zn
10 x 360 -T40	S	25	410,00 gal Zn
10 x 380 -T40	S	25	450,00 gal Zn
10 x 400 -T40	S	25	480,00 gal Zn

Artikel 89184.012

89184 Stahl Form B galvanisch verzinkt

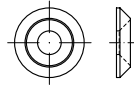

Senkscheiben für Holzbauschrauben

CE gemäß ETA-12/0276

für Artikel 89091 geeignet

Maße → TI-115 REACH → TI-262
Korrosionsschutz → TI-228



B 6	S	50	35,50 gal Zn
B 8	S	50	50,00 gal Zn
B 10	S	50	88,00 gal Zn

Artikel 89092.010

89092 Stahl galvanisch verzinkt



Holzbauschrauben, Tellerkopf, mit Schafffräser und Schabenut

CE gemäß ETA-12/0276

Maße → TI-53 Korrosionsschutz → TI-228

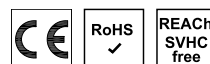

6 x 40 -T30	S	200	12,90 gal Zn
6 x 50 -T30	S	200	14,30 gal Zn
6 x 60 -T30	S	200	15,60 gal Zn
6 x 70 -T30	S	200	16,60 gal Zn
6 x 80 -T30	S	200	18,30 gal Zn
6 x 100 -T30	S	100	22,90 gal Zn
6 x 120 -T30	S	100	29,50 gal Zn
6 x 140 -T30	S	100	35,50 gal Zn
6 x 160 -T30	S	100	45,50 gal Zn
6 x 180 -T30	S	100	61,00 gal Zn
6 x 200 -T30	S	100	73,00 gal Zn
8 x 80 -T40	S	100	34,50 gal Zn
8 x 100 -T40	S	100	44,50 gal Zn
8 x 120 -T40	S	50	57,00 gal Zn
8 x 140 -T40	S	50	67,00 gal Zn
8 x 160 -T40	S	50	82,00 gal Zn
8 x 180 -T40	S	50	98,00 gal Zn
8 x 200 -T40	S	50	113,00 gal Zn
8 x 220 -T40	S	50	133,00 gal Zn
8 x 240 -T40	S	50	153,00 gal Zn
8 x 260 -T40	S	50	175,00 gal Zn
8 x 280 -T40	S	50	196,00 gal Zn

Abmessungen	VE	Stück	€/100/Obf.
8 x 300 -T40	S	50	216,00 gal Zn
8 x 320 -T40	S	50	255,00 gal Zn
8 x 340 -T40	S	50	275,00 gal Zn
8 x 360 -T40	S	50	290,00 gal Zn
8 x 380 -T40	S	50	310,00 gal Zn
8 x 400 -T40	S	50	330,00 gal Zn
10 x 80 -T40	S	50	85,00 gal Zn
10 x 100 -T40	S	50	95,00 gal Zn
10 x 120 -T40	S	50	107,00 gal Zn
10 x 140 -T40	S	50	123,00 gal Zn
10 x 160 -T40	S	25	142,00 gal Zn
10 x 180 -T40	S	25	158,00 gal Zn
10 x 200 -T40	S	25	209,00 gal Zn
10 x 220 -T40	S	25	270,00 gal Zn
10 x 240 -T40	S	25	295,00 gal Zn
10 x 260 -T40	S	25	355,00 gal Zn
10 x 280 -T40	S	25	390,00 gal Zn
10 x 300 -T40	S	25	415,00 gal Zn
10 x 320 -T40	S	25	440,00 gal Zn
10 x 340 -T40	S	25	475,00 gal Zn
10 x 360 -T40	S	25	510,00 gal Zn
10 x 380 -T40	S	25	530,00 gal Zn
10 x 400 -T40	S	25	590,00 gal Zn
10 x 450 -T40	S	25	770,00 gal Zn

Artikel 89096.010

89096 Stahl Ruko-Z galvanisch verzinkt



Spanplattenschrauben, Ruko = Halbrundkopf Z = Pozidriv-Kreuzschlitz

CE gemäß EN 14592 ab einer Gewindelänge 4 x d

Maße → TI-52 Korrosionsschutz → TI-228

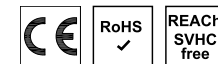

3 x 10 -Z	S	1000	1,95 gal Zn
3 x 12 -Z	S	1000	1,95 gal Zn
3 x 16 -Z	S	1000	2,00 gal Zn
3 x 20 -Z	S	1000	2,20 gal Zn
3 x 25 -Z	S	1000	2,40 gal Zn
3 x 30 -Z	S	1000	3,25 gal Zn
3,5 x 12 -Z	S	1000	2,45 gal Zn
3,5 x 16 -Z	S	1000	2,40 gal Zn
3,5 x 20 -Z	S	1000	2,75 gal Zn
3,5 x 25 -Z	S	1000	2,90 gal Zn
3,5 x 30 -Z	S	1000	3,25 gal Zn
3,5 x 35 -Z	S	1000	4,10 gal Zn
3,5 x 40 -Z	S	1000	4,60 gal Zn
4 x 12 -Z	S	1000	2,90 gal Zn
4 x 16 -Z	S	1000	2,90 gal Zn
4 x 17 -Z	S	1000	2,60 gal Zn
4 x 20 -Z	S	1000	3,15 gal Zn
4 x 25 -Z	S	1000	3,65 gal Zn
4 x 30 -Z	S	1000	3,85 gal Zn
4 x 35 -Z	S	1000	4,45 gal Zn
4 x 40 -Z	S	1000	5,20 gal Zn
4 x 45 -Z	S	500	5,90 gal Zn
4 x 50 -Z	S	500	6,50 gal Zn
4 x 60 -Z	S	500	6,70 gal Zn
4,5 x 12 -Z	S	1000	4,40 gal Zn
4,5 x 16 -Z	S	1000	4,40 gal Zn
4,5 x 20 -Z	S	1000	4,40 gal Zn
4,5 x 25 -Z	S	1000	4,80 gal Zn
4,5 x 30 -Z	S	500	5,30 gal Zn

Abmessungen	VE	Stück	€/100/Obf.
4,5 x 35 -Z	S	500	5,80 gal Zn
4,5 x 40 -Z	S	500	6,30 gal Zn
4,5 x 45 -Z	S	500	8,20 gal Zn
4,5 x 50 -Z	S	500	9,20 gal Zn
4,5 x 60 -Z	S	500	10,90 gal Zn
5 x 16 -Z	S	1000	5,10 gal Zn
5 x 20 -Z	S	1000	5,70 gal Zn
5 x 25 -Z	S	500	6,00 gal Zn
5 x 30 -Z	S	500	6,60 gal Zn
5 x 35 -Z	S	500	7,70 gal Zn
5 x 40 -Z	S	500	8,30 gal Zn
5 x 45 -Z	S	200	9,20 gal Zn
5 x 50 -Z	S	200	9,70 gal Zn
5 x 60 -Z	S	200	11,80 gal Zn
5 x 70 -Z	S	200	14,60 gal Zn
5 x 80 -Z	S	200	18,20 gal Zn
5 x 90 -Z	S	200	23,00 gal Zn
6 x 20 -Z	S	500	7,40 gal Zn
6 x 25 -Z	S	500	8,40 gal Zn
6 x 30 -Z	S	500	10,80 gal Zn
6 x 35 -Z	S	500	11,70 gal Zn
6 x 40 -Z	S	500	12,00 gal Zn
6 x 45 -Z	S	200	12,80 gal Zn
6 x 50 -Z	S	200	13,80 gal Zn
6 x 60 -Z	S	200	17,00 gal Zn
6 x 70 -Z	S	200	18,60 gal Zn
6 x 80 -Z	S	200	19,80 gal Zn
6 x 90 -Z	S	200	24,20 gal Zn
6 x 100 -Z	S	100	30,50 gal Zn

Artikel	89096.014
89096	Stahl Ruko-ISR galvanisch verzinkt



Spanplattenschrauben, Ruko = Halbrundkopf
ISR = Innensechsrund

CE gemäß EN 14592 ab einer Gewindelänge 4 x d

Maße → **TI-52**

Korrosionsschutz → **TI-228**

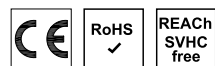

3 x 10 -T10	S	1000	2,70 gal Zn
3 x 12 -T10	S	1000	2,75 gal Zn
3 x 16 -T10	S	1000	2,75 gal Zn
3 x 20 -T10	S	1000	3,05 gal Zn
3 x 25 -T10	S	1000	3,25 gal Zn
3 x 30 -T10	S	1000	4,40 gal Zn
3,5 x 12 -T15	S	1000	3,30 gal Zn
3,5 x 16 -T15	S	1000	3,30 gal Zn
3,5 x 20 -T15	S	1000	3,70 gal Zn
3,5 x 25 -T15	S	1000	3,95 gal Zn
3,5 x 30 -T15	S	1000	4,40 gal Zn
3,5 x 35 -T15	S	1000	5,60 gal Zn
3,5 x 40 -T15	S	1000	6,30 gal Zn
4 x 12 -T20	S	1000	3,95 gal Zn
4 x 16 -T20	S	1000	3,95 gal Zn
4 x 17 -T20	S	1000	4,30 gal Zn
4 x 20 -T20	S	1000	4,30 gal Zn
4 x 25 -T20	S	1000	4,95 gal Zn
4 x 30 -T20	S	1000	5,20 gal Zn
4 x 35 -T20	S	1000	6,00 gal Zn
4 x 40 -T20	S	500	7,00 gal Zn
4 x 45 -T20	S	500	8,00 gal Zn
4 x 50 -T20	S	500	8,80 gal Zn
4 x 60 -T20	S	500	9,10 gal Zn

Abmessungen	VE	Stück	€/100/Obf.
4,5 x 12 -T20	S	1000	6,00 gal Zn
4,5 x 16 -T20	S	1000	6,00 gal Zn
4,5 x 20 -T20	S	1000	6,00 gal Zn
4,5 x 25 -T20	S	1000	6,50 gal Zn
4,5 x 30 -T20	S	500	7,20 gal Zn
4,5 x 35 -T20	S	500	7,90 gal Zn
4,5 x 40 -T20	S	500	8,60 gal Zn
4,5 x 45 -T20	S	500	11,00 gal Zn
4,5 x 50 -T20	S	500	12,50 gal Zn
4,5 x 60 -T20	S	500	14,80 gal Zn
5 x 16 -T25	S	1000	6,90 gal Zn
5 x 20 -T25	S	1000	7,70 gal Zn
5 x 25 -T25	S	500	8,10 gal Zn
5 x 30 -T25	S	500	8,90 gal Zn
5 x 35 -T25	S	500	10,40 gal Zn
5 x 40 -T25	S	500	11,20 gal Zn
5 x 45 -T25	S	200	12,50 gal Zn
5 x 50 -T25	S	200	13,10 gal Zn
5 x 60 -T25	S	200	15,90 gal Zn
5 x 70 -T25	S	200	19,70 gal Zn
5 x 80 -T25	S	200	24,60 gal Zn
5 x 90 -T25	S	200	31,50 gal Zn
6 x 20 -T30	S	500	10,00 gal Zn
6 x 25 -T30	S	500	11,40 gal Zn
6 x 30 -T30	S	500	14,60 gal Zn
6 x 35 -T30	S	500	15,80 gal Zn
6 x 40 -T30	S	500	16,30 gal Zn
6 x 45 -T30	S	200	17,20 gal Zn
6 x 50 -T30	S	200	18,70 gal Zn
6 x 60 -T30	S	200	22,90 gal Zn
6 x 70 -T30	S	200	26,50 gal Zn
6 x 80 -T30	S	200	27,00 gal Zn
6 x 90 -T30	S	200	33,00 gal Zn
6 x 100 -T30	S	100	41,50 gal Zn

Artikel	89097.010
89097	Stahl Seko-Z galvanisch verzinkt



Spanplattenschrauben, Seko = Senkkopf
Z = Pozidriv-Kreuzschlitz

CE gemäß EN 14592 ab einer Gewindelänge 4 x d

Maße → **TI-52**

Korrosionsschutz → **TI-228**

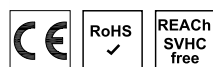

3 x 10 -Z	S	1000	1,65 gal Zn
3 x 12 -Z	S	1000	1,65 gal Zn
3 x 16 -Z	S	1000	1,70 gal Zn
3 x 20 -Z	S	1000	1,85 gal Zn
3 x 25 -Z	S	1000	2,00 gal Zn
3 x 30 -Z	S	1000	2,70 gal Zn
3 x 35 -Z	S	1000	3,00 gal Zn
3 x 40 -Z	S	1000	4,10 gal Zn
3 x 45 -Z	S	1000	5,40 gal Zn
3,5 x 12 -Z	S	1000	2,00 gal Zn
3,5 x 16 -Z	S	1000	2,00 gal Zn
3,5 x 20 -Z	S	1000	2,30 gal Zn
3,5 x 25 -Z	S	1000	2,45 gal Zn
3,5 x 30 -Z	S	1000	2,75 gal Zn
3,5 x 35 -Z	S	1000	3,35 gal Zn
3,5 x 40 -Z	S	1000	3,85 gal Zn
3,5 x 45 -Z	S	1000	5,90 gal Zn
3,5 x 50 -Z	S	500	6,30 gal Zn
4 x 16 -Z	S	1000	2,45 gal Zn

Abmessungen	VE	Stück	€/100/Obf.
4 x 20 -Z	S	1000	2,70 gal Zn
4 x 25 -Z	S	1000	3,00 gal Zn
4 x 30 -Z	S	1000	3,15 gal Zn
4 x 35 -Z	S	1000	3,70 gal Zn
4 x 40 -Z	S	1000	4,40 gal Zn
4 x 45 -Z	S	500	4,95 gal Zn
4 x 50 -Z	S	500	5,40 gal Zn
4 x 55 -Z	S	500	9,20 gal Zn
4 x 60 -Z	S	500	9,20 gal Zn
4,5 x 16 -Z	S	1000	3,35 gal Zn
4,5 x 20 -Z	S	1000	3,70 gal Zn
4,5 x 25 -Z	S	1000	4,10 gal Zn
4,5 x 30 -Z	S	1000	4,40 gal Zn
4,5 x 35 -Z	S	500	4,80 gal Zn
4,5 x 40 -Z	S	500	5,30 gal Zn
4,5 x 45 -Z	S	500	6,80 gal Zn
4,5 x 50 -Z	S	500	7,10 gal Zn
4,5 x 55 -Z	S	500	8,60 gal Zn
4,5 x 60 -Z	S	500	8,90 gal Zn
4,5 x 70 -Z	S	200	14,90 gal Zn
5 x 20 -Z	S	1000	4,85 gal Zn
5 x 25 -Z	S	1000	4,95 gal Zn
5 x 30 -Z	S	500	5,50 gal Zn
5 x 35 -Z	S	500	6,30 gal Zn
5 x 40 -Z	S	500	6,80 gal Zn
5 x 45 -Z	S	500	7,70 gal Zn
5 x 50 -Z	S	500	8,20 gal Zn
5 x 55 -Z	S	500	9,10 gal Zn
5 x 60 -Z	S	500	9,90 gal Zn
5 x 70 -Z	S	200	13,80 gal Zn
6 x 30 -Z	S	500	10,50 gal Zn
6 x 40 -Z	S	500	10,50 gal Zn
6 x 45 -Z	S	200	10,80 gal Zn
6 x 50 -Z	S	200	11,80 gal Zn
6 x 60 -Z	S	200	14,20 gal Zn
6 x 70 -Z	S	200	17,20 gal Zn

Artikel	89097.019
89097	Stahl Seko-Z-Tg galvanisch verzinkt



Spanplattenschrauben, Seko = Senkkopf
Z = Pozidriv-Kreuzschlitz
Tg = Teilgewinde

CE gemäß EN 14592 ab einer Gewindelänge 4 x d

Maße → **TI-52**

Korrosionsschutz → **TI-228**

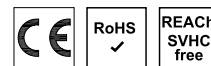

3 x 30/18 -Z	S	1000	2,70 gal Zn
3 x 35/21 -Z	S	1000	2,00 gal Zn
3 x 40/24 -Z	S	1000	4,10 gal Zn
3 x 45/27 -Z	S	1000	5,40 gal Zn
3,5 x 30/18 -Z	S	1000	2,75 gal Zn
3,5 x 35/21 -Z	S	1000	3,35 gal Zn
3,5 x 40/24 -Z	S	1000	3,90 gal Zn
3,5 x 45/27 -Z	S	1000	6,20 gal Zn
3,5 x 50/30 -Z	S	500	6,50 gal Zn
4 x 30/18 -Z	S	1000	3,15 gal Zn
4 x 35/21 -Z	S	1000	3,70 gal Zn
4 x 40/24 -Z	S	1000	4,40 gal Zn
4 x 45/27 -Z	S	500	5,10 gal Zn
4 x 50/30 -Z	S	500	5,40 gal Zn
4 x 55/33 -Z	S	500	9,20 gal Zn
4 x 60/36 -Z	S	500	9,60 gal Zn

Abmessungen	VE	Stück	€/100/Obf.
4 x 70/42 -Z	S	200	15,20 gal Zn
4 x 80/48 -Z	S	200	18,90 gal Zn
4,5 x 30/18 -Z	S	1000	4,40 gal Zn
4,5 x 35/21 -Z	S	500	4,80 gal Zn
4,5 x 40/24 -Z	S	500	5,40 gal Zn
4,5 x 45/27 -Z	S	500	6,80 gal Zn
4,5 x 50/30 -Z	S	500	7,10 gal Zn
4,5 x 60/36 -Z	S	500	8,90 gal Zn
4,5 x 70/42 -Z	S	200	15,00 gal Zn
4,5 x 80/48 -Z	S	200	25,50 gal Zn
5 x 30/18 -Z	S	500	5,50 gal Zn
5 x 35/21 -Z	S	500	6,30 gal Zn
5 x 40/24 -Z	S	500	6,90 gal Zn
5 x 45/27 -Z	S	500	8,20 gal Zn
5 x 50/30 -Z	S	500	8,20 gal Zn
5 x 55/33 -Z	S	500	9,90 gal Zn
5 x 60/36 -Z	S	500	9,90 gal Zn
5 x 70/42 -Z	S	200	14,10 gal Zn
5 x 80/48 -Z	S	200	17,10 gal Zn
5 x 90/54 -Z	S	200	22,10 gal Zn
5 x 100/60 -Z	S	200	24,60 gal Zn
5 x 120/70 -Z	S	200	36,50 gal Zn
6 x 40/24 -Z	S	500	10,50 gal Zn
6 x 50/30 -Z	S	200	11,50 gal Zn
6 x 60/36 -Z	S	200	14,10 gal Zn
6 x 70/42 -Z	S	200	17,50 gal Zn
6 x 80/48 -Z	S	200	19,50 gal Zn
6 x 90/54 -Z	S	200	22,60 gal Zn
6 x 100/60 -Z	S	100	26,50 gal Zn
6 x 110/70 -Z	S	100	34,50 gal Zn
6 x 120/70 -Z	S	100	40,00 gal Zn
6 x 130/70 -Z	S	100	44,50 gal Zn
6 x 140/70 -Z	S	100	51,00 gal Zn
6 x 150/70 -Z	S	100	59,00 gal Zn
6 x 160/70 -Z	S	100	69,00 gal Zn
6 x 180/70 -Z	S	100	85,00 gal Zn
6 x 200/70 -Z	S	100	107,00 gal Zn
6 x 220/70 -Z	S	100	180,00 gal Zn
6 x 240/70 -Z	S	100	201,00 gal Zn
6 x 280/70 -Z	S	100	224,00 gal Zn
6 x 300/70 -Z	S	100	234,00 gal Zn

Artikel 89098.010
89098 Stahl **Seko-ISR**
 galvanisch verzinkt



**Spanplattenschrauben,
Seko = Senkkopf
ISR = Innensechsrund**

CE gemäß EN 14592 ab einer Gewindelänge 4 x d

Maße → **TI-52** Korrosionsschutz → **TI-228**

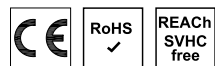

3 x 12 -T10	S	1000	1,65 gal Zn
3 x 16 -T10	S	1000	1,70 gal Zn
3 x 20 -T10	S	1000	1,85 gal Zn
3 x 25 -T10	S	1000	2,00 gal Zn
3 x 30 -T10	S	1000	2,70 gal Zn
3 x 35 -T10	S	1000	3,00 gal Zn
3 x 40 -T10	S	1000	4,10 gal Zn
3 x 45 -T10	S	1000	5,40 gal Zn
3,5 x 12 -T15	S	1000	2,00 gal Zn
3,5 x 16 -T15	S	1000	2,00 gal Zn
3,5 x 20 -T15	S	1000	2,30 gal Zn
3,5 x 25 -T15	S	1000	2,45 gal Zn

Abmessungen	VE	Stück	€/100/Obf.
3,5 x 30 -T15	S	1000	2,75 gal Zn
3,5 x 35 -T15	S	1000	3,35 gal Zn
3,5 x 40 -T15	S	1000	3,85 gal Zn
3,5 x 45 -T15	S	1000	5,90 gal Zn
3,5 x 50 -T15	S	500	6,30 gal Zn
4 x 16 -T20	S	1000	2,45 gal Zn
4 x 20 -T20	S	1000	2,70 gal Zn
4 x 25 -T20	S	1000	3,00 gal Zn
4 x 30 -T20	S	1000	3,15 gal Zn
4 x 35 -T20	S	1000	3,70 gal Zn
4 x 40 -T20	S	1000	4,40 gal Zn
4 x 45 -T20	S	1000	4,95 gal Zn
4 x 50 -T20	S	1000	5,40 gal Zn
4 x 60 -T20	S	500	9,20 gal Zn
4 x 70 -T20	S	500	14,90 gal Zn
4,5 x 16 -T20	S	1000	3,35 gal Zn
4,5 x 20 -T20	S	1000	3,70 gal Zn
4,5 x 25 -T20	S	1000	4,10 gal Zn
4,5 x 30 -T20	S	1000	4,40 gal Zn
4,5 x 35 -T20	S	500	4,80 gal Zn
4,5 x 40 -T20	S	500	5,30 gal Zn
4,5 x 45 -T20	S	500	6,80 gal Zn
4,5 x 50 -T20	S	500	7,10 gal Zn
4,5 x 60 -T20	S	500	8,90 gal Zn
4,5 x 70 -T20	S	200	14,90 gal Zn
5 x 20 -T25	S	1000	4,85 gal Zn
5 x 25 -T25	S	1000	4,95 gal Zn
5 x 30 -T25	S	500	5,50 gal Zn
5 x 35 -T25	S	500	6,30 gal Zn
5 x 40 -T25	S	500	6,80 gal Zn
5 x 50 -T25	S	500	8,20 gal Zn
5 x 60 -T25	S	500	9,90 gal Zn
5 x 70 -T25	S	500	13,80 gal Zn
6 x 30 -T30	S	500	10,50 gal Zn
6 x 40 -T30	S	500	10,50 gal Zn
6 x 50 -T30	S	200	11,80 gal Zn
6 x 60 -T30	S	200	14,20 gal Zn

Artikel 89098.019
89098 Stahl **Seko-ISR-Tg**
 galvanisch verzinkt



**Spanplattenschrauben,
Seko = Senkkopf
ISR = Innensechsrund
Tg = Teilgewinde**

CE gemäß EN 14592 ab einer Gewindelänge 4 x d

Maße → **TI-52** Korrosionsschutz → **TI-228**

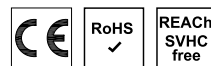

3 x 30/18 -T10	S	1000	2,70 gal Zn
3 x 35/21 -T10	S	1000	2,00 gal Zn
3 x 40/24 -T10	S	1000	4,10 gal Zn
3 x 45/27 -T10	S	1000	5,40 gal Zn
3,5 x 30/18 -T15	S	1000	2,75 gal Zn
3,5 x 35/21 -T15	S	1000	3,35 gal Zn
3,5 x 40/24 -T15	S	1000	3,90 gal Zn
3,5 x 45/27 -T15	S	1000	6,20 gal Zn
3,5 x 50/30 -T15	S	500	6,50 gal Zn
4 x 30/18 -T20	S	1000	3,15 gal Zn
4 x 35/21 -T20	S	1000	3,70 gal Zn
4 x 40/24 -T20	S	1000	4,40 gal Zn
4 x 45/27 -T20	S	500	5,10 gal Zn
4 x 50/30 -T20	S	500	5,40 gal Zn
4 x 55/33 -T20	S	500	9,20 gal Zn

Abmessungen	VE	Stück	€/100/Obf.
4 x 60/36 -T20	S	500	9,60 gal Zn
4 x 70/42 -T20	S	200	15,20 gal Zn
4 x 80/48 -T20	S	500	18,90 gal Zn
4,5 x 30/18 -T20	S	1000	4,40 gal Zn
4,5 x 35/21 -T20	S	500	4,80 gal Zn
4,5 x 40/24 -T20	S	500	5,40 gal Zn
4,5 x 45/27 -T20	S	500	6,80 gal Zn
4,5 x 50/30 -T20	S	500	7,10 gal Zn
4,5 x 60/36 -T20	S	500	8,90 gal Zn
4,5 x 70/42 -T20	S	200	15,00 gal Zn
4,5 x 80/48 -T20	S	200	25,50 gal Zn
5 x 30/18 -T25	S	500	5,50 gal Zn
5 x 35/21 -T25	S	500	6,30 gal Zn
5 x 40/24 -T25	S	500	6,90 gal Zn
5 x 45/27 -T25	S	500	8,20 gal Zn
5 x 50/30 -T25	S	500	8,20 gal Zn
5 x 55/33 -T25	S	500	9,90 gal Zn
5 x 60/36 -T25	S	500	9,90 gal Zn
5 x 70/42 -T25	S	500	14,10 gal Zn
5 x 80/48 -T25	S	500	17,10 gal Zn
5 x 90/54 -T25	S	200	22,10 gal Zn
5 x 100/60 -T25	S	200	24,60 gal Zn
5 x 120/70 -T25	S	200	36,50 gal Zn
6 x 40/24 -T30	S	500	10,50 gal Zn
6 x 50/30 -T30	S	200	11,50 gal Zn
6 x 60/36 -T30	S	200	14,10 gal Zn
6 x 70/42 -T30	S	200	17,50 gal Zn
6 x 80/48 -T30	S	200	19,50 gal Zn
6 x 90/54 -T30	S	200	22,60 gal Zn
6 x 100/60 -T30	S	100	26,50 gal Zn
6 x 110/70 -T30	S	100	34,50 gal Zn
6 x 120/70 -T30	S	100	40,00 gal Zn
6 x 130/70 -T30	S	100	44,50 gal Zn
6 x 140/70 -T30	S	100	51,00 gal Zn
6 x 150/70 -T30	S	100	59,00 gal Zn
6 x 160/70 -T30	S	100	69,00 gal Zn
6 x 180/70 -T30	S	100	85,00 gal Zn
6 x 200/70 -T30	S	100	107,00 gal Zn
6 x 220/70 -T30	S	100	180,00 gal Zn
6 x 240/70 -T30	S	100	201,00 gal Zn
6 x 260/70 -T30	S	100	207,00 gal Zn
6 x 280/70 -T30	S	100	224,00 gal Zn
6 x 300/70 -T30	S	100	234,00 gal Zn
8 x 70/60 -T40	S	100	48,50 gal Zn
8 x 90/60 -T40	S	100	79,00 gal Zn

Artikel 88006.(*)
88006 Kunststoff **ISR**

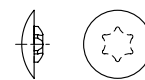

**Zierkappen für Senkschrauben
mit Innensechsrund**

weiß RAL 9010 (*630),
 hellbraun RAL 8001 (*640),
 dunkelbraun RAL 8014 (*650),
 rehbraun RAL 8007 (*660)

REACH → **TI-262**

ISR-Nummer x Kappen Ø / für Schrauben Ø

15 x 12 /3,5	S	1000	3,45
20 x 12 /4-4,5	S	1000	3,45
25 x 13,5/5	S	1000	3,45
30 x 16,5/6	S	1000	3,45

Abmessungen	VE	Stück	€/100/Obf.
Artikel	89571.014		
89571	Stahl galvanisch verzinkt		

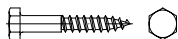

Sechskantholzschrauben

CE nach EN 14592

Maße → **TI-51**

Korrosionsschutz → **TI-228**

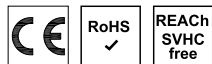

8	x	80	S	200	41,00 gal Zn
12	x	80	S	50	106,00 gal Zn
12	x	100	S	50	130,00 gal Zn
12	x	120	S	50	160,00 gal Zn
12	x	140	S	50	178,00 gal Zn
12	x	160	S	25	236,00 gal Zn
12	x	180	S	25	265,00 gal Zn
12	x	200	S	25	305,00 gal Zn
12	x	220	S	25	425,00 gal Zn
12	x	240	S	25	455,00 gal Zn
12	x	260	S	25	510,00 gal Zn
12	x	280	S	25	550,00 gal Zn
12	x	300	S	25	610,00 gal Zn
12	x	340	S	25	1350,00 gal Zn

Artikel	89601.410		
89601	Mu 4.8 galvanisch verzinkt		

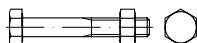

Baubolzen, Mu = mit Sechskantmutter

CE nach EN 14592

Maße → **TI-15**

REACH → **TI-262**

Korrosionsschutz → **TI-228**



M 12	x	100	S	50	147,00 gal Zn
M 12	x	120	S	50	197,00 gal Zn
M 12	x	140	S	50	300,00 gal Zn
M 12	x	150	S	50	295,00 gal Zn
M 12	x	160	S	25	295,00 gal Zn
M 12	x	170	S	25	330,00 gal Zn
M 12	x	180	S	25	345,00 gal Zn
M 12	x	200	S	25	380,00 gal Zn
M 12	x	220	S	25	420,00 gal Zn
M 12	x	240	S	25	455,00 gal Zn
M 12	x	260	S	25	480,00 gal Zn
M 12	x	280	S	25	520,00 gal Zn
M 12	x	300	S	25	550,00 gal Zn
M 12	x	320	S	25	570,00 gal Zn
M 12	x	340	S	25	590,00 gal Zn
M 12	x	360	S	25	620,00 gal Zn
M 12	x	380	S	25	650,00 gal Zn
M 12	x	400	S	25	680,00 gal Zn
M 12	x	420	S	25	720,00 gal Zn
M 12	x	440	S	25	770,00 gal Zn

Abmessungen	VE	Stück	€/100/Obf.		
M 12	x	460	S	25	800,00 gal Zn
M 12	x	480	S	25	830,00 gal Zn
M 12	x	500	S	25	860,00 gal Zn
M 12	x	520	S	25	980,00 gal Zn
M 12	x	540	S	25	1030,00 gal Zn
M 12	x	560	S	25	1070,00 gal Zn
M 12	x	580	S	25	1110,00 gal Zn
M 12	x	600	S	25	1150,00 gal Zn
M 12	x	620	S	15	1200,00 gal Zn
M 12	x	640	S	15	1250,00 gal Zn
M 12	x	660	S	15	1300,00 gal Zn
M 12	x	680	S	15	1350,00 gal Zn
M 12	x	700	S	15	1400,00 gal Zn
M 12	x	720	S	15	1470,00 gal Zn
M 12	x	740	S	15	1530,00 gal Zn
M 12	x	760	S	15	1590,00 gal Zn
M 16	x	100	S	50	160,00 gal Zn
M 16	x	110	S	50	170,00 gal Zn
M 16	x	120	S	50	197,00 gal Zn
M 16	x	130	S	50	205,00 gal Zn
M 16	x	140	S	50	217,00 gal Zn
M 16	x	150	S	50	295,00 gal Zn
M 16	x	160	S	25	540,00 gal Zn
M 16	x	170	S	25	560,00 gal Zn
M 16	x	180	S	25	570,00 gal Zn
M 16	x	190	S	25	580,00 gal Zn
M 16	x	200	S	25	590,00 gal Zn
M 16	x	220	S	25	680,00 gal Zn
M 16	x	240	S	25	720,00 gal Zn
M 16	x	260	S	25	770,00 gal Zn
M 16	x	280	S	25	820,00 gal Zn
M 16	x	300	S	25	850,00 gal Zn
M 16	x	320	S	25	910,00 gal Zn
M 16	x	340	S	25	950,00 gal Zn
M 16	x	360	S	25	1000,00 gal Zn
M 16	x	380	S	25	1030,00 gal Zn
M 16	x	400	S	25	1050,00 gal Zn
M 16	x	420	S	15	1080,00 gal Zn
M 16	x	440	S	15	1100,00 gal Zn
M 16	x	460	S	15	1140,00 gal Zn
M 16	x	480	S	15	1190,00 gal Zn
M 16	x	500	S	15	1240,00 gal Zn
M 16	x	520	S	15	1900,00 gal Zn
M 16	x	540	S	15	1960,00 gal Zn
M 16	x	560	S	15	2030,00 gal Zn
M 16	x	580	S	15	2110,00 gal Zn
M 16	x	600	S	15	2180,00 gal Zn
M 16	x	620	S	15	2250,00 gal Zn
M 16	x	640	S	15	2320,00 gal Zn
M 16	x	660	S	15	2390,00 gal Zn
M 16	x	680	S	15	2470,00 gal Zn
M 16	x	700	S	15	2550,00 gal Zn
M 20	x	160	S	15	870,00 gal Zn
M 20	x	180	S	15	940,00 gal Zn
M 20	x	200	S	15	950,00 gal Zn
M 20	x	220	S	15	980,00 gal Zn
M 20	x	240	S	15	1010,00 gal Zn
M 20	x	260	S	15	1070,00 gal Zn
M 20	x	280	S	15	1130,00 gal Zn
M 20	x	300	S	15	1160,00 gal Zn
M 20	x	320	S	15	1210,00 gal Zn
M 20	x	340	S	15	1250,00 gal Zn
M 20	x	360	S	15	1310,00 gal Zn
M 20	x	380	S	15	1370,00 gal Zn
M 20	x	400	S	15	1460,00 gal Zn
M 20	x	420	S	10	1610,00 gal Zn
M 20	x	440	S	10	1680,00 gal Zn
M 20	x	460	S	10	1750,00 gal Zn
M 20	x	480	S	10	1820,00 gal Zn
M 20	x	500	S	10	1890,00 gal Zn
M 20	x	520	S	10	2900,00 gal Zn
M 20	x	540	S	10	3050,00 gal Zn
M 20	x	560	S	10	3150,00 gal Zn
M 20	x	580	S	10	3250,00 gal Zn
M 20	x	600	S	10	3350,00 gal Zn

Abmessungen	VE	Stück	€/100/Obf.		
M 20	x	620	S	10	3500,00 gal Zn
M 20	x	640	S	10	3600,00 gal Zn
M 20	x	660	S	10	3700,00 gal Zn
M 20	x	680	S	10	3750,00 gal Zn
M 20	x	700	S	10	3850,00 gal Zn
M 20	x	720	S	10	3950,00 gal Zn
M 20	x	740	S	10	4050,00 gal Zn
M 24	x	220	S	10	1430,00 gal Zn
M 24	x	240	S	10	1550,00 gal Zn
M 24	x	260	S	10	1660,00 gal Zn
M 24	x	280	S	10	1770,00 gal Zn
M 24	x	300	S	10	1880,00 gal Zn
M 24	x	320	S	10	2050,00 gal Zn
M 24	x	340	S	10	2160,00 gal Zn
M 24	x	360	S	10	2270,00 gal Zn
M 24	x	380	S	10	2390,00 gal Zn
M 24	x	400	S	10	2550,00 gal Zn
M 24	x	420	S	10	2650,00 gal Zn
M 24	x	440	S	5	2750,00 gal Zn
M 24	x	460	S	5	2900,00 gal Zn
M 24	x	480	S	5	3000,00 gal Zn
M 24	x	500	S	5	3100,00 gal Zn
M 24	x	520	S	5	3200,00 gal Zn
M 24	x	540	S	5	3300,00 gal Zn
M 24	x	560	S	5	3400,00 gal Zn
M 24	x	580	S	5	3500,00 gal Zn
M 24	x	600	S	5	3600,00 gal Zn
M 24	x	620	S	5	3700,00 gal Zn
M 24	x	640	S	5	3750,00 gal Zn
M 24	x	660	S	5	3900,00 gal Zn

Artikel	89150.045		
89150	Stahl phosphatiert		



Schnellbauschrauben mit Trompetenkopf und Grobgewinde

CE gemäß EN 14566

Maße → **TI-53**

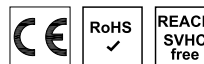

3,9	x	25 -H	S	1000	6,30
3,9	x	30 -H	S	1000	7,10
3,9	x	35 -H	S	1000	7,40
3,9	x	45 -H	S	1000	9,50

Abmessungen VE Stück €/100/Obf.
 Artikel 89151.045

89151 Stahl phosphatiert

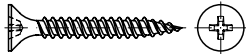

Schnellbauschrauben mit Trompetenkopf und Feingewinde

CE gemäß EN 14566

Maße → **TI-53**



3,9	x 25 -H	S 1000	6,00
3,9	x 35 -H	S 1000	6,90
3,9	x 45 -H	S 1000	8,90

Abmessungen VE Stück €/100/Obf.
 Artikel 89152.045

89152 Stahl phosphatiert



Schnellbauschrauben mit Trompetenkopf und Bohrspitze

CE gemäß EN 14566

Maße → **TI-53**



3,5	x 25 -H	S 1000	12,80
3,5	x 35 -H	S 1000	14,60
3,5	x 45 -H	S 1000	18,20

Abmessungen VE Stück €/100/Obf.



- ✓ Große Artikelvielfalt
- ✓ Verlässliche Qualität
- ✓ Hohe Lieferbereitschaft

Abmessungen	VE Stück	€/100/Obf.
DIN	00001.912	
1	A 1	Form B

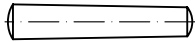

**Kegelstifte,
Kegel 1 : 50,
B = gedreht**

Maße → **TI-117** Normumstellung → **TI-10**
 Werkstoffeigensch. → **TI-236**
 Stahl → **S. 63**
 DIN 1 → wird ersetzt durch ISO 2339 (DIN EN 22339)



Form - Ø x Länge (ohne Kuppen)

B 3	x	16	S	50	74,00A1
B 3	x	20	S	50	92,00A1
B 3	x	24	S	50	112,00A1
B 3	x	30	S	50	137,00A1
B 3	x	50	S	50	175,00A1
B 4	x	20	S	50	124,00A1
B 4	x	24	S	50	148,00A1
B 4	x	26	S	25	159,00A1
B 4	x	30	S	25	182,00A1
B 4	x	50	S	25	275,00A1
B 4	x	60	S	25	330,00A1
B 5	x	20	S	25	167,00A1
B 5	x	26	S	25	205,00A1
B 5	x	30	S	25	229,00A1
B 5	x	32	S	25	241,00A1
B 5	x	36	S	25	265,00A1
B 5	x	40	S	25	280,00A1
B 5	x	50	S	10	335,00A1
B 5	x	70	S	10	430,00A1
B 6	x	24	S	10	247,00A1
B 6	x	26	S	10	260,00A1
B 6	x	30	S	10	285,00A1
B 6	x	36	S	10	325,00A1
B 6	x	40	S	10	355,00A1
B 6	x	50	S	10	425,00A1
B 6	x	60	S	10	510,00A1
B 8	x	30	S	10	485,00A1
B 8	x	40	S	10	670,00A1
B 8	x	45	S	10	730,00A1
B 8	x	50	S	10	800,00A1
B 8	x	60	S	10	900,00A1
B 8	x	90	S	1	1200,00A1
B 8	x	100	S	1	1290,00A1
B 10	x	36	S	10	780,00A1
B 10	x	40	S	10	820,00A1
B 10	x	55	S	1	1010,00A1
B 10	x	60	S	1	1080,00A1
B 10	x	70	S	1	1180,00A1
B 10	x	80	S	1	1370,00A1
B 10	x	100	S	1	1560,00A1

Abmessungen	VE Stück	€/100/Obf.
DIN	00007.910	
7	A 1	m6

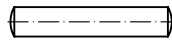

**Zylinderstifte,
Toleranzfeld m6**

Maße → **TI-116** Normumstellung → **TI-10**
 Werkstoffeigensch. → **TI-236**
 Stahl → **S. 64**
 DIN 7 → wird ersetzt durch ISO 2338

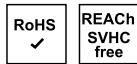

Ø - Tol. x Länge (ohne Kuppen)

0,8 m6	x	4	S	500	18,40A1
0,8 m6	x	8	S	500	20,30A1
0,8 m6	x	10	S	500	21,10A1
1 m6	x	3	S	500	13,30A1
1 m6	x	4	S	500	13,70A1
1 m6	x	5	S	500	14,40A1
1 m6	x	6	S	500	14,80A1
1 m6	x	8	S	500	15,20A1
1 m6	x	10	S	500	15,80A1
1 m6	x	12	S	500	16,50A1
1,5 m6	x	3	S	500	14,80A1
1,5 m6	x	4	S	500	15,20A1
1,5 m6	x	5	S	500	15,60A1
1,5 m6	x	6	S	500	15,90A1
1,5 m6	x	8	S	500	16,90A1
1,5 m6	x	10	S	500	17,60A1
1,5 m6	x	12	S	500	18,40A1
1,5 m6	x	14	S	500	19,20A1
1,5 m6	x	16	S	500	20,30A1
1,5 m6	x	20	S	500	33,50A1
2 m6	x	3	S	500	15,60A1
2 m6	x	4	S	500	16,30A1
2 m6	x	5	S	500	16,70A1
2 m6	x	6	S	500	17,10A1
2 m6	x	8	S	500	18,80A1
2 m6	x	10	S	500	19,50A1
2 m6	x	12	S	500	20,30A1
2 m6	x	14	S	500	21,10A1
2 m6	x	16	S	500	22,00A1
2 m6	x	18	S	500	22,90A1
2 m6	x	20	S	500	24,80A1
2,5 m6	x	4	S	500	18,40A1
2,5 m6	x	5	S	500	19,00A1
2,5 m6	x	6	S	500	19,50A1
2,5 m6	x	8	S	500	20,30A1
2,5 m6	x	10	S	500	21,10A1
2,5 m6	x	12	S	500	22,20A1
2,5 m6	x	14	S	500	26,00A1
2,5 m6	x	16	S	500	28,00A1
2,5 m6	x	18	S	500	30,50A1
2,5 m6	x	20	S	500	31,50A1
2,5 m6	x	24	S	500	37,50A1
3 m6	x	4	S	200	22,90A1
3 m6	x	5	S	200	23,70A1
3 m6	x	6	S	200	24,50A1
3 m6	x	8	S	200	26,00A1
3 m6	x	10	S	200	27,00A1
3 m6	x	12	S	200	28,50A1
3 m6	x	14	S	200	30,00A1
3 m6	x	16	S	200	30,50A1
3 m6	x	18	S	200	35,50A1
3 m6	x	20	S	200	37,50A1

Abmessungen	VE Stück	€/100/Obf.			
3 m6	x	24	S	200	43,00A1
3 m6	x	28	S	200	49,50A1
3 m6	x	30	S	200	55,00A1
3 m6	x	32	S	200	59,00A1
3 m6	x	40	S	200	105,00A1
3 m6	x	45	S	200	125,00A1
3 m6	x	50	S	200	148,00A1
3 m6	x	60	S	200	380,00A1
4 m6	x	5	S	200	33,00A1
4 m6	x	6	S	200	33,50A1
4 m6	x	8	S	200	36,00A1
4 m6	x	10	S	200	41,00A1
4 m6	x	12	S	200	44,50A1
4 m6	x	14	S	200	51,00A1
4 m6	x	16	S	200	53,00A1
4 m6	x	18	S	200	55,00A1
4 m6	x	20	S	200	61,00A1
4 m6	x	24	S	200	64,00A1
4 m6	x	26	S	200	69,00A1
4 m6	x	28	S	200	76,00A1
4 m6	x	32	S	200	87,00A1
4 m6	x	36	S	200	101,00A1
4 m6	x	40	S	200	106,00A1
4 m6	x	50	S	200	171,00A1
4 m6	x	60	S	200	250,00A1
5 m6	x	5	S	200	36,50A1
5 m6	x	6	S	200	38,50A1
5 m6	x	8	S	200	48,50A1
5 m6	x	10	S	200	49,50A1
5 m6	x	12	S	200	53,00A1
5 m6	x	14	S	200	56,00A1
5 m6	x	16	S	200	58,00A1
5 m6	x	18	S	200	69,00A1
5 m6	x	20	S	200	71,00A1
5 m6	x	24	S	200	77,00A1
5 m6	x	28	S	200	83,00A1
5 m6	x	30	S	200	88,00A1
5 m6	x	32	S	200	97,00A1
5 m6	x	36	S	200	106,00A1
5 m6	x	40	S	200	122,00A1
5 m6	x	45	S	200	141,00A1
5 m6	x	50	S	200	158,00A1
6 m6	x	6	S	200	62,00A1
6 m6	x	8	S	200	65,00A1
6 m6	x	10	S	200	69,00A1
6 m6	x	12	S	200	77,00A1
6 m6	x	14	S	200	80,00A1
6 m6	x	16	S	200	83,00A1
6 m6	x	18	S	200	85,00A1
6 m6	x	20	S	200	88,00A1
6 m6	x	24	S	200	112,00A1
6 m6	x	28	S	200	118,00A1
6 m6	x	30	S	200	135,00A1
6 m6	x	32	S	200	138,00A1
6 m6	x	36	S	200	145,00A1
6 m6	x	40	S	200	163,00A1
6 m6	x	45	S	100	175,00A1
6 m6	x	50	S	100	184,00A1
6 m6	x	55	S	100	199,00A1
6 m6	x	60	S	100	211,00A1
8 m6	x	10	S	100	116,00A1
8 m6	x	12	S	100	120,00A1
8 m6	x	14	S	100	125,00A1
8 m6	x	16	S	100	137,00A1
8 m6	x	18	S	100	144,00A1
8 m6	x	20	S	100	150,00A1
8 m6	x	24	S	100	158,00A1
8 m6	x	28	S	100	163,00A1
8 m6	x	30	S	100	178,00A1
8 m6	x	32	S	100	180,00A1
8 m6	x	36	S	100	228,00A1
8 m6	x	40	S	100	243,00A1
8 m6	x	45	S	100	260,00A1
8 m6	x	50	S	100	290,00A1
8 m6	x	55	S	100	320,00A1

Abmessungen	VE	Stück	€/100/Obf.
8 m6 x 60	S	100	340,00A1
8 m6 x 70	S	100	400,00A1
8 m6 x 80	S	100	485,00A1
10 m6 x 10	S	100	173,00A1
10 m6 x 12	S	100	178,00A1
10 m6 x 14	S	100	184,00A1
10 m6 x 16	S	100	190,00A1
10 m6 x 18	S	100	199,00A1
10 m6 x 20	S	100	247,00A1
10 m6 x 24	S	100	265,00A1
10 m6 x 28	S	100	300,00A1
10 m6 x 32	S	100	325,00A1
10 m6 x 36	S	100	345,00A1
10 m6 x 40	S	100	370,00A1
10 m6 x 45	S	50	395,00A1
10 m6 x 50	S	50	450,00A1
10 m6 x 55	S	50	495,00A1
10 m6 x 60	S	50	530,00A1
10 m6 x 70	S	50	590,00A1
10 m6 x 80	S	50	670,00A1
10 m6 x 90	S	50	740,00A1
10 m6 x 100	S	50	910,00A1
12 m6 x 16	S	50	375,00A1
12 m6 x 18	S	50	420,00A1
12 m6 x 20	S	50	450,00A1
12 m6 x 24	S	50	460,00A1
12 m6 x 30	S	50	580,00A1
12 m6 x 32	S	50	660,00A1
12 m6 x 40	S	50	790,00A1
12 m6 x 45	S	50	890,00A1
12 m6 x 50	S	50	970,00A1
12 m6 x 55	S	50	1060,00A1
12 m6 x 60	S	50	1140,00A1
12 m6 x 70	S	10	1350,00A1
12 m6 x 80	S	10	1480,00A1
12 m6 x 90	S	10	1650,00A1
12 m6 x 100	S	10	1800,00A1
16 m6 x 20	S	10	1120,00A1
16 m6 x 24	S	10	1160,00A1
16 m6 x 28	S	10	1290,00A1
16 m6 x 32	S	10	1590,00A1
16 m6 x 36	S	10	2200,00A1
16 m6 x 40	S	10	2370,00A1
16 m6 x 45	S	10	2700,00A1
16 m6 x 50	S	10	2950,00A1
16 m6 x 55	S	10	3250,00A1
16 m6 x 60	S	10	3450,00A1
16 m6 x 70	S	10	3850,00A1
16 m6 x 80	S	10	4100,00A1
16 m6 x 90	S	10	4350,00A1
16 m6 x 100	S	10	4600,00A1

Abmessungen	VE	Stück	€/100/Obf.
DIN		00007.940	
7	A 4		m6

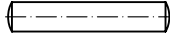

**Zylinderstifte,
Toleranzfeld m6**

Maße → **TI-116** Normumstellung → **TI-10**
 Werkstoffeigensch. → **TI-236**

Stahl → **S. 64**
 DIN 7 → wird ersetzt durch ISO 2338



∅ - Tol. x Länge (ohne Kuppen)

1 m6 x 3	S	500	25,00A4
1 m6 x 4	S	500	25,00A4
1 m6 x 5	S	500	25,00A4
1 m6 x 6	S	500	26,00A4
1 m6 x 8	S	500	26,50A4
1 m6 x 10	S	500	27,00A4
1 m6 x 12	S	500	27,00A4
1,5 m6 x 3	S	500	27,00A4
1,5 m6 x 4	S	500	27,00A4
1,5 m6 x 5	S	500	27,00A4
1,5 m6 x 6	S	500	28,00A4
1,5 m6 x 8	S	500	28,00A4
1,5 m6 x 10	S	500	30,00A4
1,5 m6 x 12	S	500	31,00A4
1,5 m6 x 14	S	500	32,50A4
1,5 m6 x 16	S	500	33,50A4
1,5 m6 x 18	S	500	47,00A4
1,5 m6 x 20	S	500	51,00A4
2 m6 x 4	S	500	28,50A4
2 m6 x 5	S	500	29,50A4
2 m6 x 6	S	500	30,00A4
2 m6 x 8	S	500	31,00A4
2 m6 x 10	S	500	33,00A4
2 m6 x 12	S	500	35,50A4
2 m6 x 14	S	500	37,50A4
2 m6 x 16	S	500	40,00A4
2 m6 x 18	S	500	47,00A4
2 m6 x 20	S	500	51,00A4
2 m6 x 24	S	500	58,00A4
2,5 m6 x 5	S	500	31,00A4
2,5 m6 x 6	S	500	33,00A4
2,5 m6 x 8	S	500	35,50A4
2,5 m6 x 10	S	500	37,50A4
2,5 m6 x 12	S	500	40,00A4
2,5 m6 x 14	S	500	42,00A4
2,5 m6 x 16	S	500	44,50A4
2,5 m6 x 20	S	500	51,00A4
2,5 m6 x 24	S	500	58,00A4
3 m6 x 4	S	500	34,50A4
3 m6 x 5	S	500	35,50A4
3 m6 x 6	S	500	38,50A4
3 m6 x 8	S	500	42,00A4
3 m6 x 10	S	500	45,00A4
3 m6 x 12	S	500	49,00A4
3 m6 x 14	S	500	55,00A4
3 m6 x 16	S	500	58,00A4
3 m6 x 18	S	500	66,00A4
3 m6 x 20	S	500	71,00A4
3 m6 x 24	S	500	77,00A4
3 m6 x 28	S	500	81,00A4
3 m6 x 30	S	500	86,00A4
3 m6 x 32	S	500	89,00A4

Abmessungen	VE	Stück	€/100/Obf.
4 m6 x 5	S	500	52,00A4
4 m6 x 6	S	500	58,00A4
4 m6 x 8	S	500	66,00A4
4 m6 x 10	S	500	73,00A4
4 m6 x 12	S	500	80,00A4
4 m6 x 14	S	500	86,00A4
4 m6 x 16	S	500	93,00A4
4 m6 x 18	S	500	107,00A4
4 m6 x 20	S	500	114,00A4
4 m6 x 24	S	200	128,00A4
4 m6 x 28	S	200	143,00A4
4 m6 x 30	S	200	149,00A4
4 m6 x 32	S	200	156,00A4
4 m6 x 36	S	200	172,00A4
4 m6 x 40	S	200	191,00A4
5 m6 x 6	S	500	64,00A4
5 m6 x 8	S	500	73,00A4
5 m6 x 10	S	500	82,00A4
5 m6 x 12	S	500	86,00A4
5 m6 x 14	S	200	94,00A4
5 m6 x 16	S	200	99,00A4
5 m6 x 18	S	200	107,00A4
5 m6 x 20	S	200	114,00A4
5 m6 x 24	S	200	128,00A4
5 m6 x 28	S	200	143,00A4
5 m6 x 30	S	200	149,00A4
5 m6 x 32	S	200	158,00A4
5 m6 x 36	S	200	170,00A4
5 m6 x 40	S	200	187,00A4
5 m6 x 45	S	200	206,00A4
5 m6 x 50	S	200	223,00A4
6 m6 x 6	S	100	106,00A4
6 m6 x 8	S	100	110,00A4
6 m6 x 10	S	100	114,00A4
6 m6 x 12	S	100	118,00A4
6 m6 x 14	S	100	122,00A4
6 m6 x 16	S	100	128,00A4
6 m6 x 18	S	100	158,00A4
6 m6 x 20	S	100	166,00A4
6 m6 x 24	S	100	183,00A4
6 m6 x 28	S	100	208,00A4
6 m6 x 30	S	100	210,00A4
6 m6 x 32	S	100	221,00A4
6 m6 x 36	S	100	242,00A4
6 m6 x 40	S	100	265,00A4
6 m6 x 45	S	100	285,00A4
6 m6 x 50	S	100	310,00A4
6 m6 x 55	S	100	330,00A4
6 m6 x 60	S	100	355,00A4
8 m6 x 10	S	100	172,00A4
8 m6 x 12	S	100	185,00A4
8 m6 x 14	S	100	202,00A4
8 m6 x 16	S	100	214,00A4
8 m6 x 18	S	100	229,00A4
8 m6 x 20	S	100	244,00A4
8 m6 x 24	S	100	275,00A4
8 m6 x 28	S	100	300,00A4
8 m6 x 30	S	100	310,00A4
8 m6 x 32	S	100	330,00A4
8 m6 x 36	S	100	355,00A4
8 m6 x 40	S	100	390,00A4
8 m6 x 45	S	100	425,00A4
8 m6 x 50	S	100	460,00A4
8 m6 x 55	S	100	500,00A4
8 m6 x 60	S	100	560,00A4
8 m6 x 70	S	100	670,00A4
8 m6 x 80	S	100	740,00A4
10 m6 x 12	S	50	330,00A4
10 m6 x 14	S	50	335,00A4
10 m6 x 16	S	50	340,00A4
10 m6 x 18	S	50	345,00A4
10 m6 x 20	S	50	355,00A4
10 m6 x 24	S	50	395,00A4
10 m6 x 28	S	50	445,00A4
10 m6 x 30	S	50	465,00A4



- ✓ Große Artikelvielfalt
- ✓ Verlässliche Qualität
- ✓ Hohe Lieferbereitschaft

Abmessungen	VE	Stück	€/100/Obf.
10 m6 x 32	S	50	485,00A4
10 m6 x 36	S	50	570,00A4
10 m6 x 40	S	50	610,00A4
10 m6 x 45	S	50	670,00A4
10 m6 x 50	S	50	730,00A4
10 m6 x 55	S	50	780,00A4
10 m6 x 60	S	50	830,00A4
10 m6 x 70	S	25	1000,00A4
10 m6 x 80	S	25	1100,00A4
10 m6 x 90	S	25	1220,00A4
10 m6 x 100	S	25	1310,00A4
12 m6 x 14	S	50	580,00A4
12 m6 x 16	S	50	590,00A4
12 m6 x 18	S	50	630,00A4
12 m6 x 20	S	50	690,00A4
12 m6 x 24	S	50	740,00A4
12 m6 x 28	S	50	830,00A4
12 m6 x 32	S	50	930,00A4
12 m6 x 36	S	50	1020,00A4
12 m6 x 40	S	50	1160,00A4
12 m6 x 45	S	50	1260,00A4
12 m6 x 50	S	10	1370,00A4
12 m6 x 55	S	10	1520,00A4
12 m6 x 60	S	10	1600,00A4
12 m6 x 70	S	10	1850,00A4
12 m6 x 80	S	10	2190,00A4
12 m6 x 100	S	10	2700,00A4
16 m6 x 20	S	10	1220,00A4
16 m6 x 24	S	10	1350,00A4
16 m6 x 28	S	10	1580,00A4
16 m6 x 32	S	10	1750,00A4
16 m6 x 36	S	10	1870,00A4
16 m6 x 40	S	10	2000,00A4
16 m6 x 45	S	10	2190,00A4
16 m6 x 50	S	10	2330,00A4
16 m6 x 55	S	10	2500,00A4
16 m6 x 60	S	10	2750,00A4
16 m6 x 70	S	10	3000,00A4
16 m6 x 80	S	10	3300,00A4
16 m6 x 90	S	10	3650,00A4
16 m6 x 100	S	10	3950,00A4

DIN	00084.914
84	A 1 gedreht

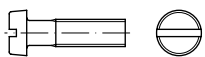

Zylinderschrauben mit Schlitz

Maße → **TI-37** Normumstellung → **TI-11**
 Werkstoffeigensch. → **TI-236**
 Stahl → **S. 65**
 Messing → **S. 611**
 DIN 84 → wird ersetzt durch ISO 1207 (austauschbar)



M 1,4 x 3	S	100	105,00A1
M 1,4 x 4	S	100	107,00A1
M 1,4 x 5	S	100	111,00A1
M 1,4 x 6	S	100	117,00A1
M 1,4 x 8	S	100	122,00A1
M 1,4 x 10	S	100	130,00A1
M 1,6 x 3	S	100	30,00A1
M 1,6 x 4	S	100	22,60A1
M 1,6 x 5	S	100	20,90A1
M 1,6 x 6	S	100	19,70A1

Abmessungen	VE	Stück	€/100/Obf.
M 1,6 x 8	S	100	21,80A1
M 1,6 x 10	S	100	24,10A1
M 1,6 x 12	S	100	33,00A1

DIN	00084.920
84	A 2

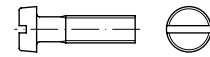

Zylinderschrauben mit Schlitz

zum Teil ab l = 60mm Teilgewinde

Maße → **TI-37** Normumstellung → **TI-11**
 Werkstoffeigensch. → **TI-236**
 Stahl → **S. 65**
 Messing, Kunststoff → **S. 611**
 DIN 84 → wird ersetzt durch ISO 1207 (austauschbar)



M 1 x 2	S	2000	285,00A2
M 1 x 3	S	2000	290,00A2
M 1 x 4	S	2000	295,00A2
M 1 x 5	S	2000	300,00A2
M 1 x 6	S	2000	310,00A2
M 1 x 8	S	2000	335,00A2
M 1 x 10	S	2000	370,00A2
M 1,2 x 2	S	2000	285,00A2
M 1,2 x 3	S	2000	290,00A2
M 1,2 x 4	S	2000	295,00A2
M 1,2 x 5	S	2000	300,00A2
M 1,2 x 6	S	2000	335,00A2
M 1,2 x 8	S	2000	370,00A2
M 1,2 x 10	S	2000	430,00A2
M 1,2 x 12	S	2000	485,00A2
M 1,4 x 2	S	2000	285,00A2
M 1,4 x 3	S	2000	290,00A2
M 1,4 x 4	S	2000	295,00A2
M 1,4 x 5	S	2000	300,00A2
M 1,4 x 6	S	2000	335,00A2
M 1,4 x 8	S	2000	370,00A2
M 1,4 x 10	S	2000	430,00A2
M 1,4 x 12	S	2000	485,00A2
M 1,6 x 2	S	2000	285,00A2
M 1,6 x 3	S	2000	290,00A2
M 1,6 x 4	S	2000	295,00A2
M 1,6 x 5	S	2000	300,00A2
M 1,6 x 6	S	2000	335,00A2
M 1,6 x 8	S	2000	370,00A2
M 1,6 x 10	S	2000	430,00A2
M 1,6 x 12	S	2000	485,00A2
M 1,6 x 16	S	2000	560,00A2
M 2 x 3	S	1000	7,10A2
M 2 x 4	S	1000	7,20A2
M 2 x 5	S	1000	7,30A2
M 2 x 6	S	1000	7,40A2
M 2 x 8	S	1000	7,80A2
M 2 x 10	S	1000	8,50A2
M 2 x 12	S	1000	9,50A2
M 2 x 16	S	1000	10,30A2
M 2 x 20	S	1000	17,10A2
M 2,5 x 3	S	1000	7,10A2
M 2,5 x 4	S	1000	7,20A2
M 2,5 x 5	S	1000	7,30A2
M 2,5 x 6	S	1000	7,40A2
M 2,5 x 8	S	1000	7,80A2
M 2,5 x 10	S	1000	8,50A2

Abmessungen	VE	Stück	€/100/Obf.
M 2,5 x 12	S	1000	9,50A2
M 2,5 x 16	S	1000	10,30A2
M 2,5 x 18	S	1000	19,00A2
M 2,5 x 20	S	1000	21,00A2
M 2,5 x 22	S	1000	25,50A2
M 2,5 x 25	S	1000	26,50A2
M 2,5 x 30	S	1000	28,50A2
M 2,5 x 35	S	1000	52,00A2
M 2,5 x 40	S	1000	97,00A2
M 3 x 3	S	1000	19,00A2
M 3 x 4	S	1000	11,60A2
M 3 x 5	S	1000	7,80A2
M 3 x 5	K	200	9,70A2
M 3 x 6	S	1000	5,30A2
M 3 x 6	K	200	7,10A2
M 3 x 8	S	1000	4,55A2
M 3 x 8	K	200	6,50A2
M 3 x 10	S	1000	4,75A2
M 3 x 10	K	200	6,70A2
M 3 x 12	S	1000	5,20A2
M 3 x 12	K	200	7,10A2
M 3 x 14	S	1000	7,40A2
M 3 x 14	K	200	9,30A2
M 3 x 16	S	1000	7,60A2
M 3 x 16	K	200	9,60A2
M 3 x 18	S	1000	8,20A2
M 3 x 18	K	200	10,10A2
M 3 x 20	S	1000	9,00A2
M 3 x 20	K	200	11,20A2
M 3 x 22	S	1000	11,10A2
M 3 x 22	K	200	13,00A2
M 3 x 25	S	1000	11,40A2
M 3 x 25	K	200	13,50A2
M 3 x 30	S	1000	12,10A2
M 3 x 30	K	200	14,00A2
M 3 x 35	S	1000	17,60A2
M 3 x 40	K	200	23,80A2
M 3 x 45	S	500	34,50A2
M 3 x 50	K	200	69,00A2
M 3 x 55	K	200	133,00A2
M 3,5 x 6	K	200	38,00A2
M 3,5 x 8	K	200	31,00A2
M 3,5 x 10	K	200	30,50A2
M 3,5 x 12	K	200	32,00A2
M 3,5 x 16	K	200	34,00A2
M 3,5 x 20	K	200	41,00A2
M 3,5 x 25	K	200	62,00A2
M 4 x 4	K	200	21,80A2
M 4 x 5	S	1000	12,50A2
M 4 x 5	K	200	14,40A2
M 4 x 6	S	1000	8,20A2
M 4 x 6	K	200	10,10A2
M 4 x 8	S	1000	8,20A2
M 4 x 8	K	200	10,10A2
M 4 x 10	S	1000	6,70A2
M 4 x 10	K	200	8,60A2
M 4 x 12	S	1000	7,20A2
M 4 x 12	K	200	9,10A2
M 4 x 14	S	1000	10,60A2
M 4 x 16	S	1000	10,90A2
M 4 x 16	K	200	10,10A2
M 4 x 18	S	1000	11,20A2
M 4 x 18	K	200	13,60A2
M 4 x 20	S	1000	11,60A2
M 4 x 20	K	200	14,80A2
M 4 x 22	K	200	17,40A2
M 4 x 25	S	500	12,10A2
M 4 x 25	K	200	18,80A2
M 4 x 30	S	500	12,50A2
M 4 x 30	K	200	19,40A2
M 4 x 35	S	500	21,80A2
M 4 x 35	K	100	23,00A2
M 4 x 40	K	100	28,50A2
M 4 x 45	K	100	31,50A2
M 4 x 50	K	100	41,00A2

Abmessungen	VE	Stück	€/100/Obf.	Abmessungen	VE	Stück	€/100/Obf.	Abmessungen	VE	Stück	€/100/Obf.
M 4 x 55	K	100	57,00A2	M 8 x 30	K	50	57,00A2	M 2,5 x 5	K	200	10,20A4
M 4 x 60	K	100	61,00A2	M 8 x 35	S	100	58,00A2	M 2,5 x 6	S	1000	8,20A4
M 4 x 70	K	100	66,00A2	M 8 x 35	K	50	66,00A2	M 2,5 x 6	K	200	10,30A4
M 4 x 80	K	100	82,00A2	M 8 x 40	S	100	67,00A2	M 2,5 x 8	S	1000	8,70A4
M 4 x 90	K	100	115,00A2	M 8 x 40	K	50	74,00A2	M 2,5 x 8	K	200	10,70A4
M 4 x 100	K	100	165,00A2	M 8 x 50	S	100	87,00A2	M 2,5 x 10	S	1000	9,40A4
M 5 x 6	S	500	17,10A2	M 8 x 50	K	50	95,00A2	M 2,5 x 10	K	200	11,50A4
M 5 x 8	S	500	12,10A2	M 8 x 60	K	50	116,00A2	M 2,5 x 12	S	1000	10,50A4
M 5 x 8	K	200	14,00A2	M 8 x 70	K	50	135,00A2	M 2,5 x 12	K	200	12,60A4
M 5 x 10	S	500	10,00A2	M 8 x 80	K	50	147,00A2	M 2,5 x 14	K	200	13,60A4
M 5 x 10	K	200	11,90A2	M 8 x 90	K	50	163,00A2	M 2,5 x 16	S	1000	11,50A4
M 5 x 12	S	500	10,90A2	M 8 x 100	K	50	176,00A2	M 2,5 x 16	K	200	17,10A4
M 5 x 12	K	200	12,80A2	M 10 x 12	K	50	95,00A2	M 2,5 x 18	K	200	18,40A4
M 5 x 14	K	200	15,90A2	M 10 x 16	K	50	92,00A2	M 2,5 x 20	S	1000	16,30A4
M 5 x 16	S	500	12,20A2	M 10 x 20	K	50	73,00A2	M 2,5 x 20	K	200	19,20A4
M 5 x 16	K	200	16,20A2	M 10 x 25	K	50	81,00A2	M 2,5 x 22	K	200	35,50A4
M 5 x 18	S	500	13,20A2	M 10 x 30	K	50	88,00A2	M 2,5 x 25	K	200	37,50A4
M 5 x 18	K	200	16,50A2	M 10 x 35	K	50	98,00A2	M 3 x 3	S	1000	22,50A4
M 5 x 20	S	500	13,80A2	M 10 x 40	K	50	106,00A2	M 3 x 3	K	200	24,60A4
M 5 x 20	K	200	16,80A2	M 10 x 45	K	50	126,00A2	M 3 x 4	S	1000	14,40A4
M 5 x 22	K	200	17,00A2	M 10 x 50	K	50	148,00A2	M 3 x 4	K	200	16,50A4
M 5 x 25	S	500	15,40A2	M 10 x 60	K	50	194,00A2	M 3 x 5	S	1000	11,50A4
M 5 x 25	K	200	17,30A2	M 10 x 70	K	25	218,00A2	M 3 x 5	K	200	13,60A4
M 5 x 30	S	500	18,90A2	M 10 x 80	K	25	235,00A2	M 3 x 6	S	1000	7,30A4
M 5 x 30	K	200	20,80A2	M 10 x 90	K	25	260,00A2	M 3 x 6	K	200	9,40A4
M 5 x 35	S	200	20,70A2	M 10 x 100	K	25	280,00A2	M 3 x 8	S	1000	6,70A4
M 5 x 35	K	100	24,60A2					M 3 x 8	K	200	8,80A4
M 5 x 40	S	200	28,50A2					M 3 x 10	S	1000	6,10A4
M 5 x 40	K	100	32,00A2					M 3 x 10	K	200	8,20A4
M 5 x 45	K	100	36,50A2					M 3 x 12	S	1000	6,80A4
M 5 x 50	K	100	45,00A2					M 3 x 12	K	200	8,90A4
M 5 x 55	K	100	71,00A2					M 3 x 14	K	200	9,50A4
M 5 x 60	K	100	73,00A2					M 3 x 16	S	1000	7,40A4
M 5 x 70	K	100	77,00A2					M 3 x 16	K	200	10,50A4
M 5 x 80	K	100	83,00A2					M 3 x 18	K	200	12,50A4
M 5 x 90	K	100	118,00A2					M 3 x 20	S	1000	8,30A4
M 5 x 100	S	100	241,00A2					M 3 x 20	K	200	14,40A4
M 6 x 8	K	100	19,50A2					M 3 x 22	K	200	15,80A4
M 6 x 10	S	200	15,70A2					M 3 x 25	S	1000	11,20A4
M 6 x 10	K	100	19,50A2					M 3 x 25	K	200	16,30A4
M 6 x 12	S	200	13,40A2					M 3 x 30	S	1000	15,60A4
M 6 x 12	K	100	17,30A2					M 3 x 30	K	200	17,70A4
M 6 x 16	S	200	15,10A2					M 3 x 35	S	500	28,00A4
M 6 x 16	K	100	19,00A2					M 3 x 35	K	100	32,00A4
M 6 x 18	S	200	16,10A2					M 3 x 40	S	500	33,50A4
M 6 x 18	K	100	20,00A2					M 3 x 40	K	100	38,00A4
M 6 x 20	S	200	16,50A2					M 3 x 50	S	500	61,00A4
M 6 x 20	K	100	20,40A2					M 3 x 50	K	100	65,00A4
M 6 x 25	S	200	18,90A2					M 3 x 55	K	100	98,00A4
M 6 x 25	K	100	22,80A2					M 3 x 60	K	100	120,00A4
M 6 x 30	S	200	21,40A2					M 3,5 x 6	K	100	53,00A4
M 6 x 30	K	100	25,50A2					M 3,5 x 8	K	200	41,50A4
M 6 x 35	S	100	24,30A2					M 3,5 x 10	K	200	40,50A4
M 6 x 35	K	50	32,00A2					M 3,5 x 20	S	500	59,00A4
M 6 x 40	S	100	27,50A2					M 3,5 x 20	K	200	63,00A4
M 6 x 40	K	50	35,50A2					M 4 x 4	K	200	27,00A4
M 6 x 45	S	100	34,00A2					M 4 x 5	S	1000	15,90A4
M 6 x 45	K	50	41,50A2					M 4 x 5	K	200	18,00A4
M 6 x 50	K	50	67,00A2					M 4 x 6	S	1000	10,60A4
M 6 x 60	K	50	82,00A2					M 4 x 6	K	200	12,70A4
M 6 x 70	K	50	90,00A2					M 4 x 8	S	1000	10,30A4
M 6 x 75	K	50	96,00A2					M 4 x 8	K	200	12,40A4
M 6 x 80	K	50	99,00A2					M 4 x 10	S	1000	9,10A4
M 6 x 90	K	50	108,00A2					M 4 x 10	K	200	11,20A4
M 6 x 100	K	50	116,00A2					M 4 x 12	S	1000	9,70A4
M 8 x 10	K	50	67,00A2					M 4 x 12	K	200	11,80A4
M 8 x 12	S	100	43,50A2					M 4 x 16	S	1000	11,20A4
M 8 x 12	K	50	52,00A2					M 4 x 16	K	200	13,30A4
M 8 x 16	S	100	40,00A2					M 4 x 18	S	1000	12,10A4
M 8 x 16	K	50	47,50A2					M 4 x 18	K	200	17,90A4
M 8 x 20	S	100	41,00A2					M 4 x 20	S	1000	13,60A4
M 8 x 20	K	50	48,50A2					M 4 x 20	K	200	19,20A4
M 8 x 25	S	100	43,50A2					M 4 x 22	K	200	21,50A4
M 8 x 25	K	50	52,00A2					M 4 x 25	S	500	14,80A4
M 8 x 30	S	100	48,50A2					M 4 x 25	K	200	22,90A4
M 2 x 3	S	1000	8,20A4								
M 2 x 3	K	200	10,30A4								
M 2 x 4	S	1000	8,00A4								
M 2 x 4	K	200	10,10A4								
M 2 x 5	S	1000	8,10A4								
M 2 x 5	K	200	10,20A4								
M 2 x 6	S	1000	8,20A4								
M 2 x 6	K	200	10,30A4								
M 2 x 8	S	1000	8,70A4								
M 2 x 8	K	200	10,70A4								
M 2 x 10	S	1000	9,40A4								
M 2 x 10	K	200	11,50A4								
M 2 x 12	S	1000	10,50A4								
M 2 x 12	K	200	12,60A4								
M 2 x 16	S	1000	11,50A4								
M 2 x 16	K	200	13,60A4								
M 2 x 20	S	1000	16,40A4								
M 2 x 20	K	200	18,50A4								
M 2 x 25	K	200	31,50A4								
M 2,5 x 3	S	1000	8,20A4								
M 2,5 x 3	K	200	10,30A4								
M 2,5 x 4	S	1000	8,00A4								
M 2,5 x 4	K	200	10,10A4								
M 2,5 x 5	S	1000	8,10A4								

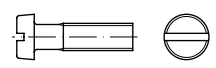
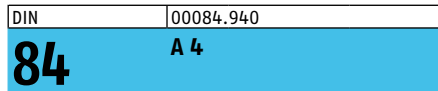

Zylinderschrauben mit Schlitz
zum Teil ab l = 60mm Teilgewinde

Maße → **TI-37** Normumstellung → **TI-11**
 Werkstoffeigensch. → **TI-236**
 Stahl → **S. 65**
 Messing, Kunststoff → **S. 611**
 DIN 84 → wird ersetzt durch ISO 1207 (austauschbar)



Abmessungen	VE	Stück	€/100/Obf.
M 4 x 30	S	500	16,80A4
M 4 x 30	K	200	24,90A4
M 4 x 35	S	500	24,00A4
M 4 x 35	K	100	28,50A4
M 4 x 40	S	500	30,00A4
M 4 x 40	K	100	34,00A4
M 4 x 45	K	100	40,00A4
M 4 x 50	S	500	42,00A4
M 4 x 50	K	100	46,50A4
M 4 x 55	K	100	72,00A4
M 4 x 60	K	100	75,00A4
M 4 x 70	K	100	89,00A4
M 4 x 80	K	100	95,00A4
M 5 x 6	S	500	18,30A4
M 5 x 6	K	200	20,40A4
M 5 x 8	S	500	17,70A4
M 5 x 8	K	200	19,80A4
M 5 x 10	S	500	15,60A4
M 5 x 10	K	200	17,70A4
M 5 x 12	S	500	15,30A4
M 5 x 12	K	200	17,40A4
M 5 x 16	S	500	17,00A4
M 5 x 16	K	200	19,10A4
M 5 x 18	K	200	20,50A4
M 5 x 20	S	500	19,20A4
M 5 x 20	K	200	21,30A4
M 5 x 25	S	500	21,40A4
M 5 x 25	K	200	23,50A4
M 5 x 30	S	500	26,50A4
M 5 x 30	K	200	28,50A4
M 5 x 35	S	200	29,00A4
M 5 x 35	K	100	33,50A4
M 5 x 40	S	200	43,50A4
M 5 x 40	K	100	48,00A4
M 5 x 45	K	100	51,00A4
M 5 x 50	S	200	49,00A4
M 5 x 50	K	100	54,00A4
M 5 x 60	K	100	94,00A4
M 5 x 70	K	100	108,00A4
M 5 x 80	K	100	122,00A4
M 5 x 100	K	100	150,00A4
M 6 x 8	S	200	22,90A4
M 6 x 8	K	100	27,50A4
M 6 x 10	S	200	21,90A4
M 6 x 10	K	100	26,50A4
M 6 x 12	S	200	19,60A4
M 6 x 12	K	100	23,90A4
M 6 x 16	S	200	21,90A4
M 6 x 16	K	100	26,50A4
M 6 x 18	K	100	36,00A4
M 6 x 20	S	200	24,20A4
M 6 x 20	K	100	37,50A4
M 6 x 22	K	100	38,50A4
M 6 x 25	S	200	27,50A4
M 6 x 25	K	100	41,00A4
M 6 x 30	S	200	31,50A4
M 6 x 30	K	100	43,00A4
M 6 x 35	S	100	36,00A4
M 6 x 35	K	50	44,50A4
M 6 x 40	S	100	53,00A4
M 6 x 40	K	50	62,00A4
M 6 x 45	K	50	70,00A4
M 6 x 50	S	100	67,00A4
M 6 x 50	K	50	76,00A4
M 6 x 60	K	50	100,00A4
M 6 x 70	K	50	128,00A4
M 6 x 75	K	50	149,00A4
M 6 x 80	K	50	160,00A4
M 8 x 10	S	100	76,00A4
M 8 x 10	K	50	84,00A4
M 8 x 12	S	100	59,00A4
M 8 x 12	K	50	68,00A4
M 8 x 16	S	100	52,00A4
M 8 x 16	K	50	60,00A4
M 8 x 20	S	100	54,00A4

Abmessungen	VE	Stück	€/100/Obf.
M 8 x 20	K	50	63,00A4
M 8 x 25	S	100	60,00A4
M 8 x 25	K	50	68,00A4
M 8 x 30	S	100	66,00A4
M 8 x 30	K	50	75,00A4
M 8 x 35	S	100	79,00A4
M 8 x 35	K	50	88,00A4
M 8 x 40	S	100	88,00A4
M 8 x 40	K	50	97,00A4
M 8 x 45	K	50	116,00A4
M 8 x 50	S	100	125,00A4
M 8 x 50	K	50	133,00A4
M 8 x 55	K	50	160,00A4
M 8 x 60	K	50	180,00A4
M 8 x 70	K	50	217,00A4
M 10 x 16	K	50	148,00A4
M 10 x 20	K	50	101,00A4
M 10 x 25	K	50	110,00A4
M 10 x 30	K	50	125,00A4
M 10 x 35	K	50	133,00A4
M 10 x 40	K	50	145,00A4
M 10 x 50	K	50	206,00A4
M 10 x 60	K	50	250,00A4
M 10 x 65	K	50	350,00A4
M 10 x 70	K	50	400,00A4

DIN	00085.920
85	A 2

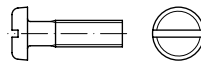

Flachkopfschrauben mit Schlitz

Maße → **TI-37** Normumstellung → **TI-11**
 Werkstoffeigensch. → **TI-236**
 Stahl → **S. 67**
 Messing, Kunststoff → **S. 612**

DIN 85 → wird ersetzt durch ISO 1580 (austauschbar)



M 3 x 4	S	1000	17,10A2
M 3 x 5	S	1000	11,60A2
M 3 x 6	S	1000	6,40A2
M 3 x 6	K	200	8,30A2
M 3 x 8	S	1000	5,90A2
M 3 x 8	K	200	7,80A2
M 3 x 10	S	1000	5,60A2
M 3 x 10	K	200	7,50A2
M 3 x 12	S	1000	6,10A2
M 3 x 12	K	200	8,00A2
M 3 x 14	S	1000	6,70A2
M 3 x 16	S	1000	6,90A2
M 3 x 16	K	200	8,80A2
M 3 x 20	S	1000	7,60A2
M 3 x 20	K	200	9,50A2
M 3 x 25	K	200	10,20A2
M 3 x 30	S	500	17,10A2
M 3 x 35	K	200	13,10A2
M 4 x 5	S	1000	17,10A2
M 4 x 5	K	200	20,80A2
M 4 x 6	S	1000	11,40A2
M 4 x 8	S	1000	9,10A2
M 4 x 8	K	200	11,00A2
M 4 x 10	S	1000	8,30A2
M 4 x 10	K	200	10,20A2
M 4 x 12	S	1000	8,50A2
M 4 x 12	K	200	10,40A2

Abmessungen	VE	Stück	€/100/Obf.
M 4 x 16	S	1000	9,10A2
M 4 x 16	K	200	11,00A2
M 4 x 20	S	1000	9,50A2
M 4 x 20	K	200	11,40A2
M 4 x 25	S	500	11,40A2
M 4 x 25	K	200	13,30A2
M 4 x 30	S	500	12,70A2
M 4 x 35	S	500	17,10A2
M 4 x 40	S	500	20,90A2
M 4 x 50	S	500	36,00A2
M 4 x 60	S	500	42,50A2
M 5 x 6	S	500	22,20A2
M 5 x 6	K	100	26,50A2
M 5 x 8	S	500	19,40A2
M 5 x 8	K	200	21,20A2
M 5 x 10	S	500	15,20A2
M 5 x 10	K	200	17,10A2
M 5 x 12	S	500	11,40A2
M 5 x 12	K	200	13,30A2
M 5 x 16	S	500	12,70A2
M 5 x 16	K	200	14,60A2
M 5 x 20	S	500	14,10A2
M 5 x 20	K	200	16,00A2
M 5 x 25	S	500	16,10A2
M 5 x 25	K	100	20,00A2
M 5 x 30	S	500	19,20A2
M 5 x 30	K	100	23,00A2
M 5 x 35	S	500	27,00A2
M 5 x 40	K	100	34,50A2
M 5 x 45	S	500	37,50A2
M 5 x 50	S	500	46,00A2
M 5 x 60	S	500	55,00A2
M 5 x 70	S	200	67,00A2
M 5 x 80	S	200	95,00A2
M 6 x 8	S	500	22,80A2
M 6 x 10	S	200	17,00A2
M 6 x 10	K	100	20,90A2
M 6 x 12	S	200	15,60A2
M 6 x 12	K	100	19,40A2
M 6 x 16	S	200	16,70A2
M 6 x 16	K	100	20,60A2
M 6 x 20	S	200	18,50A2
M 6 x 20	K	100	22,40A2
M 6 x 25	S	200	20,70A2
M 6 x 25	K	100	24,60A2
M 6 x 30	S	200	24,10A2
M 6 x 30	K	100	28,00A2
M 6 x 35	S	200	33,50A2
M 6 x 40	K	100	35,00A2
M 6 x 45	K	100	40,00A2
M 6 x 50	K	50	81,00A2
M 6 x 60	S	200	124,00A2
M 6 x 70	S	200	148,00A2
M 6 x 80	S	200	180,00A2

- ✓ Große Artikelvielfalt
- ✓ Verlässliche Qualität
- ✓ Hohe Lieferbereitschaft

Abmessungen	VE Stück	€/100/Obf.
DIN	00085.940	
85	A 4	

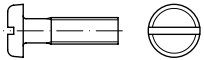

Flachkopfschrauben mit Schlitz

Maße → **TI-37** Normumstellung → **TI-11**
 Werkstoffeigensch. → **TI-236**
 Stahl → **S. 67**
 Messing, Kunststoff → **S. 612**
 DIN 85 → wird ersetzt durch ISO 1580 (austauschbar)

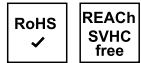

M 2	x	3	S	1000	74,00A4
M 2	x	4	S	1000	42,00A4
M 2	x	5	S	1000	41,50A4
M 2	x	6	S	1000	36,00A4
M 2	x	8	S	1000	38,00A4
M 2	x	10	S	1000	40,00A4
M 2	x	12	S	1000	42,00A4
M 2	x	16	S	1000	53,00A4
M 2	x	20	S	1000	59,00A4
M 2	x	25	S	1000	76,00A4
M 2	x	30	S	1000	95,00A4
M 2,5	x	3	S	1000	84,00A4
M 2,5	x	4	S	1000	68,00A4
M 2,5	x	5	S	1000	59,00A4
M 2,5	x	6	S	1000	61,00A4
M 2,5	x	8	S	1000	63,00A4
M 2,5	x	10	S	1000	66,00A4
M 2,5	x	12	S	1000	68,00A4
M 2,5	x	16	S	1000	74,00A4
M 2,5	x	20	S	1000	89,00A4
M 2,5	x	25	S	1000	105,00A4
M 2,5	x	30	S	1000	137,00A4
M 3	x	5	S	1000	14,50A4
M 3	x	5	K	200	16,60A4
M 3	x	6	S	1000	9,10A4
M 3	x	6	K	200	11,20A4
M 3	x	8	S	1000	8,40A4
M 3	x	8	K	200	10,50A4
M 3	x	10	S	1000	8,00A4
M 3	x	10	K	200	10,10A4
M 3	x	12	S	1000	8,40A4
M 3	x	12	K	200	10,50A4
M 3	x	16	S	1000	9,70A4
M 3	x	16	K	200	11,80A4
M 3	x	20	S	1000	10,30A4
M 3	x	20	K	200	12,40A4
M 3	x	25	K	100	13,30A4
M 3	x	30	K	100	17,60A4
M 4	x	5	S	1000	23,80A4
M 4	x	5	K	200	26,00A4
M 4	x	6	S	1000	13,50A4
M 4	x	6	K	200	15,60A4
M 4	x	8	S	1000	12,80A4
M 4	x	8	K	200	14,90A4
M 4	x	10	S	1000	11,80A4
M 4	x	10	K	200	13,90A4
M 4	x	12	S	1000	11,60A4
M 4	x	12	K	200	13,70A4
M 4	x	16	S	1000	13,20A4
M 4	x	16	K	200	15,30A4
M 4	x	20	S	1000	15,00A4
M 4	x	20	K	200	17,10A4
M 4	x	25	K	200	19,30A4

Abmessungen	VE Stück	€/100/Obf.
M 4 x 30	K 100	24,50A4
M 4 x 35	K 100	37,00A4
M 4 x 40	K 100	41,50A4
M 4 x 45	K 100	54,00A4
M 4 x 50	K 100	50,00A4
M 5 x 8	S 500	24,20A4
M 5 x 8	K 200	28,50A4
M 5 x 10	S 500	19,60A4
M 5 x 10	K 200	21,70A4
M 5 x 12	S 500	18,60A4
M 5 x 12	K 200	20,70A4
M 5 x 16	S 500	20,60A4
M 5 x 16	K 200	22,70A4
M 5 x 20	S 500	23,50A4
M 5 x 20	K 200	26,00A4
M 5 x 25	S 500	26,50A4
M 5 x 25	K 100	31,00A4
M 5 x 30	S 500	32,00A4
M 5 x 30	K 100	36,00A4
M 5 x 40	K 100	49,00A4
M 5 x 50	K 100	102,00A4
M 6 x 8	K 100	42,00A4
M 6 x 10	S 200	26,50A4
M 6 x 10	K 100	31,00A4
M 6 x 12	S 200	24,00A4
M 6 x 12	K 100	28,50A4
M 6 x 16	S 200	26,50A4
M 6 x 16	K 100	31,00A4
M 6 x 20	S 200	30,00A4
M 6 x 20	K 100	34,00A4
M 6 x 25	S 200	33,00A4
M 6 x 25	K 100	37,00A4
M 6 x 30	S 200	41,50A4
M 6 x 30	K 100	45,50A4
M 6 x 35	K 50	48,00A4
M 6 x 40	K 50	53,00A4
M 6 x 50	K 50	116,00A4
M 8 x 10	K 50	98,00A4
M 8 x 12	K 50	94,00A4
M 8 x 16	K 50	96,00A4
M 8 x 20	K 50	98,00A4
M 8 x 25	K 50	103,00A4

~DIN	00093.920
93	A 2

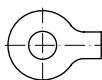

Scheiben mit Lappen

Maße → **TI-88** Schraubensicherung → **TI-256**
 Werkstoffeigensch. → **TI-236**
 Stahl → **S. 68**

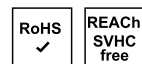

4,3	S	50	120,00A2
5,3	S	50	93,00A2
6,4	S	50	108,00A2
8,4	S	25	142,00A2
10,5	S	25	180,00A2
13	S	25	224,00A2
17	S	10	330,00A2
21	S	10	395,00A2
25	S	10	510,00A2
28	S	1	710,00A2
31	S	1	900,00A2
37	S	1	1480,00A2

Abmessungen	VE Stück	€/100/Obf.
~DIN	00093.940	
93	A 4	

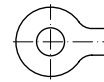

Scheiben mit Lappen

Maße → **TI-88** Schraubensicherung → **TI-256**
 Werkstoffeigensch. → **TI-236**
 Stahl → **S. 68**

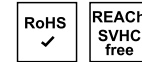

5,3	S	50	141,00A4
6,4	S	50	162,00A4
8,4	S	25	212,00A4
10,5	S	25	275,00A4
13	S	25	345,00A4
17	S	10	540,00A4
21	S	10	620,00A4
25	S	10	780,00A4
28	S	1	970,00A4
31	S	1	1390,00A4
37	S	1	2120,00A4
43	S	1	2460,00A4

DIN	00094.300
94	A 2



Splinte

Maße → **TI-22** Normumstellung → **TI-10**
 Werkstoffeigensch. → **TI-236**
 Stahl → **S. 69**
 Messing, Kupfer → **S. 613**

DIN 94 → wird ersetzt durch ISO 1234

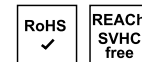

Nenn Ø = Bohrungs Ø x Länge

1	x	8	S	1000	6,90A2
1	x	10	S	1000	7,00A2
1	x	16	S	1000	7,10A2
1	x	20	S	1000	7,20A2
1	x	25	S	1000	8,40A2
1	x	32	S	1000	11,40A2
1,6	x	8	S	1000	8,10A2
1,6	x	10	S	1000	8,20A2
1,6	x	12	S	1000	8,30A2
1,6	x	16	S	1000	8,40A2
1,6	x	20	S	1000	8,50A2
1,6	x	25	S	1000	9,90A2
1,6	x	32	S	1000	11,40A2
2	x	10	S	1000	11,00A2
2	x	12	S	1000	11,20A2
2	x	14	S	1000	11,40A2
2	x	16	S	1000	11,60A2
2	x	20	S	1000	11,80A2
2	x	25	S	1000	13,70A2
2	x	32	S	1000	16,30A2

Abmessungen	VE	Stück	€/100/Obf.
2 x 40	S	1000	19,00A2
2,5 x 12	S	500	18,40A2
2,5 x 16	S	500	18,90A2
2,5 x 20	S	500	19,90A2
2,5 x 25	S	500	23,30A2
2,5 x 32	S	500	28,50A2
2,5 x 36	S	500	31,00A2
2,5 x 40	S	500	34,00A2
2,5 x 45	S	500	37,50A2
2,5 x 50	S	500	40,50A2
3,2 x 16	S	500	26,00A2
3,2 x 20	S	500	28,00A2
3,2 x 25	S	500	32,00A2
3,2 x 32	S	500	38,50A2
3,2 x 36	S	500	42,50A2
3,2 x 40	S	500	46,00A2
3,2 x 45	S	500	52,00A2
3,2 x 50	S	500	55,00A2
4 x 20	S	500	44,00A2
4 x 25	S	500	52,00A2
4 x 28	S	500	53,00A2
4 x 32	S	500	62,00A2
4 x 36	S	500	68,00A2
4 x 40	S	500	73,00A2
4 x 45	S	500	80,00A2
4 x 50	S	500	88,00A2
4 x 63	S	500	114,00A2
5 x 25	S	250	75,00A2
5 x 28	S	250	76,00A2
5 x 32	S	250	90,00A2
5 x 36	S	250	99,00A2
5 x 40	S	250	106,00A2
5 x 45	S	250	118,00A2
5 x 50	S	250	127,00A2
5 x 56	S	250	141,00A2
5 x 63	S	250	156,00A2
5 x 71	S	250	173,00A2
5 x 80	S	250	180,00A2
6,3 x 32	S	250	129,00A2
6,3 x 36	S	250	141,00A2
6,3 x 40	S	250	152,00A2
6,3 x 45	S	250	180,00A2
6,3 x 50	S	250	185,00A2
6,3 x 56	S	250	199,00A2
6,3 x 63	S	250	220,00A2
6,3 x 71	S	250	243,00A2
6,3 x 80	S	250	270,00A2
8 x 36	S	100	285,00A2
8 x 45	S	100	310,00A2
8 x 50	S	100	335,00A2
8 x 56	S	100	365,00A2
8 x 63	S	100	400,00A2
8 x 71	S	100	440,00A2
8 x 80	S	100	485,00A2
10 x 63	S	50	590,00A2
10 x 71	S	50	710,00A2
10 x 80	S	50	770,00A2
10 x 100	S	25	930,00A2

Abmessungen	VE	Stück	€/100/Obf.
DIN 94		00094.940	A 4

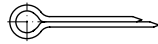

Splinte

Maße → **TI-22** Normumstellung → **TI-10**
 Werkstoffeigensch. → **TI-236**
 Stahl → **S. 69**
 Messing, Kupfer → **S. 613**
 DIN 94 → wird ersetzt durch ISO 1234



Nenn Ø = Bohrungs Ø x Länge

1 x 16	K	100	13,50A4
1 x 20	K	100	15,60A4
1,6 x 10	K	100	13,90A4
1,6 x 12	K	100	14,90A4
1,6 x 16	K	100	18,90A4
1,6 x 20	K	100	23,80A4
1,6 x 25	K	100	27,50A4
1,6 x 32	K	100	31,00A4
2 x 10	K	100	19,30A4
2 x 16	K	100	23,10A4
2 x 20	K	100	27,50A4
2 x 25	K	100	32,00A4
2 x 32	K	100	38,00A4
2 x 40	K	100	46,50A4
2,5 x 20	K	100	42,50A4
2,5 x 25	K	100	54,00A4
2,5 x 32	K	100	60,00A4
3,2 x 16	K	100	46,00A4
3,2 x 20	K	100	55,00A4
3,2 x 25	K	100	62,00A4
3,2 x 32	K	100	70,00A4
3,2 x 36	K	100	78,00A4
3,2 x 40	K	100	86,00A4
3,2 x 45	K	100	95,00A4
3,2 x 50	K	100	107,00A4
3,2 x 63	K	100	128,00A4
4 x 20	K	100	86,00A4
4 x 25	K	100	99,00A4
4 x 32	K	100	118,00A4
4 x 40	K	100	143,00A4
4 x 50	K	100	168,00A4
4 x 63	K	100	188,00A4
5 x 32	K	50	185,00A4
5 x 36	K	50	204,00A4
5 x 40	K	50	223,00A4
5 x 50	K	50	265,00A4
5 x 63	K	50	300,00A4
6,3 x 36	K	50	290,00A4
6,3 x 40	K	50	315,00A4
6,3 x 50	K	50	370,00A4
6,3 x 63	K	50	425,00A4
6,3 x 80	K	25	480,00A4
8 x 40	K	25	640,00A4
8 x 45	K	25	680,00A4
8 x 50	K	25	710,00A4
8 x 56	S	25	740,00A4
8 x 80	K	25	920,00A4
8 x 100	K	25	1000,00A4
8 x 140	K	25	1090,00A4
10 x 71	K	25	840,00A4
10 x 80	K	25	870,00A4
10 x 90	K	25	880,00A4
10 x 100	K	25	890,00A4

Abmessungen	VE	Stück	€/100/Obf.
10 x 112	K	25	910,00A4
10 x 125	K	25	920,00A4
13 x 71	K	25	1260,00A4
13 x 100	K	25	1310,00A4
13 x 125	K	25	1370,00A4
13 x 140	K	25	1430,00A4
13 x 160	K	25	1470,00A4
13 x 180	K	25	1520,00A4
13 x 200	K	25	1580,00A4

Abmessungen	VE	Stück	€/100/Obf.
DIN 95		00095.920	A 2

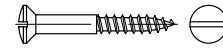

Linsensenk-Holzschrauben mit Schlitz

Maße → **TI-50** Werkstoffeigensch. → **TI-236**
 Stahl → **S. 70**
 Messing → **S. 613**

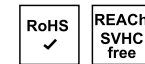

2,5 x 10	S	200	14,80A2
2,5 x 12	S	200	15,60A2
2,5 x 16	S	200	16,40A2
2,5 x 20	S	200	17,40A2
2,5 x 25	S	200	19,30A2
3 x 10	S	200	15,30A2
3 x 12	S	200	15,60A2
3 x 16	S	200	16,40A2
3 x 20	S	200	17,40A2
3 x 25	S	200	19,30A2
3 x 30	S	200	23,20A2
3 x 35	S	200	24,50A2
3 x 40	S	200	28,00A2
3,5 x 12	S	200	17,30A2
3,5 x 16	S	200	18,10A2
3,5 x 20	S	200	19,70A2
3,5 x 25	S	200	25,00A2
3,5 x 30	S	200	26,50A2
3,5 x 35	S	200	29,00A2
3,5 x 40	S	200	32,50A2
4 x 10	S	200	19,80A2
4 x 12	S	200	20,30A2
4 x 16	S	200	21,30A2
4 x 20	S	200	22,90A2
4 x 25	S	200	25,00A2
4 x 30	S	200	29,00A2
4 x 35	S	200	32,50A2
4 x 40	S	200	35,50A2
4 x 45	S	200	42,00A2
4 x 50	S	200	47,50A2
4 x 60	S	200	54,00A2
4 x 70	S	500	61,00A2
4,5 x 20	S	200	32,00A2
4,5 x 25	S	200	33,50A2
4,5 x 30	S	200	38,50A2
4,5 x 35	S	200	41,50A2
4,5 x 40	S	200	45,50A2
4,5 x 45	S	200	52,00A2
4,5 x 50	S	200	55,00A2
4,5 x 60	S	200	60,00A2
5 x 20	S	200	36,50A2
5 x 25	S	200	37,50A2
5 x 30	S	200	40,50A2
5 x 35	S	200	45,50A2

Abmessungen	VE	Stück	€/100/Obf.
5 x 40	S	200	49,50A2
5 x 45	S	200	58,00A2
5 x 50	S	200	63,00A2
5 x 60	S	200	77,00A2
5 x 70	S	200	95,00A2
5 x 80	S	200	174,00A2
5 x 90	S	200	192,00A2
5 x 100	S	200	212,00A2
6 x 20	S	200	52,00A2
6 x 25	S	200	53,00A2
6 x 30	S	200	58,00A2
6 x 35	S	200	66,00A2
6 x 40	S	200	72,00A2
6 x 45	S	200	80,00A2
6 x 50	S	200	88,00A2
6 x 60	S	100	106,00A2
6 x 70	S	100	133,00A2
6 x 80	S	100	174,00A2
6 x 90	S	100	192,00A2
6 x 100	S	100	212,00A2
6 x 120	S	100	237,00A2
8 x 50	S	100	163,00A2
8 x 60	S	100	192,00A2
8 x 70	S	100	220,00A2
8 x 80	S	100	255,00A2
8 x 100	S	100	320,00A2

DIN	00096.920
96	A 2

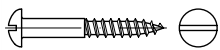

Halbrund-Holzschrauben mit Schlitz

Maße → TI-51 Werkstoffeigensch. → TI-236
 Stahl → S. 70
 Messing → S. 615

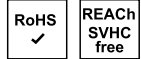

2,5 x 10	S	200	14,80A2
2,5 x 12	S	200	15,60A2
2,5 x 16	S	200	16,40A2
2,5 x 20	S	200	17,40A2
2,5 x 25	S	200	19,30A2
3 x 10	S	200	15,30A2
3 x 12	S	200	15,60A2
3 x 16	S	200	16,40A2
3 x 20	S	200	17,40A2
3 x 25	S	200	19,30A2
3 x 30	S	200	23,20A2
3 x 35	S	200	24,50A2
3 x 40	S	200	28,00A2
3,5 x 16	S	200	18,10A2
3,5 x 20	S	200	19,70A2
3,5 x 25	S	200	25,00A2
3,5 x 30	S	200	26,50A2
3,5 x 35	S	200	29,00A2
3,5 x 40	S	200	32,50A2
4 x 12	S	200	20,30A2
4 x 16	S	200	21,30A2
4 x 20	S	200	22,90A2
4 x 25	S	200	25,00A2
4 x 30	S	200	29,00A2
4 x 35	S	200	32,50A2
4 x 40	S	200	35,50A2
4 x 45	S	200	42,00A2
4 x 50	S	200	47,50A2

Abmessungen	VE	Stück	€/100/Obf.
4 x 60	S	200	65,00A2
4,5 x 20	S	200	32,00A2
4,5 x 25	S	200	34,50A2
4,5 x 30	S	200	38,50A2
4,5 x 35	S	200	41,50A2
4,5 x 40	S	200	45,50A2
4,5 x 45	S	200	52,00A2
4,5 x 50	S	200	55,00A2
4,5 x 60	S	200	60,00A2
5 x 20	S	200	36,50A2
5 x 25	S	200	37,50A2
5 x 30	S	200	40,50A2
5 x 35	S	200	45,50A2
5 x 40	S	200	49,50A2
5 x 45	S	200	58,00A2
5 x 50	S	200	63,00A2
5 x 60	S	200	77,00A2
5 x 70	S	200	95,00A2
5 x 80	S	200	174,00A2
6 x 20	S	200	52,00A2
6 x 25	S	200	53,00A2
6 x 30	S	200	58,00A2
6 x 35	S	200	66,00A2
6 x 40	S	200	72,00A2
6 x 50	S	200	88,00A2
6 x 60	S	100	106,00A2
6 x 70	S	100	133,00A2
6 x 80	S	100	174,00A2
6 x 90	S	100	192,00A2
6 x 100	S	100	212,00A2

DIN	00097.920
97	A 2

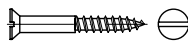

Senk-Holzschrauben mit Schlitz

Maße → TI-51 Werkstoffeigensch. → TI-236
 Stahl → S. 70
 Messing → S. 615

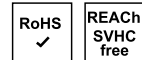

2,5 x 10	S	200	14,80A2
2,5 x 12	S	200	15,60A2
2,5 x 16	S	200	16,40A2
2,5 x 20	S	200	17,40A2
2,5 x 25	S	200	19,30A2
3 x 10	S	200	15,30A2
3 x 12	S	200	15,60A2
3 x 16	S	200	16,40A2
3 x 20	S	200	17,40A2
3 x 25	S	200	19,30A2
3 x 30	S	200	23,20A2
3 x 35	S	200	24,50A2
3 x 40	S	200	28,00A2
3,5 x 12	S	200	17,30A2
3,5 x 16	S	200	18,10A2
3,5 x 20	S	200	19,70A2
3,5 x 25	S	200	25,00A2
3,5 x 30	S	200	26,50A2
3,5 x 35	S	200	29,00A2
3,5 x 40	S	200	32,50A2
4 x 12	S	200	20,30A2
4 x 16	S	200	21,30A2
4 x 20	S	200	22,90A2
4 x 25	S	200	25,00A2
4 x 30	S	200	29,00A2
4 x 35	S	200	32,50A2
4 x 40	S	200	35,50A2
4 x 45	S	200	42,00A2
4 x 50	S	200	47,50A2

Abmessungen	VE	Stück	€/100/Obf.
4 x 30	S	200	29,00A2
4 x 35	S	200	32,50A2
4 x 40	S	200	35,50A2
4 x 45	S	200	42,00A2
4 x 50	S	200	47,50A2
4 x 60	S	200	54,00A2
4 x 70	S	200	90,00A2
4,5 x 20	S	200	32,00A2
4,5 x 25	S	200	31,50A2
4,5 x 30	S	200	38,50A2
4,5 x 35	S	200	41,50A2
4,5 x 40	S	200	45,50A2
4,5 x 45	S	200	52,00A2
4,5 x 50	S	200	55,00A2
4,5 x 60	S	200	60,00A2
5 x 20	S	200	36,50A2
5 x 25	S	200	37,50A2
5 x 30	S	200	40,50A2
5 x 35	S	200	45,50A2
5 x 40	S	200	49,50A2
5 x 45	S	200	58,00A2
5 x 50	S	200	63,00A2
5 x 60	S	200	77,00A2
5 x 70	S	200	95,00A2
5 x 80	S	200	174,00A2
5 x 100	S	200	212,00A2
6 x 20	S	200	62,00A2
6 x 25	S	200	53,00A2
6 x 30	S	200	58,00A2
6 x 35	S	200	66,00A2
6 x 40	S	200	72,00A2
6 x 45	S	200	80,00A2
6 x 50	S	200	88,00A2
6 x 60	S	100	106,00A2
6 x 70	S	100	133,00A2
6 x 80	S	100	174,00A2
6 x 90	S	100	192,00A2
6 x 100	S	100	212,00A2
8 x 50	S	100	163,00A2
8 x 60	S	100	192,00A2
8 x 70	S	100	220,00A2
8 x 80	S	100	255,00A2
8 x 90	S	100	320,00A2
8 x 100	S	100	320,00A2

DIN	00099.927
99	A 2 Form N

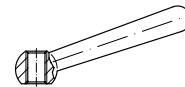

Kegelgriffe mit Griffaufnahme durch Gewinde, N = geneigte Griffachse

Maße → TI-125 Werkstoffeigensch. → TI-236
 Stahl → S. 70

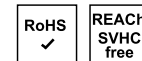

Länge / Innengewinde M

N 80 M 10	S	1	6300,00A2
N 100 M 12	S	1	8200,00A2
N 125 M 16	S	1	12200,00A2
N 160 M 20	S	1	13700,00A2

Abmessungen	VE Stück	€/100/Obf.
DIN	00125.921	
125-1	A 2 140 HV	Form A

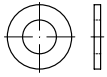

**Scheiben,
A = ohne Fase**

Maße → **TI-84** Normumstellung → **TI-84**
Werkstoffeigensch. → **TI-236**

Stahl → **S. 70**
Messing, Kupfer, Kunststoff, Aluminium → **S. 616**

DIN 125-1 Form A → wird ersetzt durch ISO 7089



Innen Ø x Außen Ø Dicke

1,7	x	4	x	0,3	S	1000	22,80A2
2,2	x	5	x	0,3	S	1000	4,30A2
2,2	x	5	x	0,3	K	200	7,60A2
2,5	x	6	x	0,5	S	1000	4,30A2
2,5	x	6	x	0,5	K	200	7,60A2
2,7	x	6	x	0,5	S	1000	4,30A2
2,7	x	6	x	0,5	K	200	7,60A2
2,8	x	7	x	0,5	S	1000	4,30A2
2,8	x	7	x	0,5	K	200	7,60A2
3,2	x	7	x	0,5	S	1000	1,90A2
3,2	x	7	x	0,5	K	200	4,30A2
3,7	x	8	x	0,5	S	1000	2,65A2
3,7	x	8	x	0,5	K	200	5,30A2
4,3	x	9	x	0,8	S	1000	2,20A2
4,3	x	9	x	0,8	K	200	4,45A2
5,3	x	10	x	1	S	1000	2,65A2
5,3	x	10	x	1	K	100	6,90A2
6,4	x	12	x	1,6	S	1000	4,95A2
6,4	x	12	x	1,6	K	100	9,70A2
7,4	x	14	x	1,6	S	1000	10,80A2
8,4	x	16	x	1,6	S	1000	8,20A2
8,4	x	16	x	1,6	K	100	14,40A2
10,5	x	20	x	2	S	1000	14,80A2
10,5	x	20	x	2	K	100	22,60A2
13	x	24	x	2,5	S	500	25,00A2
13	x	24	x	2,5	K	100	34,00A2
15	x	28	x	2,5	S	500	51,00A2
15	x	28	x	2,5	K	50	67,00A2
17	x	30	x	3	S	500	51,00A2
17	x	30	x	3	K	50	67,00A2
19	x	34	x	3	S	200	69,00A2
19	x	34	x	3	K	25	101,00A2
21	x	37	x	3	S	200	69,00A2
21	x	37	x	3	K	25	101,00A2
23	x	39	x	3	S	200	152,00A2
23	x	39	x	3	K	25	184,00A2
25	x	44	x	4	S	200	152,00A2
25	x	44	x	4	K	25	184,00A2
28	x	50	x	4	S	100	310,00A2
28	x	50	x	4	K	10	390,00A2
31	x	56	x	4	S	100	420,00A2
31	x	56	x	4	K	10	510,00A2
34	x	60	x	5	S	100	440,00A2
34	x	60	x	5	K	10	580,00A2
37	x	66	x	5	S	100	550,00A2
37	x	66	x	5	K	10	600,00A2
40	x	72	x	6	S	10	650,00A2
43	x	78	x	7	S	10	1670,00A2
46	x	85	x	7	S	10	2650,00A2
50	x	92	x	8	S	1	7400,00A2
54	x	98	x	8	S	1	9900,00A2
58	x	105	x	9	S	1	18400,00A2

Abmessungen	VE Stück	€/100/Obf.
DIN	00125.922	
125-1	A 2 140 HV	Form B

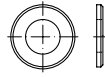

**Scheiben,
B = mit Fase**

Maße → **TI-84** Normumstellung → **TI-84**
Werkstoffeigensch. → **TI-236**

Stahl → **S. 72**
Messing → **S. 616**

DIN 125-1 Form B → wird ersetzt durch ISO 7090

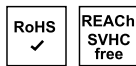

Innen Ø x Außen Ø Dicke

4,3	x	9	x	0,8	S	1000	52,00A2
5,3	x	10	x	1	S	1000	15,90A2
6,4	x	12	x	1,6	S	1000	18,40A2
8,4	x	16	x	1,6	S	500	24,10A2
10,5	x	20	x	2	S	250	39,00A2
13	x	24	x	2,5	S	250	61,00A2
17	x	30	x	3	S	100	116,00A2
21	x	37	x	3	S	50	176,00A2

Abmessungen	VE Stück	€/100/Obf.
DIN	00125.941	
125-1	A 4 140 HV	Form A

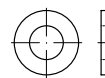

**Scheiben,
A = ohne Fase**

Maße → **TI-84** Normumstellung → **TI-84**
Werkstoffeigensch. → **TI-236**

Stahl → **S. 70**
Messing, Kupfer, Kunststoff, Aluminium → **S. 616**

DIN 125-1 Form A → wird ersetzt durch ISO 7089

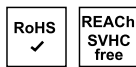

Innen Ø x Außen Ø Dicke

2,2	x	5	x	0,3	S	1000	12,40A4
2,5	x	6	x	0,5	S	1000	12,40A4
2,7	x	6	x	0,5	S	1000	10,10A4
3,2	x	7	x	0,5	S	1000	2,45A4
3,2	x	7	x	0,5	K	200	4,95A4
4,3	x	9	x	0,8	S	1000	2,75A4
4,3	x	9	x	0,8	K	200	5,30A4
5,3	x	10	x	1	S	1000	3,60A4
5,3	x	10	x	1	K	100	8,30A4
6,4	x	12	x	1,6	S	1000	9,60A4
6,4	x	12	x	1,6	K	100	16,00A4
8,4	x	16	x	1,6	S	1000	13,70A4
8,4	x	16	x	1,6	K	100	19,80A4
10,5	x	20	x	2	S	1000	29,00A4
10,5	x	20	x	2	K	100	38,00A4
13	x	24	x	2,5	S	500	39,50A4
13	x	24	x	2,5	K	100	49,00A4
15	x	28	x	2,5	S	500	75,00A4
15	x	28	x	2,5	K	50	93,00A4
17	x	30	x	3	S	500	75,00A4

Abmessungen	VE Stück	€/100/Obf.					
17	x	30	x	3	K	50	93,00A4
19	x	34	x	3	S	200	107,00A4
19	x	34	x	3	K	25	143,00A4
21	x	37	x	3	S	200	107,00A4
21	x	37	x	3	K	25	143,00A4
23	x	39	x	3	K	25	260,00A4
25	x	44	x	4	S	200	221,00A4
25	x	44	x	4	K	25	260,00A4
28	x	50	x	4	S	100	460,00A4
28	x	50	x	4	K	10	550,00A4
31	x	56	x	4	S	100	610,00A4
31	x	56	x	4	K	10	700,00A4
34	x	60	x	5	S	10	810,00A4
37	x	66	x	5	S	10	890,00A4
40	x	72	x	6	S	10	1730,00A4
43	x	78	x	7	S	10	1770,00A4

Abmessungen	VE Stück	€/100/Obf.
DIN	00125.942	
125-1	A 4 140 HV	Form B

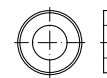

**Scheiben,
B = mit Fase**

Maße → **TI-84** Normumstellung → **TI-84**
Werkstoffeigensch. → **TI-236**

Stahl → **S. 72**
Messing → **S. 616**

DIN 125-1 Form B → wird ersetzt durch ISO 7090



Innen Ø x Außen Ø Dicke

4,3	x	9	x	0,8	S	1000	59,00A4
5,3	x	10	x	1	S	1000	23,30A4
6,4	x	12	x	1,6	S	1000	27,50A4
8,4	x	16	x	1,6	S	500	39,00A4
10,5	x	20	x	2	S	250	57,00A4
13	x	24	x	2,5	S	250	76,00A4
17	x	30	x	3	S	100	143,00A4
19	x	34	x	3	S	50	168,00A4
21	x	37	x	3	S	50	214,00A4
23	x	39	x	3	S	50	390,00A4
25	x	44	x	4	S	25	475,00A4
28	x	50	x	4	S	25	485,00A4
31	x	56	x	4	S	25	600,00A4
34	x	60	x	5	S	25	1730,00A4
37	x	66	x	5	S	10	4650,00A4
43	x	78	x	7	S	10	6200,00A4
46	x	85	x	7	S	10	9100,00A4
50	x	92	x	8	S	10	10300,00A4
54	x	98	x	8	S	1	10700,00A4
58	x	105	x	9	S	1	12400,00A4

Abmessungen	VE Stück	€/100/Obf.
DIN	00125.951	
125-1	1.4571 (A 5)	Form A

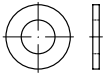

Scheiben, A = ohne Fase

Maße → **TI-84** Normumstellung → **TI-84**
 Werkstoffeigensch. → **TI-236**
 Stahl → **S. 70**
 Messing, Kupfer, Kunststoff, Aluminium → **S. 616**
 DIN 125-1 Form A → wird ersetzt durch ISO 7089

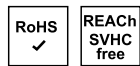

Innen Ø x Außen Ø Dicke

6,4	x	12	x	1,6	S	100	95,00 A 5
8,4	x	16	x	1,6	S	100	104,00 A 5
10,5	x	20	x	2	S	100	200,00 A 5
13	x	24	x	2,5	S	50	225,00 A 5
17	x	30	x	3	S	50	330,00 A 5
21	x	37	x	3	S	25	485,00 A 5
25	x	44	x	4	S	25	1850,00 A 5
31	x	56	x	4	S	10	2210,00 A 5

~DIN	00127.961	
127	1.4310	Form A

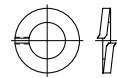

Federringe, A = aufgebogen

Achtung! Reduzierte Federkräfte.

Maße → **TI-88** Werkstoffeigensch. → **TI-236**
 Federstahl → **S. 73**

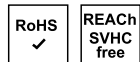

A 3	S	1000	2,85
A 3	K	100	5,30
A 4	S	1000	3,90
A 4	K	100	6,80
A 5	S	1000	4,85
A 5	K	100	8,20
A 6	S	1000	9,70
A 6	K	100	15,40
A 8	S	1000	16,70
A 8	K	100	26,00
A 10	S	1000	25,50
A 10	K	100	39,00
A 12	S	500	37,00
A 12	K	100	56,00
A 16	S	100	84,00
A 20	S	100	142,00

Abmessungen	VE Stück	€/100/Obf.
~DIN	00127.941	
127	A 4	Form A



Federringe, A = aufgebogen

Achtung! Reduzierte Federkräfte.

Maße → **TI-88** Werkstoffeigensch. → **TI-236**
 Federstahl → **S. 73**

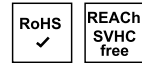

A 3	S	1000	3,50 A 4
A 3	K	100	6,60 A 4
A 4	S	1000	4,55 A 4
A 4	K	100	8,10 A 4
A 5	S	1000	6,60 A 4
A 5	K	100	10,70 A 4
A 6	S	1000	12,40 A 4
A 6	K	100	19,30 A 4
A 8	S	1000	21,40 A 4
A 8	K	100	33,50 A 4
A 10	S	1000	33,00 A 4
A 10	K	100	51,00 A 4
A 12	S	500	46,50 A 4
A 12	K	100	71,00 A 4
A 16	S	100	114,00 A 4
A 20	S	100	181,00 A 4

~DIN	00127.962	
127	1.4310	Form B

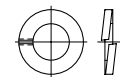

Federringe, B = glatt

Achtung! Reduzierte Federkräfte.

Maße → **TI-88** Werkstoffeigensch. → **TI-236**
 Federstahl → **S. 74**
 Bronze → **S. 617**

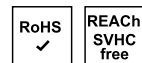

B 2	S	1000	3,45
B 2	K	100	6,90
B 2,3	S	1000	3,45
B 2,5	S	1000	3,45
B 2,5	K	100	6,90
B 2,6	S	1000	3,45
B 3	S	1000	1,75
B 3	K	100	4,45
B 3,5	S	1000	2,65
B 4	S	1000	1,90
B 4	K	100	4,85
B 5	S	1000	2,50
B 5	K	100	5,30

Abmessungen	VE Stück	€/100/Obf.	
B 6	S	1000	4,65
B 6	K	100	7,70
B 8	S	1000	7,90
B 8	K	100	12,40
B 10	S	1000	14,00
B 10	K	100	19,40
B 12	S	500	21,60
B 12	K	100	27,50
B 14	K	50	52,00
B 16	S	100	45,00
B 16	K	50	73,00
B 18	K	50	68,00
B 20	S	100	62,00
B 20	K	25	81,00
B 22	K	25	161,00
B 24	K	25	161,00
B 27	K	10	295,00
B 30	K	10	550,00
B 33	K	10	690,00
B 36	K	10	910,00

~DIN	00127.942	
127	A 4	Form B



Federringe, B = glatt

Achtung! Reduzierte Federkräfte.

Maße → **TI-88** Werkstoffeigensch. → **TI-236**
 Federstahl → **S. 74**
 Bronze → **S. 617**

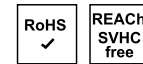

B 2	S	1000	4,10 A 4
B 2	K	100	8,00 A 4
B 2,5	S	1000	4,10 A 4
B 2,5	K	100	8,00 A 4
B 3	S	1000	2,25 A 4
B 3	K	100	5,40 A 4
B 3,5	S	1000	3,25 A 4
B 4	S	1000	2,60 A 4
B 4	K	100	5,70 A 4
B 5	S	1000	3,50 A 4
B 5	K	100	6,70 A 4
B 6	S	1000	7,00 A 4
B 6	K	100	10,20 A 4
B 8	S	1000	12,40 A 4
B 8	K	100	17,30 A 4
B 10	S	1000	26,00 A 4
B 10	K	100	33,00 A 4
B 12	S	500	36,50 A 4
B 12	K	100	43,50 A 4
B 14	K	50	77,00 A 4
B 16	S	100	69,00 A 4
B 16	K	50	98,00 A 4
B 18	K	50	112,00 A 4
B 20	K	25	118,00 A 4
B 22	K	25	223,00 A 4
B 24	K	25	223,00 A 4
B 27	K	10	480,00 A 4
B 30	K	10	810,00 A 4

Abmessungen	VE Stück	€/100/Obf.
~DIN	00128.961	
128	1.4310	Form A

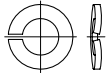

**Federringe,
A = gewölbt**

Achtung! Reduzierte Federkräfte.

Maße → **TI-89** Werkstoffeigensch. → **TI-236**
 Federstahl → **S. 75**



A 3	S 1000	5,80
A 3	K 100	8,60
A 4	S 1000	6,70
A 4	K 100	9,30
A 5	S 1000	9,30
A 5	K 100	12,90
A 6	S 1000	14,60
A 6	K 100	16,70
A 8	S 1000	23,70
A 8	K 100	26,00
A 10	S 1000	36,50
A 10	K 100	38,50
A 12	S 500	52,00
A 12	K 100	53,00
A 16	S 250	173,00
A 16	K 50	176,00
A 18	K 25	190,00
A 20	K 25	290,00

Abmessungen	VE Stück	€/100/Obf.
~DIN	00128.962	
128	1.4310	Form B



**Federringe,
B = gewellt**

Achtung! Reduzierte Federkräfte.

Maße → **TI-89** Werkstoffeigensch. → **TI-236**
 Federstahl → **S. 75**



B 4	S 1000	12,20
B 5	S 1000	12,90
B 6	S 1000	18,20
B 8	S 1000	28,00
B 10	S 1000	44,50
B 12	S 500	61,00
B 14	S 500	40,00
B 16	S 500	114,00

Abmessungen	VE Stück	€/100/Obf.
~DIN	00128.941	
128	A 4	Form A

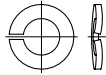

**Federringe,
A = gewölbt**

Achtung! Reduzierte Federkräfte.

Maße → **TI-89** Werkstoffeigensch. → **TI-236**
 Federstahl → **S. 75**

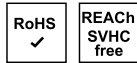

A 2,2	S 1000	20,00 A4
A 2,5	S 1000	20,00 A4
A 3	S 1000	21,40 A4
A 4	S 1000	24,40 A4
A 5	S 1000	26,50 A4
A 6	S 1000	28,50 A4
A 6	K 100	30,50 A4
A 8	S 1000	41,50 A4
A 8	K 100	44,00 A4
A 10	S 1000	69,00 A4
A 10	K 100	71,00 A4
A 12	S 500	92,00 A4
A 12	K 100	95,00 A4
A 16	S 250	325,00 A4
A 16	K 50	325,00 A4
A 20	S 100	370,00 A4
A 20	K 50	375,00 A4
A 24	S 25	380,00 A4
A 27	S 10	780,00 A4
A 30	S 10	670,00 A4

Abmessungen	VE Stück	€/100/Obf.
~DIN	00137.961	
137	1.4310	Form A

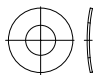

**Federscheiben,
A = gewölbt**

Achtung! Reduzierte Federkräfte.

Maße → **TI-89** Werkstoffeigensch. → **TI-236**
 Federstahl → **S. 76**

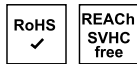

A 2	S 1000	5,20
A 2	K 100	8,20
A 2,3	S 1000	5,50
A 2,6	S 1000	3,45
A 2,6	K 100	7,10
A 3	S 1000	4,45
A 3	K 100	8,60
A 3,5	S 1000	8,80
A 3,5	K 100	14,00
A 4	S 1000	6,90

Abmessungen	VE Stück	€/100/Obf.
A 5	S 1000	9,70
A 5	K 100	16,30
A 6	S 1000	10,60
A 6	K 100	17,10
A 8	S 1000	15,00
A 8	K 100	24,50
A 10	S 1000	33,00
A 10	K 100	42,00

Abmessungen	VE Stück	€/100/Obf.
~DIN	00137.941	
137	A 4	Form A



**Federscheiben,
A = gewölbt**

Achtung! Reduzierte Federkräfte.

Maße → **TI-89** Werkstoffeigensch. → **TI-236**
 Federstahl → **S. 76**

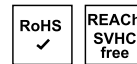

A 4	S 1000	18,90 A4
A 5	S 1000	27,50 A4
A 6	S 1000	34,00 A4
A 8	S 1000	48,50 A4
A 10	S 1000	107,00 A4

Abmessungen	VE Stück	€/100/Obf.
~DIN	00137.962	
137	1.4310	Form B



**Federscheiben,
B = gewellt**

Achtung! Reduzierte Federkräfte.

Maße → **TI-89** Werkstoffeigensch. → **TI-236**
 Federstahl → **S. 76**

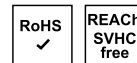

B 3	S 1000	9,70
B 3	K 100	13,30
B 4	S 1000	5,60
B 4	K 100	9,20
B 5	S 1000	7,50
B 5	K 100	11,60
B 6	S 1000	8,80
B 6	K 100	13,30
B 8	S 1000	19,00
B 8	K 100	26,50
B 10	S 1000	42,50
B 10	K 100	56,00
B 12	S 500	68,00
B 12	K 50	71,00
B 16	S 250	144,00
B 16	K 25	146,00

Abmessungen	VE	Stück	€/100/Obf.
B 20	S	25	285,00
B 24	S	100	540,00
B 30	S	100	1220,00

~DIN	00137.942
137	A 4 Form B



Federscheiben, B = gewellt

Achtung! Reduzierte Federkräfte.

Maße → TI-89 Werkstoffeigensch. → TI-236

Federstahl → S. 76

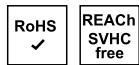

B 3	S	1000	16,80 A4
B 4	S	1000	25,50 A4
B 5	S	1000	27,50 A4
B 6	S	1000	34,00 A4
B 8	S	1000	48,50 A4
B 10	S	1000	107,00 A4
B 12	S	500	164,00 A4
B 14	S	250	320,00 A4
B 16	S	250	345,00 A4
B 20	S	25	680,00 A4

DIN	00315.920
315	A 2

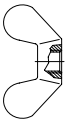

Flügelmuttern, runde Flügelform, Produktklasse C (g)

Maße → TI-72 Werkstoffeigensch. → TI-236

Temperguss → S. 77

Messing → S. 617

kleine Form → Artikel 88215

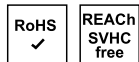

M 4	S	50	690,00 A2
M 5	S	50	710,00 A2
M 6	S	50	710,00 A2
M 8	S	25	740,00 A2
M 10	S	25	860,00 A2
M 12	S	10	1290,00 A2
M 16	S	10	1730,00 A2
M 20	S	10	2470,00 A2

Abmessungen	VE	Stück	€/100/Obf.
DIN	00315.940		
315	A 4		

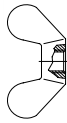

Flügelmuttern, runde Flügelform, Produktklasse C (g)

Maße → TI-72 Werkstoffeigensch. → TI-236

Temperguss → S. 77

Messing → S. 617

kleine Form → Artikel 88215



M 5	S	10	820,00 A4
M 6	S	10	880,00 A4
M 8	S	1	1030,00 A4
M 10	S	1	1280,00 A4
M 12	S	1	1850,00 A4
M 16	S	1	2460,00 A4

~DIN	88215.920
315	A 2 Artikel 88215

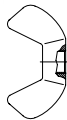

Flügelmuttern, kantige Flügelform, kleine "amerikanische" Ausführung, Produktklasse C (g)

Maße → TI-79 Werkstoffeigensch. → TI-236

Stahl → S. 78



M 4	S	100	72,00 A2
M 5	S	100	85,00 A2
M 6	S	100	120,00 A2
M 8	S	100	142,00 A2
M 10	S	100	220,00 A2
M 12	S	50	520,00 A2

Abmessungen	VE	Stück	€/100/Obf.
~DIN	88215.940		
315	A 4 Artikel 88215		

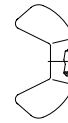

Flügelmuttern, kantige Flügelform, kleine "amerikanische" Ausführung, Produktklasse C (g)

Maße → TI-79 Werkstoffeigensch. → TI-236

Stahl → S. 78

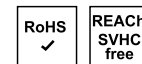

M 4	S	100	105,00 A4
M 5	S	50	107,00 A4
M 6	S	50	145,00 A4
M 8	S	25	193,00 A4
M 10	S	25	315,00 A4
M 12	S	10	740,00 A4

~DIN	00316.920
316	A 2

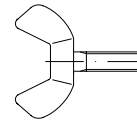

Flügelrauben, kantige Flügel, kleine "amerikanische" Ausführung, Produktklasse C (g)

Maße → TI-29 Werkstoffeigensch. → TI-236

Stahl → S. 78

Messing → S. 618

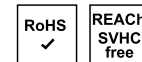

M 4	x	10	S	100	260,00 A2
M 4	x	20	S	50	270,00 A2
M 4	x	30	S	100	280,00 A2
M 5	x	10	S	100	243,00 A2
M 5	x	16	S	50	255,00 A2
M 5	x	20	S	50	265,00 A2
M 5	x	25	S	50	275,00 A2
M 5	x	30	S	50	280,00 A2
M 6	x	10	S	25	360,00 A2
M 6	x	12	S	25	365,00 A2
M 6	x	16	S	25	365,00 A2
M 6	x	20	S	25	370,00 A2
M 6	x	25	S	25	380,00 A2
M 6	x	30	S	25	390,00 A2
M 6	x	40	S	100	410,00 A2
M 6	x	50	S	100	460,00 A2
M 8	x	10	S	100	530,00 A2
M 8	x	16	S	25	540,00 A2
M 8	x	20	S	10	570,00 A2
M 8	x	25	S	10	570,00 A2
M 8	x	30	S	10	600,00 A2

Abmessungen	VE	Stück	€/100/Obf.
M 8 x 35	S	100	580,00A2
M 8 x 40	S	10	640,00A2
M 8 x 45	S	50	620,00A2
M 8 x 50	S	50	660,00A2
M 8 x 60	S	50	750,00A2
M 10 x 16	S	50	710,00A2
M 10 x 20	S	10	740,00A2
M 10 x 25	S	10	750,00A2
M 10 x 30	S	10	780,00A2
M 10 x 40	S	10	820,00A2
M 10 x 50	S	20	900,00A2
M 10 x 60	S	20	990,00A2

~DIN 00316.940
316 A 4

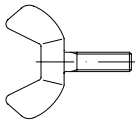

Flügelschrauben, kantige Flügel, kleine "amerikanische" Ausführung, Produktklasse C (g)

Maße → TI-29 Werkstoffeigensch. → TI-236
 Stahl → S. 78
 Messing → S. 618



M 6 x 16	S	100	510,00A4
M 6 x 20	S	100	520,00A4
M 6 x 25	S	100	540,00A4
M 6 x 30	S	100	560,00A4
M 8 x 16	S	100	760,00A4
M 8 x 20	S	100	760,00A4
M 8 x 25	S	100	790,00A4
M 8 x 30	S	100	820,00A4
M 10 x 25	S	50	1070,00A4
M 10 x 30	S	50	1120,00A4
M 12 x 30	S	25	2310,00A4
M 12 x 35	S	25	2380,00A4

DIN 00404.910
404 A 1

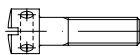

Kreuzlochschrauben mit Schlitz

Maße → TI-29 Werkstoffeigensch. → TI-236
 Stahl → S. 78



M 3 x 6	S	100	305,00A1
M 3 x 8	S	100	315,00A1
M 3 x 10	S	100	320,00A1
M 4 x 10	S	100	375,00A1
M 4 x 16	S	100	385,00A1
M 4 x 20	S	100	390,00A1

Abmessungen	VE	Stück	€/100/Obf.
M 4 x 25	S	100	395,00A1
M 4 x 30	S	100	400,00A1
M 5 x 10	S	100	530,00A1
M 5 x 12	S	100	540,00A1
M 5 x 16	S	100	550,00A1
M 5 x 30	S	100	560,00A1

DIN 00427.910
427 A 1

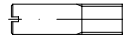

Schaftschrauben mit Kegelkuppe, mit Schlitz

Maße → TI-19 Normumstellung → TI-6
 Werkstoffeigensch. → TI-236
 Stahl → S. 79

DIN 427 → wird ersetzt durch ISO 2342 (austauschbar)

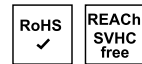

M 3 x 6	S	100	89,00A1
M 3 x 8	S	100	99,00A1
M 4 x 8	S	100	105,00A1
M 4 x 10	S	100	110,00A1
M 4 x 12	S	100	118,00A1
M 4 x 16	S	100	127,00A1
M 4 x 20	S	100	137,00A1
M 5 x 10	S	100	118,00A1
M 5 x 12	S	100	122,00A1
M 5 x 16	S	100	161,00A1
M 5 x 20	S	100	201,00A1
M 6 x 12	S	100	260,00A1
M 6 x 16	S	100	265,00A1
M 6 x 20	S	100	270,00A1
M 6 x 30	S	100	285,00A1
M 8 x 16	S	100	360,00A1
M 8 x 20	S	100	375,00A1
M 10 x 20	S	100	495,00A1
M 10 x 25	S	100	540,00A1
M 10 x 30	S	100	570,00A1
M 10 x 50	S	100	660,00A1

Abmessungen	VE	Stück	€/100/Obf.
DIN 00431.942			
431	A 4		Form B



Rohrmuttern mit zölligem Rohrgewinde G, B = einseitige Gewindeansenkung

Maße → TI-60 Werkstoffeigensch. → TI-236
 Stahl → S. 80
 Messing → S. 618

Muttern mit ISO-Schlüsselweiten auf Anfrage

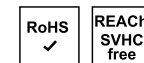

Form/Gewinde BG – Schlüsselweite

BG 1/8 SW19	S	25	214,00A4
BG 1/4 SW22	S	25	330,00A4
BG 3/8	S	25	420,00A4
BG 1/2 SW32	S	10	610,00A4
BG 3/4	S	10	910,00A4
BG 1	S	1	1700,00A4
BG 1 1/4	S	1	4550,00A4
BG 1 1/2	S	1	6000,00A4

~DIN 00432.920
432 A 2



Scheiben mit Außennase

Maße → TI-90 Werkstoffeigensch. → TI-236
 Stahl → S. 80

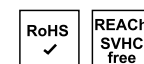

5,3	S	50	178,00A2
6,4	S	50	186,00A2
8,4	S	50	224,00A2
10,5	S	50	285,00A2
13	S	100	360,00A2
17	S	50	465,00A2
21	S	25	580,00A2

Abmessungen	VE Stück	€/100/Obf.
~DIN	00432.940	
432	A 4	

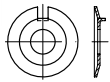

Scheiben mit Außennase

Maße → **TI-90** Werkstoffeigensch. → **TI-236**
 Stahl → **S. 80**

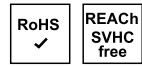

4,3	S	25	214,00 A4
5,3	S	25	223,00 A4
6,4	S	25	345,00 A4
8,4	S	25	265,00 A4
10,5	S	25	340,00 A4
13	S	25	435,00 A4
15	S	25	485,00 A4
17	S	25	610,00 A4
19	S	10	820,00 A4
21	S	10	750,00 A4
25	S	10	980,00 A4
31	S	1	1700,00 A4
37	S	1	2550,00 A4

DIN	00433.920
433-1	A 2

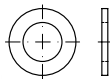

Scheiben

vorzugsweise für Zylinderschrauben

Maße → **TI-84** Normumstellung → **TI-84**
 Werkstoffeigensch. → **TI-236**
 Stahl → **S. 80**
 Messing → **S. 618**

DIN 433 → wird ersetzt durch ISO 7092

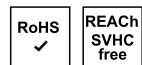

Innen Ø x Außen Ø x Dicke

2,2	x	4,5	x	0,3	S	2000	6,50 A2
2,2	x	4,5	x	0,3	K	200	10,60 A2
2,5	x	5	x	0,5	S	2000	5,40 A2
2,7	x	5	x	0,5	S	2000	4,30 A2
3,2	x	6	x	0,5	S	2000	2,10 A2
3,2	x	6	x	0,5	K	200	4,45 A2
4,3	x	8	x	0,5	S	2000	2,35 A2
4,3	x	8	x	0,5	K	200	4,45 A2
5,3	x	9	x	1	S	2000	3,35 A2
5,3	x	9	x	1	K	200	6,20 A2
6,4	x	11	x	1,6	S	1000	4,95 A2
6,4	x	11	x	1,6	K	100	8,40 A2
8,4	x	15	x	1,6	S	1000	9,90 A2
8,4	x	15	x	1,6	K	100	15,80 A2
10,5	x	18	x	1,6	S	1000	12,20 A2
10,5	x	18	x	1,6	K	100	18,40 A2

Abmessungen	VE Stück	€/100/Obf.
13	x 20 x 2	S 100 20,10 A2
15	x 24 x 2,5	S 100 31,50 A2
17	x 28 x 2,5	S 50 40,50 A2

DIN	00433.940
433-1	A 4

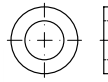

Scheiben

vorzugsweise für Zylinderschrauben

Maße → **TI-84** Normumstellung → **TI-84**
 Werkstoffeigensch. → **TI-236**

Stahl → **S. 80**
 Messing → **S. 618**
 DIN 433 → wird ersetzt durch ISO 7092

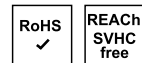

Innen Ø x Außen Ø x Dicke

3,2	x	6	x	0,5	S	2000	3,25 A4
3,2	x	6	x	0,5	K	200	5,90 A4
4,3	x	8	x	0,5	S	2000	4,35 A4
4,3	x	8	x	0,5	K	200	7,70 A4
5,3	x	9	x	1	S	2000	5,30 A4
5,3	x	9	x	1	K	200	8,80 A4
6,4	x	11	x	1,6	S	1000	8,10 A4
6,4	x	11	x	1,6	K	100	14,50 A4
8,4	x	15	x	1,6	S	1000	14,70 A4
8,4	x	15	x	1,6	K	100	21,70 A4
10,5	x	18	x	1,6	S	1000	20,00 A4
10,5	x	18	x	1,6	K	100	29,00 A4
13	x	20	x	2	S	100	36,50 A4
17	x	28	x	2,5	S	50	64,00 A4
21	x	34	x	3	S	25	94,00 A4
25	x	39	x	4	S	25	375,00 A4

DIN	00434.920
434	A 2

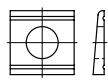

Scheiben, vierkant, keilförmig 8 %, für U-Träger

Maße → **TI-86** Werkstoffeigensch. → **TI-236**
 Stahl → **S. 81**



Innen Ø

9	S	50	445,00 A2
11	S	50	445,00 A2
13,5	S	50	740,00 A2
17,5	S	25	870,00 A2
22	S	10	1290,00 A2
26	S	10	1940,00 A2

Abmessungen	VE Stück	€/100/Obf.
DIN	00434.940	
434	A 4	

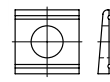

Scheiben, vierkant, keilförmig 8 %, für U-Träger

Maße → **TI-86** Werkstoffeigensch. → **TI-236**
 Stahl → **S. 81**

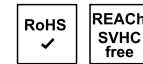

Innen Ø

9	S	50	680,00 A4
11	S	50	680,00 A4
13,5	S	50	910,00 A4
17,5	S	25	1070,00 A4
22	S	10	1730,00 A4
26	S	10	2600,00 A4

DIN	00435.920
435	A 2

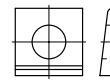

Scheiben, vierkant, keilförmig 14 %, für Doppel-T-Träger

Maße → **TI-86** Werkstoffeigensch. → **TI-236**
 Stahl → **S. 81**

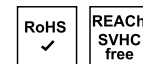

Innen Ø

9	S	50	1160,00 A2
11	S	50	1240,00 A2
13,5	S	50	1290,00 A2
17,5	S	25	1410,00 A2
22	S	10	1860,00 A2

Abmessungen	VE Stück	€/100/Obf.
DIN	00436.920	
436	A 2	

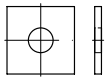

Scheiben, vierkant

vorwiegend für Holzkonstruktionen

Maße → **TI-86** Werkstoffeigensch. → **TI-236**
 Stahl → **S. 82**

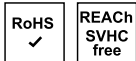

Innen Ø x Außenmaß x Dicke • ÜH-Fabrikate

11	x	30	x	3	S	100	54,00 A2
13,5	x	40	x	4	S	100	118,00 A2
17,5	x	50	x	5	S	50	224,00 A2
22	x	60	x	5	S	50	375,00 A2
26	x	80	x	6	S	50	970,00 A2
30	x	90	x	6	S	25	1160,00 A2

DIN	00439.922	
439	A 2	Form B

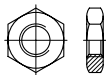

Sechskantmuttern, niedrige Form, B = mit Fasen

Maße → **TI-61** Normumstellung → **TI-7**
 Werkstoffeigensch. → **TI-236**
 Stahl → **S. 82**
 Messing → **S. 619**

DIN 439 → wird ersetzt durch ISO 4035



BM 2	S	100	38,00 A2
BM 2,5	S	100	33,00 A2
BM 3	S	1000	24,30 A2
BM 3	K	100	28,50 A2
BM 4	S	1000	23,30 A2
BM 4	K	100	27,50 A2
BM 5	S	1000	23,30 A2
BM 5	K	100	27,50 A2
BM 6	S	1000	33,50 A2
BM 6	K	100	37,50 A2
BM 8	S	1000	62,00 A2
BM 8	K	100	67,00 A2
BM 10	S	500	124,00 A2
BM 10	K	50	131,00 A2
BM 12	S	250	139,00 A2
BM 12	K	50	146,00 A2
BM 14	S	25	395,00 A2
BM 16	S	100	485,00 A2
BM 16	K	25	495,00 A2
BM 18	S	10	700,00 A2
BM 20	S	10	880,00 A2
BM 22	S	10	1120,00 A2
BM 24	S	10	1500,00 A2
BM 27	S	10	2030,00 A2

Abmessungen	VE Stück	€/100/Obf.	
BM 30	S	10	2850,00 A2
BM 36	S	1	5100,00 A2

DIN	00439.942	
439	A 4	Form B

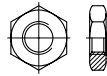

Sechskantmuttern, niedrige Form, B = mit Fasen

Maße → **TI-61** Normumstellung → **TI-7**
 Werkstoffeigensch. → **TI-236**
 Stahl → **S. 82**
 Messing → **S. 619**

DIN 439 → wird ersetzt durch ISO 4035

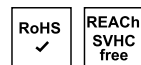

BM 2	S	100	63,00 A4
BM 2,5	S	100	63,00 A4
BM 3	S	100	36,50 A4
BM 4	S	100	35,50 A4
BM 5	S	100	41,00 A4
BM 6	S	100	47,50 A4
BM 8	S	100	89,00 A4
BM 10	S	50	166,00 A4
BM 12	S	50	355,00 A4
BM 14	S	25	530,00 A4
BM 16	S	25	680,00 A4
BM 18	S	10	930,00 A4
BM 20	S	10	1220,00 A4
BM 24	S	10	2040,00 A4
BM 27	S	10	2850,00 A4
BM 30	S	10	3950,00 A4
BM 36	S	1	7100,00 A4
BM 42	S	1	11200,00 A4

DIN	00439.927	
439	A 2	Form B - Fein

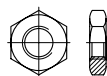

Sechskantmuttern, niedrige Form, mit metrischem Feingewinde, B = mit Fasen

Maße → **TI-61** Normumstellung → **TI-7**
 Werkstoffeigensch. → **TI-236**
 Stahl → **S. 83**

DIN 439 Feingew. → wird ersetzt durch ISO 8675



BM 8	x	1	S	100	129,00 A2
BM 10	x	1	S	50	231,00 A2
BM 10	x	1,25	S	50	231,00 A2
BM 12	x	1,25	S	50	305,00 A2
BM 12	x	1,5	S	50	305,00 A2
BM 14	x	1,5	S	25	450,00 A2

Abmessungen	VE Stück	€/100/Obf.			
BM 16	x	1,5	S	25	560,00 A2
BM 18	x	1	S	10	570,00 A2
BM 18	x	1,5	S	10	790,00 A2
BM 20	x	1,5	S	10	1010,00 A2
BM 24	x	1,5	S	10	1710,00 A2
BM 30	x	1,5	S	10	3200,00 A2
BM 30	x	2	S	10	3200,00 A2
BM 36	x	1,5	S	1	5800,00 A2

DIN	00439.947	
439	A 4	Form B - Fein

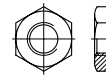

Sechskantmuttern, niedrige Form, mit metrischem Feingewinde, B = mit Fasen

Maße → **TI-61** Normumstellung → **TI-7**
 Werkstoffeigensch. → **TI-236**
 Stahl → **S. 83**

DIN 439 Feingew. → wird ersetzt durch ISO 8675

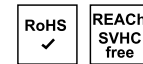

BM 10	x	1	S	50	310,00 A4
BM 10	x	1,25	S	50	310,00 A4
BM 12	x	1,25	S	50	405,00 A4
BM 12	x	1,5	S	50	405,00 A4
BM 16	x	1,5	S	25	770,00 A4
BM 18	x	1,5	S	10	1040,00 A4
BM 20	x	1,5	S	10	1370,00 A4
BM 22	x	1,5	S	10	1980,00 A4
BM 24	x	1,5	S	10	2310,00 A4
BM 24	x	2	S	10	2310,00 A4
BM 30	x	1,5	S	10	4450,00 A4
BM 30	x	2	S	10	4450,00 A4
BM 33	x	2	S	1	5800,00 A4
BM 36	x	3	S	1	7100,00 A4

DIN	00440.928	
440	A 2	Form R



Scheiben, R = mit Rundloch

vorwiegend für Holzkonstruktionen

Maße → **TI-84** Normumstellung → **TI-84**
 Werkstoffeigensch. → **TI-236**
 Stahl → **S. 84**

DIN 440 Form R → wird ersetzt durch ISO 7094

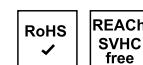

Innen Ø x Außen Ø x Dicke

R 5,5	x	18	x	2	S	100	15,20 A2
R 6,6	x	22	x	2	S	100	20,90 A2
R 9	x	28	x	3	S	100	49,50 A2

Abmessungen	VE	Stück	€/100/Obf.
R 11 x 34 x 3 S 50			72,00A2
R 13,5 x 44 x 4 S 50			159,00A2
R 17,5 x 56 x 5 S 50			305,00A2
R 22 x 72 x 6 S 50			640,00A2

DIN	00440.948
440	A 4 Form R



Scheiben, R = mit Rundloch

vorwiegend für Holzkonstruktionen

Maße → TI-84 Normumstellung → TI-84

Werkstoffeigensch. → TI-236

Stahl → S. 84

DIN 440 Form R → wird ersetzt durch ISO 7094

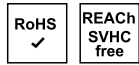

Innen Ø x Außen Ø x Dicke

R 5,5 x 18 x 2 S 100	64,00A4
R 6,6 x 22 x 2 S 100	89,00A4
R 9 x 28 x 3 S 100	196,00A4
R 11 x 34 x 3 S 50	305,00A4
R 13,5 x 44 x 4 S 50	475,00A4
R 17,5 x 56 x 5 S 50	1520,00A4
R 22 x 72 x 6 S 50	2230,00A4

DIN	00444.922
444	A 2 Form B

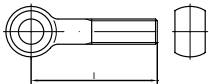

Augenschrauben, B = Produktklasse B (mg)

Maße → TI-30 Anziehmomente → TI-249

Werkstoffeigensch. → TI-236

Stahl → S. 85

Messing → S. 619

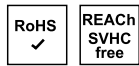

Gewinde M x Länge l

BM 5 x 40 S 10	570,00A2
BM 6 x 30 S 10	590,00A2
BM 6 x 35 S 10	650,00A2
BM 6 x 40 S 10	650,00A2
BM 6 x 45 S 10	720,00A2
BM 6 x 50 S 10	720,00A2
BM 6 x 55 S 10	780,00A2
BM 6 x 60 S 10	780,00A2
BM 8 x 30 S 10	760,00A2
BM 8 x 35 S 10	820,00A2
BM 8 x 40 S 10	820,00A2
BM 8 x 45 S 10	830,00A2
BM 8 x 50 S 10	830,00A2
BM 8 x 55 S 10	890,00A2
BM 8 x 60 S 10	890,00A2
BM 8 x 70 S 10	970,00A2

Abmessungen	VE	Stück	€/100/Obf.
BM 8 x 75 S 10			1030,00A2
BM 8 x 80 S 10			1030,00A2
BM 8 x 90 S 10			1080,00A2
BM 8 x 100 S 10			1140,00A2
BM 10 x 40 S 10			1080,00A2
BM 10 x 45 S 10			1100,00A2
BM 10 x 50 S 10			1100,00A2
BM 10 x 55 S 10			1120,00A2
BM 10 x 60 S 10			1120,00A2
BM 10 x 65 S 10			1140,00A2
BM 10 x 70 S 10			1140,00A2
BM 10 x 75 S 10			1200,00A2
BM 10 x 80 S 10			1200,00A2
BM 10 x 90 S 10			1330,00A2
BM 10 x 100 S 10			1370,00A2
BM 10 x 110 S 10			1410,00A2
BM 10 x 120 S 10			1460,00A2
BM 12 x 50 S 10			1440,00A2
BM 12 x 55 S 10			1480,00A2
BM 12 x 60 S 10			1480,00A2
BM 12 x 65 S 10			1500,00A2
BM 12 x 70 S 10			1500,00A2
BM 12 x 75 S 10			1520,00A2
BM 12 x 80 S 10			1520,00A2
BM 12 x 90 S 10			1560,00A2
BM 12 x 100 S 10			1610,00A2
BM 12 x 110 S 10			1650,00A2
BM 12 x 120 S 10			1690,00A2
BM 12 x 130 S 10			1830,00A2
BM 12 x 140 S 10			1780,00A2
BM 12 x 150 S 10			1820,00A2
BM 16 x 60 S 1			2160,00A2
BM 16 x 65 S 1			2240,00A2
BM 16 x 70 S 1			2240,00A2
BM 16 x 75 S 1			2280,00A2
BM 16 x 80 S 1			2280,00A2
BM 16 x 90 S 1			2330,00A2
BM 16 x 100 S 1			2390,00A2
BM 16 x 110 S 1			2430,00A2
BM 16 x 120 S 1			2480,00A2
BM 16 x 130 S 1			2550,00A2
BM 16 x 140 S 1			2600,00A2
BM 16 x 150 S 1			2650,00A2
BM 16 x 160 S 1			2700,00A2
BM 20 x 70 S 1			3400,00A2
BM 20 x 80 S 1			3400,00A2
BM 20 x 90 S 1			3400,00A2
BM 20 x 100 S 1			3550,00A2
BM 20 x 110 S 1			3650,00A2
BM 20 x 120 S 1			3750,00A2
BM 20 x 130 S 1			3750,00A2
BM 20 x 140 S 1			3850,00A2
BM 20 x 150 S 1			3900,00A2
BM 20 x 160 S 1			4000,00A2
BM 24 x 80 S 1			4400,00A2
BM 24 x 90 S 1			4400,00A2
BM 24 x 100 S 1			4750,00A2
BM 24 x 120 S 1			5100,00A2
BM 24 x 130 S 1			5300,00A2
BM 24 x 140 S 1			5300,00A2
BM 24 x 150 S 1			5500,00A2
BM 24 x 160 S 1			5700,00A2

Abmessungen	VE	Stück	€/100/Obf.
DIN	00444.942		
444	A 4	Form B	

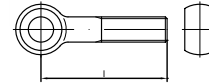

Augenschrauben, B = Produktklasse B (mg)

Maße → TI-30

Anziehmomente → TI-249

Werkstoffeigensch. → TI-236

Stahl → S. 85

Messing → S. 619

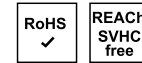

Gewinde M x Länge l

BM 6 x 30 S 10	750,00A4
BM 6 x 35 S 10	820,00A4
BM 6 x 40 S 10	820,00A4
BM 6 x 45 S 10	920,00A4
BM 6 x 50 S 10	920,00A4
BM 6 x 60 S 10	990,00A4
BM 8 x 30 S 10	970,00A4
BM 8 x 35 S 10	1040,00A4
BM 8 x 40 S 10	1040,00A4
BM 8 x 45 S 10	1070,00A4
BM 8 x 50 S 10	1070,00A4
BM 8 x 55 S 10	1140,00A4
BM 8 x 60 S 10	1140,00A4
BM 8 x 70 S 10	1220,00A4
BM 8 x 75 S 10	1280,00A4
BM 8 x 80 S 10	1280,00A4
BM 8 x 90 S 10	1370,00A4
BM 8 x 100 S 10	1430,00A4
BM 10 x 40 S 10	1370,00A4
BM 10 x 45 S 10	1390,00A4
BM 10 x 50 S 10	1390,00A4
BM 10 x 55 S 10	1410,00A4
BM 10 x 60 S 10	1410,00A4
BM 10 x 65 S 10	1430,00A4
BM 10 x 70 S 10	1430,00A4
BM 10 x 75 S 10	1520,00A4
BM 10 x 80 S 10	1520,00A4
BM 10 x 90 S 10	1680,00A4
BM 10 x 100 S 10	1770,00A4
BM 10 x 110 S 10	1810,00A4
BM 10 x 120 S 10	1850,00A4
BM 12 x 50 S 10	1850,00A4
BM 12 x 55 S 10	1870,00A4
BM 12 x 60 S 10	1870,00A4
BM 12 x 65 S 10	1910,00A4
BM 12 x 70 S 10	1910,00A4
BM 12 x 80 S 10	1930,00A4
BM 12 x 90 S 10	1980,00A4
BM 12 x 100 S 10	2060,00A4
BM 12 x 110 S 10	2100,00A4
BM 12 x 120 S 10	2140,00A4
BM 12 x 130 S 10	2190,00A4
BM 12 x 140 S 10	2250,00A4
BM 12 x 150 S 10	2310,00A4
BM 16 x 60 S 1	2750,00A4
BM 16 x 70 S 1	2850,00A4
BM 16 x 80 S 1	2950,00A4
BM 16 x 90 S 1	3000,00A4
BM 16 x 100 S 1	3050,00A4
BM 16 x 110 S 1	3100,00A4
BM 16 x 120 S 1	3150,00A4
BM 16 x 130 S 1	3250,00A4
BM 16 x 140 S 1	3300,00A4

Abmessungen	VE	Stück	€/100/Obf.
BM 16 x 150	S	1	3350,00 A4
BM 16 x 160	S	1	3400,00 A4
BM 20 x 70	S	1	4300,00 A4
BM 20 x 80	S	1	4300,00 A4
BM 20 x 90	S	1	4300,00 A4
BM 20 x 100	S	1	4550,00 A4
BM 20 x 110	S	1	4650,00 A4
BM 20 x 120	S	1	4750,00 A4
BM 20 x 130	S	1	4800,00 A4
BM 20 x 140	S	1	4850,00 A4
BM 20 x 150	S	1	5000,00 A4
BM 20 x 160	S	1	5100,00 A4
BM 24 x 80	S	1	5800,00 A4
BM 24 x 90	S	1	5900,00 A4
BM 24 x 100	S	1	6100,00 A4
BM 24 x 110	S	1	6200,00 A4
BM 24 x 120	S	1	6400,00 A4
BM 24 x 130	S	1	6700,00 A4
BM 24 x 150	S	1	7100,00 A4
BM 24 x 160	S	1	7300,00 A4

~DIN	00463.940
463	A 4

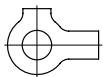

Scheiben mit 2 Lappen

Maße → **TI-91** Werkstoffeigensch. → **TI-236**
 Stahl → **S. 87**
 Messing → **S. 619**



4,3	S	25	350,00 A4
5,3	S	25	350,00 A4
6,4	S	25	285,00 A4
8,4	S	25	335,00 A4
10,5	S	25	400,00 A4
13	S	25	520,00 A4
17	S	25	760,00 A4
21	S	10	910,00 A4
23	S	10	1180,00 A4
25	S	10	1490,00 A4
31	S	1	2700,00 A4

Abmessungen	VE	Stück	€/100/Obf.
DIN	00464.910		
464	A 1/A 2		

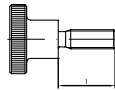

Rändelschrauben, hohe Form

Maße → **TI-30** Werkstoffeigensch. → **TI-236**
 Stahl → **S. 87**
 Messing → **S. 619**

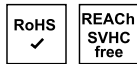

Gewinde M x Länge l

M 3 x 6	S	25	475,00 A 1/A 2
M 3 x 8	S	25	475,00 A 1/A 2
M 3 x 10	S	25	530,00 A 1/A 2
M 3 x 12	S	25	550,00 A 1/A 2
M 3 x 16	S	25	570,00 A 1/A 2
M 4 x 8	S	25	475,00 A 1/A 2
M 4 x 10	S	25	530,00 A 1/A 2
M 4 x 12	S	25	580,00 A 1/A 2
M 4 x 16	S	25	590,00 A 1/A 2
M 4 x 20	S	25	640,00 A 1/A 2
M 5 x 8	S	25	630,00 A 1/A 2
M 5 x 10	S	25	660,00 A 1/A 2
M 5 x 12	S	25	690,00 A 1/A 2
M 5 x 16	S	25	810,00 A 1/A 2
M 5 x 20	S	25	1050,00 A 1/A 2
M 5 x 25	S	25	1250,00 A 1/A 2
M 5 x 30	S	25	1420,00 A 1/A 2
M 6 x 10	S	10	910,00 A 1/A 2
M 6 x 12	S	10	950,00 A 1/A 2
M 6 x 16	S	10	970,00 A 1/A 2
M 6 x 20	S	10	1100,00 A 1/A 2
M 6 x 25	S	10	1240,00 A 1/A 2
M 6 x 30	S	10	1440,00 A 1/A 2
M 6 x 40	S	10	1820,00 A 1/A 2
M 8 x 16	S	10	2090,00 A 1/A 2
M 8 x 20	S	10	2370,00 A 1/A 2
M 8 x 25	S	10	2650,00 A 1/A 2
M 8 x 30	S	10	2850,00 A 1/A 2

DIN	00466.910
466	A 1/A 2



Rändelmuttern, hohe Form

Maße → **TI-72** Werkstoffeigensch. → **TI-236**
 Stahl → **S. 88**
 Messing → **S. 620**

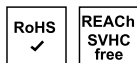

M 3	S	25	152,00 A 1/A 2
M 4	S	25	275,00 A 1/A 2
M 5	S	25	460,00 A 1/A 2
M 6	S	25	760,00 A 1/A 2
M 8	S	10	1330,00 A 1/A 2
M 10	S	10	3450,00 A 1/A 2

Abmessungen	VE	Stück	€/100/Obf.
DIN	00467.910		
467	A 1/A 2		



Rändelmuttern, niedrige Form

Maße → **TI-72** Werkstoffeigensch. → **TI-236**
 Stahl → **S. 88**
 Messing → **S. 620**



M 3	S	25	216,00 A 1/A 2
M 4	S	25	216,00 A 1/A 2
M 5	S	25	270,00 A 1/A 2
M 6	S	25	425,00 A 1/A 2
M 8	S	10	710,00 A 1/A 2
M 10	S	10	1420,00 A 1/A 2

~DIN	00471.300
471	1.4122 Regel



Sicherungsringe (Haltringe) für Wellen, Regelausführung

Achtung!
Reduzierte Federkräfte und abweichende mech. Eigenschaften gegenüber Federstahl.

Maße → **TI-91**

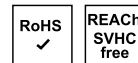

Nennmaß = für Wellen Ø x Dicke

3	x	0,4	S	100	19,90
4	x	0,4	S	100	19,90
5	x	0,6	S	100	22,20
6	x	0,7	S	100	29,00
7	x	0,8	S	100	30,00
8	x	0,8	S	100	32,00
9	x	1	S	100	70,00
10	x	1	S	100	70,00
12	x	1	S	100	78,00
14	x	1	S	100	106,00
15	x	1	S	100	159,00
16	x	1	S	100	154,00
17	x	1	S	100	158,00
18	x	1,2	S	50	175,00
19	x	1,2	S	50	207,00
20	x	1,2	S	50	180,00
22	x	1,2	S	50	222,00
24	x	1,2	S	50	265,00
25	x	1,2	S	50	270,00
26	x	1,2	S	25	520,00
28	x	1,5	S	25	510,00
29	x	1,5	S	25	520,00
30	x	1,5	S	25	520,00
32	x	1,5	S	25	740,00
34	x	1,5	S	25	770,00
35	x	1,5	S	25	590,00

Abmessungen	VE	Stück	€/100/Obf.
36 x 1,75 S 25			800,00
38 x 1,75 S 25			1440,00
40 x 1,75 S 25			1440,00
42 x 1,75 S 25			1410,00
45 x 1,75 S 10			1440,00
47 x 1,75 S 10			1500,00
48 x 1,75 S 10			1500,00
50 x 2 S 1			1480,00
52 x 2 S 1			1560,00
55 x 2 S 1			1690,00
56 x 2 S 1			1710,00
58 x 2 S 1			1730,00
60 x 2 S 1			2070,00
65 x 2,5 S 1			2140,00
68 x 2,5 S 1			2180,00
70 x 2,5 S 1			2330,00
75 x 2,5 S 1			2440,00
80 x 2,5 S 1			6600,00
90 x 3 S 1			6700,00
95 x 3 S 1			6800,00
100 x 3 S 1			7800,00

~DIN 00472.300
472 1.4122/1.4310 Regel



Sicherungsringe (Haltringe) für Bohrungen, Regelausführung

∅ ≤ 100 → 1.4122,
 ∅ > 100 → 1.4310

Achtung!
 Reduzierte Federkräfte und abweichende mech. Eigenschaften gegenüber Federstahl.

Maße → TI-95

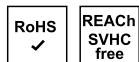

Nennmaß = für Bohrungs ∅ x Dicke

8 x 0,8 S 100	43,00
9 x 0,8 S 100	60,00
10 x 1 S 100	60,00
12 x 1 S 100	76,00
13 x 1 S 100	86,00
14 x 1 S 100	94,00
15 x 1 S 100	114,00
16 x 1 S 100	94,00
17 x 1 S 100	110,00
18 x 1 S 100	133,00
19 x 1 S 50	176,00
20 x 1 S 50	176,00
21 x 1 S 50	190,00
22 x 1 S 50	201,00
24 x 1,2 S 50	197,00
25 x 1,2 S 50	212,00
26 x 1,2 S 50	300,00
28 x 1,2 S 50	285,00
30 x 1,2 S 25	285,00
32 x 1,2 S 25	300,00
35 x 1,5 S 25	440,00
36 x 1,5 S 25	690,00
37 x 1,5 S 25	790,00
38 x 1,5 S 25	710,00
40 x 1,75 S 25	720,00
42 x 1,75 S 25	880,00
45 x 1,75 S 10	940,00
47 x 1,75 S 10	1140,00
48 x 1,75 S 10	1160,00

Abmessungen	VE	Stück	€/100/Obf.
50 x 2 S 1			1200,00
52 x 2 S 1			1220,00
54 x 2 S 1			1310,00
55 x 2 S 1			1310,00
56 x 2 S 1			1610,00
60 x 2 S 1			1710,00
62 x 2 S 1			1760,00
65 x 2,5 S 1			1820,00
68 x 2,5 S 1			3050,00
70 x 2,5 S 1			3300,00
72 x 2,5 S 1			3700,00
75 x 2,5 S 1			3750,00
80 x 2,5 S 1			5900,00
82 x 2,5 S 1			6700,00
85 x 3 S 1			6300,00
90 x 3 S 1			7100,00
95 x 3 S 1			7300,00
100 x 3 S 1			7000,00
120 x 4 S 1			7300,00
130 x 4 S 1			7700,00
140 x 4 S 1			8000,00
165 x 4 S 1			8400,00

DIN 00546.940
546 A 4

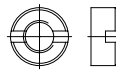

Schlitzmuttern

Maße → TI-72 Werkstoffeigensch. → TI-236

Stahl → S. 92
 Messing → S. 620



M 3 S 100	162,00 A 4
M 4 S 100	185,00 A 4
M 5 S 100	191,00 A 4
M 6 S 100	225,00 A 4
M 8 S 50	305,00 A 4

DIN 00551.910
551 A 1



Gewindestifte mit Kegelpuppe, mit Schlitz

Maße → TI-19 Normumstellung → TI-6
 Werkstoffeigensch. → TI-236

Stahl → S. 93
 Messing, Kunststoff → S. 620

DIN 551 → wird ersetzt durch ISO 4766 (austauschbar)

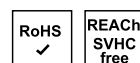

M 3 x 3 S 50	28,50 A 1
M 3 x 4 S 50	29,00 A 1
M 3 x 5 S 50	30,50 A 1

Abmessungen	VE	Stück	€/100/Obf.
M 3 x 6 S 50			32,50 A 1
M 3 x 8 S 50			34,50 A 1
M 3 x 10 S 50			36,00 A 1
M 4 x 4 S 50			31,50 A 1
M 4 x 5 S 50			31,50 A 1
M 4 x 6 S 50			33,00 A 1
M 4 x 8 S 50			35,50 A 1
M 4 x 10 S 50			37,00 A 1
M 4 x 12 S 50			39,00 A 1
M 4 x 16 S 50			41,50 A 1
M 5 x 5 S 50			34,50 A 1
M 5 x 6 S 50			36,00 A 1
M 5 x 8 S 50			38,50 A 1
M 5 x 10 S 50			40,50 A 1
M 5 x 12 S 50			43,00 A 1
M 5 x 16 S 50			47,50 A 1
M 5 x 20 S 25			62,00 A 1
M 5 x 25 S 25			72,00 A 1
M 6 x 6 S 25			43,50 A 1
M 6 x 8 S 25			45,50 A 1
M 6 x 10 S 25			48,50 A 1
M 6 x 12 S 25			53,00 A 1
M 6 x 16 S 25			55,00 A 1
M 6 x 20 S 25			63,00 A 1
M 6 x 25 S 25			72,00 A 1
M 6 x 30 S 25			85,00 A 1
M 6 x 40 S 25			97,00 A 1
M 8 x 8 S 50			57,00 A 1
M 8 x 10 S 25			70,00 A 1
M 8 x 12 S 25			76,00 A 1
M 8 x 16 S 25			85,00 A 1
M 8 x 20 S 25			101,00 A 1
M 8 x 25 S 25			120,00 A 1
M 8 x 30 S 25			131,00 A 1
M 8 x 35 S 25			139,00 A 1
M 8 x 40 S 25			150,00 A 1
M 10 x 10 S 10			122,00 A 1
M 10 x 12 S 10			122,00 A 1
M 10 x 16 S 10			129,00 A 1
M 10 x 20 S 10			159,00 A 1
M 10 x 25 S 10			180,00 A 1
M 10 x 30 S 10			192,00 A 1
M 10 x 35 S 10			205,00 A 1
M 10 x 40 S 10			216,00 A 1

DIN 00551.940
551 A 4



Gewindestifte mit Kegelpuppe, mit Schlitz

Maße → TI-19 Normumstellung → TI-6
 Werkstoffeigensch. → TI-236

Stahl → S. 93
 Messing, Kunststoff → S. 620

DIN 551 → wird ersetzt durch ISO 4766 (austauschbar)

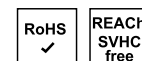

M 3 x 4 S 50	124,00 A 4
M 3 x 6 S 50	141,00 A 4
M 3 x 8 S 50	147,00 A 4
M 3 x 10 S 50	156,00 A 4
M 4 x 5 S 50	88,00 A 4
M 4 x 6 S 50	92,00 A 4
M 4 x 10 S 50	103,00 A 4

Abmessungen	VE	Stück	€/100/Obf.
M 4 x 16	S	50	116,00 A4
M 4 x 20	S	50	135,00 A4
M 4 x 25	S	50	162,00 A4
M 4 x 30	S	50	185,00 A4
M 5 x 5	S	50	350,00 A4
M 5 x 6	S	50	100,00 A4
M 5 x 8	S	50	107,00 A4
M 5 x 10	S	50	114,00 A4
M 5 x 12	S	25	131,00 A4
M 5 x 16	S	25	141,00 A4
M 5 x 20	S	25	168,00 A4
M 6 x 5	S	25	110,00 A4
M 6 x 6	S	25	118,00 A4
M 6 x 8	S	25	122,00 A4
M 6 x 10	S	25	131,00 A4
M 6 x 12	S	25	141,00 A4
M 6 x 16	S	25	149,00 A4
M 6 x 20	S	25	172,00 A4
M 6 x 25	S	25	200,00 A4
M 6 x 30	S	25	233,00 A4
M 8 x 6	S	25	168,00 A4
M 8 x 8	S	25	168,00 A4
M 8 x 10	S	25	191,00 A4
M 8 x 12	S	25	210,00 A4
M 8 x 16	S	25	233,00 A4
M 8 x 20	S	25	280,00 A4
M 8 x 30	S	25	365,00 A4
M 8 x 40	S	25	420,00 A4

DIN 00553.910
553 A 1

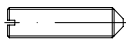

Gewindestifte mit Spitze und Schlitz

Maße → **TI-19** Normumstellung → **TI-6**
 Werkstoffeigensch. → **TI-236**
 Stahl → **S. 94**
 Messing → **S. 621**

DIN 553 → wird ersetzt durch ISO 7434 (austauschbar)

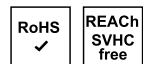

M 2 x 3	S	50	29,00 A1
M 2 x 4	S	50	30,50 A1
M 2,5 x 5	S	50	31,50 A1
M 2,5 x 6	S	50	32,50 A1
M 2,5 x 8	S	50	33,00 A1
M 3 x 4	S	50	30,00 A1
M 3 x 5	S	50	31,50 A1
M 3 x 6	S	50	33,50 A1
M 3 x 8	S	50	35,50 A1
M 4 x 5	S	50	33,00 A1
M 4 x 6	S	50	34,50 A1
M 4 x 8	S	50	36,50 A1
M 4 x 10	S	50	38,50 A1
M 4 x 12	S	50	40,50 A1
M 4 x 16	S	50	42,50 A1
M 5 x 5	S	50	35,50 A1
M 5 x 6	S	50	37,50 A1
M 5 x 8	S	50	40,00 A1
M 5 x 10	S	50	42,00 A1
M 5 x 12	S	50	44,50 A1
M 5 x 16	S	50	49,50 A1
M 6 x 6	S	25	45,00 A1
M 6 x 8	S	25	46,50 A1
M 6 x 10	S	25	51,00 A1

Abmessungen	VE	Stück	€/100/Obf.
M 6 x 12	S	25	53,00 A1
M 6 x 16	S	25	57,00 A1
M 6 x 20	S	25	65,00 A1
M 6 x 25	S	25	75,00 A1

DIN 00553.940
553 A 4

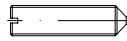

Gewindestifte mit Spitze und Schlitz

Maße → **TI-19** Normumstellung → **TI-6**
 Werkstoffeigensch. → **TI-236**
 Stahl → **S. 94**
 Messing → **S. 621**

DIN 553 → wird ersetzt durch ISO 7434 (austauschbar)

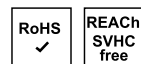

M 4 x 6	S	50	98,00 A4
M 4 x 8	S	50	104,00 A4
M 4 x 10	S	50	112,00 A4
M 5 x 5	S	50	101,00 A4
M 5 x 6	S	50	107,00 A4
M 5 x 8	S	50	116,00 A4
M 5 x 10	S	50	122,00 A4
M 5 x 16	S	25	152,00 A4
M 6 x 6	S	25	126,00 A4
M 6 x 8	S	25	131,00 A4
M 6 x 10	S	25	141,00 A4
M 6 x 12	S	25	152,00 A4
M 6 x 16	S	25	160,00 A4
M 8 x 12	S	25	227,00 A4
M 8 x 16	S	25	250,00 A4
M 8 x 20	S	25	300,00 A4
M 8 x 25	S	25	355,00 A4

DIN 00557.920
557 A 2

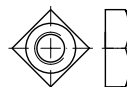

Vierkantmuttern

Maße → **TI-83** Werkstoffeigensch. → **TI-236**
 Stahl → **S. 95**

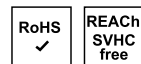

M 5	S	100	76,00 A2
M 6	S	100	105,00 A2
M 8	S	100	133,00 A2
M 10 SW 17	S	100	335,00 A2
M 12 SW 19	S	50	495,00 A2
M 16	S	25	1050,00 A2

Abmessungen	VE	Stück	€/100/Obf.
DIN 00557.940			
557			A 4

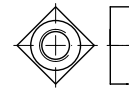

Vierkantmuttern

Maße → **TI-83** Werkstoffeigensch. → **TI-236**
 Stahl → **S. 95**

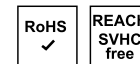

M 5	S	100	105,00 A4
M 6	S	100	131,00 A4
M 8	S	100	175,00 A4
M 10 SW 17	S	100	510,00 A4
M 12 SW 19	S	50	850,00 A4
M 16	S	25	1600,00 A4

DIN 00562.940
562 A 4



Vierkantmuttern, niedrige Form, Produktklasse B

Maße → **TI-83** Werkstoffeigensch. → **TI-236**
 Stahl → **S. 97**

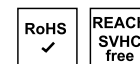

M 3	S	100	100,00 A4
M 4	S	100	104,00 A4
M 5	S	100	154,00 A4
M 6	S	100	244,00 A4
M 8	S	50	310,00 A4

DIN 00571.920
571 A 2

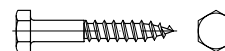

Sechskant-Holzschrauben

Maße → **TI-51** Werkstoffeigensch. → **TI-236**
 Stahl → **S. 98**

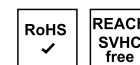

5 x 25	S	100	38,00 A2
5 x 30	S	100	45,50 A2
5 x 35	S	100	51,00 A2
5 x 40	S	100	57,00 A2

Abmessungen	VE	Stück	€/100/Obf.
5 x 45	S	100	60,00A2
5 x 50	S	50	62,00A2
5 x 60	S	50	125,00A2
5 x 70	S	50	147,00A2
6 x 20	S	25	105,00A2
6 x 25	S	25	56,00A2
6 x 30	S	200	48,50A2
6 x 30	K	25	59,00A2
6 x 35	S	25	62,00A2
6 x 40	S	200	56,00A2
6 x 40	K	25	64,00A2
6 x 45	S	25	70,00A2
6 x 50	S	200	64,00A2
6 x 50	K	25	74,00A2
6 x 60	S	100	74,00A2
6 x 60	K	25	84,00A2
6 x 70	S	100	88,00A2
6 x 70	K	25	97,00A2
6 x 80	S	100	99,00A2
6 x 80	K	25	108,00A2
6 x 90	S	25	124,00A2
6 x 100	S	25	144,00A2
6 x 110	S	25	176,00A2
6 x 120	S	25	207,00A2
6 x 130	S	25	226,00A2
8 x 25	S	25	90,00A2
8 x 30	S	25	108,00A2
8 x 35	S	25	108,00A2
8 x 40	S	100	98,00A2
8 x 40	K	10	122,00A2
8 x 45	S	10	126,00A2
8 x 50	S	100	111,00A2
8 x 50	K	10	134,00A2
8 x 55	S	100	118,00A2
8 x 55	K	10	141,00A2
8 x 60	S	100	128,00A2
8 x 60	K	10	152,00A2
8 x 70	S	100	150,00A2
8 x 70	K	10	174,00A2
8 x 80	S	100	171,00A2
8 x 80	K	10	195,00A2
8 x 90	S	10	218,00A2
8 x 100	S	100	220,00A2
8 x 100	K	10	243,00A2
8 x 110	S	10	280,00A2
8 x 120	S	10	330,00A2
8 x 130	S	10	370,00A2
8 x 140	S	10	400,00A2
8 x 150	S	10	430,00A2
8 x 160	S	10	460,00A2
8 x 180	S	10	520,00A2
10 x 40	S	10	237,00A2
10 x 50	S	100	222,00A2
10 x 50	K	10	248,00A2
10 x 60	S	100	260,00A2
10 x 60	K	10	280,00A2
10 x 70	S	100	290,00A2
10 x 70	K	10	315,00A2
10 x 80	S	100	320,00A2
10 x 80	K	10	345,00A2
10 x 90	S	10	385,00A2
10 x 100	S	100	430,00A2
10 x 100	K	10	455,00A2
10 x 110	S	10	470,00A2
10 x 120	S	10	510,00A2
10 x 130	S	10	540,00A2
10 x 140	S	10	570,00A2
10 x 150	S	10	620,00A2
10 x 160	S	10	650,00A2
10 x 180	S	10	740,00A2
10 x 200	S	10	900,00A2
12 x 50	S	10	820,00A2
12 x 60	S	10	640,00A2
12 x 70	S	10	640,00A2
12 x 80	S	10	690,00A2

Abmessungen	VE	Stück	€/100/Obf.
12 x 90	S	10	780,00A2
12 x 100	S	10	870,00A2
12 x 110	S	10	950,00A2
12 x 120	S	10	1040,00A2
12 x 130	S	10	1130,00A2
12 x 140	S	10	1220,00A2
12 x 150	S	10	1300,00A2
12 x 160	S	10	1380,00A2
12 x 180	S	10	1550,00A2
12 x 200	S	10	1730,00A2
16 x 70	S	10	1080,00A2
16 x 80	S	10	1240,00A2
16 x 90	S	10	1390,00A2
16 x 100	S	10	1540,00A2
16 x 110	S	10	1700,00A2
16 x 120	S	10	1850,00A2
16 x 130	S	10	2010,00A2
16 x 140	S	10	2150,00A2
16 x 150	S	10	2310,00A2
16 x 160	S	10	2470,00A2
16 x 180	S	10	2850,00A2
16 x 200	S	10	3100,00A2

DIN 00571.940

571 A 4

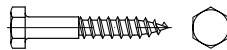

Sechskant-Holzschrauben

Maße → TI-51 Werkstoffeigensch. → TI-236
 Stahl → S. 98



5 x 25	S	200	71,00A4
5 x 30	S	200	84,00A4
5 x 35	S	200	99,00A4
5 x 40	S	200	114,00A4
5 x 45	S	200	126,00A4
5 x 50	S	200	141,00A4
5 x 60	S	200	168,00A4
5 x 70	S	200	198,00A4
6 x 25	S	200	84,00A4
6 x 30	S	200	89,00A4
6 x 35	S	200	91,00A4
6 x 40	S	200	91,00A4
6 x 45	S	200	103,00A4
6 x 50	S	200	114,00A4
6 x 60	S	200	135,00A4
6 x 70	S	200	158,00A4
6 x 80	S	200	181,00A4
6 x 90	S	100	204,00A4
6 x 100	S	100	225,00A4
6 x 110	S	100	248,00A4
6 x 120	S	100	270,00A4
6 x 130	S	100	300,00A4
8 x 25	S	100	135,00A4
8 x 30	S	100	162,00A4
8 x 35	S	100	164,00A4
8 x 40	S	100	166,00A4
8 x 45	S	100	181,00A4
8 x 50	S	100	187,00A4
8 x 60	S	100	210,00A4
8 x 70	S	100	244,00A4
8 x 80	S	100	290,00A4
8 x 90	S	100	385,00A4
8 x 100	S	100	475,00A4

Abmessungen	VE	Stück	€/100/Obf.
8 x 110	S	100	540,00A4
8 x 120	S	100	580,00A4
8 x 130	S	100	620,00A4
8 x 140	S	100	680,00A4
8 x 150	S	100	720,00A4
8 x 160	S	100	770,00A4
8 x 180	S	100	870,00A4
10 x 40	S	100	345,00A4
10 x 50	S	100	435,00A4
10 x 60	S	100	440,00A4
10 x 70	S	100	485,00A4
10 x 80	S	100	520,00A4
10 x 90	S	100	610,00A4
10 x 100	S	100	700,00A4
10 x 120	S	50	920,00A4
10 x 130	S	50	1000,00A4
10 x 140	S	50	1100,00A4
10 x 150	S	50	1180,00A4
10 x 160	S	50	1240,00A4
10 x 180	S	50	2080,00A4
12 x 50	S	50	740,00A4
12 x 60	S	50	780,00A4
12 x 70	S	50	900,00A4
12 x 80	S	50	930,00A4
12 x 90	S	50	1040,00A4
12 x 100	S	50	1180,00A4
12 x 110	S	50	1260,00A4
12 x 120	S	25	1350,00A4
12 x 130	S	50	1560,00A4
12 x 140	S	25	1680,00A4
12 x 150	S	25	1850,00A4
12 x 160	S	25	3150,00A4
12 x 180	S	25	5600,00A4
12 x 200	S	25	7800,00A4
16 x 70	S	10	1620,00A4
16 x 80	S	10	1850,00A4
16 x 90	S	10	2100,00A4
16 x 100	S	10	2310,00A4
16 x 110	S	10	2600,00A4
16 x 120	S	10	2800,00A4
16 x 130	S	10	3050,00A4
16 x 140	S	10	3250,00A4
16 x 150	S	10	3550,00A4
16 x 160	S	10	3750,00A4
16 x 180	S	10	4250,00A4
16 x 200	S	10	4700,00A4

DIN 00580.920

580 A 2

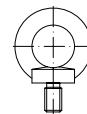

Ringschrauben

Achtung! Benutzer-Informationen beachten.
 → DIN 580 oder Technische Informationen

Maße → TI-32 Produktinformation → TI-142
 Werkstoffeigensch. → TI-236
 Stahl → S. 99

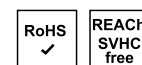

M 6 - kl. Grundkörper	S	1	2050,00A2
M 6	S	1	2050,00A2
M 8	S	1	1840,00A2
M 10	S	1	2750,00A2
M 12	S	1	4600,00A2

Abmessungen	VE	Stück	€/100/Obf.
M 16	S	1	7900,00 A2
M 20	S	1	10600,00 A2
M 24	S	1	16100,00 A2
M 30	S	1	27500,00 A2

DIN	00580.940
580	A 4

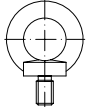

Ringschrauben

Achtung! Benutzer-Informationen beachten.
→ **DIN 580** oder Technische Informationen

Maße → **TI-32** Produktinformation → **TI-142**
Werkstoffeigensch. → **TI-236**

Stahl → **S. 99**

RoHS	REACH SVHC free
✓	

M 6	S	1	2600,00 A4
M 8	S	1	2600,00 A4
M 10	S	1	3500,00 A4
M 12	S	1	5900,00 A4
M 16	S	1	9700,00 A4
M 20	S	1	13300,00 A4
M 24	S	1	20400,00 A4
M 30	S	1	30500,00 A4

DIN	00582.920
582	A 2



Ringmuttern

Achtung! Benutzer-Informationen beachten.
→ **DIN 582** oder Technische Informationen

Maße → **TI-77** Produktinformation → **TI-142**
Werkstoffeigensch. → **TI-236**

Stahl → **S. 99**

RoHS	REACH SVHC free
✓	

M 6	S	1	1950,00 A2
M 8	S	1	1880,00 A2
M 10	S	1	2700,00 A2
M 12	S	1	4250,00 A2
M 16	S	1	6500,00 A2
M 20	S	1	11600,00 A2
M 24	S	1	13300,00 A2
M 30	S	1	25400,00 A2

Abmessungen	VE	Stück	€/100/Obf.
DIN	00582.940		
582	A 4		



Ringmuttern

Achtung! Benutzer-Informationen beachten.
→ **DIN 582** oder Technische Informationen

Maße → **TI-77** Produktinformation → **TI-142**
Werkstoffeigensch. → **TI-236**

Stahl → **S. 99**

RoHS	REACH SVHC free
✓	

M 8	S	1	2650,00 A4
M 10	S	1	3550,00 A4
M 12	S	1	5700,00 A4
M 16	S	1	9300,00 A4
M 20	S	1	14500,00 A4
M 24	S	1	16200,00 A4
M 30	S	1	28200,00 A4

DIN	00603.924
603	A 2

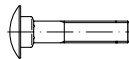

Flachrundschrauben mit Vierkantansatz

Voll- oder Teilgewinde je nach Fabrikat

Maße → **TI-32** Werkstoffeigensch. → **TI-236**

Stahl → **S. 103**
Messing → **S. 621**

RoHS	REACH SVHC free
✓	

M 5	x	16	S	100	74,00 A2
M 5	x	20	S	100	77,00 A2
M 5	x	25	S	100	82,00 A2
M 5	x	30	S	100	87,00 A2
M 5	x	35	S	100	90,00 A2
M 5	x	40	S	100	93,00 A2
M 5	x	45	S	100	126,00 A2
M 5	x	50	S	100	132,00 A2
M 5	x	55	S	100	192,00 A2
M 5	x	60	S	100	155,00 A2
M 5	x	65	S	100	255,00 A2
M 5	x	70	S	100	233,00 A2
M 5	x	80	S	100	280,00 A2
M 6	x	12	S	100	79,00 A2
M 6	x	16	S	100	82,00 A2
M 6	x	20	S	100	86,00 A2
M 6	x	25	S	100	90,00 A2
M 6	x	30	S	100	94,00 A2
M 6	x	35	S	100	105,00 A2
M 6	x	40	S	100	116,00 A2
M 6	x	45	S	100	118,00 A2
M 6	x	50	S	100	122,00 A2
M 6	x	55	S	100	139,00 A2

Abmessungen	VE	Stück	€/100/Obf.		
M 6	x	60	S	100	139,00 A2
M 6	x	65	S	100	161,00 A2
M 6	x	70	S	100	201,00 A2
M 6	x	75	S	100	229,00 A2
M 6	x	80	S	100	243,00 A2
M 6	x	90	S	100	285,00 A2
M 6	x	100	S	100	330,00 A2
M 6	x	110	S	100	355,00 A2
M 6	x	120	S	100	470,00 A2
M 8	x	16	S	100	152,00 A2
M 8	x	20	S	100	159,00 A2
M 8	x	25	S	100	164,00 A2
M 8	x	30	S	100	171,00 A2
M 8	x	35	S	100	176,00 A2
M 8	x	40	S	100	182,00 A2
M 8	x	45	S	100	197,00 A2
M 8	x	50	S	100	209,00 A2
M 8	x	55	S	100	280,00 A2
M 8	x	60	S	100	237,00 A2
M 8	x	65	S	100	320,00 A2
M 8	x	70	S	100	280,00 A2
M 8	x	75	S	100	320,00 A2
M 8	x	80	S	100	370,00 A2
M 8	x	90	S	100	355,00 A2
M 8	x	100	S	100	430,00 A2
M 8	x	110	S	100	460,00 A2
M 8	x	120	S	100	510,00 A2
M 8	x	130	S	100	920,00 A2
M 8	x	140	S	50	1020,00 A2
M 8	x	150	S	50	1130,00 A2
M 8	x	160	S	50	1830,00 A2
M 8	x	180	S	50	2020,00 A2
M 8	x	200	S	50	2290,00 A2
M 10	x	20	S	100	420,00 A2
M 10	x	25	S	100	445,00 A2
M 10	x	30	S	100	460,00 A2
M 10	x	35	S	100	485,00 A2
M 10	x	40	S	100	520,00 A2
M 10	x	45	S	100	540,00 A2
M 10	x	50	S	100	560,00 A2
M 10	x	55	S	100	580,00 A2
M 10	x	60	S	100	600,00 A2
M 10	x	65	S	100	780,00 A2
M 10	x	70	S	100	660,00 A2
M 10	x	75	S	100	690,00 A2
M 10	x	80	S	100	710,00 A2
M 10	x	90	S	100	760,00 A2
M 10	x	100	S	100	820,00 A2
M 10	x	110	S	50	1200,00 A2
M 10	x	120	S	50	1220,00 A2
M 10	x	130	S	50	1540,00 A2
M 10	x	140	S	50	1740,00 A2
M 10	x	150	S	50	1870,00 A2
M 12	x	25	S	100	850,00 A2
M 12	x	30	S	100	890,00 A2
M 12	x	35	S	100	920,00 A2
M 12	x	40	S	100	970,00 A2
M 12	x	45	S	100	1030,00 A2
M 12	x	50	S	100	1070,00 A2
M 12	x	55	S	100	1130,00 A2
M 12	x	60	S	100	1160,00 A2
M 12	x	65	S	50	1190,00 A2
M 12	x	70	S	50	1240,00 A2
M 12	x	75	S	50	1300,00 A2
M 12	x	80	S	50	1340,00 A2
M 12	x	90	S	50	1440,00 A2
M 12	x	100	S	50	1520,00 A2
M 12	x	110	S	50	1610,00 A2
M 12	x	120	S	50	1710,00 A2
M 12	x	130	S	50	1800,00 A2
M 12	x	140	S	50	1900,00 A2
M 12	x	150	S	25	2100,00 A2
M 12	x	160	S	25	2320,00 A2
M 12	x	180	S	25	2850,00 A2
M 12	x	200	S	25	3050,00 A2

Abmessungen	VE	Stück	€/100/Obf.
M 16 x 40	S	50	1520,00 A2
M 16 x 45	S	50	1580,00 A2
M 16 x 50	S	50	1660,00 A2
M 16 x 55	S	50	1760,00 A2
M 16 x 60	S	50	1800,00 A2
M 16 x 65	S	25	1900,00 A2
M 16 x 70	S	25	2000,00 A2
M 16 x 75	S	25	2050,00 A2
M 16 x 80	S	25	2100,00 A2
M 16 x 90	S	25	2220,00 A2
M 16 x 100	S	25	2400,00 A2
M 16 x 110	S	25	2550,00 A2
M 16 x 120	S	25	2750,00 A2
M 16 x 130	S	1	3950,00 A2
M 16 x 140	S	1	4250,00 A2
M 16 x 150	S	1	4450,00 A2

DIN	00603.944
603	A 4

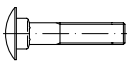

Flachrundschrauben mit Vierkantansatz

Voll- oder Teilgewinde je nach Fabrikat

Maße → **TI-32** Werkstoffeigensch. → **TI-236**

Stahl → **S. 103**
Messing → **S. 621**

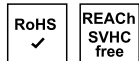

M 6 x 16	S	25	219,00 A4
M 6 x 20	S	25	240,00 A4
M 6 x 25	S	25	275,00 A4
M 6 x 30	S	25	290,00 A4
M 6 x 35	S	25	295,00 A4
M 6 x 40	S	25	300,00 A4
M 6 x 45	S	25	300,00 A4
M 6 x 50	S	25	305,00 A4
M 6 x 55	S	25	320,00 A4
M 6 x 60	S	25	335,00 A4
M 6 x 65	S	10	420,00 A4
M 6 x 70	S	10	420,00 A4
M 6 x 75	S	10	470,00 A4
M 6 x 80	S	10	490,00 A4
M 6 x 90	S	10	560,00 A4
M 6 x 100	S	10	720,00 A4
M 8 x 16	S	25	380,00 A4
M 8 x 20	S	25	395,00 A4
M 8 x 25	S	25	420,00 A4
M 8 x 30	S	25	445,00 A4
M 8 x 35	S	25	480,00 A4
M 8 x 40	S	25	480,00 A4
M 8 x 45	S	10	500,00 A4
M 8 x 50	S	10	520,00 A4
M 8 x 55	S	10	560,00 A4
M 8 x 60	S	10	570,00 A4
M 8 x 65	S	10	640,00 A4
M 8 x 70	S	10	660,00 A4
M 8 x 75	S	10	870,00 A4
M 8 x 80	S	10	690,00 A4
M 8 x 90	S	10	770,00 A4
M 8 x 100	S	10	850,00 A4
M 8 x 110	S	10	960,00 A4
M 8 x 120	S	10	1010,00 A4
M 8 x 130	S	10	1670,00 A4
M 8 x 140	S	10	1810,00 A4

Abmessungen	VE	Stück	€/100/Obf.
M 8 x 150	S	10	1900,00 A4
M 10 x 20	S	10	630,00 A4
M 10 x 25	S	10	630,00 A4
M 10 x 30	S	10	670,00 A4
M 10 x 35	S	10	720,00 A4
M 10 x 40	S	10	820,00 A4
M 10 x 45	S	10	900,00 A4
M 10 x 50	S	10	940,00 A4
M 10 x 55	S	10	960,00 A4
M 10 x 60	S	10	980,00 A4
M 10 x 65	S	10	1070,00 A4
M 10 x 70	S	10	1130,00 A4
M 10 x 75	S	1	1490,00 A4
M 10 x 80	S	1	1200,00 A4
M 10 x 90	S	1	1290,00 A4
M 10 x 100	S	1	1320,00 A4
M 10 x 110	S	1	1550,00 A4
M 10 x 120	S	1	1670,00 A4
M 10 x 130	S	1	1800,00 A4
M 10 x 140	S	1	1900,00 A4
M 10 x 150	S	1	2030,00 A4
M 12 x 25	S	1	1350,00 A4
M 12 x 30	S	1	1350,00 A4
M 12 x 35	S	1	1500,00 A4
M 12 x 40	S	1	1570,00 A4
M 12 x 45	S	1	1640,00 A4
M 12 x 50	S	1	1700,00 A4
M 12 x 55	S	1	1740,00 A4
M 12 x 60	S	1	1760,00 A4
M 12 x 65	S	1	1820,00 A4
M 12 x 70	S	1	1840,00 A4
M 12 x 75	S	1	1860,00 A4
M 12 x 80	S	1	1900,00 A4
M 12 x 90	S	1	2040,00 A4
M 12 x 100	S	1	2430,00 A4
M 12 x 110	S	1	2550,00 A4
M 12 x 120	S	1	2600,00 A4
M 12 x 130	S	1	2750,00 A4
M 12 x 140	S	1	2850,00 A4
M 12 x 150	S	1	3250,00 A4
M 12 x 160	S	1	3400,00 A4
M 16 x 50	S	1	2430,00 A4
M 16 x 55	S	1	2550,00 A4
M 16 x 60	S	1	2650,00 A4
M 16 x 65	S	1	2850,00 A4
M 16 x 70	S	1	2900,00 A4
M 16 x 75	S	1	3050,00 A4
M 16 x 80	S	1	3150,00 A4
M 16 x 90	S	1	3300,00 A4
M 16 x 100	S	1	3550,00 A4
M 16 x 110	S	1	4700,00 A4
M 16 x 120	S	1	4900,00 A4
M 16 x 130	S	1	5100,00 A4
M 16 x 140	S	1	5400,00 A4
M 16 x 150	S	1	5400,00 A4

Abmessungen	VE	Stück	€/100/Obf.
DIN		00653.910	
653		A 1	

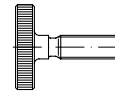

Rändelschrauben, niedrige Form

Maße → **TI-33** Werkstoffeigensch. → **TI-236**

Stahl → **S. 108**

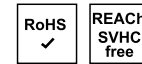

M 3 x 10	S	10	495,00 A1
M 3 x 12	S	10	530,00 A1
M 3 x 16	S	10	550,00 A1
M 4 x 8	S	10	495,00 A1
M 4 x 10	S	10	550,00 A1
M 4 x 12	S	10	580,00 A1
M 4 x 16	S	10	630,00 A1
M 4 x 20	S	10	690,00 A1
M 5 x 10	S	10	670,00 A1
M 5 x 12	S	10	710,00 A1
M 5 x 16	S	10	810,00 A1
M 5 x 20	S	10	1050,00 A1
M 5 x 25	S	10	1240,00 A1
M 5 x 30	S	10	1420,00 A1
M 5 x 40	S	10	1900,00 A1
M 5 x 50	S	10	2280,00 A1
M 6 x 12	S	10	930,00 A1
M 6 x 16	S	10	970,00 A1
M 6 x 20	S	10	1080,00 A1
M 6 x 25	S	10	1240,00 A1
M 6 x 30	S	10	1440,00 A1
M 6 x 35	S	10	1660,00 A1
M 6 x 40	S	10	1820,00 A1
M 8 x 10	S	10	1610,00 A1
M 8 x 16	S	10	1900,00 A1
M 8 x 20	S	10	2280,00 A1
M 8 x 25	S	10	2600,00 A1
M 8 x 30	S	10	2850,00 A1
M 8 x 35	S	10	3250,00 A1

DIN	00660.920
660	A 2

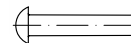

Halbrundniete

Maße → **TI-134** Werkstoffeigensch. → **TI-236**

Stahl → **S. 109**

Messing, Kupfer, Aluminium → **S. 621**

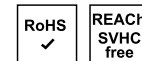

2 x 4	S	200	15,00 A2
2 x 5	S	200	15,00 A2
2 x 6	S	200	15,00 A2
2 x 8	S	200	16,10 A2
2 x 20	S	200	19,90 A2
3 x 4	S	200	18,40 A2

Abmessungen	VE	Stück	€/100/Obf.
3 x 5	S	200	18,40 A2
3 x 6	S	200	18,40 A2
3 x 8	S	200	19,40 A2
3 x 10	S	200	21,40 A2
3 x 12	S	200	22,80 A2
3 x 16	S	200	26,00 A2
3 x 20	S	200	30,00 A2
3 x 25	S	200	34,00 A2
4 x 5	S	100	30,50 A2
4 x 6	S	100	30,50 A2
4 x 8	S	100	32,50 A2
4 x 10	S	100	36,00 A2
4 x 12	S	100	39,50 A2
4 x 16	S	100	44,50 A2
4 x 20	S	100	51,00 A2
4 x 25	S	100	56,00 A2
5 x 8	S	100	46,00 A2
5 x 10	S	100	53,00 A2
5 x 12	S	100	57,00 A2
5 x 16	S	100	65,00 A2
5 x 20	S	100	78,00 A2
5 x 25	S	100	90,00 A2
6 x 12	S	100	82,00 A2
6 x 16	S	100	93,00 A2
6 x 20	S	100	114,00 A2
6 x 25	S	100	125,00 A2
6 x 30	S	100	137,00 A2
8 x 16	S	50	154,00 A2
8 x 20	S	50	173,00 A2
8 x 25	S	50	190,00 A2
8 x 30	S	50	205,00 A2

DIN	00661.920
661	A 2

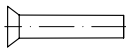

Senkniete

Maße → **TI-134** Werkstoffeigensch. → **TI-236**
 Stahl → **S. 109**
 Messing, Kupfer, Aluminium → **S. 622**

RoHS	REACH SVHC free
------	-----------------

2 x 5	S	200	14,40 A2
2 x 6	S	200	14,40 A2
3 x 6	S	200	17,50 A2
3 x 8	S	200	18,60 A2
3 x 10	S	200	20,50 A2
3 x 12	S	200	21,60 A2
3 x 16	S	200	24,30 A2
3 x 20	S	200	28,50 A2
4 x 6	S	100	29,00 A2
4 x 8	S	100	31,00 A2
4 x 10	S	100	34,00 A2
4 x 12	S	100	37,50 A2
4 x 16	S	100	42,50 A2
4 x 20	S	100	48,50 A2
5 x 8	S	100	44,00 A2
5 x 10	S	100	49,50 A2
5 x 12	S	100	54,00 A2
5 x 16	S	100	62,00 A2
5 x 20	S	100	74,00 A2
5 x 25	S	100	87,00 A2
6 x 12	S	100	78,00 A2
6 x 16	S	100	88,00 A2

Abmessungen	VE	Stück	€/100/Obf.
6 x 30	S	100	131,00 A2
8 x 20	S	50	163,00 A2
8 x 25	S	50	180,00 A2

DIN	00705.911
705	A 1 Form A

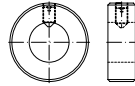

Stellringe, leichte Reihe, A = mit Gewindestift

bis Ø 75 mit Gewindestift DIN 553/ISO 7434,
 ab Ø 75 mit Gewindestift DIN 914/ISO 4027

Maße → **TI-111** Werkstoffeigensch. → **TI-236**
 Stahl → **S. 110**

RoHS	REACH SVHC free
------	-----------------

Innen-/Nenn Ø x Außen Ø x Breite

A 6 x 12 x 8	S	10	305,00 A1
A 8 x 16 x 8	S	10	325,00 A1
A 9 x 18 x 10	S	10	400,00 A1
A 10 x 20 x 10	S	10	435,00 A1
A 12 x 22 x 12	S	10	540,00 A1
A 13 x 22 x 12	S	10	540,00 A1
A 14 x 25 x 12	S	10	620,00 A1
A 15 x 25 x 12	S	10	620,00 A1
A 16 x 28 x 12	S	10	760,00 A1
A 18 x 32 x 14	S	10	990,00 A1
A 20 x 32 x 14	S	10	990,00 A1
A 22 x 36 x 14	S	1	1240,00 A1
A 25 x 40 x 16	S	1	1410,00 A1
A 26 x 40 x 16	S	1	1410,00 A1
A 28 x 45 x 16	S	1	1670,00 A1
A 30 x 45 x 16	S	1	1670,00 A1
A 32 x 50 x 16	S	1	2290,00 A1
A 35 x 56 x 16	S	1	2600,00 A1
A 40 x 63 x 18	S	1	3750,00 A1
A 45 x 70 x 18	S	1	4950,00 A1
A 50 x 80 x 18	S	1	6600,00 A1
A 60 x 90 x 20	S	1	12500,00 A1
A 65 x 100 x 20	S	1	17100,00 A1
A 70 x 100 x 20	S	1	18800,00 A1
A 80 x 110 x 22	S	1	25600,00 A1
A120 x 160 x 25	S	1	66300,00 A1

Abmessungen	VE	Stück	€/100/Obf.
DIN	00705.951		
705	1.4571 (A 5)	Form A	

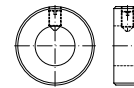

Stellringe, leichte Reihe, A = mit Gewindestift

Gewindestift DIN 553/ISO 7434

Maße → **TI-111** Werkstoffeigensch. → **TI-236**
 Stahl → **S. 110**

RoHS	REACH SVHC free
------	-----------------

Innen-/Nenn Ø x Außen Ø x Breite

A 8 x 16 x 8	S	10	700,00 A5
A 10 x 20 x 10	S	10	940,00 A5
A 12 x 22 x 12	S	10	1160,00 A5
A 14 x 25 x 12	S	10	1310,00 A5
A 15 x 25 x 12	S	10	1310,00 A5
A 16 x 28 x 12	S	10	1620,00 A5
A 20 x 32 x 14	S	10	2080,00 A5
A 25 x 40 x 16	S	5	3000,00 A5
A 30 x 45 x 16	S	5	3550,00 A5
A 35 x 56 x 16	S	5	5500,00 A5
A 40 x 63 x 18	S	1	8000,00 A5
A 50 x 80 x 18	S	1	14100,00 A5
A 60 x 90 x 20	S	1	21000,00 A5

~DIN	00741.920
741	A 2

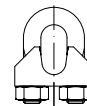

Drahtseilklemmen mit U-förmigem Klemmbügel

Kauschen → DIN 6899

Maße → **TI-133** Werkstoffeigensch. → **TI-236**

Sicherheits-Drahtseilklemmen
 → DIN 1142/EN 13411-5 auf Anfrage

RoHS	REACH SVHC free
------	-----------------

Für Seil Ø max. / Gewinde Ø Klemmbügel

3 MM / M 4	S	50	485,00 A2
5 MM / M 5	S	50	700,00 A2
6 MM / M 5	S	50	840,00 A2
8 MM / M 6	S	25	970,00 A2

Abmessungen VE Stück €/100/Obf.
DIN 00835.940

835 A 4

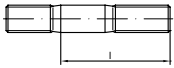

Stiftschrauben, Einschraubende ≈ 2 d

Maße → TI-18 Anziehmomente → TI-249
Werkstoffeigensch. → TI-236

Stahl → S. 112

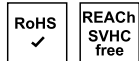

M 6	x	16	S	25	305,00 A4
M 6	x	20	S	25	315,00 A4
M 6	x	25	S	25	325,00 A4
M 8	x	30	S	10	320,00 A4
M 8	x	35	S	10	410,00 A4
M 8	x	40	S	10	420,00 A4
M 10	x	30	S	10	520,00 A4
M 10	x	35	S	10	550,00 A4
M 10	x	40	S	10	570,00 A4
M 12	x	25	S	10	620,00 A4
M 12	x	30	S	10	640,00 A4
M 12	x	35	S	10	690,00 A4
M 12	x	40	S	10	720,00 A4
M 12	x	45	S	10	750,00 A4
M 12	x	50	S	10	780,00 A4
M 12	x	60	S	10	840,00 A4
M 16	x	40	S	10	1070,00 A4
M 16	x	50	S	10	1180,00 A4

DIN 00906.940

906 A 4 keg.-Fein

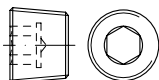

Verschlusschrauben mit Innensechskant, mit kegeligem Feingewinde

Maße → TI-22 Werkstoffeigensch. → TI-236

Stahl → S. 112
Messing → S. 624

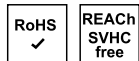

M 8	x	1	S	100	395,00 A4
M 10	x	1	S	100	440,00 A4
M 12	x	1,5	S	100	500,00 A4
M 14	x	1,5	S	100	620,00 A4
M 16	x	1,5	S	100	880,00 A4
M 18	x	1,5	S	100	990,00 A4
M 20	x	1,5	S	100	1100,00 A4
M 22	x	1,5	S	50	1220,00 A4

Abmessungen VE Stück €/100/Obf.
DIN 00906.944

906 A 4 keg.-Rohr R

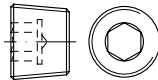

Verschlusschrauben mit Innensechskant, R = mit kegeligem Rohrgewinde

Maße → TI-22 Werkstoffeigensch. → TI-236

Stahl → S. 112
Messing → S. 624

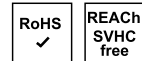

R 1/8	S	50	325,00 A4
R 1/4	S	50	640,00 A4
R 3/8	S	100	930,00 A4
R 1/2	S	100	1020,00 A4
R 3/4	S	25	7300,00 A4
R 1	S	1	12500,00 A4

DIN 00908.940

908 A 4 zyl.-Fein

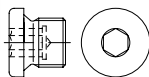

Verschlusschrauben mit Bund und Innensechskant, mit zylindrischem Feingewinde

Maße → TI-22 Werkstoffeigensch. → TI-236

Stahl → S. 112



M 8	x	1	S	100	1790,00 A4
M 10	x	1	S	100	640,00 A4
M 12	x	1,5	S	100	1070,00 A4
M 14	x	1,5	S	100	1410,00 A4
M 16	x	1,5	S	100	1520,00 A4
M 18	x	1,5	S	100	1810,00 A4
M 20	x	1,5	S	100	2080,00 A4
M 22	x	1,5	S	50	2460,00 A4
M 24	x	1,5	S	50	2850,00 A4
M 30	x	1,5	S	50	3550,00 A4
M 30	x	2	S	50	3800,00 A4

Abmessungen VE Stück €/100/Obf.
DIN 00908.944

908 A 4 zyl.-Rohr G

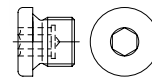

Verschlusschrauben mit Bund und Innensechskant, G = mit zylindrischem Rohrgewinde

Maße → TI-22 Werkstoffeigensch. → TI-236

Stahl → S. 112
Messing → S. 624

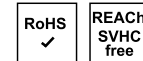

G 1/8 A	S	1	465,00 A4
G 1/4 A	S	1	890,00 A4
G 3/8 A	S	1	1030,00 A4
G 1/2 A	S	1	1280,00 A4
G 3/4 A	S	1	2460,00 A4
G 1 A	S	1	3350,00 A4
G 1 1/4 A	S	1	9600,00 A4
G 1 1/2 A	S	1	12200,00 A4
G 2 A	S	1	16800,00 A4

DIN 00910.940

910 A 4 zyl.-Fein

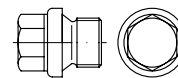

Verschlusschrauben mit Bund und Außensechskant, schwer, mit zylindrischem Feingewinde

Maße → TI-22 Werkstoffeigensch. → TI-236

Stahl → S. 112
Messing → S. 624

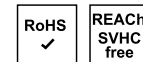

M 10	x	1	S	10	910,00 A4
M 12	x	1,5	S	10	1310,00 A4
M 14	x	1,5	S	10	1310,00 A4
M 16	x	1,5	S	1	1370,00 A4
M 18	x	1,5	S	1	1910,00 A4
M 20	x	1,5	S	1	2190,00 A4
M 22	x	1,5	S	1	2400,00 A4
M 24	x	1,5	S	1	3400,00 A4
M 30	x	1,5	S	1	14300,00 A4
M 42	x	1,5	S	10	26300,00 A4

Abmessungen	VE Stück	€/100/Obf.
DIN	00910.944	
910	A 4	zyl.-Rohr G

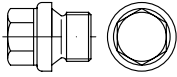

Verschlusschrauben mit Bund und Außensechskant, schwer, G = mit zylindrischem Rohrgewinde

Maße → **TI-23** Werkstoffeigensch. → **TI-236**
 Stahl → **S. 114**
 Messing → **S. 624**



G 1/8 A	S	10	670,00 A4
G 1/4 A	S	10	710,00 A4
G 3/8 A	S	10	900,00 A4
G 1/2 A	S	1	1770,00 A4
G 5/8 A	S	1	4150,00 A4
G 3/4 A	S	1	2650,00 A4
G 1 A	S	1	4150,00 A4
G 1 1/4 A	S	1	12000,00 A4
G 1 1/2 A	S	1	13300,00 A4
G 2 A	S	1	20600,00 A4

~DIN	00910.954	
910	1.4571	zyl.-Rohr EG (A 5)

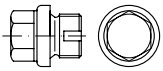

Verschlusschrauben mit Bund und Außensechskant, schwer, E = mit Entlüftung G = mit zylindrischem Rohrgewinde

(~ DIN 5586 Form A)

Maße → **TI-23** Werkstoffeigensch. → **TI-236**



EG 1/4 A	S	10	2850,00 A5
EG 3/8 A	S	10	2800,00 A5
EG 1/2 A	S	1	3550,00 A5
EG 3/4 A	S	1	4600,00 A5
EG 1 A	S	1	6800,00 A5

Abmessungen	VE Stück	€/100/Obf.
DIN	00912.920	
912	A 2 (- 70)*	

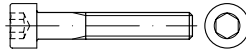

Zylinderschrauben mit Innensechskant

Maße → **TI-12** Anziehmomente → **TI-249**
 Werkstoffeigensch. → **TI-236** Normumstellung → **TI-6**

Stahl → **S. 115**
 DIN 912 → wird ersetzt durch ISO 4762



*Fkl. bei diesen Abmessungen je nach Fabrikat abweichend

M 1,6 x 4*	S	100	163,00 A2
M 1,6 x 5*	S	100	175,00 A2
M 1,6 x 6*	S	100	186,00 A2
M 1,6 x 8*	S	100	201,00 A2
M 2 x 3*	S	100	81,00 A2
M 2 x 4*	S	100	51,00 A2
M 2 x 5*	S	100	51,00 A2
M 2 x 6*	S	100	51,00 A2
M 2 x 8*	S	100	51,00 A2
M 2 x 10*	S	100	53,00 A2
M 2 x 12*	S	100	56,00 A2
M 2 x 16*	S	100	63,00 A2
M 2 x 20*	S	100	76,00 A2
M 2,5 x 4*	S	100	51,00 A2
M 2,5 x 5*	S	100	51,00 A2
M 2,5 x 6*	S	100	51,00 A2
M 2,5 x 8*	S	100	51,00 A2
M 2,5 x 10*	S	100	53,00 A2
M 2,5 x 12*	S	100	56,00 A2
M 2,5 x 14*	S	100	79,00 A2
M 2,5 x 16*	S	100	63,00 A2
M 2,5 x 20*	S	100	76,00 A2
M 2,5 x 25*	S	100	101,00 A2
M 3 x 4*	S	100	38,00 A2
M 3 x 5*	S	100	31,00 A2
M 3 x 6*	S	100	23,10 A2
M 3 x 8*	S	100	20,30 A2
M 3 x 10*	S	100	17,50 A2
M 3 x 12*	S	100	17,50 A2
M 3 x 14*	S	100	14,70 A2
M 3 x 16*	S	100	11,70 A2
M 3 x 18*	S	100	15,90 A2
M 3 x 20*	S	100	12,70 A2
M 3 x 22*	S	100	16,60 A2
M 3 x 25*	S	100	13,40 A2
M 3 x 30*	S	100	17,30 A2
M 3 x 35*	S	100	20,30 A2
M 3 x 40*	S	100	22,20 A2
M 3 x 45*	S	100	40,00 A2
M 3 x 50*	S	100	40,00 A2
M 4 x 5*	S	100	37,00 A2
M 4 x 6*	S	200	25,00 A2
M 4 x 8*	S	500	20,30 A2
M 4 x 8*	K	200	22,70 A2
M 4 x 10*	S	500	18,90 A2
M 4 x 10*	K	200	22,80 A2
M 4 x 12*	S	500	18,90 A2
M 4 x 12*	K	200	22,80 A2
M 4 x 14*	S	500	14,70 A2
M 4 x 14*	K	200	17,10 A2
M 4 x 16*	S	500	11,70 A2
M 4 x 16*	K	200	15,60 A2
M 4 x 18*	S	500	15,90 A2
M 4 x 18*	K	200	18,30 A2

Abmessungen	VE Stück	€/100/Obf.	
M 4 x 20*	S	500	12,70 A2
M 4 x 20*	K	200	16,70 A2
M 4 x 22*	S	500	16,60 A2
M 4 x 22*	K	200	19,00 A2
M 4 x 25*	S	500	13,40 A2
M 4 x 25*	K	200	15,80 A2
M 4 x 30*	S	500	17,30 A2
M 4 x 30*	K	200	19,60 A2
M 4 x 35*	S	500	17,80 A2
M 4 x 35*	K	200	20,20 A2
M 4 x 40*	S	500	19,90 A2
M 4 x 40*	K	200	22,30 A2
M 4 x 45*	S	200	40,00 A2
M 4 x 50*	S	200	40,00 A2
M 4 x 55*	S	200	235,00 A2
M 4 x 60*	S	200	260,00 A2
M 4 x 70*	S	200	335,00 A2
M 4 x 80*	S	200	860,00 A2
M 5 x 6*	S	100	44,50 A2
M 5 x 8*	S	100	20,30 A2
M 5 x 10	S	500	18,90 A2
M 5 x 10	K	100	22,80 A2
M 5 x 12	S	500	18,90 A2
M 5 x 12	K	100	22,80 A2
M 5 x 14	S	500	16,80 A2
M 5 x 14	K	100	21,50 A2
M 5 x 16	S	500	13,20 A2
M 5 x 16	K	100	17,10 A2
M 5 x 18	S	500	16,50 A2
M 5 x 18	K	100	21,20 A2
M 5 x 20	S	500	13,60 A2
M 5 x 20	K	100	17,50 A2
M 5 x 22	S	500	18,60 A2
M 5 x 22	K	100	23,30 A2
M 5 x 25	S	500	14,70 A2
M 5 x 25	K	100	18,60 A2
M 5 x 30	S	500	17,30 A2
M 5 x 30	K	100	21,20 A2
M 5 x 35	S	500	19,20 A2
M 5 x 35	K	100	23,90 A2
M 5 x 40	S	500	20,90 A2
M 5 x 40	K	100	26,00 A2
M 5 x 45	S	100	28,00 A2
M 5 x 50	S	100	31,00 A2
M 5 x 55	S	100	44,50 A2
M 5 x 60	S	100	58,00 A2
M 5 x 65	S	100	84,00 A2
M 5 x 70	S	100	67,00 A2
M 5 x 75	S	100	179,00 A2
M 5 x 80	S	100	137,00 A2
M 5 x 90	S	100	470,00 A2
M 5 x 100	S	100	690,00 A2
M 6 x 6*	S	100	46,50 A2
M 6 x 8*	S	100	26,50 A2
M 6 x 10	S	500	23,10 A2
M 6 x 10	K	100	27,50 A2
M 6 x 12	S	500	23,10 A2
M 6 x 12	K	100	27,50 A2
M 6 x 14	S	500	23,30 A2
M 6 x 14	K	100	28,50 A2
M 6 x 16	S	500	16,30 A2
M 6 x 16	K	100	20,30 A2
M 6 x 18	S	500	22,20 A2
M 6 x 18	K	100	27,00 A2
M 6 x 20	S	500	18,10 A2
M 6 x 20	K	100	22,00 A2
M 6 x 22	S	100	23,10 A2
M 6 x 25	S	500	19,50 A2
M 6 x 25	K	100	23,50 A2
M 6 x 30	S	500	21,10 A2
M 6 x 30	K	100	25,00 A2
M 6 x 35	S	500	23,90 A2
M 6 x 35	K	100	28,00 A2
M 6 x 40	S	500	26,00 A2
M 6 x 40	K	100	30,00 A2

Abmessungen	VE	Stück	€/100/0bf.	Abmessungen	VE	Stück	€/100/0bf.	Abmessungen	VE	Stück	€/100/0bf.
M 6 x 45	S	500	35,00A2	M 10 x 80	S	100	152,00A2	M 16 x 160	S	1	3700,00A2
M 6 x 45	K	100	40,00A2	M 10 x 90	S	100	173,00A2	M 16 x 170*	S	1	4000,00A2
M 6 x 50	S	500	41,50A2	M 10 x 100	S	100	211,00A2	M 16 x 180*	S	1	4300,00A2
M 6 x 50	K	100	46,50A2	M 10 x 110	S	50	290,00A2	M 16 x 190*	S	1	4550,00A2
M 6 x 55	S	500	50,00A2	M 10 x 120	S	50	320,00A2	M 16 x 200*	S	1	5200,00A2
M 6 x 55	K	100	55,00A2	M 10 x 130	S	50	390,00A2	M 20 x 30	S	10	910,00A2
M 6 x 60	S	500	55,00A2	M 10 x 140	S	50	465,00A2	M 20 x 35	S	25	910,00A2
M 6 x 60	K	100	59,00A2	M 10 x 150	S	50	530,00A2	M 20 x 40	S	25	590,00A2
M 6 x 65	S	500	88,00A2	M 10 x 160*	S	50	1550,00A2	M 20 x 45	S	25	590,00A2
M 6 x 65	K	100	93,00A2	M 10 x 170*	S	50	1750,00A2	M 20 x 50	S	25	590,00A2
M 6 x 70	S	500	71,00A2	M 10 x 180*	S	50	2230,00A2	M 20 x 55	S	25	650,00A2
M 6 x 70	K	100	76,00A2	M 12 x 16	S	100	177,00A2	M 20 x 60	S	25	670,00A2
M 6 x 75	S	100	122,00A2	M 12 x 20	S	100	88,00A2	M 20 x 65	S	25	930,00A2
M 6 x 80	S	100	97,00A2	M 12 x 25	S	100	83,00A2	M 20 x 70	S	25	760,00A2
M 6 x 85	S	100	640,00A2	M 12 x 30	S	100	77,00A2	M 20 x 75	S	25	1060,00A2
M 6 x 90	S	100	165,00A2	M 12 x 35	S	100	82,00A2	M 20 x 80	S	1	870,00A2
M 6 x 95	S	100	700,00A2	M 12 x 40	S	100	88,00A2	M 20 x 90	S	1	1170,00A2
M 6 x 100	S	100	184,00A2	M 12 x 45	S	100	98,00A2	M 20 x 100	S	1	1350,00A2
M 6 x 110	S	100	203,00A2	M 12 x 50	S	100	106,00A2	M 20 x 110	S	1	2080,00A2
M 6 x 120	S	100	241,00A2	M 12 x 55	S	100	139,00A2	M 20 x 120	S	1	2370,00A2
M 6 x 130	S	50	265,00A2	M 12 x 60	S	100	144,00A2	M 20 x 130	S	1	3000,00A2
M 6 x 140	S	50	300,00A2	M 12 x 65	S	100	228,00A2	M 20 x 140	S	1	3350,00A2
M 6 x 150	S	50	340,00A2	M 12 x 70	S	100	182,00A2	M 20 x 150	S	1	3800,00A2
M 8 x 8*	S	100	194,00A2	M 12 x 75	S	100	350,00A2	M 20 x 160*	S	1	5700,00A2
M 8 x 10	S	100	45,50A2	M 12 x 80	S	100	190,00A2	M 20 x 170*	S	1	6000,00A2
M 8 x 12	S	200	42,50A2	M 12 x 85	S	100	600,00A2	M 20 x 180*	S	1	6500,00A2
M 8 x 14	S	200	52,00A2	M 12 x 90	S	100	237,00A2	M 20 x 190*	S	1	7000,00A2
M 8 x 16	S	200	37,00A2	M 12 x 100	S	100	275,00A2	M 20 x 200*	S	1	7500,00A2
M 8 x 16	K	100	41,00A2	M 12 x 110	S	10	405,00A2	M 24 x 40	S	1	2700,00A2
M 8 x 18	S	200	42,50A2	M 12 x 120	S	10	445,00A2	M 24 x 45	S	1	2700,00A2
M 8 x 20	S	200	31,50A2	M 12 x 130	S	10	530,00A2	M 24 x 50	S	1	2080,00A2
M 8 x 20	K	100	35,50A2	M 12 x 140	S	1	630,00A2	M 24 x 55	S	1	3000,00A2
M 8 x 22	S	200	38,00A2	M 12 x 150	S	1	710,00A2	M 24 x 60	S	1	2180,00A2
M 8 x 25	S	200	29,50A2	M 12 x 160	S	1	2040,00A2	M 24 x 65	S	1	3150,00A2
M 8 x 25	K	100	33,50A2	M 12 x 170*	S	1	2230,00A2	M 24 x 70	S	1	2220,00A2
M 8 x 30	S	200	33,00A2	M 12 x 180*	S	1	2750,00A2	M 24 x 75	S	1	3250,00A2
M 8 x 30	K	100	37,00A2	M 14 x 20	S	50	880,00A2	M 24 x 80	S	1	2390,00A2
M 8 x 35	S	200	36,00A2	M 14 x 25	S	50	620,00A2	M 24 x 90	S	1	2700,00A2
M 8 x 35	K	100	40,00A2	M 14 x 30	S	50	460,00A2	M 24 x 100	S	1	2900,00A2
M 8 x 40	S	200	39,50A2	M 14 x 35	S	50	460,00A2	M 24 x 110	S	1	3500,00A2
M 8 x 40	K	100	43,50A2	M 14 x 40	S	50	460,00A2	M 24 x 120	S	1	3800,00A2
M 8 x 45	S	200	44,50A2	M 14 x 45	S	50	485,00A2	M 24 x 130	S	1	4100,00A2
M 8 x 50	S	200	48,50A2	M 14 x 50	S	50	530,00A2	M 24 x 140	S	1	4400,00A2
M 8 x 55	S	200	66,00A2	M 14 x 55	S	50	620,00A2	M 24 x 150	S	1	4650,00A2
M 8 x 60	S	200	68,00A2	M 14 x 60	S	50	640,00A2	M 24 x 160*	S	1	7300,00A2
M 8 x 65	S	200	137,00A2	M 14 x 65	S	50	900,00A2	M 24 x 170*	S	1	7900,00A2
M 8 x 70	S	200	104,00A2	M 14 x 70	S	50	900,00A2	M 24 x 180*	S	1	8400,00A2
M 8 x 75	S	200	203,00A2	M 14 x 80	S	50	920,00A2	M 24 x 200*	S	1	9300,00A2
M 8 x 80	S	200	135,00A2	M 14 x 90	S	1	1040,00A2	M 30 x 50*	S	1	5700,00A2
M 8 x 85	S	100	260,00A2	M 14 x 100	S	1	1220,00A2	M 30 x 60*	S	1	5800,00A2
M 8 x 90	S	200	148,00A2	M 14 x 110	S	1	1930,00A2	M 30 x 70*	S	1	6100,00A2
M 8 x 100	S	200	166,00A2	M 14 x 120	S	1	2180,00A2	M 30 x 80*	S	1	6400,00A2
M 8 x 110	S	50	222,00A2	M 14 x 130	S	1	2550,00A2	M 30 x 90*	S	1	6800,00A2
M 8 x 120	S	50	265,00A2	M 14 x 140	S	1	2900,00A2	M 30 x 100*	S	1	7100,00A2
M 8 x 130	S	50	290,00A2	M 14 x 150	S	1	3250,00A2	M 30 x 110*	S	1	7500,00A2
M 8 x 140	S	50	320,00A2	M 16 x 20	S	50	560,00A2	M 30 x 120*	S	1	7800,00A2
M 8 x 150	S	50	350,00A2	M 16 x 25	S	25	345,00A2	M 30 x 130*	S	1	8200,00A2
M 8 x 160*	S	50	920,00A2	M 16 x 30	S	25	260,00A2	M 30 x 140*	S	1	8500,00A2
M 8 x 170*	S	50	1210,00A2	M 16 x 35	S	25	260,00A2	M 30 x 150*	S	1	8900,00A2
M 8 x 180*	S	50	1700,00A2	M 16 x 40	S	25	260,00A2				
M 10 x 12	S	100	124,00A2	M 16 x 45	S	25	270,00A2				
M 10 x 16	S	100	70,00A2	M 16 x 50	S	25	295,00A2				
M 10 x 18	S	100	84,00A2	M 16 x 55	S	25	345,00A2				
M 10 x 20	S	100	55,00A2	M 16 x 60	S	25	355,00A2				
M 10 x 25	S	100	50,00A2	M 16 x 65	S	25	500,00A2				
M 10 x 30	S	100	53,00A2	M 16 x 70	S	25	500,00A2				
M 10 x 35	S	100	55,00A2	M 16 x 75	S	25	740,00A2				
M 10 x 40	S	100	59,00A2	M 16 x 80	S	25	510,00A2				
M 10 x 45	S	100	71,00A2	M 16 x 90	S	25	580,00A2				
M 10 x 50	S	100	75,00A2	M 16 x 100	S	25	680,00A2				
M 10 x 55	S	100	98,00A2	M 16 x 110	S	25	1080,00A2				
M 10 x 60	S	100	105,00A2	M 16 x 120	S	25	1210,00A2				
M 10 x 65	S	100	155,00A2	M 16 x 130	S	25	1410,00A2				
M 10 x 70	S	100	124,00A2	M 16 x 140	S	1	1600,00A2				
M 10 x 75	S	100	228,00A2	M 16 x 150	S	1	1790,00A2				



- ✓ Große Artikelvielfalt
- ✓ Verlässliche Qualität
- ✓ Hohe Lieferbereitschaft

Abmessungen	VE Stück	€/100/Obf.
DIN	00912.940	
912	A 4 (- 70)*	

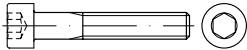

Zylinderschrauben mit Innensechskant

Maße → **TI-12** Anziehmomente → **TI-249**
 Werkstoffeigensch. → **TI-236** Normumstellung → **TI-6**

Stahl → **S. 115**

DIN 912 → wird ersetzt durch ISO 4762

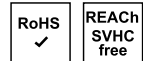

*Fkl. bei diesen Abmessungen je nach Fabrikat abweichend

M 2	x	3*	S	100	116,00A4
M 2	x	4*	S	100	65,00A4
M 2	x	5*	S	100	65,00A4
M 2	x	6*	S	100	65,00A4
M 2	x	8*	S	100	65,00A4
M 2	x	10*	S	100	68,00A4
M 2	x	12*	S	100	71,00A4
M 2	x	16*	S	100	81,00A4
M 2,5	x	4*	S	100	65,00A4
M 2,5	x	5*	S	100	65,00A4
M 2,5	x	6*	S	100	65,00A4
M 2,5	x	8*	S	100	65,00A4
M 2,5	x	10*	S	100	68,00A4
M 2,5	x	12*	S	100	71,00A4
M 2,5	x	14*	S	100	99,00A4
M 2,5	x	16*	S	100	81,00A4
M 2,5	x	20*	S	100	100,00A4
M 3	x	4*	S	100	52,00A4
M 3	x	5*	S	100	49,50A4
M 3	x	6*	S	100	37,50A4
M 3	x	8*	S	100	31,50A4
M 3	x	10*	S	100	27,00A4
M 3	x	12*	S	100	27,00A4
M 3	x	14*	S	100	27,00A4
M 3	x	16*	S	100	18,30A4
M 3	x	18*	S	100	23,50A4
M 3	x	20*	S	100	19,30A4
M 3	x	22*	S	100	24,80A4
M 3	x	25*	S	100	20,60A4
M 3	x	30*	S	100	24,00A4
M 3	x	35*	S	100	32,50A4
M 3	x	40*	S	100	35,50A4
M 3	x	45*	S	100	63,00A4
M 3	x	50*	S	100	63,00A4
M 4	x	5*	S	100	66,00A4
M 4	x	6*	S	200	39,00A4
M 4	x	8*	S	500	31,50A4
M 4	x	8*	K	200	34,00A4
M 4	x	10*	S	500	29,00A4
M 4	x	10*	K	200	31,50A4
M 4	x	12*	S	500	29,00A4
M 4	x	12*	K	200	31,50A4
M 4	x	14*	S	500	29,00A4
M 4	x	14*	K	200	31,50A4
M 4	x	16*	S	500	18,30A4
M 4	x	16*	K	200	20,90A4
M 4	x	18*	S	500	23,50A4
M 4	x	18*	K	200	26,50A4
M 4	x	20*	S	500	19,30A4
M 4	x	20*	K	200	22,00A4
M 4	x	22*	S	500	24,80A4
M 4	x	25*	S	500	20,60A4
M 4	x	25*	K	200	23,20A4
M 4	x	30*	S	500	24,00A4

M 4	x	30*	K	200	27,00A4
M 4	x	35*	S	500	32,00A4
M 4	x	35*	K	200	35,00A4
M 4	x	40*	S	500	38,50A4
M 4	x	40*	K	200	41,00A4
M 4	x	45*	S	200	63,00A4
M 4	x	50*	S	200	63,00A4
M 4	x	55*	S	200	233,00A4
M 4	x	60*	S	200	310,00A4
M 4	x	70*	S	200	395,00A4
M 5	x	6*	S	100	65,00A4
M 5	x	8*	S	100	37,00A4
M 5	x	10	S	500	29,00A4
M 5	x	10	K	100	34,00A4
M 5	x	12	S	500	29,00A4
M 5	x	12	K	100	34,00A4
M 5	x	14	S	500	29,00A4
M 5	x	14	K	100	34,00A4
M 5	x	16	S	500	20,10A4
M 5	x	16	K	100	25,50A4
M 5	x	18	S	500	28,00A4
M 5	x	18	K	100	33,00A4
M 5	x	20	S	500	21,90A4
M 5	x	20	K	100	27,50A4
M 5	x	22	S	500	29,00A4
M 5	x	22	K	100	34,00A4
M 5	x	25	S	500	22,30A4
M 5	x	25	K	100	27,50A4
M 5	x	30	S	500	27,00A4
M 5	x	30	K	100	32,00A4
M 5	x	35	S	500	33,50A4
M 5	x	35	K	100	38,50A4
M 5	x	40	S	500	36,50A4
M 5	x	40	K	100	42,00A4
M 5	x	45	S	100	40,00A4
M 5	x	50	S	100	45,00A4
M 5	x	55	S	100	63,00A4
M 5	x	60	S	100	80,00A4
M 5	x	70	S	100	95,00A4
M 5	x	80	S	100	212,00A4
M 5	x	90	S	100	580,00A4
M 5	x	100	S	100	1020,00A4
M 6	x	8*	S	100	37,00A4
M 6	x	10	S	500	33,50A4
M 6	x	10	K	100	38,50A4
M 6	x	12	S	500	34,00A4
M 6	x	12	K	100	39,50A4
M 6	x	14	S	500	37,00A4
M 6	x	14	K	100	42,50A4
M 6	x	16	S	500	25,00A4
M 6	x	16	K	100	30,50A4
M 6	x	18	S	500	34,00A4
M 6	x	18	K	100	39,00A4
M 6	x	20	S	500	27,00A4
M 6	x	20	K	100	32,50A4
M 6	x	22	S	500	36,50A4
M 6	x	22	K	100	41,50A4
M 6	x	25	S	500	30,00A4
M 6	x	25	K	100	35,00A4
M 6	x	30	S	500	32,00A4
M 6	x	30	K	100	37,00A4
M 6	x	35	S	500	33,50A4
M 6	x	35	K	100	39,00A4
M 6	x	40	S	500	38,50A4
M 6	x	40	K	100	44,00A4
M 6	x	45	S	500	51,00A4
M 6	x	45	K	100	56,00A4
M 6	x	50	S	500	58,00A4
M 6	x	50	K	100	64,00A4
M 6	x	55	S	500	72,00A4
M 6	x	60	S	500	75,00A4
M 6	x	60	K	100	81,00A4
M 6	x	65	S	500	129,00A4
M 6	x	65	K	100	134,00A4
M 6	x	70	S	500	87,00A4

M 6	x	70	K	100	93,00A4
M 6	x	75	S	100	157,00A4
M 6	x	80	S	100	137,00A4
M 6	x	90	S	100	280,00A4
M 6	x	100	S	100	315,00A4
M 6	x	110	S	100	340,00A4
M 6	x	120	S	100	405,00A4
M 6	x	130	S	100	460,00A4
M 6	x	140	S	100	530,00A4
M 6	x	150	S	100	590,00A4
M 8	x	10	S	100	62,00A4
M 8	x	12	S	200	58,00A4
M 8	x	14	S	200	67,00A4
M 8	x	16	S	200	50,00A4
M 8	x	18	S	200	57,00A4
M 8	x	20	S	200	39,00A4
M 8	x	22	S	200	53,00A4
M 8	x	25	S	200	42,00A4
M 8	x	30	S	200	44,00A4
M 8	x	35	S	200	48,50A4
M 8	x	40	S	200	62,00A4
M 8	x	45	S	200	72,00A4
M 8	x	50	S	200	82,00A4
M 8	x	55	S	200	93,00A4
M 8	x	60	S	200	97,00A4
M 8	x	65	S	200	189,00A4
M 8	x	70	S	200	152,00A4
M 8	x	75	S	200	290,00A4
M 8	x	80	S	200	189,00A4
M 8	x	90	S	200	214,00A4
M 8	x	100	S	200	242,00A4
M 8	x	110	S	50	390,00A4
M 8	x	120	S	50	450,00A4
M 8	x	130	S	50	495,00A4
M 8	x	140	S	50	560,00A4
M 8	x	150	S	50	630,00A4
M 8	x	160*	S	50	1530,00A4
M 8	x	170*	S	50	1930,00A4
M 8	x	180*	S	50	2600,00A4
M 10	x	10*	S	100	475,00A4
M 10	x	12	S	100	152,00A4
M 10	x	16	S	100	92,00A4
M 10	x	18	S	100	120,00A4
M 10	x	20	S	100	73,00A4
M 10	x	25	S	100	70,00A4
M 10	x	30	S	100	73,00A4
M 10	x	35	S	100	79,00A4
M 10	x	40	S	100	84,00A4
M 10	x	45	S	100	100,00A4
M 10	x	50	S	100	113,00A4
M 10	x	55	S	100	133,00A4
M 10	x	60	S	100	144,00A4
M 10	x	65	S	100	207,00A4
M 10	x	70	S	100	167,00A4
M 10	x	75	S	100	295,00A4
M 10	x	80	S	100	197,00A4
M 10	x	90	S	100	242,00A4
M 10	x	100	S	100	300,00A4
M 10	x	110	S	50	520,00A4
M 10	x	120	S	50	560,00A4
M 10	x	130	S	1	670,00A4
M 10	x	140	S	1	810,00A4
M 10	x	150	S	1	890,00A4
M 10	x	160*	S	1	2410,00A4
M 10	x	170*	S	1	2750,00A4
M 10	x	180*	S	1	3450,00A4
M 12	x	16	S	100	219,00A4
M 12	x	20	S	100	155,00A4
M 12	x	25	S	100	148,00A4
M 12	x	30	S	100	112,00A4
M 12	x	35	S	100	120,00A4
M 12	x	40	S	100	129,00A4
M 12	x	45	S	100	146,00A4
M 12	x	50	S	100	157,00A4
M 12	x	55	S	100	197,00A4

Abmessungen	VE	Stück	€/100/0bf.
M 12 x 60	S	100	210,00 A4
M 12 x 65	S	100	280,00 A4
M 12 x 70	S	100	233,00 A4
M 12 x 75	S	100	420,00 A4
M 12 x 80	S	100	285,00 A4
M 12 x 90	S	100	330,00 A4
M 12 x 100	S	100	390,00 A4
M 12 x 110	S	10	700,00 A4
M 12 x 120	S	10	770,00 A4
M 12 x 130	S	10	920,00 A4
M 12 x 140	S	1	1080,00 A4
M 12 x 150	S	1	1240,00 A4
M 12 x 160	S	1	3050,00 A4
M 12 x 170*	S	1	3250,00 A4
M 12 x 180*	S	1	3500,00 A4
M 14 x 20	S	50	1140,00 A4
M 14 x 25	S	50	850,00 A4
M 14 x 30	S	50	750,00 A4
M 14 x 35	S	50	750,00 A4
M 14 x 40	S	50	750,00 A4
M 14 x 45	S	50	810,00 A4
M 14 x 50	S	50	860,00 A4
M 14 x 55	S	50	980,00 A4
M 14 x 60	S	50	1100,00 A4
M 14 x 65	S	50	1430,00 A4
M 14 x 70	S	1	1200,00 A4
M 14 x 80	S	1	1650,00 A4
M 14 x 90	S	1	1870,00 A4
M 14 x 100	S	1	2120,00 A4
M 14 x 110	S	1	3300,00 A4
M 14 x 120	S	1	3900,00 A4
M 14 x 130	S	1	4450,00 A4
M 14 x 140	S	1	5100,00 A4
M 14 x 150	S	1	5800,00 A4
M 16 x 20	S	50	700,00 A4
M 16 x 25	S	25	470,00 A4
M 16 x 30	S	25	415,00 A4
M 16 x 35	S	25	415,00 A4
M 16 x 40	S	25	415,00 A4
M 16 x 45	S	25	450,00 A4
M 16 x 50	S	25	475,00 A4
M 16 x 55	S	25	550,00 A4
M 16 x 60	S	25	610,00 A4
M 16 x 65	S	25	800,00 A4
M 16 x 70	S	25	670,00 A4
M 16 x 75	S	1	1290,00 A4
M 16 x 80	S	25	920,00 A4
M 16 x 90	S	25	1040,00 A4
M 16 x 100	S	25	1180,00 A4
M 16 x 110	S	1	1830,00 A4
M 16 x 120	S	1	2150,00 A4
M 16 x 130	S	1	2470,00 A4
M 16 x 140	S	1	2800,00 A4
M 16 x 150	S	1	3250,00 A4
M 16 x 160	S	1	4650,00 A4
M 16 x 170*	S	1	4950,00 A4
M 16 x 180*	S	1	5300,00 A4
M 16 x 190*	S	1	5600,00 A4
M 16 x 200*	S	1	6100,00 A4
M 16 x 220*	S	1	9400,00 A4
M 16 x 240*	S	1	11100,00 A4
M 16 x 250*	S	1	12100,00 A4
M 16 x 260*	S	1	13500,00 A4
M 16 x 280*	S	1	16200,00 A4
M 16 x 300*	S	1	19500,00 A4
M 18 x 40*	S	1	1970,00 A4
M 18 x 45*	S	1	1970,00 A4
M 18 x 50*	S	1	2220,00 A4
M 18 x 55*	S	1	2400,00 A4
M 18 x 60*	S	1	2600,00 A4
M 18 x 65*	S	1	3350,00 A4
M 18 x 70*	S	1	2850,00 A4
M 18 x 75*	S	1	4350,00 A4
M 18 x 80*	S	1	3650,00 A4
M 18 x 90*	S	1	4150,00 A4

Abmessungen	VE	Stück	€/100/0bf.
M 18 x 100*	S	1	4650,00 A4
M 18 x 110*	S	1	7200,00 A4
M 18 x 120*	S	1	8100,00 A4
M 20 x 30	S	1	1610,00 A4
M 20 x 35	S	1	1610,00 A4
M 20 x 40	S	10	1040,00 A4
M 20 x 45	S	10	1130,00 A4
M 20 x 50	S	10	1200,00 A4
M 20 x 55	S	1	1280,00 A4
M 20 x 60	S	1	1390,00 A4
M 20 x 65	S	1	2260,00 A4
M 20 x 70	S	1	1490,00 A4
M 20 x 75	S	1	2800,00 A4
M 20 x 80	S	1	1930,00 A4
M 20 x 90	S	1	2260,00 A4
M 20 x 100	S	1	2600,00 A4
M 20 x 110	S	1	3800,00 A4
M 20 x 120	S	1	4100,00 A4
M 20 x 130	S	1	5100,00 A4
M 20 x 140	S	1	5700,00 A4
M 20 x 150	S	1	6500,00 A4
M 20 x 160*	S	1	7000,00 A4
M 20 x 170*	S	1	7300,00 A4
M 20 x 180*	S	1	7700,00 A4
M 20 x 190*	S	1	8100,00 A4
M 20 x 200*	S	1	8600,00 A4
M 24 x 40	S	1	4300,00 A4
M 24 x 45	S	1	4300,00 A4
M 24 x 50	S	1	3800,00 A4
M 24 x 55	S	1	4950,00 A4
M 24 x 60	S	1	3800,00 A4
M 24 x 65	S	1	5200,00 A4
M 24 x 70	S	1	4200,00 A4
M 24 x 75	S	1	5500,00 A4
M 24 x 80	S	1	4550,00 A4
M 24 x 90	S	1	4850,00 A4
M 24 x 100	S	1	5400,00 A4
M 24 x 110	S	1	5900,00 A4
M 24 x 120	S	1	6500,00 A4
M 24 x 130	S	1	7000,00 A4
M 24 x 140	S	1	7600,00 A4
M 24 x 150	S	1	8100,00 A4
M 24 x 160*	S	1	8700,00 A4
M 24 x 180*	S	1	9600,00 A4
M 24 x 190*	S	1	10100,00 A4
M 24 x 200*	S	1	10600,00 A4
M 24 x 210*	S	1	16600,00 A4
M 24 x 220*	S	1	18300,00 A4
M 24 x 230*	S	1	20600,00 A4
M 24 x 240*	S	1	23800,00 A4
M 30 x 50*	S	1	7100,00 A4
M 30 x 60*	S	1	7200,00 A4
M 30 x 70*	S	1	7800,00 A4
M 30 x 80*	S	1	8200,00 A4
M 30 x 90*	S	1	8600,00 A4
M 30 x 100*	S	1	9100,00 A4
M 30 x 110*	S	1	9500,00 A4
M 30 x 120*	S	1	9900,00 A4
M 30 x 130*	S	1	10300,00 A4
M 30 x 140*	S	1	10800,00 A4
M 30 x 150*	S	1	11200,00 A4
M 30 x 160*	S	1	14300,00 A4
M 30 x 170*	S	1	17500,00 A4
M 30 x 180*	S	1	21400,00 A4
M 30 x 200*	S	1	27500,00 A4

Abmessungen	VE	Stück	€/100/0bf.
DIN		00912.948	
912		A 4 - 80	

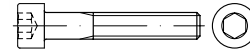

Zylinderschrauben mit Innensechskant

hochfest (stark kaltverfestigt)

Maße → TI-12 Anziehmomente → TI-249
 Werkstoffeigensch. → TI-236 Normumstellung → TI-6

Stahl → S. 115

DIN 912 → wird ersetzt durch ISO 4762

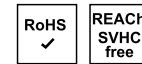

M 6 x 8	S	100	124,00 A4-80
M 6 x 10	S	100	124,00 A4-80
M 6 x 12	S	100	102,00 A4-80
M 6 x 14	S	100	126,00 A4-80
M 6 x 16	S	100	76,00 A4-80
M 6 x 20	S	100	83,00 A4-80
M 6 x 25	S	100	91,00 A4-80
M 6 x 30	S	100	98,00 A4-80
M 6 x 35	S	100	102,00 A4-80
M 6 x 40	S	100	118,00 A4-80
M 6 x 45	S	100	187,00 A4-80
M 6 x 50	S	100	175,00 A4-80
M 6 x 55	S	100	217,00 A4-80
M 6 x 60	S	100	227,00 A4-80
M 6 x 70	S	100	265,00 A4-80
M 8 x 10	S	100	208,00 A4-80
M 8 x 12	S	100	244,00 A4-80
M 8 x 16	S	100	152,00 A4-80
M 8 x 20	S	100	118,00 A4-80
M 8 x 25	S	100	126,00 A4-80
M 8 x 30	S	100	133,00 A4-80
M 8 x 35	S	100	147,00 A4-80
M 8 x 40	S	100	185,00 A4-80
M 8 x 45	S	100	217,00 A4-80
M 8 x 50	S	100	246,00 A4-80
M 8 x 55	S	100	280,00 A4-80
M 8 x 60	S	100	295,00 A4-80
M 8 x 70	S	100	460,00 A4-80
M 8 x 80	S	50	570,00 A4-80
M 8 x 90	S	50	660,00 A4-80
M 8 x 100	S	50	740,00 A4-80
M 10 x 16	S	100	275,00 A4-80
M 10 x 20	S	100	280,00 A4-80
M 10 x 25	S	100	210,00 A4-80
M 10 x 30	S	100	221,00 A4-80
M 10 x 35	S	100	240,00 A4-80
M 10 x 40	S	100	255,00 A4-80
M 10 x 45	S	100	300,00 A4-80
M 10 x 50	S	100	340,00 A4-80
M 10 x 55	S	50	405,00 A4-80
M 10 x 60	S	50	435,00 A4-80
M 10 x 70	S	50	500,00 A4-80
M 10 x 80	S	50	600,00 A4-80
M 10 x 90	S	50	740,00 A4-80
M 10 x 100	S	50	910,00 A4-80
M 12 x 20	S	100	465,00 A4-80
M 12 x 25	S	100	445,00 A4-80
M 12 x 30	S	100	340,00 A4-80
M 12 x 35	S	50	365,00 A4-80
M 12 x 40	S	50	390,00 A4-80
M 12 x 45	S	50	440,00 A4-80
M 12 x 50	S	50	470,00 A4-80

Abmessungen	VE	Stück	€/100/Obf.
M 12 x 55	S	50	600,00 A4-80
M 12 x 60	S	50	640,00 A4-80
M 12 x 70	S	50	710,00 A4-80
M 12 x 80	S	50	870,00 A4-80
M 12 x 90	S	50	1010,00 A4-80
M 12 x 100	S	50	1180,00 A4-80
M 16 x 20	S	50	3050,00 A4-80
M 16 x 25	S	50	1430,00 A4-80
M 16 x 30	S	50	1260,00 A4-80
M 16 x 35	S	50	1260,00 A4-80
M 16 x 40	S	50	1260,00 A4-80
M 16 x 45	S	50	1370,00 A4-80
M 16 x 50	S	50	1450,00 A4-80
M 16 x 55	S	25	1660,00 A4-80
M 16 x 60	S	25	1850,00 A4-80
M 16 x 70	S	25	2020,00 A4-80
M 16 x 80	S	1	2800,00 A4-80
M 16 x 90	S	1	3150,00 A4-80
M 16 x 100	S	1	3550,00 A4-80
M 20 x 30	S	1	4850,00 A4-80
M 20 x 35	S	1	4300,00 A4-80
M 20 x 40	S	1	3150,00 A4-80
M 20 x 45	S	1	3400,00 A4-80
M 20 x 50	S	1	3650,00 A4-80
M 20 x 60	S	1	4200,00 A4-80
M 20 x 70	S	1	4500,00 A4-80
M 20 x 80	S	1	5900,00 A4-80
M 20 x 90	S	1	6900,00 A4-80
M 20 x 100	S	1	7800,00 A4-80
M 20 x 110	S	1	7400,00 A4-80

DIN	00913.910
913	A 1/A 2

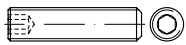

Gewindestifte mit Kegelhülse, mit Innensechskant

Maße → **TI-20** Normumstellung → **TI-6**
 Werkstoffeigensch. → **TI-236**

Stahl → **S. 134**

DIN 913 → wird ersetzt durch ISO 4026 (austauschbar)



M 2 x 2	S	500	161,00 A1/A2
M 2 x 3	S	500	112,00 A1/A2
M 2 x 4	S	500	114,00 A1/A2
M 2 x 5	S	500	114,00 A1/A2
M 2 x 6	S	500	114,00 A1/A2
M 2 x 8	S	500	116,00 A1/A2
M 2,5 x 3	S	500	88,00 A1/A2
M 2,5 x 4	S	500	86,00 A1/A2
M 2,5 x 5	S	500	86,00 A1/A2
M 2,5 x 6	S	500	86,00 A1/A2
M 3 x 2	S	500	87,00 A1/A2
M 3 x 3	S	500	43,50 A1/A2
M 3 x 4	S	500	47,00 A1/A2
M 3 x 5	S	500	46,50 A1/A2
M 3 x 6	S	500	51,00 A1/A2
M 3 x 8	S	500	53,00 A1/A2
M 3 x 10	S	500	54,00 A1/A2
M 3 x 12	S	500	60,00 A1/A2
M 3 x 16	S	500	44,50 A1/A2
M 3 x 20	S	500	58,00 A1/A2
M 3 x 25	S	500	99,00 A1/A2

Abmessungen	VE	Stück	€/100/Obf.
M 4 x 4	S	500	33,00 A1/A2
M 4 x 5	S	500	33,00 A1/A2
M 4 x 6	S	500	33,50 A1/A2
M 4 x 8	S	500	34,50 A1/A2
M 4 x 10	S	500	37,00 A1/A2
M 4 x 12	S	500	39,00 A1/A2
M 4 x 16	S	500	42,50 A1/A2
M 4 x 20	S	500	45,50 A1/A2
M 4 x 25	S	500	78,00 A1/A2
M 4 x 30	S	200	86,00 A1/A2
M 5 x 4	S	500	36,00 A1/A2
M 5 x 5	S	500	37,00 A1/A2
M 5 x 6	S	500	37,50 A1/A2
M 5 x 8	S	500	38,50 A1/A2
M 5 x 10	S	500	39,50 A1/A2
M 5 x 12	S	500	41,50 A1/A2
M 5 x 16	S	500	45,50 A1/A2
M 5 x 20	S	500	54,00 A1/A2
M 5 x 25	S	200	60,00 A1/A2
M 5 x 30	S	200	105,00 A1/A2
M 5 x 35	S	200	149,00 A1/A2
M 5 x 40	S	200	152,00 A1/A2
M 5 x 45	S	200	161,00 A1/A2
M 6 x 5	S	500	42,50 A1/A2
M 6 x 6	S	500	42,50 A1/A2
M 6 x 8	S	500	44,50 A1/A2
M 6 x 10	S	500	45,50 A1/A2
M 6 x 12	S	500	47,50 A1/A2
M 6 x 16	S	500	54,00 A1/A2
M 6 x 20	S	500	62,00 A1/A2
M 6 x 25	S	200	71,00 A1/A2
M 6 x 30	S	200	82,00 A1/A2
M 6 x 35	S	200	101,00 A1/A2
M 6 x 40	S	200	110,00 A1/A2
M 6 x 45	S	100	255,00 A1/A2
M 6 x 50	S	100	300,00 A1/A2
M 6 x 60	S	100	340,00 A1/A2
M 8 x 6	S	500	91,00 A1/A2
M 8 x 8	S	500	62,00 A1/A2
M 8 x 10	S	500	62,00 A1/A2
M 8 x 12	S	200	68,00 A1/A2
M 8 x 16	S	200	74,00 A1/A2
M 8 x 20	S	200	88,00 A1/A2
M 8 x 25	S	200	101,00 A1/A2
M 8 x 30	S	100	116,00 A1/A2
M 8 x 35	S	100	141,00 A1/A2
M 8 x 40	S	100	163,00 A1/A2
M 8 x 45	S	100	178,00 A1/A2
M 8 x 50	S	50	224,00 A1/A2
M 8 x 60	S	50	405,00 A1/A2
M 8 x 70	S	50	520,00 A1/A2
M 8 x 80	S	50	630,00 A1/A2
M 8 x 100	S	50	740,00 A1/A2
M 10 x 10	S	200	91,00 A1/A2
M 10 x 12	S	100	93,00 A1/A2
M 10 x 16	S	100	99,00 A1/A2
M 10 x 18	S	100	114,00 A1/A2
M 10 x 20	S	100	120,00 A1/A2
M 10 x 25	S	100	142,00 A1/A2
M 10 x 30	S	100	165,00 A1/A2
M 10 x 35	S	50	201,00 A1/A2
M 10 x 40	S	50	212,00 A1/A2
M 10 x 45	S	50	226,00 A1/A2
M 10 x 50	S	50	247,00 A1/A2
M 10 x 60	S	50	345,00 A1/A2
M 10 x 70	S	50	440,00 A1/A2
M 10 x 80	S	50	540,00 A1/A2
M 10 x 100	S	50	660,00 A1/A2
M 12 x 10	S	50	190,00 A1/A2
M 12 x 12	S	50	192,00 A1/A2
M 12 x 16	S	50	192,00 A1/A2
M 12 x 20	S	50	218,00 A1/A2
M 12 x 25	S	50	239,00 A1/A2
M 12 x 30	S	50	260,00 A1/A2
M 12 x 35	S	25	285,00 A1/A2

Abmessungen	VE	Stück	€/100/Obf.
M 12 x 40	S	25	315,00 A1/A2
M 12 x 45	S	25	355,00 A1/A2
M 12 x 50	S	25	385,00 A1/A2
M 12 x 60	S	25	560,00 A1/A2
M 12 x 70	S	25	1040,00 A1/A2
M 12 x 80	S	25	1080,00 A1/A2
M 12 x 90	S	10	1210,00 A1/A2
M 16 x 16	S	10	420,00 A1/A2
M 16 x 20	S	10	610,00 A1/A2
M 16 x 25	S	10	1130,00 A1/A2
M 16 x 30	S	10	660,00 A1/A2
M 16 x 40	S	10	1070,00 A1/A2
M 16 x 50	S	10	1830,00 A1/A2
M 16 x 60	S	10	1940,00 A1/A2
M 16 x 70	S	10	2280,00 A1/A2
M 16 x 80	S	10	2750,00 A1/A2
M 16 x 90	S	10	2950,00 A1/A2
M 16 x 100	S	10	3300,00 A1/A2
M 20 x 20	S	10	1860,00 A1/A2
M 20 x 25	S	10	1940,00 A1/A2
M 20 x 30	S	10	2280,00 A1/A2
M 20 x 35	S	10	2900,00 A1/A2
M 20 x 40	S	10	3000,00 A1/A2
M 20 x 50	S	10	3150,00 A1/A2
M 20 x 60	S	10	3900,00 A1/A2
M 20 x 70	S	10	4100,00 A1/A2
M 20 x 80	S	10	4500,00 A1/A2
M 20 x 90	S	10	4950,00 A1/A2
M 20 x 100	S	10	5400,00 A1/A2

DIN	00913.940
913	A 4

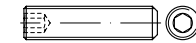

Gewindestifte mit Kegelhülse, mit Innensechskant

Maße → **TI-20** Normumstellung → **TI-6**
 Werkstoffeigensch. → **TI-236**

Stahl → **S. 134**

DIN 913 → wird ersetzt durch ISO 4026 (austauschbar)

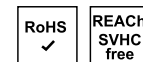

M 3 x 4	S	500	84,00 A4
M 3 x 5	S	500	89,00 A4
M 3 x 6	S	500	98,00 A4
M 3 x 8	S	500	112,00 A4
M 4 x 5	S	500	110,00 A4
M 4 x 6	S	500	114,00 A4
M 4 x 8	S	500	120,00 A4
M 4 x 10	S	500	126,00 A4
M 4 x 12	S	500	135,00 A4
M 4 x 16	S	500	156,00 A4
M 4 x 20	S	500	164,00 A4
M 5 x 5	S	500	128,00 A4
M 5 x 6	S	500	128,00 A4
M 5 x 8	S	500	131,00 A4
M 5 x 10	S	500	141,00 A4
M 5 x 12	S	500	154,00 A4
M 5 x 16	S	500	164,00 A4
M 5 x 20	S	500	185,00 A4
M 5 x 25	S	200	193,00 A4
M 5 x 30	S	200	210,00 A4
M 6 x 6	S	500	143,00 A4
M 6 x 8	S	500	145,00 A4

Abmessungen	VE	Stück	€/100/Obf.
M 6 x 10	S	500	154,00 A4
M 6 x 12	S	500	162,00 A4
M 6 x 16	S	500	185,00 A4
M 6 x 20	S	500	208,00 A4
M 6 x 25	S	200	248,00 A4
M 6 x 30	S	200	275,00 A4
M 6 x 35	S	200	290,00 A4
M 6 x 40	S	200	315,00 A4
M 6 x 45	S	100	340,00 A4
M 6 x 50	S	100	385,00 A4
M 8 x 8	S	500	198,00 A4
M 8 x 10	S	500	198,00 A4
M 8 x 12	S	200	221,00 A4
M 8 x 16	S	200	244,00 A4
M 8 x 20	S	200	295,00 A4
M 8 x 25	S	200	360,00 A4
M 8 x 30	S	100	390,00 A4
M 8 x 35	S	100	435,00 A4
M 8 x 40	S	100	470,00 A4
M 8 x 50	S	50	580,00 A4
M 8 x 60	S	50	680,00 A4
M 10 x 10	S	200	315,00 A4
M 10 x 12	S	100	315,00 A4
M 10 x 16	S	100	340,00 A4
M 10 x 20	S	100	435,00 A4
M 10 x 25	S	100	495,00 A4
M 10 x 30	S	100	465,00 A4
M 10 x 35	S	50	495,00 A4
M 10 x 40	S	50	530,00 A4
M 10 x 45	S	50	570,00 A4
M 10 x 50	S	50	640,00 A4
M 10 x 60	S	50	830,00 A4
M 10 x 70	S	50	1020,00 A4
M 12 x 12	S	50	360,00 A4
M 12 x 16	S	50	360,00 A4
M 12 x 20	S	50	445,00 A4
M 12 x 25	S	50	495,00 A4
M 12 x 30	S	50	540,00 A4
M 12 x 35	S	25	600,00 A4
M 12 x 40	S	25	640,00 A4
M 12 x 45	S	25	700,00 A4
M 12 x 50	S	25	750,00 A4
M 12 x 55	S	25	890,00 A4
M 12 x 60	S	25	1000,00 A4
M 16 x 16	S	10	1490,00 A4
M 16 x 20	S	10	2420,00 A4
M 16 x 25	S	10	750,00 A4
M 16 x 30	S	10	880,00 A4
M 16 x 35	S	10	970,00 A4
M 16 x 40	S	10	1010,00 A4
M 16 x 50	S	10	4050,00 A4
M 20 x 20	S	10	3900,00 A4
M 20 x 25	S	10	4200,00 A4
M 20 x 30	S	10	4550,00 A4
M 20 x 35	S	10	5100,00 A4
M 20 x 40	S	10	5800,00 A4
M 20 x 50	S	10	6900,00 A4
M 24 x 25	S	10	6500,00 A4
M 24 x 30	S	10	6900,00 A4
M 24 x 35	S	10	7600,00 A4
M 24 x 40	S	10	7900,00 A4
M 24 x 45	S	10	8200,00 A4
M 24 x 50	S	10	8800,00 A4

Abmessungen	VE	Stück	€/100/Obf.
DIN	00914.910		
914	A 1/A 2		



Gewindestifte mit Spitze, mit Innensechskant

Maße → TI-20 Normumstellung → TI-6
 Werkstoffeigensch. → TI-236

Stahl → S. 137

DIN 914 → wird ersetzt durch ISO 4027 (austauschbar)



M 2 x 2	S	500	142,00 A1/A 2
M 2 x 3	S	500	108,00 A1/A 2
M 2 x 4	S	500	108,00 A1/A 2
M 2 x 5	S	500	110,00 A1/A 2
M 2 x 6	S	500	110,00 A1/A 2
M 2 x 8	S	500	110,00 A1/A 2
M 2,5 x 4	S	500	83,00 A1/A 2
M 2,5 x 5	S	500	84,00 A1/A 2
M 2,5 x 6	S	500	84,00 A1/A 2
M 3 x 3	S	500	55,00 A1/A 2
M 3 x 4	S	500	45,50 A1/A 2
M 3 x 5	S	500	45,00 A1/A 2
M 3 x 6	S	500	48,50 A1/A 2
M 3 x 8	S	500	51,00 A1/A 2
M 3 x 10	S	500	53,00 A1/A 2
M 3 x 12	S	500	59,00 A1/A 2
M 3 x 16	S	500	65,00 A1/A 2
M 4 x 4	S	500	46,00 A1/A 2
M 4 x 5	S	500	42,50 A1/A 2
M 4 x 6	S	500	43,50 A1/A 2
M 4 x 8	S	500	44,00 A1/A 2
M 4 x 10	S	500	47,00 A1/A 2
M 4 x 12	S	500	51,00 A1/A 2
M 4 x 16	S	500	55,00 A1/A 2
M 4 x 20	S	500	66,00 A1/A 2
M 4 x 25	S	500	101,00 A1/A 2
M 4 x 30	S	200	110,00 A1/A 2
M 5 x 4	S	500	67,00 A1/A 2
M 5 x 5	S	500	57,00 A1/A 2
M 5 x 6	S	500	53,00 A1/A 2
M 5 x 8	S	500	54,00 A1/A 2
M 5 x 10	S	500	56,00 A1/A 2
M 5 x 12	S	500	59,00 A1/A 2
M 5 x 16	S	500	65,00 A1/A 2
M 5 x 20	S	500	77,00 A1/A 2
M 5 x 25	S	200	85,00 A1/A 2
M 5 x 30	S	200	148,00 A1/A 2
M 6 x 6	S	500	59,00 A1/A 2
M 6 x 8	S	500	58,00 A1/A 2
M 6 x 10	S	500	59,00 A1/A 2
M 6 x 12	S	500	62,00 A1/A 2
M 6 x 16	S	500	71,00 A1/A 2
M 6 x 20	S	500	80,00 A1/A 2
M 6 x 25	S	200	89,00 A1/A 2
M 6 x 30	S	200	105,00 A1/A 2
M 6 x 35	S	200	127,00 A1/A 2
M 6 x 40	S	200	142,00 A1/A 2
M 6 x 45	S	100	330,00 A1/A 2
M 6 x 50	S	100	385,00 A1/A 2
M 8 x 8	S	500	86,00 A1/A 2
M 8 x 10	S	500	79,00 A1/A 2
M 8 x 12	S	200	87,00 A1/A 2

Abmessungen	VE	Stück	€/100/Obf.
M 8 x 16	S	200	95,00 A1/A 2
M 8 x 20	S	200	112,00 A1/A 2
M 8 x 25	S	200	129,00 A1/A 2
M 8 x 30	S	100	148,00 A1/A 2
M 8 x 35	S	100	180,00 A1/A 2
M 8 x 40	S	100	209,00 A1/A 2
M 8 x 45	S	100	228,00 A1/A 2
M 8 x 50	S	50	290,00 A1/A 2
M 8 x 60	S	50	530,00 A1/A 2
M 10 x 10	S	200	127,00 A1/A 2
M 10 x 12	S	100	120,00 A1/A 2
M 10 x 16	S	100	127,00 A1/A 2
M 10 x 20	S	100	154,00 A1/A 2
M 10 x 25	S	100	203,00 A1/A 2
M 10 x 30	S	100	212,00 A1/A 2
M 10 x 35	S	50	260,00 A1/A 2
M 10 x 40	S	50	275,00 A1/A 2
M 10 x 50	S	50	320,00 A1/A 2
M 10 x 60	S	50	440,00 A1/A 2
M 12 x 16	S	50	207,00 A1/A 2
M 12 x 20	S	50	235,00 A1/A 2
M 12 x 25	S	50	260,00 A1/A 2
M 12 x 30	S	50	280,00 A1/A 2
M 12 x 35	S	25	305,00 A1/A 2
M 12 x 40	S	25	335,00 A1/A 2
M 12 x 50	S	25	415,00 A1/A 2
M 12 x 60	S	25	540,00 A1/A 2

Abmessungen	VE	Stück	€/100/Obf.
DIN	00914.940		
914	A 4		

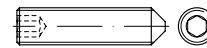

Gewindestifte mit Spitze, mit Innensechskant

Maße → TI-20 Normumstellung → TI-6
 Werkstoffeigensch. → TI-236

Stahl → S. 137

DIN 914 → wird ersetzt durch ISO 4027 (austauschbar)

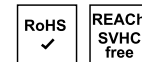

M 2,5 x 8	S	500	240,00 A4
M 3 x 4	S	500	74,00 A4
M 3 x 5	S	500	93,00 A4
M 3 x 6	S	500	93,00 A4
M 3 x 8	S	500	105,00 A4
M 3 x 10	S	500	118,00 A4
M 4 x 4	S	500	104,00 A4
M 4 x 5	S	500	104,00 A4
M 4 x 6	S	500	107,00 A4
M 4 x 8	S	500	114,00 A4
M 4 x 10	S	500	120,00 A4
M 4 x 12	S	500	128,00 A4
M 4 x 16	S	500	147,00 A4
M 4 x 20	S	500	156,00 A4
M 5 x 5	S	500	122,00 A4
M 5 x 6	S	500	122,00 A4
M 5 x 8	S	500	124,00 A4
M 5 x 10	S	500	133,00 A4
M 5 x 12	S	500	145,00 A4
M 5 x 16	S	500	156,00 A4
M 5 x 20	S	500	177,00 A4
M 5 x 25	S	200	183,00 A4
M 5 x 30	S	200	200,00 A4
M 6 x 6	S	500	135,00 A4

Abmessungen	VE	Stück	€/100/Obf.
M 6 x 8	S	500	137,00 A4
M 6 x 10	S	500	145,00 A4
M 6 x 12	S	500	154,00 A4
M 6 x 16	S	500	175,00 A4
M 6 x 20	S	500	198,00 A4
M 6 x 25	S	200	235,00 A4
M 6 x 30	S	200	260,00 A4
M 6 x 35	S	200	275,00 A4
M 6 x 45	S	100	320,00 A4
M 6 x 50	S	100	365,00 A4
M 8 x 8	S	500	189,00 A4
M 8 x 10	S	500	189,00 A4
M 8 x 12	S	200	210,00 A4
M 8 x 16	S	200	231,00 A4
M 8 x 20	S	200	280,00 A4
M 8 x 25	S	200	340,00 A4
M 8 x 30	S	100	370,00 A4
M 8 x 35	S	100	415,00 A4
M 8 x 40	S	100	445,00 A4
M 8 x 45	S	100	490,00 A4
M 8 x 50	S	50	560,00 A4
M 8 x 60	S	50	640,00 A4
M 10 x 10	S	200	300,00 A4
M 10 x 12	S	100	300,00 A4
M 10 x 16	S	100	320,00 A4
M 10 x 20	S	100	410,00 A4
M 10 x 25	S	100	470,00 A4
M 10 x 30	S	100	530,00 A4
M 10 x 35	S	50	570,00 A4
M 10 x 40	S	50	600,00 A4
M 10 x 45	S	50	660,00 A4
M 10 x 50	S	50	740,00 A4
M 10 x 60	S	50	950,00 A4
M 12 x 12	S	50	410,00 A4
M 12 x 16	S	50	410,00 A4
M 12 x 20	S	50	510,00 A4
M 12 x 25	S	50	570,00 A4
M 12 x 30	S	50	610,00 A4
M 12 x 35	S	25	690,00 A4
M 12 x 40	S	25	740,00 A4
M 12 x 45	S	25	790,00 A4
M 12 x 50	S	25	850,00 A4
M 12 x 60	S	25	1140,00 A4
M 16 x 20	S	10	830,00 A4
M 16 x 25	S	10	850,00 A4
M 16 x 30	S	10	1000,00 A4
M 16 x 40	S	10	1160,00 A4
M 16 x 50	S	10	1180,00 A4
M 16 x 60	S	10	1220,00 A4

Abmessungen	VE	Stück	€/100/Obf.
DIN		00915.910	
915		A 1/A 2	



Gewindestifte mit Zapfen, mit Innensechskant

Maße → **TI-20** Normumstellung → **TI-6**
 Werkstoffeigensch. → **TI-236**

Stahl → **S. 138**
 DIN 915 → wird ersetzt durch ISO 4028 (austauschbar)



M 2 x 6	S	500	86,00 A1/A 2
M 2 x 10	S	500	110,00 A1/A 2
M 3 x 4	S	500	59,00 A1/A 2
M 3 x 5	S	500	59,00 A1/A 2
M 3 x 6	S	500	61,00 A1/A 2
M 3 x 8	S	500	71,00 A1/A 2
M 3 x 10	S	500	72,00 A1/A 2
M 3 x 12	S	500	78,00 A1/A 2
M 4 x 5	S	500	45,50 A1/A 2
M 4 x 6	S	500	46,00 A1/A 2
M 4 x 8	S	500	46,50 A1/A 2
M 4 x 10	S	500	51,00 A1/A 2
M 4 x 12	S	500	53,00 A1/A 2
M 4 x 16	S	500	58,00 A1/A 2
M 4 x 20	S	500	70,00 A1/A 2
M 4 x 25	S	500	106,00 A1/A 2
M 5 x 5	S	500	60,00 A1/A 2
M 5 x 6	S	500	57,00 A1/A 2
M 5 x 8	S	500	58,00 A1/A 2
M 5 x 10	S	500	60,00 A1/A 2
M 5 x 12	S	500	63,00 A1/A 2
M 5 x 16	S	500	69,00 A1/A 2
M 5 x 20	S	500	82,00 A1/A 2
M 5 x 25	S	200	89,00 A1/A 2
M 5 x 30	S	200	156,00 A1/A 2
M 5 x 35	S	200	161,00 A1/A 2
M 6 x 6	S	500	63,00 A1/A 2
M 6 x 8	S	500	61,00 A1/A 2
M 6 x 10	S	500	63,00 A1/A 2
M 6 x 12	S	500	66,00 A1/A 2
M 6 x 16	S	500	74,00 A1/A 2
M 6 x 20	S	500	85,00 A1/A 2
M 6 x 25	S	200	95,00 A1/A 2
M 6 x 30	S	200	112,00 A1/A 2
M 6 x 35	S	200	137,00 A1/A 2
M 6 x 40	S	200	152,00 A1/A 2
M 6 x 50	S	100	405,00 A1/A 2
M 8 x 8	S	500	90,00 A1/A 2
M 8 x 10	S	500	85,00 A1/A 2
M 8 x 12	S	200	92,00 A1/A 2
M 8 x 16	S	200	101,00 A1/A 2
M 8 x 20	S	200	120,00 A1/A 2
M 8 x 25	S	200	137,00 A1/A 2
M 8 x 30	S	100	158,00 A1/A 2
M 8 x 35	S	100	192,00 A1/A 2
M 8 x 40	S	100	222,00 A1/A 2
M 8 x 45	S	100	243,00 A1/A 2
M 8 x 60	S	50	550,00 A1/A 2
M 10 x 10	S	200	137,00 A1/A 2
M 10 x 12	S	100	127,00 A1/A 2
M 10 x 16	S	100	135,00 A1/A 2
M 10 x 20	S	100	163,00 A1/A 2

Abmessungen	VE	Stück	€/100/Obf.
M 10 x 25	S	100	195,00 A1/A 2
M 10 x 30	S	100	226,00 A1/A 2
M 10 x 35	S	50	275,00 A1/A 2
M 10 x 40	S	50	290,00 A1/A 2
M 10 x 45	S	50	310,00 A1/A 2
M 10 x 50	S	50	340,00 A1/A 2
M 10 x 60	S	50	470,00 A1/A 2
M 12 x 16	S	50	218,00 A1/A 2
M 12 x 20	S	50	250,00 A1/A 2
M 12 x 25	S	50	275,00 A1/A 2
M 12 x 30	S	50	300,00 A1/A 2
M 12 x 40	S	25	360,00 A1/A 2
M 12 x 50	S	25	440,00 A1/A 2
M 12 x 60	S	25	580,00 A1/A 2

Abmessungen	VE	Stück	€/100/Obf.
DIN		00915.940	
915		A 4	

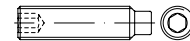

Gewindestifte mit Zapfen, mit Innensechskant

Maße → **TI-20** Normumstellung → **TI-6**
 Werkstoffeigensch. → **TI-236**

Stahl → **S. 138**
 DIN 915 → wird ersetzt durch ISO 4028 (austauschbar)

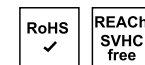

M 4 x 6	S	500	102,00 A4
M 4 x 8	S	500	107,00 A4
M 4 x 10	S	500	116,00 A4
M 4 x 16	S	500	141,00 A4
M 4 x 20	S	500	149,00 A4
M 5 x 6	S	500	116,00 A4
M 5 x 8	S	500	118,00 A4
M 5 x 10	S	500	128,00 A4
M 5 x 12	S	500	139,00 A4
M 5 x 16	S	500	149,00 A4
M 5 x 20	S	500	168,00 A4
M 5 x 25	S	200	177,00 A4
M 6 x 6	S	500	131,00 A4
M 6 x 8	S	500	133,00 A4
M 6 x 10	S	500	139,00 A4
M 6 x 12	S	500	147,00 A4
M 6 x 16	S	500	168,00 A4
M 6 x 20	S	500	189,00 A4
M 6 x 30	S	200	246,00 A4
M 6 x 35	S	200	265,00 A4
M 6 x 40	S	200	285,00 A4
M 6 x 45	S	100	305,00 A4
M 6 x 50	S	100	350,00 A4
M 8 x 8	S	500	181,00 A4
M 8 x 10	S	500	181,00 A4
M 8 x 12	S	200	200,00 A4
M 8 x 16	S	200	221,00 A4
M 8 x 20	S	200	265,00 A4
M 8 x 25	S	200	325,00 A4
M 8 x 30	S	100	355,00 A4
M 8 x 40	S	100	425,00 A4
M 8 x 50	S	50	530,00 A4
M 10 x 10	S	200	340,00 A4
M 10 x 12	S	100	340,00 A4
M 10 x 16	S	100	305,00 A4
M 10 x 20	S	100	395,00 A4
M 10 x 25	S	100	450,00 A4

Wir versorgen Sie mit Verbindungselementen und Befestigungstechnik!

Abmessungen	VE	Stück	€/100/Obf.
M 10 x 30	S	100	510,00 A4
M 10 x 40	S	50	580,00 A4
M 12 x 12	S	50	475,00 A4
M 12 x 16	S	50	390,00 A4
M 12 x 20	S	50	485,00 A4
M 12 x 25	S	50	550,00 A4
M 12 x 30	S	50	590,00 A4
M 12 x 35	S	25	660,00 A4
M 12 x 40	S	25	710,00 A4
M 12 x 50	S	25	820,00 A4
M 12 x 60	S	25	1260,00 A4
M 16 x 25	S	10	820,00 A4
M 16 x 30	S	10	960,00 A4
M 16 x 35	S	10	1050,00 A4
M 16 x 40	S	10	1120,00 A4

DIN	00916.910
916	A 1/A 2

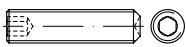

Gewindestifte mit Ringschneide, mit Innensechskant

Maße → TI-21 Normumstellung → TI-6
 Werkstoffeigensch. → TI-236
 Stahl → S. 139

DIN 916 → wird ersetzt durch ISO 4029 (austauschbar)

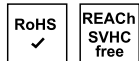

M 2 x 2	S	500	141,00 A1/A2
M 2 x 3	S	500	114,00 A1/A2
M 2 x 4	S	500	116,00 A1/A2
M 2 x 5	S	500	116,00 A1/A2
M 2 x 6	S	500	116,00 A1/A2
M 3 x 4	S	500	48,50 A1/A2
M 3 x 5	S	500	47,50 A1/A2
M 3 x 6	S	500	52,00 A1/A2
M 3 x 8	S	500	53,00 A1/A2
M 3 x 10	S	500	55,00 A1/A2
M 3 x 12	S	500	61,00 A1/A2
M 3 x 16	S	500	120,00 A1/A2
M 3 x 20	S	500	131,00 A1/A2
M 4 x 3	S	500	33,50 A1/A2
M 4 x 4	S	500	33,50 A1/A2
M 4 x 5	S	500	33,50 A1/A2
M 4 x 6	S	500	34,50 A1/A2
M 4 x 8	S	500	35,50 A1/A2
M 4 x 10	S	500	37,50 A1/A2
M 4 x 12	S	500	39,50 A1/A2
M 4 x 16	S	500	43,00 A1/A2
M 4 x 20	S	500	52,00 A1/A2
M 4 x 25	S	500	80,00 A1/A2
M 4 x 30	S	200	88,00 A1/A2
M 5 x 5	S	500	37,50 A1/A2
M 5 x 6	S	500	38,00 A1/A2
M 5 x 8	S	500	39,00 A1/A2
M 5 x 10	S	500	40,00 A1/A2
M 5 x 12	S	500	42,00 A1/A2
M 5 x 16	S	500	46,00 A1/A2
M 5 x 20	S	500	55,00 A1/A2
M 5 x 25	S	200	61,00 A1/A2
M 5 x 30	S	200	106,00 A1/A2
M 6 x 6	S	500	43,50 A1/A2
M 6 x 8	S	500	45,50 A1/A2
M 6 x 10	S	500	46,00 A1/A2

Abmessungen	VE	Stück	€/100/Obf.
M 6 x 12	S	500	48,50 A1/A2
M 6 x 16	S	500	55,00 A1/A2
M 6 x 20	S	500	63,00 A1/A2
M 6 x 25	S	200	71,00 A1/A2
M 6 x 30	S	200	83,00 A1/A2
M 6 x 35	S	200	101,00 A1/A2
M 6 x 40	S	200	112,00 A1/A2
M 6 x 45	S	100	260,00 A1/A2
M 6 x 50	S	100	305,00 A1/A2
M 6 x 60	S	100	345,00 A1/A2
M 8 x 6	S	500	63,00 A1/A2
M 8 x 8	S	500	63,00 A1/A2
M 8 x 10	S	500	63,00 A1/A2
M 8 x 12	S	200	69,00 A1/A2
M 8 x 16	S	200	75,00 A1/A2
M 8 x 20	S	200	88,00 A1/A2
M 8 x 25	S	200	103,00 A1/A2
M 8 x 30	S	100	118,00 A1/A2
M 8 x 35	S	100	142,00 A1/A2
M 8 x 40	S	100	165,00 A1/A2
M 8 x 45	S	100	180,00 A1/A2
M 8 x 50	S	50	226,00 A1/A2
M 8 x 60	S	50	410,00 A1/A2
M 8 x 70	S	50	420,00 A1/A2
M 10 x 10	S	200	93,00 A1/A2
M 10 x 12	S	100	94,00 A1/A2
M 10 x 16	S	100	101,00 A1/A2
M 10 x 20	S	100	122,00 A1/A2
M 10 x 25	S	100	144,00 A1/A2
M 10 x 30	S	100	169,00 A1/A2
M 10 x 35	S	50	203,00 A1/A2
M 10 x 40	S	50	214,00 A1/A2
M 10 x 45	S	50	229,00 A1/A2
M 10 x 50	S	50	250,00 A1/A2
M 10 x 60	S	50	350,00 A1/A2
M 12 x 12	S	50	320,00 A1/A2
M 12 x 16	S	50	194,00 A1/A2
M 12 x 20	S	50	222,00 A1/A2
M 12 x 25	S	50	243,00 A1/A2
M 12 x 30	S	50	265,00 A1/A2
M 12 x 35	S	25	285,00 A1/A2
M 12 x 40	S	25	320,00 A1/A2
M 12 x 50	S	25	390,00 A1/A2
M 12 x 60	S	25	520,00 A1/A2
M 16 x 16	S	10	830,00 A1/A2
M 16 x 20	S	10	650,00 A1/A2
M 16 x 25	S	10	780,00 A1/A2
M 16 x 30	S	10	940,00 A1/A2
M 16 x 40	S	10	1200,00 A1/A2
M 16 x 50	S	10	1490,00 A1/A2
M 16 x 60	S	10	1800,00 A1/A2
M 20 x 25	S	10	2850,00 A1/A2
M 20 x 30	S	10	3050,00 A1/A2
M 20 x 35	S	10	3250,00 A1/A2
M 20 x 50	S	10	3450,00 A1/A2

Abmessungen	VE	Stück	€/100/Obf.
DIN	00916.940		
916	A 4		



Gewindestifte mit Ringschneide, mit Innensechskant

Maße → TI-21 Normumstellung → TI-6
 Werkstoffeigensch. → TI-236

Stahl → S. 139

DIN 916 → wird ersetzt durch ISO 4029 (austauschbar)

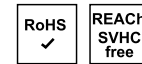

M 2 x 2	S	500	290,00 A4
M 2 x 4	S	500	310,00 A4
M 2 x 5	S	500	330,00 A4
M 2 x 6	S	500	335,00 A4
M 3 x 5	S	500	124,00 A4
M 3 x 6	S	500	143,00 A4
M 3 x 8	S	500	168,00 A4
M 3 x 10	S	500	202,00 A4
M 3 x 12	S	500	221,00 A4
M 3 x 16	S	500	238,00 A4
M 3 x 20	S	500	270,00 A4
M 4 x 5	S	500	103,00 A4
M 4 x 6	S	500	107,00 A4
M 4 x 8	S	500	112,00 A4
M 4 x 10	S	500	120,00 A4
M 4 x 12	S	500	128,00 A4
M 4 x 16	S	500	145,00 A4
M 4 x 20	S	500	156,00 A4
M 5 x 5	S	500	120,00 A4
M 5 x 6	S	500	120,00 A4
M 5 x 8	S	500	124,00 A4
M 5 x 10	S	500	133,00 A4
M 5 x 12	S	500	145,00 A4
M 5 x 16	S	500	156,00 A4
M 5 x 20	S	500	175,00 A4
M 5 x 25	S	200	183,00 A4
M 5 x 30	S	200	198,00 A4
M 6 x 6	S	500	135,00 A4
M 6 x 8	S	500	137,00 A4
M 6 x 10	S	500	145,00 A4
M 6 x 12	S	500	154,00 A4
M 6 x 16	S	500	175,00 A4
M 6 x 20	S	500	196,00 A4
M 6 x 25	S	200	233,00 A4
M 6 x 30	S	200	260,00 A4
M 6 x 35	S	200	275,00 A4
M 6 x 40	S	200	295,00 A4
M 6 x 50	S	100	360,00 A4
M 8 x 8	S	500	187,00 A4
M 8 x 10	S	500	187,00 A4
M 8 x 12	S	200	208,00 A4
M 8 x 16	S	200	229,00 A4
M 8 x 20	S	200	275,00 A4
M 8 x 25	S	200	340,00 A4
M 8 x 30	S	100	365,00 A4
M 8 x 35	S	100	410,00 A4
M 8 x 40	S	100	440,00 A4
M 8 x 50	S	50	550,00 A4
M 8 x 60	S	50	640,00 A4
M 10 x 8	S	200	440,00 A4
M 10 x 10	S	200	295,00 A4
M 10 x 12	S	100	295,00 A4

Abmessungen	VE	Stück	€/100/Obf.
M 10 x 16	S	100	320,00 A4
M 10 x 20	S	100	405,00 A4
M 10 x 25	S	100	465,00 A4
M 10 x 30	S	100	530,00 A4
M 10 x 35	S	100	560,00 A4
M 10 x 40	S	50	600,00 A4
M 10 x 50	S	50	730,00 A4
M 10 x 60	S	50	940,00 A4
M 12 x 12	S	50	350,00 A4
M 12 x 16	S	50	405,00 A4
M 12 x 20	S	50	500,00 A4
M 12 x 25	S	50	560,00 A4
M 12 x 30	S	50	610,00 A4
M 12 x 35	S	25	690,00 A4
M 12 x 40	S	25	730,00 A4
M 12 x 50	S	25	840,00 A4
M 12 x 60	S	25	1140,00 A4
M 16 x 16	S	10	1010,00 A4
M 16 x 20	S	10	1110,00 A4
M 16 x 25	S	10	950,00 A4
M 16 x 30	S	10	990,00 A4
M 16 x 35	S	10	1100,00 A4
M 16 x 40	S	10	1140,00 A4

DIN	00917.910
917	A 1/A 2

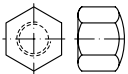

Sechskant-Hutmuttern, niedrige Form

Maße → [TI-62](#) Werkstoffeigensch. → [TI-236](#)
 Stahl → [S. 141](#)
 Messing → [S. 624](#)



M 4	S	50	54,00 A 1/A 2
M 5	S	50	59,00 A 1/A 2
M 6	S	500	66,00 A 1/A 2
M 6	K	50	73,00 A 1/A 2
M 8	S	250	110,00 A 1/A 2
M 8	K	50	118,00 A 1/A 2

Abmessungen	VE	Stück	€/100/Obf.
DIN	00917.920		
917	A 2		

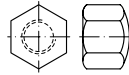

Sechskant-Hutmuttern, niedrige Form

ab M 12 mit Rille oder entsprechender Einschraubtiefe t min.

Maße → [TI-62](#) Werkstoffeigensch. → [TI-236](#)
 Stahl → [S. 141](#)
 Messing → [S. 624](#)

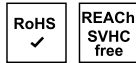

M 10 SW 17	S	250	176,00 A2
M 10 SW 17	K	25	192,00 A2
M 12 SW 19	S	200	315,00 A2
M 12 SW 19	K	25	330,00 A2
M 16	S	100	630,00 A2
M 16	K	10	650,00 A2
M 20	S	1	1100,00 A2
M 24	S	1	2310,00 A2
M 30	S	1	3800,00 A2

DIN	00917.940
917	A 4

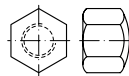

Sechskant-Hutmuttern, niedrige Form

ab M 12 mit Rille oder entsprechender Einschraubtiefe t min.

Maße → [TI-62](#) Werkstoffeigensch. → [TI-236](#)
 Stahl → [S. 141](#)
 Messing → [S. 624](#)



M 4	S	100	97,00 A4
M 5	S	100	96,00 A4
M 6	S	50	112,00 A4
M 8	S	50	172,00 A4
M 10 SW 17	S	25	335,00 A4
M 12 SW 19	S	25	520,00 A4
M 16	S	10	880,00 A4
M 20	S	1	1390,00 A4

Abmessungen	VE	Stück	€/100/Obf.
DIN	00921.910		
921	A 1		

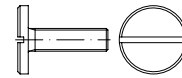

Flachkopfschrauben mit Schlitz und großem Kopf

Maße → [TI-38](#) Werkstoffeigensch. → [TI-236](#)
 Stahl → [S. 142](#)



M 3 x 6	S	100	176,00 A1
M 3 x 8	S	100	182,00 A1
M 3 x 10	S	100	188,00 A1
M 4 x 5	S	100	260,00 A1
M 4 x 6	S	100	265,00 A1
M 4 x 8	S	100	270,00 A1
M 4 x 10	S	100	300,00 A1
M 4 x 16	S	100	385,00 A1
M 5 x 6	S	100	330,00 A1
M 5 x 8	S	100	340,00 A1
M 5 x 10	S	100	370,00 A1
M 5 x 12	S	100	405,00 A1
M 5 x 16	S	100	470,00 A1
M 6 x 8	S	100	375,00 A1
M 6 x 10	S	100	415,00 A1
M 6 x 12	S	100	435,00 A1
M 6 x 16	S	100	530,00 A1
M 6 x 20	S	100	550,00 A1
M 8 x 16	S	100	600,00 A1
M 8 x 20	S	50	640,00 A1

DIN	00923.910
923	A 1

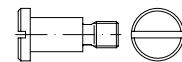

Flachkopfschrauben mit Schlitz und Ansatz

gedreht = mit Freistich
 gepresst = ohne Freistich

Maße → [TI-38](#) Werkstoffeigensch. → [TI-236](#)
 Stahl → [S. 142](#)

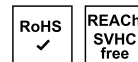

Gewinde Ø x Schaftlänge x Gewindelänge

M 3 x 3 x 4,5	S	100	330,00 A1
M 3 x 4 x 4,5	S	100	335,00 A1
M 3 x 5 x 4,5	S	100	345,00 A1
M 3 x 6 x 4,5	S	100	355,00 A1
M 3 x 10 x 4,5	S	100	360,00 A1
M 4 x 2 x 6,0	S	100	355,00 A1
M 4 x 4 x 6,0	S	100	360,00 A1
M 4 x 5 x 6,0	S	100	370,00 A1
M 4 x 6 x 6,0	S	100	375,00 A1
M 4 x 10 x 6,0	S	100	390,00 A1
M 4 x 12 x 6,0	S	100	400,00 A1
M 4 x 16 x 6,0	S	100	410,00 A1

Abmessungen	VE	Stück	€/100/Obf.
M 5 x 2,5 x 7,0 S 100			390,00A1
M 5 x 3 x 7,0 S 100			400,00A1
M 5 x 4 x 7,0 S 100			405,00A1
M 5 x 5 x 7,0 S 100			415,00A1
M 5 x 6 x 7,0 S 100			430,00A1
M 5 x 8 x 7,0 S 100			445,00A1
M 5 x 10 x 7,0 S 100			460,00A1
M 5 x 12 x 7,0 S 100			475,00A1
M 5 x 16 x 7,0 S 100			490,00A1
M 6 x 3 x 9,0 S 100			485,00A1
M 6 x 4 x 9,0 S 100			490,00A1
M 6 x 5 x 9,0 S 100			495,00A1
M 6 x 6 x 9,0 S 100			495,00A1
M 6 x 8 x 9,0 S 100			520,00A1
M 6 x 10 x 9,0 S 100			550,00A1
M 6 x 12 x 9,0 S 100			590,00A1
M 6 x 16 x 9,0 S 100			630,00A1
M 6 x 20 x 9,0 S 100			670,00A1
M 6 x 25 x 9,0 S 100			285,00A1
M 8 x 6 x 11,0 S 100			520,00A1
M 8 x 8 x 11,0 S 100			540,00A1
M 8 x 10 x 11,0 S 100			580,00A1
M 8 x 12 x 11,0 S 100			640,00A1
M 8 x 16 x 11,0 S 100			710,00A1
M 8 x 20 x 11,0 S 100			770,00A1

DIN	00929.920
929	A 4

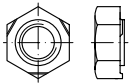

Sechskant-Schweißmuttern

Maße → [TI-71](#) Werkstoffeigensch. → [TI-236](#)
 Stahl → [S. 143](#)



M 3	S 100	34,00A2
M 4	S 100	37,00A2
M 5	S 100	55,00A2
M 6	S 100	101,00A2
M 8	S 100	122,00A2
M 10	S 100	201,00A2
M 12	S 50	430,00A2
M 16	S 50	650,00A2

Abmessungen	VE	Stück	€/100/Obf.
DIN	00929.940		
929	A 4		

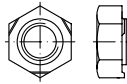

Sechskant-Schweißmuttern

Maße → [TI-71](#) Werkstoffeigensch. → [TI-236](#)
 Stahl → [S. 143](#)



M 3	S 100	63,00A4
M 4	S 100	72,00A4
M 5	S 100	84,00A4
M 6	S 100	126,00A4
M 8	S 100	168,00A4
M 10	S 100	275,00A4
M 12	S 50	530,00A4
M 16	S 25	800,00A4

DIN	00931.920
931	A 2 (- 70)*



Sechskantschrauben mit Schaft

kurze Abmessungen z. T. Gewinde bis Kopf

Maße → [TI-15](#) Anziehmomente → [TI-249](#)
 Werkstoffeigensch. → [TI-236](#) Normumstellung → [TI-6](#)
 Stahl → [S. 143](#)
 Messing → [S. 625](#)

DIN 931 → wird ersetzt durch ISO 4014

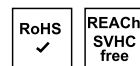

*Fkl. bei diesen Abmessungen je nach Fabrikat abweichend

M 5 x 30	S 100	15,60A2
M 5 x 35	S 100	18,80A2
M 5 x 40	S 100	19,70A2
M 5 x 45	S 100	23,10A2
M 5 x 50	S 100	27,00A2
M 5 x 55	S 100	53,00A2
M 5 x 60	S 100	53,00A2
M 5 x 65	S 200	115,00A2
M 5 x 70	S 100	117,00A2
M 5 x 80	S 100	395,00A2
M 5 x 90	S 100	530,00A2
M 5 x 100	S 100	670,00A2
M 6 x 30	S 200	15,00A2
M 6 x 35	S 100	16,80A2
M 6 x 40	S 100	19,40A2
M 6 x 45	S 100	22,60A2
M 6 x 50	S 100	27,00A2
M 6 x 55	S 100	40,00A2
M 6 x 60	S 100	45,00A2
M 6 x 65	S 100	57,00A2
M 6 x 70	S 100	61,00A2
M 6 x 75	S 100	88,00A2
M 6 x 80	S 100	74,00A2

Abmessungen	VE	Stück	€/100/Obf.
M 6 x 85	S 100		121,00A2
M 6 x 90	S 100		97,00A2
M 6 x 100	S 100		114,00A2
M 6 x 110	S 50		143,00A2
M 6 x 120	S 50		168,00A2
M 6 x 130	S 50		275,00A2
M 6 x 140	S 50		290,00A2
M 6 x 150	S 50		345,00A2
M 6 x 160*	S 50		370,00A2
M 6 x 170*	S 50		450,00A2
M 6 x 180*	S 50		455,00A2
M 8 x 35	S 100		28,50A2
M 8 x 40	S 100		33,00A2
M 8 x 45	S 100		35,00A2
M 8 x 50	S 100		37,50A2
M 8 x 55	S 100		41,50A2
M 8 x 60	S 100		42,50A2
M 8 x 65	S 100		59,00A2
M 8 x 70	S 100		62,00A2
M 8 x 75	S 100		120,00A2
M 8 x 80	S 100		95,00A2
M 8 x 85	S 100		145,00A2
M 8 x 90	S 100		116,00A2
M 8 x 100	S 100		141,00A2
M 8 x 110	S 50		169,00A2
M 8 x 120	S 50		192,00A2
M 8 x 130	S 50		216,00A2
M 8 x 140	S 50		239,00A2
M 8 x 150	S 50		265,00A2
M 8 x 160	S 25		365,00A2
M 8 x 170	S 25		445,00A2
M 8 x 180	S 25		445,00A2
M 8 x 190	S 25		590,00A2
M 8 x 200	S 25		590,00A2
M 8 x 220*	S 25		890,00A2
M 10 x 40	S 100		59,00A2
M 10 x 45	S 100		61,00A2
M 10 x 50	S 100		65,00A2
M 10 x 55	S 100		70,00A2
M 10 x 60	S 100		75,00A2
M 10 x 65	S 100		85,00A2
M 10 x 70	S 100		88,00A2
M 10 x 75	S 50		156,00A2
M 10 x 80	S 50		107,00A2
M 10 x 85	S 50		203,00A2
M 10 x 90	S 50		164,00A2
M 10 x 100	S 50		207,00A2
M 10 x 110	S 50		255,00A2
M 10 x 120	S 50		315,00A2
M 10 x 130	S 50		385,00A2
M 10 x 140	S 50		445,00A2
M 10 x 150	S 50		500,00A2
M 10 x 160	S 50		590,00A2
M 10 x 170	S 1		720,00A2
M 10 x 180	S 1		730,00A2
M 10 x 190	S 1		950,00A2
M 10 x 200	S 1		950,00A2
M 10 x 210	S 1		1230,00A2
M 10 x 220	S 1		1380,00A2
M 12 x 40	S 50		80,00A2
M 12 x 45	S 50		85,00A2
M 12 x 50	S 50		92,00A2
M 12 x 55	S 50		99,00A2
M 12 x 60	S 50		106,00A2
M 12 x 65	S 50		118,00A2
M 12 x 70	S 50		127,00A2
M 12 x 75	S 50		222,00A2
M 12 x 80	S 50		153,00A2
M 12 x 85	S 50		260,00A2
M 12 x 90	S 50		207,00A2
M 12 x 100	S 50		229,00A2
M 12 x 105	S 50		475,00A2
M 12 x 110	S 50		280,00A2
M 12 x 120	S 25		330,00A2
M 12 x 130	S 1		405,00A2

Abmessungen	VE	Stück	€/100/Obf.	Abmessungen	VE	Stück	€/100/Obf.	Abmessungen	VE	Stück	€/100/Obf.
M 12 x 140	S	1	480,00A2	M 20 x 65	S	1	340,00A2	M 27 x 220*	S	1	4100,00A2
M 12 x 150	S	1	550,00A2	M 20 x 70	S	1	360,00A2	M 27 x 230*	S	1	4550,00A2
M 12 x 160	S	1	660,00A2	M 20 x 75	S	1	395,00A2	M 27 x 240*	S	1	4550,00A2
M 12 x 170	S	1	830,00A2	M 20 x 80	S	1	395,00A2	M 27 x 250*	S	1	5100,00A2
M 12 x 180	S	1	830,00A2	M 20 x 85	S	1	540,00A2	M 30 x 90*	S	1	2330,00A2
M 12 x 190	S	1	1130,00A2	M 20 x 90	S	1	430,00A2	M 30 x 100*	S	1	2550,00A2
M 12 x 200	S	1	1130,00A2	M 20 x 100	S	1	470,00A2	M 30 x 110*	S	1	2750,00A2
M 12 x 210	S	1	1450,00A2	M 20 x 110	S	1	670,00A2	M 30 x 120*	S	1	2900,00A2
M 12 x 220	S	1	1580,00A2	M 20 x 120	S	1	730,00A2	M 30 x 130*	S	1	3050,00A2
M 12 x 230	S	1	1670,00A2	M 20 x 130	S	1	850,00A2	M 30 x 140*	S	1	3450,00A2
M 12 x 240	S	1	1760,00A2	M 20 x 140	S	1	940,00A2	M 30 x 150*	S	1	3650,00A2
M 12 x 250	S	1	1850,00A2	M 20 x 150	S	1	1020,00A2	M 30 x 160*	S	1	4050,00A2
M 12 x 260*	S	1	2050,00A2	M 20 x 160	S	1	1310,00A2	M 30 x 170*	S	1	4450,00A2
M 12 x 280*	S	1	2220,00A2	M 20 x 170	S	1	1420,00A2	M 30 x 180*	S	1	4450,00A2
M 12 x 300*	S	1	2370,00A2	M 20 x 180	S	1	1500,00A2	M 30 x 190*	S	1	4850,00A2
M 12 x 320*	S	1	2850,00A2	M 20 x 190	S	1	1690,00A2	M 30 x 200*	S	1	4850,00A2
M 14 x 50	S	50	195,00A2	M 20 x 200	S	1	1690,00A2	M 30 x 210*	S	1	5300,00A2
M 14 x 55	S	50	195,00A2	M 20 x 210	S	1	2070,00A2	M 30 x 220*	S	1	5300,00A2
M 14 x 60	S	50	199,00A2	M 20 x 220	S	1	2070,00A2	M 30 x 240*	S	1	5700,00A2
M 14 x 65	S	50	216,00A2	M 20 x 230	S	1	2360,00A2	M 30 x 250*	S	1	6000,00A2
M 14 x 70	S	50	228,00A2	M 20 x 240	S	1	2360,00A2	M 33 x 100*	S	1	3350,00A2
M 14 x 80	S	50	255,00A2	M 20 x 250	S	1	2650,00A2	M 33 x 110*	S	1	3600,00A2
M 14 x 90	S	50	280,00A2	M 20 x 260*	S	1	2650,00A2	M 33 x 120*	S	1	3800,00A2
M 14 x 100	S	50	305,00A2	M 20 x 270*	S	1	2950,00A2	M 33 x 130*	S	1	4050,00A2
M 14 x 110	S	50	440,00A2	M 20 x 280*	S	1	2950,00A2	M 33 x 140*	S	1	4300,00A2
M 14 x 120	S	1	475,00A2	M 20 x 290*	S	1	3250,00A2	M 33 x 150*	S	1	4500,00A2
M 14 x 130	S	1	590,00A2	M 20 x 300*	S	1	3250,00A2	M 33 x 160*	S	1	4750,00A2
M 14 x 140	S	1	640,00A2	M 22 x 80	S	1	1000,00A2	M 33 x 170*	S	1	5200,00A2
M 14 x 150	S	1	700,00A2	M 22 x 90	S	1	1060,00A2	M 33 x 180*	S	1	5200,00A2
M 14 x 160	S	1	900,00A2	M 22 x 100	S	1	1140,00A2	M 33 x 190*	S	1	5700,00A2
M 14 x 170*	S	1	1000,00A2	M 22 x 110	S	1	1290,00A2	M 33 x 200*	S	1	5700,00A2
M 14 x 180*	S	1	1060,00A2	M 22 x 120	S	1	1390,00A2	M 33 x 210*	S	1	6100,00A2
M 14 x 200*	S	1	1220,00A2	M 22 x 130	S	1	1550,00A2	M 33 x 220*	S	1	6100,00A2
M 16 x 55	S	50	195,00A2	M 22 x 140	S	1	1680,00A2	M 33 x 230*	S	1	6600,00A2
M 16 x 60	S	50	199,00A2	M 22 x 150	S	1	1810,00A2	M 33 x 240*	S	1	6600,00A2
M 16 x 65	S	50	216,00A2	M 22 x 160	S	1	2130,00A2	M 33 x 250*	S	1	7100,00A2
M 16 x 70	S	25	228,00A2	M 22 x 180	S	1	2410,00A2	M 36 x 100*	S	1	4100,00A2
M 16 x 75	S	25	255,00A2	M 22 x 200	S	1	2700,00A2	M 36 x 110*	S	1	4400,00A2
M 16 x 80	S	25	255,00A2	M 24 x 75	S	1	790,00A2	M 36 x 120*	S	1	4650,00A2
M 16 x 85	S	25	345,00A2	M 24 x 80	S	1	640,00A2	M 36 x 130*	S	1	4900,00A2
M 16 x 90	S	25	280,00A2	M 24 x 85	S	1	840,00A2	M 36 x 140*	S	1	5200,00A2
M 16 x 95	S	25	400,00A2	M 24 x 90	S	1	670,00A2	M 36 x 150*	S	1	5500,00A2
M 16 x 100	S	25	305,00A2	M 24 x 95	S	1	910,00A2	M 36 x 160*	S	1	5800,00A2
M 16 x 110	S	25	440,00A2	M 24 x 100	S	1	720,00A2	M 36 x 170*	S	1	6700,00A2
M 16 x 120	S	25	475,00A2	M 24 x 110	S	1	810,00A2	M 36 x 180*	S	1	6700,00A2
M 16 x 130	S	1	590,00A2	M 24 x 120	S	1	870,00A2	M 36 x 190*	S	1	7200,00A2
M 16 x 140	S	1	640,00A2	M 24 x 130	S	1	1100,00A2	M 36 x 200*	S	1	7200,00A2
M 16 x 150	S	1	700,00A2	M 24 x 140	S	1	1190,00A2	M 36 x 210*	S	1	7800,00A2
M 16 x 160	S	1	900,00A2	M 24 x 150	S	1	1260,00A2	M 36 x 220*	S	1	7800,00A2
M 16 x 170	S	1	1000,00A2	M 24 x 160	S	1	1870,00A2	M 36 x 230*	S	1	8400,00A2
M 16 x 180	S	1	1060,00A2	M 24 x 170	S	1	2170,00A2	M 36 x 240*	S	1	8400,00A2
M 16 x 190	S	1	1220,00A2	M 24 x 180	S	1	2170,00A2	M 36 x 250*	S	1	8900,00A2
M 16 x 200	S	1	1220,00A2	M 24 x 190	S	1	2410,00A2				
M 16 x 210	S	1	1450,00A2	M 24 x 200	S	1	2410,00A2				
M 16 x 220	S	1	1450,00A2	M 24 x 210	S	1	2750,00A2				
M 16 x 230	S	1	1680,00A2	M 24 x 220	S	1	2750,00A2				
M 16 x 240	S	1	1680,00A2	M 24 x 230	S	1	3050,00A2				
M 16 x 250	S	1	2000,00A2	M 24 x 240	S	1	3050,00A2				
M 16 x 260*	S	1	2000,00A2	M 24 x 250	S	1	3500,00A2				
M 16 x 270*	S	1	2250,00A2	M 24 x 260*	S	1	3500,00A2				
M 16 x 280*	S	1	2250,00A2	M 24 x 280*	S	1	3850,00A2				
M 16 x 290*	S	1	2500,00A2	M 24 x 290*	S	1	4150,00A2				
M 16 x 300*	S	1	2500,00A2	M 24 x 300*	S	1	4150,00A2				
M 18 x 65	S	1	510,00A2	M 27 x 90	S	1	1790,00A2				
M 18 x 70	S	25	540,00A2	M 27 x 100	S	1	1930,00A2				
M 18 x 75	S	1	590,00A2	M 27 x 110	S	1	2080,00A2				
M 18 x 80	S	25	590,00A2	M 27 x 120	S	1	2230,00A2				
M 18 x 90	S	25	650,00A2	M 27 x 130	S	1	2300,00A2				
M 18 x 100	S	25	710,00A2	M 27 x 140	S	1	2440,00A2				
M 18 x 110	S	25	1000,00A2	M 27 x 150	S	1	2600,00A2				
M 18 x 120	S	25	1090,00A2	M 27 x 160*	S	1	2750,00A2				
M 18 x 130	S	25	1280,00A2	M 27 x 170*	S	1	3050,00A2				
M 18 x 140	S	25	1400,00A2	M 27 x 180*	S	1	3050,00A2				
M 18 x 150	S	25	1520,00A2	M 27 x 200*	S	1	3300,00A2				
M 18 x 160	S	25	1600,00A2	M 27 x 210*	S	1	4100,00A2				



- ✓ Große Artikelvielfalt
- ✓ Verlässliche Qualität
- ✓ Hohe Lieferbereitschaft

Abmessungen	VE Stück	€/100/Obf.
DIN 00931.940		
931	A 4 (- 70)*	



Sechskantschrauben mit Schaft

kurze Abmessungen z. T. Gewinde bis Kopf

Maße → **TI-15** Anziehmomente → **TI-249**
 Werkstoffeigensch. → **TI-236** Normumstellung → **TI-6**
 Stahl → **S. 143**
 Messing → **S. 625**

DIN 931 → wird ersetzt durch ISO 4014

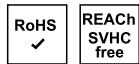

*Fkl. bei diesen Abmessungen je nach Fabrikat abweichend

M 5	x	30	S	100	24,40A4
M 5	x	35	S	100	26,50A4
M 5	x	40	S	100	29,00A4
M 5	x	45	S	100	33,50A4
M 5	x	50	S	100	42,00A4
M 5	x	55	S	100	69,00A4
M 5	x	60	S	100	72,00A4
M 5	x	70	S	100	152,00A4
M 5	x	80	S	100	470,00A4
M 5	x	90	S	100	600,00A4
M 5	x	100	S	100	770,00A4
M 6	x	30	S	200	24,20A4
M 6	x	35	S	100	26,00A4
M 6	x	40	S	100	28,00A4
M 6	x	45	S	100	32,00A4
M 6	x	50	S	100	36,50A4
M 6	x	55	S	100	51,00A4
M 6	x	60	S	100	58,00A4
M 6	x	65	S	100	70,00A4
M 6	x	70	S	100	74,00A4
M 6	x	80	S	100	92,00A4
M 6	x	90	S	100	120,00A4
M 6	x	100	S	100	133,00A4
M 6	x	110	S	50	176,00A4
M 6	x	120	S	50	214,00A4
M 6	x	130	S	50	365,00A4
M 6	x	140	S	1	405,00A4
M 6	x	150	S	1	445,00A4
M 6	x	160*	S	1	485,00A4
M 6	x	170*	S	1	620,00A4
M 8	x	35	S	100	53,00A4
M 8	x	40	S	100	53,00A4
M 8	x	45	S	100	56,00A4
M 8	x	50	S	100	60,00A4
M 8	x	55	S	100	71,00A4
M 8	x	60	S	100	73,00A4
M 8	x	65	S	100	96,00A4
M 8	x	70	S	100	101,00A4
M 8	x	75	S	100	210,00A4
M 8	x	80	S	100	152,00A4
M 8	x	85	S	100	221,00A4
M 8	x	90	S	100	178,00A4
M 8	x	100	S	100	210,00A4
M 8	x	110	S	50	260,00A4
M 8	x	120	S	50	295,00A4
M 8	x	130	S	50	365,00A4
M 8	x	140	S	1	430,00A4
M 8	x	150	S	1	490,00A4
M 8	x	160	S	1	610,00A4
M 8	x	170	S	1	750,00A4
M 8	x	180	S	1	750,00A4

Abmessungen	VE Stück	€/100/Obf.			
M 8	x	190	S	1	990,00A4
M 8	x	200	S	1	990,00A4
M 8	x	220*	S	1	1460,00A4
M 10	x	40	S	100	98,00A4
M 10	x	45	S	100	100,00A4
M 10	x	50	S	100	104,00A4
M 10	x	55	S	100	116,00A4
M 10	x	60	S	100	122,00A4
M 10	x	65	S	100	142,00A4
M 10	x	70	S	100	145,00A4
M 10	x	75	S	50	248,00A4
M 10	x	80	S	50	175,00A4
M 10	x	90	S	50	242,00A4
M 10	x	100	S	50	305,00A4
M 10	x	110	S	50	385,00A4
M 10	x	120	S	50	475,00A4
M 10	x	130	S	1	610,00A4
M 10	x	140	S	1	700,00A4
M 10	x	150	S	1	800,00A4
M 10	x	160	S	1	990,00A4
M 10	x	170	S	1	1210,00A4
M 10	x	180	S	1	1210,00A4
M 10	x	190	S	1	1600,00A4
M 10	x	200	S	1	1600,00A4
M 10	x	210	S	1	1970,00A4
M 10	x	220	S	1	2220,00A4
M 12	x	45	S	50	146,00A4
M 12	x	50	S	50	147,00A4
M 12	x	55	S	50	162,00A4
M 12	x	60	S	50	166,00A4
M 12	x	65	S	50	197,00A4
M 12	x	70	S	50	200,00A4
M 12	x	75	S	50	335,00A4
M 12	x	80	S	50	233,00A4
M 12	x	85	S	50	355,00A4
M 12	x	90	S	50	285,00A4
M 12	x	95	S	50	420,00A4
M 12	x	100	S	50	340,00A4
M 12	x	110	S	50	415,00A4
M 12	x	120	S	25	510,00A4
M 12	x	130	S	1	640,00A4
M 12	x	140	S	1	760,00A4
M 12	x	150	S	1	870,00A4
M 12	x	160	S	1	1130,00A4
M 12	x	170	S	1	1420,00A4
M 12	x	180	S	1	1420,00A4
M 12	x	190	S	1	1750,00A4
M 12	x	200	S	1	1750,00A4
M 12	x	210	S	1	2140,00A4
M 12	x	220	S	1	2260,00A4
M 12	x	240	S	1	2440,00A4
M 12	x	250	S	1	2550,00A4
M 12	x	260*	S	1	2750,00A4
M 12	x	280*	S	1	2900,00A4
M 12	x	300*	S	1	3050,00A4
M 12	x	320*	S	1	3200,00A4
M 12	x	340*	S	1	3350,00A4
M 12	x	360*	S	1	3500,00A4
M 12	x	380*	S	1	3650,00A4
M 12	x	400*	S	1	3950,00A4
M 14	x	50	S	50	365,00A4
M 14	x	55	S	50	355,00A4
M 14	x	60	S	50	355,00A4
M 14	x	65	S	50	390,00A4
M 14	x	70	S	50	395,00A4
M 14	x	80	S	50	430,00A4
M 14	x	90	S	50	480,00A4
M 14	x	100	S	50	520,00A4
M 14	x	110	S	1	660,00A4
M 14	x	120	S	1	740,00A4
M 14	x	130	S	1	880,00A4
M 14	x	140	S	1	980,00A4
M 14	x	150	S	1	1070,00A4
M 14	x	160	S	1	1410,00A4
M 14	x	170*	S	1	1620,00A4

Abmessungen	VE Stück	€/100/Obf.			
M 14	x	180*	S	1	1620,00A4
M 14	x	190*	S	1	1830,00A4
M 14	x	200*	S	1	1830,00A4
M 16	x	55	S	50	355,00A4
M 16	x	60	S	50	355,00A4
M 16	x	65	S	50	390,00A4
M 16	x	70	S	25	395,00A4
M 16	x	75	S	25	430,00A4
M 16	x	80	S	25	430,00A4
M 16	x	85	S	25	600,00A4
M 16	x	90	S	25	480,00A4
M 16	x	100	S	25	520,00A4
M 16	x	110	S	25	660,00A4
M 16	x	120	S	25	740,00A4
M 16	x	130	S	1	880,00A4
M 16	x	140	S	1	980,00A4
M 16	x	150	S	1	1070,00A4
M 16	x	160	S	1	1410,00A4
M 16	x	170	S	1	1620,00A4
M 16	x	180	S	1	1620,00A4
M 16	x	190	S	1	1830,00A4
M 16	x	200	S	1	1830,00A4
M 16	x	210	S	1	2600,00A4
M 16	x	220	S	1	2600,00A4
M 16	x	230	S	1	2950,00A4
M 16	x	240	S	1	2950,00A4
M 16	x	250	S	1	3300,00A4
M 16	x	260*	S	1	3300,00A4
M 16	x	270*	S	1	3650,00A4
M 16	x	280*	S	1	3650,00A4
M 16	x	290*	S	1	4000,00A4
M 16	x	300*	S	1	4000,00A4
M 16	x	320*	S	1	6500,00A4
M 16	x	340*	S	1	7000,00A4
M 16	x	360*	S	1	7200,00A4
M 16	x	380*	S	1	7300,00A4
M 16	x	400*	S	1	7400,00A4
M 18	x	70	S	1	790,00A4
M 18	x	80	S	1	870,00A4
M 18	x	90	S	1	960,00A4
M 18	x	100	S	1	1040,00A4
M 18	x	110	S	1	1560,00A4
M 18	x	120	S	1	1690,00A4
M 18	x	130	S	1	1970,00A4
M 18	x	140	S	1	2000,00A4
M 18	x	150	S	1	2000,00A4
M 18	x	160	S	1	2030,00A4
M 18	x	170	S	1	3000,00A4
M 18	x	180	S	1	3000,00A4
M 18	x	190	S	1	3400,00A4
M 18	x	200	S	1	3400,00A4
M 20	x	65	S	1	610,00A4
M 20	x	70	S	1	630,00A4
M 20	x	75	S	1	660,00A4
M 20	x	80	S	1	660,00A4
M 20	x	85	S	1	950,00A4
M 20	x	90	S	1	760,00A4
M 20	x	100	S	1	840,00A4
M 20	x	110	S	1	1040,00A4
M 20	x	120	S	1	1130,00A4
M 20	x	130	S	1	1320,00A4
M 20	x	140	S	1	1440,00A4
M 20	x	150	S	1	1570,00A4
M 20	x	160	S	1	2030,00A4
M 20	x	170	S	1	2330,00A4
M 20	x	180	S	1	2330,00A4
M 20	x	190	S	1	2650,00A4
M 20	x	200	S	1	2650,00A4
M 20	x	210	S	1	3050,00A4
M 20	x	220	S	1	3050,00A4
M 20	x	230	S	1	3400,00A4
M 20	x	240	S	1	3400,00A4
M 20	x	250	S	1	4500,00A4
M 20	x	260*	S	1	4500,00A4
M 20	x	270*	S	1	4950,00A4

Abmessungen	VE	Stück	€/100/0bf.
M 14 x 100	S	50	1310,00 A4-80
M 14 x 110	S	1	1640,00 A4-80
M 14 x 120	S	1	1870,00 A4-80
M 14 x 130	S	1	2210,00 A4-80
M 14 x 140	S	1	2480,00 A4-80
M 14 x 150	S	1	2700,00 A4-80
M 14 x 160	S	1	3550,00 A4-80
M 14 x 180	S	1	4050,00 A4-80
M 14 x 200	S	1	4600,00 A4-80
M 16 x 55	S	25	910,00 A4-80
M 16 x 60	S	25	910,00 A4-80
M 16 x 65	S	25	990,00 A4-80
M 16 x 70	S	25	1000,00 A4-80
M 16 x 75	S	25	1280,00 A4-80
M 16 x 80	S	25	1100,00 A4-80
M 16 x 85	S	25	1490,00 A4-80
M 16 x 90	S	25	1220,00 A4-80
M 16 x 100	S	25	1310,00 A4-80
M 16 x 110	S	25	1640,00 A4-80
M 16 x 120	S	25	1870,00 A4-80
M 16 x 130	S	1	2210,00 A4-80
M 16 x 140	S	1	2460,00 A4-80
M 16 x 150	S	1	2700,00 A4-80
M 16 x 160	S	1	3550,00 A4-80
M 16 x 170	S	1	3850,00 A4-80
M 16 x 180	S	1	4100,00 A4-80
M 16 x 190	S	1	4400,00 A4-80
M 16 x 200	S	1	4600,00 A4-80
M 16 x 220	S	1	5500,00 A4-80
M 20 x 65	S	1	1540,00 A4-80
M 20 x 70	S	1	1600,00 A4-80
M 20 x 75	S	1	1890,00 A4-80
M 20 x 80	S	1	1680,00 A4-80
M 20 x 90	S	1	1910,00 A4-80
M 20 x 100	S	1	2120,00 A4-80
M 20 x 110	S	1	2650,00 A4-80
M 20 x 120	S	1	2850,00 A4-80
M 20 x 130	S	1	3300,00 A4-80
M 20 x 140	S	1	3650,00 A4-80
M 20 x 150	S	1	3950,00 A4-80
M 20 x 160	S	1	5100,00 A4-80
M 20 x 170	S	1	5700,00 A4-80
M 20 x 180	S	1	5900,00 A4-80
M 20 x 190	S	1	6200,00 A4-80
M 20 x 200	S	1	6700,00 A4-80
M 20 x 220	S	1	7600,00 A4-80
M 24 x 80	S	1	3250,00 A4-80
M 24 x 90	S	1	3500,00 A4-80
M 24 x 100	S	1	3900,00 A4-80
M 24 x 110	S	1	4350,00 A4-80
M 24 x 120	S	1	4600,00 A4-80
M 24 x 130	S	1	5100,00 A4-80
M 24 x 150	S	1	5900,00 A4-80
M 24 x 160	S	1	7900,00 A4-80
M 24 x 170	S	1	8800,00 A4-80
M 24 x 180	S	1	9300,00 A4-80
M 24 x 190	S	1	9800,00 A4-80
M 24 x 200	S	1	9800,00 A4-80
M 24 x 220	S	1	12800,00 A4-80

Abmessungen	VE	Stück	€/100/0bf.
DIN	00931.950		
931	1.4571 (A 5)		



Sechskantschrauben mit Schaft

kurze Abmessungen z. T. Gewinde bis Kopf

Maße → **TI-15** Anziehmomente → **TI-249**
 Werkstoffeigensch. → **TI-236** Normumstellung → **TI-6**
 Stahl → **S. 143**
 Messing → **S. 625**

DIN 931 → wird ersetzt durch ISO 4014



M 6 x 30	S	100	80,00 A5
M 6 x 35	S	100	85,00 A5
M 6 x 40	S	100	93,00 A5
M 6 x 50	S	100	120,00 A5
M 8 x 70	S	50	335,00 A5
M 8 x 80	S	50	490,00 A5
M 10 x 60	S	50	400,00 A5
M 10 x 70	S	50	475,00 A5
M 10 x 80	S	50	580,00 A5
M 10 x 90	S	50	800,00 A5
M 10 x 100	S	50	1000,00 A5
M 10 x 110	S	25	1280,00 A5
M 10 x 120	S	25	1580,00 A5
M 12 x 70	S	25	660,00 A5
M 12 x 80	S	25	770,00 A5
M 12 x 90	S	25	940,00 A5
M 12 x 100	S	25	1120,00 A5
M 12 x 110	S	25	1370,00 A5
M 12 x 120	S	25	1680,00 A5
M 16 x 55	S	1	1310,00 A5
M 16 x 60	S	1	1350,00 A5
M 16 x 65	S	1	1390,00 A5
M 16 x 70	S	1	1430,00 A5
M 16 x 80	S	1	1490,00 A5
M 16 x 90	S	1	1580,00 A5
M 16 x 100	S	1	1640,00 A5
M 16 x 110	S	1	1750,00 A5
M 16 x 120	S	1	1830,00 A5
M 16 x 130	S	1	1910,00 A5
M 16 x 140	S	1	2020,00 A5
M 16 x 150	S	1	2120,00 A5
M 16 x 160	S	1	2230,00 A5
M 20 x 65	S	1	1930,00 A5
M 20 x 70	S	1	1980,00 A5
M 20 x 80	S	1	2100,00 A5
M 20 x 85	S	1	2170,00 A5
M 20 x 90	S	1	2380,00 A5
M 20 x 100	S	1	2440,00 A5
M 20 x 110	S	1	2480,00 A5
M 20 x 120	S	1	2600,00 A5
M 20 x 130	S	1	2750,00 A5
M 20 x 140	S	1	2850,00 A5
M 20 x 150	S	1	3050,00 A5
M 20 x 160	S	1	3300,00 A5
M 20 x 170	S	1	3700,00 A5
M 20 x 180	S	1	4250,00 A5

Abmessungen	VE	Stück	€/100/0bf.
DIN	00933.920		
933	A 2 (- 70)*		



Sechskantschrauben mit Gewinde bis Kopf

Maße → **TI-15** Anziehmomente → **TI-249**
 Werkstoffeigensch. → **TI-236** Normumstellung → **TI-6**

Stahl → **S. 156**
 Messing, Kunststoff → **S. 625**

DIN 933 → wird ersetzt durch ISO 4017

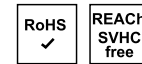

*Fkl. bei diesen Abmessungen je nach Fabrikat abweichend

M 3 x 6*	S	100	15,50 A2
M 3 x 8*	S	100	11,10 A2
M 3 x 10*	S	100	10,60 A2
M 3 x 12*	S	100	9,90 A2
M 3 x 14*	S	100	13,10 A2
M 3 x 16*	S	100	9,90 A2
M 3 x 20*	S	100	11,10 A2
M 3 x 25*	S	100	12,00 A2
M 3 x 30*	S	100	14,40 A2
M 3 x 35*	S	100	20,70 A2
M 3 x 40*	S	100	31,00 A2
M 4 x 6*	S	200	15,50 A2
M 4 x 8*	S	200	11,10 A2
M 4 x 10*	S	200	10,60 A2
M 4 x 12*	S	200	9,90 A2
M 4 x 14*	S	100	13,10 A2
M 4 x 16*	S	200	8,10 A2
M 4 x 18*	S	100	10,60 A2
M 4 x 20*	S	200	8,80 A2
M 4 x 22*	S	100	12,20 A2
M 4 x 25*	S	200	10,10 A2
M 4 x 30*	S	200	11,30 A2
M 4 x 35*	S	200	19,40 A2
M 4 x 40*	S	200	23,10 A2
M 4 x 45*	S	100	29,50 A2
M 4 x 50*	S	100	35,00 A2
M 4 x 60*	S	100	107,00 A2
M 5 x 6*	S	100	33,00 A2
M 5 x 8*	S	100	11,10 A2
M 5 x 10	S	500	10,60 A2
M 5 x 10	K	100	14,60 A2
M 5 x 12	S	500	9,90 A2
M 5 x 12	K	100	13,80 A2
M 5 x 14	S	500	13,10 A2
M 5 x 14	K	100	17,80 A2
M 5 x 16	S	500	8,10 A2
M 5 x 16	K	100	12,00 A2
M 5 x 18	S	500	10,60 A2
M 5 x 18	K	100	15,40 A2
M 5 x 20	S	500	8,80 A2
M 5 x 20	K	100	12,60 A2
M 5 x 22	S	200	12,20 A2
M 5 x 25	S	200	11,60 A2
M 5 x 25	K	100	15,60 A2
M 5 x 30	S	200	13,00 A2
M 5 x 30	K	100	16,90 A2
M 5 x 35	S	200	15,30 A2
M 5 x 40	S	200	22,00 A2
M 5 x 45	S	200	29,50 A2
M 5 x 50	S	200	35,00 A2
M 5 x 55	S	200	41,50 A2
M 5 x 60	S	200	44,50 A2



Wir versorgen Sie mit
 Verbindungselementen
 und Befestigungstechnik!

Abmessungen	VE	Stück	€/100/Obf.	Abmessungen	VE	Stück	€/100/Obf.	Abmessungen	VE	Stück	€/100/Obf.
M 5 x 70	S	100	117,00A2	M 8 x 160	S	50	530,00A2	M 14 x 65	S	50	195,00A2
M 5 x 80	S	100	395,00A2	M 8 x 170	S	50	650,00A2	M 14 x 70	S	50	203,00A2
M 6 x 6*	S	100	127,00A2	M 8 x 180	S	50	650,00A2	M 14 x 75	S	50	300,00A2
M 6 x 8*	S	100	15,50A2	M 8 x 190	S	50	1240,00A2	M 14 x 80	S	50	241,00A2
M 6 x 10	S	500	13,10A2	M 8 x 200	S	50	1630,00A2	M 14 x 90	S	50	405,00A2
M 6 x 10	K	100	17,00A2	M 10 x 10*	S	100	211,00A2	M 14 x 100	S	50	465,00A2
M 6 x 12	S	500	13,10A2	M 10 x 12	S	100	113,00A2	M 14 x 110	S	25	580,00A2
M 6 x 12	K	100	17,00A2	M 10 x 14	S	100	71,00A2	M 14 x 120	S	25	650,00A2
M 6 x 14	S	500	15,60A2	M 10 x 16	S	100	57,00A2	M 14 x 130	S	25	770,00A2
M 6 x 14	K	100	20,30A2	M 10 x 18	S	100	63,00A2	M 14 x 140	S	25	870,00A2
M 6 x 16	S	200	9,30A2	M 10 x 20	S	100	41,50A2	M 14 x 150	S	25	950,00A2
M 6 x 16	K	100	13,30A2	M 10 x 22	S	100	49,00A2	M 16 x 20	S	50	218,00A2
M 6 x 18	S	200	13,30A2	M 10 x 25	S	100	40,00A2	M 16 x 25	S	50	181,00A2
M 6 x 20	S	200	10,60A2	M 10 x 30	S	100	44,00A2	M 16 x 30	S	50	132,00A2
M 6 x 20	K	100	14,60A2	M 10 x 35	S	100	48,50A2	M 16 x 35	S	50	132,00A2
M 6 x 22	S	200	14,80A2	M 10 x 40	S	100	53,00A2	M 16 x 40	S	50	141,00A2
M 6 x 25	S	200	11,90A2	M 10 x 45	S	100	57,00A2	M 16 x 45	S	50	151,00A2
M 6 x 25	K	100	15,80A2	M 10 x 50	S	100	60,00A2	M 16 x 50	S	50	160,00A2
M 6 x 30	S	200	13,80A2	M 10 x 55	S	50	85,00A2	M 16 x 55	S	25	171,00A2
M 6 x 30	K	100	17,60A2	M 10 x 60	S	50	89,00A2	M 16 x 60	S	25	182,00A2
M 6 x 35	S	200	15,00A2	M 10 x 65	S	50	100,00A2	M 16 x 65	S	25	195,00A2
M 6 x 35	K	100	19,00A2	M 10 x 70	S	50	106,00A2	M 16 x 70	S	25	203,00A2
M 6 x 40	S	200	16,80A2	M 10 x 75	S	50	157,00A2	M 16 x 75	S	25	241,00A2
M 6 x 40	K	100	20,70A2	M 10 x 80	S	50	126,00A2	M 16 x 80	S	25	241,00A2
M 6 x 45	S	100	26,50A2	M 10 x 85	S	50	218,00A2	M 16 x 85	S	25	495,00A2
M 6 x 50	S	100	28,50A2	M 10 x 90	S	50	170,00A2	M 16 x 90	S	25	405,00A2
M 6 x 55	S	100	36,50A2	M 10 x 100	S	50	195,00A2	M 16 x 100	S	25	465,00A2
M 6 x 60	S	100	41,50A2	M 10 x 110	S	50	325,00A2	M 16 x 110	S	25	580,00A2
M 6 x 65	S	100	57,00A2	M 10 x 120	S	50	355,00A2	M 16 x 120	S	25	650,00A2
M 6 x 70	S	100	57,00A2	M 10 x 130	S	1	445,00A2	M 16 x 130	S	25	770,00A2
M 6 x 75	S	100	85,00A2	M 10 x 140	S	1	530,00A2	M 16 x 140	S	25	870,00A2
M 6 x 80	S	100	68,00A2	M 10 x 150	S	1	600,00A2	M 16 x 150	S	25	950,00A2
M 6 x 90	S	100	97,00A2	M 10 x 160	S	1	680,00A2	M 16 x 160	S	25	1690,00A2
M 6 x 100	S	100	112,00A2	M 10 x 170	S	1	840,00A2	M 16 x 170	S	25	1740,00A2
M 6 x 110	S	100	435,00A2	M 10 x 180	S	1	840,00A2	M 16 x 180	S	25	1740,00A2
M 6 x 120	S	100	510,00A2	M 10 x 190	S	1	1320,00A2	M 16 x 190	S	10	1920,00A2
M 8 x 8*	S	100	147,00A2	M 10 x 200	S	1	1450,00A2	M 16 x 200	S	10	1920,00A2
M 8 x 10	S	200	30,50A2	M 12 x 16	S	100	89,00A2	M 18 x 30	S	25	500,00A2
M 8 x 10	K	100	34,50A2	M 12 x 20	S	100	80,00A2	M 18 x 35	S	25	405,00A2
M 8 x 12	S	200	28,50A2	M 12 x 22	S	100	95,00A2	M 18 x 40	S	25	375,00A2
M 8 x 12	K	100	32,50A2	M 12 x 25	S	100	59,00A2	M 18 x 45	S	25	400,00A2
M 8 x 14	S	200	34,00A2	M 12 x 30	S	100	63,00A2	M 18 x 50	S	25	425,00A2
M 8 x 16	S	200	19,40A2	M 12 x 35	S	100	69,00A2	M 18 x 55	S	25	460,00A2
M 8 x 16	K	100	23,30A2	M 12 x 40	S	50	75,00A2	M 18 x 60	S	25	470,00A2
M 8 x 18	S	200	24,10A2	M 12 x 45	S	50	80,00A2	M 18 x 65	S	25	520,00A2
M 8 x 20	S	200	19,40A2	M 12 x 50	S	50	85,00A2	M 18 x 70	S	25	540,00A2
M 8 x 20	K	100	24,30A2	M 12 x 55	S	50	91,00A2	M 18 x 75	S	25	620,00A2
M 8 x 22	S	200	29,00A2	M 12 x 60	S	50	96,00A2	M 18 x 80	S	25	620,00A2
M 8 x 25	S	200	22,90A2	M 12 x 65	S	50	138,00A2	M 18 x 90	S	25	1010,00A2
M 8 x 25	K	100	27,00A2	M 12 x 70	S	50	147,00A2	M 18 x 100	S	25	1140,00A2
M 8 x 30	S	200	24,30A2	M 12 x 75	S	50	220,00A2	M 18 x 110	S	1	1300,00A2
M 8 x 30	K	100	28,50A2	M 12 x 80	S	50	177,00A2	M 18 x 120	S	1	1440,00A2
M 8 x 35	S	200	30,50A2	M 12 x 85	S	50	315,00A2	M 18 x 130	S	1	1740,00A2
M 8 x 35	K	100	40,00A2	M 12 x 90	S	50	245,00A2	M 18 x 140	S	1	1890,00A2
M 8 x 40	S	200	29,00A2	M 12 x 95	S	50	340,00A2	M 18 x 150	S	1	2120,00A2
M 8 x 40	K	100	33,00A2	M 12 x 100	S	50	295,00A2	M 20 x 30	S	25	330,00A2
M 8 x 45	S	200	32,00A2	M 12 x 110	S	25	355,00A2	M 20 x 35	S	25	270,00A2
M 8 x 45	K	100	36,00A2	M 12 x 120	S	25	430,00A2	M 20 x 40	S	25	248,00A2
M 8 x 50	S	200	34,00A2	M 12 x 130	S	1	530,00A2	M 20 x 45	S	25	265,00A2
M 8 x 50	K	100	38,50A2	M 12 x 140	S	1	620,00A2	M 20 x 50	S	25	285,00A2
M 8 x 55	S	100	52,00A2	M 12 x 150	S	1	710,00A2	M 20 x 55	S	25	310,00A2
M 8 x 60	S	200	55,00A2	M 12 x 160	S	1	800,00A2	M 20 x 60	S	25	315,00A2
M 8 x 60	K	100	59,00A2	M 12 x 170	S	1	980,00A2	M 20 x 65	S	25	350,00A2
M 8 x 65	S	50	68,00A2	M 12 x 180	S	1	980,00A2	M 20 x 70	S	25	360,00A2
M 8 x 70	S	50	81,00A2	M 12 x 190	S	1	1600,00A2	M 20 x 75	S	25	410,00A2
M 8 x 75	S	50	127,00A2	M 12 x 200	S	1	1790,00A2	M 20 x 80	S	25	410,00A2
M 8 x 80	S	50	102,00A2	M 14 x 20	S	50	218,00A2	M 20 x 85	S	25	840,00A2
M 8 x 85	S	50	163,00A2	M 14 x 25	S	50	181,00A2	M 20 x 90	S	25	670,00A2
M 8 x 90	S	50	130,00A2	M 14 x 30	S	50	132,00A2	M 20 x 95	S	10	670,00A2
M 8 x 100	S	50	147,00A2	M 14 x 35	S	50	132,00A2	M 20 x 100	S	10	760,00A2
M 8 x 110	S	50	220,00A2	M 14 x 40	S	50	141,00A2	M 20 x 110	S	10	870,00A2
M 8 x 120	S	50	260,00A2	M 14 x 45	S	50	151,00A2	M 20 x 120	S	10	960,00A2
M 8 x 130	S	50	325,00A2	M 14 x 50	S	50	160,00A2	M 20 x 130	S	10	1160,00A2
M 8 x 140	S	50	390,00A2	M 14 x 55	S	50	171,00A2	M 20 x 140	S	10	1260,00A2
M 8 x 150	S	50	455,00A2	M 14 x 60	S	50	182,00A2	M 20 x 150	S	10	1370,00A2

Abmessungen	VE	Stück	€/100/Obf.
M 20 x 160	S	10	2130,00A2
M 20 x 170	S	10	2210,00A2
M 20 x 180	S	10	2210,00A2
M 20 x 200	S	10	2410,00A2
M 20 x 220*	S	10	2950,00A2
M 22 x 30	S	25	1360,00A2
M 22 x 35	S	25	1360,00A2
M 22 x 40	S	25	1360,00A2
M 22 x 50	S	25	840,00A2
M 22 x 55	S	1	880,00A2
M 22 x 60	S	1	920,00A2
M 22 x 65	S	1	990,00A2
M 22 x 70	S	1	990,00A2
M 22 x 75	S	1	1070,00A2
M 22 x 80	S	1	1070,00A2
M 22 x 90	S	1	1320,00A2
M 22 x 100	S	1	1450,00A2
M 22 x 110	S	1	2330,00A2
M 22 x 120	S	1	2380,00A2
M 22 x 130	S	1	2430,00A2
M 22 x 140	S	1	2470,00A2
M 24 x 40	S	20	1070,00A2
M 24 x 45	S	20	1070,00A2
M 24 x 50	S	20	570,00A2
M 24 x 55	S	10	590,00A2
M 24 x 60	S	10	610,00A2
M 24 x 65	S	10	640,00A2
M 24 x 70	S	10	670,00A2
M 24 x 80	S	10	720,00A2
M 24 x 90	S	1	1010,00A2
M 24 x 100	S	1	1220,00A2
M 24 x 110	S	1	1430,00A2
M 24 x 120	S	1	1580,00A2
M 24 x 130	S	1	1710,00A2
M 24 x 140	S	1	1890,00A2
M 24 x 150	S	1	2040,00A2
M 24 x 160	S	1	2950,00A2
M 24 x 170	S	1	3050,00A2
M 24 x 180	S	1	3050,00A2
M 24 x 190	S	1	3150,00A2
M 24 x 200	S	1	3150,00A2
M 27 x 50	S	1	1060,00A2
M 27 x 55	S	1	1160,00A2
M 27 x 60	S	1	1170,00A2
M 27 x 65	S	1	1270,00A2
M 27 x 70	S	1	1270,00A2
M 27 x 80	S	1	1370,00A2
M 27 x 90	S	1	1470,00A2
M 27 x 100	S	1	1560,00A2
M 27 x 110	S	1	1780,00A2
M 27 x 120	S	1	1890,00A2
M 27 x 130	S	1	2040,00A2
M 27 x 140	S	1	2150,00A2
M 27 x 150	S	1	2280,00A2
M 30 x 60*	S	1	1560,00A2
M 30 x 65*	S	1	1690,00A2
M 30 x 70*	S	1	1760,00A2
M 30 x 80*	S	1	1870,00A2
M 30 x 90*	S	1	2040,00A2
M 30 x 100*	S	1	2220,00A2
M 30 x 110*	S	1	2440,00A2
M 30 x 120*	S	1	2600,00A2
M 30 x 130*	S	1	2850,00A2
M 30 x 140*	S	1	3050,00A2
M 30 x 150*	S	1	3200,00A2
M 33 x 70*	S	1	2280,00A2
M 33 x 80*	S	1	2470,00A2
M 33 x 90*	S	1	2650,00A2
M 33 x 100*	S	1	2850,00A2
M 33 x 110*	S	1	3150,00A2
M 33 x 120*	S	1	3350,00A2
M 33 x 130*	S	1	3500,00A2
M 33 x 140*	S	1	3700,00A2
M 33 x 150*	S	1	3900,00A2
M 36 x 80*	S	1	3200,00A2

Abmessungen	VE	Stück	€/100/Obf.
M 36 x 90*	S	1	3400,00A2
M 36 x 100*	S	1	3650,00A2
M 36 x 110*	S	1	4050,00A2
M 36 x 120*	S	1	4250,00A2
M 36 x 130*	S	1	4300,00A2
M 36 x 140*	S	1	4550,00A2
M 36 x 150*	S	1	4750,00A2

DIN	00933.924
933	A 2
	Sz



Sechskantschrauben mit Gewinde bis Kopf, Sz = Kopf mit Schlitz nach DIN 962

Maße → TI-15 Anziehmomente → TI-249
 Werkstoffeigensch. → TI-236 Normumstellung → TI-6
 Stahl → S. 164



M 4 x 6	S	100	46,00A2
M 4 x 8	S	100	41,00A2
M 4 x 10	S	100	40,50A2
M 4 x 12	S	100	39,50A2
M 5 x 8	S	100	45,50A2
M 5 x 10	S	100	43,50A2
M 5 x 12	S	100	43,00A2
M 5 x 16	S	100	41,00A2
M 5 x 20	S	100	43,00A2
M 5 x 25	S	100	46,00A2
M 5 x 30	S	100	49,50A2
M 6 x 10	S	100	48,50A2
M 6 x 12	S	100	46,00A2
M 6 x 16	S	100	44,50A2
M 6 x 20	S	100	47,50A2
M 6 x 25	S	100	52,00A2
M 6 x 30	S	100	56,00A2
M 6 x 35	S	100	60,00A2
M 6 x 40	S	100	65,00A2
M 8 x 16	S	100	99,00A2
M 8 x 20	S	100	99,00A2
M 8 x 25	S	100	105,00A2
M 8 x 30	S	100	108,00A2
M 8 x 35	S	100	112,00A2
M 8 x 40	S	100	118,00A2



- ✓ Große Artikelvielfalt
- ✓ Verlässliche Qualität
- ✓ Hohe Lieferbereitschaft

Abmessungen	VE	Stück	€/100/Obf.
DIN		00933.940	
933		A 4 (- 70)*	



Sechskantschrauben mit Gewinde bis Kopf

Maße → TI-15 Anziehmomente → TI-249
 Werkstoffeigensch. → TI-236 Normumstellung → TI-6

Stahl → S. 156
 Messing, Kunststoff → S. 625

DIN 933 → wird ersetzt durch ISO 4017

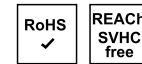

*Fkl. bei diesen Abmessungen je nach Fabrikat abweichend

M 3 x 5*	S	100	22,50A4
M 3 x 6*	S	100	18,20A4
M 3 x 8*	S	100	15,00A4
M 3 x 10*	S	100	14,50A4
M 3 x 12*	S	100	13,60A4
M 3 x 16*	S	100	13,60A4
M 3 x 18*	S	100	18,70A4
M 3 x 20*	S	100	14,80A4
M 3 x 25*	S	100	16,60A4
M 3 x 30*	S	100	19,20A4
M 3 x 35*	S	100	30,00A4
M 3 x 40*	S	100	42,00A4
M 4 x 6*	S	200	18,20A4
M 4 x 8*	S	200	15,00A4
M 4 x 10*	S	200	14,50A4
M 4 x 12*	S	200	13,60A4
M 4 x 14*	S	200	16,20A4
M 4 x 16*	S	200	11,10A4
M 4 x 18*	S	200	14,60A4
M 4 x 20*	S	200	11,70A4
M 4 x 25*	S	200	14,30A4
M 4 x 30*	S	200	16,20A4
M 4 x 35*	S	200	28,00A4
M 4 x 40*	S	200	36,50A4
M 4 x 45*	S	200	43,00A4
M 4 x 50*	S	200	46,00A4
M 4 x 60*	S	100	141,00A4
M 5 x 6*	S	100	46,00A4
M 5 x 8*	S	100	15,00A4
M 5 x 10	S	500	14,50A4
M 5 x 10	K	100	19,80A4
M 5 x 12	S	500	13,60A4
M 5 x 12	K	100	18,80A4
M 5 x 14	S	500	16,20A4
M 5 x 14	K	100	21,40A4
M 5 x 16	S	500	12,10A4
M 5 x 16	K	100	17,40A4
M 5 x 18	S	500	16,20A4
M 5 x 18	K	100	21,40A4
M 5 x 20	S	500	13,40A4
M 5 x 20	K	100	18,60A4
M 5 x 22	S	200	19,10A4
M 5 x 25	S	200	15,40A4
M 5 x 30	S	200	17,90A4
M 5 x 35	S	200	26,00A4
M 5 x 40	S	200	32,50A4
M 5 x 45	S	200	43,00A4
M 5 x 50	S	200	46,00A4
M 5 x 55	S	200	63,00A4
M 5 x 60	S	200	67,00A4
M 5 x 70	S	100	153,00A4
M 5 x 80	S	100	470,00A4

Abmessungen	VE	Stück	€/100/Obf.	Abmessungen	VE	Stück	€/100/Obf.	Abmessungen	VE	Stück	€/100/Obf.
M 6 x 8*	S	100	23,30A4	M 10 x 85	S	50	310,00A4	M 16 x 80	S	25	410,00A4
M 6 x 10	S	500	21,20A4	M 10 x 90	S	50	285,00A4	M 16 x 90	S	25	590,00A4
M 6 x 10	K	100	26,50A4	M 10 x 95	S	50	475,00A4	M 16 x 100	S	25	690,00A4
M 6 x 12	S	500	19,60A4	M 10 x 100	S	50	330,00A4	M 16 x 110	S	1	890,00A4
M 6 x 12	K	100	24,80A4	M 10 x 110	S	50	460,00A4	M 16 x 120	S	1	1010,00A4
M 6 x 14	S	500	22,70A4	M 10 x 120	S	50	570,00A4	M 16 x 130	S	1	1150,00A4
M 6 x 14	K	100	28,00A4	M 10 x 130	S	1	740,00A4	M 16 x 140	S	1	1270,00A4
M 6 x 16	S	200	15,40A4	M 10 x 140	S	1	870,00A4	M 16 x 150	S	1	1410,00A4
M 6 x 20	S	200	16,60A4	M 10 x 150	S	1	1020,00A4	M 16 x 160	S	1	2600,00A4
M 6 x 22	S	200	22,90A4	M 10 x 160	S	1	1150,00A4	M 16 x 170	S	1	2700,00A4
M 6 x 25	S	200	18,30A4	M 10 x 170	S	1	1320,00A4	M 16 x 180	S	1	2700,00A4
M 6 x 30	S	200	20,90A4	M 10 x 180	S	1	1420,00A4	M 16 x 190	S	1	2850,00A4
M 6 x 35	S	200	24,60A4	M 10 x 200	S	1	1830,00A4	M 16 x 200	S	1	2850,00A4
M 6 x 40	S	200	28,00A4	M 12 x 16	S	100	145,00A4	M 18 x 30	S	1	790,00A4
M 6 x 45	S	100	37,50A4	M 12 x 18	S	100	145,00A4	M 18 x 35	S	1	710,00A4
M 6 x 50	S	100	43,50A4	M 12 x 20	S	100	117,00A4	M 18 x 40	S	1	710,00A4
M 6 x 55	S	100	58,00A4	M 12 x 22	S	100	138,00A4	M 18 x 45	S	1	710,00A4
M 6 x 60	S	100	63,00A4	M 12 x 25	S	100	98,00A4	M 18 x 50	S	1	740,00A4
M 6 x 65	S	50	99,00A4	M 12 x 30	S	100	98,00A4	M 18 x 55	S	1	790,00A4
M 6 x 70	S	50	99,00A4	M 12 x 35	S	100	106,00A4	M 18 x 60	S	1	800,00A4
M 6 x 75	S	50	149,00A4	M 12 x 40	S	50	109,00A4	M 18 x 65	S	1	890,00A4
M 6 x 80	S	50	120,00A4	M 12 x 45	S	50	117,00A4	M 18 x 70	S	1	920,00A4
M 6 x 90	S	50	168,00A4	M 12 x 50	S	50	126,00A4	M 18 x 75	S	1	1020,00A4
M 6 x 100	S	50	192,00A4	M 12 x 55	S	50	152,00A4	M 18 x 80	S	1	1020,00A4
M 6 x 110	S	50	580,00A4	M 12 x 60	S	50	154,00A4	M 18 x 90	S	1	1470,00A4
M 6 x 120	S	50	700,00A4	M 12 x 65	S	50	198,00A4	M 18 x 100	S	1	1730,00A4
M 8 x 8*	S	100	91,00A4	M 12 x 70	S	50	205,00A4	M 18 x 110	S	1	2100,00A4
M 8 x 10	S	200	46,00A4	M 12 x 75	S	50	295,00A4	M 18 x 120	S	1	2290,00A4
M 8 x 12	S	200	45,00A4	M 12 x 80	S	50	235,00A4	M 18 x 130	S	1	2700,00A4
M 8 x 14	S	200	54,00A4	M 12 x 85	S	50	380,00A4	M 18 x 150	S	1	3200,00A4
M 8 x 16	S	200	35,50A4	M 12 x 90	S	50	295,00A4	M 20 x 20*	S	25	710,00A4
M 8 x 18	S	200	45,50A4	M 12 x 95	S	1	630,00A4	M 20 x 30	S	25	530,00A4
M 8 x 20	S	200	35,50A4	M 12 x 100	S	1	345,00A4	M 20 x 35	S	25	470,00A4
M 8 x 22	S	200	45,50A4	M 12 x 110	S	1	500,00A4	M 20 x 40	S	25	470,00A4
M 8 x 25	S	200	36,00A4	M 12 x 120	S	1	630,00A4	M 20 x 45	S	25	470,00A4
M 8 x 30	S	200	38,00A4	M 12 x 130	S	1	810,00A4	M 20 x 50	S	25	490,00A4
M 8 x 35	S	200	42,50A4	M 12 x 140	S	1	980,00A4	M 20 x 55	S	25	530,00A4
M 8 x 40	S	100	44,50A4	M 12 x 150	S	1	1140,00A4	M 20 x 60	S	25	540,00A4
M 8 x 45	S	100	53,00A4	M 12 x 160	S	1	1300,00A4	M 20 x 65	S	25	600,00A4
M 8 x 50	S	100	57,00A4	M 12 x 170	S	1	1570,00A4	M 20 x 70	S	25	610,00A4
M 8 x 55	S	100	74,00A4	M 12 x 180	S	1	1620,00A4	M 20 x 75	S	25	680,00A4
M 8 x 60	S	100	80,00A4	M 12 x 190	S	1	2040,00A4	M 20 x 80	S	25	680,00A4
M 8 x 65	S	50	108,00A4	M 12 x 200	S	1	2360,00A4	M 20 x 90	S	1	980,00A4
M 8 x 70	S	50	114,00A4	M 14 x 20	S	50	315,00A4	M 20 x 100	S	1	1150,00A4
M 8 x 75	S	50	174,00A4	M 14 x 25	S	50	290,00A4	M 20 x 110	S	1	1400,00A4
M 8 x 80	S	50	140,00A4	M 14 x 30	S	50	248,00A4	M 20 x 120	S	1	1530,00A4
M 8 x 90	S	50	200,00A4	M 14 x 35	S	50	248,00A4	M 20 x 130	S	1	1790,00A4
M 8 x 100	S	50	227,00A4	M 14 x 40	S	50	248,00A4	M 20 x 140	S	1	1920,00A4
M 8 x 110	S	1	300,00A4	M 14 x 45	S	50	255,00A4	M 20 x 150	S	1	2120,00A4
M 8 x 120	S	1	345,00A4	M 14 x 50	S	50	270,00A4	M 20 x 160	S	1	3850,00A4
M 8 x 130	S	1	445,00A4	M 14 x 55	S	50	300,00A4	M 20 x 170	S	1	3900,00A4
M 8 x 140	S	1	540,00A4	M 14 x 60	S	50	305,00A4	M 20 x 180	S	1	3900,00A4
M 8 x 150	S	1	640,00A4	M 14 x 65	S	50	355,00A4	M 20 x 190	S	1	4150,00A4
M 8 x 160	S	1	730,00A4	M 14 x 70	S	50	365,00A4	M 20 x 200	S	1	4150,00A4
M 8 x 170	S	1	920,00A4	M 14 x 75	S	50	500,00A4	M 22 x 40	S	1	2260,00A4
M 8 x 180	S	1	920,00A4	M 14 x 80	S	1	410,00A4	M 22 x 45	S	1	2260,00A4
M 8 x 200	S	1	1380,00A4	M 14 x 100	S	1	690,00A4	M 22 x 50	S	1	1840,00A4
M 10 x 10*	S	100	244,00A4	M 14 x 110	S	1	890,00A4	M 22 x 55	S	1	1880,00A4
M 10 x 12	S	100	144,00A4	M 14 x 120	S	1	1010,00A4	M 22 x 60	S	1	1930,00A4
M 10 x 14	S	100	104,00A4	M 14 x 130	S	1	1150,00A4	M 22 x 65	S	1	1990,00A4
M 10 x 16	S	100	84,00A4	M 14 x 140	S	1	1270,00A4	M 22 x 70	S	1	2100,00A4
M 10 x 20	S	100	65,00A4	M 14 x 150	S	1	1410,00A4	M 22 x 75	S	1	2280,00A4
M 10 x 22	S	100	79,00A4	M 14 x 160*	S	1	2650,00A4	M 22 x 80	S	1	2280,00A4
M 10 x 25	S	100	63,00A4	M 16 x 20	S	50	315,00A4	M 22 x 90	S	1	2950,00A4
M 10 x 30	S	100	67,00A4	M 16 x 25	S	50	290,00A4	M 22 x 100	S	1	3200,00A4
M 10 x 35	S	100	70,00A4	M 16 x 30	S	50	248,00A4	M 22 x 110	S	1	3950,00A4
M 10 x 40	S	100	77,00A4	M 16 x 35	S	50	248,00A4	M 22 x 120	S	1	4300,00A4
M 10 x 45	S	100	84,00A4	M 16 x 40	S	50	248,00A4	M 22 x 130	S	1	4700,00A4
M 10 x 50	S	100	92,00A4	M 16 x 45	S	50	255,00A4	M 22 x 140	S	1	5100,00A4
M 10 x 55	S	50	118,00A4	M 16 x 50	S	50	270,00A4	M 24 x 30	S	1	2020,00A4
M 10 x 60	S	50	123,00A4	M 16 x 55	S	25	300,00A4	M 24 x 35	S	1	2020,00A4
M 10 x 65	S	50	149,00A4	M 16 x 60	S	25	305,00A4	M 24 x 40	S	1	1690,00A4
M 10 x 70	S	50	157,00A4	M 16 x 65	S	25	355,00A4	M 24 x 45	S	1	1690,00A4
M 10 x 75	S	50	242,00A4	M 16 x 70	S	25	365,00A4	M 24 x 50	S	1	1150,00A4
M 10 x 80	S	50	193,00A4	M 16 x 75	S	25	410,00A4	M 24 x 55	S	1	1170,00A4

Abmessungen	VE	Stück	€/100/Obf.
M 24 x 60	S	1	1200,00 A4
M 24 x 65	S	1	1250,00 A4
M 24 x 70	S	1	1310,00 A4
M 24 x 75	S	1	1430,00 A4
M 24 x 80	S	1	1430,00 A4
M 24 x 90	S	1	1950,00 A4
M 24 x 100	S	1	2120,00 A4
M 24 x 110	S	1	2450,00 A4
M 24 x 120	S	1	2700,00 A4
M 24 x 130	S	1	2950,00 A4
M 24 x 140	S	1	3150,00 A4
M 24 x 150	S	1	3450,00 A4
M 24 x 160	S	1	5200,00 A4
M 24 x 170	S	1	5300,00 A4
M 24 x 180	S	1	5300,00 A4
M 24 x 190	S	1	5400,00 A4
M 24 x 200	S	1	5400,00 A4
M 27 x 50	S	1	2100,00 A4
M 27 x 55	S	1	2220,00 A4
M 27 x 60	S	1	2320,00 A4
M 27 x 65	S	1	2420,00 A4
M 27 x 70	S	1	2550,00 A4
M 27 x 80	S	1	2750,00 A4
M 27 x 90	S	1	3000,00 A4
M 27 x 100	S	1	3200,00 A4
M 27 x 110	S	1	3600,00 A4
M 27 x 120	S	1	3800,00 A4
M 27 x 130	S	1	3950,00 A4
M 27 x 140	S	1	4150,00 A4
M 27 x 150	S	1	4300,00 A4
M 30 x 40*	S	1	5100,00 A4
M 30 x 50*	S	1	3700,00 A4
M 30 x 60*	S	1	2900,00 A4
M 30 x 65*	S	1	3000,00 A4
M 30 x 70*	S	1	3100,00 A4
M 30 x 80*	S	1	3350,00 A4
M 30 x 90*	S	1	3600,00 A4
M 30 x 100*	S	1	4000,00 A4
M 30 x 110*	S	1	4550,00 A4
M 30 x 120*	S	1	4850,00 A4
M 30 x 130*	S	1	5100,00 A4
M 30 x 140*	S	1	5200,00 A4
M 30 x 150*	S	1	5300,00 A4
M 33 x 70*	S	1	4200,00 A4
M 33 x 80*	S	1	4550,00 A4
M 33 x 90*	S	1	4850,00 A4
M 33 x 120*	S	1	6100,00 A4
M 33 x 130*	S	1	6300,00 A4
M 33 x 140*	S	1	6400,00 A4
M 33 x 150*	S	1	6500,00 A4
M 36 x 80*	S	1	5600,00 A4
M 36 x 90*	S	1	6000,00 A4
M 36 x 100*	S	1	6800,00 A4
M 36 x 110*	S	1	7100,00 A4
M 36 x 120*	S	1	7400,00 A4
M 36 x 130*	S	1	7600,00 A4
M 36 x 140*	S	1	7800,00 A4
M 36 x 150*	S	1	7900,00 A4

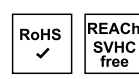
Abmessungen	VE	Stück	€/100/Obf.
DIN 933			00933.948 A 4 - 80
			
Sechskantschrauben mit Gewinde bis Kopf			
hochfest (stark kaltverfestigt)			
Maße → TI-15 Anziehmomente → TI-249			
Werkstoffeigensch. → TI-236 Normumstellung → TI-6			
Stahl → S. 156			
Messing, Kunststoff → S. 625			
DIN 933 → wird ersetzt durch ISO 4017			
			
M 5 x 10	S	500	36,50 A4-80
M 5 x 16	S	500	30,50 A4-80
M 5 x 20	S	500	40,50 A4-80
M 5 x 25	S	200	33,50 A4-80
M 5 x 30	S	200	38,50 A4-80
M 5 x 35	S	200	45,00 A4-80
M 5 x 40	S	200	66,00 A4-80
M 5 x 50	S	200	81,00 A4-80
M 5 x 60	S	200	116,00 A4-80
M 5 x 70	S	100	168,00 A4-80
M 6 x 10	S	100	54,00 A4-80
M 6 x 12	S	100	49,00 A4-80
M 6 x 16	S	100	38,50 A4-80
M 6 x 20	S	100	42,00 A4-80
M 6 x 25	S	100	46,00 A4-80
M 6 x 30	S	100	53,00 A4-80
M 6 x 35	S	100	62,00 A4-80
M 6 x 40	S	100	71,00 A4-80
M 6 x 45	S	100	95,00 A4-80
M 6 x 50	S	100	110,00 A4-80
M 6 x 55	S	100	143,00 A4-80
M 6 x 60	S	100	154,00 A4-80
M 6 x 70	S	50	248,00 A4-80
M 6 x 80	S	50	305,00 A4-80
M 6 x 90	S	50	420,00 A4-80
M 6 x 100	S	50	485,00 A4-80
M 6 x 110	S	50	560,00 A4-80
M 6 x 120	S	50	630,00 A4-80
M 8 x 10	S	100	116,00 A4-80
M 8 x 12	S	100	114,00 A4-80
M 8 x 16	S	100	91,00 A4-80
M 8 x 20	S	100	91,00 A4-80
M 8 x 25	S	100	91,00 A4-80
M 8 x 30	S	100	96,00 A4-80
M 8 x 35	S	100	107,00 A4-80
M 8 x 40	S	100	114,00 A4-80
M 8 x 45	S	100	133,00 A4-80
M 8 x 50	S	100	143,00 A4-80
M 8 x 55	S	100	187,00 A4-80
M 8 x 60	S	100	198,00 A4-80
M 8 x 65	S	100	242,00 A4-80
M 8 x 70	S	50	265,00 A4-80
M 8 x 80	S	50	310,00 A4-80
M 8 x 90	S	50	320,00 A4-80
M 8 x 100	S	50	385,00 A4-80
M 8 x 110	S	1	460,00 A4-80
M 8 x 120	S	1	560,00 A4-80
M 8 x 130	S	1	670,00 A4-80
M 8 x 140	S	1	800,00 A4-80
M 8 x 150	S	1	960,00 A4-80

Abmessungen	VE	Stück	€/100/Obf.
M 8 x 160	S	1	1160,00 A4-80
M 10 x 16	S	100	208,00 A4-80
M 10 x 20	S	100	162,00 A4-80
M 10 x 25	S	100	158,00 A4-80
M 10 x 30	S	100	168,00 A4-80
M 10 x 35	S	100	177,00 A4-80
M 10 x 40	S	100	191,00 A4-80
M 10 x 45	S	100	210,00 A4-80
M 10 x 50	S	100	229,00 A4-80
M 10 x 55	S	100	295,00 A4-80
M 10 x 60	S	100	310,00 A4-80
M 10 x 65	S	100	375,00 A4-80
M 10 x 70	S	100	395,00 A4-80
M 10 x 75	S	50	620,00 A4-80
M 10 x 80	S	50	485,00 A4-80
M 10 x 90	S	50	630,00 A4-80
M 10 x 100	S	50	1000,00 A4-80
M 10 x 110	S	50	1160,00 A4-80
M 10 x 120	S	50	1430,00 A4-80
M 10 x 130	S	1	1850,00 A4-80
M 10 x 140	S	1	2190,00 A4-80
M 10 x 150	S	1	2550,00 A4-80
M 10 x 160	S	1	2900,00 A4-80
M 10 x 170	S	1	3350,00 A4-80
M 10 x 180	S	1	3550,00 A4-80
M 10 x 190	S	1	4100,00 A4-80
M 10 x 200	S	1	4600,00 A4-80
M 12 x 20	S	100	295,00 A4-80
M 12 x 25	S	100	246,00 A4-80
M 12 x 30	S	100	246,00 A4-80
M 12 x 35	S	100	265,00 A4-80
M 12 x 40	S	100	275,00 A4-80
M 12 x 45	S	50	295,00 A4-80
M 12 x 50	S	50	315,00 A4-80
M 12 x 55	S	50	380,00 A4-80
M 12 x 60	S	50	385,00 A4-80
M 12 x 65	S	50	495,00 A4-80
M 12 x 70	S	50	510,00 A4-80
M 12 x 75	S	50	750,00 A4-80
M 12 x 80	S	50	600,00 A4-80
M 12 x 90	S	50	810,00 A4-80
M 12 x 100	S	1	870,00 A4-80
M 12 x 110	S	1	1520,00 A4-80
M 12 x 120	S	1	1560,00 A4-80
M 12 x 130	S	1	1520,00 A4-80
M 12 x 140	S	1	2440,00 A4-80
M 12 x 150	S	1	2850,00 A4-80
M 12 x 160	S	1	3300,00 A4-80
M 12 x 170	S	1	3950,00 A4-80
M 12 x 180	S	1	4100,00 A4-80
M 12 x 190	S	1	5100,00 A4-80
M 12 x 200	S	1	6000,00 A4-80
M 14 x 25	S	50	740,00 A4-80
M 14 x 30	S	50	630,00 A4-80
M 14 x 35	S	50	630,00 A4-80
M 14 x 40	S	50	630,00 A4-80
M 14 x 45	S	50	640,00 A4-80
M 14 x 50	S	50	680,00 A4-80
M 14 x 55	S	50	760,00 A4-80
M 14 x 60	S	50	770,00 A4-80
M 14 x 65	S	50	900,00 A4-80
M 14 x 70	S	50	920,00 A4-80
M 14 x 80	S	1	1040,00 A4-80
M 14 x 90	S	1	1520,00 A4-80
M 14 x 100	S	1	1680,00 A4-80
M 14 x 110	S	1	2060,00 A4-80
M 14 x 120	S	1	2350,00 A4-80
M 14 x 130	S	1	2700,00 A4-80
M 14 x 140	S	1	3000,00 A4-80
M 14 x 150	S	1	3350,00 A4-80
M 14 x 160	S	1	3900,00 A4-80
M 14 x 170	S	1	4300,00 A4-80
M 14 x 180	S	1	4700,00 A4-80
M 14 x 190	S	1	5200,00 A4-80
M 14 x 200	S	1	6200,00 A4-80

Abmessungen	VE	Stück	€/100/Obf.
M 16 x 25	S	50	740,00 A4-80
M 16 x 30	S	50	630,00 A4-80
M 16 x 35	S	50	630,00 A4-80
M 16 x 40	S	50	630,00 A4-80
M 16 x 45	S	50	640,00 A4-80
M 16 x 50	S	25	680,00 A4-80
M 16 x 55	S	25	760,00 A4-80
M 16 x 60	S	25	770,00 A4-80
M 16 x 65	S	25	900,00 A4-80
M 16 x 70	S	25	920,00 A4-80
M 16 x 75	S	25	1200,00 A4-80
M 16 x 80	S	25	1040,00 A4-80
M 16 x 90	S	25	1490,00 A4-80
M 16 x 100	S	25	1730,00 A4-80
M 16 x 110	S	1	1970,00 A4-80
M 16 x 120	S	1	2550,00 A4-80
M 16 x 130	S	1	2900,00 A4-80
M 16 x 140	S	1	3200,00 A4-80
M 16 x 150	S	1	3550,00 A4-80
M 16 x 160	S	1	4350,00 A4-80
M 16 x 170	S	1	4750,00 A4-80
M 16 x 180	S	1	5200,00 A4-80
M 16 x 190	S	1	6300,00 A4-80
M 16 x 200	S	1	7100,00 A4-80
M 20 x 30	S	25	1330,00 A4-80
M 20 x 35	S	25	1430,00 A4-80
M 20 x 40	S	25	1200,00 A4-80
M 20 x 45	S	25	1200,00 A4-80
M 20 x 50	S	25	1240,00 A4-80
M 20 x 55	S	25	1350,00 A4-80
M 20 x 60	S	25	1350,00 A4-80
M 20 x 65	S	25	1520,00 A4-80
M 20 x 70	S	25	1540,00 A4-80
M 20 x 75	S	25	1640,00 A4-80
M 20 x 80	S	25	1700,00 A4-80
M 20 x 90	S	1	2460,00 A4-80
M 20 x 100	S	1	2900,00 A4-80
M 20 x 110	S	1	3550,00 A4-80
M 20 x 120	S	1	3850,00 A4-80
M 20 x 130	S	1	4500,00 A4-80
M 20 x 140	S	1	4850,00 A4-80
M 20 x 150	S	1	5400,00 A4-80
M 20 x 160	S	1	6000,00 A4-80
M 20 x 170	S	1	6800,00 A4-80
M 20 x 180	S	1	7500,00 A4-80
M 20 x 190	S	1	8300,00 A4-80
M 20 x 200	S	1	9400,00 A4-80
M 24 x 50	S	1	2900,00 A4-80
M 24 x 55	S	1	2180,00 A4-80
M 24 x 60	S	1	3050,00 A4-80
M 24 x 70	S	1	3300,00 A4-80
M 24 x 80	S	1	2750,00 A4-80
M 24 x 90	S	1	2950,00 A4-80
M 24 x 100	S	1	3200,00 A4-80
M 24 x 110	S	1	3400,00 A4-80
M 24 x 120	S	1	3650,00 A4-80
M 24 x 130	S	1	7400,00 A4-80
M 24 x 140	S	1	8000,00 A4-80
M 24 x 150	S	1	8700,00 A4-80
M 24 x 160	S	1	13100,00 A4-80
M 24 x 170	S	1	13300,00 A4-80
M 24 x 180	S	1	13900,00 A4-80
M 24 x 190	S	1	14500,00 A4-80
M 24 x 200	S	1	15600,00 A4-80

Abmessungen	VE	Stück	€/100/Obf.
M 6 x 10	S	100	126,00 A5
M 6 x 20	S	100	133,00 A5
M 6 x 25	S	100	154,00 A5
M 6 x 30	S	100	156,00 A5
M 6 x 40	S	100	164,00 A5
M 6 x 50	S	100	175,00 A5
M 8 x 25	S	100	200,00 A5
M 8 x 30	S	100	223,00 A5
M 8 x 35	S	100	242,00 A5
M 8 x 40	S	100	335,00 A5
M 8 x 50	S	100	370,00 A5
M 8 x 60	S	100	465,00 A5
M 10 x 20	S	1	850,00 A5
M 10 x 25	S	1	870,00 A5
M 10 x 30	S	1	880,00 A5
M 10 x 35	S	1	900,00 A5
M 10 x 40	S	1	920,00 A5
M 10 x 45	S	1	940,00 A5
M 10 x 50	S	1	1120,00 A5
M 12 x 20	S	1	870,00 A5
M 12 x 25	S	1	880,00 A5
M 12 x 30	S	1	900,00 A5
M 12 x 35	S	1	920,00 A5
M 12 x 40	S	1	940,00 A5
M 12 x 45	S	1	960,00 A5
M 12 x 50	S	1	1140,00 A5
M 12 x 60	S	1	1370,00 A5
M 16 x 25	S	1	1240,00 A5
M 16 x 30	S	1	1260,00 A5
M 16 x 35	S	1	1310,00 A5
M 16 x 40	S	1	1350,00 A5
M 16 x 45	S	1	1370,00 A5
M 16 x 50	S	1	1410,00 A5
M 16 x 55	S	1	2000,00 A5
M 16 x 60	S	1	2100,00 A5
M 16 x 65	S	1	2310,00 A5
M 20 x 35	S	1	2480,00 A5
M 20 x 40	S	1	2500,00 A5
M 20 x 45	S	1	2600,00 A5
M 20 x 50	S	1	2650,00 A5
M 20 x 60	S	1	2950,00 A5
M 20 x 70	S	1	3400,00 A5

DIN	00933.950
933	1.4571 (A 5)

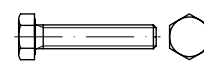

Sechskantschrauben mit Gewinde bis Kopf

Maße → **TI-15** Anziehmomente → **TI-245**
 Werkstoffeigensch. → **TI-236** Normumstellung → **TI-7**
 Stahl → **S. 156**
 Messing, Kunststoff → **S. 625**
 DIN 933 → wird ersetzt durch ISO 4017



Abmessungen	VE	Stück	€/100/Obf.
M 1,6	S	500	41,00 A1/A2
M 2	S	500	29,00 A1/A2
M 2	K	100	37,50 A1/A2
M 2,3	S	500	48,00 A1/A2
M 2,3	K	100	52,00 A1/A2
M 2,5	S	500	26,50 A1/A2
M 2,5	K	100	32,00 A1/A2
M 2,6	S	500	52,00 A1/A2
M 2,6	K	100	60,00 A1/A2

DIN	00934.910
934	A 1/A 2

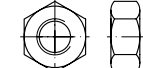

Sechskantmuttern

Maße → **TI-62** Anziehmomente → **TI-249**
 Werkstoffeigensch. → **TI-236** Normumstellung → **TI-7**
 Stahl → **S. 168**
 Messing, Kupfer, Aluminium, Titan → **S. 626**
 DIN 934 → wird ersetzt durch ISO 4032

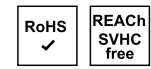

DIN	00934.920
934	A 2 (- 70)*



Sechskantmuttern

Maße → **TI-62** Anziehmomente → **TI-249**
 Werkstoffeigensch. → **TI-236** Normumstellung → **TI-7**
 Stahl → **S. 168**
 Messing, Kupfer, Aluminium, Titan → **S. 626**
 DIN 934 → wird ersetzt durch ISO 4032

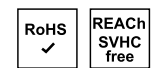

*Fkl. bei diesen Abmessungen je nach Fabrikat abweichend

M 3*	S	1000	10,60 A2
M 3*	K	100	16,80 A2
M 3,5*	K	100	45,00 A2
M 4*	S	1000	12,00 A2
M 4*	K	100	17,50 A2
M 5	S	1000	14,00 A2
M 5	K	100	19,70 A2
M 6	S	1000	21,20 A2
M 6	K	100	27,00 A2
M 7	S	100	35,00 A2
M 8	S	500	39,50 A2
M 8	K	100	46,00 A2
M 10	S	250	84,00 A2
M 10	K	100	90,00 A2
M 12	S	250	120,00 A2
M 12	K	100	126,00 A2
M 14	S	25	209,00 A2
M 16	S	50	209,00 A2
M 18	S	10	540,00 A2
M 20	S	25	540,00 A2
M 22	S	10	1220,00 A2

Abmessungen	VE	Stück	€/100/Obf.
M 24	S	25	1220,00 A2
M 27	S	1	2310,00 A2
M 30*	S	1	3250,00 A2
M 33*	S	1	4250,00 A2
M 36*	S	1	4650,00 A2
M 42*	S	1	6800,00 A2
M 48*	S	1	11300,00 A2

DIN	00934.931
934	A 2 - 70 geschmiert

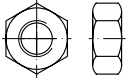

Sechskantmuttern, geschmiert

Reibzahlfenster je Charge auf Anfrage

Maße → [TI-62](#) Anziehmomente → [TI-249](#)
 Werkstoffeigensch. → [TI-236](#) Normumstellung → [TI-7](#)

DIN 934 → wird ersetzt durch ISO 4032

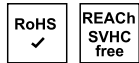

M 10	S	250	84,00 A2
M 12	S	250	120,00 A2

DIN	00934.925
934	A 2 Fein

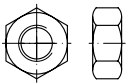

Sechskantmuttern mit metrischem Feingewinde

Maße → [TI-62](#) Anziehmomente → [TI-249](#)
 Werkstoffeigensch. → [TI-236](#) Normumstellung → [TI-7](#)

DIN 934 Feingew. → wird ersetzt durch ISO 8673

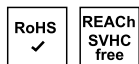

M 6	x 0,75	S	100	152,00 A2
M 8	x 1	S	100	92,00 A2
M 10	x 1	S	50	126,00 A2
M 10	x 1,25	S	50	126,00 A2
M 12	x 1,25	S	50	222,00 A2
M 12	x 1,5	S	50	182,00 A2
M 14	x 1,5	S	25	248,00 A2
M 16	x 1,5	S	25	335,00 A2
M 18	x 1,5	S	10	610,00 A2
M 20	x 1,5	S	10	620,00 A2
M 24	x 1,5	S	10	1420,00 A2
M 24	x 2	S	10	1420,00 A2
M 30	x 1,5	S	1	3500,00 A2
M 30	x 2	S	1	3500,00 A2
M 36	x 1,5	S	1	5800,00 A2

Abmessungen	VE	Stück	€/100/Obf.
DIN	00934.924		
934	A 2	Links	

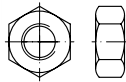

Sechskantmuttern mit metrischem Linksgewinde

Maße → [TI-62](#) Anziehmomente → [TI-249](#)
 Werkstoffeigensch. → [TI-236](#) Normumstellung → [TI-7](#)

DIN 934 → wird ersetzt durch ISO 4032



M 5 -LH	S	100	39,00 A2
M 6 -LH	S	100	59,00 A2
M 8 -LH	S	100	94,00 A2
M 10 -LH	S	50	180,00 A2
M 12 -LH	S	25	245,00 A2
M 14 -LH	S	25	460,00 A2
M 16 -LH	S	25	460,00 A2
M 18 -LH	S	25	570,00 A2
M 20 -LH	S	1	710,00 A2
M 22 -LH	S	10	990,00 A2
M 24 -LH	S	1	1950,00 A2
M 27 -LH	S	1	2050,00 A2
M 30 -LH	S	1	2370,00 A2

DIN	00934.940
934	A 4 (- 70)*

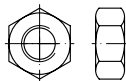

Sechskantmuttern

Maße → [TI-62](#) Anziehmomente → [TI-249](#)
 Werkstoffeigensch. → [TI-236](#) Normumstellung → [TI-7](#)

Stahl → [S. 168](#)
 Messing, Kupfer, Aluminium, Titan → [S. 626](#)

DIN 934 → wird ersetzt durch ISO 4032



*Fkl. bei diesen Abmessungen je nach Fabrikat abweichend

M 2*	S	1000	38,00 A4
M 2*	K	100	43,50 A4
M 2,5*	S	500	36,50 A4
M 2,5*	K	100	42,00 A4
M 3*	S	1000	15,20 A4
M 3*	K	100	21,90 A4
M 4*	S	1000	17,10 A4
M 4*	K	100	25,50 A4
M 5	S	1000	18,40 A4
M 5	K	100	26,50 A4
M 6	S	1000	28,50 A4
M 6	K	100	36,50 A4
M 7	S	100	52,00 A4
M 8	S	500	55,00 A4
M 8	K	100	62,00 A4
M 10	S	250	117,00 A4
M 10	K	50	129,00 A4
M 12	S	250	161,00 A4

Abmessungen	VE	Stück	€/100/Obf.
M 12	K	50	173,00 A4
M 14	S	25	335,00 A4
M 16	S	50	335,00 A4
M 18	S	10	820,00 A4
M 20	S	25	820,00 A4
M 22	S	10	1650,00 A4
M 24	S	10	1650,00 A4
M 27*	S	1	3150,00 A4
M 30*	S	1	4200,00 A4
M 33*	S	1	5400,00 A4
M 36*	S	1	6500,00 A4
M 39*	S	1	13100,00 A4
M 42*	S	1	9200,00 A4
M 48*	S	1	17500,00 A4

DIN	00934.951
934	A 4 - 70 geschmiert

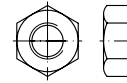

Sechskantmuttern, geschmiert

Reibzahlfenster je Charge auf Anfrage

Maße → [TI-62](#) Anziehmomente → [TI-249](#)
 Werkstoffeigensch. → [TI-236](#) Normumstellung → [TI-7](#)

DIN 934 → wird ersetzt durch ISO 4032

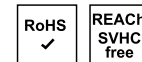

M 10	S	250	106,00 A4
M 12	S	250	146,00 A4

DIN	00934.948
934	A 4 - 80

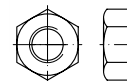

Sechskantmuttern

hochfest (stark kaltverfestigt)

Maße → [TI-62](#) Anziehmomente → [TI-249](#)
 Werkstoffeigensch. → [TI-236](#) Normumstellung → [TI-7](#)

Stahl → [S. 168](#)
 Messing, Kupfer, Aluminium, Titan → [S. 626](#)

DIN 934 → wird ersetzt durch ISO 4032

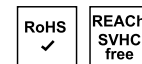

M 5	S	1000	16,20 A4-80
M 6	S	200	21,60 A4-80
M 8	S	200	27,00 A4-80
M 10	S	100	54,00 A4-80
M 12	S	100	70,00 A4-80
M 14	S	100	118,00 A4-80
M 16	S	50	151,00 A4-80
M 18	S	50	217,00 A4-80
M 20	S	50	244,00 A4-80
M 24	S	25	740,00 A4-80

Abmessungen	VE Stück	€/100/Obf.
DIN	00934.950	
934 1.4571 (A 5)		

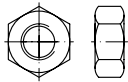

Sechskantmuttern

Maße → [TI-62](#) Anziehmomente → [TI-249](#)
 Werkstoffeigensch. → [TI-236](#) Normumstellung → [TI-7](#)
 Stahl → [S. 168](#)
 Messing, Kupfer, Aluminium, Titan → [S. 626](#)
 DIN 934 → wird ersetzt durch ISO 4032



M 6	S 100	214,00 A5
M 8	S 100	233,00 A5
M 10	S 100	248,00 A5
M 12	S 50	320,00 A5
M 16	S 25	540,00 A5
M 20	S 25	1070,00 A5
M 24	S 10	1880,00 A5
M 27	S 10	3050,00 A5
M 30	S 10	4150,00 A5

DIN	00934.944	
934 A 4 Links		

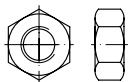

Sechskantmuttern mit metrischem Linksgewinde

Maße → [TI-62](#) Anziehmomente → [TI-249](#)
 Werkstoffeigensch. → [TI-236](#) Normumstellung → [TI-7](#)
 DIN 934 → wird ersetzt durch ISO 4032

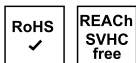

M 5 -LH	S 100	55,00 A4
M 6 -LH	S 100	76,00 A4
M 8 -LH	S 100	116,00 A4
M 10 -LH	S 50	217,00 A4
M 12 -LH	S 25	295,00 A4
M 14 -LH	S 25	550,00 A4
M 16 -LH	S 25	570,00 A4
M 18 -LH	S 25	780,00 A4
M 20 -LH	S 10	950,00 A4
M 22 -LH	S 10	1520,00 A4
M 24 -LH	S 10	2380,00 A4
M 27 -LH	S 1	2950,00 A4
M 30 -LH	S 1	3450,00 A4

Abmessungen	VE Stück	€/100/Obf.
DIN	00935.920	
935-1 A 2		

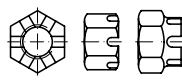

Kronenmuttern

Maße → [TI-67](#) Werkstoffeigensch. → [TI-236](#)
 Stahl → [S. 173](#)

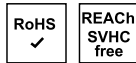

M 6	S 50	150,00 A2
M 8	S 25	203,00 A2
M 10 SW 17	S 25	300,00 A2
M 12 SW 19	S 25	375,00 A2
M 16	S 1	700,00 A2
M 20	S 1	1180,00 A2
M 24	S 1	1650,00 A2

DIN	00935.940	
935-1 A 4		

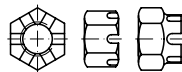

Kronenmuttern

Maße → [TI-67](#) Werkstoffeigensch. → [TI-236](#)
 Stahl → [S. 173](#)



M 8	S 25	400,00 A4
M 10 SW 17	S 25	430,00 A4
M 12 SW 19	S 25	600,00 A4
M 16	S 1	1000,00 A4
M 20	S 1	1770,00 A4
M 24	S 1	3400,00 A4
M 30	S 1	17900,00 A4

Abmessungen	VE Stück	€/100/Obf.
DIN	00936.920	
936 A 2		

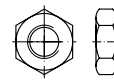

Sechskantmuttern, niedrige Form

Maße → [TI-63](#) Normumstellung → [TI-7](#)
 Werkstoffeigensch. → [TI-236](#)

Stahl → [S. 174](#)
 Messing → [S. 627](#)

Muttern nach ISO → ISO 4035 (DIN 439)



M 8	S 100	64,00 A2
M 10	S 50	114,00 A2
M 12	S 50	159,00 A2
M 16	S 25	260,00 A2
M 20	S 10	415,00 A2
M 24	S 1	640,00 A2
M 27	S 1	950,00 A2
M 30	S 1	1330,00 A2
M 36	S 1	2700,00 A2

DIN	00936.940	
936 A 4		

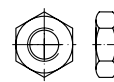

Sechskantmuttern, niedrige Form

Maße → [TI-63](#) Normumstellung → [TI-7](#)
 Werkstoffeigensch. → [TI-236](#)

Stahl → [S. 174](#)
 Messing → [S. 627](#)

Muttern nach ISO → ISO 4035 (DIN 439)

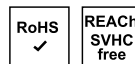

M 8	S 100	83,00 A4
M 10	S 50	158,00 A4
M 12	S 50	227,00 A4
M 14	S 25	440,00 A4
M 16	S 25	365,00 A4
M 20	S 10	610,00 A4
M 22	S 10	880,00 A4
M 24	S 1	920,00 A4
M 30	S 1	1850,00 A4
M 36	S 1	4400,00 A4

Abmessungen	VE Stück	€/100/obf.
DIN 00936.925		
936	A 2	Fein

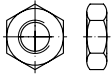

Sechskantmuttern, niedrige Form, mit metrischem Feingewinde

Maße → **TI-63** Normumstellung → **TI-7**
 Werkstoffeigensch. → **TI-236**
 Stahl → **S. 175**
 Messing → **S. 627**

Muttern nach ISO → ISO 8675 (DIN 439)

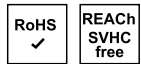

M 8	x	1	S	100	88,00A2
M 10	x	1	S	50	161,00A2
M 12	x	1,5	S	50	211,00A2
M 14	x	1,5	S	25	315,00A2
M 16	x	1,5	S	25	335,00A2
M 18	x	1,5	S	10	460,00A2
M 20	x	1,5	S	10	560,00A2
M 22	x	1,5	S	10	740,00A2
M 24	x	1,5	S	1	840,00A2
M 27	x	1,5	S	1	1540,00A2
M 30	x	1,5	S	1	1590,00A2
M 36	x	1,5	S	1	3600,00A2

Abmessungen	VE Stück	€/100/obf.
DIN 00936.945		
936	A 4	Fein

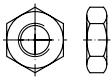

Sechskantmuttern, niedrige Form, mit metrischem Feingewinde

Maße → **TI-63** Normumstellung → **TI-7**
 Werkstoffeigensch. → **TI-236**
 Stahl → **S. 175**
 Messing → **S. 627**

Muttern nach ISO → ISO 8675 (DIN 439)

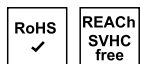

M 10	x	1	S	50	227,00A4
M 12	x	1,5	S	50	350,00A4
M 14	x	1,5	S	25	520,00A4
M 16	x	1,5	S	25	530,00A4
M 18	x	1,5	S	10	920,00A4
M 20	x	1,5	S	10	980,00A4
M 24	x	1,5	S	1	1280,00A4
M 30	x	1,5	S	1	2350,00A4
M 36	x	1,5	S	1	4800,00A4

Abmessungen	VE Stück	€/100/obf.
DIN 00938.920		
938	A 2	

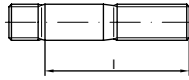

Stiftschrauben, Einschraubende ≈ 1 d

Maße → **TI-18** Anziehmomente → **TI-249**
 Werkstoffeigensch. → **TI-236**
 Stahl → **S. 177**



M 6	x	16	S	25	131,00A2
M 6	x	20	S	25	133,00A2
M 6	x	25	S	25	139,00A2
M 6	x	30	S	25	142,00A2
M 6	x	35	S	25	146,00A2
M 6	x	40	S	25	150,00A2
M 8	x	16	S	25	159,00A2
M 8	x	20	S	25	165,00A2
M 8	x	25	S	25	171,00A2
M 8	x	30	S	25	176,00A2
M 8	x	35	S	25	182,00A2
M 8	x	40	S	25	184,00A2
M 8	x	45	S	25	192,00A2
M 8	x	50	S	25	197,00A2
M 8	x	55	S	25	201,00A2
M 8	x	60	S	25	248,00A2
M 10	x	20	S	25	207,00A2
M 10	x	25	S	25	214,00A2
M 10	x	30	S	25	224,00A2
M 10	x	35	S	25	233,00A2
M 10	x	40	S	25	239,00A2
M 10	x	45	S	25	248,00A2
M 10	x	50	S	25	260,00A2
M 10	x	55	S	25	265,00A2
M 10	x	60	S	25	275,00A2
M 10	x	65	S	25	285,00A2
M 10	x	70	S	25	300,00A2
M 12	x	25	S	25	265,00A2
M 12	x	30	S	25	270,00A2
M 12	x	35	S	25	285,00A2
M 12	x	40	S	25	295,00A2
M 12	x	45	S	25	305,00A2
M 12	x	50	S	25	320,00A2
M 12	x	55	S	10	340,00A2
M 12	x	60	S	10	355,00A2
M 12	x	65	S	10	395,00A2
M 12	x	70	S	10	420,00A2
M 12	x	75	S	10	435,00A2
M 12	x	80	S	10	445,00A2
M 12	x	90	S	10	530,00A2
M 12	x	100	S	10	600,00A2
M 16	x	30	S	10	475,00A2
M 16	x	35	S	10	510,00A2
M 16	x	40	S	10	530,00A2
M 16	x	45	S	10	550,00A2
M 16	x	50	S	10	570,00A2
M 16	x	55	S	10	610,00A2
M 16	x	60	S	10	710,00A2
M 16	x	65	S	10	720,00A2
M 16	x	70	S	10	740,00A2
M 16	x	75	S	10	780,00A2
M 16	x	80	S	10	810,00A2
M 16	x	90	S	10	840,00A2
M 16	x	100	S	1	860,00A2

Abmessungen	VE Stück	€/100/obf.			
M 20	x	35	S	1	760,00A2
M 20	x	40	S	1	820,00A2
M 20	x	45	S	1	850,00A2
M 20	x	50	S	1	990,00A2
M 20	x	55	S	1	1010,00A2
M 20	x	60	S	1	1030,00A2
M 20	x	65	S	1	1050,00A2
M 20	x	70	S	1	1060,00A2
M 20	x	75	S	1	1120,00A2
M 20	x	80	S	1	1160,00A2
M 20	x	90	S	1	1270,00A2
M 20	x	100	S	1	1390,00A2
M 24	x	50	S	1	1290,00A2
M 24	x	55	S	1	1350,00A2
M 24	x	60	S	1	1410,00A2
M 24	x	65	S	1	1460,00A2
M 24	x	70	S	1	1520,00A2

Abmessungen	VE Stück	€/100/obf.
DIN 00938.940		
938	A 4	

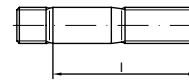

Stiftschrauben, Einschraubende ≈ 1 d

Maße → **TI-18** Anziehmomente → **TI-249**
 Werkstoffeigensch. → **TI-236**
 Stahl → **S. 177**

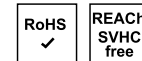

M 6	x	20	S	25	193,00A4
M 6	x	25	S	25	200,00A4
M 6	x	30	S	25	208,00A4
M 6	x	35	S	25	214,00A4
M 6	x	40	S	25	219,00A4
M 6	x	45	S	25	225,00A4
M 8	x	16	S	25	206,00A4
M 8	x	20	S	25	210,00A4
M 8	x	25	S	25	214,00A4
M 8	x	30	S	25	221,00A4
M 8	x	35	S	25	225,00A4
M 8	x	40	S	25	260,00A4
M 8	x	45	S	25	275,00A4
M 8	x	50	S	25	275,00A4
M 8	x	55	S	25	290,00A4
M 8	x	60	S	25	290,00A4
M 8	x	65	S	25	305,00A4
M 8	x	70	S	25	320,00A4
M 8	x	75	S	25	330,00A4
M 8	x	80	S	25	340,00A4
M 8	x	90	S	25	355,00A4
M 10	x	20	S	25	290,00A4
M 10	x	25	S	25	290,00A4
M 10	x	30	S	25	305,00A4
M 10	x	35	S	25	340,00A4
M 10	x	40	S	25	350,00A4
M 10	x	45	S	25	365,00A4
M 10	x	50	S	25	375,00A4
M 10	x	55	S	25	395,00A4
M 10	x	60	S	25	415,00A4
M 10	x	65	S	25	450,00A4
M 10	x	70	S	25	465,00A4
M 10	x	75	S	25	470,00A4
M 10	x	80	S	25	485,00A4
M 12	x	20	S	25	380,00A4
M 12	x	25	S	25	380,00A4

Abmessungen	VE	Stück	€/100/Obf.
M 12 x 30	S	25	400,00 A4
M 12 x 35	S	25	420,00 A4
M 12 x 40	S	25	445,00 A4
M 12 x 45	S	25	465,00 A4
M 12 x 50	S	25	485,00 A4
M 12 x 55	S	10	510,00 A4
M 12 x 60	S	10	530,00 A4
M 12 x 65	S	10	560,00 A4
M 12 x 70	S	10	600,00 A4
M 12 x 75	S	10	610,00 A4
M 12 x 80	S	10	630,00 A4
M 12 x 85	S	10	670,00 A4
M 12 x 90	S	10	680,00 A4
M 12 x 95	S	10	720,00 A4
M 12 x 100	S	10	750,00 A4
M 16 x 30	S	10	680,00 A4
M 16 x 35	S	10	720,00 A4
M 16 x 40	S	10	770,00 A4
M 16 x 45	S	10	790,00 A4
M 16 x 50	S	10	830,00 A4
M 16 x 55	S	10	870,00 A4
M 16 x 60	S	10	930,00 A4
M 16 x 65	S	1	980,00 A4
M 16 x 70	S	1	1020,00 A4
M 16 x 75	S	1	1040,00 A4
M 16 x 80	S	1	1100,00 A4
M 16 x 85	S	1	1280,00 A4
M 16 x 90	S	1	1330,00 A4
M 16 x 95	S	1	1350,00 A4
M 16 x 100	S	1	1430,00 A4
M 20 x 40	S	1	1240,00 A4
M 20 x 45	S	1	1280,00 A4
M 20 x 50	S	1	1330,00 A4
M 20 x 55	S	1	1410,00 A4
M 20 x 60	S	1	1470,00 A4
M 20 x 65	S	1	1560,00 A4
M 20 x 70	S	1	1640,00 A4
M 20 x 75	S	1	1730,00 A4
M 20 x 80	S	1	1830,00 A4
M 20 x 85	S	1	1910,00 A4
M 20 x 90	S	1	2000,00 A4
M 20 x 95	S	1	2100,00 A4
M 20 x 100	S	1	2210,00 A4
M 24 x 45	S	1	1680,00 A4
M 24 x 50	S	1	1770,00 A4
M 24 x 55	S	1	1850,00 A4
M 24 x 60	S	1	1960,00 A4
M 24 x 65	S	1	2040,00 A4
M 24 x 70	S	1	2120,00 A4
M 24 x 75	S	1	2250,00 A4
M 24 x 80	S	1	2350,00 A4
M 24 x 85	S	1	2480,00 A4
M 24 x 90	S	1	2650,00 A4
M 24 x 95	S	1	2750,00 A4
M 24 x 100	S	1	2850,00 A4

Abmessungen	VE	Stück	€/100/Obf.
DIN	00939.920		
939	A 2		

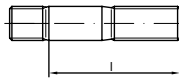

Stiftschrauben, Einschraubende ≈ 1,25 d

Maße → **TI-18** Anziehmomente → **TI-249**
 Werkstoffeigensch. → **TI-236**
 Stahl → **S. 179**

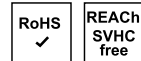

M 6 x 16	S	25	135,00 A2
M 6 x 20	S	25	137,00 A2
M 6 x 25	S	25	142,00 A2
M 6 x 30	S	25	146,00 A2
M 6 x 35	S	25	150,00 A2
M 6 x 40	S	25	154,00 A2
M 8 x 16	S	25	163,00 A2
M 8 x 20	S	25	169,00 A2
M 8 x 25	S	25	175,00 A2
M 8 x 30	S	25	180,00 A2
M 8 x 35	S	25	188,00 A2
M 8 x 40	S	25	190,00 A2
M 8 x 45	S	25	195,00 A2
M 8 x 50	S	25	201,00 A2
M 8 x 55	S	25	207,00 A2
M 8 x 60	S	25	260,00 A2
M 10 x 20	S	25	212,00 A2
M 10 x 25	S	25	220,00 A2
M 10 x 30	S	25	229,00 A2
M 10 x 35	S	25	239,00 A2
M 10 x 40	S	25	245,00 A2
M 10 x 45	S	25	260,00 A2
M 10 x 50	S	25	265,00 A2
M 10 x 55	S	25	275,00 A2
M 10 x 60	S	25	285,00 A2
M 10 x 70	S	25	310,00 A2
M 12 x 25	S	25	275,00 A2
M 12 x 30	S	25	280,00 A2
M 12 x 35	S	25	290,00 A2
M 12 x 40	S	25	300,00 A2
M 12 x 45	S	25	315,00 A2
M 12 x 50	S	25	330,00 A2
M 12 x 55	S	10	350,00 A2
M 12 x 60	S	10	365,00 A2
M 12 x 65	S	10	395,00 A2
M 12 x 70	S	10	420,00 A2
M 12 x 75	S	10	435,00 A2
M 12 x 80	S	10	445,00 A2
M 12 x 90	S	10	530,00 A2
M 12 x 100	S	10	600,00 A2
M 16 x 30	S	10	475,00 A2
M 16 x 35	S	10	510,00 A2
M 16 x 40	S	10	530,00 A2
M 16 x 45	S	10	550,00 A2
M 16 x 50	S	10	570,00 A2
M 16 x 55	S	10	610,00 A2
M 16 x 60	S	10	710,00 A2
M 16 x 65	S	10	720,00 A2
M 16 x 70	S	10	740,00 A2
M 16 x 75	S	10	780,00 A2
M 16 x 80	S	10	810,00 A2
M 16 x 90	S	10	840,00 A2
M 16 x 100	S	1	860,00 A2
M 20 x 45	S	1	850,00 A2

Abmessungen	VE	Stück	€/100/Obf.
M 20 x 50	S	1	990,00 A2
M 20 x 55	S	1	1010,00 A2
M 20 x 60	S	1	1030,00 A2
M 20 x 65	S	1	1050,00 A2
M 20 x 70	S	1	1060,00 A2
M 20 x 75	S	1	1120,00 A2
M 20 x 80	S	1	1160,00 A2
M 20 x 90	S	1	1270,00 A2
M 20 x 100	S	1	1390,00 A2

Abmessungen	VE	Stück	€/100/Obf.
DIN	00939.940		
939	A 4		

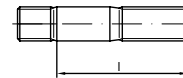

Stiftschrauben, Einschraubende ≈ 1,25 d

Maße → **TI-18** Anziehmomente → **TI-249**
 Werkstoffeigensch. → **TI-236**
 Stahl → **S. 179**

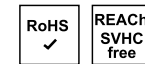

M 6 x 20	S	25	193,00 A4
M 6 x 25	S	25	200,00 A4
M 6 x 30	S	25	208,00 A4
M 6 x 35	S	25	214,00 A4
M 6 x 40	S	25	219,00 A4
M 6 x 45	S	25	225,00 A4
M 6 x 50	S	25	233,00 A4
M 8 x 20	S	25	210,00 A4
M 8 x 25	S	25	214,00 A4
M 8 x 30	S	25	221,00 A4
M 8 x 35	S	25	250,00 A4
M 8 x 40	S	25	260,00 A4
M 8 x 45	S	25	275,00 A4
M 8 x 50	S	25	275,00 A4
M 8 x 55	S	25	290,00 A4
M 8 x 60	S	25	290,00 A4
M 8 x 65	S	25	305,00 A4
M 8 x 70	S	25	320,00 A4
M 8 x 75	S	25	330,00 A4
M 8 x 80	S	25	340,00 A4
M 10 x 20	S	25	290,00 A4
M 10 x 25	S	25	290,00 A4
M 10 x 30	S	25	305,00 A4
M 10 x 35	S	25	340,00 A4
M 10 x 40	S	25	350,00 A4
M 10 x 45	S	25	365,00 A4
M 10 x 50	S	25	375,00 A4
M 10 x 55	S	25	395,00 A4
M 10 x 60	S	25	415,00 A4
M 10 x 65	S	25	450,00 A4
M 10 x 70	S	25	465,00 A4
M 10 x 75	S	25	470,00 A4
M 10 x 80	S	25	485,00 A4
M 12 x 25	S	25	380,00 A4
M 12 x 30	S	25	400,00 A4
M 12 x 35	S	25	420,00 A4
M 12 x 40	S	25	445,00 A4
M 12 x 45	S	25	465,00 A4
M 12 x 50	S	25	485,00 A4
M 12 x 55	S	10	510,00 A4
M 12 x 60	S	10	530,00 A4
M 12 x 65	S	10	560,00 A4
M 12 x 70	S	10	600,00 A4
M 12 x 75	S	10	610,00 A4

Abmessungen	VE	Stück	€/100/Obf.	Abmessungen	VE	Stück	€/100/Obf.	Abmessungen	VE	Stück	€/100/Obf.
M 12 x 80	S	10	630,00A4	M 1,2 x 4	S	1000	285,00A2	M 4 x 14	S	1000	36,50A2
M 12 x 85	S	10	670,00A4	M 1,2 x 5	S	1000	305,00A2	M 4 x 16	S	1000	6,90A2
M 12 x 90	S	10	680,00A4	M 1,2 x 6	S	1000	335,00A2	M 4 x 16	K	200	8,80A2
M 12 x 95	S	10	720,00A4	M 1,4 x 2	S	1000	285,00A2	M 4 x 18	S	1000	39,50A2
M 12 x 100	S	10	750,00A4	M 1,4 x 3	S	1000	285,00A2	M 4 x 20	S	1000	7,80A2
M 16 x 30	S	10	680,00A4	M 1,4 x 4	S	1000	285,00A2	M 4 x 20	K	200	9,70A2
M 16 x 35	S	10	720,00A4	M 1,4 x 5	S	1000	305,00A2	M 4 x 22	K	200	15,30A2
M 16 x 40	S	10	770,00A4	M 1,4 x 6	S	1000	335,00A2	M 4 x 25	S	500	8,80A2
M 16 x 45	S	10	790,00A4	M 1,4 x 8	S	1000	370,00A2	M 4 x 25	K	200	10,60A2
M 16 x 50	S	10	830,00A4	M 1,4 x 10	S	1000	430,00A2	M 4 x 30	S	500	11,80A2
M 16 x 55	S	10	870,00A4	M 1,6 x 3	S	1000	105,00A2	M 4 x 30	K	200	13,70A2
M 16 x 60	S	10	930,00A4	M 1,6 x 4	S	1000	105,00A2	M 4 x 35	S	500	16,00A2
M 16 x 65	S	1	980,00A4	M 1,6 x 5	S	1000	124,00A2	M 4 x 35	K	200	17,90A2
M 16 x 70	S	1	1020,00A4	M 1,6 x 6	S	1000	133,00A2	M 4 x 40	K	100	24,00A2
M 16 x 75	S	1	1040,00A4	M 1,6 x 8	S	1000	142,00A2	M 4 x 50	K	100	37,00A2
M 16 x 80	S	1	1100,00A4	M 1,6 x 10	S	1000	152,00A2	M 5 x 6	S	500	12,90A2
M 16 x 85	S	1	1280,00A4	M 2 x 3	S	1000	124,00A2	M 5 x 6	K	200	14,80A2
M 16 x 90	S	1	1330,00A4	M 2 x 4	S	1000	8,80A2	M 5 x 8	S	500	11,30A2
M 16 x 95	S	1	1350,00A4	M 2 x 5	S	1000	6,30A2	M 5 x 8	K	200	13,20A2
M 16 x 100	S	1	1430,00A4	M 2 x 6	S	1000	6,60A2	M 5 x 10	S	500	11,30A2
M 16 x 120	S	1	1470,00A4	M 2 x 8	S	1000	7,00A2	M 5 x 10	K	200	13,20A2
M 16 x 140	S	1	1520,00A4	M 2 x 10	S	1000	7,60A2	M 5 x 12	S	500	8,40A2
M 20 x 40	S	1	1240,00A4	M 2 x 12	S	1000	8,20A2	M 5 x 12	K	200	10,30A2
M 20 x 45	S	1	1280,00A4	M 2 x 16	S	1000	8,80A2	M 5 x 14	K	200	16,40A2
M 20 x 50	S	1	1330,00A4	M 2 x 18	S	1000	11,40A2	M 5 x 16	S	500	9,70A2
M 20 x 55	S	1	1410,00A4	M 2,5 x 4	S	1000	8,80A2	M 5 x 16	K	200	11,60A2
M 20 x 60	S	1	1470,00A4	M 2,5 x 5	S	1000	6,30A2	M 5 x 18	S	500	12,40A2
M 20 x 65	S	1	1560,00A4	M 2,5 x 6	S	1000	6,60A2	M 5 x 20	S	500	11,20A2
M 20 x 70	S	1	1640,00A4	M 2,5 x 8	S	1000	7,00A2	M 5 x 20	K	200	13,10A2
M 20 x 75	S	1	1730,00A4	M 2,5 x 10	S	1000	7,60A2	M 5 x 25	S	500	13,20A2
M 20 x 80	S	1	1830,00A4	M 2,5 x 12	S	1000	8,20A2	M 5 x 25	K	200	15,10A2
M 20 x 85	S	1	1910,00A4	M 2,5 x 14	S	1000	8,80A2	M 5 x 30	S	500	14,90A2
M 20 x 90	S	1	2000,00A4	M 2,5 x 16	S	1000	8,80A2	M 5 x 30	K	200	16,80A2
M 20 x 95	S	1	2100,00A4	M 2,5 x 20	S	1000	24,20A2	M 5 x 35	S	200	18,10A2
M 20 x 100	S	1	2210,00A4	M 2,5 x 25	S	1000	31,00A2	M 5 x 35	K	100	22,00A2
M 24 x 50	S	1	1770,00A4	M 3 x 4	S	1000	48,00A2	M 5 x 40	S	200	23,30A2
M 24 x 55	S	1	1850,00A4	M 3 x 5	S	1000	9,60A2	M 5 x 40	K	100	27,50A2
M 24 x 60	S	1	1960,00A4	M 3 x 5	K	200	11,50A2	M 5 x 45	K	100	33,50A2
M 24 x 65	S	1	2040,00A4	M 3 x 6	S	1000	5,50A2	M 5 x 50	K	100	42,50A2
M 24 x 70	S	1	2120,00A4	M 3 x 6	K	200	7,40A2	M 5 x 60	K	100	64,00A2
M 24 x 75	S	1	2250,00A4	M 3 x 8	S	1000	5,10A2	M 5 x 65	K	100	88,00A2
M 24 x 80	S	1	2350,00A4	M 3 x 8	K	200	7,00A2	M 5 x 70	K	100	88,00A2
M 24 x 85	S	1	2480,00A4	M 3 x 10	S	1000	4,65A2	M 5 x 80	S	500	99,00A2
M 24 x 90	S	1	2650,00A4	M 3 x 10	K	200	6,60A2	M 5 x 90	K	100	125,00A2
M 24 x 95	S	1	2750,00A4	M 3 x 12	S	1000	4,75A2	M 5 x 100	K	100	142,00A2
M 24 x 100	S	1	2850,00A4	M 3 x 12	K	200	6,70A2	M 6 x 8	S	200	20,30A2
				M 3 x 14	K	200	10,90A2	M 6 x 8	K	100	24,20A2
				M 3 x 16	S	1000	5,40A2	M 6 x 10	S	200	13,60A2
				M 3 x 16	K	200	7,30A2	M 6 x 10	K	100	17,50A2
				M 3 x 20	S	1000	6,30A2	M 6 x 12	S	200	13,10A2
				M 3 x 20	K	200	8,20A2	M 6 x 12	K	100	17,00A2
				M 3 x 22	S	1000	21,00A2	M 6 x 16	S	200	12,30A2
				M 3 x 25	S	1000	7,90A2	M 6 x 16	K	100	16,10A2
				M 3 x 25	K	200	9,80A2	M 6 x 18	K	100	26,50A2
				M 3 x 30	S	1000	46,50A2	M 6 x 20	S	200	13,60A2
				M 3 x 30	K	200	15,60A2	M 6 x 20	K	100	17,50A2
				M 3 x 35	S	1000	48,00A2	M 6 x 25	S	200	15,60A2
				M 3 x 40	S	1000	61,00A2	M 6 x 25	K	100	19,40A2
				M 3 x 45	S	1000	55,00A2	M 6 x 30	S	200	18,90A2
				M 3 x 50	S	500	74,00A2	M 6 x 30	K	100	22,80A2
				M 3 x 60	S	500	110,00A2	M 6 x 35	S	100	22,60A2
				M 3,5 x 8	K	200	30,00A2	M 6 x 35	K	50	30,50A2
				M 3,5 x 10	K	200	30,00A2	M 6 x 40	S	100	29,50A2
				M 3,5 x 12	K	200	32,50A2	M 6 x 40	K	50	37,00A2
				M 3,5 x 16	K	200	35,00A2	M 6 x 45	K	100	43,00A2
				M 4 x 5	S	1000	45,50A2	M 6 x 50	K	50	53,00A2
				M 4 x 5	K	200	20,20A2	M 6 x 55	K	50	78,00A2
				M 4 x 6	S	1000	8,50A2	M 6 x 60	K	50	78,00A2
				M 4 x 6	K	200	10,40A2	M 6 x 65	K	50	87,00A2
				M 4 x 8	S	1000	8,20A2	M 6 x 70	K	50	87,00A2
				M 4 x 8	K	200	10,10A2	M 6 x 80	K	50	95,00A2
				M 4 x 10	S	1000	7,10A2	M 6 x 90	K	50	125,00A2
				M 4 x 10	K	200	9,00A2	M 6 x 100	K	50	190,00A2
				M 4 x 12	S	1000	6,60A2	M 6 x 110	K	50	345,00A2
				M 4 x 12	K	200	8,50A2	M 6 x 120	K	25	380,00A2

DIN 00963.920
963 A 2



Senkschrauben mit Schlitz

Maße → TI-27 Normumstellung → TI-11
 Werkstoffeigensch. → TI-236

Stahl → S. 187
 Messing, Kunststoff → S. 627

DIN 963 → wird ersetzt durch ISO 2009

RoHS REACH SVHC free

M 1 x 2	S	1000	285,00A2
M 1 x 3	S	1000	285,00A2
M 1 x 4	S	1000	285,00A2
M 1 x 5	S	1000	285,00A2
M 1,2 x 2	S	1000	285,00A2
M 1,2 x 3	S	1000	285,00A2

Abmessungen	VE	Stück	€/100/Obf.	Abmessungen	VE	Stück	€/100/Obf.	Abmessungen	VE	Stück	€/100/Obf.
M 6 x 130	K	25	485,00A2	M 2 x 5	S	1000	7,00A4	M 4 x 40	K	100	27,50A4
M 6 x 140	K	25	570,00A2	M 2 x 5	K	200	9,10A4	M 4 x 45	K	100	46,00A4
M 6 x 160	K	25	670,00A2	M 2 x 6	S	1000	7,30A4	M 4 x 50	K	100	46,00A4
M 8 x 12	S	100	30,50A2	M 2 x 6	K	200	9,40A4	M 4 x 60	K	100	70,00A4
M 8 x 16	S	100	31,50A2	M 2 x 8	S	1000	7,70A4	M 5 x 6	S	500	53,00A4
M 8 x 16	K	50	39,00A2	M 2 x 8	K	200	9,80A4	M 5 x 8	S	500	15,00A4
M 8 x 18	S	200	80,00A2	M 2 x 10	S	1000	8,40A4	M 5 x 8	K	200	17,10A4
M 8 x 20	S	100	32,50A2	M 2 x 10	K	200	10,50A4	M 5 x 10	S	500	15,00A4
M 8 x 20	K	50	40,00A2	M 2 x 12	S	1000	9,10A4	M 5 x 10	K	200	17,10A4
M 8 x 25	S	100	39,00A2	M 2 x 12	K	200	11,20A4	M 5 x 12	S	500	11,70A4
M 8 x 25	K	50	46,50A2	M 2 x 16	S	1000	9,70A4	M 5 x 12	K	200	13,80A4
M 8 x 30	S	100	41,50A2	M 2 x 16	K	200	11,80A4	M 5 x 16	S	500	13,60A4
M 8 x 30	K	50	49,00A2	M 2 x 20	S	1000	12,80A4	M 5 x 16	K	200	15,70A4
M 8 x 35	S	100	46,00A2	M 2 x 20	K	200	14,90A4	M 5 x 18	K	200	25,50A4
M 8 x 35	K	50	54,00A2	M 2,5 x 4	S	1000	9,70A4	M 5 x 20	S	500	15,90A4
M 8 x 40	S	100	51,00A2	M 2,5 x 4	K	200	11,80A4	M 5 x 20	K	200	18,00A4
M 8 x 40	K	50	59,00A2	M 2,5 x 5	S	1000	7,00A4	M 5 x 25	S	500	18,30A4
M 8 x 45	K	50	70,00A2	M 2,5 x 5	K	200	9,10A4	M 5 x 25	K	200	20,40A4
M 8 x 50	S	100	67,00A2	M 2,5 x 6	S	1000	7,30A4	M 5 x 30	S	500	20,90A4
M 8 x 50	K	50	75,00A2	M 2,5 x 6	K	200	9,40A4	M 5 x 30	K	200	23,00A4
M 8 x 55	K	50	105,00A2	M 2,5 x 8	S	1000	7,70A4	M 5 x 35	S	200	29,00A4
M 8 x 60	K	50	105,00A2	M 2,5 x 8	K	200	9,80A4	M 5 x 35	K	100	33,50A4
M 8 x 70	K	50	113,00A2	M 2,5 x 10	S	1000	8,40A4	M 5 x 40	S	200	32,50A4
M 8 x 80	K	50	124,00A2	M 2,5 x 10	K	200	10,50A4	M 5 x 40	K	100	36,50A4
M 8 x 90	K	50	137,00A2	M 2,5 x 12	S	1000	9,10A4	M 5 x 45	K	100	44,50A4
M 8 x 100	K	50	218,00A2	M 2,5 x 12	K	200	11,20A4	M 5 x 50	K	100	48,50A4
M 8 x 110	K	50	380,00A2	M 2,5 x 16	S	1000	9,70A4	M 5 x 60	K	100	66,00A4
M 10 x 16	K	50	124,00A2	M 2,5 x 16	K	200	11,80A4	M 5 x 70	K	100	104,00A4
M 10 x 20	S	100	63,00A2	M 2,5 x 20	K	200	14,90A4	M 5 x 80	K	100	115,00A4
M 10 x 20	K	50	71,00A2	M 2,5 x 25	S	1000	42,00A4	M 5 x 90	K	100	152,00A4
M 10 x 25	S	100	72,00A2	M 3 x 4	S	1000	16,10A4	M 5 x 100	K	100	154,00A4
M 10 x 25	K	50	79,00A2	M 3 x 4	K	200	18,20A4	M 6 x 8	S	200	59,00A4
M 10 x 30	S	100	80,00A2	M 3 x 5	S	1000	13,90A4	M 6 x 8	K	100	33,50A4
M 10 x 30	K	50	88,00A2	M 3 x 5	K	200	16,00A4	M 6 x 10	S	200	21,40A4
M 10 x 35	S	100	89,00A2	M 3 x 6	S	1000	8,30A4	M 6 x 10	K	100	26,00A4
M 10 x 35	K	50	96,00A2	M 3 x 6	K	200	10,40A4	M 6 x 12	S	200	20,70A4
M 10 x 40	S	100	97,00A2	M 3 x 8	S	1000	7,10A4	M 6 x 12	K	100	25,00A4
M 10 x 40	K	50	105,00A2	M 3 x 8	K	200	9,20A4	M 6 x 14	S	200	25,50A4
M 10 x 50	S	100	114,00A2	M 3 x 10	S	1000	6,00A4	M 6 x 16	S	200	19,90A4
M 10 x 50	K	50	121,00A2	M 3 x 10	K	200	8,10A4	M 6 x 16	K	100	24,20A4
M 10 x 60	S	100	148,00A2	M 3 x 12	S	1000	6,30A4	M 6 x 18	K	100	34,50A4
M 10 x 60	K	50	155,00A2	M 3 x 12	K	200	8,40A4	M 6 x 20	S	200	22,90A4
M 10 x 70	S	50	190,00A2	M 3 x 16	S	1000	7,30A4	M 6 x 20	K	100	27,50A4
M 10 x 80	S	50	219,00A2	M 3 x 16	K	200	9,40A4	M 6 x 25	S	200	27,00A4
M 10 x 90	K	50	237,00A2	M 3 x 20	S	1000	8,00A4	M 6 x 25	K	100	31,00A4
M 10 x 100	K	50	335,00A2	M 3 x 20	K	200	10,10A4	M 6 x 30	S	200	31,00A4
M 10 x 120	K	25	760,00A2	M 3 x 25	S	1000	11,60A4	M 6 x 30	K	100	35,50A4
M 10 x 130	K	25	800,00A2	M 3 x 25	K	200	13,70A4	M 6 x 35	S	100	39,50A4
M 10 x 140	K	25	800,00A2	M 3 x 30	S	1000	13,00A4	M 6 x 35	K	50	48,00A4
				M 3 x 30	K	200	15,00A4	M 6 x 40	S	100	48,50A4
				M 3 x 35	S	1000	63,00A4	M 6 x 40	K	50	57,00A4
				M 3 x 40	S	1000	80,00A4	M 6 x 45	S	100	54,00A4
				M 3 x 40	K	200	33,50A4	M 6 x 45	K	50	62,00A4
				M 3 x 45	S	1000	99,00A4	M 6 x 50	S	100	57,00A4
				M 3 x 50	S	1000	124,00A4	M 6 x 50	K	50	65,00A4
				M 4 x 5	K	200	27,00A4	M 6 x 55	K	100	80,00A4
				M 4 x 6	S	1000	12,20A4	M 6 x 60	S	100	71,00A4
				M 4 x 6	K	200	14,30A4	M 6 x 60	K	50	80,00A4
				M 4 x 8	S	1000	11,60A4	M 6 x 65	K	50	126,00A4
				M 4 x 8	K	200	13,70A4	M 6 x 70	K	50	127,00A4
				M 4 x 10	S	1000	9,80A4	M 6 x 80	K	50	150,00A4
				M 4 x 10	K	200	11,90A4	M 6 x 90	K	50	187,00A4
				M 4 x 12	S	1000	9,40A4	M 6 x 100	K	50	450,00A4
				M 4 x 12	K	200	11,50A4	M 6 x 110	K	50	580,00A4
				M 4 x 16	S	1000	9,90A4	M 6 x 120	K	50	600,00A4
				M 4 x 16	K	200	12,00A4	M 8 x 10	K	50	85,00A4
				M 4 x 18	S	200	16,80A4	M 8 x 12	S	100	84,00A4
				M 4 x 20	S	1000	10,90A4	M 8 x 12	K	50	59,00A4
				M 4 x 20	K	200	13,00A4	M 8 x 16	S	100	48,50A4
				M 4 x 25	S	500	13,50A4	M 8 x 16	K	50	57,00A4
				M 4 x 25	K	200	15,60A4	M 8 x 20	S	100	50,00A4
				M 4 x 30	S	500	17,80A4	M 8 x 20	K	50	59,00A4
				M 4 x 30	K	200	19,90A4	M 8 x 25	S	100	57,00A4
				M 4 x 35	S	500	21,40A4	M 8 x 25	K	50	65,00A4
				M 4 x 35	K	200	23,50A4	M 8 x 30	S	100	62,00A4
M 2 x 3	S	1000	179,00A4								
M 2 x 4	S	1000	9,70A4								
M 2 x 4	K	200	11,80A4								

DIN 00963.940
963 A 4

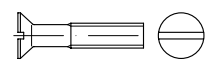

Senkschrauben mit Schlitz

Maße → **TI-27** Normumstellung → **TI-11**
 Werkstoffeigensch. → **TI-236**
 Stahl → **S. 187**
 Messing, Kunststoff → **S. 627**
 DIN 963 → wird ersetzt durch ISO 2009

RoHS REACH SVHC free

Abmessungen	VE	Stück	€/100/Obf.
M 8 x 30	K	50	71,00A4
M 8 x 35	S	100	70,00A4
M 8 x 40	S	100	78,00A4
M 8 x 40	K	50	87,00A4
M 8 x 45	S	100	93,00A4
M 8 x 45	K	50	102,00A4
M 8 x 50	S	100	104,00A4
M 8 x 50	K	50	112,00A4
M 8 x 55	K	50	133,00A4
M 8 x 60	K	50	133,00A4
M 8 x 70	K	50	209,00A4
M 8 x 80	K	50	255,00A4
M 8 x 90	K	50	315,00A4
M 8 x 100	K	50	335,00A4
M 10 x 16	K	50	174,00A4
M 10 x 20	S	100	97,00A4
M 10 x 20	K	50	106,00A4
M 10 x 25	S	100	111,00A4
M 10 x 25	K	50	119,00A4
M 10 x 30	S	100	124,00A4
M 10 x 30	K	50	132,00A4
M 10 x 35	S	100	137,00A4
M 10 x 35	K	50	145,00A4
M 10 x 40	S	100	150,00A4
M 10 x 40	K	50	159,00A4
M 10 x 45	S	100	163,00A4
M 10 x 45	K	50	172,00A4
M 10 x 50	S	100	176,00A4
M 10 x 50	K	50	185,00A4
M 10 x 60	S	100	227,00A4
M 10 x 60	K	50	238,00A4
M 10 x 70	S	50	350,00A4
M 10 x 70	K	25	370,00A4
M 10 x 80	S	50	420,00A4
M 10 x 90	K	25	520,00A4
M 10 x 100	K	25	620,00A4
M 10 x 110	K	25	830,00A4
M 10 x 120	K	25	920,00A4
M 10 x 130	K	25	1050,00A4
M 10 x 140	K	25	1210,00A4
M 12 x 16	K	25	244,00A4
M 12 x 20	K	25	450,00A4
M 12 x 25	K	25	450,00A4
M 12 x 30	K	25	480,00A4
M 12 x 35	K	25	510,00A4
M 12 x 40	K	25	530,00A4
M 12 x 45	K	25	590,00A4
M 12 x 50	K	25	590,00A4
M 12 x 60	K	25	680,00A4
M 12 x 70	K	25	920,00A4
M 12 x 80	K	25	1070,00A4
M 12 x 90	K	25	1450,00A4
M 12 x 100	K	25	1970,00A4
M 16 x 25	K	1	1590,00A4
M 16 x 30	K	1	1630,00A4
M 16 x 35	K	1	1670,00A4
M 16 x 40	K	1	1730,00A4
M 16 x 45	K	1	1820,00A4
M 16 x 50	K	1	1820,00A4
M 16 x 60	K	1	1910,00A4
M 16 x 70	K	25	2310,00A4

Abmessungen	VE	Stück	€/100/Obf.
DIN	00964.920		
964	A 2		



Linsensenschrauben mit Schlitz

Maße → TI-39 Normumstellung → TI-11
 Werkstoffeigensch. → TI-236
 Stahl → S. 189
 Messing → S. 628

DIN 964 → wird ersetzt durch ISO 2010

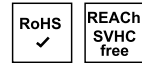

M 3 x 5	K	200	9,70A2
M 3 x 6	S	1000	6,30A2
M 3 x 6	K	200	8,20A2
M 3 x 8	S	1000	5,70A2
M 3 x 8	K	200	7,60A2
M 3 x 10	S	1000	5,20A2
M 3 x 10	K	200	7,10A2
M 3 x 12	S	1000	5,30A2
M 3 x 12	K	200	7,10A2
M 3 x 16	K	200	7,80A2
M 3 x 20	S	1000	7,10A2
M 3 x 20	K	200	8,90A2
M 3 x 25	K	200	10,80A2
M 4 x 6	S	1000	13,50A2
M 4 x 6	K	200	15,40A2
M 4 x 8	S	1000	9,10A2
M 4 x 8	K	200	11,00A2
M 4 x 10	S	1000	7,80A2
M 4 x 10	K	200	9,70A2
M 4 x 12	S	1000	7,30A2
M 4 x 12	K	200	9,20A2
M 4 x 16	S	1000	8,00A2
M 4 x 16	K	200	9,90A2
M 4 x 20	S	1000	8,20A2
M 4 x 20	K	200	10,10A2
M 4 x 25	K	200	11,70A2
M 4 x 30	K	200	14,50A2
M 4 x 35	K	100	23,20A2
M 5 x 8	K	100	20,10A2
M 5 x 10	S	500	12,50A2
M 5 x 10	K	200	14,40A2
M 5 x 12	S	500	9,50A2
M 5 x 12	K	200	11,40A2
M 5 x 16	S	500	10,90A2
M 5 x 16	K	200	12,80A2
M 5 x 18	K	200	19,80A2
M 5 x 20	S	500	12,20A2
M 5 x 20	K	200	14,00A2
M 5 x 25	S	500	14,30A2
M 5 x 25	K	200	16,20A2
M 5 x 30	S	500	16,90A2
M 5 x 30	K	200	18,80A2
M 5 x 35	S	200	20,70A2
M 5 x 35	K	100	24,60A2
M 5 x 40	K	100	31,00A2
M 5 x 45	K	100	34,50A2
M 5 x 50	K	100	43,50A2
M 5 x 60	K	100	64,00A2
M 5 x 70	K	100	92,00A2
M 5 x 80	K	100	102,00A2
M 6 x 10	S	200	15,60A2
M 6 x 10	K	100	19,40A2
M 6 x 12	S	200	15,00A2

Abmessungen	VE	Stück	€/100/Obf.
M 6 x 12	K	100	18,90A2
M 6 x 16	S	200	13,60A2
M 6 x 16	K	100	17,50A2
M 6 x 20	S	200	15,60A2
M 6 x 20	K	100	19,40A2
M 6 x 25	S	200	18,10A2
M 6 x 25	K	100	22,00A2
M 6 x 30	S	200	20,10A2
M 6 x 30	K	100	24,00A2
M 6 x 35	S	100	26,00A2
M 6 x 35	K	50	34,00A2
M 6 x 40	S	100	33,50A2
M 6 x 40	K	50	41,50A2
M 6 x 45	K	50	44,00A2
M 6 x 50	K	50	59,00A2
M 6 x 55	S	100	77,00A2
M 6 x 60	K	50	77,00A2
M 6 x 70	K	50	114,00A2
M 6 x 80	S	50	355,00A2
M 6 x 90	S	50	465,00A2
M 6 x 100	S	50	590,00A2
M 6 x 105	S	50	670,00A2
M 6 x 110	S	50	670,00A2
M 8 x 12	K	50	72,00A2
M 8 x 16	S	100	36,00A2
M 8 x 16	K	50	43,50A2
M 8 x 20	S	100	37,50A2
M 8 x 20	K	50	45,50A2
M 8 x 25	S	100	44,00A2
M 8 x 25	K	50	52,00A2
M 8 x 30	S	100	47,50A2
M 8 x 30	K	50	55,00A2
M 8 x 35	S	100	53,00A2
M 8 x 40	S	100	58,00A2
M 8 x 40	K	50	66,00A2
M 8 x 45	S	100	70,00A2
M 8 x 50	S	100	73,00A2
M 8 x 55	S	100	105,00A2
M 8 x 60	S	100	102,00A2
M 8 x 70	S	100	156,00A2
M 8 x 80	K	50	192,00A2
M 10 x 20	S	100	84,00A2
M 10 x 25	S	100	90,00A2
M 10 x 25	K	50	98,00A2
M 10 x 30	K	50	106,00A2
M 10 x 35	S	100	105,00A2
M 10 x 40	K	50	127,00A2

Abmessungen	VE	Stück	€/100/Obf.
DIN	00964.940		
964	A 4		



Linsensenschrauben mit Schlitz

Maße → TI-39 Normumstellung → TI-11
 Werkstoffeigensch. → TI-236
 Stahl → S. 189
 Messing → S. 628

DIN 964 → wird ersetzt durch ISO 2010

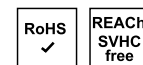

M 2 x 4	K	200	19,60A4
M 2 x 5	K	200	10,70A4
M 2 x 6	K	200	11,20A4
M 2 x 8	K	200	11,80A4
M 2 x 10	K	200	12,70A4

Abmessungen	VE	Stück	€/100/Obf.
M 2 x 12	K	200	13,50A4
M 2 x 20	K	200	46,50A4
M 2,5 x 6	K	200	11,20A4
M 2,5 x 8	K	200	11,80A4
M 2,5 x 10	K	200	12,70A4
M 2,5 x 16	K	200	18,60A4
M 2,5 x 20	K	200	24,20A4
M 3 x 6	S	1000	9,10A4
M 3 x 6	K	200	11,20A4
M 3 x 8	K	200	9,90A4
M 3 x 10	K	200	8,90A4
M 3 x 12	K	200	9,30A4
M 3 x 16	K	200	10,00A4
M 3 x 20	K	200	11,10A4
M 3 x 25	K	200	14,10A4
M 3 x 30	K	200	21,20A4
M 4 x 6	K	200	21,00A4
M 4 x 8	S	1000	13,30A4
M 4 x 8	K	200	15,40A4
M 4 x 10	S	1000	10,90A4
M 4 x 10	K	200	13,00A4
M 4 x 12	K	200	12,60A4
M 4 x 16	S	1000	11,20A4
M 4 x 16	K	200	13,30A4
M 4 x 18	K	200	20,00A4
M 4 x 20	S	1000	12,10A4
M 4 x 20	K	200	14,20A4
M 4 x 25	K	200	17,10A4
M 4 x 30	K	200	21,90A4
M 4 x 35	K	100	32,50A4
M 4 x 40	K	100	43,00A4
M 4 x 45	K	100	56,00A4
M 5 x 10	S	500	16,70A4
M 5 x 10	K	200	18,80A4
M 5 x 12	K	200	15,90A4
M 5 x 16	S	500	15,40A4
M 5 x 16	K	200	17,50A4
M 5 x 20	S	500	16,20A4
M 5 x 20	K	200	18,30A4
M 5 x 25	K	200	21,40A4
M 5 x 30	K	200	27,00A4
M 5 x 35	K	100	36,50A4
M 5 x 40	S	200	40,00A4
M 5 x 40	K	100	44,00A4
M 5 x 50	S	200	86,00A4
M 5 x 50	K	100	90,00A4
M 5 x 60	K	100	112,00A4
M 5 x 70	K	100	137,00A4
M 5 x 80	K	100	152,00A4
M 6 x 10	S	200	24,80A4
M 6 x 10	K	100	29,50A4
M 6 x 12	K	100	28,00A4
M 6 x 16	S	200	22,70A4
M 6 x 16	K	100	27,00A4
M 6 x 20	S	200	26,50A4
M 6 x 20	K	100	31,00A4
M 6 x 25	S	200	31,00A4
M 6 x 25	K	100	35,50A4
M 6 x 30	S	200	35,50A4
M 6 x 30	K	100	40,00A4
M 6 x 35	S	100	44,50A4
M 6 x 40	S	100	59,00A4
M 6 x 40	K	50	68,00A4
M 6 x 50	S	100	90,00A4
M 6 x 50	K	50	99,00A4
M 6 x 60	K	50	105,00A4
M 6 x 70	K	50	153,00A4
M 6 x 80	K	50	182,00A4
M 8 x 16	K	50	65,00A4
M 8 x 20	S	100	59,00A4
M 8 x 20	K	50	68,00A4
M 8 x 25	S	100	65,00A4
M 8 x 25	K	50	73,00A4
M 8 x 30	S	100	73,00A4
M 8 x 40	K	50	99,00A4

Abmessungen	VE	Stück	€/100/Obf.
M 8 x 50	K	50	140,00A4
M 10 x 20	K	50	125,00A4
M 10 x 25	K	50	130,00A4
M 10 x 50	K	50	217,00A4

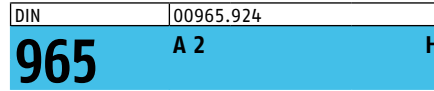

Senkschrauben mit Phillips-Kreuzschlitz H

Maße → **TI-39** Normumstellung → **TI-11**
 Werkstoffeigensch. → **TI-236**

Stahl → **S. 190**

DIN 965 → wird ersetzt durch ISO 7046



M 1,6 x 3-H	S	2000	114,00A2
M 1,6 x 3-H	K	1000	124,00A2
M 1,6 x 4-H	S	2000	114,00A2
M 1,6 x 4-H	K	1000	124,00A2
M 1,6 x 5-H	S	2000	124,00A2
M 1,6 x 5-H	K	1000	133,00A2
M 1,6 x 6-H	S	2000	127,00A2
M 1,6 x 6-H	K	1000	137,00A2
M 1,6 x 8-H	S	2000	131,00A2
M 1,6 x 8-H	K	1000	141,00A2
M 1,6 x 10-H	S	2000	135,00A2
M 1,6 x 10-H	K	1000	144,00A2
M 1,6 x 12-H	S	2000	139,00A2
M 1,6 x 12-H	K	1000	148,00A2
M 1,6 x 16-H	S	2000	142,00A2
M 1,6 x 16-H	K	1000	152,00A2
M 2 x 3-H	S	1000	11,00A2
M 2 x 4-H	S	1000	11,00A2
M 2 x 5-H	S	1000	11,00A2
M 2 x 6-H	S	1000	11,00A2
M 2 x 8-H	S	1000	11,00A2
M 2 x 10-H	S	1000	11,00A2
M 2 x 12-H	S	1000	12,00A2
M 2 x 14-H	S	1000	22,80A2
M 2 x 16-H	S	1000	38,00A2
M 2 x 20-H	S	1000	42,00A2
M 2,5 x 3-H	S	1000	22,80A2
M 2,5 x 4-H	S	1000	22,80A2
M 2,5 x 5-H	S	1000	11,00A2
M 2,5 x 6-H	S	1000	11,00A2
M 2,5 x 8-H	S	1000	11,00A2
M 2,5 x 10-H	S	1000	11,00A2
M 2,5 x 12-H	S	1000	11,40A2
M 2,5 x 16-H	S	1000	12,40A2
M 2,5 x 20-H	S	1000	13,30A2
M 2,5 x 25-H	S	1000	28,50A2
M 3 x 4-H	S	1000	12,50A2
M 3 x 5-H	S	1000	10,60A2
M 3 x 5-H	K	200	12,50A2
M 3 x 6-H	S	1000	7,10A2
M 3 x 6-H	K	200	8,90A2
M 3 x 8-H	S	1000	7,50A2
M 3 x 8-H	K	200	9,40A2
M 3 x 10-H	S	1000	8,00A2
M 3 x 10-H	K	200	9,90A2
M 3 x 12-H	S	1000	8,50A2
M 3 x 12-H	K	200	10,40A2

Abmessungen	VE	Stück	€/100/Obf.
M 3 x 16-H	S	1000	9,20A2
M 3 x 16-H	K	200	11,10A2
M 3 x 20-H	S	1000	10,60A2
M 3 x 20-H	K	200	12,40A2
M 3 x 22-H	S	1000	17,10A2
M 3 x 25-H	S	1000	11,50A2
M 3 x 30-H	S	1000	16,90A2
M 3 x 35-H	S	500	28,50A2
M 3 x 40-H	S	500	35,50A2
M 3 x 45-H	S	500	65,00A2
M 3 x 50-H	S	500	65,00A2
M 4 x 5-H	S	1000	14,30A2
M 4 x 6-H	S	1000	11,30A2
M 4 x 6-H	K	200	13,20A2
M 4 x 8-H	S	1000	11,30A2
M 4 x 8-H	K	200	13,20A2
M 4 x 10-H	S	1000	11,80A2
M 4 x 10-H	K	200	13,70A2
M 4 x 12-H	S	1000	12,40A2
M 4 x 12-H	K	200	14,30A2
M 4 x 14-H	S	1000	14,00A2
M 4 x 16-H	S	1000	14,00A2
M 4 x 16-H	K	200	15,90A2
M 4 x 18-H	S	1000	15,70A2
M 4 x 20-H	S	1000	15,50A2
M 4 x 20-H	K	200	17,40A2
M 4 x 25-H	S	1000	18,00A2
M 4 x 25-H	K	200	19,90A2
M 4 x 30-H	S	1000	21,10A2
M 4 x 30-H	K	200	22,90A2
M 4 x 35-H	S	500	26,50A2
M 4 x 35-H	K	200	28,50A2
M 4 x 40-H	S	500	28,50A2
M 4 x 40-H	K	200	30,50A2
M 4 x 45-H	S	500	65,00A2
M 4 x 50-H	S	500	65,00A2
M 4 x 60-H	S	500	86,00A2
M 5 x 6-H	S	500	28,50A2
M 5 x 8-H	S	500	20,10A2
M 5 x 8-H	K	200	22,00A2
M 5 x 10-H	S	500	19,90A2
M 5 x 10-H	K	200	21,80A2
M 5 x 12-H	S	500	20,10A2
M 5 x 12-H	K	200	22,00A2
M 5 x 14-H	S	500	22,50A2
M 5 x 16-H	S	500	22,40A2
M 5 x 16-H	K	200	24,30A2
M 5 x 18-H	S	500	33,00A2
M 5 x 20-H	S	500	25,00A2
M 5 x 20-H	K	200	27,00A2
M 5 x 25-H	S	500	29,00A2
M 5 x 25-H	K	200	30,50A2
M 5 x 30-H	S	500	33,50A2
M 5 x 30-H	K	200	35,50A2
M 5 x 35-H	S	500	38,00A2
M 5 x 35-H	K	200	40,00A2
M 5 x 40-H	S	200	44,00A2
M 5 x 45-H	S	200	54,00A2
M 5 x 50-H	S	200	57,00A2
M 5 x 55-H	S	200	71,00A2
M 5 x 60-H	S	200	71,00A2
M 5 x 70-H	S	200	96,00A2
M 5 x 80-H	S	200	113,00A2
M 5 x 90-H	S	200	133,00A2
M 5 x 100-H	S	200	161,00A2
M 6 x 8-H	S	200	33,50A2
M 6 x 10-H	S	200	25,00A2
M 6 x 12-H	S	200	26,50A2
M 6 x 16-H	S	200	30,00A2
M 6 x 20-H	S	200	32,50A2
M 6 x 25-H	S	200	36,50A2
M 6 x 30-H	S	200	42,50A2
M 6 x 35-H	S	200	47,00A2
M 6 x 40-H	S	200	54,00A2
M 6 x 45-H	S	200	60,00A2

Abmessungen	VE	Stück	€/100/Obf.
M 6 x 50 -H	S	200	68,00A2
M 6 x 55 -H	S	200	77,00A2
M 6 x 60 -H	S	200	77,00A2
M 6 x 70 -H	S	100	115,00A2
M 6 x 80 -H	S	100	132,00A2
M 6 x 90 -H	S	100	150,00A2
M 6 x 100 -H	S	100	168,00A2
M 6 x 110 -H	S	100	355,00A2
M 6 x 120 -H	S	100	430,00A2
M 8 x 10 -H	S	100	143,00A2
M 8 x 12 -H	S	100	55,00A2
M 8 x 16 -H	S	100	59,00A2
M 8 x 20 -H	S	100	66,00A2
M 8 x 25 -H	S	100	77,00A2
M 8 x 30 -H	S	100	80,00A2
M 8 x 35 -H	S	100	84,00A2
M 8 x 40 -H	S	100	91,00A2
M 8 x 45 -H	S	100	97,00A2
M 8 x 50 -H	S	100	110,00A2
M 8 x 55 -H	S	100	122,00A2
M 8 x 60 -H	S	100	122,00A2
M 8 x 70 -H	S	100	144,00A2
M 8 x 80 -H	S	100	167,00A2
M 8 x 105 -H	S	100	265,00A2
M 8 x 130 -H	S	100	205,00A2
M 10 x 12 -H	S	100	237,00A2
M 10 x 16 -H	S	100	275,00A2
M 10 x 20 -H	S	100	305,00A2
M 10 x 25 -H	S	100	360,00A2
M 10 x 30 -H	S	100	420,00A2
M 10 x 35 -H	S	100	455,00A2
M 10 x 40 -H	S	100	495,00A2
M 10 x 45 -H	S	100	550,00A2
M 10 x 50 -H	S	100	600,00A2
M 10 x 55 -H	S	100	660,00A2
M 10 x 60 -H	S	100	700,00A2

DIN	00965.944
965	A 4 H

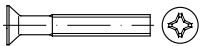

Senkschrauben mit Phillips-Kreuzschlitz H

Maße → **TI-39** Normumstellung → **TI-11**

Werkstoffeigensch. → **TI-236**

Stahl → **S. 190**

DIN 965 → wird ersetzt durch ISO 7046

RoHS	REACH SVHC free
✓	

M 1,6 x 3 -H	S	1000	126,00A4
M 1,6 x 4 -H	S	1000	126,00A4
M 1,6 x 5 -H	S	1000	137,00A4
M 1,6 x 10 -H	S	1000	149,00A4
M 1,6 x 16 -H	S	1000	158,00A4
M 2 x 3 -H	S	1000	34,00A4
M 2 x 4 -H	S	1000	34,00A4
M 2 x 5 -H	S	1000	36,50A4
M 2 x 6 -H	S	1000	39,50A4
M 2 x 8 -H	S	1000	42,00A4
M 2 x 10 -H	S	1000	44,50A4
M 2 x 12 -H	S	1000	47,50A4
M 2 x 16 -H	S	1000	51,00A4
M 2 x 20 -H	S	1000	57,00A4
M 2,5 x 3 -H	S	1000	34,00A4

Abmessungen	VE	Stück	€/100/Obf.
M 2,5 x 4 -H	S	1000	34,00A4
M 2,5 x 5 -H	S	1000	38,00A4
M 2,5 x 6 -H	S	1000	40,00A4
M 2,5 x 8 -H	S	1000	46,50A4
M 2,5 x 10 -H	S	1000	51,00A4
M 2,5 x 12 -H	S	1000	55,00A4
M 2,5 x 14 -H	S	1000	62,00A4
M 2,5 x 16 -H	S	1000	62,00A4
M 2,5 x 20 -H	S	1000	74,00A4
M 2,5 x 25 -H	S	1000	89,00A4
M 3 x 4 -H	S	1000	42,00A4
M 3 x 5 -H	S	1000	42,00A4
M 3 x 6 -H	S	1000	12,40A4
M 3 x 8 -H	S	1000	12,10A4
M 3 x 10 -H	S	1000	13,40A4
M 3 x 12 -H	S	1000	14,40A4
M 3 x 14 -H	S	1000	15,60A4
M 3 x 16 -H	S	1000	15,60A4
M 3 x 20 -H	S	1000	17,40A4
M 3 x 25 -H	S	1000	20,40A4
M 3 x 30 -H	S	1000	30,00A4
M 3 x 35 -H	S	1000	55,00A4
M 3 x 40 -H	S	500	70,00A4
M 4 x 5 -H	S	1000	28,50A4
M 4 x 6 -H	S	1000	20,10A4
M 4 x 8 -H	S	1000	18,10A4
M 4 x 10 -H	S	1000	19,30A4
M 4 x 12 -H	S	1000	20,80A4
M 4 x 16 -H	S	1000	22,30A4
M 4 x 18 -H	S	1000	25,50A4
M 4 x 20 -H	S	1000	25,00A4
M 4 x 25 -H	S	1000	30,00A4
M 4 x 30 -H	S	1000	37,50A4
M 4 x 35 -H	S	500	47,00A4
M 4 x 40 -H	S	500	51,00A4
M 4 x 45 -H	S	500	115,00A4
M 4 x 50 -H	S	200	115,00A4
M 4 x 55 -H	S	200	139,00A4
M 4 x 60 -H	S	200	179,00A4
M 5 x 6 -H	S	500	42,00A4
M 5 x 8 -H	S	500	38,00A4
M 5 x 10 -H	S	500	28,50A4
M 5 x 12 -H	S	500	30,50A4
M 5 x 16 -H	S	500	32,50A4
M 5 x 20 -H	S	500	35,50A4
M 5 x 25 -H	S	500	42,50A4
M 5 x 30 -H	S	500	50,00A4
M 5 x 35 -H	S	200	62,00A4
M 5 x 40 -H	S	200	80,00A4
M 5 x 45 -H	S	200	134,00A4
M 5 x 50 -H	S	200	147,00A4
M 5 x 55 -H	S	200	172,00A4
M 5 x 60 -H	S	200	200,00A4
M 6 x 8 -H	S	200	52,00A4
M 6 x 10 -H	S	200	42,50A4
M 6 x 12 -H	S	200	44,50A4
M 6 x 16 -H	S	200	48,00A4
M 6 x 20 -H	S	200	52,00A4
M 6 x 25 -H	S	200	60,00A4
M 6 x 30 -H	S	200	64,00A4
M 6 x 35 -H	S	200	84,00A4
M 6 x 40 -H	S	200	84,00A4
M 6 x 45 -H	S	200	114,00A4
M 6 x 50 -H	S	200	114,00A4
M 6 x 55 -H	S	200	137,00A4
M 6 x 60 -H	S	200	137,00A4
M 6 x 70 -H	S	200	200,00A4
M 6 x 80 -H	S	200	255,00A4
M 6 x 90 -H	S	200	305,00A4
M 8 x 10 -H	S	200	137,00A4
M 8 x 12 -H	S	100	137,00A4
M 8 x 16 -H	S	100	112,00A4
M 8 x 20 -H	S	100	120,00A4
M 8 x 25 -H	S	100	129,00A4
M 8 x 30 -H	S	100	149,00A4

Abmessungen	VE	Stück	€/100/Obf.
M 8 x 35 -H	S	100	174,00A4
M 8 x 40 -H	S	100	192,00A4
M 8 x 45 -H	S	100	370,00A4
M 8 x 50 -H	S	100	435,00A4
M 8 x 55 -H	S	100	550,00A4
M 8 x 60 -H	S	100	610,00A4
M 8 x 70 -H	S	100	700,00A4
M 8 x 80 -H	S	100	790,00A4
M 8 x 90 -H	S	100	900,00A4
M 10 x 16 -H	S	100	530,00A4
M 10 x 20 -H	S	100	295,00A4
M 10 x 25 -H	S	100	320,00A4
M 10 x 30 -H	S	100	340,00A4
M 10 x 35 -H	S	100	380,00A4
M 10 x 40 -H	S	100	415,00A4
M 10 x 45 -H	S	100	425,00A4
M 10 x 50 -H	S	100	425,00A4
M 10 x 55 -H	S	100	475,00A4
M 10 x 60 -H	S	100	475,00A4
M 10 x 70 -H	S	100	890,00A4
M 10 x 80 -H	S	100	1050,00A4

DIN	00965.925
965	A 2 Z

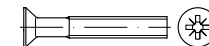

Senkschrauben mit Pozidriv-Kreuzschlitz Z

Maße → **TI-39**

Normumstellung → **TI-11**

Werkstoffeigensch. → **TI-236**

Stahl → **S. 191**

DIN 965 → wird ersetzt durch ISO 7046

RoHS	REACH SVHC free
✓	

M 1,6 x 3 -Z	S	2000	114,00A2
M 1,6 x 4 -Z	S	2000	114,00A2
M 1,6 x 5 -Z	S	2000	124,00A2
M 1,6 x 6 -Z	S	2000	127,00A2
M 1,6 x 8 -Z	S	2000	131,00A2
M 1,6 x 10 -Z	S	2000	135,00A2
M 1,6 x 12 -Z	S	2000	139,00A2
M 1,6 x 16 -Z	S	2000	142,00A2
M 2 x 3 -Z	S	1000	22,80A2
M 2 x 4 -Z	S	1000	24,70A2
M 2 x 5 -Z	S	1000	27,00A2
M 2 x 6 -Z	S	1000	30,00A2
M 2 x 10 -Z	S	1000	30,00A2
M 2 x 12 -Z	S	1000	31,00A2
M 2 x 14 -Z	S	1000	38,00A2
M 2 x 16 -Z	S	1000	38,00A2
M 2 x 20 -Z	S	1000	42,00A2
M 2,5 x 3 -Z	S	1000	22,80A2
M 2,5 x 4 -Z	S	1000	22,80A2
M 2,5 x 5 -Z	S	1000	11,00A2
M 2,5 x 6 -Z	S	1000	11,00A2
M 2,5 x 8 -Z	S	1000	11,00A2
M 2,5 x 10 -Z	S	1000	11,00A2
M 2,5 x 12 -Z	S	1000	11,40A2
M 2,5 x 16 -Z	S	1000	12,40A2
M 2,5 x 20 -Z	S	1000	13,30A2
M 2,5 x 25 -Z	S	1000	28,50A2
M 3 x 4 -Z	S	1000	12,50A2
M 3 x 5 -Z	S	1000	10,60A2
M 3 x 6 -Z	S	1000	7,10A2

Abmessungen	VE	Stück	€/100/Obf.
M 3 x 8-Z	S	1000	7,50A2
M 3 x 10-Z	S	1000	8,00A2
M 3 x 12-Z	S	1000	8,50A2
M 3 x 14-Z	S	1000	8,40A2
M 3 x 16-Z	S	1000	9,20A2
M 3 x 22-Z	S	1000	11,50A2
M 3 x 25-Z	S	1000	11,50A2
M 3 x 30-Z	S	1000	16,90A2
M 3 x 35-Z	S	500	28,50A2
M 3 x 40-Z	S	500	35,50A2
M 3 x 45-Z	S	500	65,00A2
M 3 x 50-Z	S	500	65,00A2
M 4 x 5-Z	S	1000	14,30A2
M 4 x 6-Z	S	1000	11,30A2
M 4 x 8-Z	S	1000	11,30A2
M 4 x 10-Z	S	1000	11,80A2
M 4 x 12-Z	S	1000	12,40A2
M 4 x 14-Z	S	1000	14,00A2
M 4 x 16-Z	S	1000	14,00A2
M 4 x 20-Z	S	1000	15,50A2
M 4 x 22-Z	S	1000	18,00A2
M 4 x 25-Z	S	1000	18,00A2
M 4 x 30-Z	S	1000	21,10A2
M 4 x 35-Z	S	1000	26,50A2
M 4 x 40-Z	S	500	28,50A2
M 4 x 45-Z	S	500	65,00A2
M 4 x 60-Z	S	500	76,00A2
M 5 x 8-Z	S	500	20,10A2
M 5 x 10-Z	S	500	19,90A2
M 5 x 12-Z	S	500	20,10A2
M 5 x 16-Z	S	500	22,40A2
M 5 x 18-Z	S	500	27,00A2
M 5 x 20-Z	S	500	25,00A2
M 5 x 25-Z	S	500	29,00A2
M 5 x 30-Z	S	500	33,50A2
M 5 x 35-Z	S	500	38,00A2
M 5 x 40-Z	S	200	44,00A2
M 5 x 45-Z	S	200	57,00A2
M 5 x 50-Z	S	200	57,00A2
M 5 x 55-Z	S	200	71,00A2
M 5 x 60-Z	S	200	71,00A2
M 5 x 70-Z	S	200	96,00A2
M 5 x 80-Z	S	200	113,00A2
M 5 x 90-Z	S	200	133,00A2
M 5 x 100-Z	S	200	161,00A2
M 6 x 8-Z	S	200	33,50A2
M 6 x 10-Z	S	200	25,00A2
M 6 x 12-Z	S	200	26,50A2
M 6 x 16-Z	S	200	30,00A2
M 6 x 20-Z	S	200	32,50A2
M 6 x 25-Z	S	200	36,50A2
M 6 x 30-Z	S	200	42,50A2
M 6 x 35-Z	S	200	47,00A2
M 6 x 40-Z	S	200	54,00A2
M 6 x 45-Z	S	200	86,00A2
M 6 x 50-Z	S	200	68,00A2
M 6 x 55-Z	S	200	77,00A2
M 6 x 60-Z	S	200	77,00A2
M 6 x 70-Z	S	100	171,00A2
M 6 x 80-Z	S	100	199,00A2
M 6 x 90-Z	S	100	237,00A2
M 6 x 100-Z	S	100	285,00A2
M 6 x 110-Z	S	100	355,00A2
M 6 x 120-Z	S	100	430,00A2
M 8 x 10-Z	S	100	143,00A2
M 8 x 12-Z	S	100	161,00A2
M 8 x 16-Z	S	100	190,00A2
M 8 x 20-Z	S	100	209,00A2
M 8 x 25-Z	S	100	247,00A2
M 8 x 30-Z	S	100	285,00A2
M 8 x 40-Z	S	100	345,00A2
M 8 x 45-Z	S	100	380,00A2
M 8 x 50-Z	S	100	410,00A2
M 8 x 55-Z	S	100	445,00A2
M 8 x 60-Z	S	100	475,00A2

Abmessungen	VE	Stück	€/100/Obf.
M 8 x 70-Z	S	100	560,00A2
M 8 x 80-Z	S	100	670,00A2
M 10 x 12-Z	S	100	237,00A2
M 10 x 16-Z	S	100	275,00A2
M 10 x 25-Z	S	100	360,00A2
M 10 x 35-Z	S	100	455,00A2
M 10 x 40-Z	S	100	495,00A2

~DIN 00965.926
965 A 2 **ISR**



Senkschrauben, ISR = Innensechsrund

Maße → **TI-39** Werkstoffeigensch. → **TI-236**
 Stahl → **S. 191**
 ~ ISO 14581



M 1,6 x 3-T5	K	1000	124,00A2
M 1,6 x 4-T5	K	1000	124,00A2
M 1,6 x 5-T5	K	1000	133,00A2
M 1,6 x 6-T5	K	1000	137,00A2
M 1,6 x 8-T5	K	1000	141,00A2
M 1,6 x 10-T5	K	1000	144,00A2
M 2 x 3-T6	S	2000	22,80A2
M 2 x 4-T6	S	2000	24,70A2
M 2 x 5-T6	S	2000	27,00A2
M 2 x 6-T6	S	2000	30,00A2
M 2 x 8-T6	S	2000	32,00A2
M 2 x 10-T6	S	2000	34,00A2
M 2 x 12-T6	S	2000	35,50A2
M 2 x 16-T6	S	2000	38,00A2
M 2 x 20-T6	S	2000	42,00A2
M 2,5 x 3-T8	S	2000	22,80A2
M 2,5 x 4-T8	S	2000	22,80A2
M 2,5 x 5-T8	S	1000	15,60A2
M 2,5 x 6-T8	S	1000	15,90A2
M 2,5 x 8-T8	S	1000	16,30A2
M 2,5 x 10-T8	S	1000	16,90A2
M 2,5 x 12-T8	S	1000	17,80A2
M 2,5 x 16-T8	S	1000	19,50A2
M 2,5 x 18-T8	S	1000	23,20A2
M 2,5 x 20-T8	S	1000	20,50A2
M 2,5 x 25-T8	S	1000	28,50A2
M 3 x 4-T10	S	1000	19,00A2
M 3 x 5-T10	S	1000	15,90A2
M 3 x 6-T10	S	1000	10,60A2
M 3 x 8-T10	S	1000	11,20A2
M 3 x 10-T10	S	1000	12,00A2
M 3 x 12-T10	S	1000	12,50A2
M 3 x 16-T10	S	1000	13,70A2
M 3 x 20-T10	S	1000	15,80A2
M 3 x 22-T10	S	1000	11,50A2
M 3 x 25-T10	S	1000	17,10A2
M 3 x 30-T10	S	1000	25,50A2
M 4 x 5-T20	S	1000	21,40A2
M 4 x 6-T20	S	1000	16,90A2
M 4 x 8-T20	S	1000	17,10A2
M 4 x 10-T20	S	1000	17,60A2
M 4 x 12-T20	S	1000	18,60A2
M 4 x 16-T20	S	1000	21,10A2
M 4 x 20-T20	S	1000	23,10A2
M 4 x 25-T20	S	1000	27,00A2

Abmessungen	VE	Stück	€/100/Obf.
M 4 x 30-T20	S	1000	32,00A2
M 4 x 35-T20	S	500	40,00A2
M 4 x 40-T20	S	500	43,00A2
M 5 x 6-T25	S	1000	33,50A2
M 5 x 8-T25	S	500	29,50A2
M 5 x 10-T25	S	500	30,00A2
M 5 x 12-T25	S	500	30,00A2
M 5 x 14-T25	S	500	42,00A2
M 5 x 16-T25	S	500	33,50A2
M 5 x 20-T25	S	500	24,30A2
M 5 x 25-T25	S	500	43,00A2
M 5 x 30-T25	S	500	50,00A2
M 5 x 35-T25	S	500	56,00A2
M 5 x 40-T25	S	200	66,00A2
M 5 x 45-T25	S	200	80,00A2
M 5 x 50-T25	S	200	105,00A2
M 6 x 8-T30	S	1000	28,50A2
M 6 x 10-T30	S	200	20,50A2
M 6 x 12-T30	S	200	39,00A2
M 6 x 16-T30	S	200	44,50A2
M 6 x 20-T30	S	200	48,50A2
M 6 x 25-T30	S	200	54,00A2
M 6 x 30-T30	S	200	64,00A2
M 6 x 35-T30	S	200	84,00A2
M 6 x 40-T30	S	200	87,00A2
M 6 x 45-T30	S	200	87,00A2
M 6 x 50-T30	S	200	156,00A2
M 6 x 60-T30	S	200	158,00A2
M 8 x 10-T40	S	100	143,00A2
M 8 x 12-T40	S	100	161,00A2
M 8 x 16-T40	S	100	190,00A2
M 8 x 20-T40	S	100	209,00A2
M 8 x 25-T40	S	100	247,00A2
M 8 x 30-T40	S	100	285,00A2
M 8 x 35-T40	S	100	315,00A2
M 8 x 40-T40	S	100	345,00A2
M 8 x 45-T40	S	100	380,00A2
M 8 x 50-T40	S	100	410,00A2
M 8 x 55-T40	S	100	445,00A2
M 8 x 60-T40	S	50	475,00A2
M 10 x 12-T50	S	100	325,00A2
M 10 x 16-T50	S	100	380,00A2
M 10 x 20-T50	S	100	410,00A2
M 10 x 25-T50	S	100	485,00A2
M 10 x 30-T50	S	100	570,00A2
M 10 x 35-T50	S	100	620,00A2
M 10 x 40-T50	S	100	710,00A2
M 10 x 45-T50	S	100	760,00A2
M 10 x 50-T50	S	100	800,00A2
M 10 x 55-T50	S	100	880,00A2
M 10 x 60-T50	S	100	950,00A2



- ✓ Große Artikelvielfalt
- ✓ Verlässliche Qualität
- ✓ Hohe Lieferbereitschaft

Abmessungen	VE Stück	€/100/Obf.
~DIN	00965.948	
965	A 4	ISR



**Senkschrauben,
ISR = Innensechsrund**

Maße → **TI-39** Werkstoffeigensch. → **TI-236**

Stahl → **S. 191**

~ ISO 14581

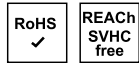

M 2	x	3 -T6	S	2000	40,00A4
M 2	x	4 -T6	S	2000	44,00A4
M 2	x	5 -T6	S	2000	47,50A4
M 2	x	6 -T6	S	2000	52,00A4
M 2	x	8 -T6	S	2000	57,00A4
M 2	x	10 -T6	S	2000	41,00A4
M 2	x	12 -T6	S	2000	62,00A4
M 2	x	16 -T6	S	2000	67,00A4
M 2	x	20 -T6	S	2000	73,00A4
M 2,5	x	3 -T8	S	2000	40,00A4
M 2,5	x	4 -T8	S	2000	40,00A4
M 2,5	x	5 -T8	S	1000	28,50A4
M 2,5	x	6 -T8	S	1000	28,50A4
M 2,5	x	8 -T8	S	1000	29,50A4
M 2,5	x	10 -T8	S	1000	30,50A4
M 2,5	x	12 -T8	S	1000	32,50A4
M 2,5	x	16 -T8	S	1000	36,00A4
M 2,5	x	18 -T8	S	1000	42,00A4
M 2,5	x	20 -T8	S	1000	47,50A4
M 2,5	x	25 -T8	S	1000	52,00A4
M 3	x	4 -T10	S	1000	34,50A4
M 3	x	5 -T10	S	1000	28,50A4
M 3	x	6 -T10	S	1000	19,00A4
M 3	x	8 -T10	S	1000	20,90A4
M 3	x	10 -T10	S	1000	21,80A4
M 3	x	12 -T10	S	1000	22,80A4
M 3	x	16 -T10	S	1000	24,70A4
M 3	x	20 -T10	S	1000	28,50A4
M 3	x	25 -T10	S	1000	30,50A4
M 3	x	30 -T10	S	1000	45,50A4
M 4	x	5 -T20	S	1000	38,00A4
M 4	x	6 -T20	S	1000	30,50A4
M 4	x	8 -T20	S	1000	30,50A4
M 4	x	10 -T20	S	1000	32,50A4
M 4	x	12 -T20	S	1000	33,50A4
M 4	x	16 -T20	S	1000	38,00A4
M 4	x	20 -T20	S	1000	42,00A4
M 4	x	25 -T20	S	1000	47,50A4
M 4	x	30 -T20	S	1000	57,00A4
M 4	x	35 -T20	S	500	71,00A4
M 4	x	40 -T20	S	500	76,00A4
M 5	x	6 -T25	S	1000	59,00A4
M 5	x	8 -T25	S	500	61,00A4
M 5	x	10 -T25	S	500	67,00A4
M 5	x	12 -T25	S	500	72,00A4
M 5	x	14 -T25	S	500	76,00A4
M 5	x	16 -T25	S	500	80,00A4
M 5	x	20 -T25	S	500	84,00A4
M 5	x	25 -T25	S	500	86,00A4
M 5	x	30 -T25	S	500	89,00A4
M 5	x	35 -T25	S	500	99,00A4
M 5	x	40 -T25	S	500	85,00A4
M 5	x	45 -T25	S	200	142,00A4

Abmessungen	VE Stück	€/100/Obf.			
M 5	x	50 -T25	S	200	190,00A4
M 6	x	8 -T30	S	1000	52,00A4
M 6	x	10 -T30	S	200	61,00A4
M 6	x	12 -T30	S	200	69,00A4
M 6	x	16 -T30	S	200	80,00A4
M 6	x	20 -T30	S	200	86,00A4
M 6	x	25 -T30	S	200	95,00A4
M 6	x	30 -T30	S	200	112,00A4
M 6	x	35 -T30	S	200	146,00A4
M 6	x	40 -T30	S	200	152,00A4
M 6	x	45 -T30	S	200	190,00A4
M 6	x	50 -T30	S	200	275,00A4
M 6	x	60 -T30	S	200	315,00A4
M 8	x	10 -T40	S	100	260,00A4
M 8	x	12 -T40	S	100	285,00A4
M 8	x	16 -T40	S	200	75,00A4
M 8	x	20 -T40	S	200	85,00A4
M 8	x	25 -T40	S	100	440,00A4
M 8	x	30 -T40	S	100	510,00A4
M 8	x	35 -T40	S	100	550,00A4
M 8	x	40 -T40	S	100	600,00A4
M 8	x	45 -T40	S	100	670,00A4
M 8	x	50 -T40	S	100	720,00A4
M 8	x	60 -T40	S	50	840,00A4

Abmessungen	VE Stück	€/100/Obf.
DIN	00966.924	
966	A 2	H

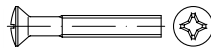

**Linsensenkschrauben
mit Phillips-Kreuzschlitz H**

Maße → **TI-39** Normumstellung → **TI-11**

Werkstoffeigensch. → **TI-236**

Stahl → **S. 192**

DIN 966 → wird ersetzt durch ISO 7047

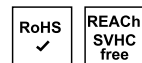

M 2,5	x	4 -H	S	1000	28,50A2
M 2,5	x	5 -H	S	1000	26,00A2
M 2,5	x	6 -H	S	1000	21,80A2
M 2,5	x	8 -H	S	1000	13,20A2
M 2,5	x	10 -H	S	1000	13,20A2
M 2,5	x	12 -H	S	1000	16,10A2
M 2,5	x	16 -H	S	1000	20,90A2
M 2,5	x	20 -H	S	1000	30,50A2
M 2,5	x	25 -H	S	1000	45,50A2
M 3	x	4 -H	S	1000	19,00A2
M 3	x	5 -H	S	1000	10,60A2
M 3	x	6 -H	S	1000	7,10A2
M 3	x	8 -H	S	1000	7,50A2
M 3	x	10 -H	S	1000	8,00A2
M 3	x	12 -H	S	1000	9,20A2
M 3	x	16 -H	S	1000	9,20A2
M 3	x	18 -H	S	1000	10,50A2
M 3	x	20 -H	S	1000	10,60A2
M 3	x	25 -H	S	1000	18,50A2
M 3	x	30 -H	S	500	24,70A2
M 3	x	35 -H	S	500	26,50A2
M 3	x	45 -H	S	500	61,00A2
M 3	x	50 -H	S	500	95,00A2
M 4	x	5 -H	S	1000	22,80A2
M 4	x	6 -H	S	1000	11,00A2
M 4	x	8 -H	S	1000	11,30A2
M 4	x	10 -H	S	1000	11,80A2

Abmessungen	VE Stück	€/100/Obf.			
M 4	x	12 -H	S	1000	12,40A2
M 4	x	14 -H	S	1000	14,00A2
M 4	x	16 -H	S	1000	14,00A2
M 4	x	20 -H	S	1000	15,50A2
M 4	x	25 -H	S	1000	18,00A2
M 4	x	30 -H	S	500	21,10A2
M 4	x	35 -H	S	500	26,50A2
M 4	x	40 -H	S	500	28,50A2
M 4	x	45 -H	S	500	67,00A2
M 4	x	50 -H	S	500	110,00A2
M 5	x	6 -H	S	500	30,50A2
M 5	x	8 -H	S	500	20,10A2
M 5	x	10 -H	S	500	19,90A2
M 5	x	12 -H	S	500	20,10A2
M 5	x	16 -H	S	500	22,40A2
M 5	x	20 -H	S	500	25,00A2
M 5	x	25 -H	S	500	29,00A2
M 5	x	30 -H	S	500	33,50A2
M 5	x	35 -H	S	500	38,00A2
M 5	x	40 -H	S	200	44,00A2
M 5	x	45 -H	S	200	59,00A2
M 5	x	50 -H	S	200	62,00A2
M 5	x	55 -H	S	200	86,00A2
M 5	x	60 -H	S	200	81,00A2
M 5	x	70 -H	S	200	114,00A2
M 5	x	80 -H	S	200	161,00A2
M 6	x	8 -H	S	200	38,00A2
M 6	x	10 -H	S	200	38,00A2
M 6	x	12 -H	S	200	26,50A2
M 6	x	16 -H	S	200	30,00A2
M 6	x	20 -H	S	200	32,50A2
M 6	x	22 -H	S	200	126,00A2
M 6	x	25 -H	S	200	36,50A2
M 6	x	30 -H	S	200	42,50A2
M 6	x	35 -H	S	200	47,00A2
M 6	x	40 -H	S	200	54,00A2
M 6	x	45 -H	S	200	63,00A2
M 6	x	50 -H	S	200	64,00A2
M 6	x	55 -H	S	200	77,00A2
M 6	x	60 -H	S	200	77,00A2
M 6	x	65 -H	S	200	142,00A2
M 6	x	70 -H	S	200	167,00A2
M 6	x	80 -H	S	200	209,00A2
M 8	x	10 -H	S	200	57,00A2
M 8	x	12 -H	S	200	57,00A2
M 8	x	16 -H	S	200	45,00A2
M 8	x	20 -H	S	200	47,50A2
M 8	x	25 -H	S	200	59,00A2
M 8	x	30 -H	S	200	64,00A2
M 8	x	35 -H	S	100	71,00A2
M 8	x	40 -H	S	100	75,00A2
M 8	x	45 -H	S	100	151,00A2
M 8	x	50 -H	S	100	151,00A2
M 8	x	55 -H	S	100	163,00A2
M 8	x	60 -H	S	100	175,00A2

Abmessungen	VE Stück	€/100/Obf.
DIN	00966.944	
966	A 4	H



Linsensenschrauben mit Phillips-Kreuzschlitz H

Maße → **TI-39** Normumstellung → **TI-11**
 Werkstoffeigensch. → **TI-236**
 Stahl → **S. 192**
 DIN 966 → wird ersetzt durch ISO 7047



M 2,5 x 6 -H	S	1000	36,50 A4
M 2,5 x 8 -H	S	1000	22,10 A4
M 2,5 x 10 -H	S	1000	31,00 A4
M 2,5 x 12 -H	S	1000	27,00 A4
M 2,5 x 16 -H	S	1000	35,00 A4
M 2,5 x 20 -H	S	1000	51,00 A4
M 2,5 x 25 -H	S	1000	76,00 A4
M 3 x 4 -H	S	1000	31,50 A4
M 3 x 5 -H	S	1000	17,70 A4
M 3 x 6 -H	S	1000	12,10 A4
M 3 x 8 -H	S	1000	12,60 A4
M 3 x 10 -H	S	1000	13,40 A4
M 3 x 12 -H	S	1000	14,40 A4
M 3 x 16 -H	S	1000	15,60 A4
M 3 x 20 -H	S	1000	17,40 A4
M 3 x 25 -H	S	1000	20,40 A4
M 3 x 30 -H	S	1000	41,00 A4
M 4 x 6 -H	S	1000	18,30 A4
M 4 x 8 -H	S	1000	18,10 A4
M 4 x 10 -H	S	1000	19,30 A4
M 4 x 12 -H	S	1000	20,80 A4
M 4 x 16 -H	S	1000	22,30 A4
M 4 x 20 -H	S	1000	25,00 A4
M 4 x 25 -H	S	1000	30,00 A4
M 4 x 30 -H	S	1000	35,00 A4
M 4 x 35 -H	S	1000	44,50 A4
M 4 x 40 -H	S	1000	47,50 A4
M 5 x 6 -H	S	500	51,00 A4
M 5 x 8 -H	S	500	33,50 A4
M 5 x 10 -H	S	500	28,50 A4
M 5 x 12 -H	S	500	30,50 A4
M 5 x 16 -H	S	500	32,50 A4
M 5 x 20 -H	S	500	35,50 A4
M 5 x 25 -H	S	500	42,50 A4
M 5 x 30 -H	S	500	50,00 A4
M 5 x 35 -H	S	500	63,00 A4
M 5 x 40 -H	S	200	73,00 A4
M 5 x 45 -H	S	200	98,00 A4
M 5 x 50 -H	S	200	103,00 A4
M 6 x 8 -H	S	200	63,00 A4
M 6 x 10 -H	S	200	42,50 A4
M 6 x 12 -H	S	200	44,50 A4
M 6 x 16 -H	S	200	48,00 A4
M 6 x 20 -H	S	200	50,00 A4
M 6 x 25 -H	S	200	57,00 A4
M 6 x 30 -H	S	200	64,00 A4
M 6 x 35 -H	S	200	71,00 A4
M 6 x 40 -H	S	200	84,00 A4
M 6 x 45 -H	S	200	105,00 A4
M 6 x 50 -H	S	200	107,00 A4
M 6 x 55 -H	S	200	128,00 A4
M 6 x 60 -H	S	200	152,00 A4

Abmessungen	VE Stück	€/100/Obf.	
M 8 x 10 -H	S	200	95,00 A4
M 8 x 16 -H	S	200	75,00 A4
M 8 x 20 -H	S	200	79,00 A4
M 8 x 25 -H	S	200	97,00 A4
M 8 x 30 -H	S	200	106,00 A4
M 8 x 35 -H	S	100	118,00 A4
M 8 x 40 -H	S	100	124,00 A4
M 8 x 45 -H	S	100	255,00 A4
M 8 x 50 -H	S	100	255,00 A4
M 8 x 55 -H	S	100	275,00 A4
M 8 x 60 -H	S	100	290,00 A4

~DIN	00975.920
975*	A 2



Gewindestangen, Länge 1000 mm
(entsprechend DIN 976-1, Form A)

Werkstoffeigensch. → **TI-236**
 Stahl → **S. 192**
 Messing, Kunststoff → **S. 630**
 Farbkennzeichnung (als Ersatz für Stempelung) → Infoeinblender

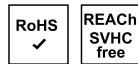

M 3	S	1	680,00 A2
M 4	S	1	650,00 A2
M 5	S	1	710,00 A2
M 6	S	1	720,00 A2
M 8	S	1	1140,00 A2
M 10	S	1	1610,00 A2
M 12	S	1	2350,00 A2
M 14	S	1	3350,00 A2
M 16	S	1	3800,00 A2
M 20	S	1	6300,00 A2
M 24	S	1	8800,00 A2
M 27	S	1	10500,00 A2
M 30	S	1	14400,00 A2
M 36	S	1	19200,00 A2

Farb-Kennzeichnung für Gewindestangen

Fkl./Werkstoff	Farbe	~RAL-Nr.
A 2	grün	6024
A 4	rot	3000
andere	nach Vereinbarung	

Farbe anstatt Stempelung nach DIN 976-1

Abmessungen	VE Stück	€/100/Obf.
~DIN	00975.926	
975*	A 2	2000



Gewindestangen, Länge 2000 mm
(entsprechend DIN 976-1, Form A)

Werkstoffeigensch. → **TI-236**
 Stahl → **S. 193**
 Farbkennzeichnung (als Ersatz für Stempelung) → Infoeinblender

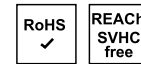

M 8 x 2000	S	1	2280,00 A2
M 10 x 2000	S	1	3200,00 A2
M 12 x 2000	S	1	4650,00 A2
M 16 x 2000	S	1	7600,00 A2
M 20 x 2000	S	1	12500,00 A2
M 24 x 2000	S	1	17500,00 A2

~DIN	00975.940
975*	A 4

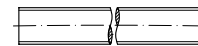

Gewindestangen, Länge 1000 mm
(entsprechend DIN 976-1, Form A)

Werkstoffeigensch. → **TI-236**
 Stahl → **S. 192**
 Messing, Kunststoff → **S. 630**
 Farbkennzeichnung (als Ersatz für Stempelung) → Infoeinblender

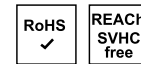

M 2	S	1	1220,00 A4
M 3	S	1	880,00 A4
M 4	S	1	820,00 A4
M 5	S	1	1180,00 A4
M 6	S	1	1240,00 A4
M 8	S	1	1620,00 A4
M 10	S	1	2480,00 A4
M 12	S	1	3400,00 A4
M 14	S	1	4600,00 A4
M 16	S	1	6000,00 A4
M 18	S	1	7400,00 A4
M 20	S	1	8700,00 A4
M 22	S	1	11800,00 A4
M 24	S	1	13900,00 A4
M 27	S	1	16000,00 A4
M 30	S	1	19600,00 A4
M 33	S	1	29200,00 A4
M 36	S	1	29800,00 A4

Abmessungen	VE Stück	€/100/Obf.
~DIN	00975.924	
975*	A 2	Links



Gewindestangen, Länge 1000 mm mit metrischem Linksgewinde

(entsprechend DIN 976-1, Form A)

Werkstoffeigensch. → TI-236

Stahl → S. 194

Farbkennzeichnung (als Ersatz für Stempelung) → Infoeinblender

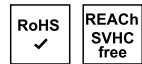

M 6 -LH	S	1	3000,00A2
M 8 -LH	S	1	3000,00A2
M 10 -LH	S	1	4100,00A2
M 12 -LH	S	1	7100,00A2
M 16 -LH	S	1	11400,00A2
M 20 -LH	S	1	18600,00A2

~DIN	00975.944
975	A 4 Trapez



Gewindestangen, Länge 1000 mm, mit normalem Trapezgewinde

Gewinde nach DIN 103, Gewindeenden nach DIN 78-Ko/ISO 4753-RL

Rundmuffen TR → Artikel 88089

Werkstoffeigensch. → TI-236

Stahl → S. 197

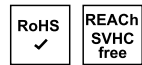

TR 16	x	4	S	1	33200,00A4
TR 20	x	4	S	1	44900,00A4
TR 24	x	5	S	1	74300,00A4
TR 30	x	6	S	1	86700,00A4

Farb-Kennzeichnung für Gewindestangen



Fkl./Werkstoff	Farbe	~RAL-Nr.
A2	grün	6024
A4	rot	3000
andere	nach Vereinbarung	

Farbe anstatt Stempelung nach DIN 976-1

Abmessungen	VE Stück	€/100/Obf.
~DIN	00975.950	
975*	A 5	



Gewindestangen, Länge 1000 mm

(entsprechend DIN 976-1, Form A)

Werkstoffeigensch. → TI-236

Stahl → S. 192

Messing, Kunststoff → S. 630

Farbkennzeichnung (als Ersatz für Stempelung) → Infoeinblender

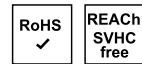

M 6	S	1	1670,00A5
M 8	S	1	2190,00A5
M 10	S	1	3350,00A5
M 12	S	1	4600,00A5
M 16	S	1	8100,00A5
M 20	S	1	11700,00A5
M 24	S	1	18700,00A5

DIN	00976.922
976-1	A 2 Form B

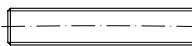

Gewindebolzen, B = mit Kegelhuppen

Werkstoffeigensch. → TI-236

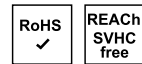

BM 8	x	16	S	100	146,00A2
BM 8	x	20	S	100	182,00A2
BM 8	x	25	S	100	228,00A2
BM 8	x	30	S	100	275,00A2
BM 8	x	35	S	100	320,00A2
BM 8	x	40	S	100	365,00A2
BM 8	x	45	S	100	410,00A2
BM 8	x	50	S	100	460,00A2
BM 8	x	55	S	100	510,00A2
BM 8	x	60	S	100	550,00A2
BM 8	x	65	S	100	600,00A2
BM 8	x	70	S	100	650,00A2
BM 8	x	80	S	100	730,00A2
BM 8	x	90	S	100	830,00A2
BM 8	x	100	S	100	910,00A2
BM 8	x	110	S	100	1010,00A2
BM 8	x	120	S	100	1100,00A2
BM 8	x	130	S	100	1200,00A2
BM 8	x	140	S	50	1290,00A2
BM 8	x	150	S	50	1390,00A2
BM 8	x	160	S	50	1460,00A2
BM 8	x	170	S	50	1560,00A2
BM 8	x	180	S	50	1650,00A2
BM 8	x	190	S	50	1750,00A2

BM 8	x	200	S	50	1840,00A2
BM 8	x	250	S	25	2290,00A2
BM 8	x	300	S	25	2750,00A2
BM 8	x	500	S	10	4600,00A2
BM 10	x	20	S	100	194,00A2
BM 10	x	25	S	100	243,00A2
BM 10	x	30	S	100	290,00A2
BM 10	x	35	S	100	340,00A2
BM 10	x	40	S	100	390,00A2
BM 10	x	45	S	100	440,00A2
BM 10	x	50	S	100	485,00A2
BM 10	x	55	S	100	540,00A2
BM 10	x	60	S	100	590,00A2
BM 10	x	65	S	100	640,00A2
BM 10	x	70	S	100	690,00A2
BM 10	x	80	S	100	780,00A2
BM 10	x	90	S	100	880,00A2
BM 10	x	100	S	100	990,00A2
BM 10	x	110	S	100	1080,00A2
BM 10	x	120	S	50	1180,00A2
BM 10	x	130	S	50	1270,00A2
BM 10	x	140	S	50	1370,00A2
BM 10	x	150	S	50	1460,00A2
BM 10	x	160	S	50	1560,00A2
BM 10	x	170	S	50	1650,00A2
BM 10	x	180	S	25	1750,00A2
BM 10	x	190	S	25	1840,00A2
BM 10	x	200	S	25	1950,00A2
BM 10	x	250	S	25	2430,00A2
BM 10	x	300	S	10	2950,00A2
BM 10	x	500	S	10	4850,00A2
BM 12	x	30	S	100	285,00A2
BM 12	x	35	S	100	330,00A2
BM 12	x	40	S	100	380,00A2
BM 12	x	45	S	100	425,00A2
BM 12	x	50	S	100	470,00A2
BM 12	x	55	S	100	530,00A2
BM 12	x	60	S	100	570,00A2
BM 12	x	65	S	50	620,00A2
BM 12	x	70	S	50	670,00A2
BM 12	x	80	S	50	760,00A2
BM 12	x	90	S	50	860,00A2
BM 12	x	100	S	50	950,00A2
BM 12	x	110	S	50	1050,00A2
BM 12	x	120	S	50	1140,00A2
BM 12	x	130	S	50	1240,00A2
BM 12	x	140	S	25	1330,00A2
BM 12	x	150	S	25	1420,00A2
BM 12	x	160	S	25	1520,00A2
BM 12	x	170	S	25	1610,00A2
BM 12	x	180	S	25	1710,00A2
BM 12	x	190	S	25	1800,00A2
BM 12	x	200	S	25	1900,00A2
BM 12	x	250	S	10	2370,00A2
BM 12	x	300	S	10	2850,00A2
BM 12	x	500	S	10	4750,00A2
BM 16	x	40	S	50	610,00A2
BM 16	x	50	S	50	760,00A2
BM 16	x	60	S	50	910,00A2
BM 16	x	70	S	25	1080,00A2
BM 16	x	80	S	25	1240,00A2
BM 16	x	90	S	25	1390,00A2
BM 16	x	100	S	25	1540,00A2
BM 16	x	110	S	25	1690,00A2
BM 16	x	120	S	25	1840,00A2
BM 16	x	130	S	10	1990,00A2
BM 16	x	140	S	10	2140,00A2
BM 16	x	150	S	10	2290,00A2
BM 16	x	160	S	10	2450,00A2
BM 16	x	170	S	10	2600,00A2
BM 16	x	180	S	10	2750,00A2
BM 16	x	190	S	10	2900,00A2
BM 16	x	200	S	10	3050,00A2
BM 16	x	250	S	10	3850,00A2
BM 16	x	300	S	10	4600,00A2

Abmessungen	VE	Stück	€/100/Obf.
BM 16 x 500	S	5	7600,00A2
BM 20 x 40	S	25	1010,00A2
BM 20 x 50	S	25	1270,00A2
BM 20 x 60	S	25	1520,00A2
BM 20 x 70	S	25	1760,00A2
BM 20 x 80	S	10	2010,00A2
BM 20 x 90	S	10	2260,00A2
BM 20 x 100	S	10	2550,00A2
BM 20 x 110	S	10	2800,00A2
BM 20 x 120	S	10	3050,00A2
BM 20 x 130	S	10	3300,00A2
BM 20 x 140	S	10	3550,00A2
BM 20 x 150	S	10	3800,00A2
BM 20 x 160	S	10	4050,00A2
BM 20 x 170	S	10	4300,00A2
BM 20 x 180	S	10	4550,00A2
BM 20 x 190	S	10	4850,00A2
BM 20 x 200	S	10	5100,00A2
BM 20 x 250	S	5	6300,00A2
BM 20 x 300	S	5	7600,00A2
BM 20 x 500	S	1	12700,00A2

DIN	00976.942
976-1	A 4 Form B

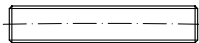

Gewindebolzen, B = mit Kegeln

Werkstoffeigensch. → **TI-236**



BM 8 x 16	S	100	208,00A4
BM 8 x 20	S	100	265,00A4
BM 8 x 25	S	100	325,00A4
BM 8 x 30	S	100	390,00A4
BM 8 x 35	S	100	455,00A4
BM 8 x 40	S	100	520,00A4
BM 8 x 45	S	100	590,00A4
BM 8 x 50	S	100	660,00A4
BM 8 x 55	S	100	720,00A4
BM 8 x 60	S	100	780,00A4
BM 8 x 65	S	100	850,00A4
BM 8 x 70	S	100	920,00A4
BM 8 x 80	S	100	1040,00A4
BM 8 x 90	S	100	1180,00A4
BM 8 x 100	S	100	1310,00A4
BM 8 x 110	S	100	1430,00A4
BM 8 x 120	S	100	1560,00A4
BM 8 x 130	S	100	1700,00A4
BM 8 x 140	S	50	1830,00A4
BM 8 x 150	S	50	1960,00A4
BM 8 x 160	S	50	2080,00A4
BM 8 x 170	S	50	2210,00A4
BM 8 x 180	S	50	2330,00A4
BM 8 x 190	S	50	2480,00A4
BM 8 x 200	S	50	2650,00A4
BM 8 x 250	S	25	3300,00A4
BM 8 x 300	S	25	3900,00A4
BM 8 x 500	S	10	6600,00A4
BM 10 x 20	S	100	300,00A4
BM 10 x 25	S	100	375,00A4
BM 10 x 30	S	100	450,00A4
BM 10 x 35	S	100	530,00A4
BM 10 x 40	S	100	600,00A4
BM 10 x 45	S	100	680,00A4

Abmessungen	VE	Stück	€/100/Obf.
BM 10 x 50	S	100	750,00A4
BM 10 x 55	S	100	820,00A4
BM 10 x 60	S	100	900,00A4
BM 10 x 65	S	100	980,00A4
BM 10 x 70	S	100	1050,00A4
BM 10 x 80	S	100	1200,00A4
BM 10 x 90	S	100	1350,00A4
BM 10 x 100	S	100	1490,00A4
BM 10 x 110	S	100	1640,00A4
BM 10 x 120	S	50	1790,00A4
BM 10 x 130	S	50	1960,00A4
BM 10 x 140	S	50	2100,00A4
BM 10 x 150	S	50	2250,00A4
BM 10 x 160	S	50	2400,00A4
BM 10 x 170	S	50	2550,00A4
BM 10 x 180	S	25	2700,00A4
BM 10 x 190	S	25	2850,00A4
BM 10 x 200	S	25	3000,00A4
BM 10 x 250	S	25	3750,00A4
BM 10 x 300	S	10	4500,00A4
BM 10 x 500	S	10	7500,00A4
BM 12 x 30	S	100	410,00A4
BM 12 x 35	S	100	475,00A4
BM 12 x 40	S	100	550,00A4
BM 12 x 45	S	100	610,00A4
BM 12 x 50	S	100	690,00A4
BM 12 x 55	S	100	750,00A4
BM 12 x 60	S	100	820,00A4
BM 12 x 65	S	50	890,00A4
BM 12 x 70	S	50	960,00A4
BM 12 x 80	S	50	1100,00A4
BM 12 x 90	S	50	1220,00A4
BM 12 x 100	S	50	1370,00A4
BM 12 x 110	S	50	1490,00A4
BM 12 x 120	S	50	1640,00A4
BM 12 x 130	S	50	1770,00A4
BM 12 x 140	S	25	1910,00A4
BM 12 x 150	S	25	2040,00A4
BM 12 x 160	S	25	2190,00A4
BM 12 x 170	S	25	2310,00A4
BM 12 x 180	S	25	2440,00A4
BM 12 x 190	S	25	2600,00A4
BM 12 x 200	S	25	2750,00A4
BM 12 x 250	S	10	3400,00A4
BM 12 x 300	S	10	4100,00A4
BM 12 x 500	S	10	6900,00A4
BM 16 x 40	S	50	970,00A4
BM 16 x 50	S	50	1220,00A4
BM 16 x 60	S	50	1450,00A4
BM 16 x 70	S	25	1680,00A4
BM 16 x 80	S	25	1930,00A4
BM 16 x 90	S	25	2170,00A4
BM 16 x 100	S	25	2420,00A4
BM 16 x 110	S	25	2650,00A4
BM 16 x 120	S	25	2900,00A4
BM 16 x 130	S	10	3150,00A4
BM 16 x 140	S	10	3400,00A4
BM 16 x 150	S	10	3650,00A4
BM 16 x 160	S	10	3850,00A4
BM 16 x 170	S	10	4100,00A4
BM 16 x 180	S	10	4350,00A4
BM 16 x 190	S	10	4600,00A4
BM 16 x 200	S	10	4800,00A4
BM 16 x 250	S	10	6000,00A4
BM 16 x 300	S	10	7300,00A4
BM 16 x 500	S	5	12000,00A4
BM 20 x 40	S	25	1390,00A4
BM 20 x 50	S	25	1750,00A4
BM 20 x 60	S	25	2080,00A4
BM 20 x 70	S	25	2420,00A4
BM 20 x 80	S	10	2800,00A4
BM 20 x 90	S	10	3150,00A4
BM 20 x 100	S	10	3500,00A4
BM 20 x 110	S	10	3800,00A4
BM 20 x 120	S	10	4150,00A4

Abmessungen	VE	Stück	€/100/Obf.
BM 20 x 130	S	10	4500,00A4
BM 20 x 140	S	10	4850,00A4
BM 20 x 150	S	10	5200,00A4
BM 20 x 160	S	10	5600,00A4
BM 20 x 170	S	10	5900,00A4
BM 20 x 180	S	10	6300,00A4
BM 20 x 190	S	10	6700,00A4
BM 20 x 200	S	10	7000,00A4
BM 20 x 250	S	5	8700,00A4
BM 20 x 300	S	5	10400,00A4
BM 20 x 500	S	1	17300,00A4

DIN	00976.956
976-1	A 5 Form A

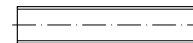

Gewindebolzen, A = ohne Kegeln, Gewindestange 1 Meter

Werkstoffeigensch. → **TI-236**

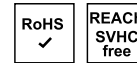

AM 6 x 1000	S	1	1670,00A5
AM 8 x 1000	S	1	2190,00A5
AM 10 x 1000	S	1	3350,00A5
AM 12 x 1000	S	1	4600,00A5
AM 16 x 1000	S	1	8100,00A5
AM 20 x 1000	S	1	11700,00A5
AM 24 x 1000	S	1	18700,00A5

~DIN	00980.924
980	A 2 Form V

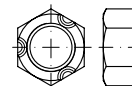

Sechskantmuttern mit Klemnteil, V = Ganzmetallmuttern, einteilig

Form und Maße ~ DIN 934 mit Quetschung

Achtung! Risiko der Kaltverschweißung. Bitte technischen Hinweis im Infoeinblender beachten!

Maße → **TI-9** Normumstellung → **TI-9**

Werkstoffeigensch. → **TI-236**

Stahl → **S. 198**

DIN 980 → wird ersetzt durch ISO 7042

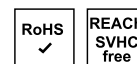

VM 3	S	1000	23,30A2
VM 4	S	1000	47,00A2
VM 5	S	1000	53,00A2
VM 6	S	1000	59,00A2
VM 8	S	500	82,00A2
VM 10	S	500	112,00A2
VM 12	S	250	135,00A2
VM 14	S	100	295,00A2

Abmessungen	VE	Stück	€/100/Obf.
VM 16	S	100	310,00 A2
VM 18	S	50	340,00 A2
VM 20	S	25	355,00 A2
VM 22	S	25	365,00 A2
VM 24	S	25	410,00 A2

~DIN	00980.944
980	A 4 Form V

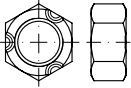

Sechskantmuttern mit Klemmteil, V = Ganzmetallmuttern, einteilig

Form und Maße ~ DIN 934 mit Quetschung

Achtung! Risiko der Kaltverschweißung. Bitte technischen Hinweis im Infoeinblender beachten!

Maße → [TI-9](#) Normumstellung → [TI-9](#)
Werkstoffeigensch. → [TI-236](#)

Stahl → [S. 198](#)

DIN 980 → wird ersetzt durch ISO 7042

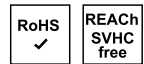

VM 3	S	1000	168,00 A4
VM 4	S	100	208,00 A4
VM 5	S	1000	229,00 A4
VM 5	K	100	233,00 A4
VM 6	S	1000	235,00 A4
VM 6	K	100	240,00 A4
VM 8	S	500	248,00 A4
VM 8	K	100	255,00 A4
VM 10	S	500	370,00 A4
VM 10	K	100	375,00 A4
VM 12	S	250	570,00 A4
VM 12	K	50	580,00 A4
VM 14	S	100	690,00 A4
VM 16	S	100	930,00 A4
VM 16	K	25	940,00 A4
VM 18	S	50	980,00 A4
VM 20	S	25	1240,00 A4
VM 24	S	25	2330,00 A4
VM 30	S	10	3400,00 A4

Abmessungen	VE	Stück	€/100/Obf.
Artikel	84032.927		
84032	A 2 - 70		Biloc

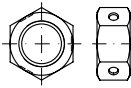

Sechskantmuttern mit Klemmteil, Ganzmetallmuttern

- drei Quetschungen mittig auf Schlüsselfläche
- beidseitig aufschraubbar
- für automatische Zuführungen geeignet
- Maße wie ISO 4032

Achtung! Risiko der Kaltverschweißung. Bitte technischen Hinweis im Infoeinblender beachten!

Maße → [TI-62](#) Werkstoffeigensch. → [TI-236](#)

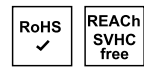

M 6	S	1000	74,00
M 8	S	500	99,00
M 10	S	250	148,00
M 12	S	250	182,00
M 16	S	50	345,00
M 20	S	50	650,00

Abmessungen	VE	Stück	€/100/Obf.
Artikel	84032.948		
84032	A 4 - 80		Biloc

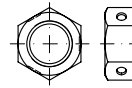

Sechskantmuttern mit Klemmteil, Ganzmetallmuttern

- drei Quetschungen mittig auf Schlüsselfläche
- beidseitig aufschraubbar
- für automatische Zuführungen geeignet
- Maße wie ISO 4032

Achtung! Risiko der Kaltverschweißung. Bitte technischen Hinweis im Infoeinblender beachten!

Maße → [TI-62](#) Werkstoffeigensch. → [TI-236](#)

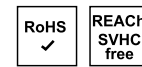

M 6	S	1000	86,00
M 8	S	1000	91,00
M 10	S	500	124,00
M 12	S	500	186,00
M 16	S	100	430,00
M 20	S	50	660,00

Wichtiger Hinweis!

Die gültigen Normen für Sechskantmuttern mit Klemmteil gelten für die Ausführung Stahl in den Festigkeitsklassen 5, (6), 8, 10 bzw. 12. Die Verwendung von Muttern mit Klemmteil aus anderen Werkstoffen (z.B. nichtrostenden Stählen, Messing, Aluminium) erfolgt auf eigenes Risiko. Muttern mit Klemmteil aus diesen weicheren Werkstoffen neigen manchmal wegen des hohen Gewindeflankendrucks beim Einformen des Bolzen- gewindes in den Sicherungsring zum Festfressen. Hier hilft in der Regel die Verwendung eines Schmiermittels. Die veränderten Reibwerte sind beim Anziehen der Verbindung entsprechend zu berücksichtigen.

Abmessungen	VE Stück	€/100/Obf.
~DIN	00982.920	
982	A 2	

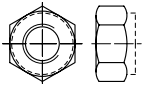

Sechskantmuttern mit Klemmteil, mit nichtmetallischem Einsatz, hohe Form

für Temperatur-Einsatz von -50 bis +120 °C

Achtung! Risiko der Kaltverschweißung. Bitte technischen Hinweis im Infoeinblender beachten!

Maße → TI-9 Normumstellung → TI-9
Werkstoffeigensch. → TI-236

mit wärmostabilisiertem Ring → ISO 7040 S. 560
Stahl → S. 200

DIN 982 → wird ersetzt durch ISO 7040



M 4	S 1000	68,00A2
M 5	S 1000	76,00A2
M 5	K 100	80,00A2
M 6	S 1000	88,00A2
M 6	K 100	92,00A2
M 8	S 500	112,00A2
M 8	K 100	116,00A2
M 10	S 500	194,00A2
M 10	K 100	197,00A2
M 12	S 250	241,00A2
M 12	K 50	248,00A2
M 16	S 100	415,00A2
M 16	K 25	430,00A2
M 20	S 25	790,00A2

Abmessungen	VE Stück	€/100/Obf.
~DIN	00982.940	
982	A 4	

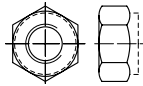

Sechskantmuttern mit Klemmteil, mit nichtmetallischem Einsatz, hohe Form

für Temperatur-Einsatz von -50 bis +120 °C

Achtung! Risiko der Kaltverschweißung. Bitte technischen Hinweis im Infoeinblender beachten!

Maße → TI-9 Normumstellung → TI-9
Werkstoffeigensch. → TI-236

Stahl → S. 200

DIN 982 → wird ersetzt durch ISO 7040



M 4	S 100	116,00A4
M 5	S 100	116,00A4
M 6	S 100	133,00A4
M 8	S 100	175,00A4
M 10	S 100	350,00A4
M 12	S 50	445,00A4
M 16	S 25	770,00A4
M 20	S 25	3150,00A4
M 24	S 25	3600,00A4

Wichtiger Hinweis!

Die gültigen Normen für Sechskantmuttern mit Klemmteil gelten für die Ausführung Stahl in den Festigkeitsklassen 5, (6), 8, 10 bzw. 12. Die Verwendung von Muttern mit Klemmteil aus anderen Werkstoffen (z.B. nichtrostenden Stählen, Messing, Aluminium) erfolgt auf eigenes Risiko. Muttern mit Klemmteil aus diesen weicheren Werkstoffen neigen manchmal wegen des hohen Gewindeflankendrucks beim Einformen des Bolzen-gewindes in den Sicherungsring zum Festfressen. Hier hilft in der Regel die Verwendung eines Schmiermittels. Die veränderten Reibwerte sind beim Anziehen der Verbindung entsprechend zu berücksichtigen.



Abmessungen	VE Stück	€/100/Obf.
~DIN	00985.920	
985	A 2	

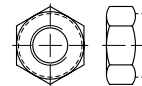

Sechskantmuttern mit Klemmteil, mit nichtmetallischem Einsatz, niedrige Form

für Temperatur-Einsatz von -50 bis +120 °C

Achtung! Risiko der Kaltverschweißung. Bitte technischen Hinweis im Infoeinblender beachten!

Maße → TI-9 Normumstellung → TI-9
Werkstoffeigensch. → TI-236

Stahl → S. 201
Messing → S. 630

DIN 985 → wird ersetzt durch ISO 10511



M 2,5	S 1000	29,50A2
M 3	S 1000	31,00A2
M 3	K 100	38,00A2
M 4	S 1000	24,10A2
M 4	K 100	30,00A2
M 5	S 1000	24,10A2
M 5	K 100	30,00A2
M 6	S 1000	31,50A2
M 6	K 100	38,00A2
M 8	S 500	60,00A2
M 8	K 100	70,00A2
M 10	S 500	118,00A2
M 10	K 50	131,00A2
M 12	S 250	161,00A2
M 12	K 25	192,00A2
M 14	S 250	365,00A2
M 14	K 25	425,00A2
M 16	S 250	385,00A2
M 16	K 25	445,00A2
M 18	S 25	990,00A2
M 20	S 1	1180,00A2
M 22	S 1	1250,00A2
M 24	S 1	1250,00A2
M 27	S 1	4600,00A2
M 30	S 1	4600,00A2
M 36	S 1	9000,00A2

Abmessungen	VE Stück	€/100/Obf.
~DIN	00985.940	
985	A 4	

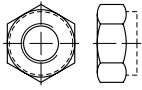

Sechskantmutter mit Klemmteil, mit nichtmetallischem Einsatz, niedrige Form

für Temperatur-Einsatz von -50 bis +120 °C

Achtung! Risiko der Kaltverschweißung. Bitte technischen Hinweis im Infoeinblender beachten!

Maße → **TI-9** Normumstellung → **TI-9**
Werkstoffeigensch. → **TI-236**

Stahl → **S. 201**
Messing → **S. 630**

DIN 985 → wird ersetzt durch ISO 10511



M 3	S 1000	96,00 A4
M 3	K 100	110,00 A4
M 4	S 1000	54,00 A4
M 4	K 100	63,00 A4
M 5	S 1000	54,00 A4
M 5	K 100	63,00 A4
M 6	S 1000	72,00 A4
M 6	K 100	88,00 A4
M 8	S 500	104,00 A4
M 8	K 100	118,00 A4
M 10	S 500	204,00 A4
M 10	K 50	229,00 A4
M 12	S 250	315,00 A4
M 12	K 25	360,00 A4
M 14	S 250	620,00 A4
M 14	K 25	720,00 A4
M 16	S 250	720,00 A4
M 16	K 25	800,00 A4
M 20	S 1	2000,00 A4
M 24	S 1	2100,00 A4
M 27	S 1	6000,00 A4
M 30	S 1	7700,00 A4

Abmessungen	VE Stück	€/100/Obf.
DIN	00985.948	
985	A 4 - 80	

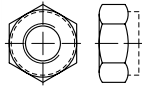

Sechskantmutter mit Klemmteil, mit nichtmetallischem Einsatz, niedrige Form

für Temperatur-Einsatz von -50 bis +120 °C, hochfest (stark kaltverfestigt)

Achtung! Risiko der Kaltverschweißung. Bitte technischen Hinweis im Infoeinblender beachten!

Maße → **TI-9** Normumstellung → **TI-9**
Werkstoffeigensch. → **TI-236**

Stahl → **S. 201**
Messing → **S. 630**

DIN 985 → wird ersetzt durch ISO 10511



M 5	S 1000	81,00 A4
M 6	S 1000	107,00 A4
M 8	S 500	146,00 A4
M 10	S 500	285,00 A4
M 12	S 250	445,00 A4
M 16	S 250	930,00 A4

~DIN	00986.920
986	A 2

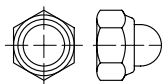

Sechskant-Hutmutter mit Klemmteil, mit nichtmetallischem Einsatz

für Temperatur-Einsatz von -50 bis +120 °C

Achtung! Risiko der Kaltverschweißung. Bitte technischen Hinweis im Infoeinblender beachten!

Maße → **TI-68** Werkstoffeigensch. → **TI-236**
Stahl → **S. 203**



M 4	S 100	86,00 A2
M 5	S 100	86,00 A2
M 6	S 100	105,00 A2
M 8	S 100	110,00 A2
M 10 SW 17	S 100	235,00 A2
M 12 SW 19	S 50	330,00 A2
M 16	S 25	800,00 A2

Abmessungen	VE Stück	€/100/Obf.
~DIN	00988.920	
988	A 2/1.4310	



Passscheiben

Achtung! Toleranzen nach Produktklasse A-B ISO 4759-3/DIN 522.

Werkstoffeigensch. → **TI-236**

Stahl → **S. 203**
Federstahl → **S. 204**

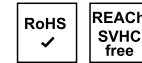

Loch Ø x Außen Ø x Dicke h

6	x	12	x	0,25	S 1000	510,00 A2
6	x	12	x	0,5	S 1000	495,00 A2
6	x	12	x	1	S 1000	650,00 A2
8	x	14	x	0,1	S 1000	580,00 A2
8	x	14	x	0,25	S 1000	495,00 A2
8	x	14	x	0,5	S 1000	495,00 A2
8	x	14	x	1	S 1000	640,00 A2
10	x	16	x	0,1	S 1000	430,00 A2
10	x	16	x	0,25	S 1000	485,00 A2
10	x	16	x	0,5	S 1000	485,00 A2
10	x	16	x	1	S 1000	630,00 A2
12	x	18	x	0,1	S 1000	430,00 A2
12	x	18	x	0,25	S 1000	485,00 A2
12	x	18	x	0,5	S 1000	485,00 A2
12	x	18	x	1	S 1000	630,00 A2
14	x	20	x	1	S 1000	67,00 A2
16	x	22	x	0,1	S 1000	540,00 A2
16	x	22	x	0,25	S 1000	530,00 A2
16	x	22	x	0,5	S 1000	495,00 A2
16	x	22	x	1	S 1000	640,00 A2
18	x	25	x	1	S 1000	640,00 A2
20	x	28	x	0,1	S 1000	570,00 A2
20	x	28	x	0,2	S 1000	600,00 A2
20	x	28	x	0,25	S 1000	530,00 A2
20	x	28	x	0,5	S 1000	510,00 A2
20	x	28	x	1	S 1000	650,00 A2
20	x	28	x	2	S 1000	930,00 A2
25	x	35	x	0,1	S 1000	485,00 A2
25	x	35	x	0,2	S 1000	520,00 A2
25	x	35	x	0,25	S 1000	580,00 A2
25	x	35	x	0,5	S 500	540,00 A2
25	x	35	x	1	S 500	710,00 A2
30	x	42	x	1	S 500	640,00 A2
40	x	50	x	0,2	S 500	209,00 A2
40	x	50	x	0,5	S 100	265,00 A2
40	x	50	x	1	S 100	530,00 A2

Wichtiger Hinweis!



Die gültigen Normen für Sechskantmutter mit Klemmteil gelten für die Ausführung Stahl in den Festigkeitsklassen 5, (6), 8, 10 bzw. 12. Die Verwendung von Muttern mit Klemmteil aus anderen Werkstoffen (z.B. nichtrostenden Stählen, Messing, Aluminium) erfolgt auf eigenes Risiko. Muttern mit Klemmteil aus diesen weicheren Werkstoffen neigen manchmal wegen des hohen Gewindeflankendrucks beim Einführen des Bolzen- gewindes in den Sicherungsring zum Festfressen. Hier hilft in der Regel die Verwendung eines Schmiermittels. Die veränderten Reibwerte sind beim Anziehen der Verbindung entsprechend zu berücksichtigen.

Abmessungen	VE Stück	€/100/Obf.
DIN	01052.924	
1052	A 2	

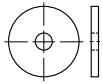

Scheiben für Holzverbinder, starke, runde Ausführung

Maße → **TI-85** Werkstoffeigensch. → **TI-236**
 Stahl → **S. 205**

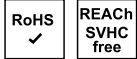

Loch Ø x Außen Ø x Dicke h

14	x	58	x	6	S	25	860,00A2
18	x	68	x	6	S	25	1150,00A2
23	x	80	x	8	S	10	2800,00A2
25	x	92	x	8	S	10	3350,00A2
27	x	105	x	8	S	10	3800,00A2

DIN	01052.944
1052	A 4

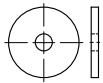

Scheiben für Holzverbinder, starke, runde Ausführung

Maße → **TI-85** Werkstoffeigensch. → **TI-236**
 Stahl → **S. 205**

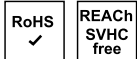

Loch Ø x Außen Ø x Dicke h

14	x	58	x	6	S	25	1310,00A4
18	x	68	x	6	S	25	1790,00A4
23	x	80	x	8	S	10	4350,00A4
25	x	92	x	8	S	10	5300,00A4
27	x	105	x	8	S	10	5900,00A4

Abmessungen	VE Stück	€/100/Obf.
ISO	01207.914	
1207	A 1	gedreht

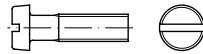

Zylinderschrauben mit Schlitz

Maße → **TI-37** Normumstellung → **TI-11**
 Werkstoffeigensch. → **TI-236**
 Stahl → **S. 205**
 Messing/Kunststoff → **S. 630**

ISO 1207 → ersetzt DIN 84 (austauschbar)

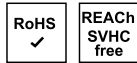

M 1,4	x	3	S	100	105,00A1
M 1,4	x	4	S	100	107,00A1
M 1,4	x	5	S	100	111,00A1
M 1,4	x	6	S	100	117,00A1
M 1,4	x	8	S	100	122,00A1
M 1,4	x	10	S	100	130,00A1
M 1,6	x	3	S	100	30,00A1
M 1,6	x	4	S	100	22,60A1
M 1,6	x	5	S	100	20,90A1
M 1,6	x	6	S	100	19,70A1
M 1,6	x	8	S	100	21,80A1
M 1,6	x	10	S	100	24,10A1
M 1,6	x	12	S	100	33,00A1

ISO	01207.920
1207	A 2

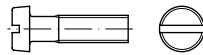

Zylinderschrauben mit Schlitz

zum Teil ab l = 60 mm Teilgewinde

Maße → **TI-37** Normumstellung → **TI-11**
 Werkstoffeigensch. → **TI-236**
 Stahl → **S. 205**
 Messing/Kunststoff → **S. 630**

ISO 1207 → ersetzt DIN 84 (austauschbar)

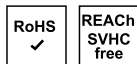





M 1	x	2	S	2000	285,00A2
M 1	x	3	S	2000	290,00A2
M 1	x	4	S	2000	295,00A2
M 1	x	5	S	2000	300,00A2
M 1	x	6	S	2000	310,00A2
M 1	x	8	S	2000	335,00A2
M 1	x	10	S	2000	370,00A2
M 1,2	x	2	S	2000	285,00A2
M 1,2	x	3	S	2000	290,00A2
M 1,2	x	4	S	2000	295,00A2
M 1,2	x	5	S	2000	300,00A2
M 1,2	x	6	S	2000	335,00A2
M 1,2	x	8	S	2000	370,00A2
M 1,2	x	10	S	2000	430,00A2
M 1,2	x	12	S	2000	485,00A2

M 1,4	x	2	S	2000	285,00A2
M 1,4	x	3	S	2000	290,00A2
M 1,4	x	4	S	2000	295,00A2
M 1,4	x	5	S	2000	300,00A2
M 1,4	x	6	S	2000	335,00A2
M 1,4	x	8	S	2000	370,00A2
M 1,4	x	10	S	2000	430,00A2
M 1,4	x	12	S	2000	485,00A2
M 1,6	x	2	S	2000	285,00A2
M 1,6	x	3	S	2000	290,00A2
M 1,6	x	4	S	2000	295,00A2
M 1,6	x	5	S	2000	300,00A2
M 1,6	x	6	S	2000	335,00A2
M 1,6	x	8	S	2000	370,00A2
M 1,6	x	10	S	2000	430,00A2
M 1,6	x	12	S	2000	485,00A2
M 1,6	x	16	S	2000	560,00A2
M 2	x	3	S	1000	7,10A2
M 2	x	4	S	1000	7,20A2
M 2	x	5	S	1000	7,30A2
M 2	x	6	S	1000	7,40A2
M 2	x	8	S	1000	7,80A2
M 2	x	10	S	1000	8,50A2
M 2	x	12	S	1000	9,50A2
M 2	x	16	S	1000	10,30A2
M 2	x	20	S	1000	17,10A2
M 2,5	x	3	S	1000	7,10A2
M 2,5	x	4	S	1000	7,20A2
M 2,5	x	5	S	1000	7,30A2
M 2,5	x	6	S	1000	7,40A2
M 2,5	x	8	S	1000	7,80A2
M 2,5	x	10	S	1000	8,50A2
M 2,5	x	12	S	1000	9,50A2
M 2,5	x	16	S	1000	10,30A2
M 2,5	x	18	S	1000	19,00A2
M 2,5	x	20	S	1000	21,00A2
M 2,5	x	22	S	1000	25,50A2
M 2,5	x	25	S	1000	26,50A2
M 2,5	x	30	S	1000	28,50A2
M 2,5	x	35	S	1000	52,00A2
M 2,5	x	40	S	1000	97,00A2
M 3	x	3	S	1000	19,00A2
M 3	x	4	S	1000	11,60A2
M 3	x	5	S	1000	7,80A2
M 3	x	5	K	200	9,70A2
M 3	x	6	S	1000	5,30A2
M 3	x	6	K	200	7,10A2
M 3	x	8	S	1000	4,55A2
M 3	x	8	K	200	6,50A2
M 3	x	10	S	1000	4,75A2
M 3	x	10	K	200	6,70A2
M 3	x	12	S	1000	5,20A2
M 3	x	12	K	200	7,10A2
M 3	x	14	S	1000	7,40A2
M 3	x	14	K	200	9,30A2
M 3	x	16	S	1000	7,60A2
M 3	x	16	K	200	9,60A2
M 3	x	18	S	1000	8,20A2
M 3	x	18	K	200	10,10A2
M 3	x	20	S	1000	9,00A2
M 3	x	20	K	200	11,20A2
M 3	x	22	S	1000	11,10A2
M 3	x	22	K	200	13,00A2
M 3	x	25	S	1000	11,40A2
M 3	x	25	K	200	13,50A2
M 3	x	30	S	1000	12,10A2
M 3	x	30	K	200	14,00A2
M 3	x	35	S	1000	17,60A2
M 3	x	40	K	200	23,80A2
M 3	x	45	S	500	34,50A2
M 3	x	50	K	200	69,00A2
M 3	x	55	K	200	133,00A2
M 3,5	x	6	K	200	38,00A2
M 3,5	x	8	K	200	31,00A2
M 3,5	x	10	K	200	30,50A2

Abmessungen	VE	Stück	€/100/Obf.
M 3,5 x 12	K	200	32,00A2
M 3,5 x 16	K	200	34,00A2
M 3,5 x 20	K	200	41,00A2
M 3,5 x 25	K	200	62,00A2
M 4 x 4	K	200	21,80A2
M 4 x 5	S	1000	12,50A2
M 4 x 5	K	200	14,40A2
M 4 x 6	S	1000	8,20A2
M 4 x 6	K	200	10,10A2
M 4 x 8	S	1000	8,20A2
M 4 x 8	K	200	10,10A2
M 4 x 10	S	1000	6,70A2
M 4 x 10	K	200	8,60A2
M 4 x 12	S	1000	7,20A2
M 4 x 12	K	200	9,10A2
M 4 x 14	S	1000	10,60A2
M 4 x 16	S	1000	10,90A2
M 4 x 16	K	200	10,10A2
M 4 x 18	S	1000	11,20A2
M 4 x 18	K	200	13,60A2
M 4 x 20	S	1000	11,60A2
M 4 x 20	K	200	14,80A2
M 4 x 22	K	200	17,40A2
M 4 x 25	S	500	12,10A2
M 4 x 25	K	200	18,80A2
M 4 x 30	S	500	12,50A2
M 4 x 30	K	200	19,40A2
M 4 x 35	S	500	21,80A2
M 4 x 35	K	100	23,00A2
M 4 x 40	K	100	28,50A2
M 4 x 45	K	100	31,50A2
M 4 x 50	K	100	41,00A2
M 4 x 55	K	100	57,00A2
M 4 x 60	K	100	61,00A2
M 4 x 70	K	100	66,00A2
M 4 x 80	K	100	82,00A2
M 4 x 90	K	100	115,00A2
M 4 x 100	K	100	165,00A2
M 5 x 6	S	500	17,10A2
M 5 x 8	S	500	12,10A2
M 5 x 8	K	200	14,00A2
M 5 x 10	S	500	10,00A2
M 5 x 10	K	200	11,90A2
M 5 x 12	S	500	10,90A2
M 5 x 12	K	200	12,80A2
M 5 x 14	K	200	15,90A2
M 5 x 16	S	500	12,20A2
M 5 x 16	K	200	16,20A2
M 5 x 18	S	500	13,20A2
M 5 x 18	K	200	16,50A2
M 5 x 20	S	500	13,80A2
M 5 x 20	K	200	16,80A2
M 5 x 22	K	200	17,00A2
M 5 x 25	S	500	15,40A2
M 5 x 25	K	200	17,30A2
M 5 x 30	S	500	18,90A2
M 5 x 30	K	200	20,80A2
M 5 x 35	S	200	20,70A2
M 5 x 35	K	100	24,60A2
M 5 x 40	S	200	28,50A2
M 5 x 40	K	100	32,00A2
M 5 x 45	K	100	36,50A2
M 5 x 50	K	100	45,00A2
M 5 x 55	K	100	71,00A2
M 5 x 60	K	100	73,00A2
M 5 x 70	K	100	77,00A2
M 5 x 80	K	100	83,00A2
M 5 x 90	K	100	118,00A2
M 5 x 100	S	100	241,00A2
M 6 x 8	K	100	19,50A2
M 6 x 10	S	200	15,70A2
M 6 x 10	K	100	19,50A2
M 6 x 12	S	200	13,40A2
M 6 x 12	K	100	17,30A2
M 6 x 16	S	200	15,10A2

Abmessungen	VE	Stück	€/100/Obf.
M 6 x 16	K	100	19,00A2
M 6 x 18	S	200	16,10A2
M 6 x 18	K	100	20,00A2
M 6 x 20	S	200	16,50A2
M 6 x 20	K	100	20,40A2
M 6 x 25	S	200	18,90A2
M 6 x 25	K	100	22,80A2
M 6 x 30	S	200	21,40A2
M 6 x 30	K	100	25,50A2
M 6 x 35	S	100	24,30A2
M 6 x 35	K	50	32,00A2
M 6 x 40	S	100	27,50A2
M 6 x 40	K	50	35,50A2
M 6 x 45	S	100	34,00A2
M 6 x 45	K	50	41,50A2
M 6 x 50	K	50	67,00A2
M 6 x 60	K	50	82,00A2
M 6 x 70	K	50	90,00A2
M 6 x 75	K	50	96,00A2
M 6 x 80	K	50	99,00A2
M 6 x 90	K	50	108,00A2
M 6 x 100	K	50	116,00A2
M 8 x 10	K	50	67,00A2
M 8 x 12	S	100	43,50A2
M 8 x 12	K	50	52,00A2
M 8 x 16	S	100	40,00A2
M 8 x 16	K	50	47,50A2
M 8 x 20	S	100	41,00A2
M 8 x 20	K	50	48,50A2
M 8 x 25	S	100	43,50A2
M 8 x 25	K	50	52,00A2
M 8 x 30	S	100	48,50A2
M 8 x 30	K	50	57,00A2
M 8 x 35	S	100	58,00A2
M 8 x 35	K	50	66,00A2
M 8 x 40	S	100	67,00A2
M 8 x 40	K	50	74,00A2
M 8 x 50	S	100	87,00A2
M 8 x 50	K	50	95,00A2
M 8 x 60	K	50	116,00A2
M 8 x 70	K	50	135,00A2
M 8 x 80	K	50	147,00A2
M 8 x 90	K	50	163,00A2
M 8 x 100	K	50	176,00A2
M 10 x 12	K	50	95,00A2
M 10 x 16	K	50	92,00A2
M 10 x 20	K	50	73,00A2
M 10 x 25	K	50	81,00A2
M 10 x 30	K	50	88,00A2
M 10 x 35	K	50	98,00A2
M 10 x 40	K	50	106,00A2
M 10 x 45	K	50	126,00A2
M 10 x 50	K	50	148,00A2
M 10 x 60	K	50	194,00A2
M 10 x 70	K	25	218,00A2
M 10 x 80	K	25	235,00A2
M 10 x 90	K	25	260,00A2
M 10 x 100	K	25	280,00A2

Abmessungen	VE	Stück	€/100/Obf.
ISO		01207.940	
1207		A 4	
			
Zylinderschrauben mit Schlitz			
zum Teil ab l = 60 mm Teilgewinde			
Maße → TI-37 Normumstellung → TI-11			
Werkstoffeigensch. → TI-236			
Stahl → S. 205			
Messing/Kunststoff → S. 630			
ISO 1207 → ersetzt DIN 84 (austauschbar)			
			
M 2 x 3	S	1000	8,20A4
M 2 x 3	K	200	10,30A4
M 2 x 4	S	1000	8,00A4
M 2 x 4	K	200	10,10A4
M 2 x 5	S	1000	8,10A4
M 2 x 5	K	200	10,20A4
M 2 x 6	S	1000	8,20A4
M 2 x 6	K	200	10,30A4
M 2 x 8	S	1000	8,70A4
M 2 x 8	K	200	10,70A4
M 2 x 10	S	1000	9,40A4
M 2 x 10	K	200	11,50A4
M 2 x 12	S	1000	10,50A4
M 2 x 12	K	200	12,60A4
M 2 x 16	S	1000	11,50A4
M 2 x 16	K	200	13,60A4
M 2 x 20	S	1000	16,40A4
M 2 x 20	K	200	18,50A4
M 2 x 25	K	200	31,50A4
M 2,5 x 3	S	1000	8,20A4
M 2,5 x 3	K	200	10,30A4
M 2,5 x 4	S	1000	8,00A4
M 2,5 x 4	K	200	10,10A4
M 2,5 x 5	S	1000	8,10A4
M 2,5 x 5	K	200	10,20A4
M 2,5 x 6	S	1000	8,20A4
M 2,5 x 6	K	200	10,30A4
M 2,5 x 8	S	1000	8,70A4
M 2,5 x 8	K	200	10,70A4
M 2,5 x 10	S	1000	9,40A4
M 2,5 x 10	K	200	11,50A4
M 2,5 x 12	S	1000	10,50A4
M 2,5 x 12	K	200	12,60A4
M 2,5 x 14	K	200	13,60A4
M 2,5 x 16	S	1000	11,50A4
M 2,5 x 16	K	200	17,10A4
M 2,5 x 18	K	200	18,40A4
M 2,5 x 20	S	1000	16,30A4
M 2,5 x 20	K	200	19,20A4
M 2,5 x 22	K	200	35,50A4
M 2,5 x 25	K	200	37,50A4
M 3 x 3	S	1000	22,50A4
M 3 x 3	K	200	24,60A4
M 3 x 4	S	1000	14,40A4
M 3 x 4	K	200	16,50A4
M 3 x 5	S	1000	11,50A4
M 3 x 5	K	200	13,60A4
M 3 x 6	S	1000	7,30A4
M 3 x 6	K	200	9,40A4
M 3 x 8	S	1000	6,70A4
M 3 x 8	K	200	8,80A4



- ✓ Große Artikelvielfalt
- ✓ Verlässliche Qualität
- ✓ Hohe Lieferbereitschaft

Abmessungen	VE	Stück	€/100/Obf.
M 3 x 10	S	1000	6,10A4
M 3 x 10	K	200	8,20A4
M 3 x 12	S	1000	6,80A4
M 3 x 12	K	200	8,90A4
M 3 x 14	K	200	9,50A4
M 3 x 16	S	1000	7,40A4
M 3 x 16	K	200	10,50A4
M 3 x 18	K	200	12,50A4
M 3 x 20	S	1000	8,30A4
M 3 x 20	K	200	14,40A4
M 3 x 22	K	200	15,80A4
M 3 x 25	S	1000	11,20A4
M 3 x 25	K	200	16,30A4
M 3 x 30	S	1000	15,60A4
M 3 x 30	K	200	17,70A4
M 3 x 35	S	500	28,00A4
M 3 x 35	K	100	32,00A4
M 3 x 40	S	500	33,50A4
M 3 x 40	K	100	38,00A4
M 3 x 50	S	500	61,00A4
M 3 x 50	K	100	65,00A4
M 3 x 55	K	100	98,00A4
M 3 x 60	K	100	120,00A4
M 3,5 x 6	K	100	53,00A4
M 3,5 x 8	K	200	41,50A4
M 3,5 x 10	K	200	40,50A4
M 3,5 x 20	S	500	59,00A4
M 3,5 x 20	K	200	63,00A4
M 4 x 4	K	200	27,00A4
M 4 x 5	S	1000	15,90A4
M 4 x 5	K	200	18,00A4
M 4 x 6	S	1000	10,60A4
M 4 x 6	K	200	12,70A4
M 4 x 8	S	1000	10,30A4
M 4 x 8	K	200	12,40A4
M 4 x 10	S	1000	9,10A4
M 4 x 10	K	200	11,20A4
M 4 x 12	S	1000	9,70A4
M 4 x 12	K	200	11,80A4
M 4 x 16	S	1000	11,20A4
M 4 x 16	K	200	13,30A4
M 4 x 18	S	1000	12,10A4
M 4 x 18	K	200	17,90A4
M 4 x 20	S	1000	13,60A4
M 4 x 20	K	200	19,20A4
M 4 x 22	K	200	21,50A4
M 4 x 25	S	500	14,80A4
M 4 x 25	K	200	22,90A4
M 4 x 30	S	500	16,80A4
M 4 x 30	K	200	24,90A4
M 4 x 35	S	500	24,00A4
M 4 x 35	K	100	28,50A4
M 4 x 40	S	500	30,00A4
M 4 x 40	K	100	34,00A4
M 4 x 45	K	100	40,00A4
M 4 x 50	S	500	42,00A4
M 4 x 50	K	100	46,50A4
M 4 x 55	K	100	72,00A4
M 4 x 60	K	100	75,00A4
M 4 x 70	K	100	89,00A4
M 4 x 80	K	100	95,00A4
M 5 x 6	S	500	18,30A4
M 5 x 6	K	200	20,40A4
M 5 x 8	S	500	17,70A4
M 5 x 8	K	200	19,80A4
M 5 x 10	S	500	15,60A4
M 5 x 10	K	200	17,70A4
M 5 x 12	S	500	15,30A4
M 5 x 12	K	200	17,40A4
M 5 x 16	S	500	17,00A4
M 5 x 16	K	200	19,10A4
M 5 x 18	K	200	20,50A4
M 5 x 20	S	500	19,20A4
M 5 x 20	K	200	21,30A4
M 5 x 25	S	500	21,40A4

Abmessungen	VE	Stück	€/100/Obf.
M 5 x 25	K	200	23,50A4
M 5 x 30	S	500	26,50A4
M 5 x 30	K	200	28,50A4
M 5 x 35	S	200	29,00A4
M 5 x 35	K	100	33,50A4
M 5 x 40	S	200	43,50A4
M 5 x 40	K	100	48,00A4
M 5 x 45	K	100	51,00A4
M 5 x 50	S	200	49,00A4
M 5 x 50	K	100	54,00A4
M 5 x 60	K	100	94,00A4
M 5 x 70	K	100	108,00A4
M 5 x 80	K	100	122,00A4
M 5 x 100	K	100	150,00A4
M 6 x 8	S	200	22,90A4
M 6 x 8	K	100	27,50A4
M 6 x 10	S	200	21,90A4
M 6 x 10	K	100	26,50A4
M 6 x 12	S	200	19,60A4
M 6 x 12	K	100	23,90A4
M 6 x 16	S	200	21,90A4
M 6 x 16	K	100	26,50A4
M 6 x 18	K	100	36,00A4
M 6 x 20	S	200	24,20A4
M 6 x 20	K	100	37,50A4
M 6 x 22	K	100	38,50A4
M 6 x 25	S	200	27,50A4
M 6 x 25	K	100	41,00A4
M 6 x 30	S	200	31,50A4
M 6 x 30	K	100	43,00A4
M 6 x 35	S	100	36,00A4
M 6 x 35	K	50	44,50A4
M 6 x 40	S	100	53,00A4
M 6 x 40	K	50	62,00A4
M 6 x 45	K	50	70,00A4
M 6 x 50	S	100	67,00A4
M 6 x 50	K	50	76,00A4
M 6 x 60	K	50	100,00A4
M 6 x 70	K	50	128,00A4
M 6 x 75	K	50	149,00A4
M 6 x 80	K	50	160,00A4
M 8 x 10	S	100	76,00A4
M 8 x 10	K	50	84,00A4
M 8 x 12	S	100	59,00A4
M 8 x 12	K	50	68,00A4
M 8 x 16	S	100	52,00A4
M 8 x 16	K	50	60,00A4
M 8 x 20	S	100	54,00A4
M 8 x 20	K	50	63,00A4
M 8 x 25	S	100	60,00A4
M 8 x 25	K	50	68,00A4
M 8 x 30	S	100	66,00A4
M 8 x 30	K	50	75,00A4
M 8 x 35	S	100	79,00A4
M 8 x 35	K	50	88,00A4
M 8 x 40	S	100	88,00A4
M 8 x 40	K	50	97,00A4
M 8 x 45	K	50	116,00A4
M 8 x 50	S	100	125,00A4
M 8 x 50	K	50	133,00A4
M 8 x 55	K	50	160,00A4
M 8 x 60	K	50	180,00A4
M 8 x 70	K	50	217,00A4
M 10 x 16	K	50	148,00A4
M 10 x 20	K	50	101,00A4
M 10 x 25	K	50	110,00A4
M 10 x 30	K	50	125,00A4
M 10 x 35	K	50	133,00A4
M 10 x 40	K	50	145,00A4
M 10 x 50	K	50	206,00A4
M 10 x 60	K	50	250,00A4
M 10 x 65	K	50	350,00A4
M 10 x 70	K	50	400,00A4

Abmessungen	VE	Stück	€/100/Obf.
ISO		01234.300	
1234		1.4300/A2	

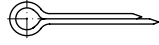

Splinte

Maße → **TI-22** Normumstellung → **TI-10**
 Werkstoffeigensch. → **TI-236**

Stahl → **S. 208**
 Kupfer → **S. 632**

ISO 1234 → ersetzt DIN 94 (austauschbar)

RoHS **REACH SVHC free**

Nenn Ø = Bohrungs Ø x Länge

1	x	8	S	1000	6,90A2
1	x	10	S	1000	7,00A2
1	x	16	S	1000	7,10A2
1	x	20	S	1000	7,20A2
1	x	25	S	1000	8,40A2
1	x	32	S	1000	11,40A2
1,6	x	8	S	1000	8,10A2
1,6	x	10	S	1000	8,20A2
1,6	x	12	S	1000	8,30A2
1,6	x	16	S	1000	8,40A2
1,6	x	20	S	1000	8,50A2
1,6	x	25	S	1000	9,90A2
1,6	x	32	S	1000	11,40A2
2	x	10	S	1000	11,00A2
2	x	12	S	1000	11,20A2
2	x	14	S	1000	11,40A2
2	x	16	S	1000	11,60A2
2	x	20	S	1000	11,80A2
2	x	25	S	1000	13,70A2
2	x	32	S	1000	16,30A2
2	x	40	S	1000	19,00A2
2,5	x	12	S	500	18,40A2
2,5	x	16	S	500	18,90A2
2,5	x	20	S	500	19,90A2
2,5	x	25	S	500	23,30A2
2,5	x	32	S	500	28,50A2
2,5	x	36	S	500	31,00A2
2,5	x	40	S	500	34,00A2
2,5	x	45	S	500	37,50A2
2,5	x	50	S	500	40,50A2
3,2	x	16	S	500	26,00A2
3,2	x	20	S	500	28,00A2
3,2	x	25	S	500	32,00A2
3,2	x	32	S	500	38,50A2
3,2	x	36	S	500	42,50A2
3,2	x	40	S	500	46,00A2
3,2	x	45	S	500	52,00A2
3,2	x	50	S	500	55,00A2
4	x	20	S	500	44,00A2
4	x	25	S	500	52,00A2
4	x	28	S	500	53,00A2
4	x	32	S	500	62,00A2
4	x	36	S	500	68,00A2
4	x	40	S	500	73,00A2
4	x	45	S	500	80,00A2
4	x	50	S	500	88,00A2
4	x	63	S	500	114,00A2
5	x	25	S	250	75,00A2
5	x	28	S	250	76,00A2
5	x	32	S	250	90,00A2
5	x	36	S	250	99,00A2
5	x	40	S	250	106,00A2
5	x	45	S	250	118,00A2

Abmessungen	VE	Stück	€/100/Obf.
5 x 50	S	250	127,00A2
5 x 56	S	250	141,00A2
5 x 63	S	250	156,00A2
5 x 71	S	250	173,00A2
5 x 80	S	250	180,00A2
6,3 x 32	S	250	129,00A2
6,3 x 36	S	250	141,00A2
6,3 x 40	S	250	152,00A2
6,3 x 45	S	250	180,00A2
6,3 x 50	S	250	185,00A2
6,3 x 56	S	250	199,00A2
6,3 x 63	S	250	220,00A2
6,3 x 71	S	250	243,00A2
6,3 x 80	S	250	270,00A2
8 x 36	S	100	285,00A2
8 x 45	S	100	310,00A2
8 x 50	S	100	335,00A2
8 x 56	S	100	365,00A2
8 x 63	S	100	400,00A2
8 x 71	S	100	440,00A2
8 x 80	S	100	485,00A2
10 x 63	S	50	590,00A2
10 x 71	S	50	710,00A2
10 x 80	S	50	770,00A2
10 x 100	S	25	930,00A2

ISO 01234.940

1234 A 4

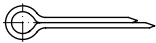

Splinte

Maße → **TI-22** Normumstellung → **TI-10**
 Werkstoffeigensch. → **TI-236**
 Stahl → **S. 208**
 Kupfer → **S.632**

ISO 1234 → ersetzt DIN 94 (austauschbar)



Innen Ø = Bohrungs Ø x Länge

1 x 16	K	100	13,50A4
1 x 20	K	100	15,60A4
1,6 x 10	K	100	13,90A4
1,6 x 12	K	100	14,90A4
1,6 x 16	K	100	18,90A4
1,6 x 20	K	100	23,80A4
1,6 x 25	K	100	27,50A4
1,6 x 32	K	100	31,00A4
2 x 10	K	100	19,30A4
2 x 16	K	100	23,10A4
2 x 20	K	100	27,50A4
2 x 25	K	100	32,00A4
2 x 32	K	100	38,00A4
2 x 40	K	100	46,50A4
2,5 x 20	K	100	42,50A4
2,5 x 25	K	100	54,00A4
2,5 x 32	K	100	60,00A4
3,2 x 16	K	100	46,00A4
3,2 x 20	K	100	55,00A4
3,2 x 25	K	100	62,00A4
3,2 x 32	K	100	70,00A4
3,2 x 36	K	100	78,00A4
3,2 x 40	K	100	86,00A4
3,2 x 45	K	100	95,00A4
3,2 x 50	K	100	107,00A4
3,2 x 63	K	100	128,00A4
4 x 20	K	100	86,00A4

Abmessungen	VE	Stück	€/100/Obf.
4 x 25	K	100	99,00A4
4 x 32	K	100	118,00A4
4 x 40	K	100	143,00A4
4 x 50	K	100	168,00A4
4 x 63	K	100	188,00A4
5 x 32	K	50	185,00A4
5 x 36	K	50	204,00A4
5 x 40	K	50	223,00A4
5 x 50	K	50	265,00A4
5 x 63	K	50	300,00A4
6,3 x 36	K	50	290,00A4
6,3 x 40	K	50	315,00A4
6,3 x 50	K	50	370,00A4
6,3 x 63	K	50	425,00A4
6,3 x 80	K	25	480,00A4
8 x 40	K	25	640,00A4
8 x 45	K	25	680,00A4
8 x 50	K	25	710,00A4
8 x 56	S	25	740,00A4
8 x 80	K	25	920,00A4
8 x 100	K	25	1000,00A4
8 x 140	K	25	1090,00A4
10 x 71	K	25	840,00A4
10 x 80	K	25	870,00A4
10 x 90	K	25	880,00A4
10 x 100	K	25	890,00A4
10 x 112	K	25	910,00A4
10 x 125	K	25	920,00A4
13 x 71	K	25	1260,00A4
13 x 100	K	25	1310,00A4
13 x 125	K	25	1370,00A4
13 x 140	K	25	1430,00A4
13 x 160	K	25	1470,00A4
13 x 180	K	25	1520,00A4
13 x 200	K	25	1580,00A4

DIN 01440.920

1440 A 2

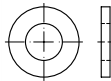

Scheiben für Bolzen

Maße → **TI-85** Normumstellung → **TI-10**
 Werkstoffeigensch. → **TI-236**
 Stahl → **S. 208**

DIN 1440 → wird ersetzt durch ISO 8738

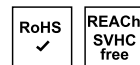

Innen Ø min. = Bolzen Ø x Außen Ø x Dicke

5 x 10 x 0,8	S	500	61,00A2
6 x 12 x 1,6	S	500	74,00A2
8 x 16 x 2	S	200	124,00A2
10 x 20 x 2,5	S	200	169,00A2
12 x 25 x 3	S	200	235,00A2
14 x 28 x 3	S	100	335,00A2
16 x 28 x 3	S	100	345,00A2
18 x 30 x 4	S	100	440,00A2
20 x 32 x 4	S	100	495,00A2
25 x 40 x 4	S	50	660,00A2

Abmessungen	VE	Stück	€/100/Obf.
DIN 01440.940			
1440			A 4

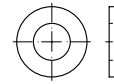

Scheiben für Bolzen

Maße → **TI-85** Normumstellung → **TI-10**
 Werkstoffeigensch. → **TI-236**

Stahl → **S. 208**

DIN 1440 → wird ersetzt durch ISO 8738

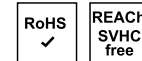

Innen Ø min. = Bolzen Ø x Außen Ø x Dicke

5 x 10 x 0,8	S	500	80,00A4
6 x 12 x 1,6	S	500	94,00A4
8 x 16 x 2	S	200	162,00A4
10 x 20 x 2,5	S	200	235,00A4
12 x 25 x 3	S	200	350,00A4
14 x 28 x 3	S	100	480,00A4
16 x 28 x 3	S	100	490,00A4
18 x 30 x 4	S	100	670,00A4
20 x 32 x 4	S	100	730,00A4
23 x 36 x 4	S	50	940,00A4
25 x 40 x 4	S	50	990,00A4
30 x 45 x 5	S	50	2750,00A4
36 x 52 x 6	S	25	3250,00A4
40 x 58 x 6	S	25	4850,00A4
50 x 68 x 8	S	10	7200,00A4
60 x 80 x 9	S	10	9400,00A4

DIN 01471.910

1471 A 1

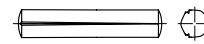

Kegelkerbstifte

Maße → **TI-119** Normumstellung → **TI-10**
 Werkstoffeigensch. → **TI-236**

Stahl → **S. 210**

DIN 1471 → wird ersetzt durch ISO 8744

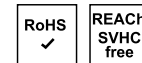

2 x 8	S	100	18,40A1
2 x 10	S	100	19,00A1
2 x 12	S	100	19,50A1
2 x 16	S	100	20,50A1
2 x 18	S	100	21,20A1
2 x 20	S	100	22,00A1
3 x 8	S	100	24,10A1
3 x 10	S	100	25,50A1
3 x 12	S	100	26,00A1
3 x 16	S	100	26,00A1
3 x 18	S	100	26,50A1
3 x 20	S	100	28,00A1
3 x 25	S	100	31,50A1
4 x 8	S	100	28,00A1
4 x 10	S	100	28,50A1
4 x 12	S	100	29,00A1

Abmessungen	VE	Stück	€/100/Obf.
4 x 16	S	100	33,50A1
4 x 18	S	100	35,00A1
4 x 20	S	100	36,00A1
4 x 25	S	100	41,50A1
4 x 30	S	100	45,50A1
4 x 35	S	100	51,00A1
4 x 40	S	100	54,00A1
5 x 8	S	100	70,00A1
5 x 10	S	100	37,50A1
5 x 12	S	100	37,50A1
5 x 16	S	100	45,50A1
5 x 18	S	100	47,50A1
5 x 20	S	100	51,00A1
5 x 25	S	100	58,00A1
5 x 30	S	100	63,00A1
5 x 35	S	100	71,00A1
5 x 40	S	100	76,00A1
6 x 10	S	100	63,00A1
6 x 12	S	100	65,00A1
6 x 16	S	100	71,00A1
6 x 18	S	100	74,00A1
6 x 20	S	100	77,00A1
6 x 25	S	100	88,00A1
6 x 30	S	100	94,00A1
6 x 40	S	100	112,00A1
6 x 45	S	100	120,00A1
6 x 50	S	100	127,00A1
8 x 12	S	100	99,00A1
8 x 16	S	100	105,00A1
8 x 20	S	100	116,00A1
8 x 25	S	100	131,00A1
8 x 30	S	100	141,00A1
8 x 35	S	100	156,00A1
8 x 40	S	100	165,00A1
8 x 45	S	100	178,00A1
8 x 50	S	100	192,00A1
8 x 60	S	100	216,00A1

DIN 01472.910
1472 A 1

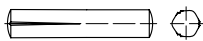

Passkerbstifte

Maße → **TI-118** Normumstellung → **TI-10**
 Werkstoffeigensch. → **TI-236**
 Stahl → **S. 211**
 DIN 1472 → wird ersetzt durch ISO 8745



1,5 x 8	S	100	27,00A1
1,5 x 10	S	100	27,50A1
2 x 8	S	100	28,00A1
2 x 10	S	100	29,00A1
2 x 12	S	100	29,50A1
2 x 14	S	100	30,00A1
2 x 16	S	100	32,50A1
2 x 18	S	100	33,00A1
2 x 20	S	100	37,00A1
3 x 6	S	100	29,00A1
3 x 8	S	100	29,00A1
3 x 10	S	100	30,00A1
3 x 12	S	100	32,50A1
3 x 14	S	100	33,00A1
3 x 16	S	100	35,50A1
3 x 18	S	100	36,00A1

Abmessungen	VE	Stück	€/100/Obf.
3 x 20	S	100	37,50A1
3 x 25	S	100	38,50A1
4 x 8	S	100	32,50A1
4 x 10	S	100	33,50A1
4 x 12	S	100	46,50A1
4 x 14	S	100	48,00A1
4 x 16	S	100	49,50A1
4 x 18	S	100	53,00A1
4 x 20	S	100	53,00A1
4 x 25	S	100	57,00A1
4 x 30	S	100	60,00A1
4 x 40	S	100	64,00A1
5 x 8	S	100	35,00A1
5 x 10	S	100	37,50A1
5 x 12	S	100	37,50A1
5 x 16	S	100	45,50A1
5 x 18	S	100	60,00A1
5 x 20	S	100	65,00A1
5 x 25	S	100	68,00A1
5 x 30	S	100	69,00A1
5 x 35	S	100	71,00A1
5 x 40	S	100	76,00A1
6 x 10	S	100	63,00A1
6 x 16	S	100	71,00A1
6 x 18	S	100	74,00A1
6 x 20	S	100	77,00A1
6 x 25	S	100	88,00A1
6 x 30	S	100	94,00A1
6 x 35	S	100	105,00A1
6 x 40	S	100	112,00A1
6 x 45	S	100	120,00A1
6 x 50	S	100	127,00A1
8 x 10	S	100	94,00A1
8 x 12	S	100	99,00A1
8 x 16	S	100	105,00A1
8 x 18	S	100	110,00A1
8 x 20	S	100	116,00A1
8 x 25	S	100	131,00A1
8 x 30	S	100	141,00A1
8 x 35	S	100	156,00A1
8 x 40	S	100	165,00A1
8 x 45	S	100	178,00A1
8 x 50	S	100	192,00A1
8 x 60	S	100	216,00A1

DIN 01473.910
1473 A 1



Zylinderkerbstifte

Maße → **TI-119** Normumstellung → **TI-10**
 Werkstoffeigensch. → **TI-236**
 Stahl → **S. 211**
 DIN 1473 → wird ersetzt durch ISO 8740



2 x 8	S	100	18,40A1
2 x 10	S	100	19,00A1
2 x 12	S	100	19,50A1
2 x 16	S	100	20,50A1
2 x 18	S	100	21,20A1
2 x 20	S	100	22,00A1
3 x 8	S	100	24,10A1
3 x 10	S	100	25,50A1
3 x 12	S	100	25,50A1

Abmessungen	VE	Stück	€/100/Obf.
3 x 16	S	100	25,50A1
3 x 18	S	100	26,50A1
3 x 20	S	100	28,00A1
3 x 24	S	100	30,00A1
3 x 30	S	100	33,00A1
4 x 8	S	100	28,00A1
4 x 10	S	100	28,50A1
4 x 12	S	100	28,50A1
4 x 16	S	100	33,50A1
4 x 18	S	100	33,50A1
4 x 20	S	100	36,00A1
4 x 24	S	100	40,50A1
4 x 30	S	100	45,50A1
4 x 35	S	100	51,00A1
4 x 40	S	100	54,00A1
5 x 8	S	100	35,00A1
5 x 10	S	100	37,50A1
5 x 12	S	100	37,50A1
5 x 16	S	100	45,50A1
5 x 18	S	100	60,00A1
5 x 20	S	100	65,00A1
5 x 16	S	100	68,00A1
5 x 18	S	100	69,00A1
5 x 20	S	100	71,00A1
5 x 24	S	100	76,00A1
5 x 30	S	100	63,00A1
5 x 35	S	100	71,00A1
5 x 40	S	100	76,00A1
6 x 10	S	100	63,00A1
6 x 12	S	100	65,00A1
6 x 16	S	100	71,00A1
6 x 18	S	100	74,00A1
6 x 20	S	100	77,00A1
6 x 24	S	100	85,00A1
6 x 30	S	100	94,00A1
6 x 35	S	100	105,00A1
6 x 40	S	100	112,00A1
6 x 45	S	100	120,00A1
6 x 50	S	100	127,00A1
8 x 10	S	100	94,00A1
8 x 12	S	100	99,00A1
8 x 16	S	100	105,00A1
8 x 18	S	100	110,00A1
8 x 20	S	100	116,00A1
8 x 25	S	100	131,00A1
8 x 30	S	100	141,00A1
8 x 35	S	100	156,00A1
8 x 40	S	100	165,00A1
8 x 45	S	100	178,00A1
8 x 50	S	100	192,00A1
8 x 60	S	100	216,00A1

Abmessungen	VE Stück	€/100/Obf.
DIN 01476.920		
1476	1.4303 (A 2)	

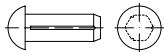

Halbrundkerbnägel

Maße → **TI-120** Normumstellung → **TI-10**
 Werkstoffeigensch. → **TI-236**

Stahl → **S. 213**
 Messing, Aluminium → **S. 632**

DIN 1476 → wird ersetzt durch ISO 8746
 (austauschbar)

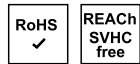

1,4	x	3	S	100	15,00 A2
1,4	x	4	S	100	15,40 A2
1,4	x	5	S	100	15,60 A2
1,4	x	6	S	100	17,10 A2
1,6	x	3	S	100	15,40 A2
1,6	x	4	S	100	16,50 A2
1,6	x	5	S	100	16,90 A2
1,6	x	6	S	100	17,60 A2
2	x	3	S	100	20,50 A2
2	x	4	S	100	20,50 A2
2	x	5	S	100	20,50 A2
2	x	6	S	100	21,80 A2
2	x	8	S	100	23,10 A2
2	x	10	S	100	24,80 A2
2,5	x	4	S	100	21,20 A2
2,5	x	5	S	100	21,60 A2
2,5	x	6	S	100	21,80 A2
2,5	x	8	S	100	22,20 A2
2,5	x	10	S	100	26,00 A2
3	x	4	S	100	25,50 A2
3	x	5	S	100	27,00 A2
3	x	6	S	100	28,50 A2
3	x	8	S	100	35,00 A2
3	x	10	S	100	36,00 A2
3	x	12	S	100	41,50 A2
4	x	6	S	100	46,00 A2
4	x	8	S	100	52,00 A2
4	x	10	S	100	55,00 A2
4	x	12	S	100	63,00 A2
5	x	8	S	100	63,00 A2
5	x	10	S	100	69,00 A2
5	x	12	S	100	78,00 A2
5	x	16	S	100	83,00 A2
6	x	10	S	100	76,00 A2
6	x	12	S	100	84,00 A2

Abmessungen	VE Stück	€/100/Obf.
ISO 91479.923		
1479	A 2	Form C



Sechskant-Blechsrauben, C = mit Spitze

Achtung! Härte werkstoffbedingt nur ~ 250 HV.

Maße → **TI-46** Montage → **TI-251**
 Werkstoffeigensch. → **TI-236** Normumstellung → **TI-11**

Stahl → **S. 214**

Ausführung mit Bund = DIN 6928 auf Anfrage

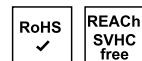

C 2,9	x	9,5	S	1000	10,30 A2
C 2,9	x	13	S	1000	11,60 A2
C 2,9	x	16	S	1000	12,20 A2
C 2,9	x	22	S	1000	16,50 A2
C 2,9	x	25	S	1000	18,60 A2
C 2,9	x	32	S	1000	22,80 A2
C 3,5	x	9,5	S	1000	12,50 A2
C 3,5	x	13	S	1000	12,70 A2
C 3,5	x	16	S	1000	13,50 A2
C 3,5	x	19	S	1000	15,00 A2
C 3,5	x	22	S	1000	17,60 A2
C 3,5	x	25	S	1000	20,30 A2
C 3,5	x	32	S	1000	24,30 A2
C 3,5	x	38	S	1000	27,00 A2
C 3,9	x	9,5	S	1000	14,60 A2
C 3,9	x	13	S	1000	14,40 A2
C 3,9	x	16	S	1000	15,20 A2
C 3,9	x	19	S	1000	15,60 A2
C 3,9	x	22	S	500	20,10 A2
C 3,9	x	25	S	500	22,40 A2
C 3,9	x	32	S	500	26,00 A2
C 4,2	x	9,5	S	1000	15,90 A2
C 4,2	x	13	S	1000	15,60 A2
C 4,2	x	16	S	1000	16,10 A2
C 4,2	x	19	S	1000	17,60 A2
C 4,2	x	22	S	500	22,60 A2
C 4,2	x	25	S	500	23,10 A2
C 4,2	x	32	S	500	28,50 A2
C 4,2	x	38	S	500	32,00 A2
C 4,2	x	45	S	500	39,00 A2
C 4,2	x	50	S	500	46,00 A2
C 4,8	x	13	S	1000	19,90 A2
C 4,8	x	16	S	1000	21,40 A2
C 4,8	x	19	S	1000	22,60 A2
C 4,8	x	22	S	1000	25,50 A2
C 4,8	x	25	S	1000	28,00 A2
C 4,8	x	32	S	500	34,50 A2
C 4,8	x	38	S	500	37,00 A2
C 4,8	x	45	S	500	47,50 A2
C 4,8	x	50	S	250	56,00 A2
C 5,5	x	13	S	500	31,50 A2
C 5,5	x	16	S	500	32,50 A2
C 5,5	x	19	S	500	34,50 A2
C 5,5	x	22	S	500	39,50 A2
C 5,5	x	25	S	250	43,00 A2
C 5,5	x	32	S	250	49,50 A2
C 5,5	x	38	S	250	56,00 A2
C 5,5	x	45	S	250	63,00 A2
C 5,5	x	50	S	250	69,00 A2
C 6,3	x	13	S	250	45,50 A2
C 6,3	x	16	S	500	45,50 A2

Abmessungen	VE Stück	€/100/Obf.			
C 6,3	x	19	S	500	48,50 A2
C 6,3	x	22	S	500	55,00 A2
C 6,3	x	25	S	500	59,00 A2
C 6,3	x	32	S	250	65,00 A2
C 6,3	x	38	S	250	72,00 A2
C 6,3	x	45	S	250	81,00 A2
C 6,3	x	50	S	250	87,00 A2
C 6,3	x	60	S	100	106,00 A2
C 6,3	x	70	S	100	148,00 A2
C 8	x	16	S	100	86,00 A2
C 8	x	19	S	100	95,00 A2
C 8	x	22	S	250	97,00 A2
C 8	x	25	S	100	148,00 A2
C 8	x	32	S	100	157,00 A2
C 8	x	38	S	100	211,00 A2
C 8	x	45	S	100	285,00 A2
C 8	x	50	S	100	390,00 A2
C 8	x	60	S	100	530,00 A2

Abmessungen	VE Stück	€/100/Obf.
DIN 01480.924		
1480	A 2	SP-AE



Spannschlösser, geschmiedet, offene Form, AE = mit 2 Anschweißenden

Maße → **TI-82** Werkstoffeigensch. → **TI-236**

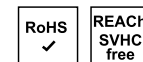

SP-AE M 12	S	1	9500,00 A2
SP-AE M 16	S	1	20300,00 A2
SP-AE M 20	S	1	27500,00 A2

Abmessungen	VE Stück	€/100/Obf.
DIN 01480.925		
1480	A 2	SP-RR

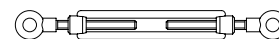

Spannschlösser, geschmiedet, offene Form, RR = mit 2 Ringösen

Maße → **TI-82** Werkstoffeigensch. → **TI-236**

Stahl → **S. 215**

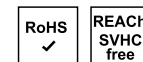

SP-RR M 6	S	1	2850,00 A2
SP-RR M 8	S	1	4100,00 A2
SP-RR M 10	S	1	6100,00 A2
SP-RR M 12	S	1	9500,00 A2
SP-RR M 16	S	1	19700,00 A2

Abmessungen	VE Stück	€/100/Obf.
DIN	01481.960	
1481	1.4310	



**Spannstifte (Spannhülsen),
schwere Ausführung**

Achtung! Reduzierte Federkräfte.

Maße → TI-121 Normumstellung → TI-10

Werkstoffeigensch. → TI-236

Federstahl → S. 217

DIN 1481 → wird ersetzt durch ISO 8752

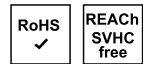

Abmessungen	VE Stück	€/100/Obf.
1 x 4	S 100	16,10
1 x 5	S 100	16,10
1 x 6	S 100	16,10
1 x 8	S 100	16,10
1 x 10	S 100	17,10
1 x 12	S 100	17,50
1 x 14	S 100	18,00
1 x 16	S 100	18,60
1 x 20	S 100	19,90
1,5 x 5	S 100	15,80
1,5 x 6	S 100	16,10
1,5 x 8	S 100	16,10
1,5 x 10	S 100	17,10
1,5 x 12	S 100	17,50
1,5 x 14	S 100	18,00
1,5 x 16	S 100	18,60
1,5 x 18	S 100	19,20
1,5 x 20	S 100	20,50
2 x 4	S 100	16,10
2 x 5	S 100	16,10
2 x 6	S 100	16,10
2 x 8	S 100	17,10
2 x 10	S 100	17,60
2 x 12	S 100	18,40
2 x 14	S 100	19,20
2 x 16	S 100	20,10
2 x 18	S 100	20,90
2 x 20	S 100	22,00
2 x 22	S 100	23,10
2 x 24	S 100	24,10
2 x 26	S 100	25,50
2 x 28	S 100	26,50
2 x 30	S 100	28,00
2,5 x 4	S 100	16,50
2,5 x 6	S 100	17,50
2,5 x 8	S 100	18,00
2,5 x 10	S 100	19,20
2,5 x 12	S 100	19,70
2,5 x 14	S 100	20,90
2,5 x 16	S 100	21,80
2,5 x 18	S 100	23,10
2,5 x 20	S 100	24,70
2,5 x 22	S 100	26,00
2,5 x 24	S 100	27,50
2,5 x 26	S 100	29,00
2,5 x 28	S 100	30,50
2,5 x 30	S 100	32,00
3 x 4	S 100	18,00
3 x 5	S 100	19,20
3 x 6	S 100	20,90
3 x 8	S 100	23,10

Abmessungen	VE Stück	€/100/Obf.
3 x 10	S 100	24,80
3 x 12	S 100	27,00
3 x 14	S 100	30,50
3 x 16	S 100	31,50
3 x 18	S 100	33,00
3 x 20	S 100	34,00
3 x 22	S 100	37,50
3 x 24	S 50	41,00
3 x 26	S 50	42,50
3 x 28	S 50	44,50
3 x 30	S 50	47,00
3 x 32	S 50	48,50
3 x 36	S 50	52,00
3 x 40	S 50	54,00
3,5 x 6	S 100	28,00
3,5 x 10	S 100	31,50
3,5 x 12	S 100	35,50
3,5 x 14	S 100	40,00
3,5 x 16	S 100	43,50
3,5 x 18	S 100	46,00
3,5 x 20	S 100	52,00
3,5 x 22	S 100	53,00
3,5 x 24	S 100	58,00
3,5 x 26	S 100	59,00
3,5 x 28	S 100	63,00
3,5 x 30	S 100	66,00
3,5 x 32	S 100	70,00
3,5 x 36	S 100	75,00
3,5 x 40	S 100	85,00
4 x 6	S 100	28,00
4 x 8	S 100	30,50
4 x 10	S 100	31,50
4 x 12	S 100	35,50
4 x 14	S 50	42,00
4 x 16	S 50	45,50
4 x 18	S 50	48,50
4 x 20	S 50	53,00
4 x 22	S 50	55,00
4 x 24	S 50	60,00
4 x 26	S 50	63,00
4 x 28	S 50	65,00
4 x 30	S 50	68,00
4 x 32	S 50	68,00
4 x 36	S 50	77,00
4 x 40	S 50	87,00
4 x 45	S 50	91,00
4 x 50	S 50	105,00
4,5 x 10	S 100	37,50
4,5 x 12	S 100	41,50
4,5 x 14	S 100	45,50
4,5 x 16	S 100	48,50
4,5 x 18	S 100	53,00
4,5 x 20	S 100	58,00
4,5 x 22	S 100	61,00
4,5 x 24	S 100	65,00
4,5 x 26	S 100	69,00
4,5 x 28	S 100	72,00
4,5 x 30	S 100	78,00
4,5 x 32	S 100	82,00
4,5 x 36	S 100	97,00
4,5 x 40	S 100	103,00
4,5 x 45	S 100	112,00
4,5 x 50	S 100	122,00
5 x 6	S 50	36,50
5 x 8	S 50	40,00
5 x 10	S 50	44,00
5 x 12	S 50	49,50
5 x 14	S 50	54,00
5 x 16	S 50	60,00
5 x 18	S 50	65,00
5 x 20	S 50	70,00
5 x 22	S 50	74,00
5 x 24	S 50	79,00
5 x 26	S 50	84,00
5 x 28	S 50	90,00

Abmessungen	VE Stück	€/100/Obf.
5 x 30	S 50	97,00
5 x 32	S 50	101,00
5 x 36	S 50	112,00
5 x 40	S 50	122,00
5 x 45	S 50	131,00
5 x 50	S 50	148,00
5 x 60	S 50	237,00
5 x 70	S 50	310,00
6 x 10	S 25	63,00
6 x 12	S 25	67,00
6 x 14	S 25	70,00
6 x 16	S 25	74,00
6 x 18	S 25	86,00
6 x 20	S 25	99,00
6 x 22	S 25	105,00
6 x 24	S 25	112,00
6 x 26	S 25	120,00
6 x 28	S 25	127,00
6 x 30	S 25	135,00
6 x 32	S 25	144,00
6 x 36	S 25	159,00
6 x 40	S 25	194,00
6 x 45	S 25	222,00
6 x 50	S 25	255,00
6 x 60	S 25	330,00
6 x 70	S 25	365,00
6 x 80	S 25	390,00
10 x 10	S 50	154,00
10 x 12	S 50	159,00
10 x 16	S 50	175,00
10 x 18	S 50	226,00
10 x 20	S 50	226,00
10 x 22	S 50	260,00
10 x 24	S 50	270,00
10 x 28	S 50	290,00
10 x 30	S 10	315,00
10 x 32	S 50	305,00
10 x 36	S 50	365,00
10 x 40	S 50	435,00
10 x 45	S 10	475,00
10 x 50	S 50	520,00
10 x 55	S 10	540,00
10 x 60	S 10	580,00
10 x 65	S 50	610,00
10 x 70	S 50	630,00
10 x 80	S 10	680,00
10 x 90	S 50	710,00
10 x 100	S 50	780,00

Abmessungen	VE Stück	€/100/Obf.
ISO 01580.920		
1580	A 2	

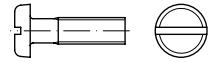

Flachkopfschrauben mit Schlitz

Maße → **TI-37** Normumstellung → **TI-11**
 Werkstoffeigensch. → **TI-236**
 Stahl → **S. 220**
 Messing, Kunststoff → **S. 633**
 ISO 1580 → ersetzt DIN 85 (austauschbar)

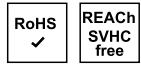

M 3 x 4	S 1000	17,10A2
M 3 x 5	S 1000	11,60A2
M 3 x 6	S 1000	6,40A2
M 3 x 6	K 200	8,30A2
M 3 x 8	S 1000	5,90A2
M 3 x 8	K 200	7,80A2
M 3 x 10	S 1000	5,60A2
M 3 x 10	K 200	7,50A2
M 3 x 12	S 1000	6,10A2
M 3 x 12	K 200	8,00A2
M 3 x 14	S 1000	6,70A2
M 3 x 16	S 1000	6,90A2
M 3 x 16	K 200	8,80A2
M 3 x 20	S 1000	7,60A2
M 3 x 20	K 200	9,50A2
M 3 x 25	K 200	10,20A2
M 3 x 30	S 500	17,10A2
M 3 x 35	K 200	13,10A2
M 4 x 5	S 1000	17,10A2
M 4 x 5	K 200	20,80A2
M 4 x 6	S 1000	11,40A2
M 4 x 8	S 1000	9,10A2
M 4 x 8	K 200	11,00A2
M 4 x 10	S 1000	8,30A2
M 4 x 10	K 200	10,20A2
M 4 x 12	S 1000	8,50A2
M 4 x 12	K 200	10,40A2
M 4 x 16	S 1000	9,10A2
M 4 x 16	K 200	11,00A2
M 4 x 20	S 1000	9,50A2
M 4 x 20	K 200	11,40A2
M 4 x 25	S 500	11,40A2
M 4 x 25	K 200	13,30A2
M 4 x 30	S 500	12,70A2
M 4 x 35	S 500	17,10A2
M 4 x 40	S 500	20,90A2
M 4 x 50	S 500	36,00A2
M 4 x 60	S 500	42,50A2
M 5 x 6	S 500	22,20A2
M 5 x 6	K 100	26,50A2
M 5 x 8	S 500	19,40A2
M 5 x 8	K 200	21,20A2
M 5 x 10	S 500	15,20A2
M 5 x 10	K 200	17,10A2
M 5 x 12	S 500	11,40A2
M 5 x 12	K 200	13,30A2
M 5 x 16	S 500	12,70A2
M 5 x 16	K 200	14,60A2
M 5 x 20	S 500	14,10A2
M 5 x 20	K 200	16,00A2
M 5 x 25	S 500	16,10A2
M 5 x 25	K 100	20,00A2
M 5 x 30	S 500	19,20A2

Abmessungen	VE Stück	€/100/Obf.
M 5 x 30	K 100	23,00A2
M 5 x 35	S 500	27,00A2
M 5 x 40	K 100	34,50A2
M 5 x 45	S 500	37,50A2
M 5 x 50	S 500	46,00A2
M 5 x 60	S 500	55,00A2
M 5 x 70	S 200	67,00A2
M 5 x 80	S 200	95,00A2
M 6 x 8	S 500	22,80A2
M 6 x 10	S 200	17,00A2
M 6 x 10	K 100	20,90A2
M 6 x 12	S 200	15,60A2
M 6 x 12	K 100	19,40A2
M 6 x 16	S 200	16,70A2
M 6 x 16	K 100	20,60A2
M 6 x 20	S 200	18,50A2
M 6 x 20	K 100	22,40A2
M 6 x 25	S 200	20,70A2
M 6 x 25	K 100	24,60A2
M 6 x 30	S 200	24,10A2
M 6 x 30	K 100	28,00A2
M 6 x 35	S 200	33,50A2
M 6 x 40	K 100	35,00A2
M 6 x 45	K 100	40,00A2
M 6 x 50	K 50	81,00A2
M 6 x 60	S 200	124,00A2
M 6 x 70	S 200	148,00A2
M 6 x 80	S 200	180,00A2

Abmessungen	VE Stück	€/100/Obf.
ISO 01580.940		
1580	A 4	

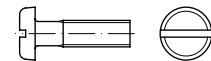

Flachkopfschrauben mit Schlitz

Maße → **TI-37** Normumstellung → **TI-11**
 Werkstoffeigensch. → **TI-236**
 Stahl → **S. 220**
 Messing, Kunststoff → **S. 633**
 ISO 1580 → ersetzt DIN 85 (austauschbar)



M 2 x 3	S 1000	74,00A4
M 2 x 4	S 1000	42,00A4
M 2 x 5	S 1000	41,50A4
M 2 x 6	S 1000	36,00A4
M 2 x 8	S 1000	38,00A4
M 2 x 10	S 1000	40,00A4
M 2 x 12	S 1000	42,00A4
M 2 x 16	S 1000	53,00A4
M 2 x 20	S 1000	59,00A4
M 2 x 25	S 1000	76,00A4
M 2 x 30	S 1000	95,00A4
M 2,5 x 3	S 1000	84,00A4
M 2,5 x 4	S 1000	68,00A4
M 2,5 x 5	S 1000	59,00A4
M 2,5 x 6	S 1000	61,00A4
M 2,5 x 8	S 1000	63,00A4
M 2,5 x 10	S 1000	66,00A4
M 2,5 x 12	S 1000	68,00A4
M 2,5 x 16	S 1000	74,00A4
M 2,5 x 20	S 1000	89,00A4
M 2,5 x 25	S 1000	105,00A4
M 2,5 x 30	S 1000	137,00A4
M 3 x 5	S 1000	14,50A4
M 3 x 5	K 200	16,60A4

Abmessungen	VE Stück	€/100/Obf.
M 3 x 6	S 1000	9,10A4
M 3 x 6	K 200	11,20A4
M 3 x 8	S 1000	8,40A4
M 3 x 8	K 200	10,50A4
M 3 x 10	S 1000	8,00A4
M 3 x 10	K 200	10,10A4
M 3 x 12	S 1000	8,40A4
M 3 x 12	K 200	10,50A4
M 3 x 16	S 1000	9,70A4
M 3 x 16	K 200	11,80A4
M 3 x 20	S 1000	10,30A4
M 3 x 20	K 200	12,40A4
M 3 x 25	K 100	13,30A4
M 3 x 30	K 100	17,60A4
M 4 x 5	S 1000	23,80A4
M 4 x 5	K 200	26,00A4
M 4 x 6	S 1000	13,50A4
M 4 x 6	K 200	15,60A4
M 4 x 8	S 1000	12,80A4
M 4 x 8	K 200	14,90A4
M 4 x 10	S 1000	11,80A4
M 4 x 10	K 200	13,90A4
M 4 x 12	S 1000	11,60A4
M 4 x 12	K 200	13,70A4
M 4 x 16	S 1000	13,20A4
M 4 x 16	K 200	15,30A4
M 4 x 20	S 1000	15,00A4
M 4 x 20	K 200	17,10A4
M 4 x 25	K 200	19,30A4
M 4 x 30	K 100	24,50A4
M 4 x 35	K 100	37,00A4
M 4 x 40	K 100	41,50A4
M 4 x 45	K 100	54,00A4
M 4 x 50	K 100	50,00A4
M 5 x 8	S 500	24,20A4
M 5 x 8	K 200	28,50A4
M 5 x 10	S 500	19,60A4
M 5 x 10	K 200	21,70A4
M 5 x 12	S 500	18,60A4
M 5 x 12	K 200	20,70A4
M 5 x 16	S 500	20,60A4
M 5 x 16	K 200	22,70A4
M 5 x 20	S 500	23,50A4
M 5 x 20	K 200	26,00A4
M 5 x 25	S 500	26,50A4
M 5 x 25	K 100	31,00A4
M 5 x 30	S 500	32,00A4
M 5 x 30	K 100	36,00A4
M 5 x 40	K 100	49,00A4
M 5 x 50	K 100	102,00A4
M 6 x 8	K 100	42,00A4
M 6 x 10	S 200	26,50A4
M 6 x 10	K 100	31,00A4
M 6 x 12	S 200	24,00A4
M 6 x 12	K 100	28,50A4
M 6 x 16	S 200	26,50A4
M 6 x 16	K 100	31,00A4
M 6 x 20	S 200	30,00A4
M 6 x 20	K 100	34,00A4
M 6 x 25	S 200	33,00A4
M 6 x 25	K 100	37,00A4
M 6 x 30	S 200	41,50A4
M 6 x 30	K 100	45,50A4
M 6 x 35	K 50	48,00A4
M 6 x 40	K 50	53,00A4
M 6 x 50	K 50	116,00A4
M 8 x 10	K 50	98,00A4
M 8 x 12	K 50	94,00A4
M 8 x 16	K 50	96,00A4
M 8 x 20	K 50	98,00A4
M 8 x 25	K 50	103,00A4

Abmessungen	VE Stück	€/100/Obf.
DIN	01587.920	
1587	A 2	

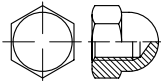

Sechskant-Hutmuttern, hohe Form

ab M 12 mit Rille oder entsprechender Einschraubtiefe t min.

Maße → **TI-63** Werkstoffeigensch. → **TI-236**
 Stahl → **S. 221**
 Messing, Kunststoff → **S. 633**

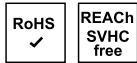

M 4	S	1000	42,00A2
M 4	K	100	51,00A2
M 5	S	1000	48,50A2
M 5	K	50	63,00A2
M 6	S	500	55,00A2
M 6	K	50	70,00A2
M 8	S	500	103,00A2
M 8	K	50	114,00A2
M 10 SW 17	S	250	195,00A2
M 10 SW 17	K	25	231,00A2
M 12 SW 19	S	200	345,00A2
M 12 SW 19	K	25	385,00A2
M 14 SW 22	S	10	550,00A2
M 16	S	10	580,00A2
M 20	S	1	1120,00A2
M 24	S	1	2650,00A2
M 27	S	1	8600,00A2
M 30	S	1	10500,00A2

Abmessungen	VE Stück	€/100/Obf.
DIN	01587.940	
1587	A 4	

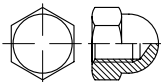

Sechskant-Hutmuttern, hohe Form

ab M 12 mit Rille oder entsprechender Einschraubtiefe t min.

Maße → **TI-63** Werkstoffeigensch. → **TI-236**
 Stahl → **S. 221**
 Messing, Kunststoff → **S. 633**

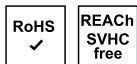

M 3	S	100	97,00A4
M 4	S	100	97,00A4
M 5	S	1000	105,00A4
M 5	K	50	110,00A4
M 6	S	500	128,00A4
M 6	K	50	145,00A4
M 8	S	500	177,00A4
M 8	K	50	193,00A4
M 10 SW 17	S	250	360,00A4
M 10 SW 17	K	25	390,00A4
M 12 SW 19	S	200	570,00A4
M 12 SW 19	K	25	600,00A4

Abmessungen	VE Stück	€/100/Obf.	
M 14 SW 22	S	10	960,00A4
M 16	S	10	1100,00A4
M 18	S	10	2100,00A4
M 20	S	1	1790,00A4
M 24	S	1	3500,00A4
M 27	S	1	12200,00A4

Abmessungen	VE Stück	€/100/Obf.
EN	01661.920	
1661	A 2	

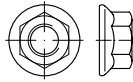

Sechskantmuttern mit Flansch

Maße → **TI-64** Anziehmomente → **TI-249**
 Werkstoffeigensch. → **TI-236** Normumstellung → **TI-7**
 Stahl → **S. 222**

EN 1661 → ersetzt DIN 6923

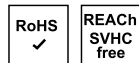

M 4	S	1000	16,10A2
M 5	S	1000	24,30A2
M 6	S	1000	39,00A2
M 8	S	1000	49,50A2
M 10	S	500	73,00A2
M 12	S	250	152,00A2

Abmessungen	VE Stück	€/100/Obf.
EN	01661.940	
1661	A 4	

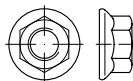

Sechskantmuttern mit Flansch

Maße → **TI-64** Anziehmomente → **TI-249**
 Werkstoffeigensch. → **TI-236** Normumstellung → **TI-7**
 Stahl → **S. 222**

EN 1661 → ersetzt DIN 6923

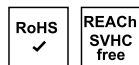

M 5	S	1000	55,00A4
M 6	S	1000	71,00A4
M 8	S	1000	81,00A4
M 10	S	500	189,00A4

Abmessungen	VE Stück	€/100/Obf.
EN	01665.920	
1665	A 2	

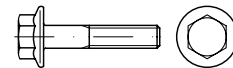

Sechskantschrauben mit Flansch, schwere Reihe

Maße → **TI-17** Anziehmomente → **TI-249**
 Werkstoffeigensch. → **TI-236** Normumstellung → **TI-6**

Stahl → **S. 223**

EN 1665 → ersetzt DIN 6921



M 5	x	10	S	200	33,50A2
M 5	x	12	S	200	34,50A2
M 5	x	16	S	200	36,00A2
M 5	x	20	S	200	37,00A2
M 5	x	25	S	200	39,50A2
M 5	x	30	S	200	42,50A2
M 6	x	10	S	200	42,50A2
M 6	x	12	S	200	44,00A2
M 6	x	16	S	200	46,50A2
M 6	x	20	S	200	48,50A2
M 6	x	25	S	200	53,00A2
M 6	x	30	S	200	55,00A2
M 6	x	35	S	200	60,00A2
M 6	x	40	S	200	63,00A2
M 6	x	45	S	200	66,00A2
M 8	x	16	S	200	83,00A2
M 8	x	20	S	200	86,00A2
M 8	x	25	S	200	91,00A2
M 8	x	30	S	200	99,00A2
M 8	x	35	S	200	105,00A2
M 8	x	40	S	200	110,00A2
M 8	x	45	S	200	116,00A2
M 8	x	50	S	200	124,00A2
M 10	x	20	S	100	124,00A2
M 10	x	25	S	100	133,00A2
M 10	x	30	S	100	141,00A2
M 10	x	35	S	100	150,00A2
M 10	x	40	S	100	161,00A2
M 10	x	45	S	100	171,00A2
M 10	x	50	S	100	180,00A2
M 10	x	60	S	100	199,00A2

Abmessungen	VE Stück	€/100/Obf.
DIN	01804.920	
1804	A 2	

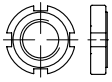

Nutmuttern

Maße → TI-74

Werkstoffeigensch. → TI-236

Stahl → S. 224



M 14	x	1,5	S	1	3350,00A2
M 16	x	1,5	S	1	3750,00A2
M 18	x	1,5	S	1	3850,00A2
M 20	x	1,5	S	1	3950,00A2
M 24	x	1,5	S	1	7000,00A2
M 30	x	1,5	S	1	7700,00A2
M 40	x	1,5	S	1	10300,00A2
M 42	x	1,5	S	1	11200,00A2
M 45	x	1,5	S	1	11600,00A2
M 50	x	1,5	S	1	12700,00A2

ISO	02009.920
2009	A 2

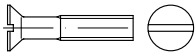

Senkschrauben mit Schlitz

Maße → TI-27

Normumstellung → TI-11

Werkstoffeigensch. → TI-236

Stahl → S. 225

Messing, Kunststoff → S. 634

ISO 2009 → ersetzt DIN 963

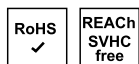

M 1	x	2	S	1000	285,00A2
M 1	x	3	S	1000	285,00A2
M 1	x	4	S	1000	285,00A2
M 1	x	5	S	1000	285,00A2
M 1,2	x	2	S	1000	285,00A2
M 1,2	x	3	S	1000	285,00A2
M 1,2	x	4	S	1000	285,00A2
M 1,2	x	5	S	1000	305,00A2
M 1,2	x	6	S	1000	335,00A2
M 1,4	x	2	S	1000	285,00A2
M 1,4	x	3	S	1000	285,00A2
M 1,4	x	4	S	1000	285,00A2
M 1,4	x	5	S	1000	305,00A2
M 1,4	x	6	S	1000	335,00A2
M 1,4	x	8	S	1000	370,00A2
M 1,4	x	10	S	1000	430,00A2
M 1,6	x	3	S	1000	105,00A2
M 1,6	x	4	S	1000	105,00A2
M 1,6	x	5	S	1000	124,00A2
M 1,6	x	6	S	1000	133,00A2
M 1,6	x	8	S	1000	142,00A2
M 1,6	x	10	S	1000	152,00A2
M 2	x	3	S	1000	124,00A2

Abmessungen	VE Stück	€/100/Obf.			
M 2	x	4	S	1000	8,80A2
M 2	x	5	S	1000	6,30A2
M 2	x	6	S	1000	6,60A2
M 2	x	8	S	1000	7,00A2
M 2	x	10	S	1000	7,60A2
M 2	x	12	S	1000	8,20A2
M 2	x	16	S	1000	8,80A2
M 2	x	18	S	1000	11,40A2
M 2,5	x	4	S	1000	8,80A2
M 2,5	x	5	S	1000	6,30A2
M 2,5	x	6	S	1000	6,60A2
M 2,5	x	8	S	1000	7,00A2
M 2,5	x	10	S	1000	7,60A2
M 2,5	x	12	S	1000	8,20A2
M 2,5	x	14	S	1000	8,80A2
M 2,5	x	16	S	1000	8,80A2
M 2,5	x	20	S	1000	24,20A2
M 2,5	x	25	S	1000	31,00A2
M 3	x	4	S	1000	48,00A2
M 3	x	5	S	1000	9,60A2
M 3	x	5	K	200	11,50A2
M 3	x	6	S	1000	5,50A2
M 3	x	6	K	200	7,40A2
M 3	x	8	S	1000	5,10A2
M 3	x	8	K	200	7,00A2
M 3	x	10	S	1000	4,65A2
M 3	x	10	K	200	6,60A2
M 3	x	12	S	1000	4,75A2
M 3	x	12	K	200	6,70A2
M 3	x	14	K	200	10,90A2
M 3	x	16	S	1000	5,40A2
M 3	x	16	K	200	7,30A2
M 3	x	20	S	1000	6,30A2
M 3	x	20	K	200	8,20A2
M 3	x	22	S	1000	21,00A2
M 3	x	25	S	1000	7,90A2
M 3	x	25	K	200	9,80A2
M 3	x	30	S	1000	46,50A2
M 3	x	30	K	200	15,60A2
M 3	x	35	S	1000	48,00A2
M 3	x	40	S	1000	61,00A2
M 3	x	45	S	1000	55,00A2
M 3	x	50	S	500	74,00A2
M 3	x	60	S	500	110,00A2
M 3,5	x	8	S	1000	36,00A2
M 3,5	x	10	S	1000	36,50A2
M 3,5	x	12	S	1000	28,50A2
M 3,5	x	16	S	1000	32,50A2
M 4	x	8	S	1000	8,20A2
M 4	x	10	S	1000	7,10A2
M 4	x	12	S	1000	6,60A2
M 4	x	14	S	1000	36,50A2
M 4	x	16	S	1000	6,90A2
M 4	x	20	S	1000	7,80A2
M 4	x	25	S	500	8,80A2
M 4	x	30	S	500	11,80A2
M 4	x	35	S	500	16,00A2
M 4	x	40	S	500	21,80A2
M 4	x	50	S	500	33,50A2
M 5	x	6	S	500	12,90A2
M 5	x	6	K	200	14,80A2
M 5	x	8	S	500	11,30A2
M 5	x	8	K	200	13,20A2
M 5	x	10	S	500	11,30A2
M 5	x	10	K	200	13,20A2
M 5	x	12	S	500	8,40A2
M 5	x	12	K	200	10,30A2
M 5	x	14	K	200	16,40A2
M 5	x	16	S	500	9,70A2
M 5	x	16	K	200	11,60A2
M 5	x	18	S	500	12,40A2
M 5	x	20	S	500	11,20A2
M 5	x	20	K	200	13,10A2
M 5	x	25	S	500	13,20A2
M 5	x	25	K	200	15,10A2

Abmessungen	VE Stück	€/100/Obf.			
M 5	x	30	S	500	14,90A2
M 5	x	30	K	200	16,80A2
M 5	x	35	S	200	18,10A2
M 5	x	35	K	100	22,00A2
M 5	x	40	S	200	23,30A2
M 5	x	40	K	100	27,50A2
M 5	x	45	K	100	33,50A2
M 5	x	50	K	100	42,50A2
M 5	x	60	K	100	64,00A2
M 5	x	65	K	100	88,00A2
M 5	x	70	K	100	88,00A2
M 5	x	80	S	500	99,00A2
M 5	x	90	K	100	125,00A2
M 5	x	100	K	100	142,00A2
M 6	x	8	S	200	20,30A2
M 6	x	8	K	100	24,20A2
M 6	x	10	S	200	13,60A2
M 6	x	10	K	100	17,50A2
M 6	x	12	S	200	13,10A2
M 6	x	12	K	100	17,00A2
M 6	x	16	S	200	12,30A2
M 6	x	16	K	100	16,10A2
M 6	x	18	K	100	26,50A2
M 6	x	20	S	200	13,60A2
M 6	x	20	K	100	17,50A2
M 6	x	25	S	200	15,60A2
M 6	x	25	K	100	19,40A2
M 6	x	30	S	200	18,90A2
M 6	x	30	K	100	22,80A2
M 6	x	35	S	100	22,60A2
M 6	x	35	K	50	30,50A2
M 6	x	40	S	100	29,50A2
M 6	x	40	K	50	37,00A2
M 6	x	45	K	100	43,00A2
M 6	x	50	K	50	53,00A2
M 6	x	55	K	50	78,00A2
M 6	x	60	K	50	78,00A2
M 6	x	65	K	50	87,00A2
M 6	x	70	K	50	87,00A2
M 6	x	80	K	50	95,00A2
M 6	x	90	K	50	125,00A2
M 6	x	100	K	50	190,00A2
M 6	x	110	K	50	345,00A2
M 6	x	120	K	25	380,00A2
M 6	x	130	K	25	485,00A2
M 6	x	140	K	25	570,00A2
M 6	x	160	K	25	670,00A2
M 8	x	12	S	100	30,50A2
M 8	x	16	S	100	31,50A2
M 8	x	20	S	100	32,50A2
M 8	x	25	S	100	39,00A2
M 8	x	30	S	100	41,50A2
M 8	x	35	S	100	46,00A2
M 8	x	40	S	100	51,00A2
M 8	x	45	S	100	64,00A2
M 8	x	50	S	100	67,00A2
M 8	x	55	S	100	93,00A2
M 8	x	60	S	100	97,00A2
M 8	x	70	S	100	102,00A2
M 8	x	80	S	100	111,00A2
M 8	x	90	S	100	119,00A2
M 8	x	100	S	100	194,00A2
M 8	x	110	S	100	340,00A2
M 10	x	16	K	50	124,00A2
M 10	x	20	S	100	63,00A2
M 10	x	20	K	50	71,00A2
M 10	x	25	S	100	72,00A2
M 10	x	25	K	50	79,00A2
M 10	x	30	S	100	80,00A2
M 10	x	30	K	50	88,00A2
M 10	x	35	S	100	89,00A2
M 10	x	35	K	50	96,00A2
M 10	x	40	S	100	97,00A2
M 10	x	40	K	50	105,00A2
M 10	x	50	S	100	114,00A2

Abmessungen	VE	Stück	€/100/Obf.
M 10 x 50	K	50	121,00A2
M 10 x 60	S	100	148,00A2
M 10 x 60	K	50	155,00A2
M 10 x 70	S	50	190,00A2
M 10 x 80	S	50	219,00A2
M 10 x 90	K	50	237,00A2
M 10 x 100	K	50	335,00A2
M 10 x 120	K	25	760,00A2
M 10 x 130	K	25	800,00A2
M 10 x 140	K	25	800,00A2

ISO	02009.940
2009	A 4



Senkschrauben mit Schlitz

Maße → **TI-27** Normumstellung → **TI-11**
 Werkstoffeigensch. → **TI-236**
 Stahl → **S. 225**
 Messing, Kunststoff → **S. 634**
 ISO 2009 → ersetzt DIN 963

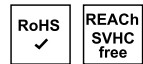

M 2 x 3	S	1000	179,00A4
M 2 x 4	S	1000	9,70A4
M 2 x 4	K	200	11,80A4
M 2 x 5	S	1000	7,00A4
M 2 x 5	K	200	9,10A4
M 2 x 6	S	1000	7,30A4
M 2 x 6	K	200	9,40A4
M 2 x 8	S	1000	7,70A4
M 2 x 8	K	200	9,80A4
M 2 x 10	S	1000	8,40A4
M 2 x 10	K	200	10,50A4
M 2 x 12	S	1000	9,10A4
M 2 x 12	K	200	11,20A4
M 2 x 16	S	1000	9,70A4
M 2 x 16	K	200	11,80A4
M 2 x 20	S	1000	12,80A4
M 2 x 20	K	200	14,90A4
M 2,5 x 4	S	1000	9,70A4
M 2,5 x 4	K	200	11,80A4
M 2,5 x 5	S	1000	7,00A4
M 2,5 x 5	K	200	9,10A4
M 2,5 x 6	S	1000	7,30A4
M 2,5 x 6	K	200	9,40A4
M 2,5 x 8	S	1000	7,70A4
M 2,5 x 8	K	200	9,80A4
M 2,5 x 10	S	1000	8,40A4
M 2,5 x 10	K	200	10,50A4
M 2,5 x 12	S	1000	9,10A4
M 2,5 x 12	K	200	11,20A4
M 2,5 x 16	S	1000	9,70A4
M 2,5 x 16	K	200	11,80A4
M 2,5 x 20	K	200	14,90A4
M 3 x 4	S	1000	16,10A4
M 3 x 4	K	200	18,20A4
M 3 x 5	S	1000	13,90A4
M 3 x 5	K	200	16,00A4
M 3 x 6	S	1000	8,30A4
M 3 x 6	K	200	10,40A4
M 3 x 8	S	1000	7,10A4
M 3 x 8	K	200	9,20A4
M 3 x 10	S	1000	6,00A4
M 3 x 10	K	200	8,10A4

Abmessungen	VE	Stück	€/100/Obf.
M 3 x 12	S	1000	6,30A4
M 3 x 12	K	200	8,40A4
M 3 x 16	S	1000	7,30A4
M 3 x 16	K	200	9,40A4
M 3 x 20	S	1000	8,00A4
M 3 x 20	K	200	10,10A4
M 3 x 25	S	1000	11,60A4
M 3 x 25	K	200	13,70A4
M 3 x 30	S	1000	13,00A4
M 3 x 30	K	200	15,00A4
M 3 x 35	S	1000	63,00A4
M 3 x 40	S	1000	80,00A4
M 3 x 40	K	200	33,50A4
M 3 x 45	S	1000	99,00A4
M 3 x 50	S	1000	124,00A4
M 4 x 8	S	1000	11,60A4
M 4 x 10	S	1000	9,80A4
M 4 x 12	S	1000	9,40A4
M 4 x 16	S	1000	9,90A4
M 4 x 20	S	1000	10,90A4
M 4 x 25	S	500	13,50A4
M 4 x 30	S	500	17,80A4
M 4 x 35	S	500	21,40A4
M 4 x 40	S	500	25,00A4
M 4 x 45	S	500	41,50A4
M 4 x 50	S	500	42,00A4
M 4 x 60	S	500	63,00A4
M 5 x 6	S	500	53,00A4
M 5 x 8	S	500	15,00A4
M 5 x 8	K	200	17,10A4
M 5 x 10	S	500	15,00A4
M 5 x 10	K	200	17,10A4
M 5 x 12	S	500	11,70A4
M 5 x 12	K	200	13,80A4
M 5 x 16	S	500	13,60A4
M 5 x 16	K	200	15,70A4
M 5 x 18	K	200	25,50A4
M 5 x 20	S	500	15,90A4
M 5 x 20	K	200	18,00A4
M 5 x 25	S	500	18,30A4
M 5 x 25	K	200	20,40A4
M 5 x 30	S	500	20,90A4
M 5 x 30	K	200	23,00A4
M 5 x 35	S	200	29,00A4
M 5 x 35	K	100	33,50A4
M 5 x 40	S	200	32,50A4
M 5 x 40	K	100	36,50A4
M 5 x 45	K	100	44,50A4
M 5 x 50	K	100	48,50A4
M 5 x 60	K	100	66,00A4
M 5 x 70	K	100	104,00A4
M 5 x 80	K	100	115,00A4
M 5 x 90	K	100	152,00A4
M 5 x 100	K	100	154,00A4
M 6 x 8	S	200	59,00A4
M 6 x 8	K	100	33,50A4
M 6 x 10	S	200	21,40A4
M 6 x 10	K	100	26,00A4
M 6 x 12	S	200	20,70A4
M 6 x 12	K	100	25,00A4
M 6 x 14	S	200	25,50A4
M 6 x 16	S	200	19,90A4
M 6 x 16	K	100	24,20A4
M 6 x 18	K	100	34,50A4
M 6 x 20	S	200	22,90A4
M 6 x 20	K	100	27,50A4
M 6 x 25	S	200	27,00A4
M 6 x 25	K	100	31,00A4
M 6 x 30	S	200	31,00A4
M 6 x 30	K	100	35,50A4
M 6 x 35	S	100	39,50A4
M 6 x 35	K	50	48,00A4
M 6 x 40	S	100	48,50A4
M 6 x 40	K	50	57,00A4
M 6 x 45	S	100	54,00A4

Abmessungen	VE	Stück	€/100/Obf.
M 6 x 45	K	50	62,00A4
M 6 x 50	S	100	57,00A4
M 6 x 50	K	50	65,00A4
M 6 x 55	K	100	80,00A4
M 6 x 60	S	100	71,00A4
M 6 x 60	K	50	80,00A4
M 6 x 65	K	50	126,00A4
M 6 x 70	K	50	127,00A4
M 6 x 80	K	50	150,00A4
M 6 x 90	K	50	187,00A4
M 6 x 100	K	50	450,00A4
M 6 x 110	K	50	580,00A4
M 6 x 120	K	50	600,00A4
M 8 x 12	S	100	84,00A4
M 8 x 16	S	100	48,50A4
M 8 x 20	S	100	50,00A4
M 8 x 25	S	100	57,00A4
M 8 x 30	S	100	62,00A4
M 8 x 35	S	100	70,00A4
M 8 x 40	S	100	78,00A4
M 8 x 45	S	100	93,00A4
M 8 x 50	S	100	104,00A4
M 8 x 55	S	100	115,00A4
M 8 x 60	S	100	117,00A4
M 8 x 70	S	100	182,00A4
M 8 x 80	S	100	221,00A4
M 8 x 90	S	100	300,00A4
M 8 x 100	S	100	305,00A4
M 10 x 16	K	50	174,00A4
M 10 x 20	S	100	97,00A4
M 10 x 20	K	50	106,00A4
M 10 x 25	S	100	111,00A4
M 10 x 25	K	50	119,00A4
M 10 x 30	S	100	124,00A4
M 10 x 30	K	50	132,00A4
M 10 x 35	S	100	137,00A4
M 10 x 35	K	50	145,00A4
M 10 x 40	S	100	150,00A4
M 10 x 40	K	50	159,00A4
M 10 x 45	S	100	163,00A4
M 10 x 45	K	50	172,00A4
M 10 x 50	S	100	176,00A4
M 10 x 50	K	50	185,00A4
M 10 x 60	S	100	227,00A4
M 10 x 60	K	50	238,00A4
M 10 x 70	S	50	350,00A4
M 10 x 70	K	25	370,00A4
M 10 x 80	S	50	420,00A4
M 10 x 90	K	25	520,00A4
M 10 x 100	K	25	620,00A4
M 10 x 110	K	25	830,00A4
M 10 x 120	K	25	920,00A4
M 10 x 130	K	25	1050,00A4
M 10 x 140	K	25	1210,00A4
M 12 x 16	K	25	244,00A4
M 12 x 20	K	25	450,00A4
M 12 x 25	K	25	450,00A4
M 12 x 30	K	25	480,00A4
M 12 x 35	K	25	510,00A4
M 12 x 40	K	25	530,00A4
M 12 x 45	K	25	590,00A4
M 12 x 50	K	25	590,00A4
M 12 x 60	K	25	680,00A4
M 12 x 70	K	25	920,00A4
M 12 x 80	K	25	1070,00A4
M 12 x 90	K	25	1450,00A4
M 12 x 100	K	25	1970,00A4
M 16 x 25	K	1	1590,00A4
M 16 x 30	K	1	1630,00A4
M 16 x 35	K	1	1670,00A4
M 16 x 40	K	1	1730,00A4
M 16 x 45	K	1	1820,00A4
M 16 x 50	K	1	1820,00A4
M 16 x 60	K	1	1910,00A4
M 16 x 70	K	25	2310,00A4

Abmessungen	VE Stück	€/100/Obf.
ISO	02010.920	

2010 A 2



Linsensenschrauben mit Schlitz

Maße → **TI-39** Normumstellung → **TI-11**
 Werkstoffeigensch. → **TI-236**
 Stahl → **S. 227**
 Messing → **S. 635**
 ISO 2010 → ersetzt DIN 964

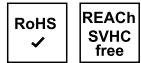

M 3	x	5	K	200	9,70A2
M 3	x	6	S	1000	6,30A2
M 3	x	6	K	200	8,20A2
M 3	x	8	S	1000	5,70A2
M 3	x	8	K	200	7,60A2
M 3	x	10	S	1000	5,20A2
M 3	x	10	K	200	7,10A2
M 3	x	12	S	1000	5,30A2
M 3	x	12	K	200	7,10A2
M 3	x	16	K	200	7,80A2
M 3	x	20	S	1000	7,10A2
M 3	x	20	K	200	8,90A2
M 3	x	25	K	200	10,80A2
M 4	x	6	S	1000	13,50A2
M 4	x	6	K	200	15,40A2
M 4	x	8	S	1000	9,10A2
M 4	x	8	K	200	11,00A2
M 4	x	10	S	1000	7,80A2
M 4	x	10	K	200	9,70A2
M 4	x	12	S	1000	7,30A2
M 4	x	12	K	200	9,20A2
M 4	x	16	S	1000	8,00A2
M 4	x	16	K	200	9,90A2
M 4	x	20	S	1000	8,20A2
M 4	x	20	K	200	10,10A2
M 4	x	25	K	200	11,70A2
M 4	x	30	K	200	14,50A2
M 4	x	35	K	100	23,20A2
M 5	x	8	K	100	20,10A2
M 5	x	10	S	500	12,50A2
M 5	x	10	K	200	14,40A2
M 5	x	12	S	500	9,50A2
M 5	x	12	K	200	11,40A2
M 5	x	16	S	500	10,90A2
M 5	x	16	K	200	12,80A2
M 5	x	18	K	200	19,80A2
M 5	x	20	S	500	12,20A2
M 5	x	20	K	200	14,00A2
M 5	x	25	S	500	14,30A2
M 5	x	25	K	200	16,20A2
M 5	x	30	S	500	16,90A2
M 5	x	30	K	200	18,80A2
M 5	x	35	S	200	20,70A2
M 5	x	35	K	100	24,60A2
M 5	x	40	K	100	31,00A2
M 5	x	45	K	100	34,50A2
M 5	x	50	K	100	43,50A2
M 5	x	60	K	100	64,00A2
M 5	x	70	K	100	92,00A2
M 5	x	80	K	100	102,00A2
M 6	x	10	S	200	15,60A2
M 6	x	10	K	100	19,40A2
M 6	x	12	S	200	15,00A2

Abmessungen	VE Stück	€/100/Obf.
-------------	----------	------------

M 6	x	12	K	100	18,90A2
M 6	x	16	S	200	13,60A2
M 6	x	16	K	100	17,50A2
M 6	x	20	S	200	15,60A2
M 6	x	20	K	100	19,40A2
M 6	x	25	S	200	18,10A2
M 6	x	25	K	100	22,00A2
M 6	x	30	S	200	20,10A2
M 6	x	30	K	100	24,00A2
M 6	x	35	S	100	26,00A2
M 6	x	35	K	50	34,00A2
M 6	x	40	S	100	33,50A2
M 6	x	40	K	50	41,50A2
M 6	x	45	K	50	44,00A2
M 6	x	50	K	50	59,00A2
M 6	x	55	S	100	77,00A2
M 6	x	60	K	50	77,00A2
M 6	x	70	K	50	114,00A2
M 6	x	80	S	50	355,00A2
M 6	x	90	S	50	465,00A2
M 6	x	100	S	50	590,00A2
M 6	x	105	S	50	670,00A2
M 6	x	110	S	50	670,00A2
M 8	x	12	K	50	72,00A2
M 8	x	16	S	100	36,00A2
M 8	x	16	K	50	43,50A2
M 8	x	20	S	100	37,50A2
M 8	x	20	K	50	45,50A2
M 8	x	25	S	100	44,00A2
M 8	x	25	K	50	52,00A2
M 8	x	30	S	100	47,50A2
M 8	x	30	K	50	55,00A2
M 8	x	35	S	100	53,00A2
M 8	x	40	S	100	58,00A2
M 8	x	40	K	50	66,00A2
M 8	x	45	S	100	70,00A2
M 8	x	50	S	100	73,00A2
M 8	x	55	S	100	105,00A2
M 8	x	60	S	100	102,00A2
M 8	x	70	S	100	156,00A2
M 8	x	80	K	50	192,00A2
M 10	x	20	S	100	84,00A2
M 10	x	25	S	100	90,00A2
M 10	x	25	K	50	98,00A2
M 10	x	30	K	50	106,00A2
M 10	x	35	S	100	105,00A2
M 10	x	40	K	50	127,00A2

ISO	02010.940
-----	-----------

2010 A 4



Linsensenschrauben mit Schlitz

Maße → **TI-39** Normumstellung → **TI-11**
 Werkstoffeigensch. → **TI-236**
 Stahl → **S. 227**
 Messing → **S. 635**
 ISO 2010 → ersetzt DIN 964

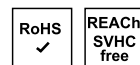

M 2	x	4	K	200	19,60A4
M 2	x	5	K	200	10,70A4
M 2	x	6	K	200	11,20A4
M 2	x	8	K	200	11,80A4
M 2	x	10	K	200	12,70A4

Abmessungen	VE Stück	€/100/Obf.
-------------	----------	------------

M 2	x	12	K	200	13,50A4
M 2	x	20	K	200	46,50A4
M 2,5	x	6	K	200	11,20A4
M 2,5	x	8	K	200	11,80A4
M 2,5	x	10	K	200	12,70A4
M 2,5	x	16	K	200	18,60A4
M 2,5	x	20	K	200	24,20A4
M 3	x	6	S	1000	9,10A4
M 3	x	6	K	200	11,20A4
M 3	x	8	K	200	9,90A4
M 3	x	10	K	200	8,90A4
M 3	x	12	K	200	9,30A4
M 3	x	16	K	200	10,00A4
M 3	x	20	K	200	11,10A4
M 3	x	25	K	200	14,10A4
M 3	x	30	K	200	21,20A4
M 4	x	6	K	200	21,00A4
M 4	x	8	S	1000	13,30A4
M 4	x	8	K	200	15,40A4
M 4	x	10	S	1000	10,90A4
M 4	x	10	K	200	13,00A4
M 4	x	12	K	200	12,60A4
M 4	x	16	S	1000	11,20A4
M 4	x	16	K	200	13,30A4
M 4	x	18	K	200	20,00A4
M 4	x	20	S	1000	12,10A4
M 4	x	20	K	200	14,20A4
M 4	x	25	K	200	17,10A4
M 4	x	30	K	200	21,90A4
M 4	x	35	K	100	32,50A4
M 4	x	40	K	100	43,00A4
M 4	x	45	K	100	56,00A4
M 5	x	10	S	500	16,70A4
M 5	x	10	K	200	18,80A4
M 5	x	12	K	200	15,90A4
M 5	x	16	S	500	15,40A4
M 5	x	16	K	200	17,50A4
M 5	x	20	S	500	16,20A4
M 5	x	20	K	200	18,30A4
M 5	x	25	K	200	21,40A4
M 5	x	30	K	200	27,00A4
M 5	x	35	K	100	36,50A4
M 5	x	40	S	200	40,00A4
M 5	x	40	K	100	44,00A4
M 5	x	50	S	200	86,00A4
M 5	x	50	K	100	90,00A4
M 5	x	60	K	100	112,00A4
M 5	x	70	K	100	137,00A4
M 5	x	80	K	100	152,00A4
M 6	x	10	S	200	24,80A4
M 6	x	10	K	100	29,50A4
M 6	x	12	K	100	28,00A4
M 6	x	16	S	200	22,70A4
M 6	x	16	K	100	27,00A4
M 6	x	20	S	200	26,50A4
M 6	x	20	K	100	31,00A4
M 6	x	25	S	200	31,00A4
M 6	x	25	K	100	35,50A4
M 6	x	30	S	200	35,50A4
M 6	x	30	K	100	40,00A4
M 6	x	35	S	100	44,50A4
M 6	x	40	S	100	59,00A4
M 6	x	40	K	50	68,00A4
M 6	x	50	S	100	90,00A4
M 6	x	50	K	50	99,00A4
M 6	x	60	K	50	105,00A4
M 6	x	70	K	50	153,00A4
M 6	x	80	K	50	182,00A4
M 8	x	16	K	50	65,00A4
M 8	x	20	S	100	59,00A4
M 8	x	20	K	50	68,00A4
M 8	x	25	S	100	65,00A4
M 8	x	25	K	50	73,00A4
M 8	x	30	S	100	73,00A4
M 8	x	40	K	50	99,00A4

Abmessungen	VE	Stück	€/100/Obf.
M 8 x 50	K	50	140,00A4
M 10 x 20	K	50	125,00A4
M 10 x 25	K	50	130,00A4
M 10 x 50	K	50	217,00A4

DIN	02093.960
2093	1.4310/1.4568*



Tellerfedern

*t ≤ 2 mm = 1.4310 or 1.4568; t > 2 mm = 1.4568

Achtung! Reduzierte Federkräfte.

Produktinformation → TI-141

Stahl → S. 227

RoHS	REACH SVHC free
------	-----------------

Außen Ø x Innen Ø x Dicke t

8	x	3,2	x	0,5	S	200	71,00
8	x	4,2	x	0,3	S	200	67,00
8	x	4,2	x	0,4	S	200	69,00
10	x	5,2	x	0,4	S	200	74,00
10	x	5,2	x	0,5	S	200	77,00
12,5	x	6,2	x	0,5	S	200	87,00
12,5	x	6,2	x	0,7	S	200	101,00
15	x	8,2	x	0,8	S	200	118,00
16	x	8,2	x	0,6	S	200	110,00
16	x	8,2	x	0,9	S	200	131,00
18	x	9,2	x	0,7	S	200	131,00
18	x	9,2	x	1	S	200	158,00
20	x	8,2	x	0,5	S	200	124,00
20	x	10,2	x	0,6	S	200	135,00
20	x	10,2	x	0,8	S	200	156,00
20	x	10,2	x	0,9	S	200	165,00
20	x	10,2	x	1	S	200	175,00
20	x	10,2	x	1,1	S	200	182,00
25	x	12,2	x	0,9	S	200	209,00
25	x	12,2	x	1,5	S	200	290,00
28	x	14,2	x	1	S	200	260,00
28	x	14,2	x	1,5	S	200	340,00
31,5	x	16,3	x	1,25	S	200	710,00
31,5	x	16,3	x	1,75	S	200	940,00
31,5	x	16,3	x	2	S	200	970,00
35,5	x	18,3	x	1,25	S	100	870,00
35,5	x	18,3	x	2	S	100	1310,00
40	x	20,4	x	1,5	S	100	1250,00
40	x	20,4	x	2	S	100	1630,00
40	x	20,4	x	2,25	S	100	1820,00

Abmessungen	VE	Stück	€/100/Obf.
ISO	02338.910		
2338	A 1		m6

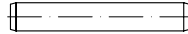

Zylinderstifte, Toleranzfeld m6

Maße → TI-116 Normumstellung → TI-10

Werkstoffeigensch. → TI-236

Stahl → S. 229

ISO 2338 → ersetzt DIN 7

RoHS	REACH SVHC free
------	-----------------

Ø - Tol. x Länge (mit Kuppen)

0,8 m6	x	4	S	500	18,40A1
0,8 m6	x	5	S	500	19,20A1
0,8 m6	x	6	S	500	19,70A1
0,8 m6	x	8	S	500	20,30A1
0,8 m6	x	10	S	500	21,10A1
1 m6	x	3	S	500	13,30A1
1 m6	x	4	S	500	13,70A1
1 m6	x	5	S	500	14,40A1
1 m6	x	6	S	500	14,80A1
1 m6	x	8	S	500	15,20A1
1 m6	x	10	S	500	15,80A1
1 m6	x	12	S	500	16,50A1
1,5 m6	x	3	S	500	14,80A1
1,5 m6	x	4	S	500	15,20A1
1,5 m6	x	5	S	500	15,60A1
1,5 m6	x	6	S	500	15,90A1
1,5 m6	x	8	S	500	16,90A1
1,5 m6	x	10	S	500	17,60A1
1,5 m6	x	12	S	500	18,40A1
1,5 m6	x	14	S	500	19,20A1
1,5 m6	x	16	S	500	20,30A1
1,5 m6	x	18	S	500	33,50A1
1,5 m6	x	20	S	500	33,50A1
2 m6	x	4	S	500	16,30A1
2 m6	x	5	S	500	16,70A1
2 m6	x	6	S	500	17,10A1
2 m6	x	8	S	500	18,80A1
2 m6	x	10	S	500	19,50A1
2 m6	x	12	S	500	20,30A1
2 m6	x	14	S	500	21,10A1
2 m6	x	16	S	500	22,00A1
2 m6	x	18	S	500	22,90A1
2 m6	x	20	S	500	24,80A1
2,5 m6	x	4	S	500	18,40A1
2,5 m6	x	5	S	500	19,00A1
2,5 m6	x	6	S	500	19,50A1
2,5 m6	x	8	S	500	20,30A1
2,5 m6	x	10	S	500	21,10A1
2,5 m6	x	12	S	500	22,20A1
2,5 m6	x	14	S	500	26,00A1
2,5 m6	x	16	S	500	28,00A1
2,5 m6	x	18	S	500	30,50A1
2,5 m6	x	20	S	500	31,50A1
2,5 m6	x	24	S	500	37,50A1
3 m6	x	4	S	200	22,90A1
3 m6	x	5	S	200	23,70A1
3 m6	x	6	S	200	24,50A1
3 m6	x	8	S	200	26,00A1
3 m6	x	10	S	200	27,00A1
3 m6	x	12	S	200	28,50A1
3 m6	x	14	S	200	30,00A1
3 m6	x	16	S	200	30,50A1
3 m6	x	18	S	200	35,50A1
3 m6	x	20	S	200	37,50A1

Abmessungen	VE	Stück	€/100/Obf.
3 m6	x	24	S 200 43,00A1
3 m6	x	28	S 200 49,50A1
3 m6	x	30	S 200 55,00A1
3 m6	x	32	S 200 59,00A1
3 m6	x	40	S 200 105,00A1
3 m6	x	45	S 200 125,00A1
3 m6	x	50	S 200 148,00A1
3 m6	x	60	S 200 380,00A1
4 m6	x	5	S 200 33,00A1
4 m6	x	6	S 200 33,50A1
4 m6	x	8	S 200 36,00A1
4 m6	x	10	S 200 41,00A1
4 m6	x	12	S 200 44,50A1
4 m6	x	14	S 200 51,00A1
4 m6	x	16	S 200 53,00A1
4 m6	x	18	S 200 55,00A1
4 m6	x	20	S 200 61,00A1
4 m6	x	24	S 200 64,00A1
4 m6	x	26	S 200 69,00A1
4 m6	x	28	S 200 76,00A1
4 m6	x	32	S 200 87,00A1
4 m6	x	36	S 200 101,00A1
4 m6	x	40	S 200 106,00A1
4 m6	x	50	S 200 171,00A1
4 m6	x	60	S 200 250,00A1
5 m6	x	5	S 200 36,50A1
5 m6	x	6	S 200 36,50A1
5 m6	x	8	S 200 48,50A1
5 m6	x	10	S 200 49,50A1
5 m6	x	12	S 200 53,00A1
5 m6	x	14	S 200 56,00A1
5 m6	x	16	S 200 58,00A1
5 m6	x	18	S 200 69,00A1
5 m6	x	20	S 200 71,00A1
5 m6	x	24	S 200 77,00A1
5 m6	x	28	S 200 83,00A1
5 m6	x	30	S 200 88,00A1
5 m6	x	32	S 200 97,00A1
5 m6	x	36	S 200 106,00A1
5 m6	x	40	S 200 122,00A1
5 m6	x	45	S 200 141,00A1
5 m6	x	50	S 200 158,00A1
6 m6	x	6	S 200 62,00A1
6 m6	x	8	S 200 65,00A1
6 m6	x	10	S 200 69,00A1
6 m6	x	12	S 200 77,00A1
6 m6	x	14	S 200 80,00A1
6 m6	x	16	S 200 83,00A1
6 m6	x	18	S 200 85,00A1
6 m6	x	20	S 200 88,00A1
6 m6	x	24	S 200 112,00A1
6 m6	x	28	S 200 118,00A1
6 m6	x	30	S 200 135,00A1
6 m6	x	32	S 200 124,00A1
6 m6	x	36	S 200 131,00A1
6 m6	x	40	S 200 163,00A1
6 m6	x	45	S 100 175,00A1
6 m6	x	50	S 100 184,00A1
6 m6	x	55	S 100 199,00A1
6 m6	x	60	S 100 211,00A1
8 m6	x	10	S 100 116,00A1
8 m6	x	12	S 100 120,00A1
8 m6	x	14	S 100 125,00A1
8 m6	x	16	S 100 137,00A1
8 m6	x	18	S 100 144,00A1
8 m6	x	20	S 100 150,00A1
8 m6	x	22	S 100 154,00A1
8 m6	x	24	S 100 158,00A1
8 m6	x	28	S 100 163,00A1
8 m6	x	30	S 100 178,00A1
8 m6	x	32	S 100 180,00A1
8 m6	x	36	S 100 228,00A1
8 m6	x	40	S 100 243,00A1
8 m6	x	45	S 100 260,00A1
8 m6	x	50	S 100 290,00A1

Abmessungen	VE	Stück	€/100/Obf.
8 m6 x 55	S	100	320,00A1
8 m6 x 60	S	100	340,00A1
8 m6 x 70	S	100	400,00A1
8 m6 x 80	S	100	485,00A1
8 m6 x 90	S	100	490,00A1
10 m6 x 10	S	100	173,00A1
10 m6 x 12	S	100	178,00A1
10 m6 x 14	S	100	184,00A1
10 m6 x 16	S	100	190,00A1
10 m6 x 18	S	100	199,00A1
10 m6 x 20	S	100	247,00A1
10 m6 x 24	S	100	265,00A1
10 m6 x 28	S	100	300,00A1
10 m6 x 32	S	100	325,00A1
10 m6 x 36	S	100	345,00A1
10 m6 x 40	S	100	370,00A1
10 m6 x 45	S	50	395,00A1
10 m6 x 50	S	50	450,00A1
10 m6 x 55	S	50	495,00A1
10 m6 x 60	S	50	530,00A1
10 m6 x 70	S	50	590,00A1
10 m6 x 80	S	50	670,00A1
10 m6 x 90	S	50	740,00A1
10 m6 x 100	S	50	910,00A1
12 m6 x 16	S	50	375,00A1
12 m6 x 18	S	50	420,00A1
12 m6 x 20	S	50	450,00A1
12 m6 x 24	S	50	460,00A1
12 m6 x 30	S	50	580,00A1
12 m6 x 32	S	50	660,00A1
12 m6 x 40	S	50	790,00A1
12 m6 x 45	S	50	890,00A1
12 m6 x 50	S	50	970,00A1
12 m6 x 55	S	50	1060,00A1
12 m6 x 60	S	50	1140,00A1
12 m6 x 70	S	10	1350,00A1
12 m6 x 80	S	10	1480,00A1
12 m6 x 90	S	10	1650,00A1
12 m6 x 100	S	10	1800,00A1
16 m6 x 20	S	10	1120,00A1
16 m6 x 24	S	10	1160,00A1
16 m6 x 28	S	10	1290,00A1
16 m6 x 32	S	10	1590,00A1
16 m6 x 36	S	10	2200,00A1
16 m6 x 40	S	10	2370,00A1
16 m6 x 45	S	10	2700,00A1
16 m6 x 50	S	10	2950,00A1
16 m6 x 55	S	10	3250,00A1
16 m6 x 60	S	10	3450,00A1
16 m6 x 70	S	10	3850,00A1
16 m6 x 80	S	10	4100,00A1
16 m6 x 90	S	10	4350,00A1
16 m6 x 100	S	10	4600,00A1

Abmessungen	VE	Stück	€/100/Obf.
ISO 02338.940			
2338	A 4		m6

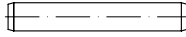

Zylinderstifte, Toleranzfeld m6

Maße → **TI-116** Normumstellung → **TI-10**
 Werkstoffeigensch. → **TI-236**

Stahl → **S. 229**

ISO 2338 → ersetzt DIN 7



Ø - Tol. x Länge (mit Kuppen)

1 m6 x 3	S	500	36,00A4
1 m6 x 4	S	500	36,00A4
1 m6 x 5	S	500	36,00A4
1 m6 x 6	S	500	37,50A4
1 m6 x 8	S	500	40,00A4
1 m6 x 10	S	500	40,50A4
1 m6 x 12	S	500	40,50A4
1,5 m6 x 4	S	500	27,00A4
1,5 m6 x 5	S	500	27,00A4
1,5 m6 x 6	S	500	28,00A4
1,5 m6 x 8	S	500	28,00A4
1,5 m6 x 10	S	500	30,00A4
1,5 m6 x 12	S	500	31,00A4
1,5 m6 x 14	S	500	32,50A4
1,5 m6 x 16	S	500	33,50A4
1,5 m6 x 18	S	500	47,00A4
1,5 m6 x 20	S	500	51,00A4
2 m6 x 5	S	500	29,50A4
2 m6 x 6	S	500	30,00A4
2 m6 x 8	S	500	31,00A4
2 m6 x 10	S	500	33,00A4
2 m6 x 12	S	500	35,50A4
2 m6 x 14	S	500	37,50A4
2 m6 x 16	S	500	40,00A4
2 m6 x 18	S	500	47,00A4
2 m6 x 20	S	500	51,00A4
2 m6 x 24	S	500	58,00A4
2,5 m6 x 4	S	500	30,00A4
2,5 m6 x 5	S	500	31,00A4
2,5 m6 x 6	S	500	33,00A4
2,5 m6 x 8	S	500	35,50A4
2,5 m6 x 10	S	500	37,50A4
2,5 m6 x 12	S	500	40,00A4
2,5 m6 x 14	S	500	42,00A4
2,5 m6 x 16	S	500	44,50A4
2,5 m6 x 18	S	500	47,00A4
2,5 m6 x 20	S	500	51,00A4
2,5 m6 x 24	S	500	58,00A4
3 m6 x 4	S	500	34,50A4
3 m6 x 5	S	500	30,00A4
3 m6 x 6	S	500	38,50A4
3 m6 x 8	S	500	42,00A4
3 m6 x 10	S	500	45,00A4
3 m6 x 12	S	500	49,00A4
3 m6 x 14	S	500	55,00A4
3 m6 x 16	S	500	58,00A4
3 m6 x 18	S	500	66,00A4
3 m6 x 20	S	500	71,00A4
3 m6 x 24	S	500	77,00A4
3 m6 x 28	S	500	81,00A4
3 m6 x 30	S	500	86,00A4
3 m6 x 32	S	500	89,00A4
4 m6 x 6	S	500	58,00A4
4 m6 x 8	S	500	66,00A4

Abmessungen	VE	Stück	€/100/Obf.
4 m6 x 10	S	500	73,00A4
4 m6 x 12	S	500	80,00A4
4 m6 x 14	S	500	86,00A4
4 m6 x 16	S	500	93,00A4
4 m6 x 18	S	500	107,00A4
4 m6 x 20	S	500	114,00A4
4 m6 x 24	S	200	128,00A4
4 m6 x 28	S	200	143,00A4
4 m6 x 30	S	200	149,00A4
4 m6 x 32	S	200	156,00A4
4 m6 x 36	S	200	172,00A4
4 m6 x 40	S	200	191,00A4
5 m6 x 6	S	500	64,00A4
5 m6 x 8	S	500	73,00A4
5 m6 x 10	S	500	82,00A4
5 m6 x 12	S	500	86,00A4
5 m6 x 14	S	200	94,00A4
5 m6 x 16	S	200	99,00A4
5 m6 x 18	S	200	107,00A4
5 m6 x 20	S	200	131,00A4
5 m6 x 24	S	200	128,00A4
5 m6 x 28	S	200	143,00A4
5 m6 x 30	S	200	149,00A4
5 m6 x 32	S	200	158,00A4
5 m6 x 36	S	200	170,00A4
5 m6 x 40	S	200	187,00A4
5 m6 x 45	S	200	206,00A4
5 m6 x 50	S	200	223,00A4
6 m6 x 8	S	100	100,00A4
6 m6 x 10	S	100	103,00A4
6 m6 x 12	S	100	112,00A4
6 m6 x 14	S	100	122,00A4
6 m6 x 16	S	100	128,00A4
6 m6 x 18	S	100	158,00A4
6 m6 x 20	S	100	166,00A4
6 m6 x 24	S	100	183,00A4
6 m6 x 28	S	100	208,00A4
6 m6 x 30	S	100	210,00A4
6 m6 x 32	S	100	221,00A4
6 m6 x 36	S	100	242,00A4
6 m6 x 40	S	100	265,00A4
6 m6 x 45	S	100	285,00A4
6 m6 x 50	S	100	310,00A4
6 m6 x 55	S	100	330,00A4
6 m6 x 60	S	100	355,00A4
8 m6 x 10	S	100	172,00A4
8 m6 x 12	S	100	185,00A4
8 m6 x 14	S	100	202,00A4
8 m6 x 16	S	100	214,00A4
8 m6 x 18	S	100	229,00A4
8 m6 x 20	S	100	244,00A4
8 m6 x 24	S	100	275,00A4
8 m6 x 28	S	100	300,00A4
8 m6 x 30	S	100	310,00A4
8 m6 x 32	S	100	330,00A4
8 m6 x 36	S	100	355,00A4
8 m6 x 40	S	100	390,00A4
8 m6 x 45	S	100	425,00A4
8 m6 x 50	S	100	460,00A4
8 m6 x 55	S	100	500,00A4
8 m6 x 60	S	100	560,00A4
8 m6 x 70	S	100	670,00A4
8 m6 x 80	S	100	740,00A4
10 m6 x 12	S	50	330,00A4
10 m6 x 14	S	50	330,00A4
10 m6 x 16	S	50	330,00A4
10 m6 x 18	S	50	340,00A4
10 m6 x 20	S	50	355,00A4
10 m6 x 24	S	50	395,00A4
10 m6 x 28	S	50	445,00A4
10 m6 x 30	S	50	465,00A4
10 m6 x 32	S	50	485,00A4
10 m6 x 36	S	50	570,00A4
10 m6 x 40	S	50	610,00A4
10 m6 x 45	S	50	670,00A4



- ✓ Große Artikelvielfalt
- ✓ Verlässliche Qualität
- ✓ Hohe Lieferbereitschaft

Abmessungen	VE	Stück	€/100/Obf.
10 m6 x 50	S	50	730,00A4
10 m6 x 55	S	50	780,00A4
10 m6 x 60	S	50	830,00A4
10 m6 x 70	S	25	1000,00A4
10 m6 x 80	S	25	1100,00A4
10 m6 x 90	S	25	1220,00A4
10 m6 x 100	S	25	1310,00A4
12 m6 x 14	S	50	740,00A4
12 m6 x 16	S	50	590,00A4
12 m6 x 18	S	50	630,00A4
12 m6 x 20	S	50	690,00A4
12 m6 x 24	S	50	740,00A4
12 m6 x 28	S	50	830,00A4
12 m6 x 32	S	50	930,00A4
12 m6 x 36	S	50	1020,00A4
12 m6 x 40	S	50	1160,00A4
12 m6 x 45	S	50	1260,00A4
12 m6 x 50	S	10	1370,00A4
12 m6 x 55	S	10	1520,00A4
12 m6 x 60	S	10	1600,00A4
12 m6 x 70	S	10	1850,00A4
12 m6 x 80	S	10	2190,00A4
12 m6 x 90	S	10	2380,00A4
12 m6 x 100	S	10	2700,00A4
16 m6 x 20	S	10	1220,00A4
16 m6 x 24	S	10	1350,00A4
16 m6 x 28	S	10	1580,00A4
16 m6 x 32	S	10	1750,00A4
16 m6 x 36	S	10	1870,00A4
16 m6 x 40	S	10	2000,00A4
16 m6 x 45	S	10	2190,00A4
16 m6 x 50	S	10	2330,00A4
16 m6 x 55	S	10	2500,00A4
16 m6 x 60	S	10	2750,00A4
16 m6 x 70	S	10	3000,00A4
16 m6 x 80	S	10	3300,00A4
16 m6 x 90	S	10	3650,00A4
16 m6 x 100	S	10	3950,00A4

ISO	02339.912
2339	A 1 Form B

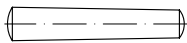

Kegelstifte, Kegel 1 : 50, B = gedreht

Maße → **TI-117** Normumstellung → **TI-10**
 Werkstoffeigensch. → **TI-236**
 Stahl → **S. 230**
 ISO 2339 → ersetzt DIN 1



∅ x Länge (mit Kuppen)

1	x	8	S	50	120,00A1
1	x	10	S	50	96,00A1
1	x	12	S	50	105,00A1
1	x	14	S	50	105,00A1
1	x	16	S	50	113,00A1
1	x	18	S	50	113,00A1
1,5	x	6	S	50	105,00A1
1,5	x	8	S	50	105,00A1
1,5	x	10	S	50	53,00A1
1,5	x	12	S	50	56,00A1
1,5	x	14	S	50	58,00A1
1,5	x	16	S	50	58,00A1
1,5	x	18	S	50	65,00A1

Abmessungen	VE	Stück	€/100/Obf.		
1,5	x	20	S	50	68,00A1
1,5	x	22	S	50	70,00A1
1,5	x	24	S	50	74,00A1
1,5	x	26	S	50	75,00A1
2	x	8	S	50	81,00A1
2	x	10	S	50	81,00A1
2	x	12	S	50	83,00A1
2	x	14	S	50	92,00A1
2	x	16	S	50	95,00A1
2	x	18	S	50	101,00A1
2	x	20	S	50	105,00A1
2	x	22	S	50	110,00A1
2	x	24	S	50	114,00A1
2	x	26	S	50	119,00A1
2	x	28	S	50	122,00A1
2	x	30	S	50	128,00A1
2	x	32	S	50	132,00A1
2	x	36	S	50	158,00A1
2,5	x	12	S	50	64,00A1
2,5	x	14	S	50	64,00A1
2,5	x	16	S	50	68,00A1
2,5	x	18	S	50	74,00A1
2,5	x	20	S	50	81,00A1
2,5	x	22	S	50	88,00A1
2,5	x	24	S	50	94,00A1
2,5	x	26	S	50	99,00A1
2,5	x	28	S	50	105,00A1
2,5	x	30	S	50	110,00A1
2,5	x	32	S	50	116,00A1
2,5	x	36	S	50	120,00A1
3	x	12	S	50	68,00A1
3	x	14	S	50	68,00A1
3	x	16	S	50	74,00A1
3	x	18	S	50	81,00A1
3	x	20	S	50	92,00A1
3	x	22	S	50	103,00A1
3	x	24	S	50	112,00A1
3	x	26	S	50	120,00A1
3	x	28	S	50	127,00A1
3	x	30	S	50	137,00A1
3	x	32	S	50	144,00A1
3	x	36	S	50	150,00A1
3	x	40	S	50	158,00A1
3	x	45	S	50	165,00A1
3	x	50	S	50	175,00A1
4	x	18	S	50	112,00A1
4	x	20	S	50	124,00A1
4	x	22	S	50	135,00A1
4	x	24	S	50	148,00A1
4	x	26	S	25	159,00A1
4	x	28	S	25	169,00A1
4	x	30	S	25	182,00A1
4	x	32	S	25	195,00A1
4	x	36	S	25	214,00A1
4	x	40	S	25	233,00A1
4	x	45	S	25	255,00A1
4	x	50	S	25	275,00A1
4	x	55	S	25	295,00A1
4	x	60	S	25	330,00A1
5	x	20	S	25	167,00A1
5	x	22	S	25	178,00A1
5	x	24	S	25	192,00A1
5	x	26	S	25	205,00A1
5	x	28	S	25	216,00A1
5	x	30	S	25	229,00A1
5	x	32	S	25	241,00A1
5	x	36	S	25	265,00A1
5	x	40	S	25	280,00A1
5	x	45	S	10	315,00A1
5	x	50	S	10	335,00A1
5	x	55	S	10	355,00A1
5	x	60	S	10	375,00A1
5	x	70	S	10	430,00A1
6	x	24	S	10	247,00A1
6	x	26	S	10	260,00A1

Abmessungen	VE	Stück	€/100/Obf.		
6	x	28	S	10	270,00A1
6	x	30	S	10	285,00A1
6	x	32	S	10	295,00A1
6	x	36	S	10	325,00A1
6	x	40	S	10	355,00A1
6	x	45	S	10	390,00A1
6	x	50	S	10	425,00A1
6	x	55	S	10	475,00A1
6	x	60	S	10	510,00A1
6	x	70	S	10	570,00A1
6	x	80	S	10	630,00A1
8	x	28	S	10	425,00A1
8	x	30	S	10	485,00A1
8	x	32	S	10	530,00A1
8	x	36	S	10	610,00A1
8	x	40	S	10	670,00A1
8	x	45	S	10	730,00A1
8	x	50	S	10	800,00A1
8	x	55	S	10	860,00A1
8	x	60	S	10	900,00A1
8	x	70	S	1	1010,00A1
8	x	80	S	1	1100,00A1
8	x	90	S	1	1200,00A1
8	x	100	S	1	1290,00A1
10	x	32	S	10	720,00A1
10	x	36	S	10	780,00A1
10	x	40	S	10	820,00A1
10	x	45	S	10	870,00A1
10	x	50	S	10	900,00A1
10	x	55	S	1	1010,00A1
10	x	60	S	1	1080,00A1
10	x	70	S	1	1180,00A1
10	x	80	S	1	1270,00A1
10	x	90	S	1	1410,00A1
10	x	100	S	1	1560,00A1

ISO	02342.910
2342	A 1

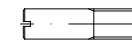

Schaftschrauben mit Kegelkuppe, mit Schlitz

Maße → **TI-19** Normumstellung → **TI-6**
 Werkstoffeigensch. → **TI-236**
 Stahl → **S. 232**
 ISO 2342 → ersetzt DIN 427 (austauschbar)

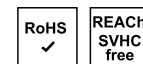

M 3	x	6	S	100	89,00A1
M 3	x	8	S	100	99,00A1
M 4	x	8	S	100	105,00A1
M 4	x	10	S	100	110,00A1
M 4	x	12	S	100	118,00A1
M 4	x	16	S	100	127,00A1
M 4	x	20	S	100	137,00A1
M 5	x	10	S	100	118,00A1
M 5	x	12	S	100	122,00A1
M 5	x	16	S	100	161,00A1
M 5	x	20	S	100	201,00A1
M 6	x	12	S	100	260,00A1
M 6	x	16	S	100	265,00A1
M 6	x	20	S	100	270,00A1
M 6	x	30	S	100	285,00A1
M 8	x	16	S	100	360,00A1

Abmessungen	VE	Stück	€/100/Obf.
M 8 x 20	S	100	375,00 A1
M 10 x 20	S	100	495,00 A1
M 10 x 25	S	100	540,00 A1
M 10 x 30	S	100	570,00 A1
M 10 x 50	S	100	660,00 A1

DIN 03017.311
3017 1.4016 (W2) Form A

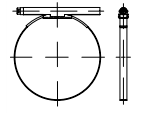

Schlauchschellen, A = mit Schneckenantrieb

Spannschraube mit Längsschlitz, Sechskant und Kreuzschlitz (H2),
 Band und Gehäuse: 1.4016, Schraube = Stahl, Zn

Maße → TI-131
 Rostfrei → S. 528



Spannbereich/Bandbreite x SW

8- 12/ 7,5 C6	S	100	102,00
10- 16/ 7,5 C6	S	100	103,00
8- 16/ 9 C7	S	100	106,00
12- 20/ 9 C7	S	100	108,00
16- 27/ 9 C7	S	100	114,00
20- 32/ 9 C7	S	100	120,00
25- 40/ 9 C7	S	100	125,00
32- 50/ 9 C7	S	50	130,00
40- 60/ 9 C7	S	50	134,00
50- 70/ 9 C7	S	50	136,00
60- 80/ 9 C7	S	25	144,00
70- 90/ 9 C7	S	25	171,00
80-100/ 9 C7	S	25	175,00
90-110/ 9 C7	S	25	184,00

DIN 03017.903
3017 1.4016 (W2) Form C1

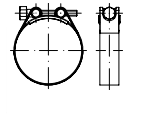

Schlauchschellen, C1 = mit Rundbolzen, einteilig

Spannschraube mit Sechskant

Maße → TI-131

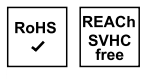

Spannbereich von - bis/Bandbreite

17- 19/18	S	50	1200,00
19- 21/18	S	50	1200,00
21- 23/18	S	50	1210,00
23- 25/18	S	50	1230,00
25- 27/18	S	50	1240,00
27- 29/18	S	50	1240,00
29- 31/18	S	50	1250,00
31- 34/18	S	50	1250,00
34- 37/18	S	50	1250,00
37- 40/18	S	50	1260,00

Abmessungen	VE	Stück	€/100/Obf.
40- 43/18	S	50	1260,00
43- 47/20	S	50	1290,00
47- 51/20	S	50	1320,00
51- 55/20	S	50	1320,00
55- 59/20	S	50	1350,00
59- 63/20	S	50	1360,00
63- 68/20	S	50	1400,00
68- 73/25	S	25	1690,00
73- 79/25	S	25	1710,00
79- 85/25	S	25	1760,00
85- 91/25	S	25	1780,00
91- 97/25	S	25	1820,00
97-104/25	S	25	1840,00
104-112/25	S	25	1890,00
112-121/25	S	25	1940,00
121-130/25	S	25	2000,00
130-140/30	S	10	3300,00
140-150/30	S	10	3350,00
150-162/30	S	10	3450,00
162-174/30	S	10	3700,00
174-187/30	S	10	3800,00
187-200/30	S	10	3850,00
200-213/30	S	10	4150,00
213-226/30	S	10	4200,00
226-239/30	S	10	4300,00
239-252/30	S	10	4400,00

DIN 03017.941
3017 A 4 (W5) Form A

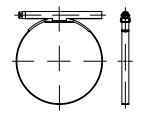

Schlauchschellen, A = mit Schneckenantrieb

Spannschraube mit Längsschlitz und Sechskant,
 Band, Gehäuse und Schraube: 1.4401

Maße → TI-131 Werkstoffeigensch. → TI-236
 Stahl → S. 234

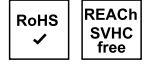

Spannbereich/Bandbreite x SW

8- 16/ 9 C7	S	100	193,00 A4
12- 20/ 9 C7	S	100	217,00 A4
12- 22/ 9 C7	S	100	221,00 A4
16- 27/ 9 C7	S	100	229,00 A4
16- 27/12 C7	S	50	375,00 A4
20- 32/ 9 C7	S	100	231,00 A4
20- 32/12 C7	S	50	380,00 A4
25- 40/ 9 C7	S	100	260,00 A4
25- 40/12 C7	S	50	400,00 A4
32- 50/ 9 C7	S	50	275,00 A4
35- 50/12 C7	S	50	420,00 A4
40- 60/ 9 C7	S	50	295,00 A4
40- 60/12 C7	S	25	510,00 A4
50- 70/ 9 C7	S	50	310,00 A4
50- 70/12 C7	S	25	530,00 A4
60- 80/ 9 C7	S	25	340,00 A4
60- 80/12 C7	S	25	600,00 A4
70- 90/ 9 C7	S	25	360,00 A4
70- 90/12 C7	S	25	630,00 A4
80-100/ 9 C7	S	25	370,00 A4
80-100/12 C7	S	1	660,00 A4
90-110/ 9 C7	S	25	385,00 A4
90-110/12 C7	S	20	690,00 A4
100-120/12 C7	S	1	750,00 A4

Abmessungen	VE	Stück	€/100/Obf.
110-130/12 C7	S	1	800,00 A4
120-140/12 C7	S	1	840,00 A4
130-150/12 C7	S	1	870,00 A4
140-160/12 C7	S	1	900,00 A4
150-170/12 C7	S	1	930,00 A4
160-180/12 C7	S	1	960,00 A4
170-190/12 C7	S	1	990,00 A4

DIN 03567.951
3567 1.4571 (A5) Form A

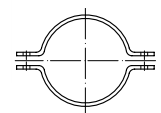

Rohrschellen, A = gleichschenkelig

Maße → TI-132 Werkstoffeigensch. → TI-232
 Stahl → S. 235

Preise gelten für Rohrschellen-Hälften

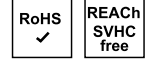

Innen Ø / für Rohr-Nennweite

A 34 / NW 25	S	1	1550,00 A5
A 43 / NW 32	S	1	1610,00 A5
A 49 / NW 40	S	1	1710,00 A5
A 61 / NW 50	S	1	2550,00 A5
A 77 / NW 65	S	1	3100,00 A5
A 89 / NW 80	S	1	3300,00 A5
A 115 / NW 100	S	1	7200,00 A5
A 140 / NW 125	S	1	8000,00 A5
A 169 / NW 150	S	1	9100,00 A5
A 220 / NW 200	S	1	11500,00 A5

DIN 03570.941
3570 A 4 Form A

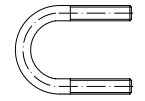

Rundstahlbügel, ohne Muttern, A = zweiseit. Befestigungsgewinde

Bügel-Höhe für Plattendicke 10 mm

Muttern → DIN 934/ISO 4032
 Maße → TI-130 Werkstoffeigensch. → TI-232
 Stahl → S. 235

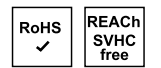

NW / ~ Rohr-Außen Ø

A 23 / NW 15	S	1	570,00 A4
A 30 / NW 20	S	1	710,00 A4
A 38 / NW 25	S	1	730,00 A4
A 46 / NW 32	S	1	780,00 A4
A 52 / NW 40	S	1	820,00 A4
A 64 / NW 50	S	1	1160,00 A4
A 82 / NW 65	S	1	1330,00 A4
A 94 / NW 80	S	1	1390,00 A4
A 120 / NW 100	S	1	4650,00 A4
A 148 / NW 125	S	1	5500,00 A4

Abmessungen	VE	Stück	€/100/Obf.
A 176 / NW 150	S	1	6100,00A4
A 228 / NW 200	S	1	12600,00A4
A 282 / NW 250	S	1	14300,00A4
A 332 / NW 300	S	1	16600,00A4
A 530 / NW 500	S	1	26100,00A4

ISO	04014.920
4014	A 2 (- 70)*

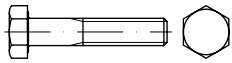

Sechskantschrauben mit Schaft

kurze Abmessungen z. T. Gewinde bis Kopf,
 **M 10/12/14/22 = RAZ 3220 übrige Ø = RAZ 401

Maße → **TI-15** Anziehmomente → **TI-249**
 Werkstoffeigensch. → **TI-236** Normumstellung → **TI-6**

Stahl → **S. 236**
 Messing → **S. 636**

ISO 4014 → ersetzt DIN 931



*Fkl. bei diesen Abmessungen je nach Fabrikat abweichend

M 5	x	30	S	100	15,60A2
M 5	x	35	S	100	18,80A2
M 5	x	40	S	100	19,70A2
M 5	x	45	S	100	23,10A2
M 5	x	50	S	100	27,00A2
M 5	x	55	S	100	53,00A2
M 5	x	60	S	100	53,00A2
M 5	x	65	S	200	115,00A2
M 5	x	70	S	100	117,00A2
M 5	x	80	S	100	395,00A2
M 5	x	90	S	100	530,00A2
M 5	x	100	S	100	670,00A2
M 6	x	30	S	200	15,00A2
M 6	x	35	S	100	16,80A2
M 6	x	40	S	100	19,40A2
M 6	x	45	S	100	22,60A2
M 6	x	50	S	100	27,00A2
M 6	x	55	S	100	40,00A2
M 6	x	60	S	100	45,00A2
M 6	x	65	S	100	57,00A2
M 6	x	70	S	100	61,00A2
M 6	x	75	S	100	88,00A2
M 6	x	80	S	100	74,00A2
M 6	x	85	S	100	121,00A2
M 6	x	90	S	100	97,00A2
M 6	x	100	S	100	114,00A2
M 6	x	110	S	50	143,00A2
M 6	x	120	S	50	168,00A2
M 6	x	130	S	50	275,00A2
M 6	x	140	S	50	290,00A2
M 6	x	150	S	50	345,00A2
M 6	x	160*	S	50	370,00A2
M 6	x	170*	S	50	450,00A2
M 6	x	180*	S	50	455,00A2
M 8	x	35	S	100	28,50A2
M 8	x	40	S	100	33,00A2
M 8	x	45	S	100	35,00A2
M 8	x	50	S	100	37,50A2
M 8	x	55	S	100	41,50A2
M 8	x	60	S	100	42,50A2
M 8	x	65	S	100	59,00A2
M 8	x	70	S	100	62,00A2
M 8	x	75	S	100	120,00A2
M 8	x	80	S	100	95,00A2
M 8	x	85	S	100	145,00A2

Abmessungen	VE	Stück	€/100/Obf.		
M 8	x	90	S	100	116,00A2
M 8	x	100	S	100	141,00A2
M 8	x	110	S	50	169,00A2
M 8	x	120	S	50	192,00A2
M 8	x	130	S	50	216,00A2
M 8	x	140	S	50	239,00A2
M 8	x	150	S	50	265,00A2
M 8	x	160	S	25	365,00A2
M 8	x	170	S	25	445,00A2
M 8	x	180	S	25	445,00A2
M 8	x	190	S	25	590,00A2
M 8	x	200	S	25	590,00A2
M 8	x	220*	S	25	890,00A2
M 10	x	40	S	100	60,00A2
M 10	x	45	S	100	61,00A2
M 10	x	50	S	100	65,00A2
M 10	x	55	S	50	71,00A2
M 10	x	60	S	50	75,00A2
M 10	x	65	S	50	86,00A2
M 10	x	70	S	50	88,00A2
M 10	x	75	S	50	159,00A2
M 10	x	80	S	50	108,00A2
M 10	x	85	S	50	239,00A2
M 10	x	90	S	50	163,00A2
M 10	x	100	S	50	209,00A2
M 10	x	110	S	100	305,00A2
M 10	x	120	S	50	315,00A2
M 10	x	130	S	50	385,00A2
M 10	x	140	S	50	450,00A2
M 10	x	150	S	50	500,00A2
M 10	x	160	S	50	590,00A2
M 10	x	170	S	1	720,00A2
M 10	x	180	S	1	730,00A2
M 10	x	190	S	1	950,00A2
M 10	x	200	S	1	950,00A2
M 10	x	210	S	1	1230,00A2
M 10	x	220	S	1	1380,00A2
M 12	x	40	S	50	80,00A2
M 12	x	45	S	50	85,00A2
M 12	x	50	S	50	93,00A2
M 12	x	55	S	50	101,00A2
M 12	x	60	S	50	106,00A2
M 12	x	65	S	50	120,00A2
M 12	x	70	S	50	127,00A2
M 12	x	75	S	50	226,00A2
M 12	x	80	S	50	154,00A2
M 12	x	85	S	50	290,00A2
M 12	x	90	S	50	207,00A2
M 12	x	100	S	50	231,00A2
M 12	x	105	S	50	475,00A2
M 12	x	110	S	25	285,00A2
M 12	x	120	S	25	335,00A2
M 12	x	130	S	1	405,00A2
M 12	x	140	S	1	570,00A2
M 12	x	150	S	1	550,00A2
M 12	x	160	S	1	660,00A2
M 12	x	170	S	1	830,00A2
M 12	x	180	S	1	830,00A2
M 12	x	190	S	1	1130,00A2
M 12	x	200	S	1	1130,00A2
M 12	x	210	S	1	1450,00A2
M 12	x	220	S	1	1580,00A2
M 12	x	230	S	1	1670,00A2
M 12	x	240	S	1	1760,00A2
M 12	x	250	S	1	1850,00A2
M 12	x	260*	S	1	2050,00A2
M 12	x	280*	S	1	2220,00A2
M 12	x	300*	S	1	2370,00A2
M 12	x	320*	S	1	2850,00A2
M 14	x	50	S	100	285,00A2
M 14	x	55	S	50	127,00A2
M 14	x	60	S	50	131,00A2
M 14	x	65	S	50	141,00A2
M 14	x	70	S	50	148,00A2
M 14	x	75	S	50	330,00A2

Abmessungen	VE	Stück	€/100/Obf.		
M 14	x	80	S	50	167,00A2
M 14	x	90	S	50	184,00A2
M 14	x	100	S	50	199,00A2
M 14	x	110	S	25	290,00A2
M 14	x	120	S	25	320,00A2
M 14	x	130	S	25	740,00A2
M 14	x	140	S	25	800,00A2
M 14	x	150	S	1	700,00A2
M 14	x	160	S	1	900,00A2
M 14	x	170*	S	1	1000,00A2
M 14	x	180*	S	1	1060,00A2
M 14	x	200*	S	1	1220,00A2
M 16	x	55	S	50	195,00A2
M 16	x	60	S	50	199,00A2
M 16	x	65	S	50	216,00A2
M 16	x	70	S	25	228,00A2
M 16	x	75	S	25	255,00A2
M 16	x	80	S	25	255,00A2
M 16	x	85	S	25	345,00A2
M 16	x	90	S	25	280,00A2
M 16	x	95	S	25	400,00A2
M 16	x	100	S	25	305,00A2
M 16	x	110	S	25	440,00A2
M 16	x	120	S	25	475,00A2
M 16	x	130	S	1	590,00A2
M 16	x	140	S	1	640,00A2
M 16	x	150	S	1	700,00A2
M 16	x	160	S	1	900,00A2
M 16	x	170	S	1	1000,00A2
M 16	x	180	S	1	1060,00A2
M 16	x	190	S	1	1220,00A2
M 16	x	200	S	1	1220,00A2
M 16	x	210	S	1	1450,00A2
M 16	x	220	S	1	1450,00A2
M 16	x	230	S	1	1680,00A2
M 16	x	240	S	1	1680,00A2
M 16	x	250	S	1	2000,00A2
M 16	x	260*	S	1	2000,00A2
M 16	x	270*	S	1	2250,00A2
M 16	x	280*	S	1	2250,00A2
M 16	x	290*	S	1	2500,00A2
M 16	x	300*	S	1	2500,00A2
M 18	x	65	S	1	510,00A2
M 18	x	70	S	25	540,00A2
M 18	x	75	S	1	590,00A2
M 18	x	80	S	25	590,00A2
M 18	x	90	S	25	650,00A2
M 18	x	100	S	25	710,00A2
M 18	x	110	S	25	1000,00A2
M 18	x	120	S	25	1090,00A2
M 18	x	130	S	25	1280,00A2
M 18	x	140	S	25	1400,00A2
M 18	x	150	S	25	1520,00A2
M 18	x	160	S	25	1600,00A2
M 20	x	65	S	1	340,00A2
M 20	x	70	S	1	360,00A2
M 20	x	75	S	1	395,00A2
M 20	x	80	S	1	395,00A2
M 20	x	85	S	1	540,00A2
M 20	x	90	S	1	430,00A2
M 20	x	100	S	1	470,00A2
M 20	x	110	S	1	670,00A2
M 20	x	120	S	1	730,00A2
M 20	x	130	S	1	850,00A2
M 20	x	140	S	1	940,00A2
M 20	x	150	S	1	1020,00A2
M 20	x	160	S	1	1310,00A2
M 20	x	170	S	1	1420,00A2
M 20	x	180	S	1	1500,00A2
M 20	x	190	S	1	1690,00A2
M 20	x	200	S	1	1690,00A2
M 20	x	210	S	1	2070,00A2
M 20	x	220	S	1	2070,00A2
M 20	x	230	S	1	2360,00A2
M 20	x	240	S	1	2360,00A2

Abmessungen	VE	Stück	€/100/Obf.	Abmessungen	VE	Stück	€/100/Obf.	Abmessungen	VE	Stück	€/100/Obf.
M 20 x 250	S	1	2650,00A2	M 33 x 110*	S	1	3600,00A2	M 12 x 65	S	50	119,00A2-70
M 20 x 260*	S	1	2650,00A2	M 33 x 120*	S	1	3800,00A2	M 12 x 70	S	50	127,00A2-70
M 20 x 270*	S	1	2950,00A2	M 33 x 130*	S	1	4050,00A2	M 12 x 75	S	50	226,00A2-70
M 20 x 280*	S	1	2950,00A2	M 33 x 140*	S	1	4300,00A2	M 12 x 80	S	25	153,00A2-70
M 20 x 290*	S	1	3250,00A2	M 33 x 150*	S	1	4500,00A2	M 12 x 85	S	25	295,00A2-70
M 20 x 300*	S	1	3250,00A2	M 33 x 160*	S	1	4750,00A2	M 12 x 90	S	25	207,00A2-70
M 22 x 80	S	10	1420,00A2	M 33 x 170*	S	1	5200,00A2	M 12 x 100	S	25	231,00A2-70
M 22 x 90	S	10	1520,00A2	M 33 x 180*	S	1	5200,00A2	M 12 x 110	S	25	285,00A2-70
M 22 x 100	S	10	1670,00A2	M 33 x 190*	S	1	5700,00A2	M 12 x 120	S	25	335,00A2-70
M 22 x 110	S	10	1880,00A2	M 33 x 200*	S	1	5700,00A2	M 12 x 130	S	25	415,00A2-70
M 22 x 120	S	10	2050,00A2	M 33 x 210*	S	1	6100,00A2	M 12 x 140	S	25	490,00A2-70
M 22 x 130	S	1	1550,00A2	M 33 x 220*	S	1	6100,00A2	M 12 x 150	S	25	560,00A2-70
M 22 x 140	S	1	1680,00A2	M 33 x 230*	S	1	6600,00A2	M 16 x 50	S	25	194,00A2-70
M 22 x 150	S	10	2650,00A2	M 33 x 240*	S	1	6600,00A2	M 16 x 55	S	25	199,00A2-70
M 22 x 160	S	1	2130,00A2	M 33 x 250*	S	1	7100,00A2	M 16 x 60	S	25	203,00A2-70
M 22 x 180	S	1	2410,00A2	M 36 x 100*	S	1	4100,00A2	M 16 x 65	S	25	218,00A2-70
M 22 x 200	S	1	2700,00A2	M 36 x 110*	S	1	4400,00A2	M 16 x 70	S	25	229,00A2-70
M 24 x 75	S	1	790,00A2	M 36 x 120*	S	1	4650,00A2	M 16 x 75	S	25	330,00A2-70
M 24 x 80	S	1	640,00A2	M 36 x 130*	S	1	4900,00A2	M 16 x 80	S	25	260,00A2-70
M 24 x 85	S	1	840,00A2	M 36 x 140*	S	1	5200,00A2	M 16 x 85	S	25	375,00A2-70
M 24 x 90	S	1	670,00A2	M 36 x 150*	S	1	5500,00A2	M 16 x 90	S	25	285,00A2-70
M 24 x 95	S	1	910,00A2	M 36 x 160*	S	1	5800,00A2	M 16 x 95	S	25	405,00A2-70
M 24 x 100	S	1	720,00A2	M 36 x 170*	S	1	6700,00A2	M 16 x 100	S	25	310,00A2-70
M 24 x 110	S	1	810,00A2	M 36 x 180*	S	1	6700,00A2	M 16 x 110	S	25	445,00A2-70
M 24 x 120	S	1	870,00A2	M 36 x 190*	S	1	7200,00A2	M 16 x 120	S	25	485,00A2-70
M 24 x 130	S	1	1100,00A2	M 36 x 200*	S	1	7200,00A2	M 16 x 130	S	25	600,00A2-70
M 24 x 140	S	1	1190,00A2	M 36 x 210*	S	1	7800,00A2	M 16 x 140	S	25	640,00A2-70
M 24 x 150	S	1	1260,00A2	M 36 x 220*	S	1	7800,00A2	M 16 x 150	S	1	700,00A2-70
M 24 x 160	S	1	1870,00A2	M 36 x 230*	S	1	8400,00A2	M 16 x 160	S	1	910,00A2-70
M 24 x 170	S	1	2170,00A2	M 36 x 240*	S	1	8400,00A2	M 16 x 170	S	1	950,00A2-70
M 24 x 180	S	1	2170,00A2	M 36 x 250*	S	1	8900,00A2	M 16 x 180	S	1	1070,00A2-70
M 24 x 190	S	1	2410,00A2					M 20 x 65	S	25	340,00A2-70
M 24 x 200	S	1	2410,00A2					M 20 x 70	S	25	360,00A2-70
M 24 x 210	S	1	2750,00A2					M 20 x 75	S	25	400,00A2-70
M 24 x 220	S	1	2750,00A2					M 20 x 80	S	25	400,00A2-70
M 24 x 230	S	1	3050,00A2					M 20 x 85	S	25	790,00A2-70
M 24 x 240	S	1	3050,00A2					M 20 x 90	S	25	435,00A2-70
M 24 x 250	S	1	3500,00A2					M 20 x 100	S	25	470,00A2-70
M 24 x 260*	S	1	3500,00A2					M 20 x 110	S	25	670,00A2-70
M 24 x 280*	S	1	3850,00A2					M 20 x 120	S	25	730,00A2-70
M 24 x 290*	S	1	4150,00A2					M 20 x 130	S	25	860,00A2-70
M 24 x 300*	S	1	4150,00A2					M 20 x 140	S	1	940,00A2-70
M 27 x 90	S	1	1790,00A2					M 20 x 150	S	1	1020,00A2-70
M 27 x 100	S	1	1930,00A2					M 20 x 160	S	1	1370,00A2-70
M 27 x 110	S	1	2080,00A2					M 20 x 170	S	1	1770,00A2-70
M 27 x 120	S	1	2230,00A2					M 20 x 180	S	1	1840,00A2-70
M 27 x 130	S	1	2300,00A2					M 20 x 190	S	1	2040,00A2-70
M 27 x 140	S	1	2440,00A2					M 20 x 200	S	1	2130,00A2-70
M 27 x 150	S	1	2600,00A2					M 20 x 220	S	1	2090,00A2-70
M 27 x 160*	S	1	2750,00A2								
M 27 x 170*	S	1	3050,00A2								
M 27 x 180*	S	1	3050,00A2								
M 27 x 200*	S	1	3300,00A2								
M 27 x 210*	S	1	4100,00A2								
M 27 x 220*	S	1	4100,00A2								
M 27 x 230*	S	1	4550,00A2								
M 27 x 240*	S	1	4550,00A2								
M 27 x 250*	S	1	5100,00A2								
M 30 x 90*	S	1	2330,00A2								
M 30 x 100*	S	1	2550,00A2								
M 30 x 110*	S	1	2750,00A2								
M 30 x 120*	S	1	2900,00A2								
M 30 x 130*	S	1	3050,00A2								
M 30 x 140*	S	1	3450,00A2								
M 30 x 150*	S	1	3650,00A2								
M 30 x 160*	S	1	4050,00A2								
M 30 x 170*	S	1	4450,00A2								
M 30 x 180*	S	1	4450,00A2								
M 30 x 190*	S	1	4850,00A2								
M 30 x 200*	S	1	4850,00A2								
M 30 x 210*	S	1	5300,00A2								
M 30 x 220*	S	1	5300,00A2								
M 30 x 240*	S	1	5700,00A2								
M 30 x 250*	S	1	6000,00A2								
M 33 x 100*	S	1	3350,00A2								
M 10 x 50	S	100	67,00A2-70								
M 10 x 55	S	100	72,00A2-70								
M 10 x 60	S	100	78,00A2-70								
M 10 x 65	S	100	90,00A2-70								
M 10 x 70	S	100	91,00A2-70								
M 10 x 75	S	50	159,00A2-70								
M 10 x 80	S	50	110,00A2-70								
M 10 x 90	S	50	167,00A2-70								
M 10 x 100	S	50	212,00A2-70								
M 10 x 110	S	50	260,00A2-70								
M 10 x 120	S	50	320,00A2-70								
M 10 x 130	S	50	390,00A2-70								
M 10 x 140	S	50	450,00A2-70								
M 10 x 150	S	50	510,00A2-70								
M 12 x 50	S	50	92,00A2-70								
M 12 x 55	S	50	99,00A2-70								
M 12 x 60	S	50	106,00A2-70								

ISO 04014.927
4014 A 2 - 70 AD W2

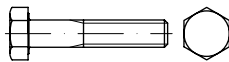

Sechskantschrauben mit Schaft

kurze Abmessungen z. T. Gewinde bis Kopf, für Druckbehälterbau nach AD-Regelwerk, Fabrikate mit Verzicht eines Abnahmeprüfzeugnis, *M 10/12= RAZ 3223 übrige Ø = RAZ 403

Maße → TI-15 Anziehmomente → TI-249
 Werkstoffeigensch. → TI-236 Normumstellung → TI-6

Stahl → S. 236
 Messing → S. 636

ISO 4014 → ersetzt DIN 931

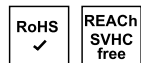

Wir versorgen Sie mit
 Verbindungselementen
 und Befestigungstechnik!

Abmessungen	VE Stück	€/100/Obf.
ISO 04014.940		
4014	A 4 (- 70)*	

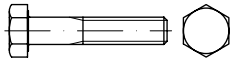

Sechskantschrauben mit Schaft

kurze Abmessungen z. T. Gewinde bis Kopf,
 **M 10/12/14/22 = RAZ 3220 übrige Ø = RAZ 401

Maße → **TI-15** Anziehungsmomente → **TI-249**
 Werkstoffeigensch. → **TI-236** Normumstellung → **TI-6**
 Stahl → **S. 236**
 Messing → **S. 636**

ISO 4014 → ersetzt DIN 931

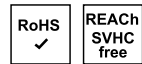

*Fkl. bei diesen Abmessungen je nach Fabrikat abweichend

M 5	x	30	S	100	24,40 A4
M 5	x	35	S	100	26,50 A4
M 5	x	40	S	100	29,00 A4
M 5	x	45	S	100	33,50 A4
M 5	x	50	S	100	42,00 A4
M 5	x	55	S	100	69,00 A4
M 5	x	60	S	100	72,00 A4
M 5	x	70	S	100	152,00 A4
M 5	x	80	S	100	470,00 A4
M 5	x	90	S	100	600,00 A4
M 5	x	100	S	100	770,00 A4
M 6	x	30	S	200	24,20 A4
M 6	x	35	S	100	26,00 A4
M 6	x	40	S	100	28,00 A4
M 6	x	45	S	100	32,00 A4
M 6	x	50	S	100	36,50 A4
M 6	x	55	S	100	51,00 A4
M 6	x	60	S	100	58,00 A4
M 6	x	65	S	100	70,00 A4
M 6	x	70	S	100	74,00 A4
M 6	x	80	S	100	92,00 A4
M 6	x	90	S	100	120,00 A4
M 6	x	100	S	100	133,00 A4
M 6	x	110	S	50	176,00 A4
M 6	x	120	S	50	214,00 A4
M 6	x	130	S	50	365,00 A4
M 6	x	140	S	1	405,00 A4
M 6	x	150	S	1	445,00 A4
M 6	x	160*	S	1	485,00 A4
M 6	x	170*	S	1	620,00 A4
M 8	x	35	S	100	53,00 A4
M 8	x	40	S	100	53,00 A4
M 8	x	45	S	100	56,00 A4
M 8	x	50	S	100	60,00 A4
M 8	x	55	S	100	71,00 A4
M 8	x	60	S	100	73,00 A4
M 8	x	65	S	100	96,00 A4
M 8	x	70	S	100	101,00 A4
M 8	x	75	S	100	210,00 A4
M 8	x	80	S	100	152,00 A4
M 8	x	85	S	100	221,00 A4
M 8	x	90	S	100	178,00 A4
M 8	x	100	S	100	210,00 A4
M 8	x	110	S	50	260,00 A4
M 8	x	120	S	50	295,00 A4
M 8	x	130	S	50	365,00 A4
M 8	x	140	S	1	430,00 A4
M 8	x	150	S	1	490,00 A4
M 8	x	160	S	1	610,00 A4
M 8	x	170	S	1	750,00 A4
M 8	x	180	S	1	750,00 A4

M 8	x	190	S	1	990,00 A4
M 8	x	200	S	1	990,00 A4
M 8	x	220*	S	1	1460,00 A4
M 10	x	40	S	100	99,00 A4
M 10	x	45	S	100	101,00 A4
M 10	x	50	S	100	105,00 A4
M 10	x	55	S	50	118,00 A4
M 10	x	60	S	50	122,00 A4
M 10	x	65	S	50	143,00 A4
M 10	x	70	S	50	145,00 A4
M 10	x	75	S	50	260,00 A4
M 10	x	80	S	50	177,00 A4
M 10	x	90	S	50	242,00 A4
M 10	x	95	S	50	800,00 A4
M 10	x	100	S	50	310,00 A4
M 10	x	110	S	50	390,00 A4
M 10	x	120	S	50	475,00 A4
M 10	x	130	S	50	610,00 A4
M 10	x	140	S	1	1490,00 A4
M 10	x	150	S	50	800,00 A4
M 10	x	160	S	1	990,00 A4
M 10	x	170	S	1	1210,00 A4
M 10	x	180	S	1	1210,00 A4
M 10	x	190	S	1	1600,00 A4
M 10	x	200	S	1	1600,00 A4
M 10	x	210	S	1	1970,00 A4
M 10	x	220	S	1	2220,00 A4
M 12	x	45	S	50	147,00 A4
M 12	x	50	S	50	149,00 A4
M 12	x	55	S	50	164,00 A4
M 12	x	60	S	50	166,00 A4
M 12	x	65	S	50	198,00 A4
M 12	x	70	S	50	202,00 A4
M 12	x	75	S	50	360,00 A4
M 12	x	80	S	50	235,00 A4
M 12	x	85	S	50	420,00 A4
M 12	x	90	S	50	290,00 A4
M 12	x	95	S	50	440,00 A4
M 12	x	100	S	50	340,00 A4
M 12	x	110	S	25	415,00 A4
M 12	x	120	S	25	510,00 A4
M 12	x	130	S	1	640,00 A4
M 12	x	140	S	1	960,00 A4
M 12	x	150	S	50	870,00 A4
M 12	x	160	S	1	1130,00 A4
M 12	x	170	S	1	1640,00 A4
M 12	x	180	S	1	1420,00 A4
M 12	x	190	S	1	1750,00 A4
M 12	x	200	S	1	1750,00 A4
M 12	x	210	S	1	2140,00 A4
M 12	x	220	S	1	2260,00 A4
M 12	x	240	S	1	2440,00 A4
M 12	x	250	S	1	2550,00 A4
M 12	x	260*	S	1	2750,00 A4
M 12	x	280*	S	1	2900,00 A4
M 12	x	300*	S	1	3050,00 A4
M 12	x	320*	S	1	3200,00 A4
M 12	x	340*	S	1	3350,00 A4
M 12	x	360*	S	1	3500,00 A4
M 14	x	50	S	100	365,00 A4
M 14	x	55	S	50	365,00 A4
M 14	x	60	S	50	365,00 A4
M 14	x	65	S	50	395,00 A4
M 14	x	70	S	50	400,00 A4
M 14	x	80	S	50	435,00 A4
M 14	x	90	S	50	485,00 A4
M 14	x	100	S	50	530,00 A4
M 14	x	110	S	25	670,00 A4
M 14	x	120	S	25	750,00 A4
M 14	x	130	S	25	890,00 A4
M 14	x	140	S	25	990,00 A4
M 14	x	150	S	1	1070,00 A4
M 14	x	160	S	1	1410,00 A4
M 14	x	170*	S	1	1620,00 A4
M 14	x	180*	S	1	1620,00 A4

M 14	x	190*	S	1	1830,00 A4
M 14	x	200*	S	1	1830,00 A4
M 16	x	55	S	50	355,00 A4
M 16	x	60	S	50	355,00 A4
M 16	x	65	S	50	390,00 A4
M 16	x	70	S	25	395,00 A4
M 16	x	75	S	25	430,00 A4
M 16	x	80	S	25	430,00 A4
M 16	x	85	S	25	600,00 A4
M 16	x	90	S	25	480,00 A4
M 16	x	100	S	25	520,00 A4
M 16	x	110	S	25	660,00 A4
M 16	x	120	S	25	740,00 A4
M 16	x	130	S	1	880,00 A4
M 16	x	140	S	1	980,00 A4
M 16	x	150	S	1	1070,00 A4
M 16	x	160	S	1	1410,00 A4
M 16	x	170	S	1	1620,00 A4
M 16	x	180	S	1	1620,00 A4
M 16	x	190	S	1	1830,00 A4
M 16	x	200	S	1	1830,00 A4
M 16	x	210	S	1	2600,00 A4
M 16	x	220	S	1	2600,00 A4
M 16	x	230	S	1	2950,00 A4
M 16	x	240	S	1	2950,00 A4
M 16	x	250	S	1	3300,00 A4
M 16	x	260*	S	1	3300,00 A4
M 16	x	270*	S	1	3650,00 A4
M 16	x	280*	S	1	3650,00 A4
M 16	x	290*	S	1	4000,00 A4
M 16	x	300*	S	1	4000,00 A4
M 16	x	320*	S	1	6500,00 A4
M 16	x	340*	S	1	7000,00 A4
M 16	x	360*	S	1	7200,00 A4
M 16	x	380*	S	1	7300,00 A4
M 16	x	400*	S	1	7400,00 A4
M 18	x	70	S	1	790,00 A4
M 18	x	80	S	1	870,00 A4
M 18	x	90	S	1	960,00 A4
M 18	x	100	S	1	1040,00 A4
M 18	x	110	S	1	1560,00 A4
M 18	x	120	S	1	1690,00 A4
M 18	x	130	S	1	1970,00 A4
M 18	x	140	S	1	2000,00 A4
M 18	x	150	S	1	2000,00 A4
M 18	x	160	S	1	2030,00 A4
M 18	x	170	S	1	3000,00 A4
M 18	x	180	S	1	3000,00 A4
M 18	x	190	S	1	3400,00 A4
M 18	x	200	S	1	3400,00 A4
M 20	x	65	S	1	610,00 A4
M 20	x	70	S	1	630,00 A4
M 20	x	75	S	1	660,00 A4
M 20	x	80	S	1	660,00 A4
M 20	x	85	S	1	950,00 A4
M 20	x	90	S	1	760,00 A4
M 20	x	100	S	1	840,00 A4
M 20	x	110	S	1	1040,00 A4
M 20	x	120	S	1	1130,00 A4
M 20	x	130	S	1	1320,00 A4
M 20	x	140	S	1	1440,00 A4
M 20	x	150	S	1	1570,00 A4
M 20	x	160	S	1	2030,00 A4
M 20	x	170	S	1	2330,00 A4
M 20	x	180	S	1	2330,00 A4
M 20	x	190	S	1	2650,00 A4
M 20	x	200	S	1	2650,00 A4
M 20	x	210	S	1	3050,00 A4
M 20	x	220	S	1	3050,00 A4
M 20	x	230	S	1	3400,00 A4
M 20	x	240	S	1	3400,00 A4
M 20	x	250	S	1	4500,00 A4
M 20	x	260*	S	1	4500,00 A4
M 20	x	270*	S	1	4950,00 A4
M 20	x	280*	S	1	4950,00 A4

Abmessungen	VE	Stück	€/100/0bf.
M 20 x 290*	S	1	5400,00 A4
M 20 x 300*	S	1	5400,00 A4
M 22 x 70	S	10	1680,00 A4
M 22 x 80	S	10	1680,00 A4
M 22 x 90	S	10	1810,00 A4
M 22 x 100	S	10	1980,00 A4
M 22 x 110	S	10	2270,00 A4
M 22 x 120	S	10	2460,00 A4
M 22 x 130	S	10	2650,00 A4
M 22 x 140	S	10	3050,00 A4
M 22 x 150	S	10	3300,00 A4
M 22 x 160	S	10	3550,00 A4
M 22 x 170	S	10	4000,00 A4
M 22 x 180	S	10	3900,00 A4
M 22 x 200	S	10	4400,00 A4
M 24 x 75	S	1	1520,00 A4
M 24 x 80	S	1	1280,00 A4
M 24 x 85	S	1	1730,00 A4
M 24 x 90	S	1	1390,00 A4
M 24 x 100	S	1	1540,00 A4
M 24 x 110	S	1	1740,00 A4
M 24 x 120	S	1	1840,00 A4
M 24 x 130	S	1	2000,00 A4
M 24 x 140	S	1	2210,00 A4
M 24 x 150	S	1	2350,00 A4
M 24 x 160	S	1	3150,00 A4
M 24 x 170	S	1	3500,00 A4
M 24 x 180	S	1	3500,00 A4
M 24 x 190	S	1	3900,00 A4
M 24 x 200	S	1	3900,00 A4
M 24 x 210	S	1	5100,00 A4
M 24 x 220	S	1	5100,00 A4
M 24 x 230	S	1	5600,00 A4
M 24 x 240	S	1	5600,00 A4
M 24 x 250	S	1	6100,00 A4
M 24 x 260*	S	1	6100,00 A4
M 24 x 270*	S	1	6600,00 A4
M 24 x 280*	S	1	6600,00 A4
M 24 x 290*	S	1	7100,00 A4
M 24 x 300*	S	1	7100,00 A4
M 27 x 90	S	1	2850,00 A4
M 27 x 100	S	1	3100,00 A4
M 27 x 110	S	1	3350,00 A4
M 27 x 120	S	1	3550,00 A4
M 27 x 130	S	1	3700,00 A4
M 27 x 140	S	1	3900,00 A4
M 27 x 150	S	1	4150,00 A4
M 27 x 160*	S	1	4400,00 A4
M 27 x 170*	S	1	4850,00 A4
M 27 x 180*	S	1	4850,00 A4
M 27 x 190*	S	1	5300,00 A4
M 27 x 200*	S	1	5300,00 A4
M 27 x 210*	S	1	6800,00 A4
M 27 x 220*	S	1	6800,00 A4
M 27 x 230*	S	1	7400,00 A4
M 27 x 240*	S	1	7400,00 A4
M 27 x 250*	S	1	8100,00 A4
M 27 x 260*	S	1	8700,00 A4
M 27 x 280*	S	1	9900,00 A4
M 30 x 90*	S	1	3550,00 A4
M 30 x 100*	S	1	3850,00 A4
M 30 x 110*	S	1	4150,00 A4
M 30 x 120*	S	1	4400,00 A4
M 30 x 130*	S	1	4600,00 A4
M 30 x 140*	S	1	4900,00 A4
M 30 x 150*	S	1	5200,00 A4
M 30 x 160*	S	1	5500,00 A4
M 30 x 170*	S	1	6100,00 A4
M 30 x 180*	S	1	6100,00 A4
M 30 x 190*	S	1	6600,00 A4
M 30 x 200*	S	1	6600,00 A4
M 30 x 210*	S	1	8000,00 A4
M 30 x 220*	S	1	8000,00 A4
M 30 x 240*	S	1	8600,00 A4
M 30 x 250*	S	1	9500,00 A4

Abmessungen	VE	Stück	€/100/0bf.
M 30 x 260*	S	1	10000,00 A4
M 30 x 280*	S	1	11000,00 A4
M 30 x 300*	S	1	12000,00 A4
M 33 x 90*	S	1	4950,00 A4
M 33 x 100*	S	1	5400,00 A4
M 33 x 110*	S	1	5700,00 A4
M 33 x 120*	S	1	6100,00 A4
M 33 x 130*	S	1	6500,00 A4
M 33 x 140*	S	1	6800,00 A4
M 33 x 150*	S	1	7200,00 A4
M 33 x 160*	S	1	7600,00 A4
M 33 x 170*	S	1	8300,00 A4
M 33 x 180*	S	1	8300,00 A4
M 33 x 190*	S	1	9000,00 A4
M 33 x 200*	S	1	9000,00 A4
M 33 x 210*	S	1	10200,00 A4
M 33 x 220*	S	1	10200,00 A4
M 33 x 230*	S	1	11400,00 A4
M 33 x 240*	S	1	11400,00 A4
M 33 x 250*	S	1	12200,00 A4
M 36 x 100*	S	1	6600,00 A4
M 36 x 110*	S	1	7000,00 A4
M 36 x 120*	S	1	7500,00 A4
M 36 x 130*	S	1	7800,00 A4
M 36 x 140*	S	1	8300,00 A4
M 36 x 150*	S	1	8700,00 A4
M 36 x 160*	S	1	9200,00 A4
M 36 x 170*	S	1	10600,00 A4
M 36 x 180*	S	1	10600,00 A4
M 36 x 190*	S	1	11500,00 A4
M 36 x 200*	S	1	11500,00 A4
M 36 x 220*	S	1	12800,00 A4
M 36 x 230*	S	1	14200,00 A4
M 36 x 240*	S	1	14200,00 A4
M 36 x 250*	S	1	15600,00 A4

Abmessungen	VE	Stück	€/100/0bf.
M 10 x 150	S	1	800,00 A4-70
M 12 x 50	S	50	147,00 A4-70
M 12 x 55	S	50	162,00 A4-70
M 12 x 60	S	50	166,00 A4-70
M 12 x 65	S	50	197,00 A4-70
M 12 x 70	S	50	200,00 A4-70
M 12 x 75	S	25	365,00 A4-70
M 12 x 80	S	25	235,00 A4-70
M 12 x 85	S	50	360,00 A4-70
M 12 x 90	S	25	290,00 A4-70
M 12 x 100	S	25	340,00 A4-70
M 12 x 110	S	25	415,00 A4-70
M 12 x 120	S	25	510,00 A4-70
M 12 x 140	S	1	760,00 A4-70
M 12 x 150	S	1	880,00 A4-70
M 16 x 55	S	25	365,00 A4-70
M 16 x 60	S	25	365,00 A4-70
M 16 x 65	S	25	395,00 A4-70
M 16 x 70	S	25	400,00 A4-70
M 16 x 75	S	25	510,00 A4-70
M 16 x 80	S	25	435,00 A4-70
M 16 x 85	S	25	610,00 A4-70
M 16 x 90	S	25	485,00 A4-70
M 16 x 100	S	25	530,00 A4-70
M 16 x 110	S	25	660,00 A4-70
M 16 x 120	S	25	750,00 A4-70
M 16 x 130	S	1	890,00 A4-70
M 16 x 140	S	1	980,00 A4-70
M 16 x 150	S	1	1080,00 A4-70
M 16 x 160	S	1	1410,00 A4-70
M 16 x 170	S	1	1630,00 A4-70
M 16 x 180	S	1	1630,00 A4-70
M 16 x 200	S	1	1830,00 A4-70
M 20 x 65	S	25	620,00 A4-70
M 20 x 70	S	25	640,00 A4-70
M 20 x 75	S	25	760,00 A4-70
M 20 x 80	S	25	670,00 A4-70
M 20 x 90	S	25	770,00 A4-70
M 20 x 100	S	25	850,00 A4-70
M 20 x 110	S	25	1050,00 A4-70
M 20 x 120	S	20	1130,00 A4-70
M 20 x 130	S	20	1310,00 A4-70
M 20 x 140	S	1	1440,00 A4-70
M 20 x 150	S	1	1560,00 A4-70
M 20 x 160	S	1	2030,00 A4-70
M 20 x 170	S	1	2180,00 A4-70
M 20 x 180	S	1	2330,00 A4-70
M 20 x 190	S	1	2550,00 A4-70
M 20 x 200	S	1	2650,00 A4-70
M 24 x 90	S	1	1400,00 A4-70
M 24 x 100	S	1	1520,00 A4-70
M 24 x 110	S	1	1620,00 A4-70
M 24 x 120	S	1	1840,00 A4-70
M 24 x 150	S	1	2360,00 A4-70

ISO 04014.947
4014 A 4 - 70 AD W2

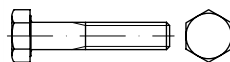

Sechskantschrauben mit Schaft

kurze Abmessungen z. T. Gewinde bis Kopf, für Druckbehälterbau nach AD-Regelwerk, Fabrikate mit Verzicht eines Abnahmeprüfzeugnis, *M 10/12= RAZ 3223 übrige Ø = RAZ 401

Maße → TI-15 Anziehmomente → TI-249
 Werkstoffeigensch. → TI-236 Normumstellung → TI-6

Stahl → S. 236
 Messing → S. 636

ISO 4014 → ersetzt DIN 931

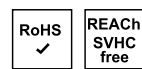

M 10 x 50	S	100	107,00 A4-70
M 10 x 55	S	100	119,00 A4-70
M 10 x 60	S	100	123,00 A4-70
M 10 x 65	S	100	144,00 A4-70
M 10 x 70	S	100	149,00 A4-70
M 10 x 75	S	50	255,00 A4-70
M 10 x 80	S	50	178,00 A4-70
M 10 x 90	S	50	246,00 A4-70
M 10 x 100	S	50	310,00 A4-70
M 10 x 110	S	50	390,00 A4-70
M 10 x 120	S	50	480,00 A4-70
M 10 x 130	S	1	620,00 A4-70
M 10 x 140	S	1	710,00 A4-70



- ✓ Große Artikelvielfalt
- ✓ Verlässliche Qualität
- ✓ Hohe Lieferbereitschaft

Abmessungen	VE Stück	€/100/Obf.
ISO 04014.948		
4014	A 4 - 80	

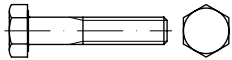

Sechskantschrauben mit Schaft

kurze Abmessungen z. T. Gewinde bis Kopf, hochfest (stark kaltverfestigt)

Maße → **TI-15** Anziehungsmomente → **TI-249**
 Werkstoffeigensch. → **TI-236** Normumstellung → **TI-6**
 Stahl → **S. 236**
 Messing → **S. 636**

ISO 4014 → ersetzt DIN 931

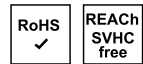

M 5	x	25	S	200	57,00 A4-80
M 5	x	30	S	200	61,00 A4-80
M 5	x	35	S	200	67,00 A4-80
M 5	x	40	S	200	73,00 A4-80
M 5	x	50	S	200	104,00 A4-80
M 5	x	60	S	200	181,00 A4-80
M 5	x	70	S	100	380,00 A4-80
M 5	x	80	S	100	1180,00 A4-80
M 6	x	30	S	100	61,00 A4-80
M 6	x	35	S	100	66,00 A4-80
M 6	x	40	S	100	71,00 A4-80
M 6	x	45	S	100	81,00 A4-80
M 6	x	50	S	100	92,00 A4-80
M 6	x	55	S	100	128,00 A4-80
M 6	x	60	S	100	147,00 A4-80
M 6	x	65	S	100	177,00 A4-80
M 6	x	70	S	100	183,00 A4-80
M 6	x	80	S	50	229,00 A4-80
M 6	x	90	S	50	305,00 A4-80
M 6	x	100	S	50	335,00 A4-80
M 6	x	110	S	50	445,00 A4-80
M 6	x	120	S	50	540,00 A4-80
M 6	x	130	S	50	920,00 A4-80
M 6	x	140	S	50	1010,00 A4-80
M 6	x	150	S	50	1120,00 A4-80
M 8	x	35	S	100	133,00 A4-80
M 8	x	40	S	100	133,00 A4-80
M 8	x	45	S	100	141,00 A4-80
M 8	x	50	S	100	152,00 A4-80
M 8	x	55	S	100	179,00 A4-80
M 8	x	60	S	100	183,00 A4-80
M 8	x	65	S	100	240,00 A4-80
M 8	x	70	S	50	255,00 A4-80
M 8	x	75	S	50	550,00 A4-80
M 8	x	80	S	50	380,00 A4-80
M 8	x	90	S	50	445,00 A4-80
M 8	x	100	S	50	530,00 A4-80
M 8	x	110	S	50	640,00 A4-80
M 8	x	120	S	50	740,00 A4-80
M 8	x	130	S	50	920,00 A4-80
M 8	x	140	S	1	1070,00 A4-80
M 8	x	150	S	1	1220,00 A4-80
M 8	x	160	S	1	1540,00 A4-80
M 10	x	40	S	100	246,00 A4-80
M 10	x	45	S	100	250,00 A4-80
M 10	x	50	S	100	265,00 A4-80
M 10	x	55	S	50	295,00 A4-80
M 10	x	60	S	50	305,00 A4-80
M 10	x	65	S	50	355,00 A4-80
M 10	x	70	S	50	365,00 A4-80
M 10	x	75	S	50	660,00 A4-80

Abmessungen	VE Stück	€/100/Obf.			
M 10	x	80	S	50	440,00 A4-80
M 10	x	90	S	50	610,00 A4-80
M 10	x	100	S	50	770,00 A4-80
M 10	x	110	S	25	980,00 A4-80
M 10	x	120	S	25	1200,00 A4-80
M 10	x	130	S	1	1540,00 A4-80
M 10	x	140	S	1	3750,00 A4-80
M 10	x	150	S	1	2000,00 A4-80
M 10	x	160	S	1	2480,00 A4-80
M 10	x	170	S	1	3050,00 A4-80
M 10	x	180	S	1	3550,00 A4-80
M 10	x	190	S	1	4000,00 A4-80
M 10	x	200	S	1	4550,00 A4-80
M 10	x	220	S	1	5600,00 A4-80
M 12	x	45	S	50	365,00 A4-80
M 12	x	50	S	50	370,00 A4-80
M 12	x	55	S	50	410,00 A4-80
M 12	x	60	S	50	415,00 A4-80
M 12	x	65	S	50	495,00 A4-80
M 12	x	70	S	25	500,00 A4-80
M 12	x	75	S	25	910,00 A4-80
M 12	x	80	S	25	590,00 A4-80
M 12	x	90	S	25	720,00 A4-80
M 12	x	100	S	25	850,00 A4-80
M 12	x	110	S	25	1040,00 A4-80
M 12	x	120	S	25	1280,00 A4-80
M 12	x	130	S	1	1620,00 A4-80
M 12	x	140	S	1	2400,00 A4-80
M 12	x	150	S	1	2190,00 A4-80
M 12	x	160	S	1	2850,00 A4-80
M 12	x	170	S	1	4100,00 A4-80
M 12	x	180	S	1	3550,00 A4-80
M 12	x	190	S	1	4100,00 A4-80
M 12	x	200	S	1	4400,00 A4-80
M 12	x	220	S	1	5700,00 A4-80
M 14	x	50	S	50	910,00 A4-80
M 14	x	55	S	50	910,00 A4-80
M 14	x	60	S	50	910,00 A4-80
M 14	x	70	S	50	1000,00 A4-80
M 14	x	80	S	50	1100,00 A4-80
M 14	x	90	S	50	1220,00 A4-80
M 14	x	100	S	50	1310,00 A4-80
M 14	x	110	S	1	1640,00 A4-80
M 16	x	55	S	25	910,00 A4-80
M 16	x	60	S	25	910,00 A4-80
M 16	x	65	S	25	990,00 A4-80
M 16	x	70	S	25	1000,00 A4-80
M 16	x	75	S	25	1280,00 A4-80
M 16	x	80	S	25	1100,00 A4-80
M 16	x	85	S	25	1490,00 A4-80
M 16	x	90	S	25	1220,00 A4-80
M 16	x	100	S	25	1310,00 A4-80
M 16	x	110	S	25	1640,00 A4-80
M 16	x	120	S	25	1870,00 A4-80
M 16	x	130	S	1	2210,00 A4-80
M 16	x	140	S	1	2460,00 A4-80
M 16	x	150	S	1	2700,00 A4-80
M 16	x	160	S	1	3550,00 A4-80
M 16	x	170	S	1	3850,00 A4-80
M 16	x	180	S	1	4100,00 A4-80
M 16	x	190	S	1	4400,00 A4-80
M 16	x	200	S	1	4600,00 A4-80
M 16	x	220	S	1	5500,00 A4-80
M 20	x	65	S	1	1540,00 A4-80
M 20	x	70	S	1	1600,00 A4-80
M 20	x	75	S	1	1890,00 A4-80
M 20	x	80	S	1	1680,00 A4-80
M 20	x	90	S	1	1910,00 A4-80
M 20	x	100	S	1	2120,00 A4-80
M 20	x	110	S	1	2650,00 A4-80
M 20	x	120	S	1	2850,00 A4-80
M 20	x	130	S	1	3300,00 A4-80
M 20	x	140	S	1	3650,00 A4-80
M 20	x	150	S	1	3950,00 A4-80
M 20	x	160	S	1	5100,00 A4-80

Abmessungen	VE Stück	€/100/Obf.			
M 20	x	170	S	1	5700,00 A4-80
M 20	x	180	S	1	5900,00 A4-80
M 20	x	190	S	1	6200,00 A4-80
M 20	x	200	S	1	6700,00 A4-80
M 20	x	220	S	1	7600,00 A4-80
M 24	x	80	S	1	3250,00 A4-80
M 24	x	90	S	1	3500,00 A4-80
M 24	x	100	S	1	3900,00 A4-80
M 24	x	110	S	1	4350,00 A4-80
M 24	x	120	S	1	4600,00 A4-80
M 24	x	130	S	1	5100,00 A4-80
M 24	x	150	S	1	5900,00 A4-80
M 24	x	160	S	1	7900,00 A4-80
M 24	x	170	S	1	8800,00 A4-80
M 24	x	180	S	1	9300,00 A4-80
M 24	x	190	S	1	9800,00 A4-80
M 24	x	200	S	1	9800,00 A4-80
M 24	x	220	S	1	12800,00 A4-80

Abmessungen	VE Stück	€/100/Obf.
ISO 04014.912		
4014	Mu A 4	SB

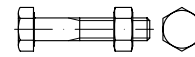

SB-Schrauben-Garnituren EN 15048, Mu = mit Sechskantmutter ISO 4032 SB = nach EN 15048

für nicht planmäßig vorgespannte Verbindungen im Stahlbau mit Abnahmeprüfzeugnis 3.1, Preise gelten zzgl. APZ-Kosten

Maße → **TI-15** Anziehungsmomente → **TI-248**
 Werkstoffeigensch. → **TI-236** Normumstellung → **TI-6**

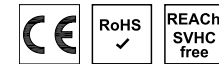

M 12	x	60	S	50	475,00 A4
M 12	x	70	S	50	520,00 A4
M 12	x	80	S	50	570,00 A4
M 12	x	90	S	25	620,00 A4
M 12	x	100	S	25	750,00 A4
M 12	x	110	S	25	930,00 A4
M 12	x	120	S	25	1030,00 A4
M 16	x	60	S	25	950,00 A4
M 16	x	70	S	25	1030,00 A4
M 16	x	80	S	25	1110,00 A4
M 16	x	90	S	25	1310,00 A4
M 16	x	100	S	25	1400,00 A4
M 16	x	110	S	25	1780,00 A4
M 16	x	120	S	25	1810,00 A4
M 16	x	130	S	10	1880,00 A4
M 16	x	140	S	10	2330,00 A4
M 16	x	150	S	10	2700,00 A4
M 16	x	160	S	10	2800,00 A4
M 20	x	70	S	10	1610,00 A4
M 20	x	80	S	10	1760,00 A4
M 20	x	90	S	10	1930,00 A4
M 20	x	100	S	10	2050,00 A4
M 20	x	120	S	10	2800,00 A4
M 20	x	140	S	10	3700,00 A4
M 20	x	160	S	10	4350,00 A4
M 20	x	180	S	10	5100,00 A4
M 24	x	80	S	10	2950,00 A4
M 24	x	90	S	10	3150,00 A4
M 24	x	100	S	10	3350,00 A4
M 24	x	120	S	10	4550,00 A4

Abmessungen	VE	Stück	€/100/Obf.
M 24 x 140	S	5	6200,00 A4
M 24 x 160	S	5	6900,00 A4
M 24 x 180	S	5	8000,00 A4

ISO	04014.950
4014	1.4571 (A 5)

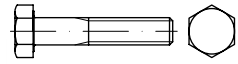

Sechskantschrauben mit Schaft

kurze Abmessungen z. T. Gewinde bis Kopf

Maße → **TI-15** Anziehmomente → **TI-249**
 Werkstoffeigensch. → **TI-236** Normumstellung → **TI-6**
 Stahl → **S. 236**
 Messing → **S. 636**

ISO 4014 → ersetzt DIN 931



M 6 x 30	S	100	80,00 A5
M 6 x 35	S	100	85,00 A5
M 6 x 40	S	100	93,00 A5
M 6 x 50	S	100	120,00 A5
M 8 x 70	S	50	335,00 A5
M 8 x 80	S	50	490,00 A5
M 10 x 60	S	50	400,00 A5
M 10 x 70	S	50	475,00 A5
M 10 x 80	S	50	580,00 A5
M 10 x 90	S	50	800,00 A5
M 10 x 100	S	50	1000,00 A5
M 10 x 110	S	25	1280,00 A5
M 10 x 120	S	25	1580,00 A5
M 12 x 70	S	25	660,00 A5
M 12 x 80	S	25	770,00 A5
M 12 x 90	S	25	940,00 A5
M 12 x 100	S	25	1120,00 A5
M 12 x 110	S	25	1370,00 A5
M 12 x 120	S	25	1680,00 A5
M 16 x 55	S	1	1310,00 A5
M 16 x 60	S	1	1350,00 A5
M 16 x 65	S	1	1390,00 A5
M 16 x 70	S	1	1430,00 A5
M 16 x 80	S	1	1490,00 A5
M 16 x 90	S	1	1580,00 A5
M 16 x 100	S	1	1640,00 A5
M 16 x 110	S	1	1750,00 A5
M 16 x 120	S	1	1830,00 A5
M 16 x 130	S	1	1910,00 A5
M 16 x 140	S	1	2020,00 A5
M 16 x 150	S	1	2120,00 A5
M 16 x 160	S	1	2230,00 A5
M 20 x 65	S	1	1930,00 A5
M 20 x 70	S	1	1980,00 A5
M 20 x 80	S	1	2100,00 A5
M 20 x 85	S	1	2170,00 A5
M 20 x 90	S	1	2380,00 A5
M 20 x 100	S	1	2440,00 A5
M 20 x 110	S	1	2480,00 A5
M 20 x 120	S	1	2600,00 A5
M 20 x 130	S	1	2750,00 A5
M 20 x 140	S	1	2850,00 A5
M 20 x 150	S	1	3050,00 A5
M 20 x 160	S	1	3300,00 A5
M 20 x 170	S	1	3700,00 A5
M 20 x 180	S	1	4250,00 A5

Abmessungen	VE	Stück	€/100/Obf.
ISO	04017.920		
4017	A 2 (- 70)*		

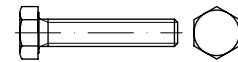

Sechskantschrauben mit Gewinde bis Kopf

**M 10/12/14/22 = RAZ 3220 übrige Ø = RAZ 401

Maße → **TI-15** Anziehmomente → **TI-249**
 Werkstoffeigensch. → **TI-236** Normumstellung → **TI-6**
 Stahl → **S. 254**
 Messing → **S. 636**

ISO 4017 → ersetzt DIN 933

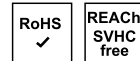

*Fkl. bei diesen Abmessungen je nach Fabrikat abweichend

M 3 x 6*	S	100	15,50 A2
M 3 x 8*	S	100	11,10 A2
M 3 x 10*	S	100	10,60 A2
M 3 x 12*	S	100	9,90 A2
M 3 x 14*	S	100	13,10 A2
M 3 x 16*	S	100	9,90 A2
M 3 x 20*	S	100	11,10 A2
M 3 x 25*	S	100	12,00 A2
M 3 x 30*	S	100	14,40 A2
M 3 x 35*	S	100	20,70 A2
M 3 x 40*	S	100	31,00 A2
M 4 x 6*	S	200	15,50 A2
M 4 x 8*	S	200	11,10 A2
M 4 x 10*	S	200	10,60 A2
M 4 x 12*	S	200	9,90 A2
M 4 x 14*	S	100	13,10 A2
M 4 x 16*	S	200	8,10 A2
M 4 x 18*	S	100	10,60 A2
M 4 x 20*	S	200	8,80 A2
M 4 x 22*	S	100	12,20 A2
M 4 x 25*	S	200	10,10 A2
M 4 x 30*	S	200	11,30 A2
M 4 x 35*	S	200	19,40 A2
M 4 x 40*	S	200	23,10 A2
M 4 x 45*	S	100	29,50 A2
M 4 x 50*	S	100	35,00 A2
M 4 x 60*	S	100	107,00 A2
M 5 x 6*	S	100	33,00 A2
M 5 x 8*	S	100	11,10 A2
M 5 x 10	S	500	10,60 A2
M 5 x 10	K	100	14,60 A2
M 5 x 12	S	500	9,90 A2
M 5 x 12	K	100	13,80 A2
M 5 x 14	S	500	13,10 A2
M 5 x 14	K	100	17,80 A2
M 5 x 16	S	500	8,10 A2
M 5 x 16	K	100	12,00 A2
M 5 x 18	S	500	10,60 A2
M 5 x 18	K	100	15,40 A2
M 5 x 20	S	500	8,80 A2
M 5 x 20	K	100	12,60 A2
M 5 x 22	S	200	12,20 A2
M 5 x 25	S	200	11,60 A2
M 5 x 25	K	100	15,60 A2
M 5 x 30	S	200	13,00 A2
M 5 x 30	K	100	16,90 A2
M 5 x 35	S	200	15,30 A2
M 5 x 40	S	200	22,00 A2
M 5 x 45	S	200	29,50 A2
M 5 x 50	S	200	35,00 A2

Abmessungen	VE	Stück	€/100/Obf.
M 5 x 55	S	200	41,50 A2
M 5 x 60	S	200	44,50 A2
M 5 x 70	S	100	117,00 A2
M 5 x 80	S	100	395,00 A2
M 6 x 6*	S	100	127,00 A2
M 6 x 8*	S	100	15,50 A2
M 6 x 10	S	500	13,10 A2
M 6 x 10	K	100	17,00 A2
M 6 x 12	S	500	13,10 A2
M 6 x 12	K	100	17,00 A2
M 6 x 14	S	500	15,60 A2
M 6 x 14	K	100	20,30 A2
M 6 x 16	S	200	9,30 A2
M 6 x 16	K	100	13,30 A2
M 6 x 18	S	200	13,30 A2
M 6 x 20	S	200	10,60 A2
M 6 x 20	K	100	14,60 A2
M 6 x 22	S	200	14,80 A2
M 6 x 25	S	200	11,90 A2
M 6 x 25	K	100	15,80 A2
M 6 x 30	S	200	13,80 A2
M 6 x 30	K	100	17,60 A2
M 6 x 35	S	200	15,00 A2
M 6 x 35	K	100	19,00 A2
M 6 x 40	S	200	16,80 A2
M 6 x 40	K	100	20,70 A2
M 6 x 45	S	100	26,50 A2
M 6 x 50	S	100	28,50 A2
M 6 x 55	S	100	36,50 A2
M 6 x 60	S	100	41,50 A2
M 6 x 65	S	100	57,00 A2
M 6 x 70	S	100	57,00 A2
M 6 x 75	S	100	85,00 A2
M 6 x 80	S	100	68,00 A2
M 6 x 90	S	100	97,00 A2
M 6 x 100	S	100	112,00 A2
M 6 x 110	S	100	435,00 A2
M 6 x 120	S	100	510,00 A2
M 8 x 8*	S	100	147,00 A2
M 8 x 10	S	200	30,50 A2
M 8 x 10	K	100	34,50 A2
M 8 x 12	S	200	28,50 A2
M 8 x 12	K	100	32,50 A2
M 8 x 14	S	200	34,00 A2
M 8 x 16	S	200	19,40 A2
M 8 x 16	K	100	23,30 A2
M 8 x 18	S	200	24,10 A2
M 8 x 20	S	200	19,40 A2
M 8 x 20	K	100	24,30 A2
M 8 x 22	S	200	29,00 A2
M 8 x 25	S	200	22,90 A2
M 8 x 25	K	100	27,00 A2
M 8 x 30	S	200	24,30 A2
M 8 x 30	K	100	28,50 A2
M 8 x 35	S	200	30,50 A2
M 8 x 35	K	100	40,00 A2
M 8 x 40	S	200	29,00 A2
M 8 x 40	K	100	33,00 A2
M 8 x 45	S	200	32,00 A2
M 8 x 45	K	100	36,00 A2
M 8 x 50	S	200	34,00 A2
M 8 x 50	K	100	38,50 A2
M 8 x 55	S	100	52,00 A2
M 8 x 60	S	200	55,00 A2
M 8 x 60	K	100	59,00 A2
M 8 x 65	S	50	68,00 A2
M 8 x 70	S	50	81,00 A2
M 8 x 75	S	50	127,00 A2
M 8 x 80	S	50	102,00 A2
M 8 x 85	S	50	163,00 A2
M 8 x 90	S	50	130,00 A2
M 8 x 100	S	50	147,00 A2
M 8 x 110	S	50	220,00 A2
M 8 x 120	S	50	260,00 A2
M 8 x 130	S	50	325,00 A2

Abmessungen	VE	Stück	€/100/Obf.	Abmessungen	VE	Stück	€/100/Obf.	Abmessungen	VE	Stück	€/100/Obf.
M 8 x 140	S	50	390,00A2	M 14 x 55	S	50	152,00A2	M 20 x 140	S	10	1260,00A2
M 8 x 150	S	50	455,00A2	M 14 x 60	S	50	158,00A2	M 20 x 150	S	10	1370,00A2
M 8 x 160	S	50	530,00A2	M 14 x 65	S	50	173,00A2	M 20 x 160	S	10	2130,00A2
M 8 x 170	S	50	650,00A2	M 14 x 70	S	50	220,00A2	M 20 x 170	S	10	2210,00A2
M 8 x 180	S	50	650,00A2	M 14 x 75	S	50	300,00A2	M 20 x 180	S	10	2210,00A2
M 8 x 190	S	50	1240,00A2	M 14 x 80	S	50	248,00A2	M 20 x 200	S	10	2410,00A2
M 8 x 200	S	50	1630,00A2	M 14 x 90	S	50	405,00A2	M 20 x 220*	S	10	2950,00A2
M 10 x 10*	S	100	245,00A2	M 14 x 100	S	50	465,00A2	M 22 x 30	S	25	1360,00A2
M 10 x 12	S	100	79,00A2	M 14 x 110	S	25	580,00A2	M 22 x 35	S	25	1360,00A2
M 10 x 14	S	100	93,00A2	M 14 x 120	S	25	650,00A2	M 22 x 40	S	25	1360,00A2
M 10 x 16	S	100	57,00A2	M 14 x 130	S	25	770,00A2	M 22 x 50	S	25	840,00A2
M 10 x 18	S	100	63,00A2	M 14 x 140	S	25	870,00A2	M 22 x 55	S	1	880,00A2
M 10 x 20	S	100	41,50A2	M 14 x 150	S	25	950,00A2	M 22 x 60	S	10	1440,00A2
M 10 x 22	S	100	49,00A2	M 16 x 20	S	50	218,00A2	M 22 x 65	S	10	1580,00A2
M 10 x 25	S	100	39,50A2	M 16 x 25	S	50	181,00A2	M 22 x 70	S	10	1610,00A2
M 10 x 30	S	100	44,00A2	M 16 x 30	S	50	132,00A2	M 22 x 80	S	1	1070,00A2
M 10 x 35	S	100	48,50A2	M 16 x 35	S	50	132,00A2	M 22 x 90	S	1	1320,00A2
M 10 x 40	S	100	53,00A2	M 16 x 40	S	50	141,00A2	M 22 x 100	S	10	2650,00A2
M 10 x 45	S	100	56,00A2	M 16 x 45	S	50	151,00A2	M 22 x 110	S	1	2330,00A2
M 10 x 50	S	100	60,00A2	M 16 x 50	S	50	160,00A2	M 22 x 120	S	10	3200,00A2
M 10 x 55	S	100	84,00A2	M 16 x 55	S	25	171,00A2	M 22 x 130	S	1	2430,00A2
M 10 x 60	S	100	89,00A2	M 16 x 60	S	25	182,00A2	M 22 x 140	S	1	2470,00A2
M 10 x 65	S	100	101,00A2	M 16 x 65	S	25	195,00A2	M 24 x 40	S	20	1070,00A2
M 10 x 70	S	100	106,00A2	M 16 x 70	S	25	203,00A2	M 24 x 45	S	20	1070,00A2
M 10 x 75	S	50	169,00A2	M 16 x 75	S	25	241,00A2	M 24 x 50	S	20	570,00A2
M 10 x 80	S	50	127,00A2	M 16 x 80	S	25	241,00A2	M 24 x 55	S	10	590,00A2
M 10 x 85	S	50	218,00A2	M 16 x 85	S	25	495,00A2	M 24 x 60	S	10	610,00A2
M 10 x 90	S	50	171,00A2	M 16 x 90	S	25	405,00A2	M 24 x 65	S	10	640,00A2
M 10 x 100	S	50	218,00A2	M 16 x 100	S	25	465,00A2	M 24 x 70	S	10	670,00A2
M 10 x 110	S	50	325,00A2	M 16 x 110	S	25	580,00A2	M 24 x 80	S	10	720,00A2
M 10 x 120	S	50	355,00A2	M 16 x 120	S	25	650,00A2	M 24 x 90	S	1	1010,00A2
M 10 x 130	S	1	445,00A2	M 16 x 130	S	25	770,00A2	M 24 x 100	S	1	1220,00A2
M 10 x 140	S	1	530,00A2	M 16 x 140	S	25	870,00A2	M 24 x 110	S	1	1430,00A2
M 10 x 150	S	1	600,00A2	M 16 x 150	S	25	950,00A2	M 24 x 120	S	1	1580,00A2
M 10 x 160	S	1	680,00A2	M 16 x 160	S	25	1690,00A2	M 24 x 130	S	1	1710,00A2
M 10 x 170	S	1	840,00A2	M 16 x 170	S	25	1740,00A2	M 24 x 140	S	1	1890,00A2
M 10 x 180	S	1	840,00A2	M 16 x 180	S	25	1740,00A2	M 24 x 150	S	1	2040,00A2
M 10 x 190	S	1	1320,00A2	M 16 x 190	S	10	1920,00A2	M 24 x 160	S	1	2950,00A2
M 10 x 200	S	1	1450,00A2	M 16 x 200	S	10	1920,00A2	M 24 x 170	S	1	3050,00A2
M 12 x 16	S	100	118,00A2	M 18 x 30	S	25	500,00A2	M 24 x 180	S	1	3050,00A2
M 12 x 20	S	100	80,00A2	M 18 x 35	S	25	405,00A2	M 24 x 190	S	1	3150,00A2
M 12 x 22	S	100	95,00A2	M 18 x 40	S	25	375,00A2	M 24 x 200	S	1	3150,00A2
M 12 x 25	S	100	60,00A2	M 18 x 45	S	25	400,00A2	M 27 x 50	S	1	1060,00A2
M 12 x 30	S	100	63,00A2	M 18 x 50	S	25	425,00A2	M 27 x 55	S	1	1160,00A2
M 12 x 35	S	100	69,00A2	M 18 x 55	S	25	460,00A2	M 27 x 60	S	1	1170,00A2
M 12 x 40	S	100	74,00A2	M 18 x 60	S	25	470,00A2	M 27 x 65	S	1	1270,00A2
M 12 x 45	S	100	79,00A2	M 18 x 65	S	25	520,00A2	M 27 x 70	S	1	1270,00A2
M 12 x 50	S	50	85,00A2	M 18 x 70	S	25	540,00A2	M 27 x 80	S	1	1370,00A2
M 12 x 55	S	50	91,00A2	M 18 x 75	S	25	620,00A2	M 27 x 90	S	1	1470,00A2
M 12 x 60	S	50	97,00A2	M 18 x 80	S	25	620,00A2	M 27 x 100	S	1	1560,00A2
M 12 x 65	S	50	139,00A2	M 18 x 90	S	25	1010,00A2	M 27 x 110	S	1	1780,00A2
M 12 x 70	S	50	148,00A2	M 18 x 100	S	25	1140,00A2	M 27 x 120	S	1	1890,00A2
M 12 x 75	S	50	216,00A2	M 18 x 110	S	1	1300,00A2	M 27 x 130	S	1	2040,00A2
M 12 x 80	S	50	178,00A2	M 18 x 120	S	1	1440,00A2	M 27 x 140	S	1	2150,00A2
M 12 x 85	S	50	315,00A2	M 18 x 130	S	1	1740,00A2	M 27 x 150	S	1	2280,00A2
M 12 x 90	S	50	231,00A2	M 18 x 140	S	1	1890,00A2	M 30 x 60*	S	1	1560,00A2
M 12 x 95	S	50	340,00A2	M 18 x 150	S	1	2120,00A2	M 30 x 65*	S	1	1690,00A2
M 12 x 100	S	50	280,00A2	M 20 x 30	S	25	330,00A2	M 30 x 70*	S	1	1760,00A2
M 12 x 110	S	25	330,00A2	M 20 x 35	S	25	270,00A2	M 30 x 80*	S	1	1870,00A2
M 12 x 120	S	25	440,00A2	M 20 x 40	S	25	248,00A2	M 30 x 90*	S	1	2040,00A2
M 12 x 130	S	1	530,00A2	M 20 x 45	S	25	265,00A2	M 30 x 100*	S	1	2220,00A2
M 12 x 140	S	1	620,00A2	M 20 x 50	S	25	285,00A2	M 30 x 110*	S	1	2440,00A2
M 12 x 150	S	1	1050,00A2	M 20 x 55	S	25	310,00A2	M 30 x 120*	S	1	2600,00A2
M 12 x 160	S	1	800,00A2	M 20 x 60	S	25	315,00A2	M 30 x 130*	S	1	2850,00A2
M 12 x 170	S	1	980,00A2	M 20 x 65	S	25	350,00A2	M 30 x 140*	S	1	3050,00A2
M 12 x 180	S	1	980,00A2	M 20 x 70	S	25	360,00A2	M 30 x 150*	S	1	3200,00A2
M 12 x 190	S	1	1600,00A2	M 20 x 75	S	25	410,00A2	M 33 x 70*	S	1	2280,00A2
M 12 x 200	S	1	1790,00A2	M 20 x 80	S	25	410,00A2	M 33 x 80*	S	1	2470,00A2
M 14 x 20	S	50	220,00A2	M 20 x 85	S	25	840,00A2	M 33 x 90*	S	1	2650,00A2
M 14 x 25	S	50	156,00A2	M 20 x 90	S	25	670,00A2	M 33 x 100*	S	1	2850,00A2
M 14 x 30	S	50	112,00A2	M 20 x 95	S	10	670,00A2	M 33 x 110*	S	1	3150,00A2
M 14 x 35	S	50	116,00A2	M 20 x 100	S	10	760,00A2	M 33 x 120*	S	1	3350,00A2
M 14 x 40	S	50	120,00A2	M 20 x 110	S	10	870,00A2	M 33 x 130*	S	1	3500,00A2
M 14 x 45	S	50	127,00A2	M 20 x 120	S	10	960,00A2	M 33 x 140*	S	1	3700,00A2
M 14 x 50	S	50	135,00A2	M 20 x 130	S	10	1160,00A2	M 33 x 150*	S	1	3900,00A2

Abmessungen	VE	Stück	€/100/Obf.
M 36 x 80*	S	1	3200,00 A2
M 36 x 90*	S	1	3400,00 A2
M 36 x 100*	S	1	3650,00 A2
M 36 x 110*	S	1	4050,00 A2
M 36 x 120*	S	1	4250,00 A2
M 36 x 130*	S	1	4300,00 A2
M 36 x 140*	S	1	4550,00 A2
M 36 x 150*	S	1	4750,00 A2

ISO 04017.927
4017 A 2 - 70 AD W2

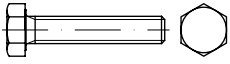

Sechskantschrauben mit Gewinde bis Kopf

für Druckbehälterbau nach AD-Regelwerk, Fabrikate mit Verzicht eines Abnahmeprüfzeugnis, *M 10/12= RAZ 3223 übrige Ø = RAZ 403

Maße → TI-15 Anziehmomente → TI-249
 Werkstoffeigensch. → TI-236 Normumstellung → TI-6

Stahl → S. 254
 Messing → S. 636

ISO 4017 → ersetzt DIN 933

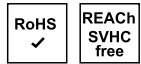

M 10 x 16	S	100	59,00 A2-70
M 10 x 20	S	100	43,00 A2-70
M 10 x 25	S	100	41,00 A2-70
M 10 x 30	S	100	45,50 A2-70
M 10 x 35	S	100	49,50 A2-70
M 10 x 40	S	100	53,00 A2-70
M 10 x 45	S	100	57,00 A2-70
M 10 x 50	S	100	61,00 A2-70
M 12 x 20	S	50	80,00 A2-70
M 12 x 25	S	50	60,00 A2-70
M 12 x 30	S	50	62,00 A2-70
M 12 x 35	S	50	68,00 A2-70
M 12 x 40	S	50	74,00 A2-70
M 12 x 45	S	50	79,00 A2-70
M 12 x 50	S	50	85,00 A2-70
M 12 x 55	S	50	90,00 A2-70
M 12 x 60	S	50	95,00 A2-70
M 12 x 65	S	50	138,00 A2-70
M 12 x 70	S	50	147,00 A2-70
M 12 x 75	S	25	216,00 A2-70
M 12 x 80	S	25	178,00 A2-70
M 16 x 30	S	25	131,00 A2-70
M 16 x 35	S	25	131,00 A2-70
M 16 x 40	S	25	140,00 A2-70
M 16 x 45	S	25	150,00 A2-70
M 16 x 50	S	25	159,00 A2-70
M 16 x 55	S	25	170,00 A2-70
M 16 x 60	S	25	182,00 A2-70
M 16 x 65	S	25	195,00 A2-70
M 16 x 70	S	25	205,00 A2-70
M 16 x 75	S	25	285,00 A2-70
M 16 x 80	S	25	241,00 A2-70
M 16 x 85	S	25	500,00 A2-70
M 16 x 110	S	25	580,00 A2-70
M 16 x 120	S	25	650,00 A2-70
M 20 x 30	S	25	335,00 A2-70
M 20 x 35	S	25	275,00 A2-70
M 20 x 40	S	25	255,00 A2-70
M 20 x 45	S	25	270,00 A2-70
M 20 x 50	S	25	300,00 A2-70

Abmessungen	VE	Stück	€/100/Obf.
M 20 x 55	S	25	315,00 A2-70
M 20 x 60	S	25	315,00 A2-70
M 20 x 65	S	25	355,00 A2-70
M 20 x 70	S	25	360,00 A2-70
M 20 x 75	S	25	415,00 A2-70
M 20 x 80	S	25	415,00 A2-70
M 20 x 90	S	25	680,00 A2-70
M 20 x 120	S	10	970,00 A2-70

ISO 04017.940
4017 A 4 (- 70)*

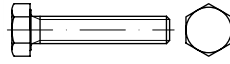

Sechskantschrauben mit Gewinde bis Kopf

**M 10/12/14/22 = RAZ 3220 übrige Ø = RAZ 401

Maße → TI-15 Anziehmomente → TI-249
 Werkstoffeigensch. → TI-236 Normumstellung → TI-6

Stahl → S. 254
 Messing → S. 636

ISO 4017 → ersetzt DIN 933



*Fkl. bei diesen Abmessungen je nach Fabrikat abweichend

M 3 x 5*	S	100	22,50 A4
M 3 x 6*	S	100	18,20 A4
M 3 x 8*	S	100	15,00 A4
M 3 x 10*	S	100	14,50 A4
M 3 x 12*	S	100	13,60 A4
M 3 x 16*	S	100	13,60 A4
M 3 x 18*	S	100	18,70 A4
M 3 x 20*	S	100	14,80 A4
M 3 x 25*	S	100	16,60 A4
M 3 x 30*	S	100	19,20 A4
M 3 x 35*	S	100	30,00 A4
M 3 x 40*	S	100	42,00 A4
M 4 x 6*	S	200	18,20 A4
M 4 x 8*	S	200	15,00 A4
M 4 x 10*	S	200	14,50 A4
M 4 x 12*	S	200	13,60 A4
M 4 x 14*	S	200	16,20 A4
M 4 x 16*	S	200	11,10 A4
M 4 x 18*	S	200	14,60 A4
M 4 x 20*	S	200	11,70 A4
M 4 x 25*	S	200	14,30 A4
M 4 x 30*	S	200	16,20 A4
M 4 x 35*	S	200	28,00 A4
M 4 x 40*	S	200	36,50 A4
M 4 x 45*	S	200	43,00 A4
M 4 x 50*	S	200	46,00 A4
M 4 x 60*	S	100	141,00 A4
M 5 x 6*	S	100	46,00 A4
M 5 x 8*	S	100	15,00 A4
M 5 x 10	S	500	14,50 A4
M 5 x 10	K	100	19,80 A4
M 5 x 12	S	500	13,60 A4
M 5 x 12	K	100	18,80 A4
M 5 x 14	S	500	16,20 A4
M 5 x 14	K	100	21,40 A4
M 5 x 16	S	500	12,10 A4
M 5 x 16	K	100	17,40 A4
M 5 x 18	S	500	16,20 A4
M 5 x 18	K	100	21,40 A4
M 5 x 20	S	500	13,40 A4
M 5 x 20	K	100	18,60 A4

Abmessungen	VE	Stück	€/100/Obf.
M 5 x 22	S	200	19,10 A4
M 5 x 25	S	200	15,40 A4
M 5 x 30	S	200	17,90 A4
M 5 x 35	S	200	26,00 A4
M 5 x 40	S	200	32,50 A4
M 5 x 45	S	200	43,00 A4
M 5 x 50	S	200	46,00 A4
M 5 x 55	S	200	63,00 A4
M 5 x 60	S	200	67,00 A4
M 5 x 70	S	100	153,00 A4
M 5 x 80	S	100	470,00 A4
M 6 x 8*	S	100	23,30 A4
M 6 x 10	S	500	21,20 A4
M 6 x 10	K	100	26,50 A4
M 6 x 12	S	500	19,60 A4
M 6 x 12	K	100	24,80 A4
M 6 x 14	S	500	22,70 A4
M 6 x 14	K	100	28,00 A4
M 6 x 16	S	200	15,40 A4
M 6 x 20	S	200	16,60 A4
M 6 x 22	S	200	22,90 A4
M 6 x 25	S	200	18,30 A4
M 6 x 30	S	200	20,90 A4
M 6 x 35	S	200	24,60 A4
M 6 x 40	S	200	28,00 A4
M 6 x 45	S	100	37,50 A4
M 6 x 50	S	100	43,50 A4
M 6 x 55	S	100	58,00 A4
M 6 x 60	S	100	63,00 A4
M 6 x 65	S	50	99,00 A4
M 6 x 70	S	50	99,00 A4
M 6 x 75	S	50	149,00 A4
M 6 x 80	S	50	120,00 A4
M 6 x 90	S	50	168,00 A4
M 6 x 100	S	50	192,00 A4
M 6 x 110	S	50	580,00 A4
M 6 x 120	S	50	700,00 A4
M 8 x 8*	S	100	91,00 A4
M 8 x 10	S	200	46,00 A4
M 8 x 12	S	200	45,00 A4
M 8 x 14	S	200	54,00 A4
M 8 x 16	S	200	35,50 A4
M 8 x 18	S	200	45,50 A4
M 8 x 20	S	200	35,50 A4
M 8 x 22	S	200	45,50 A4
M 8 x 25	S	200	36,00 A4
M 8 x 30	S	200	38,00 A4
M 8 x 35	S	200	42,50 A4
M 8 x 40	S	100	44,50 A4
M 8 x 45	S	100	53,00 A4
M 8 x 50	S	100	57,00 A4
M 8 x 55	S	100	74,00 A4
M 8 x 60	S	100	80,00 A4
M 8 x 65	S	50	108,00 A4
M 8 x 70	S	50	114,00 A4
M 8 x 75	S	50	174,00 A4
M 8 x 80	S	50	140,00 A4
M 8 x 90	S	50	200,00 A4
M 8 x 100	S	50	227,00 A4
M 8 x 110	S	1	300,00 A4
M 8 x 120	S	1	345,00 A4
M 8 x 130	S	1	445,00 A4
M 8 x 140	S	1	540,00 A4
M 8 x 150	S	1	640,00 A4
M 8 x 160	S	1	730,00 A4
M 8 x 170	S	1	920,00 A4
M 8 x 180	S	1	920,00 A4
M 8 x 200	S	1	1380,00 A4
M 10 x 10*	S	100	244,00 A4
M 10 x 12	S	100	141,00 A4
M 10 x 14	S	100	139,00 A4
M 10 x 16	S	100	83,00 A4
M 10 x 20	S	100	66,00 A4
M 10 x 22	S	100	79,00 A4
M 10 x 25	S	100	63,00 A4

Abmessungen	VE	Stück	€/100/Obf.	Abmessungen	VE	Stück	€/100/Obf.	Abmessungen	VE	Stück	€/100/Obf.
M 10 x 30	S	100	68,00A4	M 16 x 20	S	50	315,00A4	M 22 x 80	S	10	2290,00A4
M 10 x 35	S	100	71,00A4	M 16 x 25	S	50	290,00A4	M 22 x 90	S	10	2950,00A4
M 10 x 40	S	100	77,00A4	M 16 x 30	S	50	248,00A4	M 22 x 100	S	10	3550,00A4
M 10 x 45	S	100	84,00A4	M 16 x 35	S	50	248,00A4	M 22 x 110	S	10	3950,00A4
M 10 x 50	S	100	92,00A4	M 16 x 40	S	50	248,00A4	M 22 x 120	S	10	4350,00A4
M 10 x 55	S	100	118,00A4	M 16 x 45	S	50	255,00A4	M 22 x 130	S	10	4700,00A4
M 10 x 60	S	100	124,00A4	M 16 x 50	S	50	270,00A4	M 22 x 140	S	10	5100,00A4
M 10 x 65	S	100	149,00A4	M 16 x 55	S	25	300,00A4	M 22 x 150	S	10	5600,00A4
M 10 x 70	S	100	158,00A4	M 16 x 60	S	25	305,00A4	M 24 x 30	S	1	2020,00A4
M 10 x 75	S	100	246,00A4	M 16 x 65	S	25	355,00A4	M 24 x 35	S	1	2020,00A4
M 10 x 80	S	50	193,00A4	M 16 x 70	S	25	365,00A4	M 24 x 40	S	1	1690,00A4
M 10 x 85	S	50	305,00A4	M 16 x 75	S	25	410,00A4	M 24 x 45	S	1	1690,00A4
M 10 x 90	S	50	250,00A4	M 16 x 80	S	25	410,00A4	M 24 x 50	S	1	1150,00A4
M 10 x 95	S	50	470,00A4	M 16 x 90	S	25	590,00A4	M 24 x 55	S	1	1170,00A4
M 10 x 100	S	50	400,00A4	M 16 x 100	S	25	690,00A4	M 24 x 60	S	1	1200,00A4
M 10 x 110	S	50	460,00A4	M 16 x 110	S	1	890,00A4	M 24 x 65	S	1	1250,00A4
M 10 x 120	S	50	570,00A4	M 16 x 120	S	1	1010,00A4	M 24 x 70	S	1	1310,00A4
M 10 x 130	S	1	740,00A4	M 16 x 130	S	1	1150,00A4	M 24 x 75	S	1	1430,00A4
M 10 x 140	S	1	870,00A4	M 16 x 140	S	1	1270,00A4	M 24 x 80	S	1	1430,00A4
M 10 x 150	S	1	1020,00A4	M 16 x 150	S	1	1410,00A4	M 24 x 90	S	1	1950,00A4
M 10 x 160	S	1	1150,00A4	M 16 x 160	S	1	2600,00A4	M 24 x 100	S	1	2120,00A4
M 10 x 170	S	1	1320,00A4	M 16 x 170	S	1	2700,00A4	M 24 x 110	S	1	2450,00A4
M 10 x 180	S	1	1420,00A4	M 16 x 180	S	1	2700,00A4	M 24 x 120	S	1	2700,00A4
M 10 x 200	S	1	1830,00A4	M 16 x 190	S	1	2850,00A4	M 24 x 130	S	1	2950,00A4
M 12 x 16	S	100	156,00A4	M 16 x 200	S	1	2850,00A4	M 24 x 140	S	1	3150,00A4
M 12 x 18	S	100	145,00A4	M 18 x 30	S	1	790,00A4	M 24 x 150	S	1	3450,00A4
M 12 x 20	S	100	118,00A4	M 18 x 35	S	1	710,00A4	M 24 x 160	S	1	5200,00A4
M 12 x 22	S	100	138,00A4	M 18 x 40	S	1	710,00A4	M 24 x 170	S	1	5300,00A4
M 12 x 25	S	100	99,00A4	M 18 x 45	S	1	710,00A4	M 24 x 180	S	1	5300,00A4
M 12 x 30	S	100	99,00A4	M 18 x 50	S	1	740,00A4	M 24 x 190	S	1	5400,00A4
M 12 x 35	S	100	107,00A4	M 18 x 55	S	1	790,00A4	M 24 x 200	S	1	5400,00A4
M 12 x 40	S	100	110,00A4	M 18 x 60	S	1	800,00A4	M 27 x 50	S	1	2100,00A4
M 12 x 45	S	100	118,00A4	M 18 x 65	S	1	890,00A4	M 27 x 55	S	1	2220,00A4
M 12 x 50	S	50	126,00A4	M 18 x 70	S	1	920,00A4	M 27 x 60	S	1	2320,00A4
M 12 x 55	S	50	154,00A4	M 18 x 75	S	1	1020,00A4	M 27 x 65	S	1	2420,00A4
M 12 x 60	S	50	156,00A4	M 18 x 80	S	1	1020,00A4	M 27 x 70	S	1	2550,00A4
M 12 x 65	S	50	198,00A4	M 18 x 90	S	1	1470,00A4	M 27 x 80	S	1	2750,00A4
M 12 x 70	S	50	206,00A4	M 18 x 100	S	1	1730,00A4	M 27 x 90	S	1	3000,00A4
M 12 x 75	S	50	295,00A4	M 18 x 110	S	1	2100,00A4	M 27 x 100	S	1	3200,00A4
M 12 x 80	S	50	238,00A4	M 18 x 120	S	1	2290,00A4	M 27 x 110	S	1	3600,00A4
M 12 x 85	S	50	380,00A4	M 18 x 130	S	1	2700,00A4	M 27 x 120	S	1	3800,00A4
M 12 x 90	S	50	325,00A4	M 18 x 150	S	1	3200,00A4	M 27 x 130	S	1	3950,00A4
M 12 x 95	S	1	630,00A4	M 20 x 20*	S	25	710,00A4	M 27 x 140	S	1	4150,00A4
M 12 x 100	S	50	345,00A4	M 20 x 30	S	25	530,00A4	M 27 x 150	S	1	4300,00A4
M 12 x 110	S	1	600,00A4	M 20 x 35	S	25	470,00A4	M 30 x 40*	S	1	5100,00A4
M 12 x 120	S	50	620,00A4	M 20 x 40	S	25	470,00A4	M 30 x 50*	S	1	3700,00A4
M 12 x 130	S	1	600,00A4	M 20 x 45	S	25	470,00A4	M 30 x 60*	S	1	2900,00A4
M 12 x 140	S	1	980,00A4	M 20 x 50	S	25	490,00A4	M 30 x 65*	S	1	3000,00A4
M 12 x 150	S	1	1140,00A4	M 20 x 55	S	25	530,00A4	M 30 x 70*	S	1	3100,00A4
M 12 x 160	S	1	1300,00A4	M 20 x 60	S	25	540,00A4	M 30 x 80*	S	1	3350,00A4
M 12 x 170	S	1	1570,00A4	M 20 x 65	S	25	600,00A4	M 30 x 90*	S	1	3600,00A4
M 12 x 180	S	1	1620,00A4	M 20 x 70	S	25	610,00A4	M 30 x 100*	S	1	4000,00A4
M 12 x 190	S	1	2040,00A4	M 20 x 75	S	25	680,00A4	M 30 x 110*	S	1	4550,00A4
M 12 x 200	S	1	2360,00A4	M 20 x 80	S	25	680,00A4	M 30 x 120*	S	1	4850,00A4
M 14 x 20	S	50	315,00A4	M 20 x 90	S	1	980,00A4	M 30 x 130*	S	1	5100,00A4
M 14 x 25	S	50	295,00A4	M 20 x 100	S	1	1150,00A4	M 30 x 140*	S	1	5200,00A4
M 14 x 30	S	50	250,00A4	M 20 x 110	S	1	1400,00A4	M 30 x 150*	S	1	5300,00A4
M 14 x 35	S	50	250,00A4	M 20 x 120	S	1	1530,00A4	M 33 x 70*	S	1	4200,00A4
M 14 x 40	S	50	250,00A4	M 20 x 130	S	1	1790,00A4	M 33 x 80*	S	1	4550,00A4
M 14 x 45	S	50	255,00A4	M 20 x 140	S	1	1920,00A4	M 33 x 90*	S	1	4850,00A4
M 14 x 50	S	50	270,00A4	M 20 x 150	S	1	2120,00A4	M 33 x 120*	S	1	6100,00A4
M 14 x 55	S	50	300,00A4	M 20 x 160	S	1	3850,00A4	M 33 x 130*	S	1	6300,00A4
M 14 x 60	S	50	305,00A4	M 20 x 170	S	1	3900,00A4	M 33 x 140*	S	1	6400,00A4
M 14 x 65	S	50	355,00A4	M 20 x 180	S	1	3900,00A4	M 33 x 150*	S	1	6500,00A4
M 14 x 70	S	50	365,00A4	M 20 x 190	S	1	4150,00A4	M 36 x 80*	S	1	5600,00A4
M 14 x 75	S	50	500,00A4	M 20 x 200	S	1	4150,00A4	M 36 x 90*	S	1	6000,00A4
M 14 x 80	S	50	415,00A4	M 22 x 30*	S	1	2260,00A4	M 36 x 100*	S	1	6800,00A4
M 14 x 90	S	50	600,00A4	M 22 x 40	S	1	2260,00A4	M 36 x 110*	S	1	7100,00A4
M 14 x 100	S	50	700,00A4	M 22 x 45	S	1	2260,00A4	M 36 x 120*	S	1	7400,00A4
M 14 x 110	S	25	900,00A4	M 22 x 50	S	1	1840,00A4	M 36 x 130*	S	1	7600,00A4
M 14 x 120	S	25	1020,00A4	M 22 x 55	S	1	1880,00A4	M 36 x 140*	S	1	7800,00A4
M 14 x 130	S	25	1160,00A4	M 22 x 60	S	10	1930,00A4	M 36 x 150*	S	1	7900,00A4
M 14 x 140	S	25	1280,00A4	M 22 x 65	S	1	1990,00A4				
M 14 x 150	S	1	1410,00A4	M 22 x 70	S	10	2100,00A4				
M 14 x 160*	S	1	2650,00A4	M 22 x 75	S	1	2280,00A4				

Abmessungen	VE Stück	€/100/Obf.
ISO 04017.947		
4017	A 4 - 70	AD W2



Sechskantschrauben mit Gewinde bis Kopf

für Druckbehälterbau nach AD-Regelwerk, Fabrikate mit Verzicht eines Abnahmeprüfzeugnis, *M 10/12= RAZ 3223 übrige Ø = RAZ 403

Maße → **TI-15** Anziehmomente → **TI-249**
 Werkstoffeigensch. → **TI-236** Normumstellung → **TI-6**

Stahl → **S. 254**
 Messing → **S. 636**

ISO 4017 → ersetzt DIN 933



M 5	x	10	S	100	14,50 A4-70
M 5	x	12	S	100	13,60 A4-70
M 5	x	16	S	100	12,10 A4-70
M 5	x	20	S	100	13,70 A4-70
M 6	x	8	S	200	24,80 A4-70
M 6	x	10	S	200	21,70 A4-70
M 6	x	12	S	200	20,00 A4-70
M 6	x	16	S	200	15,40 A4-70
M 6	x	20	S	200	16,60 A4-70
M 6	x	25	S	200	18,30 A4-70
M 6	x	30	S	100	20,90 A4-70
M 8	x	12	S	200	45,00 A4-70
M 8	x	16	S	200	35,50 A4-70
M 8	x	20	S	200	35,50 A4-70
M 8	x	25	S	200	36,00 A4-70
M 8	x	30	S	200	38,00 A4-70
M 8	x	35	S	200	42,50 A4-70
M 8	x	40	S	100	44,50 A4-70
M 8	x	45	S	100	55,00 A4-70
M 10	x	16	S	100	86,00 A4-70
M 10	x	20	S	100	65,00 A4-70
M 10	x	25	S	100	63,00 A4-70
M 10	x	30	S	100	67,00 A4-70
M 10	x	35	S	100	70,00 A4-70
M 10	x	40	S	100	77,00 A4-70
M 10	x	45	S	100	86,00 A4-70
M 10	x	50	S	100	93,00 A4-70
M 10	x	55	S	50	120,00 A4-70
M 10	x	60	S	100	123,00 A4-70
M 10	x	70	S	50	158,00 A4-70
M 10	x	80	S	50	196,00 A4-70
M 12	x	16	S	50	152,00 A4-70
M 12	x	20	S	50	116,00 A4-70
M 12	x	25	S	50	98,00 A4-70
M 12	x	30	S	50	98,00 A4-70
M 12	x	35	S	50	106,00 A4-70
M 12	x	40	S	50	109,00 A4-70
M 12	x	45	S	50	117,00 A4-70
M 12	x	50	S	50	126,00 A4-70
M 12	x	55	S	50	152,00 A4-70
M 12	x	60	S	50	154,00 A4-70
M 12	x	65	S	50	197,00 A4-70
M 12	x	70	S	50	204,00 A4-70
M 12	x	75	S	50	300,00 A4-70
M 12	x	80	S	25	238,00 A4-70
M 12	x	90	S	50	300,00 A4-70
M 16	x	20	S	50	320,00 A4-70
M 16	x	25	S	25	295,00 A4-70
M 16	x	30	S	25	250,00 A4-70

Abmessungen	VE Stück	€/100/Obf.
M 16 x 35	S 25	250,00 A4-70
M 16 x 40	S 25	250,00 A4-70
M 16 x 45	S 25	255,00 A4-70
M 16 x 50	S 25	270,00 A4-70
M 16 x 55	S 25	305,00 A4-70
M 16 x 60	S 25	310,00 A4-70
M 16 x 65	S 25	355,00 A4-70
M 16 x 70	S 25	365,00 A4-70
M 16 x 75	S 25	475,00 A4-70
M 16 x 80	S 25	415,00 A4-70
M 16 x 90	S 50	600,00 A4-70
M 16 x 100	S 25	710,00 A4-70
M 20 x 30	S 25	530,00 A4-70
M 20 x 35	S 25	475,00 A4-70
M 20 x 40	S 25	475,00 A4-70
M 20 x 45	S 25	475,00 A4-70
M 20 x 50	S 25	500,00 A4-70
M 20 x 55	S 25	540,00 A4-70
M 20 x 60	S 25	540,00 A4-70
M 20 x 65	S 25	610,00 A4-70
M 20 x 70	S 25	620,00 A4-70
M 20 x 75	S 25	660,00 A4-70
M 20 x 80	S 25	680,00 A4-70
M 20 x 90	S 10	990,00 A4-70
M 20 x 100	S 10	1190,00 A4-70
M 20 x 120	S 1	1530,00 A4-70
M 20 x 160	S 1	3900,00 A4-70
M 24 x 110	S 1	2460,00 A4-70
M 24 x 130	S 1	2950,00 A4-70

Abmessungen	VE Stück	€/100/Obf.
ISO 04017.948		
4017	A 4 - 80	

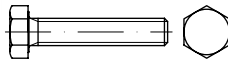

Sechskantschrauben mit Gewinde bis Kopf

hochfest (stark kalt verfestigt)

Maße → **TI-15** Anziehmomente → **TI-249**
 Werkstoffeigensch. → **TI-236** Normumstellung → **TI-6**

Stahl → **S. 254**
 Messing → **S. 636**

ISO 4017 → ersetzt DIN 933



M 5	x	10	S	500	36,50 A4-80
M 5	x	16	S	500	30,50 A4-80
M 5	x	20	S	500	40,50 A4-80
M 5	x	25	S	200	33,50 A4-80
M 5	x	30	S	200	38,50 A4-80
M 5	x	35	S	200	45,00 A4-80
M 5	x	40	S	200	66,00 A4-80
M 5	x	50	S	200	81,00 A4-80
M 5	x	60	S	200	116,00 A4-80
M 5	x	70	S	100	168,00 A4-80
M 6	x	10	S	100	54,00 A4-80
M 6	x	12	S	100	49,00 A4-80
M 6	x	16	S	100	38,50 A4-80
M 6	x	20	S	100	42,00 A4-80
M 6	x	25	S	100	46,00 A4-80
M 6	x	30	S	100	53,00 A4-80
M 6	x	35	S	100	62,00 A4-80
M 6	x	40	S	100	71,00 A4-80
M 6	x	45	S	100	95,00 A4-80
M 6	x	50	S	100	110,00 A4-80

Abmessungen	VE Stück	€/100/Obf.
M 6 x 55	S 100	143,00 A4-80
M 6 x 60	S 100	154,00 A4-80
M 6 x 70	S 50	248,00 A4-80
M 6 x 80	S 50	305,00 A4-80
M 6 x 90	S 50	420,00 A4-80
M 6 x 100	S 50	485,00 A4-80
M 6 x 110	S 50	560,00 A4-80
M 6 x 120	S 50	630,00 A4-80
M 8 x 10	S 100	116,00 A4-80
M 8 x 12	S 100	114,00 A4-80
M 8 x 16	S 100	91,00 A4-80
M 8 x 20	S 100	91,00 A4-80
M 8 x 25	S 100	91,00 A4-80
M 8 x 30	S 100	96,00 A4-80
M 8 x 35	S 100	107,00 A4-80
M 8 x 40	S 100	114,00 A4-80
M 8 x 45	S 100	133,00 A4-80
M 8 x 50	S 100	143,00 A4-80
M 8 x 55	S 100	187,00 A4-80
M 8 x 60	S 100	198,00 A4-80
M 8 x 65	S 100	242,00 A4-80
M 8 x 70	S 100	265,00 A4-80
M 8 x 80	S 100	310,00 A4-80
M 8 x 90	S 50	320,00 A4-80
M 8 x 100	S 50	385,00 A4-80
M 8 x 110	S 1	460,00 A4-80
M 8 x 120	S 1	560,00 A4-80
M 8 x 130	S 1	670,00 A4-80
M 8 x 140	S 1	800,00 A4-80
M 8 x 150	S 1	960,00 A4-80
M 8 x 160	S 1	1160,00 A4-80
M 10 x 16	S 100	208,00 A4-80
M 10 x 20	S 100	162,00 A4-80
M 10 x 25	S 100	158,00 A4-80
M 10 x 30	S 100	168,00 A4-80
M 10 x 35	S 100	177,00 A4-80
M 10 x 40	S 100	191,00 A4-80
M 10 x 45	S 100	210,00 A4-80
M 10 x 50	S 100	229,00 A4-80
M 10 x 55	S 100	295,00 A4-80
M 10 x 60	S 100	310,00 A4-80
M 10 x 65	S 100	375,00 A4-80
M 10 x 70	S 100	395,00 A4-80
M 10 x 75	S 50	620,00 A4-80
M 10 x 80	S 50	485,00 A4-80
M 10 x 90	S 50	630,00 A4-80
M 10 x 100	S 50	1000,00 A4-80
M 10 x 110	S 50	1160,00 A4-80
M 10 x 120	S 50	1430,00 A4-80
M 10 x 130	S 1	1850,00 A4-80
M 10 x 140	S 1	2190,00 A4-80
M 10 x 150	S 1	2550,00 A4-80
M 10 x 160	S 1	2900,00 A4-80
M 10 x 170	S 1	3350,00 A4-80
M 10 x 180	S 1	3550,00 A4-80
M 10 x 190	S 1	4100,00 A4-80
M 10 x 200	S 1	4600,00 A4-80
M 12 x 20	S 100	295,00 A4-80
M 12 x 25	S 100	246,00 A4-80
M 12 x 30	S 100	246,00 A4-80
M 12 x 35	S 100	265,00 A4-80
M 12 x 40	S 100	275,00 A4-80
M 12 x 45	S 50	295,00 A4-80
M 12 x 50	S 50	315,00 A4-80
M 12 x 55	S 50	380,00 A4-80
M 12 x 60	S 50	385,00 A4-80
M 12 x 65	S 50	495,00 A4-80
M 12 x 70	S 50	510,00 A4-80
M 12 x 75	S 50	750,00 A4-80
M 12 x 80	S 50	600,00 A4-80
M 12 x 90	S 50	810,00 A4-80
M 12 x 100	S 1	870,00 A4-80
M 12 x 110	S 1	1520,00 A4-80
M 12 x 120	S 1	1560,00 A4-80
M 12 x 130	S 1	1520,00 A4-80

Abmessungen	VE	Stück	€/100/Obf.
M 12 x 140	S	1	2440,00 A4-80
M 12 x 150	S	1	2850,00 A4-80
M 12 x 160	S	1	3300,00 A4-80
M 12 x 170	S	1	3950,00 A4-80
M 12 x 180	S	1	4100,00 A4-80
M 12 x 190	S	1	5100,00 A4-80
M 12 x 200	S	1	6000,00 A4-80
M 14 x 25	S	50	740,00 A4-80
M 14 x 30	S	50	630,00 A4-80
M 14 x 35	S	50	630,00 A4-80
M 14 x 40	S	50	630,00 A4-80
M 14 x 45	S	50	640,00 A4-80
M 14 x 50	S	50	680,00 A4-80
M 14 x 55	S	50	760,00 A4-80
M 14 x 60	S	50	770,00 A4-80
M 14 x 65	S	50	900,00 A4-80
M 14 x 70	S	1	920,00 A4-80
M 14 x 80	S	1	1040,00 A4-80
M 14 x 90	S	1	1520,00 A4-80
M 16 x 25	S	50	740,00 A4-80
M 16 x 30	S	50	630,00 A4-80
M 16 x 35	S	50	630,00 A4-80
M 16 x 40	S	50	630,00 A4-80
M 16 x 45	S	50	640,00 A4-80
M 16 x 50	S	25	680,00 A4-80
M 16 x 55	S	25	760,00 A4-80
M 16 x 60	S	25	770,00 A4-80
M 16 x 65	S	25	900,00 A4-80
M 16 x 70	S	25	920,00 A4-80
M 16 x 75	S	25	1200,00 A4-80
M 16 x 80	S	25	1040,00 A4-80
M 16 x 90	S	25	1490,00 A4-80
M 16 x 100	S	25	1730,00 A4-80
M 16 x 110	S	25	1970,00 A4-80
M 16 x 120	S	1	2550,00 A4-80
M 16 x 130	S	1	2900,00 A4-80
M 16 x 140	S	1	3200,00 A4-80
M 16 x 150	S	1	3550,00 A4-80
M 16 x 160	S	1	4350,00 A4-80
M 16 x 170	S	1	4750,00 A4-80
M 16 x 180	S	1	5200,00 A4-80
M 16 x 190	S	1	6300,00 A4-80
M 16 x 200	S	1	7100,00 A4-80
M 20 x 30	S	25	1330,00 A4-80
M 20 x 35	S	25	1430,00 A4-80
M 20 x 40	S	25	1200,00 A4-80
M 20 x 45	S	25	1200,00 A4-80
M 20 x 50	S	25	1240,00 A4-80
M 20 x 55	S	25	1350,00 A4-80
M 20 x 60	S	25	1350,00 A4-80
M 20 x 65	S	25	1520,00 A4-80
M 20 x 70	S	25	1540,00 A4-80
M 20 x 75	S	25	1640,00 A4-80
M 20 x 80	S	25	1700,00 A4-80
M 20 x 90	S	1	2460,00 A4-80
M 20 x 100	S	1	2900,00 A4-80
M 20 x 110	S	1	3550,00 A4-80
M 20 x 120	S	1	3850,00 A4-80
M 20 x 130	S	1	4500,00 A4-80
M 20 x 140	S	1	4850,00 A4-80
M 20 x 150	S	1	5400,00 A4-80
M 20 x 160	S	1	6000,00 A4-80
M 20 x 170	S	1	6800,00 A4-80
M 20 x 180	S	1	7500,00 A4-80
M 20 x 190	S	1	8300,00 A4-80
M 20 x 200	S	1	9400,00 A4-80
M 24 x 50	S	10	2900,00 A4-80
M 24 x 55	S	10	2180,00 A4-80
M 24 x 60	S	10	3050,00 A4-80
M 24 x 70	S	10	3300,00 A4-80
M 24 x 80	S	10	2750,00 A4-80
M 24 x 90	S	10	2950,00 A4-80
M 24 x 100	S	10	3200,00 A4-80
M 24 x 110	S	10	3400,00 A4-80
M 24 x 120	S	10	3650,00 A4-80

Abmessungen	VE	Stück	€/100/Obf.
M 24 x 130	S	1	7400,00 A4-80
M 24 x 140	S	1	8000,00 A4-80
M 24 x 150	S	1	8700,00 A4-80
M 24 x 160	S	1	13100,00 A4-80
M 24 x 170	S	1	13300,00 A4-80
M 24 x 180	S	1	13900,00 A4-80
M 24 x 190	S	1	14500,00 A4-80
M 24 x 200	S	1	15600,00 A4-80

ISO 04017.941
4017 A 4 BUMAX88*

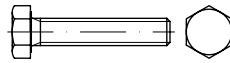

Sechskantschrauben mit Gewinde bis Kopf

Abmessungen ab M 6 und Länge > 3 x d für den Einsatz nach Druckgeräterichtlinie geeignet → APZ 3.1 auf Anfrage

Maße → **TI-15** Anziehmomente → **TI-250**
 Werkstoffeigensch. → **TI-237** Normumstellung → **TI-6**

Stahl → **S. 254**
 Messing → **S. 636**

*mechanische Eigenschaften ~ Fkl. 8.8

DGRL Pre-Approval
 RoHS ✓
 REACH SVHC free

M 5 x 10	S	100	175,00 A4-88
M 5 x 12	S	100	179,00 A4-88
M 5 x 16	S	100	189,00 A4-88
M 5 x 20	S	100	196,00 A4-88
M 5 x 25	S	100	208,00 A4-88
M 5 x 30	S	100	219,00 A4-88
M 5 x 35	S	100	229,00 A4-88
M 5 x 40	S	100	240,00 A4-88
M 6 x 16	S	100	183,00 A4-88
M 6 x 20	S	100	196,00 A4-88
M 6 x 25	S	100	212,00 A4-88
M 6 x 30	S	100	229,00 A4-88
M 6 x 35	S	100	246,00 A4-88
M 6 x 40	S	100	265,00 A4-88
M 6 x 45	S	100	280,00 A4-88
M 6 x 50	S	100	300,00 A4-88
M 8 x 16	S	50	310,00 A4-88
M 8 x 20	S	50	330,00 A4-88
M 8 x 25	S	50	365,00 A4-88
M 8 x 30	S	50	395,00 A4-88
M 8 x 35	S	50	425,00 A4-88
M 8 x 40	S	50	455,00 A4-88
M 8 x 45	S	50	485,00 A4-88
M 8 x 50	S	50	520,00 A4-88
M 8 x 60	S	50	580,00 A4-88
M 8 x 70	S	50	1830,00 A4-88
M 10 x 16	S	50	550,00 A4-88
M 10 x 20	S	50	620,00 A4-88
M 10 x 25	S	50	720,00 A4-88
M 10 x 30	S	50	760,00 A4-88
M 10 x 35	S	50	810,00 A4-88
M 10 x 40	S	50	890,00 A4-88
M 10 x 45	S	50	960,00 A4-88
M 12 x 45	S	25	1260,00 A4-88
M 12 x 70	S	25	1600,00 A4-88
M 12 x 80	S	25	1790,00 A4-88
M 12 x 90	S	25	1910,00 A4-88
M 12 x 100	S	25	2310,00 A4-88
M 14 x 30	S	25	2310,00 A4-88

Abmessungen	VE	Stück	€/100/Obf.
M 14 x 40	S	25	2480,00 A4-88
M 14 x 50	S	25	2650,00 A4-88
M 14 x 60	S	25	2850,00 A4-88
M 14 x 70	S	25	2850,00 A4-88
M 16 x 40	S	25	2270,00 A4-88
M 16 x 45	S	25	2400,00 A4-88
M 16 x 50	S	25	2550,00 A4-88
M 16 x 60	S	25	2800,00 A4-88
M 16 x 70	S	25	3100,00 A4-88
M 16 x 80	S	25	3400,00 A4-88
M 20 x 45	S	10	5100,00 A4-88
M 20 x 50	S	10	5300,00 A4-88
M 20 x 55	S	10	5400,00 A4-88
M 20 x 60	S	10	5600,00 A4-88
M 20 x 65	S	10	5900,00 A4-88
M 20 x 70	S	10	6100,00 A4-88
M 20 x 75	S	10	6300,00 A4-88
M 20 x 80	S	10	6600,00 A4-88
M 20 x 100	S	10	7400,00 A4-88
M 24 x 50	S	10	7600,00 A4-88
M 24 x 65	S	10	8500,00 A4-88
M 24 x 70	S	10	8900,00 A4-88
M 24 x 80	S	10	9500,00 A4-88
M 24 x 90	S	10	10700,00 A4-88
M 30 x 60	S	10	35300,00 A4-88
M 30 x 70	S	10	36300,00 A4-88
M 30 x 80	S	10	37200,00 A4-88
M 30 x 90	S	10	38200,00 A4-88
M 30 x 100	S	10	39300,00 A4-88

ISO 04017.942
4017 A 4 BUMAX109*

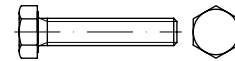

Sechskantschrauben mit Gewinde bis Kopf

Maße → **TI-15** Anziehmomente → **TI-250**
 Werkstoffeigensch. → **TI-237** Normumstellung → **TI-6**

Stahl → **S. 254**
 Messing → **S. 636**

*mechanische Eigenschaften ~ Fkl. 10.9

RoHS ✓
 REACH SVHC free

M 6 x 16	S	100	250,00 A4-109
M 6 x 20	S	100	265,00 A4-109
M 6 x 25	S	100	305,00 A4-109
M 6 x 30	S	100	305,00 A4-109
M 8 x 20	S	50	380,00 A4-109
M 8 x 25	S	50	400,00 A4-109
M 8 x 30	S	50	445,00 A4-109
M 8 x 35	S	50	480,00 A4-109
M 8 x 40	S	50	670,00 A4-109
M 8 x 45	S	50	690,00 A4-109
M 8 x 50	S	50	740,00 A4-109
M 8 x 55	S	50	850,00 A4-109
M 8 x 60	S	50	930,00 A4-109
M 10 x 30	S	50	950,00 A4-109
M 10 x 40	S	50	1040,00 A4-109
M 12 x 30	S	25	1220,00 A4-109
M 12 x 40	S	25	1390,00 A4-109
M 16 x 40	S	25	2550,00 A4-109
M 16 x 50	S	25	2850,00 A4-109
M 16 x 60	S	25	3150,00 A4-109
M 20 x 40	S	10	4700,00 A4-109
M 20 x 50	S	10	6200,00 A4-109

Abmessungen	VE	Stück	€/100/Obf.
M 20 x 60	S	10	6800,00 A4-109
M 20 x 70	S	10	7400,00 A4-109
M 20 x 80	S	10	8400,00 A4-109

ISO	04017.912
4017	Mu A 4 SB

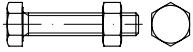

SB-Schrauben-Garnituren EN 15048, Mu = mit Sechskantmutter ISO 4032 SB = nach EN 15048

für nicht planmäßig vorgespannte Verbindungen im Stahlbau mit Abnahmeprüfzeugnis 3.1, Preise gelten zzgl. APZ-Kosten

Maße → TI-15 Anziehmomente → TI-248
Werkstoffeigensch. → TI-236 Normumstellung → TI-6



M 12 x 30	S	50	310,00 A4
M 12 x 35	S	50	320,00 A4
M 12 x 40	S	50	335,00 A4
M 12 x 45	S	50	355,00 A4
M 12 x 50	S	50	375,00 A4
M 16 x 35	S	50	690,00 A4
M 16 x 40	S	50	710,00 A4
M 16 x 45	S	50	740,00 A4
M 16 x 50	S	50	850,00 A4
M 20 x 40	S	25	1290,00 A4
M 20 x 45	S	25	1350,00 A4
M 20 x 50	S	25	1390,00 A4
M 20 x 55	S	25	1440,00 A4
M 20 x 60	S	25	1490,00 A4
M 20 x 65	S	25	1560,00 A4
M 24 x 50	S	10	2340,00 A4
M 24 x 55	S	10	2410,00 A4
M 24 x 60	S	10	2550,00 A4
M 24 x 65	S	10	2650,00 A4
M 24 x 70	S	10	2700,00 A4

ISO	04017.950
4017	1.4571 (A 5)

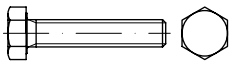

Sechskantschrauben mit Gewinde bis Kopf

*M 10/12 = RAZ 3220 übrige Ø = RAZ 403

Maße → TI-15 Anziehmomente → TI-249
Werkstoffeigensch. → TI-236 Normumstellung → TI-6

Stahl → S. 254
Messing, Kunststoff → S. 636
ISO 4017 → ersetzt DIN 933



Abmessungen	VE	Stück	€/100/Obf.
M 6 x 10	S	100	126,00 A5
M 6 x 20	S	100	133,00 A5
M 6 x 25	S	100	154,00 A5
M 6 x 30	S	100	156,00 A5
M 6 x 40	S	100	164,00 A5
M 6 x 50	S	100	175,00 A5
M 8 x 25	S	100	200,00 A5
M 8 x 30	S	100	223,00 A5
M 8 x 35	S	100	242,00 A5
M 8 x 40	S	100	335,00 A5
M 8 x 50	S	100	370,00 A5
M 8 x 60	S	100	465,00 A5
M 10 x 20	S	1	850,00 A5
M 10 x 25	S	1	870,00 A5
M 10 x 30	S	1	880,00 A5
M 10 x 35	S	1	900,00 A5
M 10 x 40	S	1	920,00 A5
M 10 x 45	S	1	940,00 A5
M 10 x 50	S	1	1120,00 A5
M 12 x 20	S	1	870,00 A5
M 12 x 25	S	1	880,00 A5
M 12 x 30	S	1	900,00 A5
M 12 x 35	S	1	920,00 A5
M 12 x 40	S	1	940,00 A5
M 12 x 45	S	1	960,00 A5
M 12 x 50	S	1	1140,00 A5
M 12 x 60	S	1	1370,00 A5
M 16 x 25	S	1	1240,00 A5
M 16 x 30	S	1	1260,00 A5
M 16 x 35	S	1	1310,00 A5
M 16 x 40	S	1	1350,00 A5
M 16 x 45	S	1	1370,00 A5
M 16 x 50	S	1	1410,00 A5
M 16 x 55	S	1	2000,00 A5
M 16 x 60	S	1	2100,00 A5
M 16 x 65	S	1	2310,00 A5
M 20 x 35	S	1	2480,00 A5
M 20 x 40	S	1	2500,00 A5
M 20 x 45	S	1	2600,00 A5
M 20 x 50	S	1	2650,00 A5
M 20 x 60	S	1	2950,00 A5
M 20 x 70	S	1	3400,00 A5

ISO	04026.910
4026	A 1/A 2

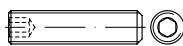

Gewindestifte mit Kegelkuppe, mit Innensechskant

Maße → TI-20 Normumstellung → TI-6
Werkstoffeigensch. → TI-236

Stahl → S. 272
ISO 4026 → ersetzt DIN 913

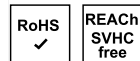

M 2 x 2	S	500	161,00 A1/A 2
M 2 x 3	S	500	112,00 A1/A 2
M 2 x 4	S	500	114,00 A1/A 2
M 2 x 5	S	500	114,00 A1/A 2
M 2 x 6	S	500	114,00 A1/A 2
M 2 x 8	S	500	116,00 A1/A 2
M 2,5 x 3	S	500	88,00 A1/A 2
M 2,5 x 4	S	500	86,00 A1/A 2
M 2,5 x 5	S	500	86,00 A1/A 2

Abmessungen	VE	Stück	€/100/Obf.
M 2,5 x 6	S	500	86,00 A1/A 2
M 3 x 2	S	500	87,00 A1/A 2
M 3 x 3	S	500	43,50 A1/A 2
M 3 x 4	S	500	47,00 A1/A 2
M 3 x 5	S	500	46,50 A1/A 2
M 3 x 6	S	500	51,00 A1/A 2
M 3 x 8	S	500	53,00 A1/A 2
M 3 x 10	S	500	54,00 A1/A 2
M 3 x 12	S	500	60,00 A1/A 2
M 3 x 16	S	500	44,50 A1/A 2
M 3 x 20	S	500	58,00 A1/A 2
M 3 x 25	S	500	99,00 A1/A 2
M 4 x 4	S	500	33,00 A1/A 2
M 4 x 5	S	500	33,00 A1/A 2
M 4 x 6	S	500	33,50 A1/A 2
M 4 x 8	S	500	34,50 A1/A 2
M 4 x 10	S	500	37,00 A1/A 2
M 4 x 12	S	500	39,00 A1/A 2
M 4 x 16	S	500	42,50 A1/A 2
M 4 x 20	S	500	45,50 A1/A 2
M 4 x 25	S	500	78,00 A1/A 2
M 4 x 30	S	200	86,00 A1/A 2
M 5 x 4	S	500	36,00 A1/A 2
M 5 x 5	S	500	37,00 A1/A 2
M 5 x 6	S	500	37,50 A1/A 2
M 5 x 8	S	500	38,50 A1/A 2
M 5 x 10	S	500	39,50 A1/A 2
M 5 x 12	S	500	41,50 A1/A 2
M 5 x 16	S	500	45,50 A1/A 2
M 5 x 20	S	500	54,00 A1/A 2
M 5 x 25	S	200	60,00 A1/A 2
M 5 x 30	S	200	105,00 A1/A 2
M 5 x 35	S	200	149,00 A1/A 2
M 5 x 40	S	200	152,00 A1/A 2
M 5 x 45	S	200	161,00 A1/A 2
M 6 x 5	S	500	42,50 A1/A 2
M 6 x 6	S	500	42,50 A1/A 2
M 6 x 8	S	500	44,50 A1/A 2
M 6 x 10	S	500	45,50 A1/A 2
M 6 x 12	S	500	47,50 A1/A 2
M 6 x 16	S	500	54,00 A1/A 2
M 6 x 20	S	500	62,00 A1/A 2
M 6 x 25	S	200	71,00 A1/A 2
M 6 x 30	S	200	82,00 A1/A 2
M 6 x 35	S	200	101,00 A1/A 2
M 6 x 40	S	200	110,00 A1/A 2
M 6 x 45	S	100	255,00 A1/A 2
M 6 x 50	S	100	300,00 A1/A 2
M 6 x 60	S	100	340,00 A1/A 2
M 8 x 6	S	500	91,00 A1/A 2
M 8 x 8	S	500	62,00 A1/A 2
M 8 x 10	S	500	62,00 A1/A 2
M 8 x 12	S	200	68,00 A1/A 2
M 8 x 16	S	200	74,00 A1/A 2
M 8 x 20	S	200	88,00 A1/A 2
M 8 x 25	S	200	101,00 A1/A 2
M 8 x 30	S	100	116,00 A1/A 2
M 8 x 35	S	100	141,00 A1/A 2
M 8 x 40	S	100	163,00 A1/A 2
M 8 x 45	S	100	178,00 A1/A 2
M 8 x 50	S	50	224,00 A1/A 2
M 8 x 60	S	50	405,00 A1/A 2
M 8 x 70	S	50	520,00 A1/A 2
M 8 x 80	S	50	630,00 A1/A 2
M 8 x 100	S	50	740,00 A1/A 2
M 10 x 10	S	200	91,00 A1/A 2
M 10 x 12	S	100	93,00 A1/A 2
M 10 x 16	S	100	99,00 A1/A 2
M 10 x 18	S	100	114,00 A1/A 2
M 10 x 20	S	100	120,00 A1/A 2
M 10 x 25	S	100	142,00 A1/A 2
M 10 x 30	S	100	165,00 A1/A 2
M 10 x 35	S	50	201,00 A1/A 2
M 10 x 40	S	50	212,00 A1/A 2
M 10 x 45	S	50	226,00 A1/A 2

Abmessungen	VE	Stück	€/100/Obf.
M 10 x 50	S	50	247,00 A 1/A 2
M 10 x 60	S	50	345,00 A 1/A 2
M 10 x 70	S	50	440,00 A 1/A 2
M 10 x 80	S	50	540,00 A 1/A 2
M 10 x 100	S	50	660,00 A 1/A 2
M 12 x 10	S	50	190,00 A 1/A 2
M 12 x 12	S	50	192,00 A 1/A 2
M 12 x 16	S	50	192,00 A 1/A 2
M 12 x 20	S	50	218,00 A 1/A 2
M 12 x 25	S	50	239,00 A 1/A 2
M 12 x 30	S	50	260,00 A 1/A 2
M 12 x 35	S	25	285,00 A 1/A 2
M 12 x 40	S	25	315,00 A 1/A 2
M 12 x 45	S	25	355,00 A 1/A 2
M 12 x 50	S	25	385,00 A 1/A 2
M 12 x 60	S	25	560,00 A 1/A 2
M 12 x 70	S	25	1040,00 A 1/A 2
M 12 x 80	S	25	1080,00 A 1/A 2
M 12 x 90	S	10	1210,00 A 1/A 2
M 16 x 16	S	10	420,00 A 1/A 2
M 16 x 20	S	10	610,00 A 1/A 2
M 16 x 25	S	10	1130,00 A 1/A 2
M 16 x 30	S	10	660,00 A 1/A 2
M 16 x 40	S	10	1070,00 A 1/A 2
M 16 x 50	S	10	1830,00 A 1/A 2
M 16 x 60	S	10	1940,00 A 1/A 2
M 16 x 70	S	10	2280,00 A 1/A 2
M 16 x 80	S	10	2750,00 A 1/A 2
M 16 x 90	S	10	2950,00 A 1/A 2
M 16 x 100	S	10	3300,00 A 1/A 2
M 20 x 20	S	10	1860,00 A 1/A 2
M 20 x 25	S	10	1940,00 A 1/A 2
M 20 x 30	S	10	2280,00 A 1/A 2
M 20 x 35	S	10	2900,00 A 1/A 2
M 20 x 40	S	10	3000,00 A 1/A 2
M 20 x 50	S	10	3150,00 A 1/A 2
M 20 x 60	S	10	3900,00 A 1/A 2
M 20 x 70	S	10	4100,00 A 1/A 2
M 20 x 80	S	10	4500,00 A 1/A 2
M 20 x 90	S	10	4950,00 A 1/A 2
M 20 x 100	S	10	5400,00 A 1/A 2

ISO	04026.940
4026	A 4

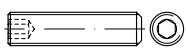

Gewindestifte mit Kegelhülse, mit Innensechskant

Maße → TI-20 Normumstellung → TI-6
 Werkstoffeigensch. → TI-236

Stahl → S. 272

ISO 4026 → ersetzt DIN 913

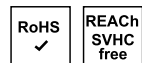

M 3 x 4	S	500	84,00 A 4
M 3 x 5	S	500	89,00 A 4
M 3 x 6	S	500	98,00 A 4
M 3 x 8	S	500	112,00 A 4
M 4 x 5	S	500	110,00 A 4
M 4 x 6	S	500	114,00 A 4
M 4 x 8	S	500	120,00 A 4
M 4 x 10	S	500	126,00 A 4
M 4 x 12	S	500	135,00 A 4
M 4 x 16	S	500	156,00 A 4

Abmessungen	VE	Stück	€/100/Obf.
M 4 x 20	S	500	164,00 A 4
M 5 x 5	S	500	128,00 A 4
M 5 x 6	S	500	128,00 A 4
M 5 x 8	S	500	131,00 A 4
M 5 x 10	S	500	141,00 A 4
M 5 x 12	S	500	154,00 A 4
M 5 x 16	S	500	164,00 A 4
M 5 x 20	S	500	185,00 A 4
M 5 x 25	S	200	193,00 A 4
M 5 x 30	S	200	210,00 A 4
M 6 x 6	S	500	143,00 A 4
M 6 x 8	S	500	145,00 A 4
M 6 x 10	S	500	154,00 A 4
M 6 x 12	S	500	162,00 A 4
M 6 x 16	S	500	185,00 A 4
M 6 x 20	S	500	208,00 A 4
M 6 x 25	S	200	248,00 A 4
M 6 x 30	S	200	275,00 A 4
M 6 x 35	S	200	290,00 A 4
M 6 x 40	S	200	315,00 A 4
M 6 x 45	S	100	340,00 A 4
M 6 x 50	S	100	385,00 A 4
M 8 x 8	S	500	198,00 A 4
M 8 x 10	S	500	198,00 A 4
M 8 x 12	S	200	221,00 A 4
M 8 x 16	S	200	244,00 A 4
M 8 x 20	S	200	295,00 A 4
M 8 x 25	S	200	360,00 A 4
M 8 x 30	S	100	390,00 A 4
M 8 x 35	S	100	435,00 A 4
M 8 x 40	S	100	470,00 A 4
M 8 x 50	S	50	580,00 A 4
M 8 x 60	S	50	680,00 A 4
M 10 x 10	S	200	315,00 A 4
M 10 x 12	S	100	315,00 A 4
M 10 x 16	S	100	340,00 A 4
M 10 x 20	S	100	435,00 A 4
M 10 x 25	S	100	495,00 A 4
M 10 x 30	S	100	465,00 A 4
M 10 x 35	S	50	495,00 A 4
M 10 x 40	S	50	530,00 A 4
M 10 x 45	S	50	570,00 A 4
M 10 x 50	S	50	640,00 A 4
M 10 x 60	S	50	830,00 A 4
M 10 x 70	S	50	1020,00 A 4
M 12 x 12	S	50	360,00 A 4
M 12 x 16	S	50	360,00 A 4
M 12 x 20	S	50	445,00 A 4
M 12 x 25	S	50	495,00 A 4
M 12 x 30	S	50	540,00 A 4
M 12 x 35	S	25	600,00 A 4
M 12 x 40	S	25	640,00 A 4
M 12 x 45	S	25	700,00 A 4
M 12 x 50	S	25	750,00 A 4
M 12 x 55	S	25	890,00 A 4
M 12 x 60	S	25	1000,00 A 4
M 16 x 16	S	10	1490,00 A 4
M 16 x 20	S	10	2420,00 A 4
M 16 x 25	S	10	750,00 A 4
M 16 x 30	S	10	880,00 A 4
M 16 x 35	S	10	970,00 A 4
M 16 x 40	S	10	1010,00 A 4
M 16 x 50	S	10	4050,00 A 4
M 20 x 20	S	10	3900,00 A 4
M 20 x 25	S	10	4200,00 A 4
M 20 x 30	S	10	4550,00 A 4
M 20 x 35	S	10	5100,00 A 4
M 20 x 40	S	10	5800,00 A 4
M 20 x 50	S	10	6900,00 A 4
M 24 x 25	S	10	6500,00 A 4
M 24 x 30	S	10	6900,00 A 4
M 24 x 35	S	10	7600,00 A 4
M 24 x 40	S	10	7900,00 A 4
M 24 x 45	S	10	8200,00 A 4
M 24 x 50	S	10	8800,00 A 4

Abmessungen	VE	Stück	€/100/Obf.
ISO		04027.910	
4027		A 1/A 2	

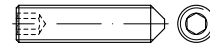

Gewindestifte mit Spitze, mit Innensechskant

Maße → TI-20 Normumstellung → TI-6
 Werkstoffeigensch. → TI-236

Stahl → S. 274

ISO 4027 → ersetzt DIN 914

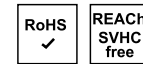

M 2 x 2	S	500	142,00 A 1/A 2
M 2 x 3	S	500	108,00 A 1/A 2
M 2 x 4	S	500	108,00 A 1/A 2
M 2 x 5	S	500	110,00 A 1/A 2
M 2 x 6	S	500	110,00 A 1/A 2
M 2 x 8	S	500	110,00 A 1/A 2
M 2,5 x 4	S	500	83,00 A 1/A 2
M 2,5 x 5	S	500	84,00 A 1/A 2
M 2,5 x 6	S	500	84,00 A 1/A 2
M 3 x 3	S	500	55,00 A 1/A 2
M 3 x 4	S	500	45,50 A 1/A 2
M 3 x 5	S	500	45,00 A 1/A 2
M 3 x 6	S	500	48,50 A 1/A 2
M 3 x 8	S	500	51,00 A 1/A 2
M 3 x 10	S	500	53,00 A 1/A 2
M 3 x 12	S	500	59,00 A 1/A 2
M 3 x 16	S	500	65,00 A 1/A 2
M 4 x 4	S	500	46,00 A 1/A 2
M 4 x 5	S	500	42,50 A 1/A 2
M 4 x 6	S	500	43,50 A 1/A 2
M 4 x 8	S	500	44,00 A 1/A 2
M 4 x 10	S	500	47,00 A 1/A 2
M 4 x 12	S	500	51,00 A 1/A 2
M 4 x 16	S	500	55,00 A 1/A 2
M 4 x 20	S	500	66,00 A 1/A 2
M 4 x 25	S	500	101,00 A 1/A 2
M 4 x 30	S	200	110,00 A 1/A 2
M 5 x 4	S	500	67,00 A 1/A 2
M 5 x 5	S	500	57,00 A 1/A 2
M 5 x 6	S	500	53,00 A 1/A 2
M 5 x 8	S	500	54,00 A 1/A 2
M 5 x 10	S	500	56,00 A 1/A 2
M 5 x 12	S	500	59,00 A 1/A 2
M 5 x 16	S	500	65,00 A 1/A 2
M 5 x 20	S	500	77,00 A 1/A 2
M 5 x 25	S	200	85,00 A 1/A 2
M 5 x 30	S	200	148,00 A 1/A 2
M 6 x 6	S	500	59,00 A 1/A 2
M 6 x 8	S	500	58,00 A 1/A 2
M 6 x 10	S	500	59,00 A 1/A 2
M 6 x 12	S	500	62,00 A 1/A 2
M 6 x 16	S	500	71,00 A 1/A 2
M 6 x 20	S	500	80,00 A 1/A 2
M 6 x 25	S	200	89,00 A 1/A 2
M 6 x 30	S	200	105,00 A 1/A 2
M 6 x 35	S	200	127,00 A 1/A 2
M 6 x 40	S	200	142,00 A 1/A 2
M 6 x 45	S	100	330,00 A 1/A 2
M 6 x 50	S	100	385,00 A 1/A 2
M 8 x 8	S	500	86,00 A 1/A 2
M 8 x 10	S	500	79,00 A 1/A 2
M 8 x 12	S	200	87,00 A 1/A 2

Abmessungen	VE	Stück	€/100/Obf.
M 8 x 16	S	200	95,00 A 1/A 2
M 8 x 20	S	200	112,00 A 1/A 2
M 8 x 25	S	200	129,00 A 1/A 2
M 8 x 30	S	100	148,00 A 1/A 2
M 8 x 35	S	100	180,00 A 1/A 2
M 8 x 40	S	100	209,00 A 1/A 2
M 8 x 45	S	100	228,00 A 1/A 2
M 8 x 50	S	50	290,00 A 1/A 2
M 8 x 60	S	50	530,00 A 1/A 2
M 10 x 10	S	200	127,00 A 1/A 2
M 10 x 12	S	100	120,00 A 1/A 2
M 10 x 16	S	100	127,00 A 1/A 2
M 10 x 20	S	100	154,00 A 1/A 2
M 10 x 25	S	100	203,00 A 1/A 2
M 10 x 30	S	100	212,00 A 1/A 2
M 10 x 35	S	50	260,00 A 1/A 2
M 10 x 40	S	50	275,00 A 1/A 2
M 10 x 50	S	50	320,00 A 1/A 2
M 10 x 60	S	50	440,00 A 1/A 2
M 12 x 16	S	50	207,00 A 1/A 2
M 12 x 20	S	50	235,00 A 1/A 2
M 12 x 25	S	50	260,00 A 1/A 2
M 12 x 30	S	50	280,00 A 1/A 2
M 12 x 35	S	25	305,00 A 1/A 2
M 12 x 40	S	25	335,00 A 1/A 2
M 12 x 50	S	25	415,00 A 1/A 2
M 12 x 60	S	25	540,00 A 1/A 2

ISO 04027.940

4027 A 4



Gewindestifte mit Spitze, mit Innensechskant

Maße → TI-20 Normumstellung → TI-6
 Werkstoffeigensch. → TI-236
 Stahl → S. 274
 ISO 4027 → ersetzt DIN 914

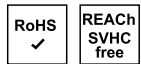

M 2,5 x 8	S	500	240,00 A 4
M 3 x 4	S	500	74,00 A 4
M 3 x 5	S	500	93,00 A 4
M 3 x 6	S	500	93,00 A 4
M 3 x 8	S	500	105,00 A 4
M 3 x 10	S	500	118,00 A 4
M 4 x 4	S	500	104,00 A 4
M 4 x 5	S	500	104,00 A 4
M 4 x 6	S	500	107,00 A 4
M 4 x 8	S	500	114,00 A 4
M 4 x 10	S	500	120,00 A 4
M 4 x 12	S	500	128,00 A 4
M 4 x 16	S	500	147,00 A 4
M 4 x 20	S	500	156,00 A 4
M 5 x 5	S	500	122,00 A 4
M 5 x 6	S	500	122,00 A 4
M 5 x 8	S	500	124,00 A 4
M 5 x 10	S	500	133,00 A 4
M 5 x 12	S	500	145,00 A 4
M 5 x 16	S	500	156,00 A 4
M 5 x 20	S	500	177,00 A 4
M 5 x 25	S	200	183,00 A 4
M 5 x 30	S	200	200,00 A 4
M 6 x 6	S	500	135,00 A 4

Abmessungen	VE	Stück	€/100/Obf.
M 6 x 8	S	500	137,00 A 4
M 6 x 10	S	500	145,00 A 4
M 6 x 12	S	500	154,00 A 4
M 6 x 16	S	500	175,00 A 4
M 6 x 20	S	500	198,00 A 4
M 6 x 25	S	200	235,00 A 4
M 6 x 30	S	200	260,00 A 4
M 6 x 35	S	200	275,00 A 4
M 6 x 45	S	100	320,00 A 4
M 6 x 50	S	100	365,00 A 4
M 8 x 8	S	500	189,00 A 4
M 8 x 10	S	500	189,00 A 4
M 8 x 12	S	200	210,00 A 4
M 8 x 16	S	200	231,00 A 4
M 8 x 20	S	200	280,00 A 4
M 8 x 25	S	200	340,00 A 4
M 8 x 30	S	100	370,00 A 4
M 8 x 35	S	100	415,00 A 4
M 8 x 40	S	100	445,00 A 4
M 8 x 45	S	100	490,00 A 4
M 8 x 50	S	50	560,00 A 4
M 8 x 60	S	50	640,00 A 4
M 10 x 10	S	200	300,00 A 4
M 10 x 12	S	100	300,00 A 4
M 10 x 16	S	100	320,00 A 4
M 10 x 20	S	100	410,00 A 4
M 10 x 25	S	100	470,00 A 4
M 10 x 30	S	100	530,00 A 4
M 10 x 35	S	50	570,00 A 4
M 10 x 40	S	50	600,00 A 4
M 10 x 45	S	50	660,00 A 4
M 10 x 50	S	50	740,00 A 4
M 10 x 60	S	50	950,00 A 4
M 12 x 12	S	50	410,00 A 4
M 12 x 16	S	50	410,00 A 4
M 12 x 20	S	50	510,00 A 4
M 12 x 25	S	50	570,00 A 4
M 12 x 30	S	50	610,00 A 4
M 12 x 35	S	25	690,00 A 4
M 12 x 40	S	25	740,00 A 4
M 12 x 45	S	25	790,00 A 4
M 12 x 50	S	25	850,00 A 4
M 12 x 60	S	25	1140,00 A 4
M 16 x 20	S	10	830,00 A 4
M 16 x 25	S	10	850,00 A 4
M 16 x 30	S	10	1000,00 A 4
M 16 x 40	S	10	1160,00 A 4
M 16 x 50	S	10	1180,00 A 4
M 16 x 60	S	10	1220,00 A 4

ISO 04028.910

4028 A 1/A 2



Gewindestifte mit Zapfen, mit Innensechskant

Maße → TI-20 Normumstellung → TI-6
 Werkstoffeigensch. → TI-236
 Stahl → S. 275
 ISO 4028 → ersetzt DIN 915

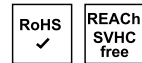

M 2 x 6	S	500	86,00 A 1/A 2
M 2 x 10	S	500	110,00 A 1/A 2

Abmessungen	VE	Stück	€/100/Obf.
M 6 x 16	S	500	74,00 A 1/A 2
M 6 x 20	S	500	85,00 A 1/A 2
M 6 x 25	S	200	95,00 A 1/A 2
M 6 x 30	S	200	112,00 A 1/A 2
M 6 x 35	S	200	137,00 A 1/A 2
M 6 x 40	S	200	152,00 A 1/A 2
M 6 x 50	S	100	405,00 A 1/A 2
M 8 x 8	S	500	90,00 A 1/A 2
M 8 x 10	S	500	85,00 A 1/A 2
M 8 x 12	S	200	92,00 A 1/A 2
M 8 x 16	S	200	101,00 A 1/A 2
M 8 x 20	S	200	120,00 A 1/A 2
M 8 x 25	S	200	137,00 A 1/A 2
M 8 x 30	S	100	158,00 A 1/A 2
M 8 x 35	S	100	192,00 A 1/A 2
M 8 x 40	S	100	222,00 A 1/A 2
M 8 x 45	S	100	243,00 A 1/A 2
M 8 x 60	S	50	550,00 A 1/A 2
M 10 x 10	S	200	137,00 A 1/A 2
M 10 x 12	S	100	127,00 A 1/A 2
M 10 x 16	S	100	135,00 A 1/A 2
M 10 x 20	S	100	163,00 A 1/A 2
M 10 x 25	S	100	195,00 A 1/A 2
M 10 x 30	S	100	226,00 A 1/A 2
M 10 x 35	S	50	275,00 A 1/A 2
M 10 x 40	S	50	290,00 A 1/A 2
M 10 x 45	S	50	310,00 A 1/A 2
M 10 x 50	S	50	340,00 A 1/A 2
M 10 x 60	S	50	470,00 A 1/A 2
M 12 x 16	S	50	218,00 A 1/A 2
M 12 x 20	S	50	250,00 A 1/A 2
M 12 x 25	S	50	275,00 A 1/A 2
M 12 x 30	S	50	300,00 A 1/A 2
M 12 x 40	S	25	360,00 A 1/A 2
M 12 x 50	S	25	440,00 A 1/A 2
M 12 x 60	S	25	580,00 A 1/A 2

ISO 04028.940
4028 A 4

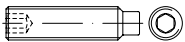

Gewindestifte mit Zapfen, mit Innensechskant

Maße → TI-20 Normumstellung → TI-6
 Werkstoffeigensch. → TI-236
 Stahl → S. 275
 ISO 4028 → ersetzt DIN 915



M 4 x 6	S	500	102,00 A 4
M 4 x 8	S	500	107,00 A 4
M 4 x 10	S	500	116,00 A 4
M 4 x 16	S	500	141,00 A 4
M 4 x 20	S	500	149,00 A 4
M 5 x 6	S	500	116,00 A 4
M 5 x 8	S	500	118,00 A 4
M 5 x 10	S	500	128,00 A 4
M 5 x 12	S	500	139,00 A 4
M 5 x 16	S	500	149,00 A 4
M 5 x 20	S	500	168,00 A 4
M 5 x 25	S	200	177,00 A 4
M 6 x 6	S	500	131,00 A 4
M 6 x 8	S	500	133,00 A 4

Abmessungen	VE	Stück	€/100/Obf.
M 6 x 10	S	500	139,00 A 4
M 6 x 12	S	500	147,00 A 4
M 6 x 16	S	500	168,00 A 4
M 6 x 20	S	500	189,00 A 4
M 6 x 30	S	200	246,00 A 4
M 6 x 35	S	200	265,00 A 4
M 6 x 40	S	200	285,00 A 4
M 6 x 45	S	100	305,00 A 4
M 6 x 50	S	100	350,00 A 4
M 8 x 8	S	500	181,00 A 4
M 8 x 10	S	500	181,00 A 4
M 8 x 12	S	200	200,00 A 4
M 8 x 16	S	200	221,00 A 4
M 8 x 20	S	200	265,00 A 4
M 8 x 25	S	200	325,00 A 4
M 8 x 30	S	100	355,00 A 4
M 8 x 40	S	100	425,00 A 4
M 8 x 50	S	50	530,00 A 4
M 10 x 10	S	200	340,00 A 4
M 10 x 12	S	100	340,00 A 4
M 10 x 16	S	100	305,00 A 4
M 10 x 20	S	100	395,00 A 4
M 10 x 25	S	100	450,00 A 4
M 10 x 30	S	100	510,00 A 4
M 10 x 40	S	50	580,00 A 4
M 12 x 12	S	50	475,00 A 4
M 12 x 16	S	50	390,00 A 4
M 12 x 20	S	50	485,00 A 4
M 12 x 25	S	50	550,00 A 4
M 12 x 30	S	50	590,00 A 4
M 12 x 35	S	25	660,00 A 4
M 12 x 40	S	25	710,00 A 4
M 12 x 50	S	25	820,00 A 4
M 12 x 60	S	25	1260,00 A 4
M 16 x 25	S	10	820,00 A 4
M 16 x 30	S	10	960,00 A 4
M 16 x 35	S	10	1050,00 A 4
M 16 x 40	S	10	1120,00 A 4

ISO 04029.910
4029 A 1/A 2

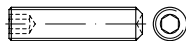

Gewindestifte mit Ringschneide, mit Innensechskant

Maße → TI-21 Normumstellung → TI-6
 Werkstoffeigensch. → TI-236
 Stahl → S. 277
 ISO 4029 → ersetzt DIN 916



M 2 x 2	S	500	141,00 A 1/A 2
M 2 x 3	S	500	114,00 A 1/A 2
M 2 x 4	S	500	116,00 A 1/A 2
M 2 x 5	S	500	116,00 A 1/A 2
M 2 x 6	S	500	116,00 A 1/A 2
M 3 x 4	S	500	48,50 A 1/A 2
M 3 x 5	S	500	47,50 A 1/A 2
M 3 x 6	S	500	52,00 A 1/A 2
M 3 x 8	S	500	53,00 A 1/A 2
M 3 x 10	S	500	55,00 A 1/A 2
M 3 x 12	S	500	61,00 A 1/A 2
M 3 x 16	S	500	120,00 A 1/A 2

Abmessungen	VE	Stück	€/100/Obf.
M 3 x 20	S	500	131,00 A 1/A 2
M 4 x 3	S	500	33,50 A 1/A 2
M 4 x 4	S	500	33,50 A 1/A 2
M 4 x 5	S	500	33,50 A 1/A 2
M 4 x 6	S	500	34,50 A 1/A 2
M 4 x 8	S	500	35,50 A 1/A 2
M 4 x 10	S	500	37,50 A 1/A 2
M 4 x 12	S	500	39,50 A 1/A 2
M 4 x 16	S	500	43,00 A 1/A 2
M 4 x 20	S	500	52,00 A 1/A 2
M 4 x 25	S	500	80,00 A 1/A 2
M 4 x 30	S	200	88,00 A 1/A 2
M 5 x 5	S	500	37,50 A 1/A 2
M 5 x 6	S	500	38,00 A 1/A 2
M 5 x 8	S	500	39,00 A 1/A 2
M 5 x 10	S	500	40,00 A 1/A 2
M 5 x 12	S	500	42,00 A 1/A 2
M 5 x 16	S	500	46,00 A 1/A 2
M 5 x 20	S	500	55,00 A 1/A 2
M 5 x 25	S	200	61,00 A 1/A 2
M 5 x 30	S	200	106,00 A 1/A 2
M 6 x 6	S	500	43,50 A 1/A 2
M 6 x 8	S	500	45,50 A 1/A 2
M 6 x 10	S	500	46,00 A 1/A 2
M 6 x 12	S	500	48,50 A 1/A 2
M 6 x 16	S	500	55,00 A 1/A 2
M 6 x 20	S	500	63,00 A 1/A 2
M 6 x 25	S	200	71,00 A 1/A 2
M 6 x 30	S	200	83,00 A 1/A 2
M 6 x 35	S	200	101,00 A 1/A 2
M 6 x 40	S	200	112,00 A 1/A 2
M 6 x 45	S	100	260,00 A 1/A 2
M 6 x 50	S	100	305,00 A 1/A 2
M 6 x 60	S	100	345,00 A 1/A 2
M 8 x 6	S	500	63,00 A 1/A 2
M 8 x 8	S	500	63,00 A 1/A 2
M 8 x 10	S	500	63,00 A 1/A 2
M 8 x 12	S	200	69,00 A 1/A 2
M 8 x 16	S	200	75,00 A 1/A 2
M 8 x 20	S	200	88,00 A 1/A 2
M 8 x 25	S	200	103,00 A 1/A 2
M 8 x 30	S	100	118,00 A 1/A 2
M 8 x 35	S	100	142,00 A 1/A 2
M 8 x 40	S	100	165,00 A 1/A 2
M 8 x 45	S	100	180,00 A 1/A 2
M 8 x 50	S	50	226,00 A 1/A 2
M 8 x 60	S	50	410,00 A 1/A 2
M 8 x 70	S	50	420,00 A 1/A 2
M 10 x 10	S	200	93,00 A 1/A 2
M 10 x 12	S	100	94,00 A 1/A 2
M 10 x 16	S	100	101,00 A 1/A 2
M 10 x 20	S	100	122,00 A 1/A 2
M 10 x 25	S	100	144,00 A 1/A 2
M 10 x 30	S	100	169,00 A 1/A 2
M 10 x 35	S	50	203,00 A 1/A 2
M 10 x 40	S	50	214,00 A 1/A 2
M 10 x 45	S	50	229,00 A 1/A 2
M 10 x 50	S	50	250,00 A 1/A 2
M 10 x 60	S	50	350,00 A 1/A 2
M 12 x 12	S	50	320,00 A 1/A 2
M 12 x 16	S	50	194,00 A 1/A 2
M 12 x 20	S	50	222,00 A 1/A 2
M 12 x 25	S	50	243,00 A 1/A 2
M 12 x 30	S	50	265,00 A 1/A 2
M 12 x 35	S	25	285,00 A 1/A 2
M 12 x 40	S	25	320,00 A 1/A 2
M 12 x 50	S	25	390,00 A 1/A 2
M 12 x 60	S	25	520,00 A 1/A 2
M 16 x 16	S	10	830,00 A 1/A 2
M 16 x 20	S	10	650,00 A 1/A 2
M 16 x 25	S	10	780,00 A 1/A 2
M 16 x 30	S	10	940,00 A 1/A 2
M 16 x 40	S	10	1200,00 A 1/A 2
M 16 x 50	S	10	1490,00 A 1/A 2

Abmessungen	VE	Stück	€/100/Obf.
M 16 x 60	S	10	1800,00 A 1/A 2
M 20 x 25	S	10	2850,00 A 1/A 2
M 20 x 30	S	10	3050,00 A 1/A 2
M 20 x 35	S	10	3250,00 A 1/A 2
M 20 x 50	S	10	3450,00 A 1/A 2

ISO	04029.940
4029	A 4

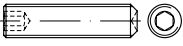

Gewindestifte mit Ringschneide, mit Innensechskant

Maße → **TI-21** Normumstellung → **TI-6**
 Werkstoffeigensch. → **TI-236**
 Stahl → **S. 277**
 ISO 4029 → ersetzt DIN 916



M 2 x 2	S	500	290,00 A 4
M 2 x 4	S	500	310,00 A 4
M 2 x 5	S	500	330,00 A 4
M 2 x 6	S	500	335,00 A 4
M 3 x 5	S	500	124,00 A 4
M 3 x 6	S	500	143,00 A 4
M 3 x 8	S	500	168,00 A 4
M 3 x 10	S	500	202,00 A 4
M 3 x 12	S	500	221,00 A 4
M 3 x 16	S	500	238,00 A 4
M 3 x 20	S	500	270,00 A 4
M 4 x 5	S	500	103,00 A 4
M 4 x 6	S	500	107,00 A 4
M 4 x 8	S	500	112,00 A 4
M 4 x 10	S	500	120,00 A 4
M 4 x 12	S	500	128,00 A 4
M 4 x 16	S	500	145,00 A 4
M 4 x 20	S	500	156,00 A 4
M 5 x 5	S	500	120,00 A 4
M 5 x 6	S	500	120,00 A 4
M 5 x 8	S	500	124,00 A 4
M 5 x 10	S	500	133,00 A 4
M 5 x 12	S	500	145,00 A 4
M 5 x 16	S	500	156,00 A 4
M 5 x 20	S	500	175,00 A 4
M 5 x 25	S	200	183,00 A 4
M 5 x 30	S	200	198,00 A 4
M 6 x 6	S	500	135,00 A 4
M 6 x 8	S	500	137,00 A 4
M 6 x 10	S	500	145,00 A 4
M 6 x 12	S	500	154,00 A 4
M 6 x 16	S	500	175,00 A 4
M 6 x 20	S	500	196,00 A 4
M 6 x 25	S	200	233,00 A 4
M 6 x 30	S	200	260,00 A 4
M 6 x 35	S	200	275,00 A 4
M 6 x 40	S	200	295,00 A 4
M 6 x 50	S	100	360,00 A 4
M 8 x 8	S	500	187,00 A 4
M 8 x 10	S	500	187,00 A 4
M 8 x 12	S	200	208,00 A 4
M 8 x 16	S	200	229,00 A 4
M 8 x 20	S	200	275,00 A 4
M 8 x 25	S	200	340,00 A 4
M 8 x 30	S	100	365,00 A 4
M 8 x 35	S	100	410,00 A 4

Abmessungen	VE	Stück	€/100/Obf.
M 8 x 40	S	100	440,00 A 4
M 8 x 50	S	50	550,00 A 4
M 8 x 60	S	50	640,00 A 4
M 10 x 8	S	200	440,00 A 4
M 10 x 10	S	200	295,00 A 4
M 10 x 12	S	100	295,00 A 4
M 10 x 16	S	100	320,00 A 4
M 10 x 20	S	100	405,00 A 4
M 10 x 25	S	100	465,00 A 4
M 10 x 30	S	100	530,00 A 4
M 10 x 35	S	50	560,00 A 4
M 10 x 40	S	50	600,00 A 4
M 10 x 50	S	50	730,00 A 4
M 10 x 60	S	50	940,00 A 4
M 12 x 12	S	50	350,00 A 4
M 12 x 16	S	50	405,00 A 4
M 12 x 20	S	50	500,00 A 4
M 12 x 25	S	50	560,00 A 4
M 12 x 30	S	50	610,00 A 4
M 12 x 35	S	25	690,00 A 4
M 12 x 40	S	25	730,00 A 4
M 12 x 50	S	25	840,00 A 4
M 12 x 60	S	25	1140,00 A 4
M 16 x 16	S	10	1010,00 A 4
M 16 x 20	S	10	1110,00 A 4
M 16 x 25	S	10	950,00 A 4
M 16 x 30	S	10	990,00 A 4
M 16 x 35	S	10	1100,00 A 4
M 16 x 40	S	10	1140,00 A 4

ISO	04032.910	
4032	A 1	gedreht

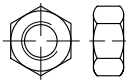

Sechskantmuttern, ISO-Typ 1

Maße → **TI-62** Anziehmomente → **TI-249**
 Werkstoffeigensch. → **TI-236** Normumstellung → **TI-7**
 Stahl → **S. 278**
 Messing, Aluminium, Titan, Kupfer → **S. 637**
 ISO 4032 → ersetzt DIN 934

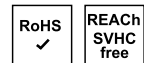

M 1,6	S	500	41,00 A 1
M 2	S	500	29,00 A 1
M 2	K	100	37,50 A 1
M 2,3	S	500	48,00 A 1
M 2,3	K	100	52,00 A 1
M 2,5	S	500	26,50 A 1
M 2,5	K	100	32,00 A 1
M 2,6	S	500	52,00 A 1
M 2,6	K	100	60,00 A 1

Abmessungen	VE	Stück	€/100/Obf.
ISO			04032.920
4032			A 2 (- 70)*

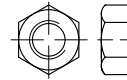

Sechskantmuttern, ISO-Typ 1

**M 5 - M 39 = RAZ 3310 übrige Ø = RAZ 410

Maße → **TI-62** Anziehmomente → **TI-249**
 Werkstoffeigensch. → **TI-236** Normumstellung → **TI-7**

Stahl → **S. 278**
 Messing, Aluminium, Titan, Kupfer → **S. 637**

ISO 4032 → ersetzt DIN 934

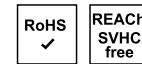

*Fkl. bei diesen Abmessungen je nach Fabrikat abweichend

M 3*	S	1000	10,60 A 2
M 3*	K	100	16,80 A 2
M 3,5*	K	100	45,00 A 2
M 4*	S	1000	12,00 A 2
M 4*	K	100	17,50 A 2
M 5	S	1000	14,00 A 2
M 6	S	1000	21,20 A 2
M 7*	S	100	35,00 A 2
M 8	S	500	39,00 A 2
M 10	S	250	84,00 A 2
M 12	S	250	120,00 A 2
M 14	S	25	211,00 A 2
M 16	S	50	211,00 A 2
M 18	S	10	540,00 A 2
M 20	S	25	540,00 A 2
M 22	S	10	1220,00 A 2
M 24	S	25	1220,00 A 2
M 27	S	1	6100,00 A 2
M 30*	S	1	4750,00 A 2
M 33*	S	1	5500,00 A 2
M 36*	S	5	4700,00 A 2
M 42*	S	1	6800,00 A 2
M 48*	S	1	11300,00 A 2

ISO	04032.931	
4032	A 2 - 70	geschmied

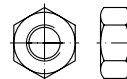

Sechskantmuttern, ISO-Typ 1, geschmied

Reibzahlfenster je Charge auf Anfrage

Maße → **TI-62** Anziehmomente → **TI-249**
 Werkstoffeigensch. → **TI-236** Normumstellung → **TI-7**

ISO 4032 → ersetzt DIN 934

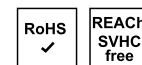

M 6	S	1000	21,20 A 2
M 8	S	500	39,00 A 2
M 10	S	250	84,00 A 2
M 12	S	250	120,00 A 2

Abmessungen	VE	Stück	€/100/Obf.
M 16	S	50	211,00 A2
M 20	S	25	540,00 A2
M 24	S	25	1220,00 A2

ISO	04032.926
4032	A 2 - 70* AD W2

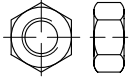

Sechskantmuttern, ISO-Typ 1

für Druckbehälterbau nach AD-Regelwerk,
Fabrikate mit Verzicht eines Abnahmeprüfzeugnis,
*≥ M 30: A 2-50

Maße → [TI-62](#) Anziehmomente → [TI-249](#)
Werkstoffeigensch. → [TI-236](#) Normumstellung → [TI-7](#)

Stahl → [S. 278](#)
Messing, Aluminium, Titan, Kupfer → [S. 637](#)

ISO 4032 → ersetzt DIN 934

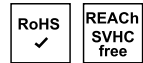

M 10	S	100	730,00 A 2-70
M 12	S	100	840,00 A 2-70
M 14	S	25	1030,00 A 2-70
M 16	S	50	1160,00 A 2-70
M 20	S	25	1560,00 A 2-70
M 24	S	25	2180,00 A 2-70
M 27	S	1	3450,00 A 2-70
M 30	S	1	4000,00 A 2-70
M 33	S	1	4750,00 A 2-70

ISO	04032.940
4032	A 4 (- 70)*

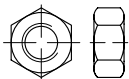

Sechskantmuttern, ISO-Typ 1

**M 5 - M 39 = RAZ 3310 übrige Ø = RAZ 410

Maße → [TI-62](#) Anziehmomente → [TI-249](#)
Werkstoffeigensch. → [TI-236](#) Normumstellung → [TI-7](#)

Stahl → [S. 278](#)
Messing, Aluminium, Titan, Kupfer → [S. 637](#)

ISO 4032 → ersetzt DIN 934

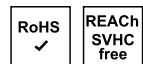

*Fkl. bei diesen Abmessungen je nach Fabrikat abweichend

M 2*	S	1000	38,00 A4
M 2*	K	100	43,50 A4
M 2,5*	S	500	36,50 A4
M 2,5*	K	100	42,00 A4
M 3*	S	1000	15,20 A4
M 3*	K	100	21,90 A4
M 4*	S	1000	17,10 A4
M 4*	K	100	25,50 A4
M 5	S	1000	18,50 A4
M 6	S	1000	28,50 A4
M 7	S	100	52,00 A4
M 8	S	500	55,00 A4

Abmessungen	VE	Stück	€/100/Obf.
M 10	S	250	118,00 A4
M 12	S	250	162,00 A4
M 14	S	25	335,00 A4
M 16	S	50	335,00 A4
M 18	S	10	820,00 A4
M 20	S	25	820,00 A4
M 22	S	10	1660,00 A4
M 24	S	10	1660,00 A4
M 27*	S	10	3150,00 A4
M 30*	S	10	4200,00 A4
M 33*	S	10	5400,00 A4
M 36*	S	5	6600,00 A4
M 39*	S	5	13300,00 A4
M 42*	S	1	9200,00 A4
M 48*	S	1	17500,00 A4

ISO	04032.951
4032	A 4 - 70 geschmiert



Sechskantmuttern, ISO-Typ 1, geschmiert

Reibzahlfenster je Charge auf Anfrage

Maße → [TI-62](#) Anziehmomente → [TI-249](#)
Werkstoffeigensch. → [TI-236](#) Normumstellung → [TI-7](#)

ISO 4032 → ersetzt DIN 934



M 6	S	1000	26,00 A4
M 8	S	500	49,50 A4
M 10	S	250	106,00 A4
M 12	S	250	146,00 A4
M 16	S	50	300,00 A4
M 20	S	25	740,00 A4
M 24	S	25	1500,00 A4

ISO	04032.947
4032	A 4 - 70* AD W2

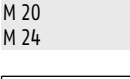

Sechskantmuttern, ISO-Typ 1

für Druckbehälterbau nach AD-Regelwerk,
Fabrikate mit Verzicht eines Abnahmeprüfzeugnis,
*≥ M 30: A 4-50

Maße → [TI-62](#) Anziehmomente → [TI-249](#)
Werkstoffeigensch. → [TI-236](#) Normumstellung → [TI-7](#)

Stahl → [S. 278](#)
Messing, Aluminium, Titan, Kupfer → [S. 637](#)

ISO 4032 → ersetzt DIN 934

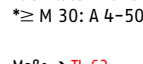

*mechanische Eigenschaften ~ Fkl. 8

M 8	S	500	910,00 A4-70
M 10	S	100	950,00 A4-70
M 12	S	100	1030,00 A4-70
M 14	S	25	1180,00 A4-70

Abmessungen	VE	Stück	€/100/Obf.
M 16	S	50	1410,00 A4-70
M 20	S	25	1930,00 A4-70
M 24	S	25	2700,00 A4-70
M 27	S	1	4200,00 A4-70
M 30	S	1	4850,00 A4-70

ISO	04032.948
4032	A 4 - 80



Sechskantmuttern, ISO-Typ 1

hochfest (stark kaltverfestigt)

Maße → [TI-62](#) Anziehmomente → [TI-249](#)
Werkstoffeigensch. → [TI-236](#) Normumstellung → [TI-7](#)

Stahl → [S. 278](#)
Messing, Aluminium, Titan, Kupfer → [S. 637](#)

ISO 4032 → ersetzt DIN 934

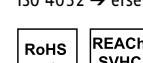

M 5	S	1000	16,20 A4-80
M 6	S	200	21,60 A4-80
M 8	S	200	27,00 A4-80
M 10	S	100	54,00 A4-80
M 12	S	100	70,00 A4-80
M 14	S	100	118,00 A4-80
M 16	S	50	151,00 A4-80
M 18	S	50	550,00 A4-80
M 20	S	50	244,00 A4-80
M 24	S	25	740,00 A4-80

ISO	04032.941
4032	A 4 BUMAX88*



Sechskantmuttern, ISO-Typ 1

Abmessungen ab M 6 für den Einsatz
nach Druckgeräterichtlinie geeignet
→ APZ 3.1 auf Anfrage

Maße → [TI-62](#) Anziehmomente → [TI-250](#)
Werkstoffeigensch. → [TI-237](#) Normumstellung → [TI-7](#)

Stahl → [S. 278](#)
Messing, Aluminium, Titan, Kupfer → [S. 637](#)

*mechanische Eigenschaften ~ Fkl. 8



*mechanische Eigenschaften ~ Fkl. 8

M 6	S	100	100,00 A4-88
M 8	S	100	168,00 A4-88
M 10	S	50	400,00 A4-88
M 12	S	50	680,00 A4-88
M 16	S	25	1750,00 A4-88
M 20	S	25	2900,00 A4-88
M 24	S	10	13700,00 A4-88
M 30	S	10	27500,00 A4-88

Abmessungen	VE Stück	€/100/Obf.
ISO	04032.942	
4032	A 4 BUMAX109*	

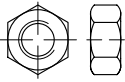

Sechskantmuttern, ISO-Typ 1

Maße → [TI-62](#) Anziehmomente → [TI-250](#)
 Werkstoffeigensch. → [TI-237](#) Normumstellung → [TI-7](#)

Stahl → [S. 278](#)
 Messing, Aluminium, Titan, Kupfer → [S. 637](#)

*mechanische Eigenschaften ~ Fkl. 10

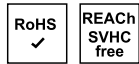

M 6	S	100	244,00 A4-109
M 8	S	100	450,00 A4-109
M 10	S	50	570,00 A4-109
M 12	S	50	780,00 A4-109
M 16	S	25	2800,00 A4-109
M 20	S	25	3800,00 A4-109

ISO	04032.950
4032	1.4571 (A 5)

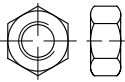

Sechskantmuttern, ISO-Typ 1

Maße → [TI-62](#) Anziehmomente → [TI-249](#)
 Werkstoffeigensch. → [TI-236](#) Normumstellung → [TI-7](#)

Stahl → [S. 278](#)
 Messing, Aluminium, Titan, Kupfer → [S. 637](#)

ISO 4032 → ersetzt DIN 934

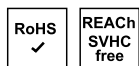

M 6	S	100	214,00 A5
M 8	S	100	233,00 A5
M 10	S	100	248,00 A5
M 12	S	50	315,00 A5
M 16	S	25	540,00 A5
M 20	S	25	1070,00 A5
M 24	S	10	1890,00 A5
M 27	S	10	3000,00 A5
M 30	S	10	4100,00 A5

Abmessungen	VE Stück	€/100/Obf.
ISO	04032.924	
4032	A 2	Links

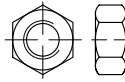

Sechskantmuttern, ISO-Typ 1, mit metrischem Linksgewinde

Maße → [TI-62](#) Anziehmomente → [TI-249](#)
 Werkstoffeigensch. → [TI-236](#) Normumstellung → [TI-7](#)

Stahl → [S. 280](#)

ISO 4032 → ersetzt DIN 934



M 5	S	100	39,00 A2
M 6	S	100	59,00 A2
M 8	S	100	94,00 A2
M 10	S	50	180,00 A2
M 12	S	25	245,00 A2
M 14	S	25	460,00 A2
M 16	S	25	460,00 A2
M 18	S	25	570,00 A2
M 20	S	10	710,00 A2
M 22	S	10	990,00 A2
M 24	S	10	1950,00 A2
M 27	S	1	2050,00 A2
M 30	S	1	2370,00 A2

ISO	04032.944
4032	A 4
	Links

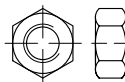

Sechskantmuttern, ISO-Typ 1, mit metrischem Linksgewinde

Maße → [TI-62](#) Anziehmomente → [TI-249](#)
 Werkstoffeigensch. → [TI-236](#) Normumstellung → [TI-7](#)

Stahl → [S. 280](#)

ISO 4032 → ersetzt DIN 934

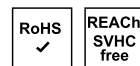

M 5	S	100	55,00 A4
M 6	S	100	76,00 A4
M 8	S	100	116,00 A4
M 10	S	50	217,00 A4
M 12	S	25	295,00 A4
M 14	S	25	550,00 A4
M 16	S	25	570,00 A4
M 18	S	25	780,00 A4
M 20	S	10	950,00 A4
M 22	S	10	1520,00 A4
M 24	S	10	2380,00 A4
M 27	S	1	2950,00 A4
M 30	S	1	3450,00 A4

Abmessungen	VE Stück	€/100/Obf.
ISO	04035.920	
4035	A 2	

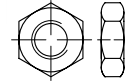

Sechskantmuttern, niedrige Form, mit Fasen

*M 5-M 39 = RAZ 3370 übrige Ø = RAZ 170

Maße → [TI-61](#) Normumstellung → [TI-7](#)
 Werkstoffeigensch. → [TI-236](#)

Stahl → [S. 284](#)
 Messing → [S. 638](#)

ISO 4035 → ersetzt DIN 439 Form B

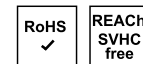

M 2	S	100	38,00 A2
M 2,5	S	100	33,00 A2
M 3	S	1000	24,30 A2
M 3	K	100	28,50 A2
M 4	S	1000	23,30 A2
M 4	K	100	27,50 A2
M 5	S	1000	23,30 A2
M 5	K	100	27,50 A2
M 6	S	1000	33,50 A2
M 6	K	100	37,50 A2
M 8	S	1000	62,00 A2
M 8	K	100	67,00 A2
M 10	S	100	131,00 A2
M 12	S	50	146,00 A2
M 14	S	25	395,00 A2
M 16	S	100	485,00 A2
M 16	K	25	495,00 A2
M 18	S	10	700,00 A2
M 20	S	10	880,00 A2
M 22	S	10	1120,00 A2
M 24	S	10	1500,00 A2
M 27	S	10	2030,00 A2
M 30	S	10	2850,00 A2
M 36	S	1	5100,00 A2



- ✓ Große Artikelvielfalt
- ✓ Verlässliche Qualität
- ✓ Hohe Lieferbereitschaft

Abmessungen	VE Stück	€/100/Obf.
ISO 04035.940		
4035	A 4	

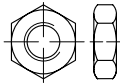

Sechskantmuttern, niedrige Form, mit Fasen

*M 5-M 39 = RAZ 3370 übrige Ø = RAZ 170

Maße → **TI-61** Normumstellung → **TI-7**
 Werkstoffeigensch. → **TI-236**

Stahl → **S. 284**
 Messing → **S. 638**

ISO 4035 → ersetzt DIN 439 Form B

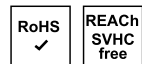

M 2	S	100	63,00A4
M 2,5	S	100	63,00A4
M 3	S	100	36,50A4
M 4	S	100	35,50A4
M 5	S	100	41,00A4
M 6	S	100	47,50A4
M 8	S	100	89,00A4
M 10	S	100	166,00A4
M 12	S	50	355,00A4
M 14	S	25	530,00A4
M 16	S	25	680,00A4
M 18	S	10	930,00A4
M 20	S	10	1220,00A4
M 24	S	10	2040,00A4
M 27	S	10	2850,00A4
M 30	S	10	3950,00A4
M 36	S	1	7100,00A4
M 42	S	1	11200,00A4

Abmessungen	VE Stück	€/100/Obf.
ISO 04762.920		
4762	A 2 (- 70)*	

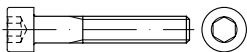

Zylinderschrauben mit Innensechskant

Maße → **TI-12** Anziehmomente → **TI-249**
 Werkstoffeigensch. → **TI-236** Normumstellung → **TI-6**

Stahl → **S. 286**

ISO 4762 → ersetzt DIN 912 (austauschbar)

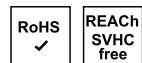

*Fkl. bei diesen Abmessungen je nach Fabrikat abweichend

M 1,6	x	4*	S	100	163,00A2
M 1,6	x	5*	S	100	175,00A2
M 1,6	x	6*	S	100	186,00A2
M 1,6	x	8*	S	100	201,00A2
M 2	x	3*	S	100	81,00A2
M 2	x	4*	S	100	51,00A2
M 2	x	5*	S	100	51,00A2
M 2	x	6*	S	100	51,00A2
M 2	x	8*	S	100	51,00A2
M 2	x	10*	S	100	53,00A2

M 2	x	12*	S	100	56,00A2
M 2	x	16*	S	100	63,00A2
M 2	x	20*	S	100	76,00A2
M 2,5	x	4*	S	100	51,00A2
M 2,5	x	5*	S	100	51,00A2
M 2,5	x	6*	S	100	51,00A2
M 2,5	x	8*	S	100	51,00A2
M 2,5	x	10*	S	100	53,00A2
M 2,5	x	12*	S	100	56,00A2
M 2,5	x	14*	S	100	79,00A2
M 2,5	x	16*	S	100	63,00A2
M 2,5	x	20*	S	100	76,00A2
M 2,5	x	25*	S	100	101,00A2
M 3	x	4*	S	100	38,00A2
M 3	x	5*	S	100	31,00A2
M 3	x	6*	S	100	23,10A2
M 3	x	8*	S	100	20,30A2
M 3	x	10*	S	100	17,50A2
M 3	x	12*	S	100	17,50A2
M 3	x	14*	S	100	14,70A2
M 3	x	16*	S	100	11,70A2
M 3	x	18*	S	100	15,90A2
M 3	x	20*	S	100	12,70A2
M 3	x	22*	S	100	16,60A2
M 3	x	25*	S	100	13,40A2
M 3	x	30*	S	100	17,30A2
M 3	x	35*	S	100	20,30A2
M 3	x	40*	S	100	22,20A2
M 3	x	45*	S	100	40,00A2
M 3	x	50*	S	100	40,00A2
M 4	x	5*	S	100	37,00A2
M 4	x	6*	S	200	25,00A2
M 4	x	8*	S	500	20,30A2
M 4	x	8*	K	200	22,70A2
M 4	x	10*	S	500	18,90A2
M 4	x	10*	K	200	22,80A2
M 4	x	12*	S	500	18,90A2
M 4	x	12*	K	200	22,80A2
M 4	x	14*	S	500	14,70A2
M 4	x	14*	K	200	17,10A2
M 4	x	16*	S	500	11,70A2
M 4	x	16*	K	200	15,60A2
M 4	x	18*	S	500	15,90A2
M 4	x	18*	K	200	18,30A2
M 4	x	20*	S	500	12,70A2
M 4	x	20*	K	200	16,70A2
M 4	x	22*	S	500	16,60A2
M 4	x	22*	K	200	19,00A2
M 4	x	25*	S	500	13,40A2
M 4	x	25*	K	200	15,80A2
M 4	x	30*	S	500	17,30A2
M 4	x	30*	K	200	19,60A2
M 4	x	35*	S	500	17,80A2
M 4	x	35*	K	200	20,20A2
M 4	x	40*	S	500	19,90A2
M 4	x	40*	K	200	22,30A2
M 4	x	45*	S	200	40,00A2
M 4	x	50*	S	200	40,00A2
M 4	x	55*	S	200	235,00A2
M 4	x	60*	S	200	260,00A2
M 4	x	70*	S	200	335,00A2
M 4	x	80*	S	200	860,00A2
M 5	x	6*	S	100	44,50A2
M 5	x	8*	S	100	20,30A2
M 5	x	10	S	500	18,90A2
M 5	x	10	K	100	22,80A2
M 5	x	12	S	500	18,90A2
M 5	x	12	K	100	22,80A2
M 5	x	14	S	500	16,80A2
M 5	x	14	K	100	21,50A2
M 5	x	16	S	500	13,20A2
M 5	x	16	K	100	17,10A2
M 5	x	18	S	500	16,50A2
M 5	x	18	K	100	21,20A2
M 5	x	20	S	500	13,60A2

M 5	x	20	K	100	17,50A2
M 5	x	22	S	500	18,60A2
M 5	x	22	K	100	23,30A2
M 5	x	25	S	500	14,70A2
M 5	x	25	K	100	18,60A2
M 5	x	30	S	500	17,30A2
M 5	x	30	K	100	21,20A2
M 5	x	35	S	500	19,20A2
M 5	x	35	K	100	23,90A2
M 5	x	40	S	500	20,90A2
M 5	x	40	K	100	26,00A2
M 5	x	45	S	100	28,00A2
M 5	x	50	S	100	31,00A2
M 5	x	55	S	100	44,50A2
M 5	x	60	S	100	58,00A2
M 5	x	65	S	100	84,00A2
M 5	x	70	S	100	67,00A2
M 5	x	75	S	100	179,00A2
M 5	x	80	S	100	137,00A2
M 5	x	90	S	100	470,00A2
M 5	x	100	S	100	690,00A2
M 6	x	6*	S	100	46,50A2
M 6	x	8*	S	100	26,50A2
M 6	x	10	S	500	23,10A2
M 6	x	10	K	100	27,50A2
M 6	x	12	S	500	23,10A2
M 6	x	12	K	100	27,50A2
M 6	x	14	S	500	23,30A2
M 6	x	14	K	100	28,50A2
M 6	x	16	S	500	16,30A2
M 6	x	16	K	100	20,30A2
M 6	x	18	S	500	22,20A2
M 6	x	18	K	100	27,00A2
M 6	x	20	S	500	18,10A2
M 6	x	20	K	100	22,00A2
M 6	x	22	S	100	23,10A2
M 6	x	25	S	500	19,50A2
M 6	x	25	K	100	23,50A2
M 6	x	30	S	500	21,10A2
M 6	x	30	K	100	25,00A2
M 6	x	35	S	500	23,90A2
M 6	x	35	K	100	28,00A2
M 6	x	40	S	500	26,00A2
M 6	x	40	K	100	30,00A2
M 6	x	45	S	500	35,00A2
M 6	x	45	K	100	40,00A2
M 6	x	50	S	500	41,50A2
M 6	x	50	K	100	46,50A2
M 6	x	55	S	500	50,00A2
M 6	x	55	K	100	55,00A2
M 6	x	60	S	500	55,00A2
M 6	x	60	K	100	59,00A2
M 6	x	65	S	500	88,00A2
M 6	x	65	K	100	93,00A2
M 6	x	70	S	500	71,00A2
M 6	x	70	K	100	76,00A2
M 6	x	75	S	100	122,00A2
M 6	x	80	S	100	97,00A2
M 6	x	85	S	100	640,00A2
M 6	x	90	S	100	165,00A2
M 6	x	95	S	100	700,00A2
M 6	x	100	S	100	184,00A2
M 6	x	110	S	100	203,00A2
M 6	x	120	S	100	241,00A2
M 6	x	130	S	50	265,00A2
M 6	x	140	S	50	300,00A2
M 6	x	150	S	50	340,00A2
M 8	x	8*	S	100	194,00A2
M 8	x	10	S	100	45,50A2
M 8	x	12	S	200	42,50A2
M 8	x	14	S	200	52,00A2
M 8	x	16	S	200	37,00A2
M 8	x	16	K	100	41,00A2
M 8	x	18	S	200	42,50A2
M 8	x	20	S	200	31,50A2

Abmessungen	VE	Stück	€/100/0bf.	Abmessungen	VE	Stück	€/100/0bf.	Abmessungen	VE	Stück	€/100/0bf.
M 8 x 20	K	100	35,50A2	M 12 x 140	S	1	630,00A2	M 24 x 55	S	1	3000,00A2
M 8 x 22	S	200	38,00A2	M 12 x 150	S	1	710,00A2	M 24 x 60	S	1	2180,00A2
M 8 x 25	S	200	29,50A2	M 12 x 160	S	1	2040,00A2	M 24 x 65	S	1	3150,00A2
M 8 x 25	K	100	33,50A2	M 12 x 170*	S	1	2230,00A2	M 24 x 70	S	1	2220,00A2
M 8 x 30	S	200	33,00A2	M 12 x 180*	S	1	2750,00A2	M 24 x 75	S	1	3250,00A2
M 8 x 30	K	100	37,00A2	M 14 x 20	S	50	880,00A2	M 24 x 80	S	1	2390,00A2
M 8 x 35	S	200	36,00A2	M 14 x 25	S	50	620,00A2	M 24 x 90	S	1	2700,00A2
M 8 x 35	K	100	40,00A2	M 14 x 30	S	50	460,00A2	M 24 x 100	S	1	2900,00A2
M 8 x 40	S	200	39,50A2	M 14 x 35	S	50	460,00A2	M 24 x 110	S	1	3500,00A2
M 8 x 40	K	100	43,50A2	M 14 x 40	S	50	460,00A2	M 24 x 120	S	1	3800,00A2
M 8 x 45	S	200	44,50A2	M 14 x 45	S	50	485,00A2	M 24 x 130	S	1	4100,00A2
M 8 x 50	S	200	48,50A2	M 14 x 50	S	50	530,00A2	M 24 x 140	S	1	4400,00A2
M 8 x 55	S	200	66,00A2	M 14 x 55	S	50	620,00A2	M 24 x 150	S	1	4650,00A2
M 8 x 60	S	200	68,00A2	M 14 x 60	S	50	640,00A2	M 24 x 160*	S	1	7300,00A2
M 8 x 65	S	200	137,00A2	M 14 x 65	S	50	900,00A2	M 24 x 170*	S	1	7900,00A2
M 8 x 70	S	200	104,00A2	M 14 x 70	S	50	900,00A2	M 24 x 180*	S	1	8400,00A2
M 8 x 75	S	200	203,00A2	M 14 x 80	S	50	920,00A2	M 24 x 200*	S	1	9300,00A2
M 8 x 80	S	200	135,00A2	M 14 x 90	S	1	1040,00A2	M 30 x 50*	S	1	5700,00A2
M 8 x 85	S	100	260,00A2	M 14 x 100	S	1	1220,00A2	M 30 x 60*	S	1	5800,00A2
M 8 x 90	S	200	148,00A2	M 14 x 110	S	1	1930,00A2	M 30 x 70*	S	1	6100,00A2
M 8 x 100	S	200	166,00A2	M 14 x 120	S	1	2180,00A2	M 30 x 80*	S	1	6400,00A2
M 8 x 110	S	50	222,00A2	M 14 x 130	S	1	2550,00A2	M 30 x 90*	S	1	6800,00A2
M 8 x 120	S	50	265,00A2	M 14 x 140	S	1	2900,00A2	M 30 x 100*	S	1	7100,00A2
M 8 x 130	S	50	290,00A2	M 14 x 150	S	1	3250,00A2	M 30 x 110*	S	1	7500,00A2
M 8 x 140	S	50	320,00A2	M 16 x 20	S	50	560,00A2	M 30 x 120*	S	1	7800,00A2
M 8 x 150	S	50	350,00A2	M 16 x 25	S	25	345,00A2	M 30 x 130*	S	1	8200,00A2
M 8 x 160*	S	50	920,00A2	M 16 x 30	S	25	260,00A2	M 30 x 140*	S	1	8500,00A2
M 8 x 170*	S	50	1210,00A2	M 16 x 35	S	25	260,00A2	M 30 x 150*	S	1	8900,00A2
M 8 x 180*	S	50	1700,00A2	M 16 x 40	S	25	260,00A2				
M 10 x 12	S	100	124,00A2	M 16 x 45	S	25	270,00A2				
M 10 x 16	S	100	70,00A2	M 16 x 50	S	25	295,00A2				
M 10 x 18	S	100	84,00A2	M 16 x 55	S	25	345,00A2				
M 10 x 20	S	100	55,00A2	M 16 x 60	S	25	355,00A2				
M 10 x 25	S	100	50,00A2	M 16 x 65	S	25	500,00A2				
M 10 x 30	S	100	53,00A2	M 16 x 70	S	25	500,00A2				
M 10 x 35	S	100	55,00A2	M 16 x 75	S	25	740,00A2				
M 10 x 40	S	100	59,00A2	M 16 x 80	S	25	510,00A2				
M 10 x 45	S	100	71,00A2	M 16 x 90	S	25	580,00A2				
M 10 x 50	S	100	75,00A2	M 16 x 100	S	25	680,00A2				
M 10 x 55	S	100	98,00A2	M 16 x 110	S	25	1080,00A2				
M 10 x 60	S	100	105,00A2	M 16 x 120	S	25	1210,00A2				
M 10 x 65	S	100	155,00A2	M 16 x 130	S	25	1410,00A2				
M 10 x 70	S	100	124,00A2	M 16 x 140	S	1	1600,00A2				
M 10 x 75	S	100	228,00A2	M 16 x 150	S	1	1790,00A2				
M 10 x 80	S	100	152,00A2	M 16 x 160	S	1	3700,00A2				
M 10 x 90	S	100	173,00A2	M 16 x 170*	S	1	4000,00A2				
M 10 x 100	S	100	211,00A2	M 16 x 180*	S	1	4300,00A2				
M 10 x 110	S	50	290,00A2	M 16 x 190*	S	1	4550,00A2				
M 10 x 120	S	50	320,00A2	M 16 x 200*	S	1	5200,00A2				
M 10 x 130	S	50	390,00A2	M 20 x 30	S	10	910,00A2				
M 10 x 140	S	50	465,00A2	M 20 x 35	S	25	910,00A2				
M 10 x 150	S	50	530,00A2	M 20 x 40	S	25	590,00A2				
M 10 x 160*	S	50	1550,00A2	M 20 x 45	S	25	590,00A2				
M 10 x 170*	S	50	1750,00A2	M 20 x 50	S	25	590,00A2				
M 10 x 180*	S	50	2230,00A2	M 20 x 55	S	25	650,00A2				
M 12 x 16	S	100	177,00A2	M 20 x 60	S	25	670,00A2				
M 12 x 20	S	100	88,00A2	M 20 x 65	S	25	930,00A2				
M 12 x 25	S	100	83,00A2	M 20 x 70	S	25	760,00A2				
M 12 x 30	S	100	77,00A2	M 20 x 75	S	25	1060,00A2				
M 12 x 35	S	100	82,00A2	M 20 x 80	S	1	870,00A2				
M 12 x 40	S	100	88,00A2	M 20 x 90	S	1	1170,00A2				
M 12 x 45	S	100	98,00A2	M 20 x 100	S	1	1350,00A2				
M 12 x 50	S	100	106,00A2	M 20 x 110	S	1	2080,00A2				
M 12 x 55	S	100	139,00A2	M 20 x 120	S	1	2370,00A2				
M 12 x 60	S	100	144,00A2	M 20 x 130	S	1	3000,00A2				
M 12 x 65	S	100	228,00A2	M 20 x 140	S	1	3350,00A2				
M 12 x 70	S	100	182,00A2	M 20 x 150	S	1	3800,00A2				
M 12 x 75	S	100	350,00A2	M 20 x 160*	S	1	5700,00A2				
M 12 x 80	S	100	190,00A2	M 20 x 170*	S	1	6000,00A2				
M 12 x 85	S	100	600,00A2	M 20 x 180*	S	1	6500,00A2				
M 12 x 90	S	100	237,00A2	M 20 x 190*	S	1	7000,00A2				
M 12 x 100	S	100	275,00A2	M 20 x 200*	S	1	7500,00A2				
M 12 x 110	S	10	405,00A2	M 24 x 40	S	1	2700,00A2				
M 12 x 120	S	10	445,00A2	M 24 x 45	S	1	2700,00A2				
M 12 x 130	S	10	530,00A2	M 24 x 50	S	1	2080,00A2				

ISO 04762.940
4762 A 4 (-70)*



Zylinderschrauben mit Innensechskant

Maße → TI-12 Anziehmomente → TI-249
 Werkstoffeigensch. → TI-236 Normumstellung → TI-6

Stahl → S. 286

ISO 4762 → ersetzt DIN 912 (austauschbar)

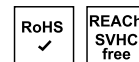

*Fkl. bei diesen Abmessungen je nach Fabrikat abweichend

M 2 x 3*	S	100	116,00A4
M 2 x 4*	S	100	65,00A4
M 2 x 5*	S	100	65,00A4
M 2 x 6*	S	100	65,00A4
M 2 x 8*	S	100	65,00A4
M 2 x 10*	S	100	68,00A4
M 2 x 12*	S	100	71,00A4
M 2 x 16*	S	100	81,00A4
M 2,5 x 4*	S	100	65,00A4
M 2,5 x 5*	S	100	65,00A4
M 2,5 x 6*	S	100	65,00A4
M 2,5 x 8*	S	100	65,00A4
M 2,5 x 10*	S	100	68,00A4
M 2,5 x 12*	S	100	71,00A4
M 2,5 x 14*	S	100	99,00A4
M 2,5 x 16*	S	100	81,00A4
M 2,5 x 20*	S	100	100,00A4
M 3 x 4*	S	100	52,00A4
M 3 x 5*	S	100	49,50A4
M 3 x 6*	S	100	37,50A4
M 3 x 8*	S	100	31,50A4
M 3 x 10*	S	100	27,00A4
M 3 x 12*	S	100	27,00A4
M 3 x 14*	S	100	27,00A4
M 3 x 16*	S	100	18,30A4

Abmessungen	VE	Stück	€/100/Obf.	Abmessungen	VE	Stück	€/100/Obf.	Abmessungen	VE	Stück	€/100/Obf.
M 3 x 18*	S	100	23,50A4	M 6 x 12	K	100	39,50A4	M 10 x 35	S	100	79,00A4
M 3 x 20*	S	100	19,30A4	M 6 x 14	S	500	37,00A4	M 10 x 40	S	100	84,00A4
M 3 x 22*	S	100	24,80A4	M 6 x 14	K	100	42,50A4	M 10 x 45	S	100	100,00A4
M 3 x 25*	S	100	20,60A4	M 6 x 16	S	500	25,00A4	M 10 x 50	S	100	113,00A4
M 3 x 30*	S	100	24,00A4	M 6 x 16	K	100	30,50A4	M 10 x 55	S	100	133,00A4
M 3 x 35*	S	100	32,50A4	M 6 x 18	S	500	34,00A4	M 10 x 60	S	100	144,00A4
M 3 x 40*	S	100	35,50A4	M 6 x 18	K	100	39,00A4	M 10 x 65	S	100	207,00A4
M 3 x 45*	S	100	63,00A4	M 6 x 20	S	500	27,00A4	M 10 x 70	S	100	167,00A4
M 3 x 50*	S	100	63,00A4	M 6 x 20	K	100	32,50A4	M 10 x 75	S	100	295,00A4
M 4 x 5*	S	100	66,00A4	M 6 x 22	S	500	36,50A4	M 10 x 80	S	100	197,00A4
M 4 x 6*	S	200	39,00A4	M 6 x 22	K	100	41,50A4	M 10 x 90	S	100	242,00A4
M 4 x 8*	S	500	31,50A4	M 6 x 25	S	500	30,00A4	M 10 x 100	S	100	300,00A4
M 4 x 8*	K	200	34,00A4	M 6 x 25	K	100	35,00A4	M 10 x 110	S	50	520,00A4
M 4 x 10*	S	500	29,00A4	M 6 x 30	S	500	32,00A4	M 10 x 120	S	50	560,00A4
M 4 x 10*	K	200	31,50A4	M 6 x 30	K	100	37,00A4	M 10 x 130	S	1	670,00A4
M 4 x 12*	S	500	29,00A4	M 6 x 35	S	500	33,50A4	M 10 x 140	S	1	810,00A4
M 4 x 12*	K	200	31,50A4	M 6 x 35	K	100	39,00A4	M 10 x 150	S	1	890,00A4
M 4 x 14*	S	500	29,00A4	M 6 x 40	S	500	38,50A4	M 10 x 160*	S	1	2410,00A4
M 4 x 14*	K	200	31,50A4	M 6 x 40	K	100	44,00A4	M 10 x 170*	S	1	2750,00A4
M 4 x 16*	S	500	18,30A4	M 6 x 45	S	500	51,00A4	M 10 x 180*	S	1	3450,00A4
M 4 x 16*	K	200	20,90A4	M 6 x 45	K	100	56,00A4	M 12 x 16	S	100	219,00A4
M 4 x 18*	S	500	23,50A4	M 6 x 50	S	500	58,00A4	M 12 x 20	S	100	155,00A4
M 4 x 18*	K	200	26,50A4	M 6 x 50	K	100	64,00A4	M 12 x 25	S	100	148,00A4
M 4 x 20*	S	500	19,30A4	M 6 x 55	S	500	72,00A4	M 12 x 30	S	100	112,00A4
M 4 x 20*	K	200	22,00A4	M 6 x 60	S	500	75,00A4	M 12 x 35	S	100	120,00A4
M 4 x 22*	S	500	24,80A4	M 6 x 60	K	100	81,00A4	M 12 x 40	S	100	129,00A4
M 4 x 25*	S	500	20,60A4	M 6 x 65	S	500	129,00A4	M 12 x 45	S	100	146,00A4
M 4 x 25*	K	200	23,20A4	M 6 x 65	K	100	134,00A4	M 12 x 50	S	100	157,00A4
M 4 x 30*	S	500	24,00A4	M 6 x 70	S	500	87,00A4	M 12 x 55	S	100	197,00A4
M 4 x 30*	K	200	27,00A4	M 6 x 70	K	100	93,00A4	M 12 x 60	S	100	210,00A4
M 4 x 35*	S	500	32,00A4	M 6 x 75	S	100	157,00A4	M 12 x 65	S	100	280,00A4
M 4 x 35*	K	200	35,00A4	M 6 x 80	S	100	137,00A4	M 12 x 70	S	100	233,00A4
M 4 x 40*	S	500	38,50A4	M 6 x 90	S	100	280,00A4	M 12 x 75	S	100	420,00A4
M 4 x 40*	K	200	41,00A4	M 6 x 100	S	100	315,00A4	M 12 x 80	S	100	285,00A4
M 4 x 45*	S	200	63,00A4	M 6 x 110	S	100	340,00A4	M 12 x 90	S	100	330,00A4
M 4 x 50*	S	200	63,00A4	M 6 x 120	S	100	405,00A4	M 12 x 100	S	100	390,00A4
M 4 x 55*	S	200	233,00A4	M 6 x 130	S	100	460,00A4	M 12 x 110	S	10	700,00A4
M 4 x 60*	S	200	310,00A4	M 6 x 140	S	100	530,00A4	M 12 x 120	S	10	770,00A4
M 4 x 70*	S	200	395,00A4	M 6 x 150	S	100	590,00A4	M 12 x 130	S	10	920,00A4
M 5 x 6*	S	100	65,00A4	M 8 x 10	S	100	62,00A4	M 12 x 140	S	1	1080,00A4
M 5 x 8*	S	100	37,00A4	M 8 x 12	S	200	58,00A4	M 12 x 150	S	1	1240,00A4
M 5 x 10	S	500	29,00A4	M 8 x 14	S	200	67,00A4	M 12 x 160	S	1	3050,00A4
M 5 x 10	K	100	34,00A4	M 8 x 16	S	200	50,00A4	M 12 x 170*	S	1	3250,00A4
M 5 x 12	S	500	29,00A4	M 8 x 18	S	200	57,00A4	M 12 x 180*	S	1	3500,00A4
M 5 x 12	K	100	34,00A4	M 8 x 20	S	200	39,00A4	M 14 x 20	S	50	1140,00A4
M 5 x 14	S	500	29,00A4	M 8 x 22	S	200	53,00A4	M 14 x 25	S	50	850,00A4
M 5 x 14	K	100	34,00A4	M 8 x 25	S	200	42,00A4	M 14 x 30	S	50	750,00A4
M 5 x 16	S	500	20,10A4	M 8 x 30	S	200	44,00A4	M 14 x 35	S	50	750,00A4
M 5 x 16	K	100	25,50A4	M 8 x 35	S	200	48,50A4	M 14 x 40	S	50	750,00A4
M 5 x 18	S	500	28,00A4	M 8 x 40	S	200	62,00A4	M 14 x 45	S	50	810,00A4
M 5 x 18	K	100	33,00A4	M 8 x 45	S	200	72,00A4	M 14 x 50	S	50	860,00A4
M 5 x 20	S	500	21,90A4	M 8 x 50	S	200	82,00A4	M 14 x 55	S	50	980,00A4
M 5 x 20	K	100	27,50A4	M 8 x 55	S	200	93,00A4	M 14 x 60	S	50	1100,00A4
M 5 x 22	S	500	29,00A4	M 8 x 60	S	200	97,00A4	M 14 x 65	S	50	1430,00A4
M 5 x 22	K	100	34,00A4	M 8 x 65	S	200	189,00A4	M 14 x 70	S	1	1200,00A4
M 5 x 25	S	500	22,30A4	M 8 x 70	S	200	152,00A4	M 14 x 80	S	1	1650,00A4
M 5 x 25	K	100	27,50A4	M 8 x 75	S	200	290,00A4	M 14 x 90	S	1	1870,00A4
M 5 x 30	S	500	27,00A4	M 8 x 80	S	200	189,00A4	M 14 x 100	S	1	2120,00A4
M 5 x 30	K	100	32,00A4	M 8 x 90	S	200	214,00A4	M 14 x 110	S	1	3300,00A4
M 5 x 35	S	500	33,50A4	M 8 x 100	S	200	242,00A4	M 14 x 120	S	1	3900,00A4
M 5 x 35	K	100	38,50A4	M 8 x 110	S	50	390,00A4	M 14 x 130	S	1	4450,00A4
M 5 x 40	S	500	36,50A4	M 8 x 120	S	50	450,00A4	M 14 x 140	S	1	5100,00A4
M 5 x 40	K	100	42,00A4	M 8 x 130	S	50	495,00A4	M 14 x 150	S	1	5800,00A4
M 5 x 45	S	100	40,00A4	M 8 x 140	S	50	560,00A4	M 16 x 20	S	50	700,00A4
M 5 x 50	S	100	45,00A4	M 8 x 150	S	50	630,00A4	M 16 x 25	S	25	470,00A4
M 5 x 55	S	100	63,00A4	M 8 x 160*	S	50	1530,00A4	M 16 x 30	S	25	415,00A4
M 5 x 60	S	100	80,00A4	M 8 x 170*	S	50	1930,00A4	M 16 x 35	S	25	415,00A4
M 5 x 70	S	100	95,00A4	M 8 x 180*	S	50	2600,00A4	M 16 x 40	S	25	415,00A4
M 5 x 80	S	100	212,00A4	M 10 x 10*	S	100	475,00A4	M 16 x 45	S	25	450,00A4
M 5 x 90	S	100	580,00A4	M 10 x 12	S	100	152,00A4	M 16 x 50	S	25	475,00A4
M 5 x 100	S	100	1020,00A4	M 10 x 16	S	100	92,00A4	M 16 x 55	S	25	550,00A4
M 6 x 8*	S	100	37,00A4	M 10 x 18	S	100	120,00A4	M 16 x 60	S	25	610,00A4
M 6 x 10	S	500	33,50A4	M 10 x 20	S	100	73,00A4	M 16 x 65	S	25	800,00A4
M 6 x 10	K	100	38,50A4	M 10 x 25	S	100	70,00A4	M 16 x 70	S	25	670,00A4
M 6 x 12	S	500	34,00A4	M 10 x 30	S	100	73,00A4	M 16 x 75	S	1	1290,00A4

Abmessungen	VE	Stück	€/100/0bf.
M 16 x 80	S	25	920,00 A4
M 16 x 90	S	25	1040,00 A4
M 16 x 100	S	25	1180,00 A4
M 16 x 110	S	1	1830,00 A4
M 16 x 120	S	1	2150,00 A4
M 16 x 130	S	1	2470,00 A4
M 16 x 140	S	1	2800,00 A4
M 16 x 150	S	1	3250,00 A4
M 16 x 160	S	1	4650,00 A4
M 16 x 170*	S	1	4950,00 A4
M 16 x 180*	S	1	5300,00 A4
M 16 x 190*	S	1	5600,00 A4
M 16 x 200*	S	1	6100,00 A4
M 16 x 220*	S	1	9400,00 A4
M 16 x 240*	S	1	11100,00 A4
M 16 x 250*	S	1	12100,00 A4
M 16 x 260*	S	1	13500,00 A4
M 16 x 280*	S	1	16200,00 A4
M 16 x 300*	S	1	19500,00 A4
M 18 x 40*	S	1	1970,00 A4
M 18 x 45*	S	1	1970,00 A4
M 18 x 50*	S	1	2220,00 A4
M 18 x 55*	S	1	2400,00 A4
M 18 x 60*	S	1	2600,00 A4
M 18 x 65*	S	1	3350,00 A4
M 18 x 70*	S	1	2850,00 A4
M 18 x 75*	S	1	4350,00 A4
M 18 x 80*	S	1	3650,00 A4
M 18 x 90*	S	1	4150,00 A4
M 18 x 100*	S	1	4650,00 A4
M 18 x 110*	S	1	7200,00 A4
M 18 x 120*	S	1	8100,00 A4
M 20 x 30	S	1	1610,00 A4
M 20 x 35	S	1	1610,00 A4
M 20 x 40	S	10	1040,00 A4
M 20 x 45	S	10	1130,00 A4
M 20 x 50	S	10	1200,00 A4
M 20 x 55	S	1	1280,00 A4
M 20 x 60	S	1	1390,00 A4
M 20 x 65	S	1	2260,00 A4
M 20 x 70	S	1	1490,00 A4
M 20 x 75	S	1	2800,00 A4
M 20 x 80	S	1	1930,00 A4
M 20 x 90	S	1	2260,00 A4
M 20 x 100	S	1	2600,00 A4
M 20 x 110	S	1	3800,00 A4
M 20 x 120	S	1	4100,00 A4
M 20 x 130	S	1	5100,00 A4
M 20 x 140	S	1	5700,00 A4
M 20 x 150	S	1	6500,00 A4
M 20 x 160*	S	1	7000,00 A4
M 20 x 170*	S	1	7300,00 A4
M 20 x 180*	S	1	7700,00 A4
M 20 x 190*	S	1	8100,00 A4
M 20 x 200*	S	1	8600,00 A4
M 24 x 40	S	1	4300,00 A4
M 24 x 45	S	1	4300,00 A4
M 24 x 50	S	1	3800,00 A4
M 24 x 55	S	1	4950,00 A4
M 24 x 60	S	1	3800,00 A4
M 24 x 65	S	1	5200,00 A4
M 24 x 70	S	1	4200,00 A4
M 24 x 75	S	1	5500,00 A4
M 24 x 80	S	1	4550,00 A4
M 24 x 90	S	1	4850,00 A4
M 24 x 100	S	1	5400,00 A4
M 24 x 110	S	1	5900,00 A4
M 24 x 120	S	1	6500,00 A4
M 24 x 130	S	1	7000,00 A4
M 24 x 140	S	1	7600,00 A4
M 24 x 150	S	1	8100,00 A4
M 24 x 160*	S	1	8700,00 A4
M 24 x 180*	S	1	9600,00 A4
M 24 x 190*	S	1	10100,00 A4
M 24 x 200*	S	1	10600,00 A4

Abmessungen	VE	Stück	€/100/0bf.
M 24 x 210*	S	1	16600,00 A4
M 24 x 220*	S	1	18300,00 A4
M 24 x 230*	S	1	20600,00 A4
M 24 x 240*	S	1	23800,00 A4
M 30 x 50*	S	1	7100,00 A4
M 30 x 60*	S	1	7200,00 A4
M 30 x 70*	S	1	7800,00 A4
M 30 x 80*	S	1	8200,00 A4
M 30 x 90*	S	1	8600,00 A4
M 30 x 100*	S	1	9100,00 A4
M 30 x 110*	S	1	9500,00 A4
M 30 x 120*	S	1	9900,00 A4
M 30 x 130*	S	1	10300,00 A4
M 30 x 140*	S	1	10800,00 A4
M 30 x 150*	S	1	11200,00 A4
M 30 x 160*	S	1	14300,00 A4
M 30 x 170*	S	1	17500,00 A4
M 30 x 180*	S	1	21400,00 A4
M 30 x 200*	S	1	27500,00 A4

ISO 04762.948
4762 A 4 - 80

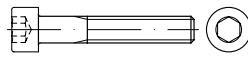

Zylinderschrauben mit Innensechskant

hochfest (stark kaltverfestigt)

Maße → TI-12 Anziehmomente → TI-24-9
 Werkstoffeigensch. → TI-236 Normumstellung → TI-6

Stahl → S. 286

ISO 4762 → ersetzt DIN 912 (austauschbar)

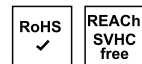

M 6 x 8	S	100	124,00 A4-80
M 6 x 10	S	100	124,00 A4-80
M 6 x 12	S	100	102,00 A4-80
M 6 x 14	S	100	126,00 A4-80
M 6 x 16	S	100	76,00 A4-80
M 6 x 20	S	100	83,00 A4-80
M 6 x 25	S	100	91,00 A4-80
M 6 x 30	S	100	98,00 A4-80
M 6 x 35	S	100	102,00 A4-80
M 6 x 40	S	100	118,00 A4-80
M 6 x 45	S	100	187,00 A4-80
M 6 x 50	S	100	175,00 A4-80
M 6 x 55	S	100	217,00 A4-80
M 6 x 60	S	100	227,00 A4-80
M 6 x 70	S	100	265,00 A4-80
M 8 x 10	S	100	208,00 A4-80
M 8 x 12	S	100	244,00 A4-80
M 8 x 16	S	100	152,00 A4-80
M 8 x 20	S	100	118,00 A4-80
M 8 x 25	S	100	126,00 A4-80
M 8 x 30	S	100	133,00 A4-80
M 8 x 35	S	100	147,00 A4-80
M 8 x 40	S	100	185,00 A4-80
M 8 x 45	S	100	217,00 A4-80
M 8 x 50	S	100	246,00 A4-80
M 8 x 55	S	100	280,00 A4-80
M 8 x 60	S	100	295,00 A4-80
M 8 x 70	S	100	460,00 A4-80
M 8 x 80	S	50	570,00 A4-80
M 8 x 90	S	50	660,00 A4-80
M 8 x 100	S	50	740,00 A4-80
M 10 x 16	S	100	275,00 A4-80

Abmessungen	VE	Stück	€/100/0bf.
M 10 x 20	S	100	280,00 A4-80
M 10 x 25	S	100	210,00 A4-80
M 10 x 30	S	100	221,00 A4-80
M 10 x 35	S	100	240,00 A4-80
M 10 x 40	S	100	255,00 A4-80
M 10 x 45	S	100	300,00 A4-80
M 10 x 50	S	100	340,00 A4-80
M 10 x 55	S	50	405,00 A4-80
M 10 x 60	S	50	435,00 A4-80
M 10 x 70	S	50	500,00 A4-80
M 10 x 80	S	50	600,00 A4-80
M 10 x 90	S	50	740,00 A4-80
M 10 x 100	S	50	910,00 A4-80
M 12 x 20	S	100	465,00 A4-80
M 12 x 25	S	100	445,00 A4-80
M 12 x 30	S	100	340,00 A4-80
M 12 x 35	S	50	365,00 A4-80
M 12 x 40	S	50	390,00 A4-80
M 12 x 45	S	50	440,00 A4-80
M 12 x 50	S	50	470,00 A4-80
M 12 x 55	S	50	600,00 A4-80
M 12 x 60	S	50	640,00 A4-80
M 12 x 70	S	50	710,00 A4-80
M 12 x 80	S	50	870,00 A4-80
M 12 x 90	S	50	1010,00 A4-80
M 12 x 100	S	50	1180,00 A4-80
M 16 x 20	S	50	3050,00 A4-80
M 16 x 25	S	50	1430,00 A4-80
M 16 x 30	S	50	1260,00 A4-80
M 16 x 35	S	50	1260,00 A4-80
M 16 x 40	S	50	1260,00 A4-80
M 16 x 45	S	50	1370,00 A4-80
M 16 x 50	S	50	1450,00 A4-80
M 16 x 55	S	25	1660,00 A4-80
M 16 x 60	S	25	1850,00 A4-80
M 16 x 70	S	25	2020,00 A4-80
M 16 x 80	S	1	2800,00 A4-80
M 16 x 90	S	1	3150,00 A4-80
M 16 x 100	S	1	3550,00 A4-80
M 20 x 30	S	1	4850,00 A4-80
M 20 x 35	S	1	4300,00 A4-80
M 20 x 40	S	1	3150,00 A4-80
M 20 x 45	S	1	3400,00 A4-80
M 20 x 50	S	1	3650,00 A4-80
M 20 x 60	S	1	4200,00 A4-80
M 20 x 70	S	1	4500,00 A4-80
M 20 x 80	S	1	5900,00 A4-80
M 20 x 90	S	1	6900,00 A4-80
M 20 x 100	S	1	7800,00 A4-80



Wir versorgen Sie mit
 Verbindungselementen
 und Befestigungstechnik!

Abmessungen	VE Stück	€/100/Obf.
ISO	04762.941	
4762 A 4 BUMAX88*		

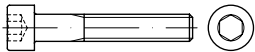

Zylinderschrauben mit Innensechskant

Abmessungen ab M 8 und Länge > 3 x d für den Einsatz nach Druckgeräterichtlinie geeignet → APZ 3.1 auf Anfrage

Maße → **TI-12** Anziehmomente → **TI-250**
 Werkstoffeigensch. → **TI-237** Normumstellung → **TI-6**

Stahl → **S. 286**

*mechanische Eigenschaften ~ Fkl. 8.8

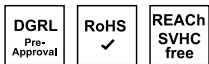

M 3	x	6	S	500	104,00 A4-88
M 3	x	8	S	500	110,00 A4-88
M 3	x	10	S	500	126,00 A4-88
M 3	x	12	S	500	126,00 A4-88
M 3	x	16	S	500	131,00 A4-88
M 3	x	20	S	500	133,00 A4-88
M 3	x	25	S	500	139,00 A4-88
M 4	x	6	S	200	116,00 A4-88
M 4	x	8	S	200	122,00 A4-88
M 4	x	10	S	200	126,00 A4-88
M 4	x	12	S	200	131,00 A4-88
M 4	x	16	S	200	139,00 A4-88
M 4	x	20	S	200	145,00 A4-88
M 4	x	25	S	200	156,00 A4-88
M 4	x	30	S	200	191,00 A4-88
M 5	x	10	S	100	187,00 A4-88
M 5	x	12	S	100	193,00 A4-88
M 5	x	16	S	100	202,00 A4-88
M 5	x	20	S	100	210,00 A4-88
M 5	x	25	S	100	225,00 A4-88
M 5	x	30	S	100	315,00 A4-88
M 5	x	35	S	100	325,00 A4-88
M 5	x	40	S	100	340,00 A4-88
M 5	x	45	S	100	355,00 A4-88
M 5	x	50	S	100	365,00 A4-88
M 6	x	12	S	100	214,00 A4-88
M 6	x	16	S	100	225,00 A4-88
M 6	x	20	S	100	238,00 A4-88
M 6	x	25	S	100	255,00 A4-88
M 6	x	30	S	100	275,00 A4-88
M 6	x	35	S	100	365,00 A4-88
M 6	x	40	S	100	385,00 A4-88
M 6	x	45	S	100	405,00 A4-88
M 6	x	50	S	100	425,00 A4-88
M 6	x	60	S	100	460,00 A4-88
M 6	x	70	S	100	500,00 A4-88
M 8	x	16	S	50	340,00 A4-88
M 8	x	20	S	50	365,00 A4-88
M 8	x	25	S	50	395,00 A4-88
M 8	x	30	S	50	430,00 A4-88
M 8	x	35	S	50	470,00 A4-88
M 8	x	40	S	50	510,00 A4-88
M 8	x	45	S	50	550,00 A4-88
M 8	x	50	S	50	590,00 A4-88
M 8	x	60	S	50	670,00 A4-88
M 10	x	16	S	50	800,00 A4-88
M 10	x	20	S	50	720,00 A4-88
M 10	x	25	S	50	760,00 A4-88
M 10	x	30	S	50	810,00 A4-88
M 10	x	35	S	50	880,00 A4-88

Abmessungen	VE Stück	€/100/Obf.			
M 10	x	40	S	50	920,00 A4-88
M 10	x	45	S	50	1260,00 A4-88
M 10	x	50	S	50	1330,00 A4-88
M 10	x	55	S	50	1430,00 A4-88
M 10	x	60	S	50	1450,00 A4-88
M 10	x	65	S	50	1490,00 A4-88
M 10	x	70	S	50	1560,00 A4-88
M 10	x	75	S	50	1730,00 A4-88
M 10	x	80	S	50	1770,00 A4-88
M 10	x	90	S	50	1890,00 A4-88
M 12	x	20	S	25	960,00 A4-88
M 12	x	25	S	25	1020,00 A4-88
M 12	x	30	S	25	1100,00 A4-88
M 12	x	35	S	25	1160,00 A4-88
M 12	x	40	S	25	1220,00 A4-88
M 12	x	45	S	25	1310,00 A4-88
M 12	x	50	S	25	1390,00 A4-88
M 12	x	60	S	25	1640,00 A4-88
M 12	x	70	S	25	1790,00 A4-88
M 12	x	80	S	25	2060,00 A4-88
M 12	x	90	S	25	2290,00 A4-88
M 12	x	100	S	25	2480,00 A4-88
M 12	x	120	S	25	2850,00 A4-88
M 16	x	35	S	25	2020,00 A4-88
M 16	x	40	S	25	2120,00 A4-88
M 16	x	45	S	25	2290,00 A4-88
M 16	x	50	S	25	2420,00 A4-88
M 16	x	55	S	25	2650,00 A4-88
M 16	x	60	S	25	2800,00 A4-88
M 16	x	80	S	25	3700,00 A4-88
M 16	x	90	S	25	4100,00 A4-88
M 16	x	100	S	25	4350,00 A4-88
M 20	x	40	S	10	5100,00 A4-88
M 20	x	45	S	10	5400,00 A4-88
M 20	x	50	S	10	5600,00 A4-88
M 20	x	60	S	10	6000,00 A4-88
M 20	x	70	S	10	6400,00 A4-88
M 20	x	80	S	10	7100,00 A4-88
M 20	x	90	S	10	7600,00 A4-88
M 20	x	100	S	10	8000,00 A4-88
M 24	x	50	S	10	8200,00 A4-88
M 24	x	60	S	10	8900,00 A4-88
M 24	x	70	S	10	9500,00 A4-88
M 24	x	80	S	10	9700,00 A4-88
M 24	x	90	S	10	11000,00 A4-88
M 24	x	100	S	10	11400,00 A4-88

Abmessungen	VE Stück	€/100/Obf.
ISO	04762.942	
4762 A 4 BUMAX109*		

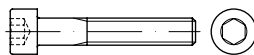

Zylinderschrauben mit Innensechskant

Maße → **TI-12** Anziehmomente → **TI-250**
 Werkstoffeigensch. → **TI-237** Normumstellung → **TI-6**

Stahl → **S. 286**

*mechanische Eigenschaften ~ Fkl. 10.9



M 4	x	12	S	200	1560,00 A4-109
M 4	x	20	S	200	223,00 A4-109
M 6	x	20	S	100	390,00 A4-109
M 6	x	30	S	100	435,00 A4-109
M 6	x	40	S	100	570,00 A4-109
M 6	x	50	S	100	610,00 A4-109

Abmessungen	VE Stück	€/100/Obf.			
M 6	x	60	S	100	670,00 A4-109
M 8	x	20	S	50	510,00 A4-109
M 8	x	30	S	50	580,00 A4-109
M 8	x	40	S	50	660,00 A4-109
M 8	x	50	S	50	740,00 A4-109
M 8	x	60	S	50	740,00 A4-109
M 8	x	70	S	50	900,00 A4-109
M 8	x	80	S	50	1330,00 A4-109
M 8	x	90	S	50	2040,00 A4-109
M 10	x	20	S	50	910,00 A4-109
M 10	x	30	S	50	1040,00 A4-109
M 10	x	40	S	50	1120,00 A4-109
M 10	x	50	S	50	1660,00 A4-109
M 10	x	60	S	50	1830,00 A4-109
M 10	x	70	S	50	1790,00 A4-109
M 10	x	80	S	50	2120,00 A4-109
M 12	x	30	S	25	1490,00 A4-109
M 12	x	40	S	25	1640,00 A4-109
M 12	x	50	S	25	1810,00 A4-109
M 12	x	60	S	25	2080,00 A4-109
M 12	x	70	S	25	2230,00 A4-109
M 12	x	80	S	25	2480,00 A4-109
M 12	x	90	S	25	2750,00 A4-109
M 12	x	100	S	25	2950,00 A4-109
M 12	x	120	S	25	3350,00 A4-109
M 16	x	40	S	25	2750,00 A4-109
M 16	x	50	S	25	2950,00 A4-109
M 16	x	60	S	25	3200,00 A4-109
M 16	x	80	S	25	4200,00 A4-109
M 16	x	90	S	25	4650,00 A4-109
M 16	x	100	S	25	4850,00 A4-109

Abmessungen	VE Stück	€/100/Obf.
ISO	04766.910	
4766 A 1		

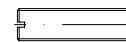

Gewindestifte mit Kegelkuppe, mit Schlitz

Maße → **TI-19** Normumstellung → **TI-6**
 Werkstoffeigensch. → **TI-236**

Stahl → **S. 305**

Messing, Kunststoff → **S. 638**

ISO 4766 → ersetzt DIN 551 (austauschbar)



M 3	x	3	S	50	28,50 A1
M 3	x	4	S	50	29,00 A1
M 3	x	5	S	50	30,50 A1
M 3	x	6	S	50	32,50 A1
M 3	x	8	S	50	34,50 A1
M 3	x	10	S	50	36,00 A1
M 4	x	4	S	50	31,50 A1
M 4	x	5	S	50	31,50 A1
M 4	x	6	S	50	33,00 A1
M 4	x	8	S	50	35,50 A1
M 4	x	10	S	50	37,00 A1
M 4	x	12	S	50	39,00 A1
M 4	x	16	S	50	41,50 A1
M 5	x	5	S	50	34,50 A1
M 5	x	6	S	50	36,00 A1
M 5	x	8	S	50	38,50 A1
M 5	x	10	S	50	40,50 A1
M 5	x	12	S	50	43,00 A1
M 5	x	16	S	50	47,50 A1
M 5	x	20	S	25	62,00 A1

Abmessungen	VE	Stück	€/100/Obf.
M 5 x 25	S	25	72,00 A1
M 6 x 6	S	25	43,50 A1
M 6 x 8	S	25	45,50 A1
M 6 x 10	S	25	48,50 A1
M 6 x 12	S	25	53,00 A1
M 6 x 16	S	25	55,00 A1
M 6 x 20	S	25	63,00 A1
M 6 x 25	S	25	72,00 A1
M 6 x 30	S	25	85,00 A1
M 6 x 40	S	25	97,00 A1
M 8 x 8	S	50	57,00 A1
M 8 x 10	S	25	70,00 A1
M 8 x 12	S	25	76,00 A1
M 8 x 16	S	25	85,00 A1
M 8 x 20	S	25	101,00 A1
M 8 x 25	S	25	120,00 A1
M 8 x 30	S	25	131,00 A1
M 8 x 35	S	25	139,00 A1
M 8 x 40	S	25	150,00 A1
M 10 x 10	S	10	122,00 A1
M 10 x 12	S	10	122,00 A1
M 10 x 16	S	10	129,00 A1
M 10 x 20	S	10	159,00 A1
M 10 x 25	S	10	180,00 A1
M 10 x 30	S	10	192,00 A1
M 10 x 35	S	10	205,00 A1
M 10 x 40	S	10	216,00 A1

ISO	04766.940
4766	A 4



Gewindestifte mit Kegelkuppe, mit Schlitz

Maße → **TI-19** Normumstellung → **TI-6**
 Werkstoffeigensch. → **TI-236**

Stahl → **S. 305**
 Messing, Kunststoff → **S. 638**

ISO 4766 → ersetzt DIN 551 (austauschbar)

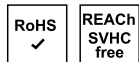

M 3 x 4	S	50	124,00 A4
M 3 x 6	S	50	141,00 A4
M 3 x 8	S	50	147,00 A4
M 3 x 10	S	50	156,00 A4
M 4 x 5	S	50	88,00 A4
M 4 x 6	S	50	92,00 A4
M 4 x 10	S	50	103,00 A4
M 4 x 16	S	50	116,00 A4
M 4 x 20	S	50	135,00 A4
M 4 x 25	S	50	162,00 A4
M 4 x 30	S	50	185,00 A4
M 5 x 5	S	50	350,00 A4
M 5 x 6	S	50	100,00 A4
M 5 x 8	S	50	107,00 A4
M 5 x 10	S	50	114,00 A4
M 5 x 12	S	25	131,00 A4
M 5 x 16	S	25	141,00 A4
M 5 x 20	S	25	168,00 A4
M 6 x 5	S	25	110,00 A4
M 6 x 6	S	25	118,00 A4
M 6 x 8	S	25	122,00 A4
M 6 x 10	S	25	131,00 A4
M 6 x 12	S	25	141,00 A4
M 6 x 16	S	25	149,00 A4

Abmessungen	VE	Stück	€/100/Obf.
M 6 x 20	S	25	172,00 A4
M 6 x 25	S	25	200,00 A4
M 6 x 30	S	25	233,00 A4
M 8 x 6	S	25	168,00 A4
M 8 x 8	S	25	168,00 A4
M 8 x 10	S	25	191,00 A4
M 8 x 12	S	25	210,00 A4
M 8 x 16	S	25	233,00 A4
M 8 x 20	S	25	280,00 A4
M 8 x 30	S	25	365,00 A4
M 8 x 40	S	25	420,00 A4

DIN	06330.942
6330	A 4 Form B

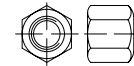

Sechskantmutter mit einer Höhe von 1,5 d, B = kugelige u. ebene Auflagefläche

Maße → **TI-64** Werkstoffeigensch. → **TI-236**

Stahl → **S. 309**



Gewinde – Schlüsselweite

BM 6 SW 10	S	25	315,00 A4
BM 8 SW 13	S	25	390,00 A4
BM 10 SW 17	S	25	560,00 A4
BM 12 SW 19	S	25	720,00 A4
BM 16 SW 24	S	10	1280,00 A4
BM 20 SW 30	S	10	2140,00 A4
BM 24 SW 36	S	10	3700,00 A4

DIN	06331.940
6331	A 4



Sechskantmutter mit Bund, mit einer Höhe von 1,5 d

Maße → **TI-64** Werkstoffeigensch. → **TI-236**

Stahl → **S. 309**



Gewinde – Schlüsselweite

M 8 SW 13	S	10	700,00 A4
M 10 SW 16	S	10	980,00 A4
M 12 SW 18	S	10	1280,00 A4
M 16 SW 24	S	10	2250,00 A4
M 20 SW 30	S	10	3950,00 A4
M 24 SW 36	S	10	7200,00 A4

Abmessungen	VE	Stück	€/100/Obf.
DIN	06334.940		
6334	A 4		

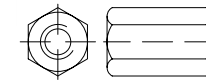

Sechskantmutter mit einer Höhe von 3 d

Maße → **TI-64**

Werkstoffeigensch. → **TI-236**

Stahl → **S. 310**

Runde und Sechskant-Muffen
 → Artikel 88088/88087

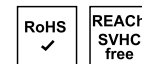

Innengewinde – Schlüsselweite SW

M 6 SW10	S	10	1520,00 A4
M 8 SW13	S	10	1520,00 A4
M 10 SW17	S	10	2650,00 A4
M 12 SW19	S	10	3700,00 A4
M 16 SW24	S	10	6100,00 A4
M 20 SW30	S	10	8900,00 A4
M 24 SW36	S	10	12800,00 A4

DIN	06796.(*)
6796	1.4310/A 2*

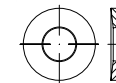

Spannscheiben für Schraubverbindungen

*≤ Ø 8 = 1.4310 = (960), > Ø 8 = A2 = (920)

Achtung! Reduzierte Federkräfte.

Werkstoffeigensch. → **TI-236**

Federstahl → **S. 311**

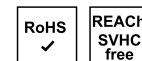

Nenn Ø x Außen Ø x Dicke

4 x 9 x 1	S	1000	29,50
5 x 11 x 1,2	S	1000	34,00
6 x 14 x 1,5	S	1000	64,00
8 x 18 x 2	S	500	77,00
10 x 23 x 2,5	S	500	88,00
12 x 29 x 3	S	250	100,00

Abmessungen	VE Stück	€/100/Obf.
~DIN	06796.940	
6796	A 4	

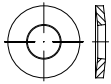

Spannscheiben für Schraubverbindungen

Achtung! Reduzierte Federkräfte.

Werkstoffeigensch. → TI-236

Federstahl → S. 311



Nenn Ø x Außen Ø x Dicke

5	x	11	x	1,2	S	100	70,00 A4
6	x	14	x	1,5	S	100	270,00 A4
8	x	18	x	2	S	100	295,00 A4
10	x	23	x	2,5	S	100	465,00 A4
12	x	29	x	3	S	100	770,00 A4
16	x	39	x	4	S	50	2250,00 A4
20	x	45	x	5	S	25	4100,00 A4

~DIN	06797.961
6797	1.4310 Form A

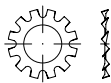

Zahnscheiben, A = außengezähnt

Achtung! Reduzierte Federkräfte.

Maße → TI-99

Werkstoffeigensch. → TI-236

Federstahl → S. 311



A 3,2	S	2000	3,80
A 3,2	K	100	8,30
A 4,3	S	1000	4,55
A 4,3	K	100	9,00
A 5,3	S	1000	6,00
A 5,3	K	100	10,60
A 6,4	S	1000	7,10
A 6,4	K	100	11,60
A 8,4	S	1000	12,90
A 8,4	K	100	17,30
A 10,5	S	1000	19,50
A 10,5	K	100	24,10
A 13	S	100	22,60
A 17	S	50	49,50

Abmessungen	VE Stück	€/100/Obf.
~DIN	06797.964	
6797	1.4310 Form I	

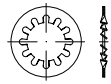

Zahnscheiben, I = innengezähnt

Achtung! Reduzierte Federkräfte.

Maße → TI-99

Werkstoffeigensch. → TI-236

Federstahl → S. 312

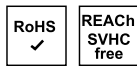

I 3,2	S	2000	3,90
I 4,3	S	1000	4,65
I 5,3	S	1000	6,30
I 6,4	S	1000	7,40
I 8,4	S	1000	13,30
I 10,5	S	1000	27,50
I 12,5	S	500	40,50

~DIN	06798.961
6798	1.4310 Form A

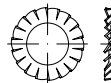

Fächerscheiben, A = außengezähnt

Achtung! Reduzierte Federkräfte.

Maße → TI-99

Werkstoffeigensch. → TI-236

Federstahl → S. 313

Bronze → S. 639



A 2,2	K	1000	5,30
A 3,2	S	2000	4,20
A 3,2	K	100	7,90
A 4,3	S	1000	4,95
A 4,3	K	100	8,80
A 5,3	S	1000	7,40
A 5,3	K	100	11,00
A 6,4	S	1000	8,40
A 6,4	K	100	12,20
A 8,4	S	1000	14,20
A 8,4	K	100	17,80
A 10,5	S	1000	20,50
A 10,5	K	100	24,10
A 13	S	100	25,50
A 17	S	50	64,00
A 21	S	50	87,00
A 25	S	50	112,00

Abmessungen	VE Stück	€/100/Obf.
~DIN	06798.964	
6798	1.4310 Form I	

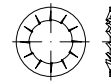

Fächerscheiben, I = innengezähnt

Achtung! Reduzierte Federkräfte.

Maße → TI-99

Werkstoffeigensch. → TI-236

Federstahl → S. 313

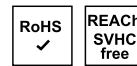

I 3,2	S	2000	5,20
I 4,3	S	1000	6,20
I 5,3	S	1000	9,00
I 6,4	S	1000	10,50
I 8,4	S	1000	17,50

~DIN	06798.944
6798	A 4 amagnetisch* Form A

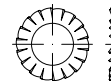

Fächerscheiben, A = außengezähnt

*Permeabilität $\mu \leq 1,1$ H/m

Achtung! Reduzierte Federkräfte.

Maße → TI-99

Werkstoffeigensch. → TI-236

Federstahl → S. 313

Bronze → S. 639

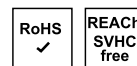

A 3,2	S	2000	18,50 A4
A 4,3	S	1000	20,40 A4
A 5,3	S	1000	27,50 A4
A 6,4	S	1000	31,00 A4
A 8,4	S	1000	52,00 A4
A 10,5	S	1000	81,00 A4
A 13	S	100	89,00 A4
A 17	S	50	98,00 A4

Abmessungen	VE Stück	€/100/Obf.
~DIN 06798.965		
6798	1.4310	Form V

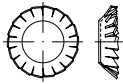

**Fächerscheiben,
V = versenkt**

Achtung! Reduzierte Federkräfte.

Maße → **TI-99** Werkstoffeigensch. → **TI-236**
 Federstahl → **S. 314**

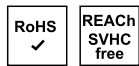

V 3,2	S 1000	9,90
V 4,3	S 1000	11,20
V 5,3	S 1000	16,30
V 6,4	S 1000	23,50
V 8,4	S 1000	38,00
V 10,5	S 1000	49,50
V 13	S 100	72,00

~DIN	06799.300
6799	1.4122

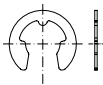

Sicherungsscheiben für Wellen

Achtung! Reduzierte Federkräfte.

Maße → **TI-100** Werkstoffeigensch. → **TI-236**

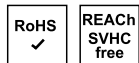

Nennmaß = Nut \varnothing

1,5	S 250	15,80
1,9	S 250	15,40
2,3	S 250	18,00
3,2	S 250	20,50
4	S 250	24,70
5	S 250	32,00
6	S 100	36,50
7	S 100	56,00
8	S 100	71,00
9	S 100	97,00
10	S 100	125,00
12	S 100	178,00
15	S 100	415,00
19	S 50	465,00

Abmessungen	VE Stück	€/100/Obf.
DIN 06885.941		
6885	A 4	Form A

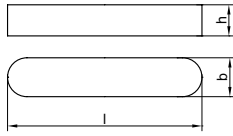

**Passfedern, hohe Form,
A = rundstirnig, ohne Bohrung(en)**

Maße → **TI-138** Werkstoffeigensch. → **TI-236**
 Stahl → **S. 315**



Breite b x Höhe h x Länge l

A 3	x 3	x 10	S 100	76,00 A4
A 3	x 3	x 12	S 100	77,00 A4
A 3	x 3	x 16	S 100	77,00 A4
A 3	x 3	x 20	S 100	81,00 A4
A 4	x 4	x 10	S 100	86,00 A4
A 4	x 4	x 12	S 100	90,00 A4
A 4	x 4	x 14	S 100	91,00 A4
A 4	x 4	x 16	S 100	91,00 A4
A 4	x 4	x 18	S 100	98,00 A4
A 4	x 4	x 20	S 100	98,00 A4
A 4	x 4	x 22	S 100	105,00 A4
A 5	x 5	x 10	S 100	76,00 A4
A 5	x 5	x 12	S 100	76,00 A4
A 5	x 5	x 14	S 50	77,00 A4
A 5	x 5	x 16	S 50	79,00 A4
A 5	x 5	x 18	S 50	82,00 A4
A 5	x 5	x 20	S 50	84,00 A4
A 5	x 5	x 22	S 50	88,00 A4
A 5	x 5	x 25	S 50	92,00 A4
A 5	x 5	x 28	S 50	102,00 A4
A 5	x 5	x 30	S 50	102,00 A4
A 5	x 5	x 32	S 50	139,00 A4
A 5	x 5	x 36	S 50	148,00 A4
A 5	x 5	x 40	S 50	156,00 A4
A 5	x 5	x 45	S 50	166,00 A4
A 5	x 5	x 50	S 50	175,00 A4
A 6	x 6	x 12	S 25	97,00 A4
A 6	x 6	x 14	S 50	97,00 A4
A 6	x 6	x 16	S 25	97,00 A4
A 6	x 6	x 18	S 25	101,00 A4
A 6	x 6	x 20	S 25	104,00 A4
A 6	x 6	x 22	S 25	110,00 A4
A 6	x 6	x 25	S 25	116,00 A4
A 6	x 6	x 28	S 25	122,00 A4
A 6	x 6	x 30	S 25	131,00 A4
A 6	x 6	x 32	S 25	131,00 A4
A 6	x 6	x 36	S 25	139,00 A4
A 6	x 6	x 40	S 25	147,00 A4
A 6	x 6	x 50	S 25	172,00 A4
A 6	x 6	x 56	S 25	179,00 A4
A 6	x 6	x 60	S 25	200,00 A4
A 6	x 6	x 63	S 25	227,00 A4
A 6	x 6	x 70	S 25	231,00 A4
A 6	x 6	x 80	S 25	265,00 A4
A 8	x 7	x 16	S 10	152,00 A4
A 8	x 7	x 18	S 10	152,00 A4
A 8	x 7	x 20	S 10	152,00 A4
A 8	x 7	x 22	S 10	166,00 A4
A 8	x 7	x 25	S 10	166,00 A4
A 8	x 7	x 28	S 10	177,00 A4
A 8	x 7	x 30	S 10	189,00 A4
A 8	x 7	x 32	S 10	189,00 A4
A 8	x 7	x 36	S 10	202,00 A4

A 8	x 7	x 40	S 10	217,00 A4
A 8	x 5	x 40	S 10	217,00 A4
A 8	x 7	x 45	S 10	320,00 A4
A 8	x 5	x 45	S 10	320,00 A4
A 8	x 7	x 50	S 10	340,00 A4
A 8	x 7	x 56	S 10	380,00 A4
A 8	x 7	x 60	S 10	400,00 A4
A 8	x 7	x 63	S 10	420,00 A4
A 8	x 7	x 70	S 10	435,00 A4
A 8	x 7	x 80	S 10	475,00 A4
A 8	x 7	x 90	S 10	510,00 A4
A 8	x 7	x 100	S 10	600,00 A4
A 10	x 8	x 20	S 10	214,00 A4
A 10	x 8	x 22	S 10	219,00 A4
A 10	x 8	x 25	S 10	219,00 A4
A 10	x 8	x 28	S 10	233,00 A4
A 10	x 8	x 30	S 10	255,00 A4
A 10	x 8	x 32	S 10	255,00 A4
A 10	x 8	x 36	S 10	275,00 A4
A 10	x 8	x 40	S 10	295,00 A4
A 10	x 8	x 45	S 10	320,00 A4
A 10	x 8	x 50	S 10	340,00 A4
A 10	x 8	x 56	S 10	370,00 A4
A 10	x 8	x 60	S 10	405,00 A4
A 10	x 8	x 63	S 10	560,00 A4
A 10	x 8	x 70	S 10	610,00 A4
A 10	x 8	x 80	S 10	690,00 A4
A 10	x 8	x 90	S 10	780,00 A4
A 10	x 8	x 100	S 10	830,00 A4
A 10	x 8	x 110	S 10	910,00 A4
A 10	x 8	x 120	S 10	970,00 A4
A 12	x 8	x 28	S 10	295,00 A4
A 12	x 8	x 30	S 10	295,00 A4
A 12	x 8	x 32	S 10	295,00 A4
A 12	x 8	x 36	S 10	315,00 A4
A 12	x 8	x 40	S 10	340,00 A4
A 12	x 8	x 45	S 10	370,00 A4
A 12	x 8	x 50	S 10	400,00 A4
A 12	x 8	x 56	S 10	435,00 A4
A 12	x 8	x 60	S 10	480,00 A4
A 12	x 8	x 63	S 10	480,00 A4
A 12	x 8	x 70	S 10	530,00 A4
A 12	x 8	x 80	S 10	600,00 A4
A 12	x 8	x 90	S 10	660,00 A4
A 12	x 8	x 100	S 10	740,00 A4
A 14	x 9	x 32	S 10	495,00 A4
A 14	x 9	x 40	S 10	520,00 A4
A 14	x 9	x 45	S 10	550,00 A4
A 14	x 9	x 50	S 10	550,00 A4
A 14	x 9	x 56	S 5	570,00 A4
A 14	x 9	x 60	S 5	620,00 A4
A 14	x 9	x 63	S 5	660,00 A4
A 14	x 9	x 70	S 5	690,00 A4
A 14	x 9	x 80	S 5	780,00 A4
A 14	x 9	x 100	S 5	960,00 A4
A 14	x 9	x 125	S 5	1180,00 A4
A 16	x 10	x 30	S 5	1340,00 A4
A 16	x 10	x 40	S 5	1340,00 A4
A 16	x 10	x 50	S 5	1340,00 A4
A 16	x 10	x 63	S 5	1610,00 A4
A 16	x 10	x 70	S 5	1690,00 A4
A 16	x 10	x 80	S 5	1900,00 A4
A 16	x 10	x 90	S 5	2060,00 A4
A 16	x 10	x 100	S 5	2060,00 A4

Abmessungen	VE Stück	€/100/Obf.
DIN 06912.920		
6912	A 2	

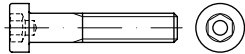

Zylinderschrauben mit Innensechskant, niedriger Kopf, mit Schlüsselführung

Länge ≤ 100 mm bei einigen Fabrikaten
Gewinde bis Kopf

Maße → **TI-12** Anziehmomente → **TI-246 - 249**
Werkstoffeigensch. → **TI-236**
Stahl → **S. 317**

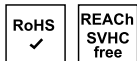

M 4	x	6	S	200	92,00A2
M 4	x	8	S	200	78,00A2
M 4	x	10	S	200	65,00A2
M 4	x	12	S	200	77,00A2
M 4	x	16	S	200	55,00A2
M 4	x	20	S	200	58,00A2
M 4	x	25	S	200	60,00A2
M 4	x	30	S	200	70,00A2
M 4	x	35	S	200	74,00A2
M 4	x	40	S	200	79,00A2
M 5	x	6	S	100	108,00A2
M 5	x	8	S	100	93,00A2
M 5	x	10	S	100	89,00A2
M 5	x	12	S	100	77,00A2
M 5	x	14	S	100	77,00A2
M 5	x	16	S	100	60,00A2
M 5	x	20	S	100	64,00A2
M 5	x	25	S	100	68,00A2
M 5	x	30	S	100	80,00A2
M 5	x	35	S	100	92,00A2
M 5	x	40	S	100	96,00A2
M 5	x	45	S	100	106,00A2
M 5	x	50	S	100	117,00A2
M 6	x	8	S	100	99,00A2
M 6	x	10	S	100	86,00A2
M 6	x	12	S	100	95,00A2
M 6	x	14	S	100	95,00A2
M 6	x	16	S	100	76,00A2
M 6	x	20	S	100	82,00A2
M 6	x	25	S	100	86,00A2
M 6	x	30	S	100	93,00A2
M 6	x	35	S	100	106,00A2
M 6	x	40	S	100	99,00A2
M 6	x	45	S	100	106,00A2
M 6	x	50	S	100	106,00A2
M 6	x	55	S	100	131,00A2
M 6	x	60	S	100	145,00A2
M 6	x	70	S	100	194,00A2
M 6	x	80	S	100	260,00A2
M 8	x	10	S	100	157,00A2
M 8	x	12	S	100	170,00A2
M 8	x	14	S	100	161,00A2
M 8	x	16	S	100	152,00A2
M 8	x	20	S	100	131,00A2
M 8	x	25	S	100	124,00A2
M 8	x	30	S	100	131,00A2
M 8	x	35	S	100	148,00A2
M 8	x	40	S	100	161,00A2
M 8	x	45	S	100	194,00A2
M 8	x	50	S	100	212,00A2
M 8	x	55	S	100	235,00A2

Abmessungen	VE Stück	€/100/Obf.			
M 8	x	60	S	100	255,00A2
M 8	x	65	S	100	325,00A2
M 8	x	70	S	50	325,00A2
M 8	x	80	S	50	390,00A2
M 8	x	90	S	50	430,00A2
M 8	x	100	S	50	490,00A2
M 10	x	16	S	100	295,00A2
M 10	x	20	S	100	270,00A2
M 10	x	25	S	100	255,00A2
M 10	x	30	S	100	275,00A2
M 10	x	35	S	100	290,00A2
M 10	x	40	S	100	310,00A2
M 10	x	45	S	100	340,00A2
M 10	x	50	S	100	385,00A2
M 10	x	55	S	50	425,00A2
M 10	x	60	S	50	440,00A2
M 10	x	70	S	50	510,00A2
M 10	x	80	S	50	570,00A2
M 10	x	90	S	50	710,00A2
M 10	x	100	S	50	830,00A2
M 12	x	20	S	50	415,00A2
M 12	x	25	S	50	385,00A2
M 12	x	30	S	50	390,00A2
M 12	x	35	S	50	415,00A2
M 12	x	40	S	50	455,00A2
M 12	x	45	S	50	495,00A2
M 12	x	50	S	50	550,00A2
M 12	x	55	S	50	590,00A2
M 12	x	60	S	50	610,00A2
M 12	x	70	S	50	700,00A2
M 12	x	80	S	25	790,00A2
M 12	x	90	S	25	980,00A2
M 12	x	100	S	25	1130,00A2
M 16	x	25	S	1	1580,00A2
M 16	x	30	S	1	1230,00A2
M 16	x	35	S	1	1250,00A2
M 16	x	40	S	1	1290,00A2
M 16	x	45	S	1	1350,00A2
M 16	x	50	S	1	1400,00A2
M 16	x	55	S	1	1520,00A2
M 16	x	60	S	1	1560,00A2
M 16	x	70	S	1	1690,00A2
M 16	x	80	S	1	1830,00A2
M 16	x	90	S	1	2040,00A2
M 16	x	100	S	1	2330,00A2
M 20	x	35	S	1	2430,00A2
M 20	x	40	S	1	2600,00A2
M 20	x	45	S	1	2650,00A2
M 20	x	50	S	1	2700,00A2
M 20	x	60	S	1	3000,00A2
M 20	x	70	S	1	3200,00A2
M 20	x	80	S	1	4000,00A2
M 20	x	90	S	1	4550,00A2
M 20	x	100	S	1	5400,00A2

Abmessungen	VE Stück	€/100/Obf.
DIN 06912.940		
6912	A 4	

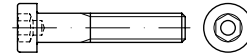

Zylinderschrauben mit Innensechskant, niedriger Kopf, mit Schlüsselführung

Länge ≤ 100 mm bei einigen Fabrikaten
Gewinde bis Kopf

Maße → **TI-12** Anziehmomente → **TI-246 - 249**
Werkstoffeigensch. → **TI-236**
Stahl → **S. 317**

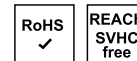

M 4	x	6	S	100	123,00A4
M 4	x	8	S	100	103,00A4
M 4	x	10	S	200	91,00A4
M 4	x	12	S	200	86,00A4
M 4	x	16	S	200	62,00A4
M 4	x	20	S	200	66,00A4
M 4	x	25	S	200	70,00A4
M 4	x	30	S	200	79,00A4
M 4	x	35	S	200	93,00A4
M 4	x	40	S	200	100,00A4
M 5	x	6	S	100	130,00A4
M 5	x	8	S	100	111,00A4
M 5	x	10	S	100	133,00A4
M 5	x	12	S	100	116,00A4
M 5	x	16	S	100	84,00A4
M 5	x	18	S	100	89,00A4
M 5	x	20	S	100	91,00A4
M 5	x	25	S	100	95,00A4
M 5	x	30	S	100	111,00A4
M 5	x	35	S	100	124,00A4
M 5	x	40	S	100	136,00A4
M 5	x	50	S	100	202,00A4
M 6	x	8	S	100	153,00A4
M 6	x	10	S	100	138,00A4
M 6	x	12	S	100	135,00A4
M 6	x	16	S	100	107,00A4
M 6	x	20	S	100	112,00A4
M 6	x	25	S	100	127,00A4
M 6	x	30	S	100	133,00A4
M 6	x	35	S	100	142,00A4
M 6	x	40	S	100	161,00A4
M 6	x	45	S	100	194,00A4
M 6	x	50	S	100	223,00A4
M 6	x	55	S	100	280,00A4
M 6	x	60	S	100	305,00A4
M 6	x	70	S	100	355,00A4
M 6	x	80	S	100	420,00A4
M 8	x	10	S	100	194,00A4
M 8	x	12	S	100	194,00A4
M 8	x	16	S	100	200,00A4
M 8	x	20	S	100	165,00A4
M 8	x	25	S	100	172,00A4
M 8	x	30	S	100	181,00A4
M 8	x	35	S	100	200,00A4
M 8	x	40	S	100	255,00A4
M 8	x	45	S	100	280,00A4
M 8	x	50	S	100	320,00A4
M 8	x	55	S	100	345,00A4
M 8	x	60	S	100	365,00A4
M 8	x	70	S	50	620,00A4
M 8	x	80	S	50	770,00A4

Abmessungen	VE	Stück	€/100/Obf.
M 8 x 90	S	50	1060,00 A4
M 10 x 16	S	100	395,00 A4
M 10 x 20	S	100	385,00 A4
M 10 x 25	S	100	365,00 A4
M 10 x 30	S	100	365,00 A4
M 10 x 35	S	100	390,00 A4
M 10 x 40	S	100	425,00 A4
M 10 x 45	S	100	475,00 A4
M 10 x 50	S	100	520,00 A4
M 10 x 55	S	50	600,00 A4
M 10 x 60	S	50	630,00 A4
M 10 x 70	S	50	710,00 A4
M 10 x 80	S	50	850,00 A4
M 10 x 90	S	50	1070,00 A4
M 10 x 100	S	50	1280,00 A4
M 12 x 16	S	50	650,00 A4
M 12 x 20	S	50	670,00 A4
M 12 x 25	S	50	640,00 A4
M 12 x 30	S	50	590,00 A4
M 12 x 35	S	50	620,00 A4
M 12 x 40	S	50	660,00 A4
M 12 x 45	S	50	730,00 A4
M 12 x 50	S	50	780,00 A4
M 12 x 55	S	50	890,00 A4
M 12 x 60	S	50	920,00 A4
M 12 x 70	S	25	1000,00 A4
M 12 x 80	S	25	1230,00 A4
M 12 x 90	S	1	1390,00 A4
M 12 x 100	S	1	1390,00 A4
M 16 x 25	S	1	2030,00 A4
M 16 x 30	S	1	1590,00 A4
M 16 x 35	S	1	1640,00 A4
M 16 x 40	S	1	1680,00 A4
M 16 x 45	S	1	1760,00 A4
M 16 x 50	S	1	1830,00 A4
M 16 x 55	S	1	2020,00 A4
M 16 x 60	S	1	2060,00 A4
M 16 x 65	S	1	2150,00 A4
M 16 x 70	S	1	2210,00 A4
M 16 x 80	S	1	2900,00 A4
M 16 x 90	S	1	3450,00 A4
M 16 x 100	S	1	3450,00 A4
M 16 x 110	S	1	6000,00 A4
M 16 x 120	S	1	6100,00 A4
M 16 x 130	S	1	6200,00 A4
M 16 x 140	S	1	6400,00 A4
M 20 x 30	S	1	3600,00 A4
M 20 x 35	S	1	3650,00 A4
M 20 x 40	S	1	3550,00 A4
M 20 x 45	S	1	3650,00 A4
M 20 x 50	S	1	3900,00 A4
M 20 x 60	S	1	4300,00 A4
M 20 x 70	S	1	4750,00 A4
M 20 x 80	S	1	6000,00 A4
M 20 x 90	S	1	8200,00 A4
M 20 x 100	S	1	8400,00 A4
M 20 x 110	S	1	10900,00 A4
M 20 x 120	S	1	11000,00 A4
M 20 x 130	S	1	11100,00 A4
M 20 x 150	S	1	11400,00 A4
M 24 x 50	S	1	6100,00 A4
M 24 x 55	S	1	6100,00 A4
M 24 x 60	S	1	6100,00 A4
M 24 x 70	S	1	6400,00 A4
M 24 x 80	S	1	7600,00 A4
M 24 x 90	S	1	9800,00 A4
M 24 x 100	S	1	10000,00 A4
M 24 x 110	S	1	12500,00 A4
M 24 x 120	S	1	12600,00 A4
M 24 x 130	S	1	12700,00 A4
M 24 x 150	S	1	13000,00 A4

Abmessungen	VE	Stück	€/100/Obf.
DIN 6921 A 2			

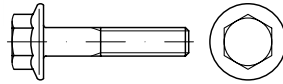

Sechskantschrauben mit Flansch

Maße → TI-17 Anziehmomente → TI-249
 Werkstoffeigensch. → TI-236 Normumstellung → TI-6

Stahl → S. 320

DIN 6921 → wird ersetzt durch EN 1665

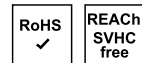

M 5 x 10	S	200	33,50
M 5 x 12	S	200	34,50
M 5 x 16	S	200	36,00
M 5 x 20	S	200	37,00
M 5 x 25	S	200	39,50
M 5 x 30	S	200	42,50
M 6 x 10	S	200	42,50
M 6 x 12	S	200	44,00
M 6 x 16	S	200	46,50
M 6 x 20	S	200	48,50
M 6 x 25	S	200	53,00
M 6 x 30	S	200	55,00
M 6 x 35	S	200	60,00
M 6 x 40	S	200	63,00
M 6 x 45	S	200	66,00
M 8 x 16	S	200	83,00
M 8 x 20	S	200	86,00
M 8 x 25	S	200	91,00
M 8 x 30	S	200	99,00
M 8 x 35	S	200	105,00
M 8 x 40	S	200	110,00
M 8 x 45	S	200	116,00
M 8 x 50	S	200	124,00
M 10 x 20	S	100	124,00
M 10 x 25	S	100	133,00
M 10 x 30	S	100	141,00
M 10 x 35	S	100	150,00
M 10 x 40	S	100	161,00
M 10 x 45	S	100	171,00
M 10 x 50	S	100	180,00
M 10 x 60	S	100	199,00

Abmessungen	VE	Stück	€/100/Obf.
~DIN 6921 A 2 Sperrzahn			

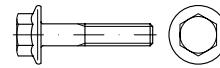

Sechskantschrauben mit Flansch und Sperrverzahnung

Maße → TI-17 Anziehmomente → TI-249
 Werkstoffeigensch. → TI-236

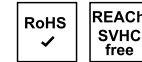

M 5 x 10	S	200	37,00
M 5 x 12	S	200	37,50
M 5 x 16	S	200	39,50
M 5 x 20	S	200	41,00
M 5 x 25	S	200	43,50
M 5 x 30	S	200	47,00
M 6 x 10	S	200	47,00
M 6 x 12	S	200	48,50
M 6 x 16	S	200	52,00
M 6 x 20	S	200	54,00
M 6 x 25	S	200	59,00
M 6 x 30	S	200	61,00
M 6 x 35	S	200	67,00
M 6 x 40	S	200	70,00
M 6 x 45	S	200	72,00
M 8 x 16	S	200	91,00
M 8 x 20	S	200	94,00
M 8 x 25	S	200	101,00
M 8 x 30	S	200	110,00
M 8 x 35	S	200	116,00
M 8 x 40	S	200	122,00
M 8 x 45	S	200	129,00
M 8 x 50	S	200	137,00
M 10 x 20	S	100	137,00
M 10 x 25	S	100	148,00
M 10 x 30	S	100	156,00
M 10 x 35	S	100	165,00
M 10 x 40	S	100	178,00
M 10 x 45	S	100	190,00
M 10 x 50	S	100	199,00
M 10 x 60	S	100	209,00

Abmessungen	VE Stück	€/100/Obf.
DIN	06921.940	
6921	A 4	

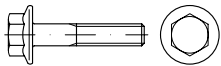

Sechskantschrauben mit Flansch

Maße → **TI-17** Anziehmomente → **TI-249**
 Werkstoffeigensch. → **TI-236** Normumstellung → **TI-6**
 Stahl → **S. 320**
 DIN 6921 → wird ersetzt durch EN 1665



M 5	x	10	S 200	48,50
M 5	x	12	S 200	49,50
M 5	x	16	S 200	52,00
M 5	x	20	S 200	54,00
M 5	x	25	S 200	57,00
M 5	x	30	S 200	61,00
M 6	x	10	S 200	61,00
M 6	x	12	S 200	64,00
M 6	x	16	S 200	68,00
M 6	x	20	S 200	71,00
M 6	x	25	S 200	77,00
M 6	x	30	S 200	80,00
M 6	x	35	S 200	86,00
M 6	x	40	S 200	91,00
M 6	x	45	S 200	95,00
M 8	x	16	S 200	120,00
M 8	x	20	S 200	124,00
M 8	x	25	S 200	133,00
M 8	x	30	S 200	143,00
M 8	x	35	S 200	152,00
M 8	x	40	S 200	160,00
M 8	x	45	S 200	168,00
M 8	x	50	S 200	179,00
M 10	x	20	S 100	179,00
M 10	x	25	S 100	193,00
M 10	x	30	S 100	204,00
M 10	x	35	S 100	217,00
M 10	x	40	S 100	233,00
M 10	x	45	S 100	248,00
M 10	x	50	S 100	265,00
M 10	x	60	S 100	275,00

Abmessungen	VE Stück	€/100/Obf.
~DIN	06921.944	
6921	A 4	Sperrzahn

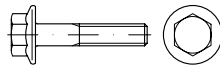

Sechskantschrauben mit Flansch und Sperrverzahnung

Maße → **TI-17** Anziehmomente → **TI-249**
 Werkstoffeigensch. → **TI-236**

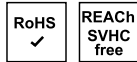

M 5	x	10	S 200	54,00
M 5	x	12	S 200	55,00
M 5	x	16	S 200	57,00
M 5	x	20	S 200	59,00
M 5	x	25	S 200	63,00
M 5	x	30	S 200	68,00
M 6	x	10	S 200	68,00
M 6	x	12	S 200	71,00
M 6	x	16	S 200	74,00
M 6	x	20	S 200	77,00
M 6	x	25	S 200	85,00
M 6	x	30	S 200	88,00
M 6	x	35	S 200	96,00
M 6	x	40	S 200	100,00
M 6	x	45	S 200	104,00
M 8	x	16	S 200	133,00
M 8	x	20	S 200	137,00
M 8	x	25	S 200	145,00
M 8	x	30	S 200	158,00
M 8	x	35	S 200	166,00
M 8	x	40	S 200	175,00
M 8	x	45	S 200	185,00
M 8	x	50	S 200	196,00
M 10	x	20	S 100	196,00
M 10	x	25	S 100	210,00
M 10	x	30	S 100	223,00
M 10	x	35	S 100	238,00
M 10	x	40	S 100	260,00
M 10	x	45	S 100	275,00
M 10	x	50	S 100	290,00
M 10	x	60	S 100	305,00

Abmessungen	VE Stück	€/100/Obf.
DIN	06923.920	
6923	A 2	

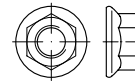

Sechskantmuttern mit Flansch

Maße → **TI-64** Anziehmomente → **TI-249**
 Werkstoffeigensch. → **TI-236** Normumstellung → **TI-7**
 Stahl → **S. 322**
 DIN 6923 → wird ersetzt durch EN 1661

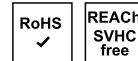

M 4	S 1000	16,10 A2
M 5	S 1000	24,30 A2
M 6	S 1000	39,00 A2
M 8	S 1000	49,50 A2
M 10	S 500	73,00 A2
M 12	S 250	152,00 A2

Abmessungen	VE Stück	€/100/Obf.
DIN	06923.940	
6923	A 4	

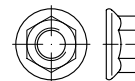

Sechskantmuttern mit Flansch

Maße → **TI-64** Anziehmomente → **TI-249**
 Werkstoffeigensch. → **TI-236** Normumstellung → **TI-7**
 Stahl → **S. 322**
 DIN 6923 → wird ersetzt durch EN 1661

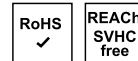

M 5	S 1000	55,00 A4
M 6	S 1000	71,00 A4
M 8	S 1000	81,00 A4
M 10	S 500	189,00 A4



- ✓ Große Artikelvielfalt
- ✓ Verlässliche Qualität
- ✓ Hohe Lieferbereitschaft



Wir versorgen Sie mit
 Verbindungselementen
 und Befestigungstechnik!

Abmessungen VE Stück €/100/Obf.

~DIN	06923.924
6923	A 2 Sperrzahn

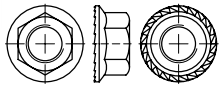

Sechskantmuttern mit Flansch und Sperrverzahnung

Achtung! Nur für den Einsatz auf weichen Gegenmaterial geeignet.

Maße → [TI-64](#) Anziehmomente → [TI-249](#)
 Werkstoffeigensch. → [TI-236](#)
 Stahl → [S. 322](#)

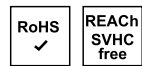

M 4	S 500	17,10 A2
M 5	S 500	26,00 A2
M 6	S 1000	41,00 A2
M 8	S 1000	52,00 A2
M 10	S 500	76,00 A2
M 12	S 200	159,00 A2

~DIN	06923.944
6923	A 4 Sperrzahn

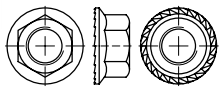

Sechskantmuttern mit Flansch und Sperrverzahnung

Achtung! Nur für den Einsatz auf weichen Gegenmaterial geeignet.

Maße → [TI-64](#) Anziehmomente → [TI-249](#)
 Werkstoffeigensch. → [TI-236](#)
 Stahl → [S. 322](#)

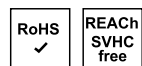

M 4	S 500	31,50 A4
M 5	S 500	57,00 A4
M 6	S 500	74,00 A4
M 8	S 500	84,00 A4
M 10	S 200	200,00 A4
M 12	S 100	255,00 A4

Abmessungen VE Stück €/100/Obf.

~DIN	06924.920
6924	A 2

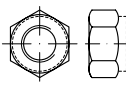

Sechskantmuttern mit Klemmteil, mit nichtmetallischem Einsatz, hohe Form

für Temperatur-Einsatz von -50 bis +120 °C

Achtung! Risiko der Kaltverschweißung. Bitte technischen Hinweis im Infoeinblender beachten!

Maße → [TI-9](#) Normumstellung → [TI-7](#)
 Werkstoffeigensch. → [TI-236](#) Schraubensicherung → [TI-256](#)
 Stahl → [S. 323](#)

DIN 6924 Regelgew. → wird ersetzt durch ISO 7040 (austauschbar)



M 5	S 1000	76,00 A2
M 6	S 1000	88,00 A2
M 8	S 500	112,00 A2
M 16	S 100	415,00 A2
M 20	S 25	790,00 A2

Abmessungen VE Stück €/100/Obf.

~DIN	06924.940
6924	A 4

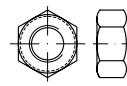

Sechskantmuttern mit Klemmteil, mit nichtmetallischem Einsatz, hohe Form

für Temperatur-Einsatz von -50 bis +120 °C

Achtung! Risiko der Kaltverschweißung. Bitte technischen Hinweis im Infoeinblender beachten!

Maße → [TI-9](#) Normumstellung → [TI-7](#)
 Werkstoffeigensch. → [TI-236](#) Schraubensicherung → [TI-256](#)
 Stahl → [S. 323](#)

DIN 6924 Regelgew. → wird ersetzt durch ISO 7040 (austauschbar)



M 5	S 100	116,00 A4
M 6	S 100	133,00 A4
M 8	S 100	175,00 A4
M 16	S 25	770,00 A4
M 20	S 25	3150,00 A4
M 24	S 25	3600,00 A4



- ✓ Große Artikelvielfalt
- ✓ Verlässliche Qualität
- ✓ Hohe Lieferbereitschaft



Wir versorgen Sie mit Verbindungselementen und Befestigungstechnik!

Abmessungen	VE Stück	€/100/Obf.
~ISO	07040.920	
7040	A 2	

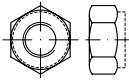

Sechskantmuttern mit Klemmteil, mit nichtmetallischem Einsatz, hohe Form

für Temperatur-Einsatz von -50 bis +120 °C, *M 10/12 RAZ = 3395, übrige Ø RAZ = 480

Achtung! Risiko der Kaltverschweißung. Bitte technischen Hinweis im Infoeinblender beachten!

Maße → **TI-9** Normumstellung → **TI-7**
 Werkstoffeigensch. → **TI-236** Schraubensicherung → **TI-256**

Stahl → **S. 324**

ISO 7040 → ersetzt DIN 982 und 6924



M 5	S 1000	76,00 A2
M 6	S 1000	88,00 A2
M 8	S 500	112,00 A2
M 10	S 500	194,00 A2
M 12	S 250	241,00 A2
M 16	S 100	415,00 A2
M 20	S 25	790,00 A2

Abmessungen	VE Stück	€/100/Obf.
~ISO	07040.924	
7040	A 2 - 70	WS

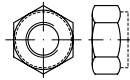

Sechskantmuttern mit Klemmteil, mit nichtmet. Einsatz, hohe Form, mit wärmostabilisiertem Polyamid-Klemmring

für Temperatur-Einsatz bis ~ +150/180 °C (BN 205 107-03)

Achtung! Risiko der Kaltverschweißung. Bitte technischen Hinweis im Infoeinblender beachten!

Maße → **TI-9** Normumstellung → **TI-7**
 Werkstoffeigensch. → **TI-236** Schraubensicherung → **TI-256**

Stahl → **S. 325**

ISO 7040 → ersetzt DIN 982 und 6924



M 3	S 1000	880,00 A2
M 4	S 100	161,00 A2
M 5	S 500	165,00 A2
M 5	K 100	169,00 A2
M 6	S 500	248,00 A2
M 6	K 100	255,00 A2
M 8	S 500	345,00 A2
M 8	K 100	350,00 A2
M 10	S 500	610,00 A2
M 10	K 100	620,00 A2
M 12	S 100	770,00 A2
M 16	S 25	1540,00 A2

Abmessungen	VE Stück	€/100/Obf.
~ISO	07040.940	
7040	A 4	

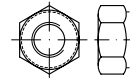

Sechskantmuttern mit Klemmteil, mit nichtmetallischem Einsatz, hohe Form

für Temperatur-Einsatz von -50 bis +120 °C, *M 10/12 RAZ = 3395, übrige Ø RAZ = 480

Achtung! Risiko der Kaltverschweißung. Bitte technischen Hinweis im Infoeinblender beachten!

Maße → **TI-9** Normumstellung → **TI-7**
 Werkstoffeigensch. → **TI-236** Schraubensicherung → **TI-256**

Stahl → **S. 324**

ISO 7040 → ersetzt DIN 982 und 6924



M 5	S 100	116,00 A4
M 6	S 100	133,00 A4
M 8	S 100	175,00 A4
M 10	S 100	350,00 A4
M 12	S 50	445,00 A4
M 16	S 25	770,00 A4
M 20	S 25	3150,00 A4
M 24	S 25	3600,00 A4

Wichtiger Hinweis!



Die gültigen Normen für Sechskantmuttern mit Klemmteil gelten für die Ausführung Stahl in den Festigkeitsklassen 5, (6), 8, 10 bzw. 12. Die Verwendung von Muttern mit Klemmteil aus anderen Werkstoffen (z.B. nichtrostenden Stählen, Messing, Aluminium) erfolgt auf eigenes Risiko. Muttern mit Klemmteil aus diesen weicheren Werkstoffen neigen manchmal wegen des hohen Gewindeflankendrucks beim Einformen des Bolzen- gewindes in den Sicherungsring zum Festfressen. Hier hilft in der Regel die Verwendung eines Schmiermittels. Die veränderten Reibwerte sind beim Anziehen der Verbindung entsprechend zu berücksichtigen.

Abmessungen	VE Stück	€/100/Obf.
~ISO	07042.920	
7042	A 2	

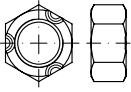

Sechskantmuttern mit Klemmteil, (Ganzmetallmuttern)

*M 10/12/14 RAZ = 3395, übrige Ø RAZ = 480

Achtung! Risiko der Kaltverschweißung. Bitte technischen Hinweis im Infoeinblender beachten!

Maße → **TI-9** Normumstellung → **TI-7**
 Werkstoffeigensch. → **TI-236** Schraubensicherung → **TI-256**

ISO 7042 → ersetzt DIN 980 und 6925



M 3	S 1000	23,30A2
M 4	S 1000	47,00A2
M 5	S 1000	53,00A2
M 8	S 500	82,00A2
M 10	S 500	112,00A2
M 12	S 250	135,00A2
M 16	S 100	310,00A2
M 18	S 50	340,00A2
M 20	S 25	355,00A2
M 24	S 25	410,00A2

Abmessungen	VE Stück	€/100/Obf.
~ISO	07042.940	
7042	A 4	

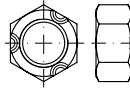

Sechskantmuttern mit Klemmteil, (Ganzmetallmuttern)

*M 10/12/14 RAZ = 3395, übrige Ø RAZ = 480

Achtung! Risiko der Kaltverschweißung. Bitte technischen Hinweis im Infoeinblender beachten!

Maße → **TI-9** Normumstellung → **TI-7**
 Werkstoffeigensch. → **TI-236** Schraubensicherung → **TI-256**

ISO 7042 → ersetzt DIN 980 und 6925



M 3	S 1000	168,00A4
M 4	S 100	208,00A4
M 5	S 1000	229,00A4
M 6	S 1000	235,00A4
M 8	S 500	248,00A4
M 10	S 500	370,00A4
M 12	S 250	570,00A4
M 14	S 100	690,00A4
M 16	S 100	930,00A4
M 18	S 50	980,00A4
M 20	S 25	1240,00A4
M 24	S 25	2330,00A4
M 30	S 10	3400,00A4

Wichtiger Hinweis!

Die gültigen Normen für Sechskantmuttern mit Klemmteil gelten für die Ausführung Stahl in den Festigkeitsklassen 5, (6), 8, 10 bzw. 12. Die Verwendung von Muttern mit Klemmteil aus anderen Werkstoffen (z.B. nichtrostenden Stählen, Messing, Aluminium) erfolgt auf eigenes Risiko. Muttern mit Klemmteil aus diesen weicheren Werkstoffen neigen manchmal wegen des hohen Gewindeflankendrucks beim Einformen des Bolzen- gewindes in den Sicherungsring zum Festfressen. Hier hilft in der Regel die Verwendung eines Schmiermittels. Die veränderten Reibwerte sind beim Anziehen der Verbindung entsprechend zu berücksichtigen.



Abmessungen	VE Stück	€/100/Obf.
ISO	07045.925	
7045	A 2	H



Linsenschrauben mit Phillips-Kreuzschlitz H

Maße → **TI-40** Normumstellung → **TI-11**
 Werkstoffeigensch. → **TI-236**

Stahl → **S. 326**

ISO 7045 → ersetzt DIN 7985 (austauschbar)

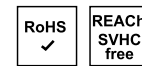

M 1,6	x 2 -H	S 1000	38,00A2
M 1,6	x 3 -H	S 1000	34,00A2
M 1,6	x 4 -H	S 1000	31,50A2
M 1,6	x 5 -H	S 1000	31,50A2
M 1,6	x 6 -H	S 1000	31,50A2
M 1,6	x 8 -H	S 1000	32,50A2
M 1,6	x 10 -H	S 1000	35,00A2
M 1,6	x 12 -H	S 1000	40,00A2
M 1,6	x 16 -H	S 1000	47,50A2
M 2	x 2 -H	S 1000	34,50A2
M 2	x 3 -H	S 1000	19,70A2
M 2	x 4 -H	S 1000	13,40A2
M 2	x 4 -H	K 200	15,30A2
M 2	x 5 -H	S 1000	11,00A2
M 2	x 5 -H	K 200	12,90A2
M 2	x 6 -H	S 1000	11,00A2
M 2	x 6 -H	K 200	12,90A2
M 2	x 8 -H	S 1000	11,00A2
M 2	x 8 -H	K 200	12,90A2
M 2	x 10 -H	S 1000	11,00A2
M 2	x 10 -H	K 200	12,90A2
M 2	x 12 -H	S 1000	12,00A2
M 2	x 12 -H	K 200	13,90A2
M 2	x 14 -H	S 1000	16,80A2
M 2	x 16 -H	S 1000	12,70A2
M 2	x 16 -H	K 200	14,60A2
M 2	x 18 -H	S 1000	17,90A2
M 2	x 20 -H	S 1000	14,70A2
M 2	x 20 -H	K 200	16,60A2
M 2,5	x 3 -H	S 1000	20,90A2
M 2,5	x 4 -H	S 1000	13,40A2
M 2,5	x 4 -H	K 200	15,30A2
M 2,5	x 5 -H	S 1000	13,70A2
M 2,5	x 5 -H	K 200	15,60A2
M 2,5	x 6 -H	S 1000	11,00A2
M 2,5	x 6 -H	K 200	12,90A2
M 2,5	x 8 -H	S 1000	11,00A2
M 2,5	x 8 -H	K 200	12,90A2
M 2,5	x 10 -H	S 1000	11,00A2
M 2,5	x 10 -H	K 200	12,90A2
M 2,5	x 12 -H	S 1000	12,00A2
M 2,5	x 12 -H	K 200	13,90A2
M 2,5	x 14 -H	S 1000	16,80A2
M 2,5	x 16 -H	S 1000	12,70A2
M 2,5	x 18 -H	S 1000	17,90A2
M 2,5	x 20 -H	S 1000	14,70A2
M 2,5	x 25 -H	S 1000	23,30A2
M 2,5	x 30 -H	S 1000	34,50A2
M 3	x 4 -H	S 1000	12,50A2
M 3	x 5 -H	S 1000	10,60A2
M 3	x 6 -H	S 1000	7,10A2
M 3	x 6 -H	K 200	8,90A2

Abmessungen	VE	Stück	€/100/Obf.	Abmessungen	VE	Stück	€/100/Obf.	Abmessungen	VE	Stück	€/100/Obf.
M 3 x 8-H	S	1000	7,50A2	M 5 x 90-H	S	100	137,00A2	M 2 x 6-Z	S	1000	11,00A2
M 3 x 8-H	K	200	9,40A2	M 6 x 8-H	S	200	24,80A2	M 2 x 8-Z	S	1000	11,00A2
M 3 x 10-H	S	1000	8,00A2	M 6 x 10-H	S	200	25,00A2	M 2 x 10-Z	S	1000	11,00A2
M 3 x 10-H	K	200	9,90A2	M 6 x 12-H	S	200	26,50A2	M 2 x 12-Z	S	1000	12,00A2
M 3 x 12-H	S	1000	8,50A2	M 6 x 14-H	S	200	39,50A2	M 2 x 16-Z	S	1000	12,70A2
M 3 x 12-H	K	200	10,40A2	M 6 x 16-H	S	200	30,00A2	M 2,5 x 4-Z	S	1000	13,40A2
M 3 x 14-H	S	1000	12,10A2	M 6 x 18-H	S	200	40,00A2	M 2,5 x 6-Z	S	1000	11,00A2
M 3 x 16-H	S	1000	11,10A2	M 6 x 20-H	S	200	32,50A2	M 2,5 x 8-Z	S	1000	11,00A2
M 3 x 16-H	K	200	15,10A2	M 6 x 25-H	S	200	36,50A2	M 2,5 x 10-Z	S	1000	11,00A2
M 3 x 18-H	S	1000	14,00A2	M 6 x 30-H	S	200	42,50A2	M 2,5 x 12-Z	S	1000	12,00A2
M 3 x 20-H	S	1000	10,60A2	M 6 x 35-H	S	200	47,00A2	M 2,5 x 16-Z	S	1000	12,70A2
M 3 x 20-H	K	200	12,40A2	M 6 x 40-H	S	200	54,00A2	M 2,5 x 18-Z	S	1000	14,70A2
M 3 x 22-H	S	1000	15,00A2	M 6 x 45-H	S	200	60,00A2	M 2,5 x 20-Z	S	1000	14,70A2
M 3 x 25-H	S	1000	11,50A2	M 6 x 50-H	S	200	62,00A2	M 2,5 x 25-Z	S	1000	23,30A2
M 3 x 30-H	S	1000	16,90A2	M 6 x 55-H	S	200	69,00A2	M 2,5 x 30-Z	S	1000	30,50A2
M 3 x 35-H	S	1000	31,00A2	M 6 x 60-H	S	100	69,00A2	M 3 x 4-Z	S	1000	12,50A2
M 3 x 40-H	S	1000	35,00A2	M 6 x 70-H	S	100	115,00A2	M 3 x 5-Z	S	1000	10,60A2
M 3 x 45-H	S	500	52,00A2	M 6 x 80-H	S	100	132,00A2	M 3 x 6-Z	S	1000	7,10A2
M 3 x 50-H	S	500	52,00A2	M 6 x 90-H	S	100	162,00A2	M 3 x 8-Z	S	1000	7,50A2
M 4 x 4-H	S	1000	18,80A2	M 8 x 10-H	S	100	56,00A2	M 3 x 10-Z	S	1000	8,00A2
M 4 x 5-H	S	1000	14,30A2	M 8 x 12-H	S	100	46,50A2	M 3 x 12-Z	S	1000	8,50A2
M 4 x 6-H	S	1000	11,30A2	M 8 x 16-H	S	100	54,00A2	M 3 x 14-Z	S	1000	13,70A2
M 4 x 6-H	K	200	13,20A2	M 8 x 20-H	S	100	58,00A2	M 3 x 16-Z	S	1000	11,10A2
M 4 x 8-H	S	1000	11,30A2	M 8 x 25-H	S	100	61,00A2	M 3 x 18-Z	S	1000	10,30A2
M 4 x 8-H	K	200	13,20A2	M 8 x 30-H	S	100	65,00A2	M 3 x 20-Z	S	1000	10,60A2
M 4 x 10-H	S	1000	11,80A2	M 8 x 35-H	S	100	67,00A2	M 3 x 25-Z	S	1000	11,50A2
M 4 x 10-H	K	200	13,70A2	M 8 x 40-H	S	100	70,00A2	M 3 x 30-Z	S	1000	16,90A2
M 4 x 12-H	S	1000	12,40A2	M 8 x 45-H	S	100	83,00A2	M 3 x 35-Z	S	1000	31,00A2
M 4 x 12-H	K	200	14,30A2	M 8 x 50-H	S	100	85,00A2	M 4 x 5-Z	S	1000	14,30A2
M 4 x 14-H	S	1000	18,40A2	M 8 x 55-H	S	100	89,00A2	M 4 x 6-Z	S	1000	11,30A2
M 4 x 16-H	S	1000	15,90A2	M 8 x 60-H	S	100	89,00A2	M 4 x 8-Z	S	1000	11,30A2
M 4 x 16-H	K	200	17,90A2	M 10 x 12-H	S	100	335,00A2	M 4 x 10-Z	S	1000	11,80A2
M 4 x 18-H	S	1000	20,30A2	M 10 x 16-H	S	100	305,00A2	M 4 x 12-Z	S	1000	12,40A2
M 4 x 20-H	S	1000	15,50A2	M 10 x 20-H	S	100	325,00A2	M 4 x 14-Z	S	1000	15,90A2
M 4 x 20-H	K	200	17,40A2	M 10 x 25-H	S	100	360,00A2	M 4 x 16-Z	S	1000	15,90A2
M 4 x 22-H	S	1000	23,70A2	M 10 x 30-H	S	100	390,00A2	M 4 x 18-Z	S	1000	17,80A2
M 4 x 25-H	S	1000	18,00A2	M 10 x 35-H	S	100	430,00A2	M 4 x 20-Z	S	1000	15,50A2
M 4 x 25-H	K	200	19,90A2	M 10 x 40-H	S	100	465,00A2	M 4 x 30-Z	S	1000	21,10A2
M 4 x 30-H	S	1000	21,10A2	M 10 x 45-H	S	100	530,00A2	M 4 x 35-Z	S	500	26,50A2
M 4 x 30-H	K	200	22,90A2	M 10 x 50-H	S	100	530,00A2	M 4 x 40-Z	S	500	28,50A2
M 4 x 35-H	S	500	26,50A2	M 10 x 55-H	S	100	560,00A2	M 4 x 45-Z	S	500	33,50A2
M 4 x 40-H	S	500	28,50A2	M 10 x 60-H	S	100	590,00A2	M 4 x 50-Z	S	200	65,00A2
M 4 x 45-H	S	500	33,50A2					M 4 x 60-Z	S	200	77,00A2
M 4 x 50-H	S	200	65,00A2					M 4 x 70-Z	S	200	110,00A2
M 4 x 55-H	S	200	76,00A2					M 5 x 6-Z	S	500	28,50A2
M 4 x 60-H	S	200	77,00A2					M 5 x 8-Z	S	500	20,10A2
M 4 x 70-H	S	200	99,00A2					M 5 x 10-Z	S	500	19,90A2
M 5 x 6-H	S	500	28,50A2					M 5 x 12-Z	S	500	20,10A2
M 5 x 8-H	S	500	20,10A2					M 5 x 14-Z	S	500	22,40A2
M 5 x 8-H	K	200	22,00A2					M 5 x 16-Z	S	500	22,40A2
M 5 x 10-H	S	500	19,90A2					M 5 x 18-Z	S	500	25,00A2
M 5 x 10-H	K	200	21,80A2					M 5 x 20-Z	S	500	25,00A2
M 5 x 12-H	S	500	20,10A2					M 5 x 25-Z	S	500	29,00A2
M 5 x 12-H	K	200	22,00A2					M 5 x 30-Z	S	500	33,50A2
M 5 x 14-H	S	500	29,50A2					M 5 x 35-Z	S	500	38,00A2
M 5 x 16-H	S	500	22,40A2					M 5 x 40-Z	S	500	44,00A2
M 5 x 16-H	K	200	24,30A2					M 5 x 45-Z	S	200	49,50A2
M 5 x 18-H	S	500	33,00A2					M 5 x 50-Z	S	200	53,00A2
M 5 x 20-H	S	500	25,00A2					M 6 x 8-Z	S	200	24,80A2
M 5 x 20-H	K	200	27,00A2					M 6 x 10-Z	S	200	25,00A2
M 5 x 22-H	S	500	37,50A2					M 6 x 12-Z	S	200	26,50A2
M 5 x 25-H	S	500	29,00A2					M 6 x 16-Z	S	1000	30,00A2
M 5 x 25-H	K	200	30,50A2					M 6 x 20-Z	S	200	32,50A2
M 5 x 30-H	S	500	33,50A2					M 6 x 25-Z	S	200	36,50A2
M 5 x 30-H	K	200	35,50A2					M 6 x 30-Z	S	200	42,50A2
M 5 x 35-H	S	500	38,00A2					M 6 x 40-Z	S	200	54,00A2
M 5 x 35-H	K	200	40,00A2					M 6 x 45-Z	S	200	60,00A2
M 5 x 40-H	S	500	44,00A2					M 6 x 50-Z	S	200	62,00A2
M 5 x 40-H	K	200	46,00A2					M 6 x 55-Z	S	200	69,00A2
M 5 x 45-H	S	200	49,50A2					M 6 x 60-Z	S	100	69,00A2
M 5 x 50-H	S	200	53,00A2					M 8 x 10-Z	S	200	209,00A2
M 5 x 55-H	S	200	61,00A2					M 8 x 12-Z	S	200	180,00A2
M 5 x 60-H	S	200	62,00A2					M 8 x 16-Z	S	200	199,00A2
M 5 x 70-H	S	100	96,00A2					M 8 x 20-Z	S	200	214,00A2
M 5 x 80-H	S	100	113,00A2					M 8 x 25-Z	S	200	237,00A2
				M 1,6 x 3-Z	S	1000	47,50A2				
				M 1,6 x 4-Z	S	1000	45,50A2				
				M 1,6 x 5-Z	S	1000	46,50A2				
				M 1,6 x 6-Z	S	1000	47,50A2				
				M 1,6 x 8-Z	S	1000	52,00A2				
				M 1,6 x 12-Z	S	1000	67,00A2				
				M 1,6 x 16-Z	S	1000	80,00A2				
				M 2 x 3-Z	S	1000	19,70A2				
				M 2 x 5-Z	S	1000	11,00A2				

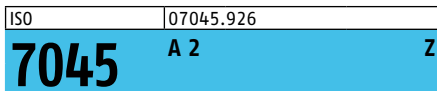

Linsenschrauben mit Pozidriv-Kreuzschlitz Z

Maße → **TI-40** Normumstellung → **TI-11**
 Werkstoffeigensch. → **TI-236**
 Stahl → **S. 327**
 ISO 7045 → ersetzt DIN 7985 (austauschbar)



Abmessungen	VE	Stück	€/100/Obf.
M 8 x 30 -Z	S	200	260,00A2
M 8 x 50 -Z	S	200	345,00A2
M 10 x 30 -Z	S	100	390,00A2

ISO 07045.944

7045 A 4 H



Linsenschrauben mit Phillips-Kreuzschlitz H

Maße → TI-40 Normumstellung → TI-11

Werkstoffeigensch. → TI-236

Stahl → S. 326

ISO 7045 → ersetzt DIN 7985 (austauschbar)



M 1,6 x 3 -H	S	1000	53,00A2
M 1,6 x 4 -H	S	1000	49,00A2
M 1,6 x 5 -H	S	1000	49,00A2
M 1,6 x 6 -H	S	1000	49,00A2
M 1,6 x 8 -H	S	1000	50,00A2
M 1,6 x 10 -H	S	1000	54,00A2
M 2 x 4 -H	S	1000	23,50A2
M 2 x 6 -H	S	1000	19,60A2
M 2 x 8 -H	S	1000	19,60A2
M 2 x 10 -H	S	1000	19,60A2
M 2 x 12 -H	S	1000	21,20A2
M 2 x 16 -H	S	1000	22,50A2
M 2 x 20 -H	S	1000	26,50A2
M 2,5 x 4 -H	S	1000	23,50A2
M 2,5 x 5 -H	S	1000	19,60A2
M 2,5 x 6 -H	S	1000	19,60A2
M 2,5 x 8 -H	S	1000	19,60A2
M 2,5 x 10 -H	S	1000	19,60A2
M 2,5 x 12 -H	S	1000	21,20A2
M 2,5 x 14 -H	S	1000	28,50A2
M 2,5 x 16 -H	S	1000	22,50A2
M 2,5 x 20 -H	S	1000	26,50A2
M 2,5 x 30 -H	S	500	53,00A2
M 3 x 4 -H	S	1000	22,30A2
M 3 x 5 -H	S	1000	18,80A2
M 3 x 6 -H	S	1000	12,40A2
M 3 x 8 -H	S	1000	12,20A2
M 3 x 10 -H	S	1000	13,40A2
M 3 x 12 -H	S	1000	14,40A2
M 3 x 14 -H	S	1000	21,40A2
M 3 x 16 -H	S	1000	15,60A2
M 3 x 20 -H	S	1000	17,40A2
M 3 x 25 -H	S	1000	20,40A2
M 3 x 30 -H	S	1000	30,00A2
M 3 x 35 -H	S	1000	55,00A2
M 3 x 40 -H	S	1000	62,00A2
M 3 x 50 -H	S	500	91,00A2
M 4 x 5 -H	S	1000	25,50A2
M 4 x 6 -H	S	1000	20,10A2
M 4 x 10 -H	S	1000	19,30A2
M 4 x 12 -H	S	1000	20,80A2
M 4 x 14 -H	S	1000	33,00A2
M 4 x 16 -H	S	1000	22,30A2
M 4 x 18 -H	S	1000	36,00A2
M 4 x 20 -H	S	1000	25,00A2
M 4 x 22 -H	S	1000	42,00A2
M 4 x 25 -H	S	1000	30,00A2
M 4 x 30 -H	S	500	37,50A2

Abmessungen	VE	Stück	€/100/Obf.
M 4 x 35 -H	S	500	47,00A2
M 4 x 40 -H	S	500	51,00A2
M 4 x 45 -H	S	200	115,00A2
M 4 x 50 -H	S	200	115,00A2
M 5 x 6 -H	S	500	50,00A2
M 5 x 8 -H	S	500	36,00A2
M 5 x 10 -H	S	500	28,50A2
M 5 x 12 -H	S	500	30,50A2
M 5 x 14 -H	S	500	53,00A2
M 5 x 16 -H	S	500	32,50A2
M 5 x 18 -H	S	500	59,00A2
M 5 x 20 -H	S	500	35,50A2
M 5 x 22 -H	S	500	66,00A2
M 5 x 25 -H	S	500	42,50A2
M 5 x 30 -H	S	500	50,00A2
M 5 x 35 -H	S	500	57,00A2
M 5 x 40 -H	S	500	79,00A2
M 5 x 45 -H	S	500	104,00A2
M 5 x 50 -H	S	200	110,00A2
M 5 x 60 -H	S	200	143,00A2
M 6 x 8 -H	S	200	60,00A2
M 6 x 10 -H	S	200	42,50A2
M 6 x 12 -H	S	200	44,50A2
M 6 x 16 -H	S	200	48,00A2
M 6 x 20 -H	S	200	52,00A2
M 6 x 25 -H	S	200	57,00A2
M 6 x 30 -H	S	200	64,00A2
M 6 x 35 -H	S	200	71,00A2
M 6 x 40 -H	S	200	84,00A2
M 6 x 45 -H	S	200	112,00A2
M 6 x 50 -H	S	200	114,00A2
M 6 x 60 -H	S	100	137,00A2

ISO 07046.924

7046-2 A 2 H



Senkschrauben mit Phillips-Kreuzschlitz H

Maße → TI-39 Normumstellung → TI-11

Werkstoffeigensch. → TI-236

Stahl → S. 328

ISO 7046 → ersetzt DIN 965 (austauschbar)



M 1,6 x 3 -H	S	2000	114,00A2
M 1,6 x 3 -H	K	1000	124,00A2
M 1,6 x 4 -H	S	2000	114,00A2
M 1,6 x 4 -H	K	1000	124,00A2
M 1,6 x 5 -H	S	2000	124,00A2
M 1,6 x 5 -H	K	1000	133,00A2
M 1,6 x 6 -H	S	2000	127,00A2
M 1,6 x 6 -H	K	1000	137,00A2
M 1,6 x 8 -H	S	2000	131,00A2
M 1,6 x 8 -H	K	1000	141,00A2
M 1,6 x 10 -H	S	2000	135,00A2
M 1,6 x 10 -H	K	1000	144,00A2
M 1,6 x 12 -H	S	2000	139,00A2
M 1,6 x 12 -H	K	1000	148,00A2
M 1,6 x 16 -H	S	2000	142,00A2
M 1,6 x 16 -H	K	1000	152,00A2
M 2 x 3 -H	S	1000	11,00A2
M 2 x 4 -H	S	1000	11,00A2
M 2 x 5 -H	S	1000	11,00A2

Abmessungen	VE	Stück	€/100/Obf.
M 2 x 6 -H	S	1000	11,00A2
M 2 x 8 -H	S	1000	11,00A2
M 2 x 10 -H	S	1000	11,00A2
M 2 x 12 -H	S	1000	12,00A2
M 2 x 14 -H	S	1000	22,80A2
M 2 x 16 -H	S	1000	38,00A2
M 2 x 20 -H	S	1000	42,00A2
M 2,5 x 3 -H	S	1000	22,80A2
M 2,5 x 4 -H	S	1000	22,80A2
M 2,5 x 5 -H	S	1000	11,00A2
M 2,5 x 6 -H	S	1000	11,00A2
M 2,5 x 8 -H	S	1000	11,00A2
M 2,5 x 10 -H	S	1000	11,00A2
M 2,5 x 12 -H	S	1000	11,40A2
M 2,5 x 16 -H	S	1000	12,40A2
M 2,5 x 20 -H	S	1000	13,30A2
M 2,5 x 25 -H	S	1000	28,50A2
M 3 x 4 -H	S	1000	12,50A2
M 3 x 5 -H	S	1000	10,60A2
M 3 x 5 -H	K	200	12,50A2
M 3 x 6 -H	S	1000	7,10A2
M 3 x 6 -H	K	200	8,90A2
M 3 x 8 -H	S	1000	7,50A2
M 3 x 8 -H	K	200	9,40A2
M 3 x 10 -H	K	200	9,90A2
M 3 x 12 -H	S	1000	8,50A2
M 3 x 12 -H	K	200	10,40A2
M 3 x 16 -H	S	1000	9,20A2
M 3 x 16 -H	K	200	11,10A2
M 3 x 20 -H	S	1000	10,60A2
M 3 x 20 -H	K	200	12,40A2
M 3 x 22 -H	S	1000	17,10A2
M 3 x 25 -H	S	1000	11,50A2
M 3 x 30 -H	S	1000	16,90A2
M 3 x 35 -H	S	500	28,50A2
M 3 x 40 -H	S	500	35,50A2
M 3 x 45 -H	S	500	65,00A2
M 3 x 50 -H	S	500	65,00A2
M 4 x 5 -H	S	1000	14,30A2
M 4 x 6 -H	S	1000	11,30A2
M 4 x 8 -H	S	1000	4,15A2
M 4 x 10 -H	S	1000	11,80A2
M 4 x 12 -H	S	1000	12,40A2
M 4 x 14 -H	S	1000	14,00A2
M 4 x 16 -H	S	1000	14,00A2
M 4 x 18 -H	S	1000	15,70A2
M 4 x 20 -H	S	1000	15,50A2
M 4 x 25 -H	S	1000	18,00A2
M 4 x 30 -H	S	1000	21,10A2
M 4 x 35 -H	S	500	26,50A2
M 4 x 40 -H	S	500	28,50A2
M 4 x 45 -H	S	500	65,00A2
M 4 x 50 -H	S	500	65,00A2
M 4 x 60 -H	S	500	86,00A2
M 5 x 6 -H	S	500	28,50A2
M 5 x 8 -H	S	500	20,10A2
M 5 x 8 -H	K	200	22,00A2
M 5 x 10 -H	S	500	19,90A2
M 5 x 10 -H	K	200	21,80A2
M 5 x 12 -H	S	500	20,10A2
M 5 x 12 -H	K	200	22,00A2
M 5 x 14 -H	S	500	22,50A2
M 5 x 16 -H	S	500	22,40A2
M 5 x 16 -H	K	200	24,30A2
M 5 x 18 -H	S	500	33,00A2
M 5 x 20 -H	S	500	25,00A2
M 5 x 20 -H	K	200	27,00A2
M 5 x 25 -H	S	500	29,00A2
M 5 x 25 -H	K	200	30,50A2
M 5 x 30 -H	S	500	33,50A2
M 5 x 30 -H	K	200	35,50A2
M 5 x 35 -H	S	500	38,00A2
M 5 x 35 -H	K	200	40,00A2
M 5 x 40 -H	S	200	44,00A2
M 5 x 45 -H	S	200	54,00A2

Abmessungen	VE	Stück	€/100/Obf.
M 5 x 50 -H	S	200	57,00A2
M 5 x 55 -H	S	200	71,00A2
M 5 x 60 -H	S	200	71,00A2
M 5 x 70 -H	S	200	96,00A2
M 5 x 80 -H	S	200	113,00A2
M 5 x 90 -H	S	200	133,00A2
M 5 x 100 -H	S	200	161,00A2
M 6 x 8 -H	S	200	33,50A2
M 6 x 10 -H	S	200	25,00A2
M 6 x 12 -H	S	200	26,50A2
M 6 x 16 -H	S	200	30,00A2
M 6 x 20 -H	S	200	32,50A2
M 6 x 25 -H	S	200	36,50A2
M 6 x 30 -H	S	200	42,50A2
M 6 x 35 -H	S	200	47,00A2
M 6 x 40 -H	S	200	54,00A2
M 6 x 45 -H	S	200	60,00A2
M 6 x 50 -H	S	200	68,00A2
M 6 x 55 -H	S	200	77,00A2
M 6 x 60 -H	S	200	77,00A2
M 6 x 70 -H	S	100	115,00A2
M 6 x 80 -H	S	100	132,00A2
M 6 x 90 -H	S	100	150,00A2
M 6 x 100 -H	S	100	168,00A2
M 6 x 110 -H	S	100	355,00A2
M 6 x 120 -H	S	100	430,00A2
M 8 x 10 -H	S	100	143,00A2
M 8 x 12 -H	S	100	55,00A2
M 8 x 16 -H	S	100	59,00A2
M 8 x 20 -H	S	100	66,00A2
M 8 x 25 -H	S	100	77,00A2
M 8 x 30 -H	S	100	80,00A2
M 8 x 35 -H	S	100	84,00A2
M 8 x 40 -H	S	100	91,00A2
M 8 x 45 -H	S	100	97,00A2
M 8 x 50 -H	S	100	110,00A2
M 8 x 55 -H	S	100	122,00A2
M 8 x 60 -H	S	100	122,00A2
M 8 x 70 -H	S	100	144,00A2
M 8 x 80 -H	S	100	167,00A2
M 10 x 12 -H	S	100	237,00A2
M 10 x 16 -H	S	100	275,00A2
M 10 x 20 -H	S	100	305,00A2
M 10 x 25 -H	S	100	360,00A2
M 10 x 30 -H	S	100	420,00A2
M 10 x 35 -H	S	100	455,00A2
M 10 x 40 -H	S	100	495,00A2
M 10 x 45 -H	S	100	550,00A2
M 10 x 50 -H	S	100	600,00A2
M 10 x 55 -H	S	100	660,00A2
M 10 x 60 -H	S	100	700,00A2

Abmessungen	VE	Stück	€/100/Obf.
ISO 07046.927			
7046-2 A 2 Z			

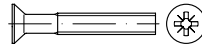

Senkschrauben mit Pozidriv-Kreuzschlitz Z

Maße → **TI-39** Normumstellung → **TI-11**
 Werkstoffeigensch. → **TI-236**

Stahl → **S. 329**
 ISO 7046 → ersetzt DIN 965 (austauschbar)



M 2 x 3 -Z	S	1000	22,80A2
M 2 x 4 -Z	S	1000	24,70A2
M 2 x 5 -Z	S	1000	27,00A2
M 2 x 6 -Z	S	1000	30,00A2
M 2 x 10 -Z	S	1000	30,00A2
M 2 x 12 -Z	S	1000	31,00A2
M 2 x 14 -Z	S	1000	38,00A2
M 2 x 16 -Z	S	1000	38,00A2
M 2 x 20 -Z	S	1000	42,00A2
M 2,5 x 3 -Z	S	1000	22,80A2
M 2,5 x 4 -Z	S	1000	22,80A2
M 2,5 x 5 -Z	S	1000	11,00A2
M 2,5 x 6 -Z	S	1000	11,00A2
M 2,5 x 8 -Z	S	1000	11,00A2
M 2,5 x 10 -Z	S	1000	11,00A2
M 2,5 x 12 -Z	S	1000	11,40A2
M 2,5 x 16 -Z	S	1000	12,40A2
M 2,5 x 20 -Z	S	1000	13,30A2
M 2,5 x 25 -Z	S	1000	28,50A2
M 3 x 4 -Z	S	1000	12,50A2
M 3 x 5 -Z	S	1000	10,60A2
M 3 x 6 -Z	S	1000	7,10A2
M 3 x 8 -Z	S	1000	7,50A2
M 3 x 10 -Z	S	1000	8,00A2
M 3 x 12 -Z	S	1000	8,50A2
M 3 x 14 -Z	S	1000	8,40A2
M 3 x 16 -Z	S	1000	9,20A2
M 3 x 22 -Z	S	1000	11,50A2
M 3 x 25 -Z	S	1000	11,50A2
M 3 x 30 -Z	S	1000	16,90A2
M 3 x 40 -Z	S	500	35,50A2
M 3 x 50 -Z	S	500	65,00A2
M 4 x 5 -Z	S	1000	14,30A2
M 4 x 6 -Z	S	1000	11,30A2
M 4 x 8 -Z	S	1000	11,30A2
M 4 x 10 -Z	S	1000	11,80A2
M 4 x 12 -Z	S	1000	12,40A2
M 4 x 14 -Z	S	1000	14,00A2
M 4 x 16 -Z	S	1000	14,00A2
M 4 x 20 -Z	S	1000	15,50A2
M 4 x 22 -Z	S	1000	18,00A2
M 4 x 25 -Z	S	1000	18,00A2
M 4 x 30 -Z	S	1000	21,10A2
M 4 x 40 -Z	S	500	28,50A2
M 4 x 45 -Z	S	500	65,00A2
M 4 x 60 -Z	S	500	76,00A2
M 5 x 8 -Z	S	500	20,10A2
M 5 x 10 -Z	S	500	19,90A2
M 5 x 12 -Z	S	500	20,10A2
M 5 x 16 -Z	S	500	22,40A2
M 5 x 18 -Z	S	500	27,00A2
M 5 x 20 -Z	S	500	25,00A2

Abmessungen	VE	Stück	€/100/Obf.
M 5 x 25 -Z	S	500	29,00A2
M 5 x 30 -Z	S	500	33,50A2
M 5 x 35 -Z	S	500	38,00A2
M 5 x 40 -Z	S	200	44,00A2
M 5 x 45 -Z	S	200	57,00A2
M 5 x 50 -Z	S	200	57,00A2
M 5 x 55 -Z	S	200	71,00A2
M 5 x 60 -Z	S	200	71,00A2
M 5 x 70 -Z	S	200	96,00A2
M 5 x 80 -Z	S	200	113,00A2
M 5 x 90 -Z	S	200	133,00A2
M 5 x 100 -Z	S	200	161,00A2
M 6 x 8 -Z	S	200	33,50A2
M 6 x 10 -Z	S	200	25,00A2
M 6 x 12 -Z	S	200	26,50A2
M 6 x 16 -Z	S	200	30,00A2
M 6 x 20 -Z	S	200	32,50A2
M 6 x 25 -Z	S	200	36,50A2
M 6 x 30 -Z	S	200	42,50A2
M 6 x 40 -Z	S	200	54,00A2
M 6 x 50 -Z	S	200	68,00A2
M 6 x 60 -Z	S	200	77,00A2
M 6 x 70 -Z	S	100	171,00A2
M 6 x 80 -Z	S	100	199,00A2
M 6 x 90 -Z	S	100	237,00A2
M 6 x 100 -Z	S	100	285,00A2
M 6 x 110 -Z	S	100	355,00A2
M 6 x 120 -Z	S	100	430,00A2
M 8 x 10 -Z	S	100	143,00A2
M 8 x 12 -Z	S	100	161,00A2
M 8 x 16 -Z	S	100	190,00A2
M 8 x 20 -Z	S	100	209,00A2
M 8 x 25 -Z	S	100	247,00A2
M 8 x 30 -Z	S	100	285,00A2
M 8 x 40 -Z	S	100	345,00A2
M 8 x 45 -Z	S	100	380,00A2
M 8 x 50 -Z	S	100	410,00A2
M 8 x 55 -Z	S	100	445,00A2
M 8 x 60 -Z	S	100	475,00A2
M 8 x 70 -Z	S	100	560,00A2
M 8 x 80 -Z	S	100	670,00A2
M 10 x 16 -Z	S	100	275,00A2
M 10 x 25 -Z	S	100	360,00A2
M 10 x 35 -Z	S	100	455,00A2
M 10 x 40 -Z	S	100	495,00A2

Abmessungen	VE Stück	€/100/0bf.
ISO	07046.945	
7046-2		A 4
		H



Senkschrauben mit Phillips-Kreuzschlitz H

Maße → **TI-39** Normumstellung → **TI-11**
 Werkstoffeigensch. → **TI-236**

Stahl → **S. 328**

ISO 7046 → ersetzt DIN 965 (austauschbar)

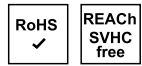

M 1,6	x 3-H	S 1000	126,00A4
M 1,6	x 4-H	S 1000	126,00A4
M 1,6	x 5-H	S 1000	137,00A4
M 1,6	x 10-H	S 1000	149,00A4
M 1,6	x 16-H	S 1000	158,00A4
M 2	x 3-H	S 1000	34,00A4
M 2	x 4-H	S 1000	34,00A4
M 2	x 5-H	S 1000	36,50A4
M 2	x 6-H	S 1000	39,50A4
M 2	x 8-H	S 1000	42,00A4
M 2	x 10-H	S 1000	44,50A4
M 2	x 12-H	S 1000	47,50A4
M 2	x 16-H	S 1000	51,00A4
M 2	x 20-H	S 1000	57,00A4
M 2,5	x 3-H	S 1000	34,00A4
M 2,5	x 4-H	S 1000	34,00A4
M 2,5	x 5-H	S 1000	38,00A4
M 2,5	x 6-H	S 1000	40,00A4
M 2,5	x 8-H	S 1000	46,50A4
M 2,5	x 10-H	S 1000	51,00A4
M 2,5	x 12-H	S 1000	55,00A4
M 2,5	x 14-H	S 1000	62,00A4
M 2,5	x 16-H	S 1000	62,00A4
M 2,5	x 20-H	S 1000	74,00A4
M 2,5	x 25-H	S 1000	89,00A4
M 3	x 4-H	S 1000	42,00A4
M 3	x 5-H	S 1000	42,00A4
M 3	x 6-H	S 1000	12,40A4
M 3	x 8-H	S 1000	12,10A4
M 3	x 10-H	S 1000	13,40A4
M 3	x 12-H	S 1000	14,40A4
M 3	x 14-H	S 1000	15,60A4
M 3	x 16-H	S 1000	15,60A4
M 3	x 20-H	S 1000	17,40A4
M 3	x 25-H	S 1000	20,40A4
M 3	x 30-H	S 1000	30,00A4
M 3	x 35-H	S 1000	55,00A4
M 3	x 40-H	S 500	70,00A4
M 4	x 5-H	S 1000	28,50A4
M 4	x 6-H	S 1000	20,10A4
M 4	x 8-H	S 1000	18,10A4
M 4	x 10-H	S 1000	19,30A4
M 4	x 12-H	S 1000	20,80A4
M 4	x 16-H	S 1000	22,30A4
M 4	x 18-H	S 1000	25,50A4
M 4	x 20-H	S 1000	25,00A4
M 4	x 25-H	S 1000	30,00A4
M 4	x 30-H	S 1000	37,50A4
M 4	x 35-H	S 500	47,00A4
M 4	x 40-H	S 500	51,00A4
M 4	x 45-H	S 500	115,00A4
M 4	x 50-H	S 200	115,00A4

Abmessungen	VE Stück	€/100/0bf.
M 4	x 55-H	S 200
M 4	x 60-H	S 200
M 5	x 6-H	S 500
M 5	x 8-H	S 500
M 5	x 10-H	S 500
M 5	x 12-H	S 500
M 5	x 16-H	S 500
M 5	x 20-H	S 500
M 5	x 25-H	S 500
M 5	x 30-H	S 500
M 5	x 35-H	S 200
M 5	x 40-H	S 200
M 5	x 45-H	S 200
M 5	x 50-H	S 200
M 5	x 55-H	S 200
M 5	x 60-H	S 200
M 6	x 8-H	S 200
M 6	x 10-H	S 200
M 6	x 12-H	S 200
M 6	x 16-H	S 200
M 6	x 20-H	S 200
M 6	x 25-H	S 200
M 6	x 30-H	S 200
M 6	x 35-H	S 200
M 6	x 40-H	S 200
M 6	x 45-H	S 200
M 6	x 50-H	S 200
M 6	x 55-H	S 200
M 6	x 60-H	S 200
M 6	x 70-H	S 200
M 6	x 80-H	S 200
M 6	x 90-H	S 200
M 6	x 90-H	S 200
M 8	x 10-H	S 200
M 8	x 12-H	S 100
M 8	x 16-H	S 100
M 8	x 20-H	S 100
M 8	x 25-H	S 100
M 8	x 30-H	S 100
M 8	x 35-H	S 100
M 8	x 40-H	S 100
M 8	x 45-H	S 100
M 8	x 50-H	S 100
M 8	x 55-H	S 100
M 8	x 60-H	S 100
M 8	x 70-H	S 100
M 8	x 80-H	S 100
M 8	x 90-H	S 100
M 10	x 16-H	S 100
M 10	x 20-H	S 100
M 10	x 25-H	S 100
M 10	x 30-H	S 100
M 10	x 35-H	S 100
M 10	x 40-H	S 100
M 10	x 45-H	S 100
M 10	x 50-H	S 100
M 10	x 55-H	S 100
M 10	x 60-H	S 100
M 10	x 70-H	S 100
M 10	x 80-H	S 100

M 4	x 55-H	S 200	139,00A4
M 4	x 60-H	S 200	179,00A4
M 5	x 6-H	S 500	42,00A4
M 5	x 8-H	S 500	38,00A4
M 5	x 10-H	S 500	28,50A4
M 5	x 12-H	S 500	30,50A4
M 5	x 16-H	S 500	32,50A4
M 5	x 20-H	S 500	35,50A4
M 5	x 25-H	S 500	42,50A4
M 5	x 30-H	S 500	50,00A4
M 5	x 35-H	S 200	62,00A4
M 5	x 40-H	S 200	80,00A4
M 5	x 45-H	S 200	134,00A4
M 5	x 50-H	S 200	147,00A4
M 5	x 55-H	S 200	172,00A4
M 5	x 60-H	S 200	200,00A4
M 6	x 8-H	S 200	52,00A4
M 6	x 10-H	S 200	42,50A4
M 6	x 12-H	S 200	44,50A4
M 6	x 16-H	S 200	48,00A4
M 6	x 20-H	S 200	52,00A4
M 6	x 25-H	S 200	60,00A4
M 6	x 30-H	S 200	64,00A4
M 6	x 35-H	S 200	84,00A4
M 6	x 40-H	S 200	84,00A4
M 6	x 45-H	S 200	114,00A4
M 6	x 50-H	S 200	114,00A4
M 6	x 55-H	S 200	137,00A4
M 6	x 60-H	S 200	137,00A4
M 6	x 70-H	S 200	200,00A4
M 6	x 80-H	S 200	255,00A4
M 6	x 90-H	S 200	305,00A4
M 8	x 10-H	S 200	137,00A4
M 8	x 12-H	S 100	137,00A4
M 8	x 16-H	S 100	112,00A4
M 8	x 20-H	S 100	120,00A4
M 8	x 25-H	S 100	129,00A4
M 8	x 30-H	S 100	149,00A4
M 8	x 35-H	S 100	174,00A4
M 8	x 40-H	S 100	192,00A4
M 8	x 45-H	S 100	370,00A4
M 8	x 50-H	S 100	435,00A4
M 8	x 55-H	S 100	550,00A4
M 8	x 60-H	S 100	610,00A4
M 8	x 70-H	S 100	700,00A4
M 8	x 80-H	S 100	790,00A4
M 8	x 90-H	S 100	900,00A4
M 10	x 16-H	S 100	530,00A4
M 10	x 20-H	S 100	295,00A4
M 10	x 25-H	S 100	320,00A4
M 10	x 30-H	S 100	340,00A4
M 10	x 35-H	S 100	380,00A4
M 10	x 40-H	S 100	415,00A4
M 10	x 45-H	S 100	425,00A4
M 10	x 50-H	S 100	425,00A4
M 10	x 55-H	S 100	475,00A4
M 10	x 60-H	S 100	475,00A4
M 10	x 70-H	S 100	890,00A4
M 10	x 80-H	S 100	1050,00A4

Abmessungen	VE Stück	€/100/0bf.
ISO	07047.924	
7047		A 2
		H



Linsenschrauben mit Phillips-Kreuzschlitz H

Maße → **TI-39** Normumstellung → **TI-11**
 Werkstoffeigensch. → **TI-232**

Stahl → **S. 329**

ISO 7047 → ersetzt DIN 966 (austauschbar)

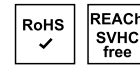

M 2,5	x 4-H	S 1000	28,50A2
M 2,5	x 5-H	S 1000	26,00A2
M 2,5	x 6-H	S 1000	21,80A2
M 2,5	x 8-H	S 1000	13,20A2
M 2,5	x 10-H	S 1000	13,20A2
M 2,5	x 12-H	S 1000	16,10A2
M 2,5	x 16-H	S 1000	20,90A2
M 2,5	x 20-H	S 1000	30,50A2
M 2,5	x 25-H	S 1000	45,50A2
M 3	x 4-H	S 1000	19,00A2
M 3	x 5-H	S 1000	10,60A2
M 3	x 6-H	S 1000	7,10A2
M 3	x 8-H	S 1000	7,50A2
M 3	x 10-H	S 1000	8,00A2
M 3	x 12-H	S 1000	9,20A2
M 3	x 16-H	S 1000	9,20A2
M 3	x 18-H	S 1000	10,50A2
M 3	x 20-H	S 1000	10,60A2
M 3	x 25-H	S 1000	18,50A2
M 3	x 30-H	S 500	24,70A2
M 3	x 35-H	S 500	26,50A2
M 3	x 45-H	S 500	61,00A2
M 3	x 50-H	S 500	95,00A2
M 4	x 5-H	S 1000	22,80A2
M 4	x 6-H	S 1000	11,00A2
M 4	x 8-H	S 1000	11,30A2
M 4	x 10-H	S 1000	11,80A2
M 4	x 12-H	S 1000	12,40A2
M 4	x 14-H	S 1000	14,00A2
M 4	x 16-H	S 1000	14,00A2
M 4	x 20-H	S 1000	15,50A2
M 4	x 25-H	S 1000	18,00A2
M 4	x 30-H	S 500	21,10A2
M 4	x 35-H	S 500	26,50A2
M 4	x 40-H	S 500	28,50A2
M 4	x 45-H	S 500	67,00A2
M 4	x 50-H	S 500	110,00A2
M 5	x 6-H	S 500	30,50A2
M 5	x 8-H	S 500	20,10A2
M 5	x 10-H	S 500	19,90A2
M 5	x 12-H	S 500	20,10A2
M 5	x 16-H	S 500	22,40A2
M 5	x 20-H	S 500	25,00A2
M 5	x 25-H	S 500	29,00A2
M 5	x 30-H	S 500	33,50A2
M 5	x 35-H	S 500	38,00A2
M 5	x 40-H	S 200	44,00A2
M 5	x 45-H	S 200	59,00A2
M 5	x 50-H	S 200	62,00A2
M 5	x 55-H	S 200	86,00A2
M 5	x 60-H	S 200	81,00A2
M 5	x 70-H	S 200	114,00A2

Abmessungen	VE	Stück	€/100/Obf.
M 5 x 80 -H	S	200	161,00A2
M 6 x 8 -H	S	200	38,00A2
M 6 x 10 -H	S	200	38,00A2
M 6 x 12 -H	S	200	26,50A2
M 6 x 16 -H	S	200	30,00A2
M 6 x 20 -H	S	200	32,50A2
M 6 x 22 -H	S	200	126,00A2
M 6 x 25 -H	S	200	36,50A2
M 6 x 30 -H	S	200	42,50A2
M 6 x 35 -H	S	200	47,00A2
M 6 x 40 -H	S	200	54,00A2
M 6 x 45 -H	S	200	63,00A2
M 6 x 50 -H	S	200	64,00A2
M 6 x 55 -H	S	200	77,00A2
M 6 x 60 -H	S	200	77,00A2
M 6 x 65 -H	S	200	142,00A2
M 6 x 70 -H	S	200	167,00A2
M 6 x 80 -H	S	200	209,00A2
M 8 x 10 -H	S	200	57,00A2
M 8 x 12 -H	S	200	57,00A2
M 8 x 16 -H	S	200	45,00A2
M 8 x 20 -H	S	200	47,50A2
M 8 x 25 -H	S	200	59,00A2
M 8 x 30 -H	S	200	64,00A2
M 8 x 35 -H	S	100	71,00A2
M 8 x 40 -H	S	100	75,00A2
M 8 x 45 -H	S	100	151,00A2
M 8 x 50 -H	S	100	151,00A2
M 8 x 55 -H	S	100	163,00A2
M 8 x 60 -H	S	100	175,00A2

ISO	07047.944
7047	A 4 H

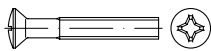

Linsensenschrauben mit Phillips-Kreuzschlitz H

Maße → **TI-39** Normumstellung → **TI-11**
 Werkstoffeigensch. → **TI-232**
 Stahl → **S. 329**
 ISO 7047 → ersetzt DIN 966 (austauschbar)

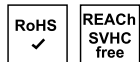

M 2,5 x 6 -H	S	1000	36,50A4
M 2,5 x 8 -H	S	1000	22,10A4
M 2,5 x 10 -H	S	1000	31,00A4
M 2,5 x 12 -H	S	1000	27,00A4
M 2,5 x 16 -H	S	1000	35,00A4
M 2,5 x 20 -H	S	1000	51,00A4
M 2,5 x 25 -H	S	1000	76,00A4
M 3 x 4 -H	S	1000	31,50A4
M 3 x 5 -H	S	1000	17,70A4
M 3 x 6 -H	S	1000	12,10A4
M 3 x 8 -H	S	1000	12,60A4
M 3 x 10 -H	S	1000	13,40A4
M 3 x 12 -H	S	1000	14,40A4
M 3 x 16 -H	S	1000	15,60A4
M 3 x 20 -H	S	1000	17,40A4
M 3 x 25 -H	S	1000	20,40A4
M 3 x 30 -H	S	1000	41,00A4
M 4 x 6 -H	S	1000	18,30A4
M 4 x 8 -H	S	1000	18,10A4
M 4 x 10 -H	S	1000	19,30A4
M 4 x 12 -H	S	1000	20,80A4

Abmessungen	VE	Stück	€/100/Obf.
M 4 x 16 -H	S	1000	22,30A4
M 4 x 20 -H	S	1000	25,00A4
M 4 x 25 -H	S	1000	30,00A4
M 4 x 30 -H	S	1000	35,00A4
M 4 x 35 -H	S	1000	44,50A4
M 4 x 40 -H	S	1000	47,50A4
M 5 x 6 -H	S	500	51,00A4
M 5 x 8 -H	S	500	33,50A4
M 5 x 10 -H	S	500	28,50A4
M 5 x 12 -H	S	500	30,50A4
M 5 x 16 -H	S	500	32,50A4
M 5 x 20 -H	S	500	35,50A4
M 5 x 25 -H	S	500	42,50A4
M 5 x 30 -H	S	500	50,00A4
M 5 x 35 -H	S	500	63,00A4
M 5 x 40 -H	S	200	73,00A4
M 5 x 45 -H	S	200	98,00A4
M 5 x 50 -H	S	200	103,00A4
M 6 x 8 -H	S	200	63,00A4
M 6 x 10 -H	S	200	42,50A4
M 6 x 12 -H	S	200	44,50A4
M 6 x 16 -H	S	200	48,00A4
M 6 x 20 -H	S	200	50,00A4
M 6 x 25 -H	S	200	57,00A4
M 6 x 30 -H	S	200	64,00A4
M 6 x 35 -H	S	200	71,00A4
M 6 x 40 -H	S	200	84,00A4
M 6 x 45 -H	S	200	105,00A4
M 6 x 50 -H	S	200	107,00A4
M 6 x 55 -H	S	200	128,00A4
M 6 x 60 -H	S	200	152,00A4
M 8 x 10 -H	S	200	95,00A4
M 8 x 16 -H	S	200	75,00A4
M 8 x 20 -H	S	200	79,00A4
M 8 x 25 -H	S	200	97,00A4
M 8 x 30 -H	S	200	106,00A4
M 8 x 35 -H	S	100	118,00A4
M 8 x 40 -H	S	100	124,00A4
M 8 x 45 -H	S	100	255,00A4
M 8 x 50 -H	S	100	255,00A4
M 8 x 55 -H	S	100	275,00A4
M 8 x 60 -H	S	100	290,00A4

ISO	07049.926
7049	A 2 Form C-H

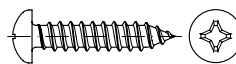

Linsenkopf-Blehschrauben mit Phillips-Kreuzschlitz H, C = mit Spitze,

Nennlängen ab 60 mm mit Teilgewinde

Achtung! Härte werkstoffbedingt nur ~ 250 HV.

Maße → **TI-46** Montage → **TI-251**
 Werkstoffeigensch. → **TI-236** Normumstellung → **TI-11**

Stahl → **S. 330**

ISO 7049 → ersetzt DIN 7981 (austauschbar)



C 2,2 x 4,5 -H	S	1000	11,40A2
C 2,2 x 6,5 -H	S	1000	11,00A2
C 2,2 x 6,5 -H	K	100	14,90A2
C 2,2 x 9,5 -H	S	1000	8,70A2
C 2,2 x 13 -H	S	1000	12,40A2
C 2,2 x 16 -H	S	1000	14,20A2

Abmessungen	VE	Stück	€/100/Obf.
C 2,2 x 19 -H	S	1000	19,00A2
C 2,9 x 6,5 -H	S	1000	7,10A2
C 2,9 x 6,5 -H	K	100	11,00A2
C 2,9 x 9,5 -H	S	1000	4,95A2
C 2,9 x 9,5 -H	K	100	8,80A2
C 2,9 x 13 -H	S	1000	5,20A2
C 2,9 x 13 -H	K	100	9,00A2
C 2,9 x 16 -H	S	1000	5,70A2
C 2,9 x 16 -H	K	100	9,60A2
C 2,9 x 19 -H	S	1000	6,10A2
C 2,9 x 19 -H	K	100	10,00A2
C 2,9 x 22 -H	S	1000	10,20A2
C 2,9 x 22 -H	K	100	14,00A2
C 2,9 x 25 -H	S	1000	10,60A2
C 2,9 x 25 -H	K	100	14,50A2
C 3,5 x 6,5 -H	S	1000	8,00A2
C 3,5 x 9,5 -H	S	1000	6,50A2
C 3,5 x 9,5 -H	K	100	10,40A2
C 3,5 x 13 -H	S	1000	6,90A2
C 3,5 x 13 -H	K	100	10,70A2
C 3,5 x 16 -H	S	1000	7,20A2
C 3,5 x 16 -H	K	100	11,10A2
C 3,5 x 19 -H	S	1000	8,00A2
C 3,5 x 19 -H	K	100	11,90A2
C 3,5 x 22 -H	S	1000	10,00A2
C 3,5 x 22 -H	K	100	13,90A2
C 3,5 x 25 -H	S	1000	10,40A2
C 3,5 x 25 -H	K	100	14,20A2
C 3,5 x 32 -H	S	1000	11,80A2
C 3,5 x 32 -H	K	100	15,70A2
C 3,5 x 38 -H	S	1000	13,20A2
C 3,5 x 38 -H	K	100	17,10A2
C 3,5 x 45 -H	S	1000	17,10A2
C 3,5 x 50 -H	S	1000	22,80A2
C 3,5 x 60 -H	S	500	31,50A2
C 3,9 x 9,5 -H	S	1000	7,80A2
C 3,9 x 9,5 -H	K	100	11,70A2
C 3,9 x 13 -H	S	1000	7,80A2
C 3,9 x 13 -H	K	100	11,70A2
C 3,9 x 16 -H	S	1000	8,40A2
C 3,9 x 16 -H	K	100	12,30A2
C 3,9 x 19 -H	S	1000	9,10A2
C 3,9 x 19 -H	K	100	13,00A2
C 3,9 x 22 -H	S	500	11,20A2
C 3,9 x 22 -H	K	100	15,10A2
C 3,9 x 25 -H	S	500	11,60A2
C 3,9 x 25 -H	K	100	15,50A2
C 3,9 x 32 -H	S	500	13,80A2
C 3,9 x 32 -H	K	100	17,60A2
C 3,9 x 38 -H	S	500	15,80A2
C 3,9 x 38 -H	K	100	19,60A2
C 3,9 x 45 -H	S	500	19,50A2
C 3,9 x 50 -H	S	500	23,40A2
C 4,2 x 9,5 -H	S	1000	8,80A2
C 4,2 x 9,5 -H	K	100	12,60A2
C 4,2 x 13 -H	S	1000	8,90A2
C 4,2 x 13 -H	K	100	12,80A2
C 4,2 x 16 -H	S	1000	10,00A2
C 4,2 x 16 -H	K	100	13,90A2
C 4,2 x 19 -H	S	500	10,90A2
C 4,2 x 19 -H	K	100	14,80A2
C 4,2 x 22 -H	S	500	12,40A2
C 4,2 x 22 -H	K	100	16,20A2
C 4,2 x 25 -H	S	500	12,70A2
C 4,2 x 25 -H	K	100	16,60A2
C 4,2 x 32 -H	S	500	15,80A2
C 4,2 x 32 -H	K	100	19,60A2
C 4,2 x 38 -H	S	500	17,90A2
C 4,2 x 38 -H	K	100	21,80A2
C 4,2 x 45 -H	S	500	26,00A2
C 4,2 x 45 -H	K	100	30,00A2
C 4,2 x 50 -H	S	500	29,50A2
C 4,2 x 50 -H	K	100	33,50A2
C 4,8 x 9,5 -H	S	500	11,00A2
C 4,8 x 9,5 -H	K	100	14,90A2

Abmessungen	VE	Stück	€/100/Obf.
C 4,8 x 13 -H	S	500	11,40 A2
C 4,8 x 13 -H	K	100	15,30 A2
C 4,8 x 16 -H	S	500	12,40 A2
C 4,8 x 16 -H	K	100	16,20 A2
C 4,8 x 19 -H	S	500	13,80 A2
C 4,8 x 19 -H	K	100	17,60 A2
C 4,8 x 22 -H	S	500	15,80 A2
C 4,8 x 22 -H	K	100	19,60 A2
C 4,8 x 25 -H	S	500	16,10 A2
C 4,8 x 25 -H	K	100	20,00 A2
C 4,8 x 32 -H	S	250	20,50 A2
C 4,8 x 32 -H	K	100	24,50 A2
C 4,8 x 38 -H	S	250	22,90 A2
C 4,8 x 38 -H	K	100	27,00 A2
C 4,8 x 45 -H	S	250	30,00 A2
C 4,8 x 45 -H	K	100	34,00 A2
C 4,8 x 50 -H	S	250	31,00 A2
C 4,8 x 50 -H	K	100	35,00 A2
C 4,8 x 60 -H	S	250	42,00 A2
C 4,8 x 70 -H	S	250	55,00 A2
C 4,8 x 80 -H	S	100	66,00 A2
C 4,8 x 90 -H	S	100	85,00 A2
C 4,8 x 100 -H	S	100	107,00 A2
C 4,8 x 120 -H	S	100	142,00 A2
C 5,5 x 13 -H	S	500	18,50 A2
C 5,5 x 13 -H	K	100	22,40 A2
C 5,5 x 16 -H	S	500	19,70 A2
C 5,5 x 16 -H	K	100	23,60 A2
C 5,5 x 19 -H	S	500	21,10 A2
C 5,5 x 19 -H	K	100	24,90 A2
C 5,5 x 22 -H	S	500	23,10 A2
C 5,5 x 22 -H	K	100	27,00 A2
C 5,5 x 25 -H	S	500	24,80 A2
C 5,5 x 25 -H	K	100	29,00 A2
C 5,5 x 32 -H	S	250	29,00 A2
C 5,5 x 32 -H	K	100	33,00 A2
C 5,5 x 38 -H	S	250	33,00 A2
C 5,5 x 38 -H	K	100	37,00 A2
C 5,5 x 45 -H	S	250	39,50 A2
C 5,5 x 45 -H	K	100	43,50 A2
C 5,5 x 50 -H	S	250	44,00 A2
C 5,5 x 50 -H	K	100	48,00 A2
C 5,5 x 60 -H	S	100	53,00 A2
C 5,5 x 70 -H	S	100	61,00 A2
C 5,5 x 80 -H	S	100	76,00 A2
C 5,5 x 90 -H	S	100	105,00 A2
C 5,5 x 100 -H	S	100	129,00 A2
C 6,3 x 13 -H	S	250	25,50 A2
C 6,3 x 13 -H	K	100	29,50 A2
C 6,3 x 16 -H	S	500	21,20 A2
C 6,3 x 16 -H	K	100	25,50 A2
C 6,3 x 19 -H	S	250	22,80 A2
C 6,3 x 19 -H	K	100	27,00 A2
C 6,3 x 22 -H	S	250	25,00 A2
C 6,3 x 22 -H	K	100	29,00 A2
C 6,3 x 25 -H	S	250	26,50 A2
C 6,3 x 25 -H	K	100	30,50 A2
C 6,3 x 32 -H	S	250	32,00 A2
C 6,3 x 32 -H	K	100	36,00 A2
C 6,3 x 38 -H	S	250	35,50 A2
C 6,3 x 38 -H	K	100	39,50 A2
C 6,3 x 45 -H	S	250	42,50 A2
C 6,3 x 45 -H	K	100	46,00 A2
C 6,3 x 50 -H	S	250	53,00 A2
C 6,3 x 50 -H	K	100	57,00 A2
C 6,3 x 60 -H	K	100	60,00 A2
C 6,3 x 70 -H	K	100	78,00 A2
C 6,3 x 80 -H	K	100	103,00 A2
C 6,3 x 90 -H	K	100	125,00 A2
C 6,3 x 100 -H	K	100	152,00 A2

Abmessungen	VE	Stück	€/100/Obf.
ISO 7049		07049.925	
7049	A 2		Form F-H



Linsenkopf-Blechschruben mit Phillips-Kreuzschlitz H, F = mit Zapfen

Achtung! Härte werkstoffbedingt nur ~ 250 HV.

Maße → **TI-46** Montage → **TI-251**
 Werkstoffeigensch. → **TI-236** Normumstellung → **TI-11**
 Stahl → **S. 330**

ISO 7049 → ersetzt DIN 7981 (austauschbar)

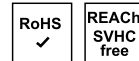

2,9 x 6,5 -F-H	S	1000	14,20 A2
2,9 x 9,5 -F-H	S	1000	14,40 A2
2,9 x 13 -F-H	S	1000	15,40 A2
2,9 x 16 -F-H	S	1000	17,10 A2
3,5 x 9,5 -F-H	S	1000	19,40 A2
3,5 x 13 -F-H	S	1000	20,50 A2
3,5 x 16 -F-H	S	1000	21,60 A2
3,9 x 9,5 -F-H	S	1000	23,30 A2
3,9 x 13 -F-H	S	1000	23,30 A2
4,2 x 9,5 -F-H	S	1000	26,50 A2

Abmessungen	VE	Stück	€/100/Obf.
ISO 7049		07049.944	
7049	A 4		Form C-H



Linsenkopf-Blechschruben mit Phillips-Kreuzschlitz H, C = mit Spitze

Achtung! Härte werkstoffbedingt nur ~ 250 HV.

Maße → **TI-46** Montage → **TI-251**
 Werkstoffeigensch. → **TI-236** Normumstellung → **TI-11**
 Stahl → **S. 330**

ISO 7049 → ersetzt DIN 7981 (austauschbar)



C 2,2 x 4,5 -H	S	1000	25,50 A4
C 2,2 x 6,5 -H	S	1000	24,40 A4
C 2,2 x 9,5 -H	S	1000	19,10 A4
C 2,2 x 13 -H	S	1000	27,50 A4
C 2,2 x 16 -H	S	1000	31,50 A4
C 2,2 x 19 -H	S	1000	38,00 A4
C 2,9 x 6,5 -H	S	1000	4,90 A4
C 2,9 x 9,5 -H	S	1000	11,00 A4
C 2,9 x 13 -H	S	1000	11,40 A4
C 2,9 x 16 -H	S	1000	12,60 A4
C 2,9 x 19 -H	S	1000	13,50 A4
C 2,9 x 22 -H	S	1000	22,50 A4
C 2,9 x 25 -H	S	1000	23,50 A4
C 3,5 x 6,5 -H	S	1000	14,70 A4

Abmessungen	VE	Stück	€/100/Obf.
C 3,5 x 6,5 -H	K	100	22,10 A4
C 3,5 x 9,5 -H	S	1000	14,30 A4
C 3,5 x 13 -H	S	1000	13,40 A4
C 3,5 x 16 -H	S	1000	13,80 A4
C 3,5 x 19 -H	S	1000	17,70 A4
C 3,5 x 22 -H	S	1000	23,10 A4
C 3,5 x 25 -H	S	1000	25,50 A4
C 3,5 x 32 -H	S	1000	27,50 A4
C 3,5 x 38 -H	S	1000	31,50 A4
C 3,9 x 9,5 -H	S	1000	17,30 A4
C 3,9 x 13 -H	S	1000	14,20 A4
C 3,9 x 16 -H	S	1000	18,50 A4
C 3,9 x 19 -H	S	1000	20,20 A4
C 3,9 x 25 -H	S	500	26,00 A4
C 3,9 x 32 -H	S	500	30,50 A4
C 3,9 x 38 -H	S	500	35,00 A4
C 3,9 x 45 -H	S	500	43,50 A4
C 3,9 x 50 -H	S	500	52,00 A4
C 4,2 x 9,5 -H	S	1000	19,30 A4
C 4,2 x 13 -H	S	1000	18,30 A4
C 4,2 x 16 -H	S	1000	20,10 A4
C 4,2 x 19 -H	S	500	21,80 A4
C 4,2 x 22 -H	S	500	27,50 A4
C 4,2 x 25 -H	S	500	28,50 A4
C 4,2 x 32 -H	S	500	35,00 A4
C 4,2 x 38 -H	S	500	40,00 A4
C 4,2 x 45 -H	S	500	58,00 A4
C 4,8 x 9,5 -H	S	500	24,40 A4
C 4,8 x 13 -H	S	100	25,50 A4
C 4,8 x 16 -H	S	500	27,00 A4
C 4,8 x 19 -H	S	500	27,50 A4
C 4,8 x 22 -H	S	500	35,00 A4
C 4,8 x 25 -H	S	500	33,50 A4
C 4,8 x 32 -H	S	250	43,50 A4
C 4,8 x 38 -H	S	250	51,00 A4
C 4,8 x 45 -H	S	250	67,00 A4
C 4,8 x 50 -H	S	250	69,00 A4
C 4,8 x 60 -H	S	250	93,00 A4
C 4,8 x 70 -H	S	250	122,00 A4
C 4,8 x 90 -H	S	100	187,00 A4
C 4,8 x 100 -H	S	100	236,00 A4
C 5,5 x 13 -H	S	500	41,00 A4
C 5,5 x 16 -H	S	500	44,00 A4
C 5,5 x 19 -H	S	500	47,00 A4
C 5,5 x 22 -H	S	500	52,00 A4
C 5,5 x 25 -H	S	500	55,00 A4
C 5,5 x 32 -H	S	250	65,00 A4
C 5,5 x 38 -H	S	250	73,00 A4
C 5,5 x 45 -H	S	250	87,00 A4
C 5,5 x 50 -H	S	250	98,00 A4
C 5,5 x 60 -H	S	100	116,00 A4
C 6,3 x 13 -H	S	250	56,00 A4
C 6,3 x 16 -H	S	500	47,00 A4
C 6,3 x 19 -H	S	250	51,00 A4
C 6,3 x 22 -H	S	250	56,00 A4
C 6,3 x 25 -H	S	250	59,00 A4
C 6,3 x 32 -H	S	250	71,00 A4
C 6,3 x 38 -H	S	250	79,00 A4
C 6,3 x 45 -H	S	250	94,00 A4
C 6,3 x 50 -H	S	250	116,00 A4

Abmessungen	VE Stück	€/100/Obf.
ISO 07050.924		
7050	A 2	Form C-H

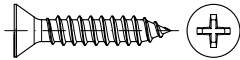

Senk-Blechschraben mit Phillips-Kreuzschlitz H, C = mit Spitze

Nennlängen ab 60 mm mit Teilgewinde, Senk $\angle = 90^\circ$

Achtung! Härte werkstoffbedingt nur ~ 250 HV.

Maße \rightarrow **TI-47** Montage \rightarrow **TI-251**
 Werkstoffeigensch. \rightarrow **TI-236** Normumstellung \rightarrow **TI-11**

Stahl \rightarrow **S. 332**

ISO 7050 \rightarrow ersetzt DIN 7982



2,2	x	6,5-C-H	S	1000	14,20A2
2,2	x	9,5-C-H	S	1000	9,80A2
2,2	x	13 -C-H	S	1000	18,70A2
2,2	x	16 -C-H	S	1000	26,50A2
2,2	x	19 -C-H	S	1000	37,50A2
2,9	x	6,5-C-H	S	1000	6,70A2
2,9	x	9,5-C-H	S	1000	4,95A2
2,9	x	13 -C-H	S	1000	5,20A2
2,9	x	16 -C-H	S	1000	5,70A2
2,9	x	19 -C-H	S	1000	6,10A2
2,9	x	22 -C-H	S	1000	10,20A2
2,9	x	25 -C-H	S	1000	10,60A2
3,5	x	9,5-C-H	S	1000	6,50A2
3,5	x	13 -C-H	S	1000	6,90A2
3,5	x	16 -C-H	S	1000	7,20A2
3,5	x	19 -C-H	S	1000	8,00A2
3,5	x	22 -C-H	S	1000	10,00A2
3,5	x	25 -C-H	S	1000	10,40A2
3,5	x	32 -C-H	S	1000	11,80A2
3,5	x	38 -C-H	S	1000	13,20A2
3,5	x	45 -C-H	S	1000	17,10A2
3,5	x	50 -C-H	S	1000	22,80A2
3,5	x	60 -C-H	S	500	31,50A2
4,2	x	9,5-C-H	S	1000	8,80A2
4,2	x	13 -C-H	S	1000	8,90A2
4,2	x	16 -C-H	S	1000	10,00A2
4,2	x	19 -C-H	S	500	10,90A2
4,2	x	22 -C-H	S	500	12,40A2
4,2	x	25 -C-H	S	500	12,70A2
4,2	x	32 -C-H	S	500	15,80A2
4,2	x	38 -C-H	S	500	17,90A2
4,2	x	45 -C-H	S	500	26,00A2
4,2	x	50 -C-H	S	500	29,50A2
4,2	x	60 -C-H	S	250	53,00A2
4,8	x	13 -C-H	S	500	11,40A2
4,8	x	16 -C-H	S	500	12,40A2
4,8	x	19 -C-H	S	500	13,80A2
4,8	x	22 -C-H	S	500	15,80A2
4,8	x	25 -C-H	S	500	16,10A2
4,8	x	32 -C-H	S	250	20,50A2
4,8	x	38 -C-H	S	250	22,90A2
4,8	x	45 -C-H	S	250	30,00A2
4,8	x	50 -C-H	S	250	31,00A2
4,8	x	55 -C-H	S	250	66,00A2
4,8	x	60 -C-H	S	250	42,00A2
4,8	x	70 -C-H	S	250	55,00A2
4,8	x	80 -C-H	S	250	66,00A2
4,8	x	90 -C-H	S	100	85,00A2

Abmessungen	VE Stück	€/100/Obf.			
4,8	x	100 -C-H	S	100	107,00A2
5,5	x	13 -C-H	S	500	18,50A2
5,5	x	16 -C-H	S	500	21,70A2
5,5	x	19 -C-H	S	500	21,10A2
5,5	x	22 -C-H	S	500	23,10A2
5,5	x	25 -C-H	S	500	24,80A2
5,5	x	32 -C-H	S	250	29,00A2
5,5	x	38 -C-H	S	250	33,00A2
5,5	x	45 -C-H	S	250	39,50A2
5,5	x	50 -C-H	S	250	44,00A2
5,5	x	60 -C-H	S	250	53,00A2
6,3	x	16 -C-H	S	500	21,20A2
6,3	x	19 -C-H	S	500	22,80A2
6,3	x	22 -C-H	S	500	25,00A2
6,3	x	25 -C-H	S	500	26,50A2
6,3	x	32 -C-H	S	250	32,00A2
6,3	x	38 -C-H	S	250	35,50A2
6,3	x	45 -C-H	S	250	42,50A2
6,3	x	50 -C-H	S	250	53,00A2

Abmessungen	VE Stück	€/100/Obf.
ISO 07051.924		
7051	A 2	Form C-H

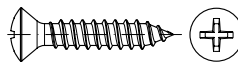

Linsensenk-Blechschraben mit Phillips-Kreuzschlitz H, C = mit Spitze

Senk $\angle = 90^\circ$

Achtung! Härte werkstoffbedingt nur ~ 250 HV.

Maße \rightarrow **TI-47** Montage \rightarrow **TI-251**
 Werkstoffeigensch. \rightarrow **TI-236** Normumstellung \rightarrow **TI-11**

Stahl \rightarrow **S. 333**

ISO 7051 \rightarrow ersetzt DIN 7983

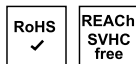

2,9	x	9,5-C-H	S	1000	4,95A2
2,9	x	13 -C-H	S	1000	5,20A2
2,9	x	16 -C-H	S	1000	5,70A2
2,9	x	19 -C-H	S	1000	6,10A2
2,9	x	22 -C-H	S	1000	10,20A2
2,9	x	25 -C-H	S	1000	10,60A2
3,5	x	9,5-C-H	S	1000	6,50A2
3,5	x	13 -C-H	S	1000	6,90A2
3,5	x	16 -C-H	S	1000	7,20A2
3,5	x	19 -C-H	S	1000	8,00A2
3,5	x	22 -C-H	S	1000	10,00A2
3,5	x	25 -C-H	S	1000	10,40A2
3,5	x	32 -C-H	S	1000	11,80A2
3,5	x	38 -C-H	S	1000	13,20A2
4,2	x	9,5-C-H	S	1000	8,80A2
4,2	x	13 -C-H	S	1000	8,90A2
4,2	x	16 -C-H	S	1000	10,00A2
4,2	x	19 -C-H	S	500	10,90A2
4,2	x	22 -C-H	S	500	12,40A2
4,2	x	25 -C-H	S	500	12,70A2
4,2	x	32 -C-H	S	500	15,80A2
4,2	x	38 -C-H	S	500	17,90A2
4,2	x	45 -C-H	S	500	26,00A2
4,2	x	50 -C-H	S	500	29,50A2
4,2	x	60 -C-H	S	250	53,00A2
4,2	x	13 -C-H	S	1000	8,90A2
4,2	x	16 -C-H	S	1000	10,00A2
4,2	x	19 -C-H	S	500	10,90A2
4,2	x	22 -C-H	S	500	12,40A2
4,2	x	25 -C-H	S	500	12,70A2
4,2	x	32 -C-H	S	500	15,80A2
4,2	x	38 -C-H	S	500	17,90A2
4,2	x	45 -C-H	S	500	26,00A2
4,2	x	50 -C-H	S	500	29,50A2
4,2	x	60 -C-H	S	200	40,00A2
4,8	x	13 -C-H	S	500	11,40A2
4,8	x	16 -C-H	S	500	12,40A2
4,8	x	19 -C-H	S	500	13,80A2
4,8	x	22 -C-H	S	500	15,80A2

Abmessungen	VE Stück	€/100/Obf.			
4,8	x	25 -C-H	S	500	16,10A2
4,8	x	32 -C-H	S	250	20,50A2
4,8	x	38 -C-H	S	250	22,90A2
4,8	x	45 -C-H	S	250	30,00A2
4,8	x	50 -C-H	S	250	31,00A2
4,8	x	60 -C-H	S	250	51,00A2
5,5	x	13 -C-H	S	500	18,50A2
5,5	x	16 -C-H	S	500	19,70A2
5,5	x	19 -C-H	S	500	21,10A2
5,5	x	22 -C-H	S	500	23,10A2
5,5	x	25 -C-H	S	500	24,80A2
5,5	x	32 -C-H	S	250	29,00A2
5,5	x	38 -C-H	S	250	33,00A2
5,5	x	45 -C-H	S	250	39,50A2
5,5	x	50 -C-H	S	250	44,00A2
6,3	x	16 -C-H	S	500	21,20A2
6,3	x	19 -C-H	S	500	22,80A2
6,3	x	22 -C-H	S	500	25,00A2
6,3	x	25 -C-H	S	500	26,50A2
6,3	x	32 -C-H	S	250	32,00A2
6,3	x	38 -C-H	S	250	35,50A2
6,3	x	45 -C-H	S	250	42,50A2
6,3	x	50 -C-H	S	250	53,00A2

Abmessungen	VE Stück	€/100/Obf.
ISO 07089.924		
7089	A 2 200 HV	

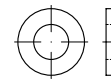

Flache Scheiben, normale Reihe, Produktklasse A, ohne Fase

Maße \rightarrow **TI-84** Normumstellung \rightarrow **TI-84**
 Werkstoffeigensch. \rightarrow **TI-236**

Stahl \rightarrow **S. 333**

Messing, Kupfer, Kunststoff, Aluminium \rightarrow **S. 639**

ISO 7089 \rightarrow ersetzt DIN 125 Form A



für Schrauben M

1,6		S	1000	27,50A2
2		S	1000	5,20A2
2,5		S	1000	5,20A2
3		S	1000	20,90A2
3		K	200	23,20A2
4		S	1000	22,00A2
4		K	200	24,30A2
5		S	1000	22,80A2
5		K	200	27,00A2
6		S	1000	34,00A2
6		K	200	38,50A2
8		S	1000	41,50A2
8		K	200	47,50A2
10		S	500	84,00A2
10		K	100	92,00A2
12		S	500	123,00A2
12		K	100	132,00A2
14		S	100	220,00A2
16		S	100	235,00A2
16		K	25	245,00A2
18		S	200	82,00A2
20		S	100	350,00A2
20		K	25	360,00A2
22		S	200	182,00A2
24		S	100	670,00A2
24		K	25	680,00A2
27		S	100	370,00A2
30		S	100	1050,00A2

Abmessungen	VE	Stück	€/100/Obf.
30	K	25	1060,00 A2
33	S	100	530,00 A2
36	S	50	2700,00 A2
39	S	10	780,00 A2
42	S	10	2000,00 A2
45	S	10	3200,00 A2
48	S	1	6400,00 A2
52	S	1	11900,00 A2
56	S	1	20200,00 A2

ISO	07089.944
7089	A 4 200 HV

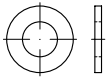

Flache Scheiben, normale Reihe, Produktklasse A, ohne Fase

Maße → [TI-84](#) Normumstellung → [TI-84](#)
 Werkstoffeigensch. → [TI-236](#)

Stahl → [S. 333](#)
 Messing, Kupfer, Kunststoff, Aluminium → [S. 639](#)

ISO 7089 → ersetzt DIN 125 Form A

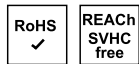

für Schrauben M

2	S	1000	14,90 A4
2,5	S	1000	12,10 A4
3	S	1000	2,45 A4
4	S	1000	99,00 A4
4	K	200	102,00 A4
5	S	1000	105,00 A4
5	K	200	110,00 A4
6	S	1000	122,00 A4
6	K	200	128,00 A4
8	S	1000	140,00 A4
8	K	200	146,00 A4
10	S	500	315,00 A4
10	K	100	325,00 A4
12	S	500	340,00 A4
12	K	100	350,00 A4
14	S	500	75,00 A4
16	S	100	770,00 A4
16	K	25	790,00 A4
18	S	200	129,00 A4
20	S	100	840,00 A4
20	K	25	860,00 A4
22	S	200	260,00 A4
24	S	100	1590,00 A4
24	K	25	1610,00 A4
27	S	100	550,00 A4
30	S	100	1660,00 A4
30	K	25	1680,00 A4
33	S	10	970,00 A4
36	S	10	890,00 A4
39	S	10	2070,00 A4
42	S	10	2120,00 A4

Abmessungen	VE	Stück	€/100/Obf.
ISO		07089.941	
7089		A 4 BUMAX88	200 HV

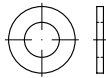

Flache Scheiben, normale Reihe, Produktklasse A, ohne Fase

Abmessungen ab Ø 6 für den Einsatz nach Druckgeräterichtlinie geeignet
 → APZ 3.1 auf Anfrage

Maße → [TI-84](#) Normumstellung → [TI-84](#)
 Werkstoffeigensch. → [TI-236](#)

Stahl → [S. 333](#)
 Messing, Kupfer, Kunststoff, Aluminium → [S. 639](#)

für den Einsatz mit Schrauben der Fkl. BUMAX88

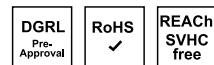

für Schrauben M

24	S	50	2550,00 A 4-88
----	---	----	----------------

ISO	07089.942
7089	A 4 BUMAX109
	300 HV

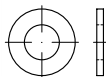

Flache Scheiben, normale Reihe, Produktklasse A, ohne Fase

Maße → [TI-84](#) Normumstellung → [TI-84](#)
 Werkstoffeigensch. → [TI-236](#)

Stahl → [S. 333](#)
 Messing, Kupfer, Kunststoff, Aluminium → [S. 639](#)

für den Einsatz mit Schrauben der Fkl. BUMAX109

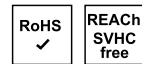

für Schrauben M

5	S	200	112,00 A4-109
6	S	200	120,00 A4-109
8	S	100	158,00 A4-109
10	S	100	340,00 A4-109
12	S	100	470,00 A4-109
16	S	100	970,00 A4-109
20	S	100	1390,00 A4-109

Abmessungen	VE	Stück	€/100/Obf.
ISO		07089.954	
7089		A 5 (1.4571) 200 HV	

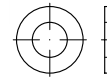

Flache Scheiben, normale Reihe, Produktklasse A, ohne Fase

Maße → [TI-84](#) Normumstellung → [TI-84](#)
 Werkstoffeigensch. → [TI-236](#)

Stahl → [S. 333](#)
 Messing, Kupfer, Kunststoff, Aluminium → [S. 639](#)

ISO 7089 → ersetzt DIN 125 Form A

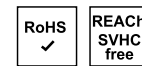

für Schrauben M

6	S	100	114,00 A5
8	S	100	125,00 A5
10	S	100	240,00 A5
12	S	50	270,00 A5
16	S	50	395,00 A5
20	S	25	580,00 A5
24	S	25	2220,00 A5
30	S	10	2650,00 A5

ISO	07090.924
7090	A 2 200 HV



Flache Scheiben mit Fase, normale Reihe, Produktklasse A

Maße → [TI-84](#) Normumstellung → [TI-84](#)
 Werkstoffeigensch. → [TI-236](#)

Stahl → [S. 335](#)
 Messing → [S. 640](#)

ISO 7090 → ersetzt DIN 125 Form B

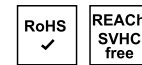

für Schrauben M

4	S	1000	52,00 A2
5	S	1000	36,50 A2
5	K	200	305,00 A2
6	S	1000	48,50 A2
6	K	200	355,00 A2
8	S	500	69,00 A2
8	K	100	380,00 A2
10	S	250	103,00 A2
10	K	50	620,00 A2
12	S	250	141,00 A2
12	K	50	770,00 A2
16	S	100	228,00 A2
16	K	25	1710,00 A2
20	S	50	365,00 A2
20	K	10	1750,00 A2
24	S	50	910,00 A2
24	K	10	1810,00 A2

Abmessungen	VE Stück	€/100/Obf.
ISO 07090.944		
7090	A 4 200 HV	



Flache Scheiben mit Fase, normale Reihe, Produktklasse A

Maße → **TI-84** Normumstellung → **TI-84**
 Werkstoffeigensch. → **TI-236**
 Stahl → **S. 335**
 Messing → **S. 640**
 ISO 7090 → ersetzt DIN 125 Form B

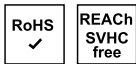

für Schrauben M

4	S 1000	59,00 A4
5	S 1000	335,00 A4
5	K 200	340,00 A4
6	S 1000	390,00 A4
6	K 200	395,00 A4
8	S 500	420,00 A4
8	K 100	420,00 A4
10	S 250	680,00 A4
10	K 100	680,00 A4
12	S 250	840,00 A4
12	K 100	850,00 A4
16	S 100	1880,00 A4
16	K 25	1890,00 A4
18	S 50	202,00 A4
20	S 50	1930,00 A4
20	K 10	1940,00 A4
24	S 50	2000,00 A4
27	S 25	580,00 A4
30	S 25	720,00 A4
33	S 25	2070,00 A4
36	S 10	5600,00 A4
42	S 10	7500,00 A4
45	S 10	10900,00 A4
48	S 10	12400,00 A4
52	S 1	12900,00 A4
56	S 1	14900,00 A4

Abmessungen	VE Stück	€/100/Obf.
ISO 07090.954		
7090	A 5 200 HV	



Flache Scheiben mit Fase, normale Reihe, Produktklasse A

Maße → **TI-84** Normumstellung → **TI-84**
 Werkstoffeigensch. → **TI-236**
 Stahl → **S. 335**
 Messing → **S. 640**
 ISO 7090 → ersetzt DIN 125 Form B

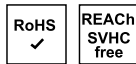

für Schrauben M

4	S 1000	59,00 A5
5	S 1000	335,00 A5
6	S 1000	390,00 A5
8	S 500	420,00 A5
10	S 250	680,00 A5
12	S 250	840,00 A5
16	S 100	1880,00 A5
20	S 50	1930,00 A5
24	S 50	2000,00 A5
30	S 25	2700,00 A5

Abmessungen	VE Stück	€/100/Obf.
ISO 07092.924		
7092	A 2 200 HV	

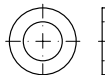

Flache Scheiben, kleine Reihe, Produktklasse A

vorzugsweise für Zylinderschrauben

Maße → **TI-84** Normumstellung → **TI-84**
 Werkstoffeigensch. → **TI-236**
 Stahl → **S. 338**
 Messing → **S. 641**
 ISO 7092 → ersetzt DIN 433

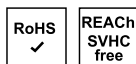

für Schrauben M

2	S 2000	6,50 A2
2,5	S 2000	4,30 A2
3	S 2000	2,10 A2
4	S 2000	2,35 A2
5	S 2000	3,35 A2
6	S 1000	4,95 A2
8	S 1000	9,90 A2
10	S 1000	12,20 A2
12	S 100	20,10 A2
14	S 100	31,50 A2
16	S 50	40,50 A2

Abmessungen	VE Stück	€/100/Obf.
ISO 07092.944		
7092	A 4 200 HV	

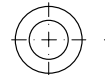

Flache Scheiben, kleine Reihe, Produktklasse A

vorzugsweise für Zylinderschrauben

Maße → **TI-84** Normumstellung → **TI-84**
 Werkstoffeigensch. → **TI-236**
 Stahl → **S. 338**
 Messing → **S. 641**
 ISO 7092 → ersetzt DIN 433

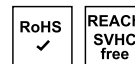

für Schrauben M

3	S 2000	3,25 A4
4	S 2000	4,35 A4
5	S 2000	5,30 A4
6	S 1000	8,10 A4
8	S 1000	14,70 A4
10	S 1000	20,00 A4
12	S 100	36,50 A4
16	S 50	64,00 A4
20	S 25	94,00 A4
24	S 25	375,00 A4

Abmessungen	VE Stück	€/100/Obf.
ISO 07093.924		
7093-1	A 2 200 HV	

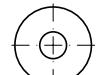

Flache Scheiben, große Reihe, Produktklasse A

Maße → **TI-85** Normumstellung → **TI-84**
 Werkstoffeigensch. → **TI-236**
 Stahl → **S. 338**
 Messing → **S. 641**
 ISO 7093 → ersetzt DIN 9021

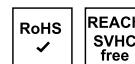

für Schrauben M

3	S 1000	27,50 A2
3	K 200	32,50 A2
4	S 1000	32,50 A2
4	K 200	36,00 A2
5	S 1000	40,00 A2
5	K 200	45,50 A2
6	S 1000	45,50 A2
6	K 200	53,00 A2
8	S 500	52,00 A2
8	K 100	59,00 A2
10	S 250	57,00 A2
10	K 50	71,00 A2
12	S 250	186,00 A2
12	K 50	224,00 A2
14	S 100	154,00 A2
16	S 100	226,00 A2

Abmessungen	VE	Stück	€/100/Obf.
16	K	25	265,00 A2
18	S	100	295,00 A2
20	S	50	670,00 A2
20	K	10	760,00 A2
24	S	25	860,00 A2

ISO	07093.944
7093-1	A 4 200 HV

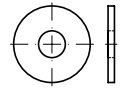

Flache Scheiben, große Reihe, Produktklasse A

Maße → **TI-85** Normumstellung → **TI-84**
 Werkstoffeigensch. → **TI-236**
 Stahl → **S. 338**
 Messing → **S. 641**

ISO 7093 → ersetzt DIN 9021



für Schrauben M

Abm.	VE	Stück	€/100/Obf.
3	S	1000	46,50 A4
4	S	1000	61,00 A4
5	S	100	61,00 A4
6	S	100	126,00 A4
8	S	100	158,00 A4
10	S	100	200,00 A4
12	S	100	475,00 A4
14	S	100	720,00 A4
16	S	100	910,00 A4
18	S	50	2400,00 A4
20	S	50	2550,00 A4
22	S	10	3700,00 A4
24	S	10	4800,00 A4

ISO	07093.954
7093-1	A 5 200 HV

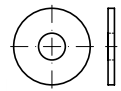

Flache Scheiben, große Reihe, Produktklasse A

Maße → **TI-85** Normumstellung → **TI-84**
 Werkstoffeigensch. → **TI-236**
 Stahl → **S. 338**
 Messing → **S. 641**

ISO 7093 → ersetzt DIN 9021



für Schrauben M

Abm.	VE	Stück	€/100/Obf.
5	S	100	61,00 A5
6	S	100	126,00 A5
8	S	100	158,00 A5
10	S	100	200,00 A5
12	S	100	475,00 A5
16	S	100	910,00 A5
20	S	50	2550,00 A5
24	S	10	4800,00 A5

Abmessungen	VE	Stück	€/100/Obf.
ISO	07094.920		
7094			A 2 100 HV



Flache Scheiben, extra große Reihe, Produktklasse C

vorwiegend für Holzkonstruktionen

Maße → **TI-84** Normumstellung → **TI-84**
 Werkstoffeigensch. → **TI-236**
 Stahl → **S. 338**

ISO 7094 → ersetzt DIN 440 Form R (austauschbar)



für Schrauben M

Abm.	VE	Stück	€/100/Obf.
5	S	100	15,20 A2
6	S	100	20,90 A2
8	S	100	49,50 A2
10	S	50	72,00 A2
12	S	50	159,00 A2
16	S	50	305,00 A2
20	S	50	640,00 A2

ISO	07094.940
7094	A 4 100 HV



Flache Scheiben, extra große Reihe, Produktklasse C

vorwiegend für Holzkonstruktionen

Maße → **TI-84** Normumstellung → **TI-84**
 Werkstoffeigensch. → **TI-236**
 Stahl → **S. 338**

ISO 7094 → ersetzt DIN 440 Form R (austauschbar)



für Schrauben M

Abm.	VE	Stück	€/100/Obf.
5	S	100	64,00 A4
6	S	100	89,00 A4
8	S	100	196,00 A4
10	S	50	305,00 A4
12	S	50	475,00 A4
16	S	50	1520,00 A4
20	S	50	2230,00 A4

Abmessungen	VE	Stück	€/100/Obf.
DIN	07343.960		
7343			1.4310

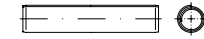

Spiral-Spannstifte, Regelausführung

Achtung! Reduzierte Federkräfte.

Maße → **TI-121** Normumstellung → **TI-10**
 Werkstoffeigensch. → **TI-236**
 Federstahl → **S. 339**

DIN 7343 → wird ersetzt durch ISO 8750 (austauschbar)

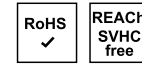

Abm.	VE	Stück	€/100/Obf.
1	x	6	S 1000 15,00
1	x	10	S 1000 16,10
1	x	12	S 1000 17,10
1,5	x	5	S 1000 14,60
1,5	x	6	S 1000 14,80
1,5	x	8	S 1000 15,20
1,5	x	10	S 1000 16,10
1,5	x	12	S 1000 17,10
2	x	4	S 1000 14,60
2	x	5	S 1000 15,20
2	x	6	S 1000 15,60
2	x	8	S 1000 16,10
2	x	10	S 1000 17,10
2	x	12	S 1000 17,50
2	x	14	S 1000 18,00
2	x	16	S 1000 19,20
2	x	18	S 1000 19,70
2	x	20	S 1000 21,10
2,5	x	5	S 1000 16,50
2,5	x	6	S 1000 17,10
2,5	x	8	S 1000 17,50
2,5	x	10	S 1000 18,00
2,5	x	12	S 1000 19,20
2,5	x	14	S 1000 19,70
2,5	x	16	S 1000 21,10
2,5	x	18	S 1000 23,10
2,5	x	20	S 1000 24,50
2,5	x	22	S 1000 25,50
2,5	x	24	S 1000 27,00
3	x	8	S 1000 23,10
3	x	10	S 1000 24,50
3	x	12	S 1000 26,50
3	x	14	S 1000 30,50
3	x	16	S 1000 31,50
3	x	18	S 1000 33,00
3	x	20	S 1000 34,00
3	x	22	S 1000 38,00
3	x	24	S 1000 39,50
3	x	26	S 1000 42,00
3	x	28	S 1000 44,00
3	x	30	S 1000 46,00
3	x	32	S 1000 47,50
4	x	8	S 500 31,50
4	x	10	S 500 32,00
4	x	12	S 500 36,00
4	x	14	S 500 40,50
4	x	16	S 500 44,50
4	x	18	S 500 47,00
4	x	20	S 500 53,00
4	x	22	S 500 56,00

Abmessungen	VE	Stück	€/100/Obf.
4 x 24	S	500	60,00
4 x 26	S	500	63,00
4 x 28	S	500	66,00
4 x 30	S	500	69,00
4 x 32	S	500	73,00
4 x 35	S	500	78,00
4 x 40	S	500	88,00
4 x 45	S	500	101,00
4 x 50	S	500	110,00
5 x 12	S	500	49,50
5 x 14	S	500	54,00
5 x 16	S	500	60,00
5 x 18	S	500	66,00
5 x 20	S	500	71,00
5 x 22	S	500	76,00
5 x 24	S	500	82,00
5 x 26	S	500	88,00
5 x 28	S	500	92,00
5 x 30	S	500	101,00
5 x 32	S	500	105,00
5 x 35	S	500	116,00
5 x 40	S	500	125,00
5 x 45	S	500	139,00
5 x 50	S	250	152,00
6 x 12	S	500	64,00
6 x 14	S	500	70,00
6 x 16	S	500	77,00
6 x 18	S	500	84,00
6 x 20	S	500	89,00
6 x 22	S	500	99,00
6 x 24	S	500	105,00
6 x 26	S	500	112,00
6 x 28	S	500	118,00
6 x 30	S	500	129,00
6 x 32	S	500	133,00
6 x 35	S	500	148,00
6 x 40	S	250	161,00
6 x 45	S	250	178,00
6 x 50	S	250	195,00
8 x 16	S	500	93,00
8 x 18	S	500	103,00
8 x 20	S	500	112,00
8 x 22	S	500	122,00
8 x 24	S	500	129,00
8 x 26	S	500	139,00
8 x 28	S	500	148,00
8 x 30	S	500	158,00
8 x 32	S	500	167,00
8 x 35	S	500	186,00
8 x 40	S	250	205,00
8 x 45	S	250	229,00
8 x 50	S	250	250,00

Abmessungen	VE	Stück	€/100/Obf.
DIN 07349.920			
7349			A 2 100 HV



Scheiben für Schrauben mit schweren Spannstiften

Maße → **TI-85** Werkstoffeigensch. → **TI-236**
 Stahl → **S. 341**



Innen Ø x Außen Ø x Dicke

3,2 x 9 x 1	S	100	13,70 A2
4,3 x 12 x 1,6	S	100	14,40 A2
5,3 x 15 x 2	S	100	23,30 A2
6,4 x 17 x 3	S	100	43,50 A2
8,4 x 21 x 4	S	100	79,00 A2
10,5 x 25 x 4	S	100	112,00 A2
13 x 30 x 6	S	50	265,00 A2
17 x 40 x 6	S	50	395,00 A2
21 x 44 x 8	S	25	730,00 A2
25 x 50 x 10	S	25	1130,00 A2

Abmessungen	VE	Stück	€/100/Obf.
DIN 07349.940			
7349			A 4 100 HV



Scheiben für Schrauben mit schweren Spannstiften

Maße → **TI-85** Werkstoffeigensch. → **TI-236**
 Stahl → **S. 341**

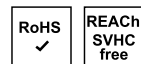

Innen Ø x Außen Ø x Dicke

8,4 x 21 x 4	S	100	102,00 A4
10,5 x 25 x 4	S	50	145,00 A4
13 x 30 x 6	S	50	360,00 A4
17 x 40 x 6	S	50	510,00 A4
21 x 44 x 8	S	25	890,00 A4
25 x 50 x 10	S	10	1870,00 A4

Abmessungen	VE	Stück	€/100/Obf.
~ISO 07379.920			
7379			A 2 f9

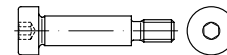

Passschultherschrauben, Außen-Nennmaße = ISO 7379, Schaftpassung f9

Maße → **TI-13** Werkstoffeigensch. → **TI-236**
 Stahl → **S. 342**

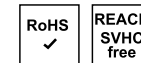

Schaft Ø / Gewinde M x Schaftlänge

6 f9 M 5 x 10	S	50	640,00 A2
6 f9 M 5 x 12	S	50	690,00 A2
6 f9 M 5 x 16	S	50	760,00 A2
6 f9 M 5 x 20	S	50	810,00 A2
6 f9 M 5 x 25	S	50	860,00 A2
8 f9 M 6 x 12	S	50	860,00 A2
8 f9 M 6 x 16	S	50	910,00 A2
8 f9 M 6 x 20	S	50	970,00 A2
8 f9 M 6 x 25	S	50	1030,00 A2
10 f9 M 8 x 16	S	50	1350,00 A2
10 f9 M 8 x 20	S	50	1440,00 A2
10 f9 M 8 x 25	S	50	1580,00 A2
10 f9 M 8 x 30	S	50	1710,00 A2
12 f9 M 10 x 20	S	50	2030,00 A2
12 f9 M 10 x 25	S	50	2200,00 A2
12 f9 M 10 x 30	S	50	2290,00 A2
12 f9 M 10 x 40	S	50	2600,00 A2
16 f9 M 12 x 30	S	25	4850,00 A2
16 f9 M 12 x 40	S	25	5400,00 A2
16 f9 M 12 x 50	S	25	6200,00 A2

Abmessungen	VE	Stück	€/100/Obf.
ISO 07380.920			
7380-1			A 2

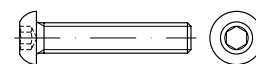

Flachkopfschrauben mit Innensechskant

einige Fabrikate Gewinde bis Kopf

Achtung! Schrauben nur eingeschränkt belastbar.

Maße → **TI-14** Anziehmomente → **TI-246, 249**
 Werkstoffeigensch. → **TI-232**

Stahl → **S. 342**



M 3 x 4	S	500	63,00 A2
M 3 x 5	S	500	63,00 A2
M 3 x 6	S	500	52,00 A2
M 3 x 8	S	500	52,00 A2
M 3 x 10	S	500	52,00 A2
M 3 x 12	S	500	52,00 A2
M 3 x 16	S	500	56,00 A2
M 3 x 20	S	500	56,00 A2

Abmessungen	VE	Stück	€/100/Obf.
M 3 x 25	S	500	60,00A2
M 4 x 4	S	500	94,00A2
M 4 x 5	S	500	87,00A2
M 4 x 6	S	500	60,00A2
M 4 x 8	S	500	60,00A2
M 4 x 10	S	500	60,00A2
M 4 x 12	S	500	60,00A2
M 4 x 16	S	500	63,00A2
M 4 x 20	S	500	63,00A2
M 4 x 25	S	500	63,00A2
M 4 x 30	S	500	67,00A2
M 4 x 35	S	200	71,00A2
M 5 x 6	S	500	60,00A2
M 5 x 8	S	500	56,00A2
M 5 x 10	S	500	56,00A2
M 5 x 12	S	500	56,00A2
M 5 x 16	S	500	56,00A2
M 5 x 20	S	500	60,00A2
M 5 x 25	S	500	60,00A2
M 5 x 30	S	500	60,00A2
M 5 x 40	S	500	63,00A2
M 5 x 45	S	200	67,00A2
M 6 x 8	S	500	56,00A2
M 6 x 10	S	500	56,00A2
M 6 x 12	S	500	56,00A2
M 6 x 16	S	500	60,00A2
M 6 x 20	S	500	60,00A2
M 6 x 25	S	500	63,00A2
M 6 x 30	S	500	67,00A2
M 6 x 35	S	200	114,00A2
M 6 x 40	S	200	127,00A2
M 6 x 45	S	200	151,00A2
M 6 x 50	S	200	168,00A2
M 6 x 55	S	200	197,00A2
M 6 x 60	S	200	209,00A2
M 8 x 10	S	200	94,00A2
M 8 x 12	S	200	94,00A2
M 8 x 16	S	200	94,00A2
M 8 x 20	S	200	102,00A2
M 8 x 25	S	200	106,00A2
M 8 x 30	S	200	137,00A2
M 8 x 35	S	200	156,00A2
M 8 x 40	S	200	168,00A2
M 8 x 45	S	200	169,00A2
M 8 x 50	S	200	175,00A2
M 8 x 60	S	200	178,00A2
M 10 x 16	S	200	154,00A2
M 10 x 20	S	200	155,00A2
M 10 x 25	S	200	175,00A2
M 10 x 30	S	200	195,00A2
M 10 x 40	S	100	199,00A2
M 10 x 50	S	100	224,00A2

Abmessungen	VE	Stück	€/100/Obf.
~ISO		07380.921	
7380-1	A 2		ISR

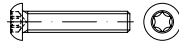

Flachkopfschrauben, ISR = Innensechsrund, mit Gewinde bis Kopf

~DIN 34805-1

Achtung! Schrauben nur eingeschränkt belastbar.

Maße → **TI-14** Anziehmomente → **TI-246, 249**
 Werkstoffeigensch. → **TI-232**

Stahl → **S. 343**

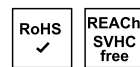

M 3 x 4 -T10	S	500	63,00A2
M 3 x 5 -T10	S	500	63,00A2
M 3 x 6 -T10	S	500	52,00A2
M 3 x 8 -T10	S	500	52,00A2
M 3 x 10 -T10	S	500	52,00A2
M 3 x 12 -T10	S	500	52,00A2
M 3 x 16 -T10	S	500	56,00A2
M 3 x 20 -T10	S	500	56,00A2
M 3 x 25 -T10	S	500	60,00A2
M 3 x 30 -T10	S	500	63,00A2
M 3 x 35 -T10	S	500	67,00A2
M 3 x 40 -T10	S	500	72,00A2
M 4 x 4 -T20	S	500	94,00A2
M 4 x 5 -T20	S	500	87,00A2
M 4 x 6 -T20	S	500	60,00A2
M 4 x 8 -T20	S	500	60,00A2
M 4 x 10 -T20	S	500	60,00A2
M 4 x 12 -T20	S	500	60,00A2
M 4 x 16 -T20	S	500	63,00A2
M 4 x 20 -T20	S	500	63,00A2
M 4 x 25 -T20	S	500	63,00A2
M 4 x 30 -T20	S	500	67,00A2
M 4 x 35 -T20	S	200	71,00A2
M 4 x 40 -T20	S	200	75,00A2
M 4 x 45 -T20	S	200	78,00A2
M 4 x 50 -T20	S	200	84,00A2
M 5 x 6 -T25	S	500	60,00A2
M 5 x 8 -T25	S	500	56,00A2
M 5 x 10 -T25	S	500	56,00A2
M 5 x 12 -T25	S	500	56,00A2
M 5 x 16 -T25	S	500	56,00A2
M 5 x 20 -T25	S	500	60,00A2
M 5 x 25 -T25	S	500	60,00A2
M 5 x 30 -T25	S	500	60,00A2
M 5 x 35 -T25	S	200	61,00A2
M 5 x 40 -T25	S	200	63,00A2
M 5 x 45 -T25	S	200	67,00A2
M 5 x 50 -T25	S	200	72,00A2
M 6 x 8 -T30	S	500	56,00A2
M 6 x 10 -T30	S	500	56,00A2
M 6 x 12 -T30	S	500	56,00A2
M 6 x 16 -T30	S	500	60,00A2
M 6 x 20 -T30	S	500	60,00A2
M 6 x 25 -T30	S	500	63,00A2
M 6 x 30 -T30	S	500	67,00A2
M 6 x 35 -T30	S	200	114,00A2
M 6 x 40 -T30	S	200	127,00A2
M 6 x 45 -T30	S	200	151,00A2
M 6 x 50 -T30	S	200	168,00A2

Abmessungen	VE	Stück	€/100/Obf.
M 6 x 55 -T30	S	200	181,00A2
M 6 x 60 -T30	S	200	209,00A2
M 8 x 10 -T40	S	200	94,00A2
M 8 x 12 -T40	S	200	94,00A2
M 8 x 16 -T40	S	200	94,00A2
M 8 x 20 -T40	S	200	102,00A2
M 8 x 25 -T40	S	200	106,00A2
M 8 x 30 -T40	S	200	137,00A2
M 8 x 35 -T40	S	200	156,00A2
M 8 x 40 -T40	S	200	168,00A2
M 8 x 45 -T40	S	200	169,00A2
M 8 x 50 -T40	S	200	175,00A2
M 8 x 55 -T40	S	200	177,00A2
M 8 x 60 -T40	S	200	178,00A2
M 10 x 16 -T50	S	200	154,00A2
M 10 x 20 -T50	S	200	155,00A2
M 10 x 25 -T50	S	200	175,00A2
M 10 x 30 -T50	S	200	195,00A2
M 10 x 35 -T50	S	200	197,00A2
M 10 x 40 -T50	S	100	199,00A2
M 10 x 45 -T50	S	100	213,00A2
M 10 x 50 -T50	S	100	224,00A2

Abmessungen	VE	Stück	€/100/Obf.
ISO		07380.922	
7380-2	A 2		



Flachkopfschrauben mit Innensechskant und Bund

einige Fabrikate mit Gewinde bis Kopf

Achtung! Schrauben nur eingeschränkt belastbar.

Maße → **TI-14** Anziehmomente → **TI-246, 249**
 Werkstoffeigensch. → **TI-232**

Stahl → **S. 344**

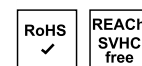

M 3 x 6	S	500	122,00A2
M 3 x 8	S	500	139,00A2
M 3 x 10	S	500	148,00A2
M 4 x 6	S	500	156,00A2
M 4 x 8	S	500	156,00A2
M 4 x 10	S	500	140,00A2
M 4 x 12	S	500	142,00A2
M 4 x 16	S	500	148,00A2
M 4 x 20	S	500	163,00A2
M 4 x 25	S	500	178,00A2
M 5 x 6	S	500	161,00A2
M 5 x 8	S	500	161,00A2
M 5 x 10	S	500	149,00A2
M 5 x 12	S	500	152,00A2
M 5 x 16	S	500	167,00A2
M 5 x 20	S	500	184,00A2
M 5 x 25	S	500	194,00A2
M 6 x 8	S	500	148,00A2
M 6 x 10	S	500	154,00A2
M 6 x 12	S	500	171,00A2
M 6 x 16	S	500	194,00A2
M 6 x 20	S	500	218,00A2
M 6 x 25	S	500	247,00A2
M 6 x 30	S	500	280,00A2
M 6 x 35	S	200	305,00A2
M 6 x 40	S	200	330,00A2
M 6 x 45	S	200	350,00A2

Abmessungen	VE	Stück	€/100/Obf.
M 8 x 10	S	200	300,00A2
M 8 x 12	S	200	290,00A2
M 8 x 16	S	200	315,00A2
M 8 x 20	S	200	385,00A2
M 8 x 25	S	200	455,00A2

~ISO 07380.924

7380-2 A 2 **ISR**



Flachkopfschrauben mit Bund, ISR = Innensechsrund, mit Gewinde bis Kopf

~DIN 34805-2

Achtung! Schrauben nur eingeschränkt belastbar.

Maße → **TI-14** Anziehmomente → **TI-246, 249**
 Werkstoffeigensch. → **TI-232**

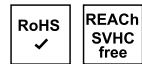

M 3 x 4-T10	S	500	110,00A2
M 3 x 5-T10	S	500	116,00A2
M 3 x 6-T10	S	500	122,00A2
M 3 x 8-T10	S	500	139,00A2
M 3 x 10-T10	S	500	148,00A2
M 3 x 12-T10	S	500	155,00A2
M 3 x 16-T10	S	500	159,00A2
M 3 x 20-T10	S	500	164,00A2
M 3 x 25-T10	S	500	167,00A2
M 3 x 30-T10	S	500	173,00A2
M 3 x 35-T10	S	500	177,00A2
M 3 x 40-T10	S	500	179,00A2
M 4 x 4-T20	S	500	144,00A2
M 4 x 5-T20	S	500	151,00A2
M 4 x 6-T20	S	500	156,00A2
M 4 x 8-T20	S	500	156,00A2
M 4 x 10-T20	S	500	140,00A2
M 4 x 12-T20	S	500	142,00A2
M 4 x 16-T20	S	500	148,00A2
M 4 x 20-T20	S	500	163,00A2
M 4 x 25-T20	S	500	178,00A2
M 4 x 30-T20	S	500	187,00A2
M 4 x 35-T20	S	200	199,00A2
M 4 x 40-T20	S	200	208,00A2
M 4 x 45-T20	S	200	215,00A2
M 4 x 50-T20	S	200	220,00A2
M 5 x 6-T25	S	500	161,00A2
M 5 x 8-T25	S	500	161,00A2
M 5 x 10-T25	S	500	149,00A2
M 5 x 12-T25	S	500	152,00A2
M 5 x 16-T25	S	500	167,00A2
M 5 x 20-T25	S	500	184,00A2
M 5 x 25-T25	S	500	194,00A2
M 5 x 30-T25	S	500	207,00A2
M 5 x 35-T25	S	200	213,00A2
M 5 x 40-T25	S	200	218,00A2
M 5 x 45-T25	S	200	227,00A2
M 5 x 50-T25	S	200	239,00A2
M 6 x 8-T30	S	500	148,00A2
M 6 x 10-T30	S	500	154,00A2
M 6 x 12-T30	S	500	171,00A2
M 6 x 16-T30	S	500	194,00A2
M 6 x 20-T30	S	500	218,00A2
M 6 x 25-T30	S	500	247,00A2
M 6 x 30-T30	S	500	280,00A2

Abmessungen	VE	Stück	€/100/Obf.
M 6 x 35-T30	S	200	305,00A2
M 6 x 40-T30	S	200	330,00A2
M 6 x 45-T30	S	200	350,00A2
M 6 x 50-T30	S	200	370,00A2
M 6 x 55-T30	S	200	400,00A2
M 6 x 60-T30	S	200	420,00A2
M 8 x 10-T40	S	200	300,00A2
M 8 x 12-T40	S	200	290,00A2
M 8 x 16-T40	S	200	315,00A2
M 8 x 20-T40	S	200	385,00A2
M 8 x 25-T40	S	200	455,00A2
M 8 x 30-T40	S	200	470,00A2
M 8 x 35-T40	S	200	480,00A2
M 8 x 40-T40	S	200	495,00A2
M 8 x 45-T40	S	200	495,00A2
M 8 x 50-T40	S	200	510,00A2
M 8 x 55-T40	S	200	530,00A2
M 8 x 60-T40	S	200	540,00A2
M 10 x 16-T50	S	200	400,00A2
M 10 x 20-T50	S	200	415,00A2
M 10 x 25-T50	S	200	430,00A2
M 10 x 30-T50	S	200	445,00A2
M 10 x 35-T50	S	200	470,00A2
M 10 x 40-T50	S	100	495,00A2
M 10 x 45-T50	S	100	510,00A2
M 10 x 50-T50	S	100	530,00A2
M 10 x 55-T50	S	100	550,00A2

ISO 07434.910

7434 A 1

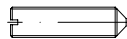

Gewindestifte mit Spitze und Schlitz

Maße → **TI-19** Normumstellung → **TI-6**
 Werkstoffeigensch. → **TI-236**
 Stahl → **S. 345**
 Messing → **S. 641**

ISO 7434 → ersetzt DIN 553 (austauschbar)



M 2 x 3	S	50	29,00A1
M 2 x 4	S	50	30,50A1
M 2,5 x 5	S	50	31,50A1
M 2,5 x 6	S	50	32,50A1
M 2,5 x 8	S	50	33,00A1
M 3 x 4	S	50	30,00A1
M 3 x 5	S	50	31,50A1
M 3 x 6	S	50	33,50A1
M 3 x 8	S	50	35,50A1
M 4 x 5	S	50	33,00A1
M 4 x 6	S	50	34,50A1
M 4 x 8	S	50	36,50A1
M 4 x 10	S	50	38,50A1
M 4 x 12	S	50	40,50A1
M 4 x 16	S	50	42,50A1
M 5 x 5	S	50	35,50A1
M 5 x 6	S	50	37,50A1
M 5 x 8	S	50	40,00A1
M 5 x 10	S	50	42,00A1
M 5 x 12	S	50	44,50A1
M 5 x 16	S	50	49,50A1
M 6 x 6	S	25	45,00A1
M 6 x 8	S	25	46,50A1
M 6 x 10	S	25	51,00A1
M 6 x 12	S	25	53,00A1

Abmessungen	VE	Stück	€/100/Obf.
M 6 x 16	S	25	57,00A1
M 6 x 20	S	25	65,00A1
M 6 x 25	S	25	75,00A1

ISO 07434.940

7434 A 4

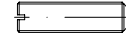

Gewindestifte mit Spitze und Schlitz

Maße → **TI-19** Normumstellung → **TI-6**
 Werkstoffeigensch. → **TI-236**
 Stahl → **S. 345**
 Messing → **S. 641**

ISO 7434 → ersetzt DIN 553 (austauschbar)

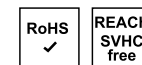

M 4 x 6	S	50	98,00A4
M 4 x 8	S	50	104,00A4
M 4 x 10	S	50	112,00A4
M 5 x 5	S	50	101,00A4
M 5 x 6	S	50	107,00A4
M 5 x 8	S	50	116,00A4
M 5 x 10	S	50	122,00A4
M 5 x 16	S	25	152,00A4
M 6 x 6	S	25	126,00A4
M 6 x 8	S	25	131,00A4
M 6 x 10	S	25	141,00A4
M 6 x 12	S	25	152,00A4
M 6 x 16	S	25	160,00A4
M 8 x 12	S	25	227,00A4
M 8 x 16	S	25	250,00A4
M 8 x 20	S	25	300,00A4
M 8 x 25	S	25	355,00A4

DIN 07604.941

7604 A 4 **Form A**

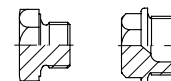

bis M16 ab M18

Verschlusschrauben mit Bund und Außensechskant, leichte Ausführung, mit zylindrischem Feingewinde, A = kurzer Einschraubzapfen

Maße → **TI-24** Werkstoffeigensch. → **TI-236**
 Stahl → **S. 351**

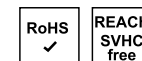

AM 10 x 1	S	10	1580,00A4
AM 12 x 1,5	S	10	2460,00A4
AM 14 x 1,5	S	10	2750,00A4
AM 16 x 1,5	S	1	2900,00A4
AM 18 x 1,5	S	1	6400,00A4
AM 22 x 1,5	S	1	7200,00A4

Abmessungen	VE Stück	€/100/Obf.
~DIN	07964.924	
7964	A 2	K-D1

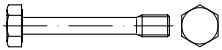

Sechskantschrauben mit dünnem Schaft, kurzem Gewinde, ISO-Schlüsselweiten

Maße → [TI-17](#) Werkstoffeigensch. → [TI-236](#)

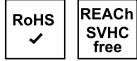

Gewinde Ø x Länge/Gewindelänge

M 8	x 20/10	S 100	320,00 A2
M 8	x 30/10	S 100	330,00 A2
M 10	x 25/12,5	S 50	420,00 A2
M 10	x 35/12,5	S 50	435,00 A2

~DIN	07967.960
7967	1.4310

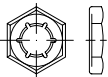

Sicherungsmuttern (Palmuttern)

Achtung! Reduzierte Federkräfte.

Maße → [TI-68](#) Schraubensicherung → [TI-256](#)

Werkstoffeigensch. → [TI-236](#)

Federstahl → [S. 352](#)

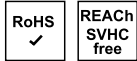

M 6	S 100	57,00
M 8	S 100	64,00
M 10	S 100	77,00
M 12	S 100	94,00
M 16	S 100	118,00
M 20	S 100	203,00
M 24	S 100	260,00
M 30	S 50	3150,00

Abmessungen	VE Stück	€/100/Obf.
~DIN	07967.940	
7967	A 4	



Sicherungsmuttern (Palmuttern)

Achtung! Reduzierte Federkräfte.

Maße → [TI-68](#) Schraubensicherung → [TI-256](#)

Werkstoffeigensch. → [TI-236](#)

Federstahl → [S. 352](#)

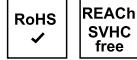

M 6	S 100	129,00 A4
M 8	S 100	137,00 A4
M 10	S 100	158,00 A4
M 12	S 100	179,00 A4
M 16	S 100	242,00 A4
M 20	S 50	420,00 A4
M 24	S 50	530,00 A4
M 27	S 10	5300,00 A4
M 30	S 10	6300,00 A4

Artikel	88312.920
88312	A 2 Form C



Zylinder-Blechschraben mit Innensechskant C = mit Spitze

Achtung! Härte werkstoffbedingt nur ~ 250 HV.

Maße → [TI-50](#) Montage → [TI-251](#)

Werkstoffeigensch. → [TI-236](#)

Kopfmaße wie DIN 912/ISO 4762

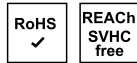

C 4,8	x 13	S 200	72,00 A2
C 4,8	x 16	S 1000	73,00 A2
C 4,8	x 19	S 1000	75,00 A2
C 4,8	x 22	S 200	83,00 A2
C 4,8	x 25	S 1000	84,00 A2
C 4,8	x 32	S 500	90,00 A2
C 4,8	x 38	S 500	103,00 A2
C 4,8	x 45	S 200	125,00 A2
C 4,8	x 50	S 200	156,00 A2
C 4,8	x 60	S 200	186,00 A2
C 4,8	x 70	S 200	218,00 A2
C 5,5	x 16	S 200	82,00 A2
C 5,5	x 19	S 500	83,00 A2
C 5,5	x 22	S 200	91,00 A2
C 5,5	x 25	S 200	95,00 A2
C 5,5	x 32	S 200	106,00 A2
C 5,5	x 38	S 250	118,00 A2
C 5,5	x 45	S 250	127,00 A2
C 5,5	x 50	S 200	161,00 A2
C 5,5	x 60	S 200	194,00 A2

Abmessungen	VE Stück	€/100/Obf.	
C 5,5	x 70	S 200	229,00 A2
C 6,3	x 16	S 200	88,00 A2
C 6,3	x 19	S 200	93,00 A2
C 6,3	x 22	S 200	99,00 A2
C 6,3	x 25	S 500	108,00 A2
C 6,3	x 32	S 200	118,00 A2
C 6,3	x 38	S 200	127,00 A2
C 6,3	x 45	S 200	130,00 A2
C 6,3	x 50	S 250	165,00 A2
C 6,3	x 60	S 200	199,00 A2
C 6,3	x 70	S 200	243,00 A2

DIN	07976.923
7976	A 2 Form C



Sechskant-Blechschraben, C = mit Spitze

Achtung! Härte werkstoffbedingt nur ~ 250 HV.

Maße → [TI-46](#) Montage → [TI-251](#)

Werkstoffeigensch. → [TI-236](#) Normumstellung → [TI-11](#)

Stahl → [S. 354](#)

DIN 7976 → wird ersetzt durch ISO 1479

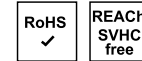

C 2,9	x 9,5	S 1000	10,30 A2
C 2,9	x 13	S 1000	11,60 A2
C 2,9	x 16	S 1000	12,20 A2
C 2,9	x 19	S 1000	13,50 A2
C 2,9	x 22	S 1000	16,50 A2
C 2,9	x 25	S 1000	18,60 A2
C 2,9	x 32	S 1000	22,80 A2
C 3,5	x 9,5	S 1000	12,50 A2
C 3,5	x 13	S 1000	12,70 A2
C 3,5	x 16	S 1000	13,50 A2
C 3,5	x 19	S 1000	15,00 A2
C 3,5	x 22	S 1000	17,60 A2
C 3,5	x 25	S 1000	20,30 A2
C 3,5	x 32	S 1000	24,30 A2
C 3,5	x 38	S 1000	27,00 A2
C 3,9	x 9,5	S 1000	14,60 A2
C 3,9	x 13	S 1000	14,40 A2
C 3,9	x 16	S 1000	15,20 A2
C 3,9	x 19	S 1000	15,60 A2
C 3,9	x 22	S 500	20,10 A2
C 3,9	x 25	S 500	22,40 A2
C 3,9	x 32	S 500	26,00 A2
C 3,9	x 38	S 500	30,00 A2
C 3,9	x 45	S 500	33,50 A2
C 3,9	x 50	S 500	35,00 A2
C 4,2	x 9,5	S 1000	15,90 A2
C 4,2	x 13	S 1000	15,60 A2
C 4,2	x 16	S 1000	16,10 A2
C 4,2	x 19	S 1000	17,60 A2
C 4,2	x 22	S 500	22,60 A2
C 4,2	x 25	S 500	23,10 A2
C 4,2	x 32	S 500	28,50 A2
C 4,2	x 38	S 500	32,00 A2
C 4,2	x 45	S 500	39,00 A2
C 4,2	x 50	S 500	46,00 A2
C 4,8	x 13	S 1000	19,90 A2
C 4,8	x 16	S 1000	21,40 A2
C 4,8	x 19	S 1000	22,60 A2
C 4,8	x 22	S 1000	25,50 A2

Abmessungen	VE	Stück	€/100/Obf.
C 4,8 x 25	S	1000	28,00A2
C 4,8 x 32	S	500	34,50A2
C 4,8 x 38	S	500	37,00A2
C 4,8 x 45	S	500	47,50A2
C 4,8 x 50	S	250	56,00A2
C 5,5 x 13	S	500	31,50A2
C 5,5 x 16	S	500	32,50A2
C 5,5 x 19	S	500	34,50A2
C 5,5 x 22	S	500	39,50A2
C 5,5 x 25	S	250	43,00A2
C 5,5 x 32	S	250	49,50A2
C 5,5 x 38	S	250	56,00A2
C 5,5 x 45	S	250	63,00A2
C 5,5 x 50	S	250	69,00A2
C 6,3 x 13	S	250	45,50A2
C 6,3 x 16	S	500	45,50A2
C 6,3 x 19	S	500	48,50A2
C 6,3 x 22	S	500	55,00A2
C 6,3 x 25	S	500	59,00A2
C 6,3 x 32	S	250	65,00A2
C 6,3 x 38	S	250	72,00A2
C 6,3 x 45	S	250	81,00A2
C 6,3 x 50	S	250	87,00A2
C 6,3 x 60	S	100	106,00A2
C 6,3 x 70	S	100	148,00A2
C 8 x 16	S	100	86,00A2
C 8 x 19	S	100	95,00A2
C 8 x 22	S	250	97,00A2
C 8 x 25	S	100	148,00A2
C 8 x 32	S	100	157,00A2
C 8 x 38	S	100	211,00A2
C 8 x 45	S	100	285,00A2
C 8 x 50	S	100	390,00A2
C 8 x 60	S	100	530,00A2

~DIN 07980.960
7980 1.4310



Federringe für Zylinderschrauben

Achtung! Reduzierte Federkräfte.

Maße → **TI-100** Werkstoffeigensch. → **TI-236**

Federstahl → **S. 357**



3	S	1000	5,30
3	K	100	8,50
4	S	1000	5,80
4	K	100	8,90
5	S	1000	8,70
5	K	100	11,80
6	S	1000	10,10
6	K	100	13,10
8	S	1000	19,40
8	K	100	22,40
10	S	1000	33,50
10	K	100	37,00
12	S	500	41,00
12	K	100	44,00
16	S	250	97,00
16	K	50	103,00

Abmessungen VE Stück €/100/Obf.
 ~DIN 07980.940
7980 A 4

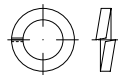

Federringe für Zylinderschrauben

Achtung! Reduzierte Federkräfte.

Maße → **TI-100** Werkstoffeigensch. → **TI-236**

Federstahl → **S. 357**



4	S	1000	8,20A4
4	K	100	11,80A4
5	S	1000	11,60A4
5	K	100	14,90A4
6	S	1000	13,50A4
6	K	100	16,80A4
8	S	1000	30,00A4
8	K	100	33,00A4
10	S	1000	46,00A4
10	K	100	49,50A4
12	S	500	57,00A4
12	K	100	60,00A4
16	S	100	128,00A4
16	K	50	132,00A4
20	S	50	295,00A4

DIN 07981.924
7981 A 2 Form C-H

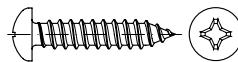

Linsen-Blechschauben mit Phillips-Kreuzschlitz H, C = mit Spitze

Nennlängen ab 60 mm mit Teilgewinde

Achtung! Härte werkstoffbedingt nur ~ 250 HV.

Maße → **TI-46** Montage → **TI-251**
 Werkstoffeigensch. → **TI-236** Normumstellung → **TI-11**

Stahl → **S. 357**

DIN 7981 → wird ersetzt durch ISO 7049



C 2,2 x 4,5-H	S	1000	11,40A2
C 2,2 x 6,5-H	S	1000	11,00A2
C 2,2 x 6,5-H	K	100	14,90A2
C 2,2 x 9,5-H	S	1000	8,70A2
C 2,2 x 13 -H	S	1000	12,40A2
C 2,2 x 16 -H	S	1000	14,20A2
C 2,2 x 19 -H	S	1000	19,00A2
C 2,9 x 6,5-H	K	100	11,00A2
C 2,9 x 6,5-H	S	1000	7,10A2
C 2,9 x 9,5-H	S	1000	4,95A2
C 2,9 x 9,5-H	K	100	8,80A2
C 2,9 x 13 -H	S	1000	5,20A2

Abmessungen	VE	Stück	€/100/Obf.
C 2,9 x 13 -H	K	100	9,00A2
C 2,9 x 16 -H	S	1000	5,70A2
C 2,9 x 16 -H	K	100	9,60A2
C 2,9 x 19 -H	S	1000	6,10A2
C 2,9 x 19 -H	K	100	10,00A2
C 2,9 x 22 -H	S	1000	10,20A2
C 2,9 x 22 -H	K	100	14,00A2
C 2,9 x 25 -H	S	1000	10,60A2
C 2,9 x 25 -H	K	100	14,50A2
C 3,5 x 6,5-H	S	1000	8,00A2
C 3,5 x 9,5-H	S	1000	6,50A2
C 3,5 x 9,5-H	K	100	10,40A2
C 3,5 x 13 -H	S	1000	6,90A2
C 3,5 x 13 -H	K	100	10,70A2
C 3,5 x 16 -H	S	1000	7,20A2
C 3,5 x 16 -H	K	100	11,10A2
C 3,5 x 19 -H	S	1000	8,00A2
C 3,5 x 19 -H	K	100	11,90A2
C 3,5 x 22 -H	S	1000	10,00A2
C 3,5 x 22 -H	K	100	13,90A2
C 3,5 x 25 -H	S	1000	10,40A2
C 3,5 x 25 -H	K	100	14,20A2
C 3,5 x 32 -H	S	1000	11,80A2
C 3,5 x 32 -H	K	100	15,70A2
C 3,5 x 38 -H	S	1000	13,20A2
C 3,5 x 38 -H	K	100	17,10A2
C 3,5 x 45 -H	S	1000	17,10A2
C 3,5 x 50 -H	S	1000	22,80A2
C 3,5 x 60 -H	S	500	31,50A2
C 3,9 x 9,5-H	S	1000	7,80A2
C 3,9 x 9,5-H	K	100	11,70A2
C 3,9 x 13 -H	S	1000	7,80A2
C 3,9 x 13 -H	K	100	11,70A2
C 3,9 x 16 -H	S	1000	8,40A2
C 3,9 x 16 -H	K	100	12,30A2
C 3,9 x 19 -H	S	1000	9,10A2
C 3,9 x 19 -H	K	100	13,00A2
C 3,9 x 22 -H	S	500	11,20A2
C 3,9 x 22 -H	K	100	15,10A2
C 3,9 x 25 -H	S	500	11,60A2
C 3,9 x 25 -H	K	100	15,50A2
C 3,9 x 32 -H	S	500	13,80A2
C 3,9 x 32 -H	K	100	17,60A2
C 3,9 x 38 -H	S	500	15,80A2
C 3,9 x 38 -H	K	100	19,60A2
C 3,9 x 45 -H	S	500	19,50A2
C 3,9 x 50 -H	S	500	23,40A2
C 4,2 x 9,5-H	S	1000	8,80A2
C 4,2 x 9,5-H	K	100	12,60A2
C 4,2 x 13 -H	S	1000	8,90A2
C 4,2 x 13 -H	K	100	12,80A2
C 4,2 x 16 -H	S	1000	10,00A2
C 4,2 x 16 -H	K	100	13,90A2
C 4,2 x 19 -H	S	500	10,90A2
C 4,2 x 19 -H	K	100	14,80A2
C 4,2 x 22 -H	S	500	12,40A2
C 4,2 x 22 -H	K	100	16,20A2
C 4,2 x 25 -H	S	500	12,70A2
C 4,2 x 25 -H	K	100	16,60A2
C 4,2 x 32 -H	S	500	15,80A2
C 4,2 x 32 -H	K	100	19,60A2
C 4,2 x 38 -H	S	500	17,90A2
C 4,2 x 38 -H	K	100	21,80A2
C 4,2 x 45 -H	S	500	26,00A2
C 4,2 x 45 -H	K	100	30,00A2
C 4,2 x 50 -H	S	500	29,50A2
C 4,2 x 50 -H	K	100	33,50A2
C 4,8 x 9,5-H	S	500	11,00A2
C 4,8 x 9,5-H	K	100	14,90A2
C 4,8 x 13 -H	S	500	11,40A2
C 4,8 x 13 -H	K	100	15,30A2
C 4,8 x 16 -H	S	500	12,40A2
C 4,8 x 16 -H	K	100	16,20A2
C 4,8 x 19 -H	S	500	13,80A2
C 4,8 x 19 -H	K	100	17,60A2

Abmessungen	VE	Stück	€/100/Obf.
C 4,8 x 22 -H	S	500	15,80A2
C 4,8 x 22 -H	K	100	19,60A2
C 4,8 x 25 -H	S	500	16,10A2
C 4,8 x 25 -H	K	100	20,00A2
C 4,8 x 32 -H	S	250	20,50A2
C 4,8 x 32 -H	K	100	24,50A2
C 4,8 x 38 -H	S	250	22,90A2
C 4,8 x 38 -H	K	100	27,00A2
C 4,8 x 45 -H	S	250	30,00A2
C 4,8 x 45 -H	K	100	34,00A2
C 4,8 x 50 -H	S	250	31,00A2
C 4,8 x 50 -H	K	100	35,00A2
C 4,8 x 60 -H	S	250	42,00A2
C 4,8 x 70 -H	S	250	55,00A2
C 4,8 x 80 -H	S	100	66,00A2
C 4,8 x 90 -H	S	100	85,00A2
C 4,8 x 100 -H	S	100	107,00A2
C 4,8 x 120 -H	S	100	142,00A2
C 5,5 x 13 -H	S	500	18,50A2
C 5,5 x 13 -H	K	100	22,40A2
C 5,5 x 16 -H	S	500	19,70A2
C 5,5 x 16 -H	K	100	23,60A2
C 5,5 x 19 -H	S	500	21,10A2
C 5,5 x 19 -H	K	100	24,90A2
C 5,5 x 22 -H	S	500	23,10A2
C 5,5 x 22 -H	K	100	27,00A2
C 5,5 x 25 -H	S	500	24,80A2
C 5,5 x 25 -H	K	100	29,00A2
C 5,5 x 32 -H	S	250	29,00A2
C 5,5 x 32 -H	K	100	33,00A2
C 5,5 x 38 -H	S	250	33,00A2
C 5,5 x 38 -H	K	100	37,00A2
C 5,5 x 45 -H	S	250	39,50A2
C 5,5 x 45 -H	K	100	43,50A2
C 5,5 x 50 -H	S	250	44,00A2
C 5,5 x 50 -H	K	100	48,00A2
C 5,5 x 60 -H	S	100	53,00A2
C 5,5 x 70 -H	S	100	61,00A2
C 5,5 x 80 -H	S	100	76,00A2
C 5,5 x 90 -H	S	100	105,00A2
C 5,5 x 100 -H	S	100	129,00A2
C 6,3 x 13 -H	S	250	25,50A2
C 6,3 x 13 -H	K	100	29,50A2
C 6,3 x 16 -H	S	500	21,20A2
C 6,3 x 16 -H	K	100	25,50A2
C 6,3 x 19 -H	S	250	22,80A2
C 6,3 x 19 -H	K	100	27,00A2
C 6,3 x 22 -H	S	250	25,00A2
C 6,3 x 22 -H	K	100	29,00A2
C 6,3 x 25 -H	S	250	26,50A2
C 6,3 x 25 -H	K	100	30,50A2
C 6,3 x 32 -H	S	250	32,00A2
C 6,3 x 32 -H	K	100	36,00A2
C 6,3 x 38 -H	S	250	35,50A2
C 6,3 x 38 -H	K	100	39,50A2
C 6,3 x 45 -H	S	250	42,50A2
C 6,3 x 45 -H	K	100	46,00A2
C 6,3 x 50 -H	S	250	53,00A2
C 6,3 x 50 -H	K	100	57,00A2
C 6,3 x 60 -H	K	100	60,00A2
C 6,3 x 70 -H	K	100	78,00A2
C 6,3 x 80 -H	K	100	103,00A2
C 6,3 x 90 -H	K	100	125,00A2
C 6,3 x 100 -H	K	100	152,00A2

Abmessungen	VE	Stück	€/100/Obf.
C 2,2 x 4,5 -H	S	1000	25,50A4
C 2,2 x 6,5 -H	S	1000	24,40A4
C 2,2 x 9,5 -H	S	1000	19,10A4
C 2,2 x 13 -H	S	1000	27,50A4
C 2,2 x 16 -H	S	1000	31,50A4
C 2,2 x 19 -H	S	1000	38,00A4
C 2,9 x 6,5 -H	S	1000	4,90A4
C 2,9 x 9,5 -H	S	1000	11,00A4
C 2,9 x 13 -H	S	1000	11,40A4
C 2,9 x 16 -H	S	1000	12,60A4
C 2,9 x 19 -H	S	1000	13,50A4
C 2,9 x 22 -H	S	1000	22,50A4
C 2,9 x 25 -H	S	1000	23,50A4
C 3,5 x 6,5 -H	S	1000	14,70A4
C 3,5 x 6,5 -H	K	100	22,10A4
C 3,5 x 9,5 -H	S	1000	14,30A4
C 3,5 x 13 -H	S	1000	13,40A4
C 3,5 x 16 -H	S	1000	13,80A4
C 3,5 x 19 -H	S	1000	17,70A4
C 3,5 x 22 -H	S	1000	23,10A4
C 3,5 x 25 -H	S	1000	25,50A4
C 3,5 x 32 -H	S	1000	27,50A4
C 3,5 x 38 -H	S	1000	31,50A4
C 3,9 x 9,5 -H	S	1000	17,30A4
C 3,9 x 13 -H	S	1000	14,20A4
C 3,9 x 16 -H	S	1000	18,50A4
C 3,9 x 19 -H	S	1000	20,20A4
C 3,9 x 25 -H	S	500	26,00A4
C 3,9 x 32 -H	S	500	30,50A4
C 3,9 x 38 -H	S	500	35,00A4
C 3,9 x 45 -H	S	500	43,50A4
C 3,9 x 50 -H	S	500	52,00A4
C 4,2 x 9,5 -H	S	1000	19,30A4
C 4,2 x 13 -H	S	1000	18,30A4
C 4,2 x 16 -H	S	1000	20,10A4
C 4,2 x 19 -H	S	500	21,80A4
C 4,2 x 22 -H	S	500	27,50A4
C 4,2 x 25 -H	S	500	28,50A4
C 4,2 x 32 -H	S	500	35,00A4
C 4,2 x 38 -H	S	500	40,00A4
C 4,2 x 45 -H	S	500	58,00A4
C 4,2 x 50 -H	S	500	66,00A4
C 4,8 x 9,5 -H	S	500	24,40A4
C 4,8 x 13 -H	S	100	25,50A4
C 4,8 x 16 -H	S	500	27,00A4
C 4,8 x 19 -H	S	500	27,50A4
C 4,8 x 22 -H	S	500	35,00A4
C 4,8 x 25 -H	S	500	33,50A4
C 4,8 x 32 -H	S	250	43,50A4
C 4,8 x 38 -H	S	250	51,00A4

DIN 07981.944
7981 A 4 Form C-H

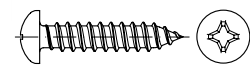

Linsen-Blebschrauben mit Phillips-Kreuzschlitz H, C = mit Spitze

Achtung! Härte werkstoffbedingt nur ~ 250 HV.

Maße → TI-46 Montage → TI-251
 Werkstoffeigensch. → TI-236 Normumstellung → TI-11

Stahl → S. 357

DIN 7981 → wird ersetzt durch ISO 7049

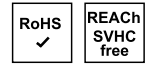

Abmessungen	VE	Stück	€/100/Obf.
C 4,8 x 45 -H	S	250	67,00A4
C 4,8 x 50 -H	S	250	69,00A4
C 4,8 x 60 -H	S	250	93,00A4
C 4,8 x 70 -H	S	250	122,00A4
C 4,8 x 80 -H	S	100	145,00A4
C 4,8 x 90 -H	S	100	187,00A4
C 4,8 x 100 -H	S	100	236,00A4
C 5,5 x 13 -H	S	500	41,00A4
C 5,5 x 16 -H	S	500	44,00A4
C 5,5 x 19 -H	S	500	47,00A4
C 5,5 x 22 -H	S	500	52,00A4
C 5,5 x 25 -H	S	500	55,00A4
C 5,5 x 32 -H	S	250	65,00A4
C 5,5 x 38 -H	S	250	73,00A4
C 5,5 x 45 -H	S	250	87,00A4
C 5,5 x 50 -H	S	250	98,00A4
C 5,5 x 60 -H	S	100	116,00A4
C 6,3 x 13 -H	S	250	56,00A4
C 6,3 x 16 -H	S	500	47,00A4
C 6,3 x 19 -H	S	250	51,00A4
C 6,3 x 22 -H	S	250	56,00A4
C 6,3 x 25 -H	S	250	59,00A4
C 6,3 x 32 -H	S	250	71,00A4
C 6,3 x 38 -H	S	250	79,00A4
C 6,3 x 45 -H	S	250	94,00A4
C 6,3 x 50 -H	S	250	116,00A4

DIN 07981.927
7981 A 2 Form F-H

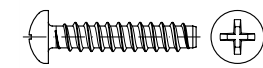

Linsen-Blebschrauben mit Phillips-Kreuzschlitz H, F = mit Zapfen

Achtung! Härte werkstoffbedingt nur ~ 250 HV.

Maße → TI-46 Montage → TI-251
 Werkstoffeigensch. → TI-236 Normumstellung → TI-11

Stahl → S. 359

DIN 7981 → wird ersetzt durch ISO 7049

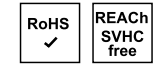

2,9 x 6,5 -F-H	S	1000	14,20A2
2,9 x 9,5 -F-H	S	1000	14,40A2
2,9 x 13 -F-H	S	1000	15,40A2
2,9 x 16 -F-H	S	1000	17,10A2
3,5 x 9,5 -F-H	S	1000	19,40A2
3,5 x 13 -F-H	S	1000	20,50A2
3,5 x 16 -F-H	S	1000	21,60A2
3,9 x 9,5 -F-H	S	1000	23,30A2
3,9 x 13 -F-H	S	1000	23,30A2
4,2 x 9,5 -F-H	S	1000	26,50A2

Abmessungen	VE Stück	€/100/Obf.
Artikel 88981.920		
7981	A 2	Artikel 88981



Kappenkopf-Blehschrauben mit Phillips-Kreuzschlitz H, Form C = mit Spitze

Achtung! Härte werkstoffbedingt nur ~ 250 HV.

Passende Zierkappen → Artikel 88003

Werkstoffeigensch. → **TI-236** Montage → **TI-251**



3,9	x	9,5 -H	S	1000	31,50A2
3,9	x	13 -H	S	1000	30,50A2
3,9	x	16 -H	S	1000	20,50A2
3,9	x	19 -H	S	1000	33,50A2
3,9	x	22 -H	S	500	27,50A2
3,9	x	25 -H	S	500	40,00A2
3,9	x	32 -H	S	500	37,00A2
3,9	x	38 -H	S	500	56,00A2

Artikel	88003.*
88003	Kunststoff



Zierkappen für Kappenschrauben Artikel 88981 Ø 3,9

weiß RAL 9010 (*630),
grau RAL 7001 (*640),
schwarz RAL 9005 (*650)

REACH → **TI-262**

F. 3,9	S	1000	8,60
--------	---	------	------

Abmessungen	VE Stück	€/100/Obf.
DIN 07982.924		
7982	A 2	Form C-H

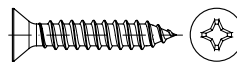

Senk-Blehschrauben mit Phillips-Kreuzschlitz H, C = mit Spitze

Nennlängen ab 60 mm mit Teilgewinde,
Senk α = 80°

Achtung! Härte werkstoffbedingt nur ~ 250 HV.

Maße → **TI-47** Montage → **TI-251**
Werkstoffeigensch. → **TI-236** Normumstellung → **TI-11**

Stahl → **S. 360**

DIN 7982 → wird ersetzt durch ISO 7050

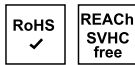

C 2,2	x	6,5 -H	S	1000	14,20A2
C 2,2	x	9,5 -H	S	1000	9,80A2
C 2,2	x	13 -H	S	1000	18,70A2
C 2,2	x	16 -H	S	1000	26,50A2
C 2,2	x	19 -H	S	1000	37,50A2
C 2,9	x	6,5 -H	S	1000	6,70A2
C 2,9	x	9,5 -H	S	1000	4,95A2
C 2,9	x	9,5 -H	K	100	8,80A2
C 2,9	x	13 -H	S	1000	5,20A2
C 2,9	x	13 -H	K	100	9,00A2
C 2,9	x	16 -H	S	1000	5,70A2
C 2,9	x	16 -H	K	100	9,60A2
C 2,9	x	19 -H	S	1000	6,10A2
C 2,9	x	19 -H	K	100	10,00A2
C 2,9	x	22 -H	S	1000	10,20A2
C 2,9	x	22 -H	K	100	14,00A2
C 2,9	x	25 -H	S	1000	10,60A2
C 2,9	x	25 -H	K	100	14,50A2
C 3,5	x	9,5 -H	S	1000	6,50A2
C 3,5	x	9,5 -H	K	100	10,40A2
C 3,5	x	13 -H	S	1000	6,90A2
C 3,5	x	13 -H	K	100	10,70A2
C 3,5	x	16 -H	S	1000	7,20A2
C 3,5	x	16 -H	K	100	11,10A2
C 3,5	x	19 -H	S	1000	8,00A2
C 3,5	x	19 -H	K	100	11,90A2
C 3,5	x	22 -H	S	1000	10,00A2
C 3,5	x	22 -H	K	100	13,90A2
C 3,5	x	25 -H	S	1000	10,40A2
C 3,5	x	25 -H	K	100	14,20A2
C 3,5	x	32 -H	S	1000	11,80A2
C 3,5	x	32 -H	K	100	15,70A2
C 3,5	x	38 -H	S	1000	13,20A2
C 3,5	x	38 -H	K	100	17,10A2
C 3,5	x	45 -H	S	1000	17,10A2
C 3,5	x	50 -H	S	1000	22,80A2
C 3,5	x	60 -H	S	500	31,50A2
C 3,9	x	9,5 -H	S	1000	7,80A2
C 3,9	x	9,5 -H	K	100	11,70A2
C 3,9	x	13 -H	S	1000	7,80A2
C 3,9	x	13 -H	K	100	11,70A2
C 3,9	x	16 -H	S	1000	8,40A2
C 3,9	x	16 -H	K	100	12,30A2
C 3,9	x	19 -H	S	1000	9,10A2
C 3,9	x	19 -H	K	100	13,00A2
C 3,9	x	22 -H	S	500	11,20A2
C 3,9	x	22 -H	K	100	15,10A2
C 3,9	x	25 -H	S	500	11,60A2

C 3,9	x	25 -H	K	100	15,50A2
C 3,9	x	32 -H	S	500	13,80A2
C 3,9	x	32 -H	K	100	17,60A2
C 3,9	x	38 -H	S	500	15,80A2
C 3,9	x	38 -H	K	100	19,60A2
C 3,9	x	45 -H	S	500	19,50A2
C 3,9	x	50 -H	S	500	21,10A2
C 3,9	x	60 -H	S	500	28,50A2
C 4,2	x	9,5 -H	S	1000	8,80A2
C 4,2	x	9,5 -H	K	100	12,60A2
C 4,2	x	13 -H	S	1000	8,90A2
C 4,2	x	13 -H	K	100	12,80A2
C 4,2	x	16 -H	S	1000	10,00A2
C 4,2	x	16 -H	K	100	13,90A2
C 4,2	x	19 -H	S	500	10,90A2
C 4,2	x	19 -H	K	100	14,80A2
C 4,2	x	22 -H	S	500	12,40A2
C 4,2	x	22 -H	K	100	16,20A2
C 4,2	x	25 -H	S	500	12,70A2
C 4,2	x	25 -H	K	100	16,60A2
C 4,2	x	32 -H	S	500	15,80A2
C 4,2	x	32 -H	K	100	19,60A2
C 4,2	x	38 -H	S	500	17,90A2
C 4,2	x	38 -H	K	100	21,80A2
C 4,2	x	45 -H	S	500	26,00A2
C 4,2	x	45 -H	K	100	30,00A2
C 4,2	x	50 -H	S	500	29,50A2
C 4,2	x	50 -H	K	100	33,50A2
C 4,2	x	60 -H	S	250	53,00A2
C 4,8	x	13 -H	S	500	11,40A2
C 4,8	x	13 -H	K	100	15,30A2
C 4,8	x	16 -H	S	500	12,40A2
C 4,8	x	16 -H	K	100	16,20A2
C 4,8	x	19 -H	S	500	13,80A2
C 4,8	x	19 -H	K	100	17,60A2
C 4,8	x	22 -H	S	500	15,80A2
C 4,8	x	22 -H	K	100	19,60A2
C 4,8	x	25 -H	S	500	16,10A2
C 4,8	x	25 -H	K	100	20,00A2
C 4,8	x	32 -H	S	250	20,50A2
C 4,8	x	32 -H	K	100	24,40A2
C 4,8	x	38 -H	S	250	22,90A2
C 4,8	x	38 -H	K	100	27,00A2
C 4,8	x	45 -H	S	250	30,00A2
C 4,8	x	45 -H	K	100	34,00A2
C 4,8	x	50 -H	S	250	31,00A2
C 4,8	x	50 -H	K	100	35,00A2
C 4,8	x	55 -H	S	250	66,00A2
C 4,8	x	60 -H	S	250	42,00A2
C 4,8	x	70 -H	S	250	55,00A2
C 4,8	x	80 -H	S	250	66,00A2
C 4,8	x	90 -H	S	100	85,00A2
C 4,8	x	100 -H	S	100	107,00A2
C 5,5	x	13 -H	S	500	18,50A2
C 5,5	x	13 -H	K	100	22,40A2
C 5,5	x	16 -H	K	100	23,60A2
C 5,5	x	19 -H	S	500	21,10A2
C 5,5	x	19 -H	K	100	24,90A2
C 5,5	x	22 -H	S	500	23,10A2
C 5,5	x	22 -H	K	100	27,00A2
C 5,5	x	25 -H	S	500	24,80A2
C 5,5	x	25 -H	K	100	29,00A2
C 5,5	x	32 -H	S	250	29,00A2
C 5,5	x	32 -H	K	100	33,00A2
C 5,5	x	38 -H	S	250	33,00A2
C 5,5	x	38 -H	K	100	37,00A2
C 5,5	x	45 -H	S	250	39,50A2
C 5,5	x	45 -H	K	100	43,50A2
C 5,5	x	50 -H	S	250	44,00A2
C 5,5	x	50 -H	K	100	48,00A2
C 5,5	x	60 -H	S	250	53,00A2
C 6,3	x	16 -H	S	500	21,20A2
C 6,3	x	16 -H	K	100	25,50A2
C 6,3	x	19 -H	S	500	22,80A2
C 6,3	x	19 -H	K	100	27,00A2

Abmessungen	VE	Stück	€/100/Obf.
C 6,3 x 22 -H	S	500	25,00A2
C 6,3 x 22 -H	K	100	29,00A2
C 6,3 x 25 -H	S	500	26,50A2
C 6,3 x 25 -H	K	100	30,50A2
C 6,3 x 32 -H	S	250	32,00A2
C 6,3 x 32 -H	K	100	36,00A2
C 6,3 x 38 -H	S	250	35,50A2
C 6,3 x 38 -H	K	100	39,50A2
C 6,3 x 45 -H	S	250	42,50A2
C 6,3 x 45 -H	K	100	46,00A2
C 6,3 x 50 -H	S	250	53,00A2
C 6,3 x 50 -H	K	100	57,00A2

Artikel	88004.(*)
88004	Kunststoff H

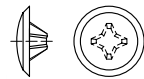

Zierkappen für Senkschrauben mit Phillips-Kreuzschlitz H

weiß RAL 9010 (*630),
hellbraun RAL 8001 (*640)
dunkelbraun RAL 8014 (*650)

REACH → TI-262

Kreuzschlitz-Nr. x Kappen Ø / für Schrauben Ø

2	x	12 / 3,5-5	S	1000	3,10 Kunstst
---	---	------------	---	------	--------------

DIN	07983.924
7983	A 2 Form C-H

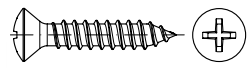

Linsensenk-Blechschräuben mit Phillips-Kreuzschlitz H, C = mit Spitze

Senk $\alpha = 80^\circ$

Achtung! Härte werkstoffbedingt nur ~ 250 HV.

Maße → TI-47 Montage → TI-251
Werkstoffeigensch. → TI-236 Normumstellung → TI-11

Stahl → S. 362

DIN 7983 → wird ersetzt durch ISO 7051

RoHS	REACH SVHC free
✓	free

C 2,9 x 9,5-H	S	1000	4,95A2
C 2,9 x 9,5-H	K	100	8,80A2
C 2,9 x 13 -H	S	1000	5,20A2
C 2,9 x 13 -H	K	100	9,00A2
C 2,9 x 16 -H	S	1000	5,70A2
C 2,9 x 16 -H	K	100	9,60A2
C 2,9 x 19 -H	S	1000	6,10A2
C 2,9 x 19 -H	K	100	10,00A2
C 2,9 x 22 -H	S	1000	10,20A2
C 2,9 x 22 -H	K	100	14,00A2
C 2,9 x 25 -H	S	1000	10,60A2
C 2,9 x 25 -H	K	100	14,50A2
C 3,5 x 9,5-H	S	1000	6,50A2
C 3,5 x 9,5-H	K	100	10,40A2
C 3,5 x 13 -H	S	1000	6,90A2

Abmessungen	VE	Stück	€/100/Obf.
C 3,5 x 13 -H	K	100	10,70A2
C 3,5 x 16 -H	S	1000	7,20A2
C 3,5 x 16 -H	K	100	11,10A2
C 3,5 x 19 -H	S	1000	8,00A2
C 3,5 x 19 -H	K	100	11,90A2
C 3,5 x 22 -H	S	1000	10,00A2
C 3,5 x 22 -H	K	100	13,90A2
C 3,5 x 25 -H	S	1000	10,40A2
C 3,5 x 25 -H	K	100	14,20A2
C 3,5 x 32 -H	S	1000	11,80A2
C 3,5 x 32 -H	K	100	15,70A2
C 3,5 x 38 -H	S	1000	13,20A2
C 3,5 x 38 -H	K	100	17,10A2
C 3,9 x 9,5-H	S	1000	7,80A2
C 3,9 x 9,5-H	K	100	11,70A2
C 3,9 x 13 -H	S	1000	7,80A2
C 3,9 x 13 -H	K	100	11,70A2
C 3,9 x 16 -H	S	1000	8,40A2
C 3,9 x 16 -H	K	100	12,30A2
C 3,9 x 19 -H	S	1000	9,10A2
C 3,9 x 19 -H	K	100	13,00A2
C 3,9 x 22 -H	S	500	11,20A2
C 3,9 x 22 -H	K	100	15,10A2
C 3,9 x 25 -H	S	500	11,60A2
C 3,9 x 25 -H	K	100	15,50A2
C 3,9 x 32 -H	S	500	13,80A2
C 3,9 x 32 -H	K	100	17,60A2
C 3,9 x 38 -H	S	500	15,80A2
C 3,9 x 38 -H	K	100	19,60A2
C 4,2 x 9,5-H	S	1000	8,80A2
C 4,2 x 9,5-H	K	100	12,60A2
C 4,2 x 13 -H	S	1000	8,90A2
C 4,2 x 13 -H	K	100	12,80A2
C 4,2 x 16 -H	S	1000	10,00A2
C 4,2 x 16 -H	K	100	13,90A2
C 4,2 x 19 -H	S	500	10,90A2
C 4,2 x 19 -H	K	100	14,80A2
C 4,2 x 22 -H	S	500	12,40A2
C 4,2 x 22 -H	K	100	16,20A2
C 4,2 x 25 -H	S	500	12,70A2
C 4,2 x 25 -H	K	100	16,60A2
C 4,2 x 32 -H	S	500	15,80A2
C 4,2 x 32 -H	K	100	19,60A2
C 4,2 x 38 -H	S	500	17,90A2
C 4,2 x 38 -H	K	100	21,80A2
C 4,2 x 45 -H	S	500	26,00A2
C 4,2 x 45 -H	K	100	30,00A2
C 4,2 x 50 -H	S	500	29,50A2
C 4,2 x 50 -H	K	100	33,50A2
C 4,2 x 60 -H	S	200	40,00A2
C 4,8 x 13 -H	S	500	11,40A2
C 4,8 x 13 -H	K	100	15,30A2
C 4,8 x 16 -H	S	500	12,40A2
C 4,8 x 16 -H	K	100	16,20A2
C 4,8 x 19 -H	S	500	13,80A2
C 4,8 x 19 -H	K	100	17,60A2
C 4,8 x 22 -H	S	500	15,80A2
C 4,8 x 22 -H	K	100	19,60A2
C 4,8 x 25 -H	S	500	16,10A2
C 4,8 x 25 -H	K	100	20,00A2
C 4,8 x 32 -H	S	250	20,50A2
C 4,8 x 32 -H	K	100	24,40A2
C 4,8 x 38 -H	S	250	22,90A2
C 4,8 x 38 -H	K	100	27,00A2
C 4,8 x 45 -H	S	250	30,00A2
C 4,8 x 45 -H	K	100	34,00A2
C 4,8 x 50 -H	S	250	31,00A2
C 4,8 x 50 -H	K	100	35,00A2
C 4,8 x 60 -H	S	250	51,00A2
C 5,5 x 13 -H	S	500	18,50A2
C 5,5 x 13 -H	K	100	22,40A2
C 5,5 x 16 -H	S	500	19,70A2
C 5,5 x 16 -H	K	100	23,60A2
C 5,5 x 19 -H	S	500	21,10A2
C 5,5 x 19 -H	K	100	24,90A2

Abmessungen	VE	Stück	€/100/Obf.
C 5,5 x 22 -H	K	100	27,00A2
C 5,5 x 25 -H	K	100	29,00A2
C 5,5 x 32 -H	S	250	29,00A2
C 5,5 x 32 -H	K	100	33,00A2
C 5,5 x 38 -H	S	250	33,00A2
C 5,5 x 38 -H	K	100	37,00A2
C 5,5 x 45 -H	S	250	39,50A2
C 5,5 x 45 -H	K	100	43,50A2
C 5,5 x 50 -H	S	250	44,00A2
C 5,5 x 50 -H	K	100	48,00A2
C 6,3 x 16 -H	K	100	25,50A2
C 6,3 x 19 -H	K	100	27,00A2
C 6,3 x 22 -H	S	500	25,00A2
C 6,3 x 22 -H	K	100	29,00A2
C 6,3 x 25 -H	S	500	26,50A2
C 6,3 x 25 -H	K	100	30,50A2
C 6,3 x 32 -H	K	100	36,00A2
C 6,3 x 38 -H	K	100	39,50A2
C 6,3 x 45 -H	K	100	46,00A2
C 6,3 x 50 -H	S	250	53,00A2
C 6,3 x 50 -H	K	100	57,00A2

DIN	07984.920
7984	A 2

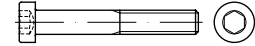

Zylinderschrauben mit Innensechskant, niedriger Kopf

Länge ≤ 100 mm bei einigen Fabrikaten
Gewinde bis Kopf

Achtung!
Schrauben nur eingeschränkt belastbar.

Maße → TI-13 Anziehmomente → TI-246, 249

Werkstoffeigensch. → TI-236

Stahl → S. 362

RoHS	REACH SVHC free
✓	free

M 3 x 5	S	200	95,00A2
M 3 x 6	S	200	95,00A2
M 3 x 8	S	200	95,00A2
M 3 x 10	S	200	95,00A2
M 3 x 12	S	100	95,00A2
M 3 x 16	S	100	59,00A2
M 3 x 20	S	100	65,00A2
M 3 x 25	S	100	67,00A2
M 3 x 30	S	100	87,00A2
M 3 x 40	S	100	91,00A2
M 4 x 6	S	200	95,00A2
M 4 x 8	S	200	95,00A2
M 4 x 10	S	200	95,00A2
M 4 x 12	S	200	95,00A2
M 4 x 16	S	200	67,00A2
M 4 x 20	S	100	71,00A2
M 4 x 25	S	100	76,00A2
M 4 x 30	S	100	95,00A2
M 4 x 35	S	100	105,00A2
M 4 x 40	S	100	116,00A2
M 5 x 8	S	100	105,00A2
M 5 x 10	S	100	95,00A2
M 5 x 12	S	100	95,00A2
M 5 x 14	S	100	86,00A2
M 5 x 16	S	100	75,00A2
M 5 x 20	S	100	80,00A2
M 5 x 25	S	100	85,00A2

Abmessungen	VE	Stück	€/100/Obf.
M 5 x 30	S	100	99,00A2
M 5 x 35	S	100	110,00A2
M 5 x 40	S	100	120,00A2
M 5 x 45	S	100	116,00A2
M 5 x 50	S	100	124,00A2
M 5 x 60	S	100	138,00A2
M 6 x 8	S	100	130,00A2
M 6 x 10	S	100	119,00A2
M 6 x 12	S	100	119,00A2
M 6 x 16	S	100	94,00A2
M 6 x 20	S	100	102,00A2
M 6 x 25	S	100	107,00A2
M 6 x 30	S	100	117,00A2
M 6 x 35	S	100	132,00A2
M 6 x 40	S	100	145,00A2
M 6 x 45	S	100	175,00A2
M 6 x 50	S	100	194,00A2
M 6 x 55	S	100	243,00A2
M 6 x 60	S	100	265,00A2
M 8 x 10	S	100	212,00A2
M 8 x 12	S	100	212,00A2
M 8 x 16	S	100	192,00A2
M 8 x 20	S	100	163,00A2
M 8 x 25	S	100	155,00A2
M 8 x 30	S	100	163,00A2
M 8 x 35	S	100	183,00A2
M 8 x 40	S	100	201,00A2
M 8 x 45	S	100	235,00A2
M 8 x 50	S	100	270,00A2
M 8 x 60	S	100	345,00A2
M 10 x 16	S	100	390,00A2
M 10 x 20	S	100	330,00A2
M 10 x 25	S	100	315,00A2
M 10 x 30	S	100	340,00A2
M 10 x 35	S	100	360,00A2
M 10 x 40	S	100	385,00A2
M 10 x 45	S	100	450,00A2
M 10 x 50	S	100	475,00A2
M 10 x 55	S	100	560,00A2
M 10 x 60	S	100	590,00A2
M 12 x 25	S	100	485,00A2
M 12 x 30	S	100	485,00A2
M 12 x 35	S	100	520,00A2
M 12 x 40	S	100	570,00A2
M 12 x 45	S	100	630,00A2
M 16 x 30	S	25	1830,00A2
M 16 x 35	S	25	1830,00A2
M 16 x 40	S	25	1900,00A2
M 16 x 45	S	25	2000,00A2
M 16 x 50	S	25	2080,00A2
M 16 x 55	S	25	2290,00A2
M 16 x 60	S	25	2350,00A2

Abmessungen	VE	Stück	€/100/Obf.
DIN 07984.940			
7984 A 4			

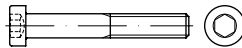

Zylinderschrauben mit Innensechskant, niedriger Kopf

Länge ≤ 100 mm bei einigen Fabrikaten
Gewinde bis Kopf

Achtung!
Schrauben nur eingeschränkt belastbar.

Maße → TI-13 Anziehmomente → TI-246, 249
Werkstoffeigensch. → TI-236

Stahl → S. 362

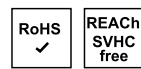

M 4 x 6	S	200	221,00A4
M 4 x 8	S	200	186,00A4
M 4 x 10	S	200	152,00A4
M 4 x 12	S	200	152,00A4
M 4 x 16	S	200	122,00A4
M 5 x 10	S	100	165,00A4
M 5 x 12	S	100	143,00A4
M 5 x 16	S	100	105,00A4
M 5 x 20	S	100	113,00A4
M 6 x 10	S	100	197,00A4
M 6 x 12	S	100	167,00A4
M 6 x 16	S	100	131,00A4
M 6 x 20	S	100	139,00A4
M 6 x 25	S	100	159,00A4
M 6 x 30	S	100	166,00A4
M 6 x 35	S	100	178,00A4
M 6 x 40	S	100	201,00A4
M 8 x 12	S	100	330,00A4
M 8 x 16	S	100	250,00A4
M 8 x 20	S	100	204,00A4
M 8 x 25	S	100	214,00A4
M 8 x 30	S	100	227,00A4
M 8 x 35	S	100	250,00A4
M 8 x 40	S	100	320,00A4
M 8 x 50	S	100	400,00A4
M 10 x 20	S	100	475,00A4
M 10 x 25	S	100	450,00A4
M 10 x 30	S	100	455,00A4
M 10 x 35	S	100	480,00A4
M 12 x 20	S	100	830,00A4
M 12 x 25	S	50	790,00A4
M 12 x 30	S	50	720,00A4
M 12 x 35	S	50	770,00A4
M 12 x 40	S	50	820,00A4
M 16 x 30	S	25	2440,00A4
M 16 x 35	S	25	2550,00A4
M 16 x 40	S	25	2600,00A4

Abmessungen	VE	Stück	€/100/Obf.
DIN 07985.924			
7985 A 2 H			

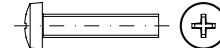

Linsenschrauben mit Phillips-Kreuzschlitz H

Maße → TI-40 Normumstellung → TI-11
Werkstoffeigensch. → TI-236

Stahl → S. 364

DIN 7985 → wird ersetzt durch ISO 7045

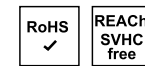

M 1,6 x 2 -H	S	1000	38,00A2
M 1,6 x 3 -H	S	1000	34,00A2
M 1,6 x 4 -H	S	1000	31,50A2
M 1,6 x 5 -H	S	1000	31,50A2
M 1,6 x 6 -H	S	1000	31,50A2
M 1,6 x 8 -H	S	1000	32,50A2
M 1,6 x 10 -H	S	1000	35,00A2
M 1,6 x 12 -H	S	1000	40,00A2
M 1,6 x 16 -H	S	1000	47,50A2
M 2 x 2 -H	S	1000	34,50A2
M 2 x 3 -H	S	1000	19,70A2
M 2 x 4 -H	S	1000	13,40A2
M 2 x 4 -H	K	200	15,30A2
M 2 x 5 -H	S	1000	11,00A2
M 2 x 5 -H	K	200	12,90A2
M 2 x 6 -H	S	1000	11,00A2
M 2 x 6 -H	K	200	12,90A2
M 2 x 8 -H	S	1000	11,00A2
M 2 x 8 -H	K	200	12,90A2
M 2 x 10 -H	S	1000	11,00A2
M 2 x 10 -H	K	200	12,90A2
M 2 x 12 -H	S	1000	12,00A2
M 2 x 12 -H	K	200	13,90A2
M 2 x 14 -H	S	1000	16,80A2
M 2 x 16 -H	S	1000	12,70A2
M 2 x 16 -H	K	200	14,60A2
M 2 x 18 -H	S	1000	17,90A2
M 2 x 20 -H	S	1000	14,70A2
M 2 x 20 -H	K	200	16,60A2
M 2,5 x 3 -H	S	1000	20,90A2
M 2,5 x 4 -H	S	1000	13,40A2
M 2,5 x 4 -H	K	200	15,30A2
M 2,5 x 5 -H	S	1000	13,70A2
M 2,5 x 5 -H	K	200	15,60A2
M 2,5 x 6 -H	S	1000	11,00A2
M 2,5 x 6 -H	K	200	12,90A2
M 2,5 x 8 -H	S	1000	11,00A2
M 2,5 x 8 -H	K	200	12,90A2
M 2,5 x 10 -H	S	1000	11,00A2
M 2,5 x 10 -H	K	200	12,90A2
M 2,5 x 12 -H	S	1000	12,00A2
M 2,5 x 12 -H	K	200	13,90A2
M 2,5 x 14 -H	S	1000	16,80A2
M 2,5 x 16 -H	S	1000	12,70A2
M 2,5 x 18 -H	S	1000	17,90A2
M 2,5 x 20 -H	S	1000	14,70A2
M 2,5 x 25 -H	S	1000	23,30A2
M 2,5 x 30 -H	S	1000	34,50A2
M 3 x 4 -H	S	1000	12,50A2
M 3 x 5 -H	S	1000	10,60A2
M 3 x 6 -H	S	1000	7,10A2
M 3 x 6 -H	K	200	8,90A2

Abmessungen	VE	Stück	€/100/Obf.	Abmessungen	VE	Stück	€/100/Obf.	Abmessungen	VE	Stück	€/100/Obf.
M 3 x 8-H	S	1000	7,50A2	M 5 x 90-H	S	100	137,00A2	M 2 x 6-H	S	1000	19,60A4
M 3 x 8-H	K	200	9,40A2	M 6 x 8-H	S	200	24,80A2	M 2 x 8-H	S	1000	19,60A4
M 3 x 10-H	S	1000	8,00A2	M 6 x 10-H	S	200	25,00A2	M 2 x 10-H	S	1000	19,60A4
M 3 x 10-H	K	200	9,90A2	M 6 x 12-H	S	200	26,50A2	M 2 x 12-H	S	1000	21,20A4
M 3 x 12-H	S	1000	8,50A2	M 6 x 14-H	S	200	39,50A2	M 2 x 16-H	S	1000	22,50A4
M 3 x 12-H	K	200	10,40A2	M 6 x 16-H	S	200	30,00A2	M 2 x 20-H	S	1000	26,50A4
M 3 x 14-H	S	1000	12,10A2	M 6 x 18-H	S	200	40,00A2	M 2,5 x 4-H	S	1000	23,50A4
M 3 x 16-H	S	1000	11,10A2	M 6 x 20-H	S	200	32,50A2	M 2,5 x 5-H	S	1000	19,60A4
M 3 x 16-H	K	200	15,10A2	M 6 x 25-H	S	200	36,50A2	M 2,5 x 6-H	S	1000	19,60A4
M 3 x 18-H	S	1000	14,00A2	M 6 x 30-H	S	200	42,50A2	M 2,5 x 8-H	S	1000	19,60A4
M 3 x 20-H	S	1000	10,60A2	M 6 x 35-H	S	200	47,00A2	M 2,5 x 10-H	S	1000	19,60A4
M 3 x 20-H	K	200	12,40A2	M 6 x 40-H	S	200	54,00A2	M 2,5 x 12-H	S	1000	21,20A4
M 3 x 22-H	S	1000	15,00A2	M 6 x 45-H	S	200	60,00A2	M 2,5 x 14-H	S	1000	28,50A4
M 3 x 25-H	S	1000	11,50A2	M 6 x 50-H	S	200	62,00A2	M 2,5 x 16-H	S	1000	22,50A4
M 3 x 30-H	S	1000	16,90A2	M 6 x 55-H	S	200	69,00A2	M 2,5 x 20-H	S	1000	26,50A4
M 3 x 35-H	S	1000	31,00A2	M 6 x 60-H	S	100	69,00A2	M 2,5 x 30-H	S	500	53,00A4
M 3 x 40-H	S	1000	35,00A2	M 6 x 70-H	S	100	115,00A2	M 3 x 4-H	S	1000	22,30A4
M 3 x 45-H	S	500	52,00A2	M 6 x 80-H	S	100	132,00A2	M 3 x 5-H	S	1000	18,80A4
M 3 x 50-H	S	500	52,00A2	M 6 x 90-H	S	100	162,00A2	M 3 x 6-H	S	1000	12,40A4
M 4 x 4-H	S	1000	18,80A2	M 8 x 10-H	S	100	56,00A2	M 3 x 8-H	S	1000	12,20A4
M 4 x 5-H	S	1000	14,30A2	M 8 x 12-H	S	100	46,50A2	M 3 x 10-H	S	1000	13,40A4
M 4 x 6-H	S	1000	11,30A2	M 8 x 16-H	S	100	54,00A2	M 3 x 12-H	S	1000	14,40A4
M 4 x 6-H	K	200	13,20A2	M 8 x 20-H	S	100	58,00A2	M 3 x 14-H	S	1000	21,40A4
M 4 x 8-H	S	1000	11,30A2	M 8 x 25-H	S	100	61,00A2	M 3 x 16-H	S	1000	15,60A4
M 4 x 8-H	K	200	13,20A2	M 8 x 30-H	S	100	65,00A2	M 3 x 20-H	S	1000	17,40A4
M 4 x 10-H	S	1000	11,80A2	M 8 x 35-H	S	100	67,00A2	M 3 x 25-H	S	1000	20,40A4
M 4 x 10-H	K	200	13,70A2	M 8 x 40-H	S	100	70,00A2	M 3 x 30-H	S	1000	30,00A4
M 4 x 12-H	S	1000	12,40A2	M 8 x 45-H	S	100	83,00A2	M 3 x 35-H	S	1000	55,00A4
M 4 x 12-H	K	200	14,30A2	M 8 x 50-H	S	100	85,00A2	M 3 x 40-H	S	1000	62,00A4
M 4 x 14-H	S	1000	18,40A2	M 8 x 55-H	S	100	89,00A2	M 3 x 50-H	S	500	91,00A4
M 4 x 16-H	S	1000	15,90A2	M 8 x 60-H	S	100	89,00A2	M 4 x 5-H	S	1000	25,50A4
M 4 x 16-H	K	200	17,90A2	M 10 x 12-H	S	100	335,00A2	M 4 x 6-H	S	1000	20,10A4
M 4 x 18-H	S	1000	20,30A2	M 10 x 16-H	S	100	305,00A2	M 4 x 8-H	S	1000	18,10A4
M 4 x 20-H	S	1000	15,50A2	M 10 x 20-H	S	100	325,00A2	M 4 x 10-H	S	1000	19,30A4
M 4 x 20-H	K	200	17,40A2	M 10 x 25-H	S	100	360,00A2	M 4 x 12-H	S	1000	20,80A4
M 4 x 22-H	S	1000	23,70A2	M 10 x 30-H	S	100	390,00A2	M 4 x 14-H	S	1000	33,00A4
M 4 x 25-H	S	1000	18,00A2	M 10 x 35-H	S	100	430,00A2	M 4 x 16-H	S	1000	22,30A4
M 4 x 25-H	K	200	19,90A2	M 10 x 40-H	S	100	465,00A2	M 4 x 18-H	S	1000	36,00A4
M 4 x 30-H	S	1000	21,10A2	M 10 x 45-H	S	100	530,00A2	M 4 x 20-H	S	1000	25,00A4
M 4 x 30-H	K	200	22,90A2	M 10 x 50-H	S	100	530,00A2	M 4 x 22-H	S	1000	42,00A4
M 4 x 35-H	S	500	26,50A2	M 10 x 55-H	S	100	560,00A2	M 4 x 25-H	S	1000	30,00A4
M 4 x 40-H	S	500	28,50A2	M 10 x 60-H	S	100	590,00A2	M 4 x 30-H	S	500	37,50A4
M 4 x 45-H	S	500	33,50A2					M 4 x 35-H	S	500	47,00A4
M 4 x 50-H	S	200	65,00A2					M 4 x 40-H	S	500	51,00A4
M 4 x 55-H	S	200	76,00A2					M 4 x 45-H	S	200	115,00A4
M 4 x 60-H	S	200	77,00A2					M 4 x 50-H	S	200	115,00A4
M 4 x 70-H	S	200	99,00A2					M 5 x 6-H	S	500	50,00A4
M 5 x 6-H	S	500	28,50A2					M 5 x 8-H	S	500	36,00A4
M 5 x 8-H	S	500	20,10A2					M 5 x 10-H	S	500	28,50A4
M 5 x 8-H	K	200	22,00A2					M 5 x 12-H	S	500	30,50A4
M 5 x 10-H	S	500	19,90A2					M 5 x 14-H	S	500	53,00A4
M 5 x 10-H	K	200	21,80A2					M 5 x 16-H	S	500	32,50A4
M 5 x 12-H	S	500	20,10A2					M 5 x 18-H	S	500	59,00A4
M 5 x 12-H	K	200	22,00A2					M 5 x 20-H	S	500	35,50A4
M 5 x 14-H	S	500	29,50A2					M 5 x 22-H	S	500	66,00A4
M 5 x 16-H	S	500	22,40A2					M 5 x 25-H	S	500	42,50A4
M 5 x 16-H	K	200	24,30A2					M 5 x 30-H	S	500	50,00A4
M 5 x 18-H	S	500	33,00A2					M 5 x 35-H	S	500	57,00A4
M 5 x 20-H	S	500	25,00A2					M 5 x 40-H	S	500	79,00A4
M 5 x 20-H	K	200	27,00A2					M 5 x 45-H	S	500	104,00A4
M 5 x 22-H	S	500	37,50A2					M 5 x 50-H	S	200	110,00A4
M 5 x 25-H	S	500	29,00A2					M 5 x 60-H	S	200	143,00A4
M 5 x 25-H	K	200	30,50A2					M 6 x 8-H	S	200	60,00A4
M 5 x 30-H	S	500	33,50A2					M 6 x 10-H	S	200	42,50A4
M 5 x 30-H	K	200	35,50A2					M 6 x 12-H	S	200	44,50A4
M 5 x 35-H	S	500	38,00A2					M 6 x 16-H	S	200	48,00A4
M 5 x 35-H	K	200	40,00A2					M 6 x 20-H	S	200	52,00A4
M 5 x 40-H	S	500	44,00A2					M 6 x 25-H	S	200	57,00A4
M 5 x 40-H	K	200	46,00A2					M 6 x 30-H	S	200	64,00A4
M 5 x 45-H	S	200	49,50A2					M 6 x 35-H	S	200	71,00A4
M 5 x 50-H	S	200	53,00A2					M 6 x 40-H	S	200	84,00A4
M 5 x 55-H	S	200	61,00A2					M 6 x 45-H	S	200	112,00A4
M 5 x 60-H	S	200	62,00A2					M 6 x 50-H	S	200	114,00A4
M 5 x 70-H	S	100	96,00A2					M 6 x 60-H	S	100	137,00A4
M 5 x 80-H	S	100	113,00A2								
				M 1,6 x 3-H	S	1000	53,00A4				
				M 1,6 x 4-H	S	1000	49,00A4				
				M 1,6 x 5-H	S	1000	49,00A4				
				M 1,6 x 6-H	S	1000	49,00A4				
				M 1,6 x 8-H	S	1000	50,00A4				
				M 1,6 x 10-H	S	1000	54,00A4				
				M 1,6 x 12-H	S	1000	62,00A4				
				M 2 x 4-H	S	1000	23,50A4				
				M 2 x 5-H	S	1000	19,60A4				

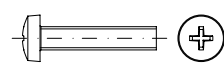
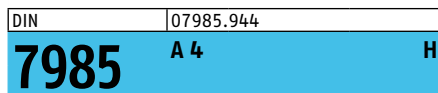

Linsenschrauben mit Phillips-Kreuzschlitz H

Maße → TI-40
 Werkstoffeigensch. → TI-236
 Normumstellung → TI-11
 Stahl → S. 364
 DIN 7985 → wird ersetzt durch ISO 7045



Abmessungen	VE Stück	€/100/Obf.
DIN	07985.925	
7985	A 2	Z



Linsenschrauben mit Pozidriv-Kreuzschlitz Z

Maße → **TI-40** Normumstellung → **TI-11**
 Werkstoffeigensch. → **TI-236**

Stahl → **S. 366**
 DIN 7985 → wird ersetzt durch ISO 7045

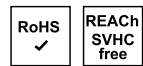

M 1,6	x 3-Z	S 1000	47,50A2
M 1,6	x 4-Z	S 1000	45,50A2
M 1,6	x 5-Z	S 1000	46,50A2
M 1,6	x 6-Z	S 1000	47,50A2
M 1,6	x 8-Z	S 1000	52,00A2
M 1,6	x 10-Z	S 1000	57,00A2
M 1,6	x 12-Z	S 1000	67,00A2
M 1,6	x 16-Z	S 1000	80,00A2
M 2	x 3-Z	S 1000	19,70A2
M 2	x 5-Z	S 1000	11,00A2
M 2	x 6-Z	S 1000	11,00A2
M 2	x 8-Z	S 1000	11,00A2
M 2	x 10-Z	S 1000	11,00A2
M 2	x 12-Z	S 1000	12,00A2
M 2	x 16-Z	S 1000	12,70A2
M 2	x 20-Z	S 1000	14,70A2
M 2,5	x 4-Z	S 1000	13,40A2
M 2,5	x 6-Z	S 1000	11,00A2
M 2,5	x 8-Z	S 1000	11,00A2
M 2,5	x 10-Z	S 1000	11,00A2
M 2,5	x 12-Z	S 1000	12,00A2
M 2,5	x 16-Z	S 1000	12,70A2
M 2,5	x 18-Z	S 1000	14,70A2
M 2,5	x 20-Z	S 1000	14,70A2
M 2,5	x 25-Z	S 1000	23,30A2
M 2,5	x 30-Z	S 1000	30,50A2
M 3	x 4-Z	S 1000	12,50A2
M 3	x 5-Z	S 1000	10,60A2
M 3	x 6-Z	S 1000	7,10A2
M 3	x 8-Z	S 1000	7,50A2
M 3	x 10-Z	S 1000	8,00A2
M 3	x 12-Z	S 1000	8,50A2
M 3	x 14-Z	S 1000	13,70A2
M 3	x 16-Z	S 1000	11,10A2
M 3	x 18-Z	S 1000	10,30A2
M 3	x 20-Z	S 1000	10,60A2
M 3	x 25-Z	S 1000	11,50A2
M 3	x 30-Z	S 1000	16,90A2
M 3	x 35-Z	S 1000	31,00A2
M 3	x 40-Z	S 1000	35,00A2
M 4	x 5-Z	S 1000	14,30A2
M 4	x 6-Z	S 1000	11,30A2
M 4	x 8-Z	S 1000	11,30A2
M 4	x 10-Z	S 1000	11,80A2
M 4	x 12-Z	S 1000	12,40A2
M 4	x 14-Z	S 1000	15,90A2
M 4	x 16-Z	S 1000	15,90A2
M 4	x 18-Z	S 1000	17,80A2
M 4	x 20-Z	S 1000	15,50A2
M 4	x 30-Z	S 1000	21,10A2
M 4	x 35-Z	S 500	26,50A2
M 4	x 40-Z	S 500	28,50A2

Abmessungen	VE Stück	€/100/Obf.
M 4	x 45-Z	S 500 33,50A2
M 4	x 50-Z	S 200 65,00A2
M 4	x 60-Z	S 200 77,00A2
M 4	x 70-Z	S 200 110,00A2
M 5	x 6-Z	S 500 28,50A2
M 5	x 8-Z	S 500 20,10A2
M 5	x 10-Z	S 500 19,90A2
M 5	x 12-Z	S 500 20,10A2
M 5	x 14-Z	S 500 22,40A2
M 5	x 16-Z	S 500 22,40A2
M 5	x 18-Z	S 500 25,00A2
M 5	x 20-Z	S 500 25,00A2
M 5	x 25-Z	S 500 29,00A2
M 5	x 30-Z	S 500 33,50A2
M 5	x 35-Z	S 500 38,00A2
M 5	x 40-Z	S 500 44,00A2
M 5	x 45-Z	S 200 49,50A2
M 5	x 50-Z	S 200 53,00A2
M 6	x 8-Z	S 200 24,80A2
M 6	x 10-Z	S 200 25,00A2
M 6	x 12-Z	S 200 26,50A2
M 6	x 16-Z	S 1000 30,00A2
M 6	x 20-Z	S 200 32,50A2
M 6	x 25-Z	S 200 36,50A2
M 6	x 30-Z	S 200 42,50A2
M 6	x 35-Z	S 200 47,00A2
M 6	x 40-Z	S 200 54,00A2
M 6	x 45-Z	S 200 60,00A2
M 6	x 50-Z	S 200 62,00A2
M 6	x 55-Z	S 200 69,00A2
M 6	x 60-Z	S 100 69,00A2
M 8	x 10-Z	S 200 209,00A2
M 8	x 12-Z	S 200 180,00A2
M 8	x 16-Z	S 200 199,00A2
M 8	x 20-Z	S 200 214,00A2
M 8	x 25-Z	S 200 237,00A2
M 8	x 30-Z	S 200 260,00A2
M 8	x 35-Z	S 200 280,00A2
M 8	x 40-Z	S 200 305,00A2
M 8	x 50-Z	S 200 345,00A2
M 8	x 55-Z	S 200 370,00A2
M10	x 25-Z	S 100 360,00A2
M10	x 30-Z	S 100 390,00A2

Abmessungen	VE Stück	€/100/Obf.
DIN	07985.926	
7985	A 2	ISR



Linsenschrauben, ISR = Innensechsrund
 entspricht ISO 14583

Maße → **TI-40** Normumstellung → **TI-6**
 Werkstoffeigensch. → **TI-236**

Stahl → **S. 366**



M 1,6	x 2-T5	S 1000	57,00A2
M 1,6	x 3-T5	S 1000	47,50A2
M 1,6	x 4-T5	S 1000	45,50A2
M 1,6	x 5-T5	S 1000	46,50A2
M 1,6	x 6-T5	S 1000	47,50A2
M 1,6	x 8-T5	S 1000	52,00A2
M 1,6	x 10-T5	S 1000	57,00A2
M 1,6	x 12-T5	S 1000	67,00A2
M 1,6	x 16-T5	S 1000	80,00A2

Abmessungen	VE Stück	€/100/Obf.	
M 2	x 2-T6	S 1000	57,00A2
M 2	x 3-T6	S 1000	47,50A2
M 2	x 4-T6	S 1000	45,50A2
M 2	x 5-T6	S 1000	46,50A2
M 2	x 6-T6	S 1000	47,50A2
M 2	x 8-T6	S 1000	52,00A2
M 2	x 10-T6	S 1000	57,00A2
M 2	x 12-T6	S 1000	67,00A2
M 2	x 16-T6	S 1000	80,00A2
M 2	x 20-T6	S 1000	95,00A2
M 2,5	x 3-T8	S 1000	28,50A2
M 2,5	x 4-T8	S 1000	20,10A2
M 2,5	x 5-T8	S 1000	20,50A2
M 2,5	x 6-T8	S 1000	16,30A2
M 2,5	x 8-T8	S 1000	16,50A2
M 2,5	x 10-T8	S 1000	16,90A2
M 2,5	x 12-T8	S 1000	18,00A2
M 2,5	x 16-T8	S 1000	19,20A2
M 2,5	x 20-T8	S 1000	22,20A2
M 2,5	x 25-T8	S 1000	34,50A2
M 3	x 4-T10	S 1000	12,40A2
M 3	x 5-T10	S 1000	11,40A2
M 3	x 6-T10	S 1000	10,60A2
M 3	x 8-T10	S 1000	11,20A2
M 3	x 10-T10	S 1000	12,00A2
M 3	x 12-T10	S 1000	12,50A2
M 3	x 16-T10	S 1000	14,80A2
M 3	x 20-T10	S 1000	15,80A2
M 3	x 25-T10	S 1000	17,30A2
M 3	x 30-T10	S 1000	27,50A2
M 4	x 5-T20	S 1000	22,80A2
M 4	x 6-T20	S 1000	16,90A2
M 4	x 8-T20	S 1000	17,10A2
M 4	x 10-T20	S 1000	17,60A2
M 4	x 12-T20	S 1000	18,60A2
M 4	x 16-T20	S 1000	23,90A2
M 4	x 20-T20	S 1000	24,30A2
M 4	x 25-T20	S 1000	27,50A2
M 4	x 30-T20	S 1000	34,50A2
M 4	x 35-T20	S 500	47,00A2
M 4	x 40-T20	S 500	61,00A2
M 5	x 6-T25	S 500	42,50A2
M 5	x 8-T25	S 500	29,50A2
M 5	x 10-T25	S 500	30,00A2
M 5	x 12-T25	S 500	30,50A2
M 5	x 16-T25	S 500	33,50A2
M 5	x 20-T25	S 500	37,50A2
M 5	x 25-T25	S 500	43,00A2
M 5	x 30-T25	S 500	49,50A2
M 5	x 35-T25	S 500	56,00A2
M 5	x 40-T25	S 500	66,00A2
M 5	x 45-T25	S 500	80,00A2
M 5	x 50-T25	S 500	105,00A2
M 6	x 8-T30	S 200	37,50A2
M 6	x 10-T30	S 200	37,50A2
M 6	x 12-T30	S 500	39,50A2
M 6	x 16-T30	S 200	43,00A2
M 6	x 20-T30	S 200	48,50A2
M 6	x 25-T30	S 200	54,00A2
M 6	x 30-T30	S 200	64,00A2
M 6	x 35-T30	S 200	71,00A2
M 6	x 40-T30	S 200	80,00A2
M 6	x 45-T30	S 200	98,00A2
M 6	x 50-T30	S 200	124,00A2
M 6	x 60-T30	S 200	167,00A2
M 8	x 10-T45	S 500	209,00A2
M 8	x 12-T45	S 500	180,00A2
M 8	x 16-T45	S 500	199,00A2
M 8	x 20-T45	S 500	214,00A2
M 8	x 25-T45	S 500	237,00A2
M 8	x 30-T45	S 500	260,00A2
M 8	x 35-T45	S 500	280,00A2
M 8	x 40-T45	S 500	305,00A2
M 8	x 45-T45	S 200	325,00A2
M 8	x 50-T45	S 200	345,00A2

Abmessungen	VE	Stück	€/100/Obf.
M 8 x 55 - T45	S	200	370,00 A2
M 8 x 60 - T45	S	200	390,00 A2
M10 x 12 - T50	S	200	335,00 A2
M10 x 16 - T50	S	200	300,00 A2
M10 x 20 - T50	S	200	325,00 A2
M10 x 25 - T50	S	200	360,00 A2
M10 x 30 - T50	S	200	390,00 A2
M10 x 35 - T50	S	200	430,00 A2
M10 x 40 - T50	S	200	465,00 A2
M10 x 45 - T50	S	100	520,00 A2
M10 x 50 - T50	S	100	530,00 A2
M10 x 55 - T50	S	100	560,00 A2
M10 x 60 - T50	S	100	590,00 A2

DIN 07989.943

7989-1 A 4 PK C

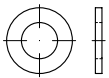

Scheiben für Stahlkonstruktionen, Produktklasse C (g)

alt: Ausführung A

Maße → TI-84 Werkstoffeigensch. → TI-236
 Stahl → S. 367

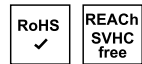

Nennmaß Ø x Außen Ø x Dicke

10/11 x 20 x 8	S	100	770,00 A4
12/13,5 x 24 x 8	S	50	810,00 A4
16/17,5 x 30 x 8	S	50	930,00 A4
20/22 x 37 x 8	S	50	1070,00 A4
22/24 x 39 x 8	S	50	1200,00 A4
24/26 x 44 x 8	S	50	1520,00 A4
27/30 x 50 x 8	S	50	1560,00 A4
30/33 x 56 x 8	S	50	1660,00 A4

ISO 08673.920

8673 A 2

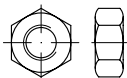

Sechskantmuttern, ISO-Typ 1, mit metrischem Feingewinde

*M 5-M 39 = RAZ 3310 übrige Ø/M = RAZ 410

Maße → TI-62 Anziehmomente → TI-249
 Werkstoffeigensch. → TI-236 Normumstellung → TI-7

Stahl → S. 369
 Messing → S. 642

ISO 8673 → ersetzt DIN 934 Feingewinde



M 6 x 0,75	S	100	152,00 A2
M 8 x 1	S	100	93,00 A2
M 10 x 1	S	50	127,00 A2
M 10 x 1,25	S	50	126,00 A2
M 12 x 1,25	S	50	222,00 A2

Abmessungen	VE	Stück	€/100/Obf.
M 12 x 1,5	S	50	495,00 A2
M 14 x 1,5	S	25	248,00 A2
M 16 x 1,5	S	25	330,00 A2
M 18 x 1,5	S	10	610,00 A2
M 20 x 1,5	S	10	620,00 A2
M 24 x 1,5	S	10	1420,00 A2
M 24 x 2	S	10	1420,00 A2
M 30 x 1,5	S	10	3500,00 A2
M 30 x 2	S	1	3500,00 A2
M 36 x 1,5	S	5	5700,00 A2

ISO 08675.920

8675 A 2

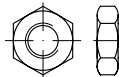

Sechskantmuttern, niedrige Form, mit Fasen, mit metrischem Feingewinde

*M 10/12/14/22 = RAZ 3370 übrige Ø = RAZ 170

Maße → TI-61 Normumstellung → TI-7
 Werkstoffeigensch. → TI-236

Stahl → S. 371
 Messing → S. 643

ISO 8675 → ersetzt DIN 439 Feingewinde

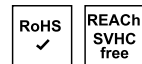

M 8 x 1	S	100	129,00 A2
M 10 x 1	S	50	231,00 A2
M 10 x 1,25	S	50	231,00 A2
M 12 x 1,25	S	50	305,00 A2
M 12 x 1,5	S	50	305,00 A2
M 14 x 1,5	S	25	450,00 A2
M 16 x 1,5	S	25	560,00 A2
M 18 x 1	S	10	570,00 A2
M 18 x 1,5	S	10	790,00 A2
M 20 x 1,5	S	10	1010,00 A2
M 22 x 1,5	S	10	740,00 A2
M 24 x 1,5	S	10	1710,00 A2
M 30 x 1,5	S	10	3200,00 A2
M 30 x 2	S	10	3200,00 A2
M 36 x 1,5	S	1	5800,00 A2

Abmessungen VE Stück €/100/Obf.

ISO 08675.940

8675 A 4

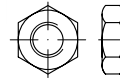

Sechskantmuttern, niedrige Form, mit Fasen, mit metrischem Feingewinde

*M 10/12/14/22 = RAZ 3370 übrige Ø = RAZ 170

Maße → TI-61 Normumstellung → TI-7
 Werkstoffeigensch. → TI-236
 Stahl → S. 371
 Messing → S. 643

ISO 8675 → ersetzt DIN 439 Feingewinde

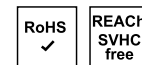

M 10 x 1	S	50	310,00 A4
M 10 x 1,25	S	50	450,00 A4
M 12 x 1,25	S	50	440,00 A4
M 12 x 1,5	S	50	405,00 A4
M 16 x 1,5	S	25	770,00 A4
M 18 x 1,5	S	10	1040,00 A4
M 20 x 1,5	S	10	1370,00 A4
M 22 x 1,5	S	10	1980,00 A4
M 24 x 1,5	S	10	2310,00 A4
M 24 x 2	S	10	2310,00 A4
M 30 x 1,5	S	10	4450,00 A4
M 30 x 2	S	10	4450,00 A4
M 33 x 2	S	1	5800,00 A4
M 36 x 3	S	1	7100,00 A4

ISO 08738.920

8738 A 2 160 HV



Scheiben für Bolzen, Produktklasse A

ISO 8738 = EN 28738, für Bolzen nach ISO 2340 und ISO 2341

Maße → TI-85 Normumstellung → TI-10
 Werkstoffeigensch. → TI-236

Stahl → S. 376

ISO 8738 → ersetzt DIN 1440

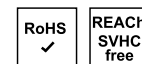

Nenngröße

5	S	50	73,00
6	S	50	89,00
8	S	50	148,00
10	S	50	203,00
12	S	25	285,00
14	S	25	400,00
16	S	25	415,00
20	S	10	600,00

Abmessungen	VE Stück	€/100/Obf.
ISO 08738.940		
8738	A 4 160 HV	

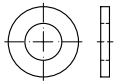

Scheiben für Bolzen, Produktklasse A

ISO 8738 = EN 28738, für Bolzen nach ISO 2340 und ISO 2341

Maße → **TI-85** Normumstellung → **TI-10**
 Werkstoffeigensch. → **TI-236**

Stahl → **S. 376**

ISO 8738 → ersetzt DIN 1440



Nenngröße

5	S	50	96,00
6	S	50	113,00
8	S	50	194,00
10	S	50	285,00
12	S	25	420,00
14	S	25	580,00
16	S	25	590,00
18	S	10	800,00
20	S	10	870,00
30	S	1	3300,00
36	S	1	3900,00
40	S	1	5800,00
50	S	1	8600,00
60	S	1	11300,00

Abmessungen	VE Stück	€/100/Obf.
ISO 08740.910		
8740	A 1	

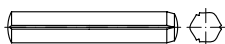

Zylinderkerbstifte mit Fasen

Maße → **TI-119** Normumstellung → **TI-10**
 Werkstoffeigensch. → **TI-236**

Stahl → **S. 377**

ISO 8740 → ersetzt DIN 1473



2	x	8	S	100	18,40A1
2	x	10	S	100	19,00A1
2	x	12	S	100	19,50A1
2	x	16	S	100	20,50A1
2	x	18	S	100	21,20A1
2	x	20	S	100	22,00A1
3	x	8	S	100	24,10A1
3	x	10	S	100	25,50A1
3	x	12	S	100	25,50A1
3	x	16	S	100	25,50A1
3	x	18	S	100	26,50A1
3	x	20	S	100	28,00A1
3	x	24	S	100	30,00A1
3	x	30	S	100	33,00A1

Abmessungen	VE Stück	€/100/Obf.			
4	x	8	S	100	28,00A1
4	x	10	S	100	28,50A1
4	x	12	S	100	28,50A1
4	x	16	S	100	33,50A1
4	x	18	S	100	33,50A1
4	x	20	S	100	36,00A1
4	x	24	S	100	40,50A1
4	x	30	S	100	45,50A1
4	x	35	S	100	51,00A1
4	x	40	S	100	54,00A1
5	x	8	S	100	35,00A1
5	x	10	S	100	37,50A1
5	x	12	S	100	37,50A1
5	x	16	S	100	45,50A1
5	x	18	S	100	47,50A1
5	x	20	S	100	51,00A1
5	x	24	S	100	58,00A1
5	x	30	S	100	63,00A1
5	x	35	S	100	71,00A1
5	x	40	S	100	76,00A1
6	x	10	S	100	63,00A1
6	x	12	S	100	65,00A1
6	x	16	S	100	71,00A1
6	x	18	S	100	74,00A1
6	x	20	S	100	77,00A1
6	x	24	S	100	85,00A1
6	x	30	S	100	94,00A1
6	x	35	S	100	105,00A1
6	x	40	S	100	112,00A1
6	x	45	S	100	120,00A1
6	x	50	S	100	127,00A1
8	x	10	S	100	94,00A1
8	x	12	S	100	99,00A1
8	x	16	S	100	105,00A1
8	x	20	S	100	116,00A1
8	x	25	S	100	131,00A1
8	x	30	S	100	141,00A1
8	x	35	S	100	156,00A1
8	x	40	S	100	165,00A1
8	x	45	S	100	178,00A1
8	x	50	S	100	192,00A1
8	x	60	S	100	216,00A1

Abmessungen	VE Stück	€/100/Obf.
ISO 08744.910		
8744	A 1	

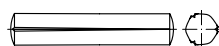

Kegelkerbstifte

Maße → **TI-119** Normumstellung → **TI-10**
 Werkstoffeigensch. → **TI-236**

Stahl → **S. 378**

ISO 8744 → ersetzt DIN 1471



2	x	8	S	100	18,40A1
2	x	10	S	100	19,00A1
2	x	12	S	100	19,50A1
2	x	16	S	100	20,50A1
2	x	18	S	100	21,20A1
2	x	20	S	100	22,00A1
3	x	8	S	100	24,10A1
3	x	10	S	100	25,50A1
3	x	12	S	100	26,00A1
3	x	16	S	100	26,00A1
3	x	18	S	100	26,50A1

Abmessungen	VE Stück	€/100/Obf.
ISO 08745.910		
8745	A 1	

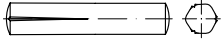

Passkerbstifte

Maße → **TI-118** Normumstellung → **TI-10**
 Werkstoffeigensch. → **TI-236**

Stahl → **S. 379**

ISO 8745 → ersetzt DIN 1472

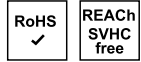

1,5	x	8	S	100	27,00A1
1,5	x	10	S	100	27,50A1
2	x	8	S	100	28,00A1
2	x	10	S	100	29,00A1
2	x	12	S	100	29,50A1
2	x	14	S	100	30,00A1
2	x	16	S	100	32,50A1
2	x	18	S	100	33,00A1
2	x	20	S	100	37,00A1
3	x	6	S	100	29,00A1
3	x	8	S	100	29,00A1
3	x	10	S	100	30,00A1
3	x	12	S	100	32,50A1
3	x	14	S	100	33,00A1
3	x	16	S	100	35,50A1
3	x	18	S	100	36,00A1
3	x	20	S	100	37,50A1
3	x	25	S	100	38,50A1
4	x	8	S	100	32,50A1
4	x	10	S	100	33,50A1
4	x	12	S	100	46,50A1
4	x	14	S	100	48,00A1
4	x	16	S	100	49,50A1
4	x	18	S	100	53,00A1
4	x	20	S	100	53,00A1
4	x	25	S	100	57,00A1
4	x	30	S	100	60,00A1
4	x	40	S	100	64,00A1
5	x	8	S	100	35,00A1
5	x	10	S	100	37,50A1
5	x	12	S	100	37,50A1
5	x	16	S	100	45,50A1
5	x	18	S	100	60,00A1
5	x	20	S	100	65,00A1
5	x	25	S	100	68,00A1
5	x	30	S	100	69,00A1
5	x	35	S	100	71,00A1
5	x	40	S	100	76,00A1
6	x	10	S	100	63,00A1
6	x	18	S	100	74,00A1
6	x	20	S	100	77,00A1
6	x	25	S	100	88,00A1
6	x	30	S	100	94,00A1
6	x	35	S	100	105,00A1
6	x	40	S	100	112,00A1
6	x	45	S	100	120,00A1
6	x	50	S	100	127,00A1
8	x	12	S	100	99,00A1
8	x	16	S	100	105,00A1
8	x	18	S	100	110,00A1
8	x	20	S	100	116,00A1
8	x	25	S	100	131,00A1
8	x	30	S	100	141,00A1
8	x	35	S	100	156,00A1

Abmessungen	VE Stück	€/100/Obf.
8 x 40	S 100	165,00A1
8 x 45	S 100	178,00A1
8 x 50	S 100	192,00A1
8 x 60	S 100	216,00A1

ISO	08746.920	
8746	1.4303 (A 2)	Form A

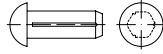

Halbrundkerbnägel, A = mit Fase

Maße → **TI-120** Normumstellung → **TI-10**
 Werkstoffeigensch. → **TI-236**

Stahl → **S. 380**

Messing, Aluminium → **S. 643**

ISO 8746 → ersetzt DIN 1476 (austauschbar)

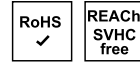

1,4	x	3	S	100	15,00A2
1,4	x	4	S	100	15,40A2
1,4	x	5	S	100	15,60A2
1,4	x	6	S	100	17,10A2
1,6	x	3	S	100	15,40A2
1,6	x	4	S	100	16,50A2
1,6	x	5	S	100	16,90A2
1,6	x	6	S	100	17,60A2
2	x	3	S	100	20,50A2
2	x	4	S	100	20,50A2
2	x	5	S	100	20,50A2
2	x	6	S	100	21,80A2
2	x	8	S	100	23,10A2
2	x	10	S	100	24,80A2
2,5	x	4	S	100	21,20A2
2,5	x	5	S	100	21,60A2
2,5	x	6	S	100	21,80A2
2,5	x	8	S	100	22,20A2
2,5	x	10	S	100	26,00A2
3	x	4	S	100	25,50A2
3	x	5	S	100	27,00A2
3	x	6	S	100	28,50A2
3	x	8	S	100	35,00A2
3	x	10	S	100	36,00A2
3	x	12	S	100	41,50A2
4	x	6	S	100	46,00A2
4	x	8	S	100	52,00A2
4	x	10	S	100	55,00A2
4	x	12	S	100	63,00A2
5	x	8	S	100	63,00A2
5	x	10	S	100	69,00A2
5	x	12	S	100	78,00A2
5	x	16	S	100	83,00A2
6	x	10	S	100	76,00A2
6	x	12	S	100	84,00A2

Abmessungen	VE Stück	€/100/Obf.
ISO 08750.960		
8750	1.4310	

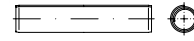

Spiralspannstifte, Regelausführung

Achtung! Reduzierte Federkräfte.

Maße → **TI-121** Normumstellung → **TI-10**
 Werkstoffeigensch. → **TI-236**

Federstahl → **S. 381**

ISO 8750 → ersetzt DIN 7343 (austauschbar)

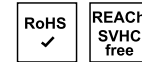

1	x	6	S	1000	15,00
1	x	10	S	1000	16,10
1	x	12	S	1000	17,10
1,5	x	5	S	1000	14,60
1,5	x	6	S	1000	14,80
1,5	x	8	S	1000	15,20
1,5	x	10	S	1000	16,10
1,5	x	12	S	1000	17,10
2	x	4	S	1000	14,60
2	x	5	S	1000	15,20
2	x	6	S	1000	15,60
2	x	8	S	1000	16,10
2	x	10	S	1000	17,10
2	x	12	S	1000	17,50
2	x	14	S	1000	18,00
2	x	16	S	1000	19,20
2	x	18	S	1000	19,70
2	x	20	S	1000	21,10
2,5	x	5	S	1000	16,50
2,5	x	6	S	1000	17,10
2,5	x	8	S	1000	17,50
2,5	x	10	S	1000	18,00
2,5	x	12	S	1000	19,20
2,5	x	14	S	1000	19,70
2,5	x	16	S	1000	21,10
2,5	x	18	S	1000	23,10
2,5	x	20	S	1000	24,50
2,5	x	22	S	1000	25,50
2,5	x	24	S	1000	27,00
3	x	8	S	1000	23,10
3	x	10	S	1000	24,50
3	x	12	S	1000	26,50
3	x	14	S	1000	30,50
3	x	16	S	1000	31,50
3	x	18	S	1000	33,00
3	x	20	S	1000	34,00
3	x	22	S	1000	38,00
3	x	24	S	1000	39,50
3	x	26	S	1000	42,00
3	x	28	S	1000	44,00
3	x	30	S	1000	46,00
3	x	32	S	1000	47,50
4	x	8	S	500	31,50
4	x	10	S	500	32,00
4	x	12	S	500	36,00
4	x	14	S	500	40,50
4	x	16	S	500	44,50
4	x	18	S	500	47,00
4	x	20	S	500	53,00
4	x	22	S	500	56,00
4	x	24	S	500	60,00

Abmessungen	VE	Stück	€/100/Obf.
5 x 28	S	50	90,00
5 x 30	S	50	97,00
5 x 32	S	50	101,00
5 x 36	S	50	112,00
5 x 40	S	50	122,00
5 x 45	S	50	131,00
5 x 50	S	50	148,00
5 x 60	S	50	237,00
5 x 70	S	50	310,00
6 x 10	S	25	63,00
6 x 12	S	25	67,00
6 x 14	S	25	70,00
6 x 16	S	25	74,00
6 x 18	S	25	86,00
6 x 20	S	25	99,00
6 x 22	S	25	105,00
6 x 24	S	25	112,00
6 x 26	S	25	120,00
6 x 28	S	25	127,00
6 x 30	S	25	135,00
6 x 32	S	25	144,00
6 x 36	S	25	159,00
6 x 40	S	25	194,00
6 x 45	S	25	222,00
6 x 50	S	25	255,00
6 x 60	S	25	330,00
6 x 70	S	25	365,00
6 x 80	S	25	390,00
8 x 10	S	25	88,00
8 x 12	S	25	92,00
8 x 14	S	25	97,00
8 x 16	S	25	105,00
8 x 18	S	25	122,00
8 x 20	S	25	139,00
8 x 22	S	25	159,00
8 x 24	S	25	165,00
8 x 26	S	25	171,00
8 x 28	S	25	182,00
8 x 30	S	25	195,00
8 x 32	S	25	212,00
8 x 36	S	25	229,00
8 x 40	S	25	280,00
8 x 45	S	25	305,00
8 x 50	S	25	320,00
8 x 55	S	25	345,00
8 x 60	S	25	365,00
8 x 70	S	25	410,00
8 x 80	S	25	440,00
8 x 90	S	25	485,00
10 x 10	S	50	154,00
10 x 12	S	50	159,00
10 x 16	S	50	175,00
10 x 18	S	50	226,00
10 x 20	S	50	226,00
10 x 22	S	50	260,00
10 x 24	S	50	270,00
10 x 28	S	50	290,00
10 x 30	S	10	315,00
10 x 32	S	50	305,00
10 x 36	S	50	365,00
10 x 40	S	50	435,00
10 x 45	S	10	475,00
10 x 50	S	50	520,00
10 x 55	S	10	540,00
10 x 60	S	10	580,00
10 x 65	S	50	610,00
10 x 70	S	50	630,00
10 x 80	S	10	680,00
10 x 90	S	50	710,00
10 x 100	S	50	780,00

Abmessungen	VE	Stück	€/100/Obf.
DIN 09021.920			
9021			A 2

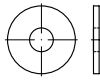

**Scheiben,
Außen Ø ≈ 3 x Schrauben Ø,
Produktklasse C (g)**

Maße → **TI-85** Normumstellung → **TI-84**
 Werkstoffeigensch. → **TI-236**
 Stahl → **S. 387**
 Messing, Kunststoff → **S. 643**

DIN 9021 → wird ersetzt durch ISO 7093

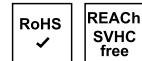

Innen Ø x Außen Ø x Dicke

3,2 x 9 x 0,8	S	1000	3,25 A2
3,2 x 9 x 0,8	K	100	6,20 A2
4,3 x 12 x 1	S	1000	4,30 A2
4,3 x 12 x 1	K	100	6,60 A2
5,3 x 15 x 1,2	S	1000	9,70 A2
5,3 x 15 x 1,2	K	100	12,50 A2
6,4 x 18 x 1,6	S	1000	12,70 A2
6,4 x 18 x 1,6	K	100	15,80 A2
8,4 x 24 x 2	S	1000	32,00 A2
8,4 x 24 x 2	K	100	35,00 A2
10,5 x 30 x 2,5	S	500	48,50 A2
10,5 x 30 x 2,5	K	50	53,00 A2
13 x 37 x 3	S	250	118,00 A2
13 x 37 x 3	K	50	122,00 A2
15 x 44 x 3	S	100	154,00 A2
17 x 50 x 3	S	100	186,00 A2
17 x 50 x 3	K	25	195,00 A2
20 x 56 x 4	S	100	295,00 A2
22 x 60 x 4	S	100	320,00 A2
22 x 60 x 4	K	10	345,00 A2
26 x 72 x 5	S	25	860,00 A2

Abmessungen	VE	Stück	€/100/Obf.
DIN 09021.940			
9021			A 4

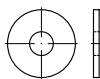

**Scheiben,
Außen Ø ≈ 3 x Schrauben Ø,
Produktklasse C (g)**

Maße → **TI-85** Normumstellung → **TI-84**
 Werkstoffeigensch. → **TI-236**
 Stahl → **S. 387**
 Messing, Kunststoff → **S. 643**

DIN 9021 → wird ersetzt durch ISO 7093



Innen Ø x Außen Ø x Dicke

3,2 x 9 x 0,8	S	1000	4,65 A4
3,2 x 9 x 0,8	K	100	8,80 A4
4,3 x 12 x 1	S	1000	6,10 A4

Abmessungen	VE	Stück	€/100/Obf.
4,3 x 12 x 1	K	100	9,70 A4
5,3 x 15 x 1,2	S	1000	13,50 A4
5,3 x 15 x 1,2	K	100	18,30 A4
6,4 x 18 x 1,6	S	1000	18,70 A4
6,4 x 18 x 1,6	K	100	23,30 A4
8,4 x 24 x 2	S	1000	42,00 A4
8,4 x 24 x 2	K	100	47,50 A4
10,5 x 30 x 2,5	S	500	84,00 A4
10,5 x 30 x 2,5	K	50	96,00 A4
13 x 37 x 3	S	250	168,00 A4
13 x 37 x 3	K	50	179,00 A4
15 x 44 x 3	S	100	233,00 A4
17 x 50 x 3	S	100	300,00 A4
17 x 50 x 3	K	25	325,00 A4
20 x 56 x 4	S	100	450,00 A4
22 x 60 x 4	S	10	560,00 A4
26 x 72 x 5	S	10	670,00 A4



- ✓ Große Artikelvielfalt
- ✓ Verlässliche Qualität
- ✓ Hohe Lieferbereitschaft

Abmessungen	VE	Stück	€/100/Obf.
~ISO 10511.920			
10511			A 2

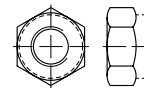

**Sechskantmuttern mit Klemmteil,
mit nichtmetallischem Einsatz,
niedrige Form**

für Temperatur-Einsatz von -50 bis +120 °C

**Achtung! Risiko der Kaltverschweißung. Bitte
technischen Hinweis im Infoeinblender
beachten!**

Maße → **TI-9** Normumstellung → **TI-9**
 Werkstoffeigensch. → **TI-236**

Stahl → **S. 388**
 Messing → **S. 643**

ISO 10511 → ersetzt DIN 985



M 3	S	1000	31,00
M 4	S	1000	24,10
M 5	S	1000	5,20
M 6	S	1000	31,50
M 8	S	500	60,00
M 10	S	500	118,00
M 12	S	250	161,00
M 14	S	250	365,00
M 16	S	250	385,00
M 18	S	25	990,00
M 20	S	1	1180,00

Abmessungen	VE	Stück	€/100/Obf.
M 22	S	1	1250,00
M 24	S	1	1250,00
M 27	S	1	4600,00
M 30	S	1	4600,00
M 36	S	1	9000,00

~ISO	10511.940
10511	A 4

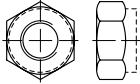

Sechskantmuttern mit Klemmteil, mit nichtmetallischem Einsatz, niedrige Form

für Temperatur-Einsatz von -50 bis +120 °C

Achtung! Risiko der Kaltverschweißung. Bitte technischen Hinweis im Infoeinblender beachten!

Maße → **TI-9** Normumstellung → **TI-9**
 Werkstoffeigensch. → **TI-236**

Stahl → **S. 388**
 Messing → **S. 643**

ISO 10511 → ersetzt DIN 985



M 3	S	1000	96,00
M 4	S	1000	54,00
M 5	S	1000	54,00
M 6	S	1000	72,00
M 8	S	500	104,00
M 10	S	500	204,00
M 12	S	250	315,00
M 14	S	250	620,00
M 16	S	250	720,00
M 20	S	1	2000,00
M 24	S	1	2100,00
M 27	S	1	6000,00
M 30	S	1	7700,00

Wichtiger Hinweis!

Die gültigen Normen für Sechskantmuttern mit Klemmteil gelten für die Ausführung Stahl in den Festigkeitsklassen 5, (6), 8, 10 bzw. 12. Die Verwendung von Muttern mit Klemmteil aus anderen Werkstoffen (z.B. nichtrostenden Stählen, Messing, Aluminium) erfolgt auf eigenes Risiko. Muttern mit Klemmteil aus diesen weicheren Werkstoffen neigen manchmal wegen des hohen Gewindeflankendrucks beim Einformen des Bolzen-gewindes in den Sicherungsring zum Festfressen. Hier hilft in der Regel die Verwendung eines Schmiermittels. Die veränderten Reibwerte sind beim Anziehen der Verbindung entsprechend zu berücksichtigen.



Abmessungen	VE	Stück	€/100/Obf.
ISO	10642.920		
10642	A 2		

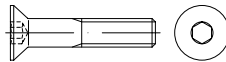

Senkschrauben mit Innensechskant

einige Fabrikate mit Gewinde bis Kopf

Achtung! Schrauben nur eingeschränkt belastbar.

Maße → **TI-14** Anziehmomente → **TI-249**
 Werkstoffeigensch. → **TI-236**

Stahl → **S. 389**

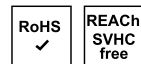

M 3	x	4	S	100	26,50A2
M 3	x	5	S	100	30,50A2
M 3	x	6	S	100	34,50A2
M 3	x	8	S	100	32,00A2
M 3	x	10	S	100	28,00A2
M 3	x	12	S	100	25,50A2
M 3	x	14	S	100	39,00A2
M 3	x	16	S	100	27,50A2
M 3	x	18	S	100	45,00A2
M 3	x	20	S	100	30,50A2
M 3	x	25	S	100	32,50A2
M 3	x	30	S	100	36,00A2
M 3	x	35	S	200	159,00A2
M 4	x	5	S	100	67,00A2
M 4	x	6	S	100	62,00A2
M 4	x	8	S	500	54,00A2
M 4	x	8	K	100	58,00A2
M 4	x	10	S	500	49,50A2
M 4	x	10	K	100	55,00A2
M 4	x	12	S	500	49,50A2
M 4	x	12	K	100	55,00A2
M 4	x	14	S	500	51,00A2
M 4	x	14	K	100	56,00A2
M 4	x	16	S	500	39,00A2
M 4	x	16	K	100	43,50A2
M 4	x	18	S	500	57,00A2
M 4	x	18	K	100	61,00A2
M 4	x	20	S	500	43,00A2
M 4	x	20	K	100	47,50A2
M 4	x	25	S	500	47,50A2
M 4	x	25	K	100	53,00A2
M 4	x	30	S	200	51,00A2
M 4	x	35	S	200	57,00A2
M 4	x	40	S	200	75,00A2
M 4	x	45	S	100	79,00A2
M 4	x	50	S	100	79,00A2
M 5	x	6	S	100	64,00A2
M 5	x	8	S	100	51,00A2
M 5	x	10	S	500	49,50A2
M 5	x	10	K	100	55,00A2
M 5	x	12	S	500	49,50A2
M 5	x	12	K	100	55,00A2
M 5	x	14	S	500	67,00A2
M 5	x	14	K	100	72,00A2
M 5	x	16	S	500	39,00A2
M 5	x	16	K	100	43,50A2
M 5	x	18	S	500	74,00A2
M 5	x	18	K	100	79,00A2
M 5	x	20	S	500	43,00A2
M 5	x	20	K	100	47,50A2

Abmessungen	VE	Stück	€/100/Obf.		
M 5	x	22	S	500	45,50A2
M 5	x	25	S	500	47,50A2
M 5	x	25	K	100	53,00A2
M 5	x	30	S	200	51,00A2
M 5	x	35	S	200	57,00A2
M 5	x	40	S	200	75,00A2
M 5	x	45	S	100	62,00A2
M 5	x	50	S	100	67,00A2
M 5	x	60	S	100	135,00A2
M 5	x	70	S	100	161,00A2
M 6	x	8	S	100	95,00A2
M 6	x	10	S	100	65,00A2
M 6	x	12	S	500	62,00A2
M 6	x	12	K	100	67,00A2
M 6	x	14	S	500	79,00A2
M 6	x	14	K	100	84,00A2
M 6	x	16	S	500	49,50A2
M 6	x	16	K	100	55,00A2
M 6	x	18	S	200	86,00A2
M 6	x	20	S	200	54,00A2
M 6	x	25	S	200	58,00A2
M 6	x	30	S	200	65,00A2
M 6	x	35	S	200	76,00A2
M 6	x	40	S	200	84,00A2
M 6	x	45	S	100	103,00A2
M 6	x	50	S	100	111,00A2
M 6	x	55	S	100	205,00A2
M 6	x	60	S	100	255,00A2
M 6	x	70	S	100	295,00A2
M 6	x	75	S	100	550,00A2
M 6	x	80	S	100	360,00A2
M 8	x	10	S	200	197,00A2
M 8	x	12	S	200	175,00A2
M 8	x	14	S	200	150,00A2
M 8	x	16	S	200	93,00A2
M 8	x	18	S	200	122,00A2
M 8	x	20	S	200	89,00A2
M 8	x	25	S	100	85,00A2
M 8	x	30	S	100	88,00A2
M 8	x	35	S	100	97,00A2
M 8	x	40	S	100	122,00A2
M 8	x	45	S	100	145,00A2
M 8	x	50	S	100	160,00A2
M 8	x	55	S	100	214,00A2
M 8	x	60	S	100	260,00A2
M 8	x	70	S	50	320,00A2
M 8	x	80	S	50	345,00A2
M 8	x	90	S	50	360,00A2
M 8	x	100	S	50	410,00A2
M 8	x	110	S	50	650,00A2
M 8	x	120	S	50	710,00A2
M 10	x	16	S	100	156,00A2
M 10	x	20	S	100	156,00A2
M 10	x	25	S	100	141,00A2
M 10	x	30	S	100	147,00A2
M 10	x	35	S	100	157,00A2
M 10	x	40	S	100	180,00A2
M 10	x	45	S	100	192,00A2
M 10	x	50	S	100	203,00A2
M 10	x	55	S	100	243,00A2
M 10	x	60	S	50	275,00A2
M 10	x	70	S	50	355,00A2
M 10	x	80	S	50	370,00A2
M 10	x	90	S	50	450,00A2
M 10	x	100	S	50	560,00A2
M 10	x	110	S	50	850,00A2
M 10	x	120	S	50	920,00A2
M 10	x	130	S	50	960,00A2
M 12	x	20	S	50	228,00A2
M 12	x	25	S	50	216,00A2
M 12	x	30	S	50	220,00A2
M 12	x	35	S	50	233,00A2
M 12	x	40	S	50	255,00A2
M 12	x	45	S	50	285,00A2
M 12	x	50	S	50	305,00A2

Abmessungen	VE	Stück	€/100/Obf.	Abmessungen	VE	Stück	€/100/Obf.	Abmessungen	VE	Stück	€/100/Obf.
M 12 x 55	S	50	320,00A2	M 3 x 18	S	100	72,00A4	M 8 x 18	S	200	255,00A4
M 12 x 60	S	50	335,00A2	M 3 x 20	S	100	56,00A4	M 8 x 20	S	200	116,00A4
M 12 x 70	S	50	475,00A2	M 3 x 25	S	100	57,00A4	M 8 x 25	S	100	117,00A4
M 12 x 80	S	50	495,00A2	M 3 x 30	S	100	62,00A4	M 8 x 30	S	100	121,00A4
M 12 x 90	S	50	600,00A2	M 4 x 6	S	100	85,00A4	M 8 x 35	S	100	131,00A4
M 12 x 100	S	50	700,00A2	M 4 x 8	S	500	77,00A4	M 8 x 40	S	100	173,00A4
M 12 x 110	S	25	760,00A2	M 4 x 8	K	100	82,00A4	M 8 x 45	S	100	202,00A4
M 12 x 120	S	25	840,00A2	M 4 x 10	S	500	70,00A4	M 8 x 50	S	100	221,00A4
M 12 x 130	S	25	900,00A2	M 4 x 10	K	100	75,00A4	M 8 x 55	S	100	305,00A4
M 12 x 140	S	25	970,00A2	M 4 x 12	S	500	76,00A4	M 8 x 60	S	100	355,00A4
M 16 x 25	S	25	940,00A2	M 4 x 12	K	100	81,00A4	M 8 x 70	S	50	435,00A4
M 16 x 30	S	25	790,00A2	M 4 x 14	S	500	76,00A4	M 8 x 80	S	50	510,00A4
M 16 x 35	S	25	850,00A2	M 4 x 14	K	100	81,00A4	M 8 x 90	S	50	610,00A4
M 16 x 40	S	25	940,00A2	M 4 x 16	S	500	62,00A4	M 8 x 100	S	50	670,00A4
M 16 x 45	S	25	980,00A2	M 4 x 16	K	100	67,00A4	M 8 x 120	S	50	1060,00A4
M 16 x 50	S	25	1010,00A2	M 4 x 18	S	500	80,00A4	M 10 x 16	S	25	295,00A4
M 16 x 55	S	25	1090,00A2	M 4 x 18	K	100	85,00A4	M 10 x 20	S	100	214,00A4
M 16 x 60	S	25	1120,00A2	M 4 x 20	S	500	67,00A4	M 10 x 25	S	100	205,00A4
M 16 x 65	S	25	1230,00A2	M 4 x 20	K	100	72,00A4	M 10 x 30	S	100	212,00A4
M 16 x 70	S	25	1230,00A2	M 4 x 25	S	500	70,00A4	M 10 x 35	S	100	227,00A4
M 16 x 80	S	25	1500,00A2	M 4 x 25	K	100	75,00A4	M 10 x 40	S	100	265,00A4
M 16 x 90	S	25	1570,00A2	M 4 x 30	S	200	76,00A4	M 10 x 45	S	100	280,00A4
M 16 x 100	S	25	1860,00A2	M 4 x 35	S	200	84,00A4	M 10 x 50	S	100	305,00A4
M 16 x 110	S	25	2230,00A2	M 4 x 40	S	200	105,00A4	M 10 x 55	S	100	385,00A4
M 16 x 120	S	25	2440,00A2	M 4 x 45	S	100	107,00A4	M 10 x 60	S	50	400,00A4
M 16 x 130	S	25	2750,00A2	M 4 x 50	S	100	107,00A4	M 10 x 70	S	50	485,00A4
M 16 x 140	S	25	3050,00A2	M 5 x 6	S	100	91,00A4	M 10 x 80	S	50	610,00A4
M 16 x 150	S	25	3200,00A2	M 5 x 8	S	100	81,00A4	M 10 x 90	S	50	720,00A4
M 20 x 40	S	25	1800,00A2	M 5 x 10	S	500	79,00A4	M 10 x 100	S	50	840,00A4
M 20 x 45	S	25	1800,00A2	M 5 x 10	K	100	84,00A4	M 10 x 120	S	50	1060,00A4
M 20 x 50	S	25	1800,00A2	M 5 x 12	S	500	76,00A4	M 12 x 20	S	50	410,00A4
M 20 x 55	S	25	1960,00A2	M 5 x 12	K	100	81,00A4	M 12 x 25	S	50	390,00A4
M 20 x 60	S	25	2060,00A2	M 5 x 14	S	500	86,00A4	M 12 x 30	S	50	375,00A4
M 20 x 70	S	25	2270,00A2	M 5 x 14	K	100	92,00A4	M 12 x 35	S	50	390,00A4
M 20 x 80	S	25	2750,00A2	M 5 x 16	S	500	62,00A4	M 12 x 40	S	50	420,00A4
M 20 x 90	S	25	2330,00A2	M 5 x 16	K	100	67,00A4	M 12 x 45	S	50	470,00A4
M 20 x 100	S	25	2850,00A2	M 5 x 18	S	500	88,00A4	M 12 x 50	S	50	485,00A4
M 20 x 110	S	25	4200,00A2	M 5 x 18	K	100	94,00A4	M 12 x 55	S	50	520,00A4
M 20 x 120	S	25	4300,00A2	M 5 x 20	S	500	67,00A4	M 12 x 60	S	50	630,00A4
M 20 x 130	S	1	4650,00A2	M 5 x 20	K	100	72,00A4	M 12 x 70	S	50	650,00A4
M 20 x 140	S	1	4750,00A2	M 5 x 25	S	500	70,00A4	M 12 x 80	S	50	750,00A4
M 20 x 150	S	1	4850,00A2	M 5 x 25	K	100	75,00A4	M 12 x 90	S	50	910,00A4
				M 5 x 30	S	200	76,00A4	M 12 x 100	S	50	1070,00A4
				M 5 x 35	S	200	84,00A4	M 12 x 110	S	25	1550,00A4
				M 5 x 40	S	200	105,00A4	M 12 x 120	S	25	1670,00A4
				M 5 x 45	S	100	99,00A4	M 16 x 25	S	25	1140,00A4
				M 5 x 50	S	100	112,00A4	M 16 x 30	S	1	1210,00A4
				M 5 x 55	S	100	130,00A4	M 16 x 35	S	1	1270,00A4
				M 5 x 60	S	100	138,00A4	M 16 x 40	S	1	1400,00A4
				M 6 x 8	S	100	181,00A4	M 16 x 45	S	1	1450,00A4
				M 6 x 10	S	100	93,00A4	M 16 x 50	S	1	1460,00A4
				M 6 x 12	S	500	88,00A4	M 16 x 55	S	1	1560,00A4
				M 6 x 12	K	100	94,00A4	M 16 x 60	S	1	1660,00A4
				M 6 x 14	S	500	107,00A4	M 16 x 70	S	1	1860,00A4
				M 6 x 14	K	100	112,00A4	M 16 x 80	S	1	2360,00A4
				M 6 x 16	S	500	69,00A4	M 16 x 90	S	1	2850,00A4
				M 6 x 16	K	100	74,00A4	M 16 x 100	S	1	3250,00A4
				M 6 x 18	S	200	113,00A4	M 16 x 110	S	1	4850,00A4
				M 6 x 20	S	200	70,00A4	M 16 x 120	S	1	4950,00A4
				M 6 x 25	S	200	86,00A4	M 16 x 130	S	1	5100,00A4
				M 6 x 30	S	200	96,00A4	M 16 x 140	S	1	5200,00A4
				M 6 x 35	S	200	107,00A4	M 16 x 150	S	1	5300,00A4
				M 6 x 40	S	200	128,00A4	M 20 x 40	S	1	2900,00A4
				M 6 x 45	S	100	181,00A4	M 20 x 45	S	1	3250,00A4
				M 6 x 50	S	100	186,00A4	M 20 x 50	S	1	3400,00A4
				M 6 x 55	S	100	290,00A4	M 20 x 55	S	1	3650,00A4
				M 6 x 60	S	100	335,00A4	M 20 x 60	S	1	3950,00A4
				M 6 x 70	S	100	405,00A4	M 20 x 70	S	1	4200,00A4
				M 6 x 80	S	100	485,00A4	M 20 x 80	S	1	5500,00A4
				M 6 x 90	S	100	630,00A4	M 20 x 90	S	1	7000,00A4
				M 6 x 100	S	100	780,00A4	M 20 x 100	S	1	7900,00A4
				M 8 x 10	S	100	295,00A4	M 20 x 110	S	1	10200,00A4
				M 8 x 12	S	200	270,00A4	M 20 x 120	S	1	10300,00A4
				M 8 x 14	S	200	244,00A4	M 20 x 130	S	1	10500,00A4
				M 8 x 16	S	200	129,00A4	M 20 x 140	S	1	10600,00A4
M 3 x 6	S	100	60,00A4								
M 3 x 8	S	100	60,00A4								
M 3 x 10	S	100	56,00A4								
M 3 x 12	S	100	43,50A4								
M 3 x 14	S	100	57,00A4								
M 3 x 16	S	100	55,00A4								

ISO 10642.940

10642 A4

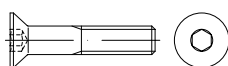

Senkschrauben mit Innensechskant

Ø > M 20: Kopfgeometrie nach DIN 7991, einige Fabrikate mit Gewinde bis Kopf

Achtung! Schrauben nur eingeschränkt belastbar.

Maße → TI-14 Anziehmomente → TI-249
Werkstoffeigensch. → TI-236

Stahl → S. 389



Abmessungen	VE	Stück	€/100/Obf.
M 20 x 150	S	1	10700,00 A4
M 24 x 50	S	1	4950,00 A4
M 24 x 55	S	1	4950,00 A4
M 24 x 60	S	1	4950,00 A4
M 24 x 70	S	1	5200,00 A4
M 24 x 80	S	1	6500,00 A4
M 24 x 90	S	1	8000,00 A4
M 24 x 100	S	1	8800,00 A4
M 24 x 110	S	1	11200,00 A4
M 24 x 120	S	1	11300,00 A4
M 24 x 140	S	1	11500,00 A4
M 24 x 150	S	1	11600,00 A4

DIN 11024.940
11024 A 4

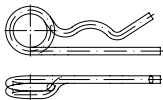

Federstecker

Maße → **TI-123** Werkstoffeigensch. → **TI-236**
Stahl → **S. 395**

RoHS ✓ REACH SVHC free

Für Bohrungsloch Ø (Tol. H13) / Wellen Ø von - bis

2,5 / 9 -11,2	S	25	2190,00 A4
3,2 / 11,3 -14	S	25	2350,00 A4
4 / 14,1 -20	S	25	3900,00 A4
5 / 20,1 -26	S	10	4800,00 A4
6,3 / 26,1 -34	S	10	6900,00 A4
7 / 34,1 -45	S	10	8500,00 A4
8 / 45,1 -56	S	10	20600,00 A4

~DIN 11024.922
11024 A 2



Federstecker, einfach

Maße → **TI-123** Werkstoffeigensch. → **TI-236**
Stahl → **S. 395**

RoHS ✓ REACH SVHC free

Draht Ø

2	S	25	1580,00
3	S	25	1860,00
4	S	25	2330,00
5	S	25	3750,00
6	S	25	5200,00

Abmessungen VE Stück €/100/Obf.
ISO 14581.920
14581 A 2



Senkschrauben mit Innensechsrund

Achtung! Schrauben nur eingeschränkt belastbar.

Maße → **TI-15** Werkstoffeigensch. → **TI-236**

RoHS ✓ REACH SVHC free

M 2 x 3 - T6	S	2000	22,80 A2
M 2 x 4 - T6	S	2000	24,70 A2
M 2 x 5 - T6	S	2000	27,00 A2
M 2 x 6 - T6	S	2000	30,00 A2
M 2 x 8 - T6	S	2000	32,00 A2
M 2 x 10 - T6	S	2000	34,00 A2
M 2 x 12 - T6	S	2000	35,50 A2
M 2,5 x 4 - T8	S	2000	22,80 A2
M 2,5 x 5 - T8	S	1000	15,60 A2
M 2,5 x 6 - T8	S	1000	15,90 A2
M 2,5 x 8 - T8	S	1000	16,30 A2
M 2,5 x 10 - T8	S	1000	16,90 A2
M 2,5 x 12 - T8	S	1000	17,80 A2
M 2,5 x 16 - T8	S	1000	19,50 A2
M 2,5 x 20 - T8	S	1000	20,50 A2
M 2,5 x 25 - T8	S	1000	28,50 A2
M 3 x 4 - T10	S	1000	19,00 A2
M 3 x 5 - T10	S	1000	15,90 A2
M 3 x 6 - T10	S	1000	10,60 A2
M 3 x 8 - T10	S	1000	11,20 A2
M 3 x 10 - T10	S	1000	12,00 A2
M 3 x 12 - T10	S	1000	12,50 A2
M 3 x 16 - T10	S	1000	13,70 A2
M 3 x 20 - T10	S	1000	15,80 A2
M 3 x 22 - T10	S	1000	11,50 A2
M 3 x 25 - T10	S	1000	17,10 A2
M 3 x 30 - T10	S	1000	25,50 A2
M 4 x 5 - T20	S	1000	21,40 A2
M 4 x 6 - T20	S	1000	16,90 A2
M 4 x 8 - T20	S	1000	17,10 A2
M 4 x 10 - T20	S	1000	17,60 A2
M 4 x 12 - T20	S	1000	18,60 A2
M 4 x 16 - T20	S	1000	21,10 A2
M 4 x 20 - T20	S	1000	23,10 A2
M 4 x 25 - T20	S	1000	27,00 A2
M 4 x 30 - T20	S	1000	32,00 A2
M 4 x 35 - T20	S	500	40,00 A2
M 4 x 40 - T20	S	500	43,00 A2
M 5 x 6 - T25	S	1000	33,50 A2
M 5 x 8 - T25	S	500	29,50 A2
M 5 x 10 - T25	S	500	30,00 A2
M 5 x 12 - T25	S	500	30,00 A2
M 5 x 14 - T25	S	500	42,00 A2
M 5 x 16 - T25	S	500	33,50 A2
M 5 x 20 - T25	S	500	24,30 A2
M 5 x 25 - T25	S	500	43,00 A2
M 5 x 30 - T25	S	500	50,00 A2
M 5 x 35 - T25	S	500	56,00 A2
M 5 x 40 - T25	S	200	66,00 A2
M 5 x 45 - T25	S	200	80,00 A2
M 5 x 50 - T25	S	200	105,00 A2
M 6 x 8 - T30	S	1000	28,50 A2
M 6 x 10 - T30	S	200	20,50 A2
M 6 x 12 - T30	S	200	39,00 A2
M 6 x 16 - T30	S	200	44,50 A2

Abmessungen	VE	Stück	€/100/Obf.
M 6 x 20 - T30	S	200	48,50 A2
M 6 x 25 - T30	S	200	54,00 A2
M 6 x 30 - T30	S	200	64,00 A2
M 6 x 35 - T30	S	200	84,00 A2
M 6 x 40 - T30	S	200	87,00 A2
M 6 x 45 - T30	S	200	87,00 A2
M 6 x 50 - T30	S	200	156,00 A2
M 6 x 60 - T30	S	200	158,00 A2
M 8 x 12 - T45	S	100	161,00 A2
M 8 x 16 - T45	S	100	190,00 A2
M 8 x 20 - T45	S	100	209,00 A2
M 8 x 25 - T45	S	100	247,00 A2
M 8 x 30 - T45	S	100	285,00 A2
M 8 x 35 - T45	S	100	315,00 A2
M 8 x 40 - T45	S	100	345,00 A2
M 8 x 45 - T45	S	100	380,00 A2
M 8 x 50 - T45	S	100	410,00 A2
M 8 x 55 - T45	S	100	445,00 A2
M 8 x 60 - T45	S	50	475,00 A2

ISO 14581.940
14581 A 4

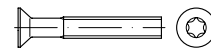

Senkschrauben mit Innensechsrund

Achtung! Schrauben nur eingeschränkt belastbar.

Maße → **TI-15** Werkstoffeigensch. → **TI-236**

RoHS ✓ REACH SVHC free

M 3 x 5 - T10	S	1000	31,50 A4
M 3 x 6 - T10	S	1000	21,00 A4
M 3 x 8 - T10	S	1000	23,10 A4
M 3 x 10 - T10	S	1000	24,20 A4
M 4 x 8 - T20	S	1000	34,00 A4
M 4 x 10 - T20	S	1000	36,00 A4
M 4 x 12 - T20	S	1000	37,00 A4
M 4 x 16 - T20	S	1000	42,00 A4
M 4 x 20 - T20	S	1000	46,50 A4
M 5 x 10 - T25	S	500	74,00 A4
M 5 x 12 - T25	S	500	80,00 A4
M 5 x 16 - T25	S	500	89,00 A4
M 5 x 20 - T25	S	500	93,00 A4
M 5 x 25 - T25	S	500	95,00 A4
M 5 x 30 - T25	S	500	99,00 A4
M 6 x 10 - T30	S	200	68,00 A4
M 6 x 16 - T30	S	200	89,00 A4
M 6 x 20 - T30	S	200	95,00 A4
M 6 x 25 - T30	S	200	105,00 A4
M 6 x 30 - T30	S	200	124,00 A4
M 6 x 35 - T30	S	200	162,00 A4
M 6 x 40 - T30	S	200	168,00 A4
M 6 x 45 - T30	S	200	210,00 A4
M 6 x 50 - T30	S	200	305,00 A4
M 8 x 16 - T45	S	200	83,00 A4
M 8 x 20 - T45	S	200	95,00 A4
M 8 x 25 - T45	S	100	485,00 A4
M 8 x 30 - T45	S	100	560,00 A4
M 8 x 35 - T45	S	100	610,00 A4
M 8 x 40 - T45	S	100	670,00 A4
M 8 x 45 - T45	S	100	720,00 A4
M 8 x 50 - T45	S	100	770,00 A4

Abmessungen	VE Stück	€/100/Obf.
ISO	14583.920	
14583 A 2		

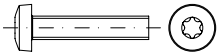

Flachkopfschrauben mit Innensechsrund

Maße → **TI-40** Werkstoffeigensch. → **TI-236**
 Stahl → **S. 405**

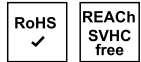

M 1,6	x	2	S	1000	57,00A2
M 1,6	x	3	S	1000	47,50A2
M 1,6	x	4	S	1000	45,50A2
M 1,6	x	5	S	1000	46,50A2
M 1,6	x	6	S	1000	47,50A2
M 1,6	x	8	S	1000	52,00A2
M 1,6	x	10	S	1000	57,00A2
M 1,6	x	12	S	1000	67,00A2
M 1,6	x	16	S	1000	80,00A2
M 2	x	2	S	1000	57,00A2
M 2	x	3	S	1000	47,50A2
M 2	x	4	S	1000	45,50A2
M 2	x	5	S	1000	46,50A2
M 2	x	6	S	1000	47,50A2
M 2	x	8	S	1000	52,00A2
M 2	x	10	S	1000	57,00A2
M 2	x	12	S	1000	67,00A2
M 2	x	16	S	1000	80,00A2
M 2	x	20	S	1000	95,00A2
M 2,5	x	3	S	1000	28,50A2
M 2,5	x	4	S	1000	20,10A2
M 2,5	x	5	S	1000	20,50A2
M 2,5	x	6	S	1000	16,30A2
M 2,5	x	8	S	1000	16,50A2
M 2,5	x	10	S	1000	16,90A2
M 2,5	x	12	S	1000	18,00A2
M 2,5	x	16	S	1000	19,20A2
M 2,5	x	20	S	1000	22,20A2
M 2,5	x	25	S	1000	34,50A2
M 3	x	4	S	1000	12,40A2
M 3	x	5	S	1000	11,40A2
M 3	x	6	S	1000	10,60A2
M 3	x	8	S	1000	11,20A2
M 3	x	10	S	1000	12,00A2
M 3	x	12	S	1000	12,50A2
M 3	x	16	S	1000	14,80A2
M 3	x	20	S	1000	15,80A2
M 3	x	25	S	1000	17,30A2
M 3	x	30	S	1000	27,50A2
M 4	x	5	S	1000	22,80A2
M 4	x	6	S	1000	16,90A2
M 4	x	8	S	1000	17,10A2
M 4	x	10	S	1000	17,60A2
M 4	x	12	S	1000	18,60A2
M 4	x	16	S	1000	23,90A2
M 4	x	20	S	1000	24,30A2
M 4	x	25	S	1000	27,50A2
M 4	x	30	S	1000	34,50A2
M 4	x	35	S	500	47,00A2
M 4	x	40	S	500	61,00A2
M 5	x	6	S	500	42,50A2
M 5	x	8	S	500	29,50A2
M 5	x	10	S	500	30,00A2
M 5	x	12	S	500	30,50A2
M 5	x	20	S	500	37,50A2

Abmessungen	VE Stück	€/100/Obf.			
M 5	x	25	S	500	43,00A2
M 5	x	30	S	500	49,50A2
M 5	x	35	S	500	56,00A2
M 5	x	40	S	500	66,00A2
M 5	x	45	S	500	80,00A2
M 5	x	50	S	500	105,00A2
M 6	x	8	S	200	37,50A2
M 6	x	10	S	200	37,50A2
M 6	x	12	S	500	39,50A2
M 6	x	16	S	200	43,00A2
M 6	x	20	S	200	48,50A2
M 6	x	25	S	200	54,00A2
M 6	x	30	S	200	64,00A2
M 6	x	35	S	200	71,00A2
M 6	x	40	S	200	80,00A2
M 6	x	45	S	200	98,00A2
M 6	x	50	S	200	124,00A2
M 6	x	60	S	200	167,00A2
M 8	x	10	S	500	209,00A2
M 8	x	12	S	500	180,00A2
M 8	x	16	S	500	199,00A2
M 8	x	20	S	500	214,00A2
M 8	x	25	S	500	237,00A2
M 8	x	30	S	500	260,00A2
M 8	x	35	S	500	280,00A2
M 8	x	40	S	500	305,00A2
M 8	x	45	S	200	325,00A2
M 8	x	50	S	200	345,00A2
M 8	x	55	S	200	370,00A2
M 8	x	60	S	200	390,00A2
M10	x	12	S	200	335,00A2
M10	x	16	S	200	300,00A2
M10	x	20	S	200	325,00A2
M10	x	25	S	200	360,00A2
M10	x	30	S	200	390,00A2
M10	x	35	S	200	430,00A2
M10	x	40	S	200	465,00A2
M10	x	45	S	100	520,00A2
M10	x	50	S	100	530,00A2
M10	x	55	S	100	560,00A2
M10	x	60	S	100	590,00A2

ISO	14585.923
14585 A 2 Form C	

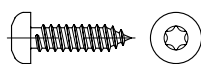

Linien-Bleederschrauben mit Innensechsrund, C = mit Spitze

Maße → **TI-46** Werkstoffeigensch. → **TI-236**
 Stahl → **S. 405**

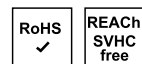

2,9	x	6,5 -C	S	1000	13,90A2
2,9	x	9,5 -C	S	1000	7,40A2
2,9	x	13 -C	S	1000	7,80A2
2,9	x	16 -C	S	1000	8,60A2
2,9	x	19 -C	S	1000	9,10A2
2,9	x	22 -C	S	1000	15,40A2
2,9	x	25 -C	S	1000	15,90A2
3,5	x	9,5 -C	S	1000	9,70A2
3,5	x	13 -C	S	1000	10,30A2
3,5	x	16 -C	S	1000	10,80A2
3,5	x	19 -C	S	1000	12,00A2
3,5	x	22 -C	S	1000	15,00A2

Abmessungen	VE Stück	€/100/Obf.			
3,5	x	25 -C	S	1000	15,60A2
3,5	x	32 -C	S	1000	17,60A2
3,5	x	38 -C	S	1000	19,80A2
3,9	x	9,5 -C	S	1000	11,70A2
3,9	x	13 -C	S	1000	11,70A2
3,9	x	16 -C	S	1000	12,50A2
3,9	x	19 -C	S	1000	13,70A2
3,9	x	22 -C	S	500	16,80A2
3,9	x	25 -C	S	500	17,40A2
3,9	x	32 -C	S	500	20,90A2
3,9	x	38 -C	S	500	23,60A2
3,9	x	45 -C	S	500	29,50A2
3,9	x	50 -C	S	500	32,00A2
4,2	x	9,5 -C	S	1000	8,80A2
4,2	x	13 -C	S	1000	13,40A2
4,2	x	16 -C	S	1000	15,20A2
4,2	x	19 -C	S	500	16,40A2
4,2	x	22 -C	S	500	18,50A2
4,2	x	25 -C	S	500	19,10A2
4,2	x	32 -C	S	500	23,60A2
4,2	x	38 -C	S	500	27,00A2
4,2	x	45 -C	S	500	39,00A2
4,2	x	50 -C	S	500	44,00A2
4,2	x	60 -C	S	500	79,00A2
4,8	x	9,5 -C	S	500	24,80A2
4,8	x	13 -C	S	500	17,10A2
4,8	x	16 -C	S	500	18,50A2
4,8	x	19 -C	S	500	20,90A2
4,8	x	22 -C	S	500	23,60A2
4,8	x	25 -C	S	500	24,20A2
4,8	x	32 -C	S	250	31,00A2
4,8	x	38 -C	S	250	34,50A2
4,8	x	45 -C	S	250	45,00A2
4,8	x	50 -C	S	250	46,50A2
4,8	x	55 -C	S	250	98,00A2
4,8	x	60 -C	S	250	63,00A2
4,8	x	70 -C	S	250	83,00A2
4,8	x	80 -C	S	250	98,00A2
4,8	x	90 -C	S	100	127,00A2
4,8	x	100 -C	S	100	160,00A2
5,5	x	13 -C	S	500	28,00A2
5,5	x	16 -C	S	500	30,00A2
5,5	x	19 -C	S	500	32,00A2
5,5	x	22 -C	S	500	35,00A2
5,5	x	25 -C	S	500	37,50A2
5,5	x	32 -C	S	250	43,50A2
5,5	x	38 -C	S	250	49,50A2
5,5	x	45 -C	S	250	59,00A2
5,5	x	50 -C	S	250	66,00A2
5,5	x	60 -C	S	250	79,00A2
5,5	x	70 -C	S	250	94,00A2
5,5	x	80 -C	S	250	114,00A2
6,3	x	13 -C	S	500	31,50A2
6,3	x	16 -C	S	500	32,00A2
6,3	x	19 -C	S	500	34,50A2
6,3	x	22 -C	S	500	37,50A2
6,3	x	25 -C	S	500	40,00A2
6,3	x	32 -C	S	250	48,00A2
6,3	x	38 -C	S	250	53,00A2
6,3	x	45 -C	S	250	64,00A2
6,3	x	50 -C	S	250	79,00A2
6,3	x	60 -C	S	250	95,00A2
6,3	x	70 -C	S	250	114,00A2

Abmessungen	VE Stück	€/100/Obf.
ISO 14586.923		
14586 A 2 Form C		



Senk-Blechschraben mit Innensechsrund, C = mit Spitze

Senk $\leq 90^\circ$

Maße \rightarrow TI-47

Werkstoffeigensch. \rightarrow TI-236

Stahl \rightarrow S. 404



2,9	x	6,5 -C	S	1000	13,90
2,9	x	9,5 -C	S	1000	7,40
2,9	x	13 -C	S	1000	7,80
2,9	x	16 -C	S	1000	8,60
2,9	x	19 -C	S	1000	9,10
2,9	x	22 -C	S	1000	15,40
2,9	x	25 -C	S	1000	15,90
3,5	x	9,5 -C	S	1000	9,70
3,5	x	13 -C	S	1000	10,30
3,5	x	16 -C	S	1000	10,80
3,5	x	19 -C	S	1000	12,00
3,5	x	22 -C	S	1000	15,00
3,5	x	25 -C	S	1000	15,60
3,5	x	32 -C	S	1000	17,60
3,5	x	38 -C	S	1000	19,80
3,9	x	9,5 -C	S	1000	11,70
3,9	x	13 -C	S	1000	11,70
3,9	x	16 -C	S	1000	12,50
3,9	x	19 -C	S	1000	13,70
3,9	x	22 -C	S	500	16,80
3,9	x	25 -C	S	500	17,40
3,9	x	32 -C	S	500	20,90
3,9	x	38 -C	S	500	23,60
3,9	x	45 -C	S	500	29,50
3,9	x	50 -C	S	500	32,00
4,2	x	9,5 -C	S	1000	13,10
4,2	x	13 -C	S	1000	13,40
4,2	x	16 -C	S	1000	15,20
4,2	x	19 -C	S	500	16,40
4,2	x	22 -C	S	500	18,50
4,2	x	25 -C	S	500	19,10
4,2	x	32 -C	S	500	23,60
4,2	x	38 -C	S	500	27,00
4,2	x	45 -C	S	500	39,00
4,2	x	50 -C	S	500	44,00
4,2	x	60 -C	S	500	79,00
4,8	x	9,5 -C	S	500	24,80
4,8	x	13 -C	S	500	17,10
4,8	x	16 -C	S	500	18,50
4,8	x	19 -C	S	500	20,90
4,8	x	22 -C	S	500	23,60
4,8	x	25 -C	S	500	24,20
4,8	x	32 -C	S	250	31,00
4,8	x	38 -C	S	250	34,50
4,8	x	45 -C	S	250	45,00
4,8	x	50 -C	S	250	46,50
4,8	x	55 -C	S	250	98,00
4,8	x	60 -C	S	250	63,00
4,8	x	70 -C	S	250	83,00
4,8	x	80 -C	S	250	98,00
4,8	x	90 -C	S	100	127,00
4,8	x	100 -C	S	100	160,00

Abmessungen	VE Stück	€/100/Obf.
5,5 x 13 -C	S 500	28,00
5,5 x 16 -C	S 500	30,00
5,5 x 19 -C	S 500	32,00
5,5 x 22 -C	S 500	35,00
5,5 x 25 -C	S 500	37,50
5,5 x 32 -C	S 250	43,50
5,5 x 38 -C	S 250	49,50
5,5 x 45 -C	S 250	59,00
5,5 x 50 -C	S 250	66,00
5,5 x 60 -C	S 250	79,00
5,5 x 70 -C	S 250	94,00
5,5 x 80 -C	S 250	114,00
6,3 x 13 -C	S 500	31,50
6,3 x 16 -C	S 500	32,00
6,3 x 19 -C	S 500	34,50
6,3 x 22 -C	S 500	37,50
6,3 x 25 -C	S 500	40,00
6,3 x 32 -C	S 250	48,00
6,3 x 38 -C	S 250	53,00
6,3 x 45 -C	S 250	64,00
6,3 x 50 -C	S 250	79,00
6,3 x 60 -C	S 250	95,00
6,3 x 70 -C	S 250	114,00

Abmessungen	VE Stück	€/100/Obf.
ISO 14586.943		
14586 A 4 Form C		



Senk-Blechschraben mit Innensechsrund, C = mit Spitze

Senk $\leq 90^\circ$

Maße \rightarrow TI-47

Werkstoffeigensch. \rightarrow TI-236

Stahl \rightarrow S. 404

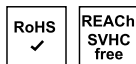

2,9	x	6,5 -T10	S	1000	18,40
2,9	x	9,5 -T10	S	1000	9,90
2,9	x	13 -T10	S	1000	10,40
2,9	x	16 -T10	S	1000	11,40
2,9	x	19 -T10	S	1000	12,10
2,9	x	22 -T10	S	1000	20,40
2,9	x	25 -T10	S	1000	21,20
3,5	x	9,5 -T15	S	1000	12,90
3,5	x	13 -T15	S	1000	13,60
3,5	x	16 -T15	S	1000	14,40
3,5	x	19 -T15	S	1000	15,90
3,5	x	22 -T15	S	1000	19,90
3,5	x	25 -T15	S	1000	20,70
3,5	x	32 -T15	S	1000	23,50
3,5	x	38 -T15	S	1000	26,50
3,9	x	9,5 -T15	S	1000	15,50
3,9	x	13 -T15	S	1000	15,50
3,9	x	16 -T15	S	1000	16,70
3,9	x	19 -T15	S	1000	18,20
3,9	x	22 -T15	S	500	22,30
3,9	x	25 -T15	S	500	23,10
3,9	x	32 -T15	S	500	28,00
3,9	x	38 -T15	S	500	31,50
3,9	x	45 -T15	S	500	39,00
3,9	x	50 -T15	S	500	42,00
4,2	x	9,5 -T20	S	1000	17,40
4,2	x	13 -T20	S	1000	17,80
4,2	x	16 -T20	S	1000	20,20

Abmessungen	VE Stück	€/100/Obf.
4,2 x 19 -T20	S 500	21,80
4,2 x 22 -T20	S 500	24,60
4,2 x 25 -T20	S 500	25,50
4,2 x 32 -T20	S 500	31,50
4,2 x 38 -T20	S 500	36,00
4,2 x 45 -T20	S 500	52,00
4,2 x 50 -T20	S 500	59,00
4,2 x 60 -T20	S 500	104,00
4,8 x 9,5 -T25	S 500	33,00
4,8 x 13 -T25	S 500	22,70
4,8 x 16 -T25	S 500	24,60
4,8 x 19 -T25	S 500	28,00
4,8 x 22 -T25	S 500	31,50
4,8 x 25 -T25	S 500	32,50
4,8 x 32 -T25	S 250	41,00
4,8 x 38 -T25	S 250	46,00
4,8 x 45 -T25	S 250	60,00
4,8 x 50 -T25	S 250	62,00
4,8 x 55 -T25	S 250	131,00
4,8 x 60 -T25	S 250	84,00
4,8 x 70 -T25	S 250	110,00
4,8 x 80 -T25	S 250	130,00
4,8 x 90 -T25	S 100	168,00
4,8 x 100 -T25	S 100	213,00
5,5 x 13 -T25	S 500	37,50
5,5 x 16 -T25	S 500	39,50
5,5 x 19 -T25	S 500	42,00
5,5 x 22 -T25	S 500	46,50
5,5 x 25 -T25	S 500	49,50
5,5 x 32 -T25	S 250	58,00
5,5 x 38 -T25	S 250	66,00
5,5 x 45 -T25	S 250	79,00
5,5 x 50 -T25	S 250	88,00
5,5 x 60 -T25	S 250	105,00
5,5 x 70 -T25	S 250	125,00
5,5 x 80 -T25	S 250	152,00
6,3 x 19 -T30	S 500	45,50
6,3 x 22 -T30	S 500	50,00
6,3 x 25 -T30	S 500	53,00
6,3 x 32 -T30	S 250	64,00
6,3 x 38 -T30	S 250	71,00
6,3 x 45 -T30	S 250	84,00
6,3 x 50 -T30	S 250	105,00
6,3 x 60 -T30	S 250	126,00
6,3 x 70 -T30	S 250	152,00

EN 16983.960	
16983 1.4310/1.4568*	

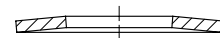

Tellerfedern

*t ≤ 2 mm = 1.4310 oder 1.4568; t > 2mm = 1.4568

Achtung! Reduzierte Federkräfte.

Produktinformation \rightarrow TI-141

Stahl \rightarrow S. 407



Außen \varnothing x Innen \varnothing x Dicke t

8	x	3,2	x	0,5	S	200	71,00
8	x	4,2	x	0,3	S	200	67,00
8	x	4,2	x	0,4	S	200	69,00
10	x	5,2	x	0,4	S	200	74,00
10	x	5,2	x	0,5	S	200	77,00
12,5	x	6,2	x	0,5	S	200	87,00
12,5	x	6,2	x	0,7	S	200	101,00

Abmessungen	VE	Stück	€/100/Obf.
15 x 8,2 x 0,8 S 200			118,00
16 x 8,2 x 0,6 S 200			110,00
16 x 8,2 x 0,9 S 200			131,00
18 x 9,2 x 0,7 S 200			131,00
18 x 9,2 x 1 S 200			158,00
20 x 8,2 x 0,5 S 200			124,00
20 x 10,2 x 0,6 S 200			135,00
20 x 10,2 x 0,8 S 200			156,00
20 x 10,2 x 0,9 S 200			165,00
20 x 10,2 x 1 S 200			175,00
20 x 10,2 x 1,1 S 200			182,00
25 x 12,2 x 0,9 S 200			209,00
25 x 12,2 x 1,5 S 200			290,00
28 x 14,2 x 1 S 200			260,00
28 x 14,2 x 1,5 S 200			340,00
31,5 x 16,3 x 1,25 S 200			710,00
31,5 x 16,3 x 1,75 S 200			940,00
31,5 x 16,3 x 2 S 200			970,00
35,5 x 18,3 x 1,25 S 100			870,00
35,5 x 18,3 x 2 S 100			1310,00
40 x 20,4 x 1,5 S 100			1250,00
40 x 20,4 x 2 S 100			1630,00
40 x 20,4 x 2,25 S 100			1820,00

DIN 71412.941
71412 A 4 Form A-M



Kegelschmiernippel, kurz, mit Sechskant, A = Kegelpfopf gerade/axial M = mit metrischem Kegelnippel

Maße → TI-25 Werkstoffeigensch. → TI-236
 Stahl → S. 409

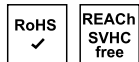

Kegelnippel M x Steigung/Schlüsselweite SW

AM 6 x 1 SW 7 S 50	2750,00 A4
AM 8 x 1 SW 9 S 50	2900,00 A4
AM 10 x 1 SW 11 S 25	3050,00 A4

DIN 80704.940
80704 A 4

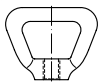

Korbmuttern

Maße → TI-129 Werkstoffeigensch. → TI-236

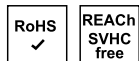

M 8 S 1	9400,00 A4
M 10 S 1	9900,00 A4
M 12 S 1	12000,00 A4
M 16 S 1	14100,00 A4
M 20 S 1	16800,00 A4

Abmessungen VE Stück €/100/Obf.
 ASME B 83934.944
18.2.2 A 4 UNC

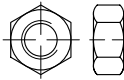

Hex nuts Sechskantmutter mit UNC-Gewinde

Maße → TI-61 Anziehmomente → TI-246
 Werkstoffeigensch. → TI-236



Ø in Inch

1/4 S 100	137,00 A4
3/8 S 100	275,00 A4
1/2 S 50	460,00 A4
5/8 S 25	810,00 A4

Artikel 88087.910
88087 A 1

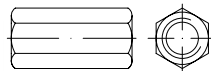

Verbindungsreifen, Sechskant, durchgehendes Innengewinde,

Produktklasse C (g), Gewinde: 6H, Toleranzen: s/Ø = h13, l = ± 1,0, Gewindeeinschraubtiefe: Gruppe N = max 1.5d

Maße → TI-66 Werkstoffeigensch. → TI-236

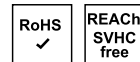

Innengewinde x Länge/Schlüsselweite (SW)

M 6 x 25 SW10 S 50	560,00 A1/A2
M 8 x 30 SW13 S 50	1140,00 A1/A2
M 10 x 30 SW17 S 25	1950,00 A1/A2
M 12 x 40 SW19 S 25	2850,00 A1/A2
M 16 x 50 SW24 S 10	4950,00 A1/A2
M 20 x 50 SW30 S 10	7500,00 A1/A2
M 24 x 50 SW36 S 5	10600,00 A1/A2
M 30 x 60 SW46 S 5	16500,00 A1/A2

Abmessungen VE Stück €/100/Obf.
 Artikel 88088.920
88088 A 2

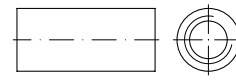

Verbindungsreifen, rund, durchgehendes Innengewinde,

Produktklasse C (g), Gewindeeinschraubtiefe: Gruppe N = max 1.5d

Maße → TI-77 Werkstoffeigensch. → TI-236

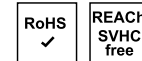

Innengewinde x Länge x Außen Ø

M 6 x 25 x 10 S 50	530,00 A2
M 6 x 30 x 10 S 50	650,00 A2
M 8 x 25 x 11 S 50	670,00 A2
M 8 x 30 x 11 S 50	830,00 A2
M 10 x 30 x 13 S 25	1010,00 A2
M 12 x 30 x 15 S 25	1310,00 A2
M 16 x 40 x 22 S 10	3150,00 A2

Artikel 88089.944
88089 A 4

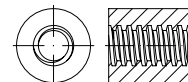

Rundmutter mit Trapezgewinde, Höhe = 1,5 d

Gewindestangen TR → DIN 975 Trapez

Maße → TI-77 Werkstoffeigensch. → TI-236

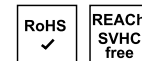

Gewinde x Steigung x Außen Ø x Höhe

TR 16 x 4-36 S 1	15800,00 A4
TR 20 x 4-36 S 1	19800,00 A4
TR 24 x 5-50 S 1	26100,00 A4
TR 30 x 6-60 S 1	40300,00 A4

Abmessungen	VE Stück	€/100/Obf.
Artikel	88091.920	
88091	A 2	SPAX Seko-T



SPAX Universalschrauben mit SPAX 4CUT-Spitze, Seko = SPAX MULTI-Senkopf T = T-STAR plus
gleitbeschichtet

Achtung! Geringere Festigkeit gegenüber gehärtetem Stahl.

- Bits → Artikel 88663, 88654
- Zierkappen → Artikel 88006

Zulassungen: Z-9.1-235, ETA-12/0114



Nenn Ø x Nennlänge / Gewindelänge ca. - Bit-Größe

3	x	12/10-T10	K	200	5,25 A2
3	x	16/13-T10	K	200	5,55 A2
3	x	20/16-T10	K	200	6,25 A2
3	x	25/21-T10	K	200	6,45 A2
3	x	30/26-T10	K	200	7,00 A2
3	x	35/31-T10	K	200	10,40 A2
3	x	40/36-T10	K	200	11,05 A2
3,5	x	16/12-T20*	K	200	6,30 A2
3,5	x	20/15-T20*	K	200	7,00 A2
3,5	x	25/20-T20*	K	200	7,15 A2
3,5	x	30/25-T20*	K	200	7,45 A2
3,5	x	35/30-T20*	K	200	8,35 A2
3,5	x	40/35-T20*	K	200	9,10 A2
4	x	20/15-T20	K	200	8,35 A2
4	x	25/20-T20	K	200	8,85 A2
4	x	30/25-T20	K	200	9,70 A2
4	x	35/30-T20	K	200	10,40 A2
4	x	40/35-T20	K	200	11,10 A2
4	x	45/40-T20	K	200	11,45 A2
4	x	50/45-T20	K	200	11,90 A2
4	x	60/50-T20	K	100	18,15 A2
4,5	x	25/19-T20	K	200	10,40 A2
4,5	x	30/24-T20	K	200	11,05 A2
4,5	x	35/29-T20	K	200	12,15 A2
4,5	x	40/34-T20	K	200	13,35 A2
4,5	x	45/39-T20	K	200	14,60 A2
4,5	x	50/44-T20	K	200	15,80 A2
4,5	x	60/54-T20	K	100	20,90 A2
4,5	x	70/59-T20	K	100	24,05 A2
5	x	30/24-T20	K	200	12,50 A2
5	x	35/29-T20	K	200	13,90 A2
5	x	40/34-T20	K	200	15,80 A2
5	x	45/39-T20	K	200	17,75 A2
5	x	50/44-T20	K	200	19,60 A2
5	x	60/54-T20	K	100	24,05 A2
5	x	70/60-T20	K	100	34,50 A2
5	x	80/60-T20	K	100	41,50 A2
6	x	40/34-T30	K	200	31,00 A2
6	x	50/43-T30	K	100	34,50 A2
6	x	60/53-T30	K	100	41,00 A2
6	x	70/61-T30	K	100	42,50 A2
6	x	80/61-T30	K	100	43,50 A2

Abmessungen	VE Stück	€/100/Obf.
Artikel	88091.929	
88091	A 2	SPAX Seko-T-Tg



SPAX Universalschrauben mit SPAX 4CUT-Spitze, Seko = SPAX MULTI-Senkopf T = T-STAR plus Tg = Teilgewinde
gleitbeschichtet,
6x160 mit CUT-Spitze

Achtung! Geringere Festigkeit gegenüber gehärtetem Stahl.

- Bits → Artikel 88663, 88654
- Zierkappen → Artikel 88006

Zulassungen: Z-9.1-235, ETA-12/0114



Nenn Ø x Nennlänge / Gewindelänge ca. - Bit-Größe

3,5	x	30/18-T20*	K	200	7,45 A2
3,5	x	35/23-T20*	K	200	8,35 A2
3,5	x	40/23-T20*	K	200	9,10 A2
4	x	30/18-T20	K	200	9,70 A2
4	x	35/23-T20	K	200	10,40 A2
4	x	40/23-T20	K	200	11,10 A2
4	x	45/30-T20	K	200	11,45 A2
4	x	50/32-T20	K	200	11,90 A2
4,5	x	40/25-T20	K	200	13,35 A2
4,5	x	45/30-T20	K	200	14,60 A2
4,5	x	50/32-T20	K	200	15,80 A2
4,5	x	60/37-T20	K	100	20,90 A2
4,5	x	70/42-T20	K	100	24,05 A2
5	x	40/27-T20	K	200	15,80 A2
5	x	45/30-T20	K	200	17,75 A2
5	x	50/32-T20	K	200	19,60 A2
5	x	60/37-T20	K	100	24,05 A2
5	x	70/41-T20	K	100	34,50 A2
5	x	80/46-T20	K	100	41,50 A2
5	x	90/61-T20	K	100	48,50 A2
5	x	100/61-T20	K	100	57,00 A2
5	x	120/68-T20	K	100	62,00 A2
6	x	60/37-T30	K	100	41,00 A2
6	x	70/41-T30	K	100	42,50 A2
6	x	80/46-T30	K	100	43,50 A2
6	x	90/61-T30	K	100	48,00 A2
6	x	100/61-T30	K	100	52,00 A2
6	x	120/68-T30	K	100	63,00 A2
6	x	140/68-T30	K	100	86,00 A2
6	x	160/68-T30	K	100	110,00 A2

Abmessungen	VE Stück	€/100/Obf.
Artikel	88092.925	
88092	A 2	SPAX Liko-T



SPAX Universalschrauben mit SPAX 4CUT-Spitze, Liko = SPAX MULTI-Linsensenkopf T = T-STAR plus
gleitbeschichtet

Achtung! Geringere Festigkeit gegenüber gehärtetem Stahl.

- Bits → Artikel 88663, 88654
- Zierkappen → Artikel 88006

Zulassungen: Z-9.1-235, ETA-12/0114



Nenn Ø x Nennlänge / Gewindelänge ca. - Bit-Größe

3	x	20/16-T10	K	200	7,15 A2
3	x	25/21-T10	K	200	7,35 A2
3,5	x	16/13-T15	K	200	7,20 A2
3,5	x	20/16-T15	K	200	8,05 A2
3,5	x	30/25-T15	K	200	8,60 A2
4	x	30/25-T20	K	200	11,05 A2
4	x	40/35-T20	K	200	12,65 A2
4	x	45/40-T20	K	200	13,35 A2

Artikel	88093.924
88093	A 2
	SPAX Ruko-T



SPAX Universalschrauben mit SPAX 4CUT-Spitze, Ruko = Halbrundkopf T = T-STAR plus
gleitbeschichtet

Achtung! Geringere Festigkeit gegenüber gehärtetem Stahl.

- Bits → Artikel 88663, 88654
- Zierkappen → Artikel 88006

Zulassungen: Z-9.1-235, ETA-12/0114



Nenn Ø x Nennlänge/Gewindelänge ca. - Bit-Größe

3	x	20/16-T10	K	200	7,45 A2
3	x	30/26-T10	K	200	8,40 A2
3,5	x	20/16-T15	K	200	8,40 A2
3,5	x	30/25-T15	K	200	9,00 A2
4	x	20/16-T20	K	200	10,00 A2
4	x	25/21-T20	K	200	10,60 A2
4	x	30/25-T20	K	200	11,60 A2
4	x	35/30-T20	K	200	12,50 A2
4	x	40/35-T20	K	200	13,30 A2
4	x	45/40-T20	K	200	13,75 A2
4	x	50/45-T20	K	200	14,25 A2

Abmessungen	VE	Stück	€/100/Obf.
5 x 25/20-T20	K	200	14,35 A2
5 x 30/25-T20	K	200	15,00 A2
5 x 40/35-T20	K	200	18,95 A2
5 x 50/44-T20	K	100	23,50 A2

Artikel	88094.920
88094	A 2 SPAX-Seko-Z



SPAX Universalschrauben mit SPAX 4CUT-Spitze, Seko = SPAX MULTI-Senkopf Z = Pozidriv-Kreuzschlitz

gleitbeschichtet,
Bit-Größen: Ø 3 → Z1, Ø 3,5 - 5,0 → Z2,
Ø 6 → 3

Achtung! Geringere Festigkeit gegenüber gehärtetem Stahl.

Zulassungen: Z-9.1-235, ETA-12/0114



Nenn Ø x Nennlänge / Gewindelänge ca.

3	x	12/10-Z	S	200	5,25 A2
3	x	16/13-Z	S	200	5,55 A2
3	x	20/16-Z	S	200	6,25 A2
3	x	25/21-Z	S	200	6,45 A2
3	x	30/26-Z	S	200	7,00 A2
3	x	40/36-Z	S	200	11,05 A2
3,5	x	16/12-Z	S	200	6,30 A2
3,5	x	20/15-Z	S	200	7,00 A2
3,5	x	25/20-Z	S	200	7,15 A2
3,5	x	30/25-Z	S	200	7,45 A2
3,5	x	35/30-Z	S	200	8,35 A2
3,5	x	40/35-Z	S	200	9,10 A2
4	x	20/15-Z	S	200	8,35 A2
4	x	25/20-Z	S	200	8,85 A2
4	x	30/25-Z	S	200	9,70 A2
4	x	35/30-Z	S	200	10,40 A2
4	x	40/35-Z	S	200	11,10 A2
4	x	45/40-Z	S	200	11,45 A2
4	x	50/45-Z	S	200	11,90 A2
4	x	60/50-Z	S	100	18,15 A2
4,5	x	25/19-Z	S	200	10,40 A2
4,5	x	30/24-Z	S	200	11,05 A2
4,5	x	35/29-Z	S	200	12,15 A2
4,5	x	40/34-Z	S	200	13,35 A2
4,5	x	45/39-Z	S	200	14,60 A2
4,5	x	50/44-Z	S	200	15,80 A2
4,5	x	60/54-Z	S	100	20,90 A2
4,5	x	70/59-Z	S	100	24,05 A2
5	x	30/24-Z	S	200	12,50 A2
5	x	35/29-Z	S	200	13,90 A2
5	x	40/34-Z	S	200	15,80 A2
5	x	45/39-Z	S	200	17,75 A2
5	x	50/44-Z	S	200	19,60 A2
5	x	60/54-Z	S	100	24,05 A2
5	x	70/60-Z	S	100	34,50 A2
5	x	80/60-Z	S	100	41,50 A2
5	x	100/60-Z	K	200	57,00 A2
6	x	40/33-Z	S	200	31,00 A2
6	x	50/43-Z	S	100	35,50 A2
6	x	60/53-Z	S	100	41,00 A2
6	x	70/60-Z	S	100	42,50 A2
6	x	80/60-Z	S	100	43,50 A2
6	x	90/60-Z	S	100	48,00 A2
6	x	100/60-Z	S	100	52,00 A2

Abmessungen	VE	Stück	€/100/Obf.
Artikel	88192.924		
88192	A 2		SPAX D-Zyko-T

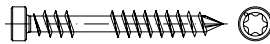

SPAX Schrauben D für Terrassen-Dielen, mit Fixiergewinde u. SPAX CUT-Spitze, Zyko = Zylinderkopf T = T-STAR plus

gleitbeschichtet

Bits → Artikel 88663, 88654

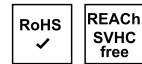

Nenn Ø x Nennlänge / Gewindelänge ca. - Bit-Größe

5	x	40/22-T25	S	200	27,00 A2
5	x	50/23-T25	S	200	32,50 A2
5	x	60/28-T25	S	100	36,50 A2
5	x	70/33-T25	S	100	55,00 A2
5	x	80/33-T25	S	100	59,00 A2

Artikel	88192.944
88192	A 4 SPAX D-Zyko-T

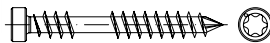

SPAX Schrauben D für Terrassen-Dielen, mit Fixiergewinde u. SPAX CUT-Spitze, Zyko = Zylinderkopf T = T-STAR plus

gleitbeschichtet

Bits → Artikel 88663, 88654



Nenn Ø x Nennlänge / Gewindelänge ca. - Bit-Größe

6	x	40/23-T	S	200	50,00 A4
6	x	50/23-T	S	200	54,00 A4
6	x	60/28-T	S	100	61,00 A4
6	x	80/40-T	S	100	99,00 A4
6	x	100/40-T	S	100	109,00 A4

Abmessungen	VE	Stück	€/100/Obf.
Artikel	88190.924		
88190	A 2		SPAX Seko-Z

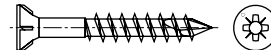

SPAX Glasleistenschrauben mit SPAX CUT-Spitze und Fäserippen, Seko = Senkkopf Z = Pozidriv-Kreuzschlitz

gleitbeschichtet

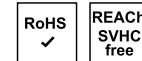

Nenn Ø x Nennlänge / Gewindelänge ca. - Bit-Größe

3,5	x	40/23-Z2	S	200	20,95 A2
-----	---	----------	---	-----	----------

Artikel	88191.924
88191	A 2 SPAX Zk-T



SPAX Pfostenschrauben mit SPAX CUT-Spitze, selbstbohrend, Zk = Zentrierkopf T = T-STAR plus

gleitbeschichtet

Bits → Artikel 88663, 88654

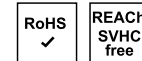

Nenn Ø x Nennlänge / Gewindelänge ca. - Bit-Größe

8	x	50/45-T40	S	50	103,00 A2
---	---	-----------	---	----	-----------

Artikel	88193.924
88193	A 2 SPAX-T-T



SPAX Schrauben mit SPAX 4CUT-Spitze, T = Tellerkopf T = T-STAR plus

gleitbeschichtet

Bits → Artikel 88663, 88654

Zulassungen: Z-9.1-449, ETA-12/0114



Nenn Ø x Nennlänge / Gewindelänge ca. - Bit-Größe

6	x	60/56-T30	S	100	52,00 A2
6	x	80/61-T30	S	100	62,00 A2
6	x	100/61-T30	S	100	72,00 A2
6	x	120/68-T30	S	100	100,00 A2

Abmessungen	VE	Stück	€/100/Obf.
6 x 140/68-T30	S	100	106,00 A2
8 x 50/46-T40	S	50	100,00 A2
8 x 80/70-T40	S	50	124,00 A2
8 x 100/80-T40	S	50	143,00 A2
8 x 120/80-T40	S	50	197,00 A2
8 x 140/80-T40	S	50	214,00 A2
8 x 160/80-T40	S	50	233,00 A2
8 x 180/80-T40	S	50	279,00 A2
8 x 200/80-T40	S	50	335,00 A2

Artikel 89018.920
89018 A 2 SPAX Fassade
 kleiner Kopf



SPAX Fassadenschrauben mit Linsenkopf, CUT-Spitze, Fräsrippen, T-STAR plus

gleitbeschichtet

Zulassungen: Z-9.1-235, ETA-12/0114

Bitgrößen:
 • Ø 4,5 - T20
 • Ø 5,0 - T25



Nenn Ø x Nennlänge / Gewindelänge ca.

4,5 x 35/25 -T	S	200	20,20
4,5 x 40/25 -T	S	200	20,95
4,5 x 45/30 -T	S	200	24,25
4,5 x 50/32 -T	S	200	27,00
4,5 x 60/37 -T	S	100	31,00
4,5 x 70/42 -T	S	100	34,50
4,5 x 80/46 -T	S	100	41,50
5 x 60/37 -T	S	100	40,50
5 x 70/42 -T	S	100	45,00
5 x 80/46 -T	S	100	54,00
5 x 90/61 -T	S	100	59,00
5 x 100/61 -T	S	100	64,00

Abmessungen VE Stück €/100/Obf.
 Artikel 89018.922
89018 A 2 SPAX Fassade
 kleiner Kopf

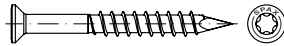

SPAX Fassadenschrauben mit sehr kleinem Linsenkopf, CUT-Spitze, Fräsrippen, T-STAR plus

gleitbeschichtet

Bitgrößen:
 • Ø 4/4,5 - T15
 • Ø 5,0 - T20



Nenn Ø x Nennlänge / Gewindelänge ca.

4 x 40/23 -T	S	100	18,80
4 x 45/30 -T	S	100	20,45
4,5 x 70/42 -T	S	100	36,00
5 x 100/61 -T	S	100	66,00

Artikel 89019.920
89019 A 2 SPAX Fassade
 Fixiergewinde



SPAX Fassadenschrauben mit Linsenkopf, 4CUT-Spitze, Fixiergewinde, T-STAR plus

kleiner Kopf (Ø 8mm),
 gleitbeschichtet

Bitgrößen Ø 4,5 - T20



Nenn Ø x Nennlänge / Gewindelänge ca.

4,5 x 50/21 -T	S	200	24,15
4,5 x 60/26 -T	S	100	30,50
4,5 x 70/31 -T	S	100	41,00

Abmessungen VE Stück €/100/Obf.
 Artikel 89019.927
89019 A 2 SPAX Fassade
 Fixiergewinde Antik



SPAX Fassadenschrauben mit Linsenkopf, Antikoptik, 4CUT-Spitze, Fixiergewinde, T-STAR plus

kleiner Kopf (Ø 8mm),
 gleitbeschichtet

Bitgrößen Ø 4,5 - T20



Nenn Ø x Nennlänge / Gewindelänge ca.

4,5 x 50/21 -T	S	200	27,50 Antik
4,5 x 60/26 -T	S	100	34,50 Antik

Spanplattenschrauben

Weitere Spanplattenschrauben mit CE nach EN 14592

- Artikel 89096
- Artikel 89097
- Artikel 89098

Artikel 88096.(*)
88096 A 4 Ruko-ISR
 pulverbeschichtet**

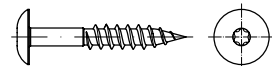

Spanplattenschrauben, Ruko = Halbrundkopf, ISR = Innensechsrund

** Kopf pulverbeschichtet
 reinweiß RAL 9010 (*947),
 anthrazitgrau RAL 7016 (*948),
 sepiabraun RAL 8014 (*949)

Werkstoffeigensch. → TI-236

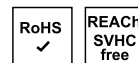

5,5 x 35/22 -T20	S	100	86,00 A4
5,5 x 35/22 -T20	S	100	86,00 A4
5,5 x 35/22 -T20	S	100	86,00 A4

Abmessungen	VE Stück	€/100/Obf.
Artikel 88104.920		
88104 A 2		



Kotflügelscheiben, Produktklasse C (g)

Maße → TI-85 Werkstoffeigensch. → TI-236



Innen Ø x Außen Ø x Dicke

4,3	x	20	x	1,5	S	100	38,00 A2
5,3	x	20	x	1,5	S	100	47,50 A2
5,3	x	30	x	1,5	S	100	106,00 A2
6,4	x	20	x	1,5	S	100	47,50 A2
6,4	x	25	x	1,5	S	100	60,00 A2
6,4	x	30	x	1,5	S	100	88,00 A2
8,4	x	20	x	1,5	S	100	47,50 A2
8,4	x	25	x	1,5	S	100	60,00 A2
8,4	x	30	x	1,5	S	100	88,00 A2
8,4	x	40	x	1,5	S	100	103,00 A2
8,4	x	50	x	2,5	S	100	122,00 A2
10,5	x	25	x	1,5	S	100	68,00 A2
10,5	x	30	x	1,5	S	100	88,00 A2
10,5	x	40	x	1,5	S	100	110,00 A2
12,5	x	30	x	1,5	S	100	88,00 A2

Artikel	88106.910
88106 A 1/A 2	

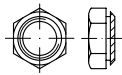

Setzmuttern

Maße → TI-78 Werkstoffeigensch. → TI-236



Gewinde M / Kragenhöhe

M 3 / 0,9	S	100	158,00 A 1/A 2
M 4 / 0,9	S	100	280,00 A 1/A 2
M 5 / 0,9	S	100	295,00 A 1/A 2
M 6 / 0,9	S	100	310,00 A 1/A 2
M 8 / 1,9	S	100	370,00 A 1/A 2
M 10 / 1,9	S	100	400,00 A 1/A 2
M 12 / 2,9	S	50	780,00 A 1/A 2
M 16 / 2,4	S	50	1220,00 A 1/A 2

Abmessungen	VE Stück	€/100/Obf.
Artikel 88107.920		
88107 A 2		

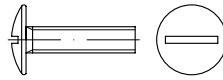

Flachrundschraben mit Schlitz, „Bordwandschrauben“, Gewinde bis Kopf

Maße → TI-41 Werkstoffeigensch. → TI-236

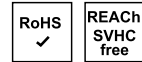

M 5	x	10	S	500	110,00 A2
M 6	x	10	S	500	82,00 A2
M 6	x	12	S	500	78,00 A2
M 6	x	16	S	500	78,00 A2
M 6	x	20	S	500	120,00 A2
M 6	x	25	S	500	131,00 A2
M 8	x	16	S	200	158,00 A2
M 8	x	20	S	200	171,00 A2
M 8	x	25	S	200	194,00 A2
M 8	x	30	S	200	231,00 A2
M 8	x	35	S	200	243,00 A2
M 8	x	40	S	200	255,00 A2
M 8	x	50	S	200	275,00 A2
M 8	x	60	S	100	455,00 A2

Artikel	88111.920
88111 A 2	Zweiloch

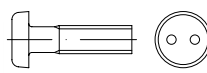

Diebstahlhemmende Schrauben mit Linsenkopf ~ DIN 85, mit metrischem Gewinde, Zweiloch-Antrieb („Snake eyes“)

Bits → Artikel 88665

Maße → TI-27 Werkstoffeigensch. → TI-236

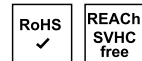

M 3	x	6	S	100	285,00 A2
M 3	x	8	S	100	285,00 A2
M 3	x	10	S	100	209,00 A2
M 3	x	12	S	100	209,00 A2
M 3	x	16	S	100	209,00 A2
M 3	x	20	S	100	237,00 A2
M 4	x	6	S	100	285,00 A2
M 4	x	10	S	100	220,00 A2
M 4	x	12	S	100	220,00 A2
M 4	x	16	S	100	220,00 A2
M 4	x	20	S	100	220,00 A2
M 4	x	25	S	100	220,00 A2
M 5	x	12	S	100	247,00 A2
M 5	x	16	S	100	247,00 A2
M 5	x	20	S	100	247,00 A2
M 5	x	25	S	100	247,00 A2
M 5	x	30	S	100	247,00 A2

Abmessungen	VE Stück	€/100/Obf.			
M 6	x	12	S	100	260,00 A 2
M 6	x	16	S	100	260,00 A 2
M 6	x	20	S	100	260,00 A 2
M 6	x	25	S	100	285,00 A 2
M 6	x	30	S	100	315,00 A 2
M 6	x	40	S	100	350,00 A 2

Artikel	88112.920
88112 A 2	Zweiloch

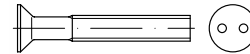

Diebstahlhemmende Schrauben mit Senkkopf ~ DIN 963, mit metrischem Gewinde, Zweiloch-Antrieb („Snake eyes“)

Bits → Artikel 88665

Maße → TI-27 Werkstoffeigensch. → TI-236

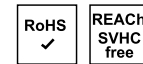

M 3	x	6	S	100	285,00 A 2
M 3	x	8	S	100	285,00 A 2
M 3	x	10	S	100	209,00 A 2
M 3	x	12	S	100	209,00 A 2
M 3	x	16	S	100	209,00 A 2
M 3	x	20	S	100	237,00 A 2
M 4	x	10	S	100	220,00 A 2
M 4	x	12	S	100	220,00 A 2
M 4	x	16	S	100	220,00 A 2
M 4	x	20	S	100	220,00 A 2
M 4	x	25	S	100	220,00 A 2
M 4	x	50	S	100	475,00 A 2
M 5	x	12	S	100	247,00 A 2
M 5	x	16	S	100	247,00 A 2
M 5	x	20	S	100	247,00 A 2
M 5	x	25	S	100	247,00 A 2
M 5	x	30	S	100	247,00 A 2
M 5	x	35	S	100	445,00 A 2
M 6	x	12	S	100	260,00 A 2
M 6	x	16	S	100	260,00 A 2
M 6	x	20	S	100	260,00 A 2
M 6	x	25	S	100	285,00 A 2
M 6	x	30	S	100	315,00 A 2
M 6	x	40	S	100	350,00 A 2

Abmessungen	VE	Stück	€/100/Obf.
Artikel	88113.920		
88113	A 2	Pin-I6kt.	

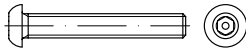

Diebstahlhemmende Schrauben mit Flachrundkopf ~ ISO 7380, mit metrischem Gewinde, Innensechskant-Antrieb mit Zapfen

Bits → Artikel 88666

Maße → **TI-27**

Werkstoffeigensch. → **TI-236**



M 3	x	6	S	100	228,00A2
M 3	x	8	S	100	199,00A2
M 3	x	10	S	100	152,00A2
M 3	x	12	S	100	152,00A2
M 3	x	16	S	100	152,00A2
M 3	x	20	S	100	161,00A2
M 4	x	6	S	100	228,00A2
M 4	x	8	S	100	228,00A2
M 4	x	10	S	100	146,00A2
M 4	x	12	S	100	150,00A2
M 4	x	16	S	100	150,00A2
M 4	x	20	S	100	161,00A2
M 4	x	25	S	100	192,00A2
M 4	x	30	S	100	216,00A2
M 4	x	40	S	100	285,00A2
M 5	x	10	S	100	169,00A2
M 5	x	12	S	100	173,00A2
M 5	x	16	S	100	173,00A2
M 5	x	20	S	100	188,00A2
M 5	x	25	S	100	220,00A2
M 5	x	30	S	100	250,00A2
M 5	x	35	S	100	335,00A2
M 5	x	40	S	100	390,00A2
M 5	x	50	S	100	430,00A2
M 5	x	60	S	100	530,00A2
M 6	x	10	S	100	237,00A2
M 6	x	12	S	100	220,00A2
M 6	x	16	S	100	222,00A2
M 6	x	20	S	100	241,00A2
M 6	x	25	S	100	275,00A2
M 6	x	30	S	100	305,00A2
M 6	x	35	S	100	380,00A2
M 6	x	40	S	100	395,00A2
M 6	x	45	S	100	465,00A2
M 6	x	50	S	100	495,00A2
M 6	x	60	S	100	610,00A2
M 8	x	10	S	100	430,00A2
M 8	x	12	S	100	380,00A2
M 8	x	16	S	100	340,00A2
M 8	x	20	S	100	360,00A2
M 8	x	25	S	100	385,00A2
M 8	x	30	S	100	445,00A2
M 8	x	35	S	100	510,00A2
M 8	x	40	S	100	560,00A2
M 8	x	45	S	100	620,00A2
M 8	x	50	S	100	650,00A2
M 8	x	60	S	100	860,00A2

Abmessungen	VE	Stück	€/100/Obf.
M 10	x	16	S 100 860,00A2
M 10	x	20	S 100 950,00A2
M 10	x	25	S 100 1150,00A2
M 10	x	30	S 100 1350,00A2
M 10	x	40	S 100 1680,00A2
M 10	x	50	S 100 1990,00A2
M 10	x	60	S 100 2600,00A2
M 12	x	25	S 100 5500,00A2

Abmessungen	VE	Stück	€/100/Obf.
Artikel	88114.920		
88114	A 2	PIN-ISR	

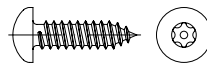

Diebstahlhemmende Schrauben mit Linsenkopf DIN 7981, mit Blechschraubengewinde ST, Innensechsrund-Antrieb mit Zapfen

Bits → Artikel 88667

Maße → **TI-48**

Werkstoffeigensch. → **TI-236**

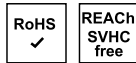

3,5	x	13	S	100	133,00A2
3,5	x	16	S	100	171,00A2
3,5	x	19	S	100	137,00A2
3,5	x	25	S	100	199,00A2
3,5	x	32	S	100	214,00A2
3,5	x	38	S	100	218,00A2
4,2	x	9,5	S	100	156,00A2
4,2	x	13	S	100	144,00A2
4,2	x	16	S	100	165,00A2
4,2	x	19	S	100	167,00A2
4,2	x	25	S	100	190,00A2
4,2	x	32	S	100	212,00A2
4,2	x	38	S	100	235,00A2
4,2	x	50	S	100	275,00A2
4,8	x	13	S	100	190,00A2
4,8	x	16	S	100	214,00A2
4,8	x	19	S	100	216,00A2
4,8	x	25	S	100	245,00A2
4,8	x	32	S	100	285,00A2
4,8	x	38	S	100	310,00A2
4,8	x	50	S	100	335,00A2
5,5	x	16	S	100	400,00A2
5,5	x	19	S	100	420,00A2
5,5	x	25	S	100	275,00A2
5,5	x	32	S	100	540,00A2
5,5	x	38	S	100	320,00A2
5,5	x	50	S	100	390,00A2
5,5	x	63	S	100	740,00A2
5,5	x	75	S	100	760,00A2
6,3	x	13	S	100	1070,00A2
6,3	x	16	S	100	495,00A2
6,3	x	19	S	100	580,00A2
6,3	x	25	S	100	660,00A2
6,3	x	32	S	100	710,00A2
6,3	x	38	S	100	760,00A2
6,3	x	50	S	100	890,00A2

Abmessungen	VE	Stück	€/100/Obf.
Artikel	88115.920		
88115	A 2	PIN-ISR	



Diebstahlhemmende Schrauben mit Senkkopf DIN 7982, mit Blechschraubengewinde ST, Innensechsrund-Antrieb mit Zapfen

Bits → Artikel 88667

Maße → **TI-48**

Werkstoffeigensch. → **TI-236**

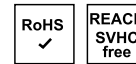

2,9	x	13	S	100	180,00A2
2,9	x	19	S	100	190,00A2
3,5	x	9,5	S	100	152,00A2
3,5	x	13	S	100	141,00A2
3,5	x	16	S	100	144,00A2
3,5	x	19	S	100	148,00A2
3,5	x	25	S	100	152,00A2
3,5	x	38	S	100	188,00A2
4,2	x	13	S	100	137,00A2
4,2	x	16	S	100	156,00A2
4,2	x	19	S	100	167,00A2
4,2	x	25	S	100	190,00A2
4,2	x	32	S	100	212,00A2
4,2	x	38	S	100	235,00A2
4,2	x	50	S	100	285,00A2
4,8	x	13	S	100	194,00A2
4,8	x	16	S	100	212,00A2
4,8	x	19	S	100	228,00A2
4,8	x	25	S	100	245,00A2
4,8	x	32	S	100	285,00A2
4,8	x	38	S	100	310,00A2
4,8	x	50	S	100	290,00A2
5,5	x	16	S	100	465,00A2
5,5	x	25	S	100	485,00A2
5,5	x	38	S	100	290,00A2
5,5	x	50	S	100	390,00A2
5,5	x	63	S	100	780,00A2
5,5	x	75	S	100	810,00A2
6,3	x	19	S	100	610,00A2
6,3	x	50	S	100	950,00A2

Abmessungen	VE Stück	€/100/Obf.
Artikel 88116.920		
88116 A 2		PIN-ISR

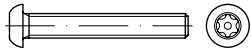

Diebstahlhemmende Schrauben mit Flachrundkopf ~ ISO 7380, mit metrischem Gewinde, Innensechsrund-Antrieb mit Zapfen

Bits → Artikel 88667

Maße → **TI-26**

Werkstoffeigensch. → **TI-236**

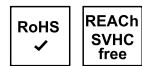

M 3	x	6-T10	S	100	182,00 A 2
M 3	x	8-T10	S	100	182,00 A 2
M 3	x	10-T10	S	100	182,00 A 2
M 3	x	12-T10	S	100	186,00 A 2
M 3	x	16-T10	S	100	186,00 A 2
M 3	x	20-T10	S	100	199,00 A 2
M 4	x	6-T20	S	100	186,00 A 2
M 4	x	8-T20	S	100	186,00 A 2
M 4	x	10-T20	S	100	195,00 A 2
M 4	x	12-T20	S	100	205,00 A 2
M 4	x	16-T20	S	100	218,00 A 2
M 4	x	20-T20	S	100	231,00 A 2
M 4	x	25-T20	S	100	247,00 A 2
M 4	x	30-T20	S	100	275,00 A 2
M 4	x	40-T20	S	100	345,00 A 2
M 4	x	50-T20	S	100	380,00 A 2
M 5	x	8-T25	S	100	265,00 A 2
M 5	x	10-T25	S	100	265,00 A 2
M 5	x	12-T25	S	100	265,00 A 2
M 5	x	16-T25	S	100	280,00 A 2
M 5	x	20-T25	S	100	290,00 A 2
M 5	x	25-T25	S	100	325,00 A 2
M 5	x	30-T25	S	100	360,00 A 2
M 5	x	35-T25	S	100	390,00 A 2
M 5	x	40-T25	S	100	420,00 A 2
M 5	x	50-T25	S	100	530,00 A 2
M 5	x	60-T25	S	100	670,00 A 2
M 6	x	10-T30	S	100	320,00 A 2
M 6	x	12-T30	S	100	325,00 A 2
M 6	x	16-T30	S	100	345,00 A 2
M 6	x	20-T30	S	100	365,00 A 2
M 6	x	25-T30	S	100	410,00 A 2
M 6	x	30-T30	S	100	410,00 A 2
M 6	x	35-T30	S	100	450,00 A 2
M 6	x	40-T30	S	100	530,00 A 2
M 6	x	45-T30	S	100	560,00 A 2
M 6	x	50-T30	S	100	600,00 A 2
M 6	x	60-T30	S	100	780,00 A 2
M 8	x	12-T40	S	100	540,00 A 2
M 8	x	16-T40	S	100	590,00 A 2
M 8	x	20-T40	S	100	670,00 A 2
M 8	x	25-T40	S	100	720,00 A 2
M 8	x	30-T40	S	100	780,00 A 2
M 8	x	35-T40	S	100	900,00 A 2
M 8	x	40-T40	S	100	910,00 A 2
M 8	x	45-T40	S	100	1010,00 A 2
M 8	x	50-T40	S	100	1020,00 A 2
M 8	x	60-T40	S	100	1090,00 A 2
M 8	x	80-T40	S	100	1340,00 A 2
M10	x	12-T45	S	100	900,00 A 2
M10	x	20-T45	S	100	1010,00 A 2
M10	x	25-T45	S	100	1060,00 A 2

Abmessungen	VE Stück	€/100/Obf.			
M10	x	30-T45	S	100	1100,00 A 2
M10	x	40-T45	S	100	1200,00 A 2
M10	x	45-T45	S	100	1270,00 A 2
M10	x	50-T45	S	100	1400,00 A 2
M10	x	60-T45	S	100	1450,00 A 2
M10	x	65-T45	S	100	1500,00 A 2
M10	x	80-T45	S	100	1640,00 A 2

Artikel	88117.920	
88117 A 2		PIN-ISR

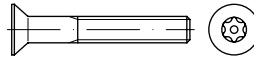

Diebstahlhemmende Schrauben mit Senkkopf ~ ISO 10642, mit metrischem Gewinde, Innensechsrund-Antrieb mit Zapfen

Bits → Artikel 88667

Maße → **TI-27**

Werkstoffeigensch. → **TI-236**

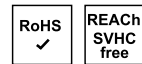

M 3	x	6-T10	S	100	146,00 A 2
M 3	x	8-T10	S	100	154,00 A 2
M 3	x	10-T10	S	100	163,00 A 2
M 3	x	12-T10	S	100	171,00 A 2
M 3	x	16-T10	S	100	190,00 A 2
M 3	x	20-T10	S	100	209,00 A 2
M 3,5	x	6-T15	S	100	152,00 A 2
M 3,5	x	12-T15	S	100	171,00 A 2
M 4	x	6-T20	S	100	171,00 A 2
M 4	x	8-T20	S	100	176,00 A 2
M 4	x	10-T20	S	100	180,00 A 2
M 4	x	12-T20	S	100	184,00 A 2
M 4	x	16-T20	S	100	190,00 A 2
M 4	x	20-T20	S	100	218,00 A 2
M 4	x	25-T20	S	100	237,00 A 2
M 4	x	30-T20	S	100	265,00 A 2
M 4	x	40-T20	S	100	305,00 A 2
M 4	x	50-T20	S	100	360,00 A 2
M 5	x	8-T25	S	100	260,00 A 2
M 5	x	10-T25	S	100	260,00 A 2
M 5	x	12-T25	S	100	260,00 A 2
M 5	x	16-T25	S	100	275,00 A 2
M 5	x	20-T25	S	100	315,00 A 2
M 5	x	25-T25	S	100	325,00 A 2
M 5	x	30-T25	S	100	360,00 A 2
M 5	x	35-T25	S	100	430,00 A 2
M 5	x	40-T25	S	100	440,00 A 2
M 5	x	50-T25	S	100	570,00 A 2
M 5	x	60-T25	S	100	680,00 A 2
M 5	x	70-T25	S	100	790,00 A 2
M 5	x	80-T25	S	100	800,00 A 2
M 6	x	10-T30	S	100	295,00 A 2
M 6	x	12-T30	S	100	305,00 A 2
M 6	x	16-T30	S	100	325,00 A 2
M 6	x	20-T30	S	100	355,00 A 2
M 6	x	25-T30	S	100	390,00 A 2
M 6	x	30-T30	S	100	420,00 A 2
M 6	x	35-T30	S	100	445,00 A 2
M 6	x	40-T30	S	100	510,00 A 2
M 6	x	45-T30	S	100	570,00 A 2
M 6	x	50-T30	S	100	620,00 A 2
M 6	x	60-T30	S	100	800,00 A 2
M 8	x	16-T40	S	100	680,00 A 2
M 8	x	20-T40	S	100	770,00 A 2

Abmessungen	VE Stück	€/100/Obf.			
M 8	x	25-T40	S	100	840,00 A 2
M 8	x	30-T40	S	100	900,00 A 2
M 8	x	40-T40	S	100	1060,00 A 2
M 8	x	50-T40	S	100	1170,00 A 2
M 8	x	60-T40	S	100	1260,00 A 2
M 8	x	80-T40	S	100	1550,00 A 2
M10	x	60-T45	S	100	1550,00 A 2
M10	x	80-T45	S	100	1890,00 A 2

Artikel	88118.910	
88118 A 1		

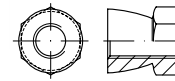

Diebstahlhemmende Muttern, „Abreißmutter“, Flachrundform, Sechskant-Abreiß-Antrieb für Einwegmontage (nicht lösbar)

Werkstoffeigensch. → **TI-236**

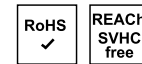

M 6	x	6	S	500	186,00 A 1
M 6	x	6	K	50	203,00 A 1
M 8	x	6	S	500	245,00 A 1
M 8	x	6	K	50	265,00 A 1
M10	x	8	S	500	950,00 A 1
M10	x	8	K	25	990,00 A 1
M12	x	9	S	250	1670,00 A 1
M12	x	9	K	25	1860,00 A 1
M16	x	14	S	100	3950,00 A 1
M16	x	14	K	25	4300,00 A 1

Artikel	88120.924	
88120 A 2		Form S



SCHNORR-Sperrzahnscheiben, beidseitig gezahnt, S = Standard

Achtung! Geringere Festigkeit gegenüber gehärtetem Stahl.

Maße → **TI-104**

Schraubensicherung → **TI-256**

Werkstoffeigensch. → **TI-236**

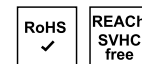

Für Schrauben M x Außen Ø x Dicke

S 2	x	4	0,35	S	1000	2,85 A 2
S 2	x	4	0,35	K	200	4,75 A 2
S 2,5	x	4,8	0,45	S	2000	2,85 A 2
S 2,5	x	4,8	0,45	K	200	4,75 A 2
S 3	x	5,5	0,45	S	2000	2,85 A 2
S 3	x	5,5	0,45	K	200	4,75 A 2
S 4	x	7	0,5	S	1000	3,45 A 2
S 4	x	7	0,5	K	200	5,30 A 2
S 5	x	9	0,6	S	1000	5,80 A 2
S 5	x	9	0,6	K	200	7,70 A 2
S 6	x	10	0,7	S	1000	7,30 A 2

Abmessungen	VE	Stück	€/100/Obf.
S 6 x 10	0,7	K 200	9,20 A2
S 8 x 13	0,8	S 1000	12,90 A2
S 8 x 13	0,8	K 200	14,80 A2
S 10 x 16	1	S 1000	23,50 A2
S 10 x 16	1	K 200	25,50 A2
S 12 x 18	1,1	S 500	33,00 A2
S 12 x 18	1,1	K 100	35,00 A2
S 16 x 24	1,3	S 250	64,00 A2
S 16 x 24	1,3	K 100	66,00 A2
S 20 x 30	1,5	S 250	118,00 A2
S 20 x 30	1,5	K 100	120,00 A2
S 24 x 36	1,8	S 100	168,00 A2

Artikel	88121.924
88121	A 2 Form VS



SCHNORR-Sperrzahnscheiben, beidseitig gezahnt, VS = verstärkt

Achtung! Geringere Festigkeit gegenüber gehärtetem Stahl.

Maße → **TI-105** Schraubensicherung → **TI-256**
Werkstoffeigensch. → **TI-236**



Für Schrauben M x Außen Ø x Dicke

VS 5 x 9 x 1	S 1000	23,30 A2
VS 6 x 10 x 1	S 1000	28,00 A2
VS 8 x 13 x 1,2	S 1000	39,50 A2
VS 10 x 16 x 1,5	S 1000	84,00 A2
VS 12 x 18 x 1,5	S 500	117,00 A2
VS 16 x 24 x 2	S 250	233,00 A2
VS 20 x 30 x 2	S 250	415,00 A2

Artikel	88123.940
88123	A 4 SK-S



TECKENTRUP-Sperrkantscheiben, S (schmal) = für normale und kleine Kopfauflagen

Maße → **TI-105** Schraubensicherung → **TI-256**
Werkstoffeigensch. → **TI-236**



Für Schrauben Ø x Außen Ø x Dicke

S 4 x 8,2 x 0,8	S 1000	22,70 A4
S 5 x 10,2 x 1	S 1000	29,00 A4
S 6 x 12,2 x 1,2	S 1000	31,00 A4
S 8 x 16,2 x 1,4	S 1000	52,00 A4
S 10 x 20,25 x 1,6	S 1000	84,00 A4
S 12 x 24,25 x 1,6	S 1000	152,00 A4

Abmessungen	VE	Stück	€/100/Obf.
Artikel	88123.947		
88123	A 4		NSK-S



TECKENTRUP-Sperrkantscheiben, S (schmal) = für normale und kleine Kopfauflagen

Maße → **TI-105** Schraubensicherung → **TI-256**
Werkstoffeigensch. → **TI-236**

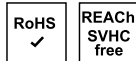

Für Schrauben M

NSK-S 4	S 1000	22,70 A4
NSK-S 5	S 1000	29,00 A4
NSK-S 6	S 1000	31,00 A4
NSK-S 8	S 1000	52,00 A4
NSK-S 10	S 1000	84,00 A4
NSK-S 12	S 1000	152,00 A4

Artikel	88124.940
88124	A 4 SK-M



TECKENTRUP-Sperrkantscheiben, M (mittel) = für normale Kopfauflagen

Maße → **TI-105** Schraubensicherung → **TI-256**
Werkstoffeigensch. → **TI-236**



Für Schrauben M x Außen Ø x Dicke

M 4 x 10,2 x 1	S 1000	28,00 A4
M 5 x 12,2 x 1,2	S 1000	34,00 A4
M 6 x 14,2 x 1,4	S 1000	43,00 A4
M 8 x 18,2 x 1,4	S 1000	63,00 A4
M 10 x 22,25 x 1,6	S 500	112,00 A4
M 12 x 27,25 x 1,8	S 500	191,00 A4

Abmessungen	VE	Stück	€/100/Obf.
Artikel	88124.947		
88124	A 4		NSK-M



TECKENTRUP-Sperrkantscheiben, M (mittel) = für normale Kopfauflagen

Maße → **TI-105** Schraubensicherung → **TI-256**
Werkstoffeigensch. → **TI-236**

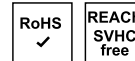

Für Schrauben M

NSK-M 4	S 1000	28,00 A4
NSK-M 5	S 1000	34,00 A4
NSK-M 6	S 1000	43,00 A4
NSK-M 8	S 1000	63,00 A4
NSK-M 10	S 500	112,00 A4
NSK-M 12	S 500	191,00 A4
NSK-M 16	S 200	275,00 A4

Artikel	88125.940
88125	A 4 SK-B



TECKENTRUP-Sperrkantscheiben, B (breit) = für große Druckflächen

Maße → **TI-106** Schraubensicherung → **TI-256**
Werkstoffeigensch. → **TI-236**

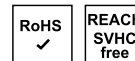

Für Schrauben Ø x Außen Ø x Dicke

B 6 x 18,2 x 1,4	S 1000	63,00 A4
B 8 x 22,25 x 1,9	S 500	112,00 A4
B 10 x 27,25 x 2,4	S 500	222,00 A4

Abmessungen	VE Stück	€/100/Obf.
Artikel	88125.947	
88125	A 4	NSK-B



TECKENTRUP-Sperrkantscheiben, B (breit) = für große Druckflächen

Maße → TI-106 Schraubensicherung → TI-256
Werkstoffeigensch. → TI-236

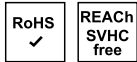

Für Schrauben M

NSK-B 6	S 1000	63,00 A4
NSK-B 8	S 500	112,00 A4
NSK-B 10	S 500	222,00 A4

Artikel	88129.940
88129	A 4
	SK-K

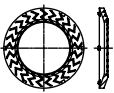

TECKENTRUP-Sperrkantscheiben, K = mit Kontaktzähnen

Maße → TI-106 Schraubensicherung → TI-256
Werkstoffeigensch. → TI-236

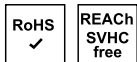

Für Schrauben Ø x Außen Ø x Dicke

K 4	x 8,2	x 0,8	S 1000	29,50 A4
K 5	x 10,2	x 1	S 1000	34,50 A4
K 6	x 12,2	x 1,2	S 1000	39,50 A4
K 8	x 16,2	x 1,4	S 1000	63,00 A4
K 10	x 20,25	x 1,6	S 500	179,00 A4
K 12	x 24,25	x 1,6	S 500	275,00 A4

Artikel	88129.947
88129	A 4
	NSK-K



TECKENTRUP-Sperrkantscheiben, K = mit Kontaktzähnen

Maße → TI-106 Schraubensicherung → TI-256
Werkstoffeigensch. → TI-236

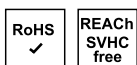

Für Schrauben M

NSK-K 4	S 1000	29,50 A4
NSK-K 5	S 1000	34,50 A4
NSK-K 6	S 1000	39,50 A4

Abmessungen	VE Stück	€/100/Obf.
NSK-K 8	S 1000	63,00 A4
NSK-K 10	S 500	179,00 A4
NSK-K 12	S 500	275,00 A4

Artikel	88130.960
88130	1.4310
	VSK-D

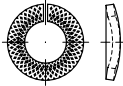

Sperrkantringe, VSK-D = Standardausführung

Achtung! Geringere Festigkeit gegenüber gehärtetem Stahl.

Maße → TI-107 Schraubensicherung → TI-256
Werkstoffeigensch. → TI-236

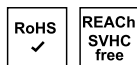

Für Schrauben M x Außen Ø x Dicke s

4	x 7,6	x 0,8	S 1000	9,20
5	x 9,2	x 1,2	S 5000	10,60
6	x 11,8	x 1,6	S 2000	18,60
8	x 14,8	x 2	S 1000	30,00
10	x 18	x 2,2	S 500	47,00
12	x 21	x 2,5	S 500	69,00
14	x 24	x 3	S 250	114,00
16	x 27,3	x 3,5	S 200	154,00
18	x 29,4	x 3,5	S 150	248,00
20	x 33,6	x 4	S 100	248,00
24	x 40	x 5	S 50	470,00

Artikel	88132.940
88132	A 4

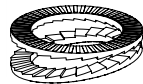

NORD-LOCK-Scheiben, Standard, paarweise verbunden

Achtung!
• Geringere Festigkeit gegenüber gehärtetem Stahl.
• Bei Montage auf richtige Lage der Scheibenpaare achten!

Maße → TI-107 Anziehmomente → TI-247
Werkstoffeigensch. → TI-236 Schraubensicherung → TI-256



für Schrauben M

NL 4 SS	S 200	420,00 A4
NL 5 SS	S 200	420,00 A4
NL 6 SS	S 200	510,00 A4
NL 8 SS	S 200	540,00 A4
NL 10 SS	S 200	610,00 A4
NL 12 SS	S 200	1100,00 A4
NL 16 SS	S 100	1560,00 A4
NL 18 SS	S 100	2080,00 A4
NL 20 SS	S 100	2080,00 A4
NL 24 SS	S 100	3150,00 A4

Abmessungen	VE Stück	€/100/Obf.
Artikel	88132.945	
88132	A 4	SP

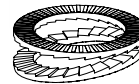

NORD-LOCK-Scheiben, paarweise verbunden, SP = mit großer Auflagefläche

Achtung!
• Geringere Festigkeit gegenüber gehärtetem Stahl.
• Bei Montage auf richtige Lage der Scheibenpaare achten!

Maße → TI-107 Anziehmomente → TI-247
Werkstoffeigensch. → TI-236 Schraubensicherung → TI-256



für Schrauben M

NL 3,5 SP SS	S 200	570,00 A4
NL 4 SP SS	S 200	590,00 A4
NL 5 SP SS	S 200	610,00 A4
NL 6 SP SS	S 200	640,00 A4
NL 8 SP SS	S 200	790,00 A4
NL 10 SP SS	S 200	1280,00 A4
NL 12 SP SS	S 100	2320,00 A4
NL 14 SP SS	S 100	2600,00 A4
NL 16 SP SS	S 100	2600,00 A4
NL 18 SP SS	S 100	3900,00 A4
NL 20 SP SS	S 100	3950,00 A4
NL 22 SP SS	S 50	6700,00 A4
NL 24 SP SS	S 50	9100,00 A4
NL 27 SP SS	S 25	9100,00 A4
NL 30 SP SS	S 25	11300,00 A4

Artikel	88032.940
88032	A 4
	HLS

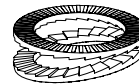

HEICO-LOCK Keilsicherungsscheiben, paarweise verbunden, HLS = Standard

Achtung!
• Geringere Festigkeit gegenüber gehärtetem Stahl.
• Bei Montage auf richtige Lage der Scheibenpaare achten!

Maße → TI-103 Anziehmomente → TI-247
Werkstoffeigensch. → TI-236 Schraubensicherung → TI-256



für Schrauben M

HLS- 3S	S 200	315,00
HLS- 3,5S	S 200	315,00
HLS- 4S	S 200	325,00
HLS- 5S	S 200	330,00
HLS- 6S	S 200	370,00
HLS- 8S	S 200	395,00
HLS-10S	S 200	450,00

Abmessungen	VE	Stück	€/100/Obf.
HLS-12S	S	200	740,00
HLS-14S	S	100	1210,00
HLS-16S	S	100	1310,00
HLS-18S	S	100	1730,00
HLS-20S	S	100	1860,00
HLS-22S	S	100	2350,00
HLS-24S	S	100	2390,00
HLS-27S	S	50	4650,00
HLS-30S	S	50	4950,00
HLS-33S	S	25	5600,00
HLS-36S	S	25	6800,00
HLS-39S	S	25	8800,00
HLS-42S	S	25	9600,00

Artikel	88032.944
88032	A 4 HLB

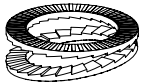

HEICO-LOCK Keilsicherungsscheiben, paarweise verbunden, HLB = mit großer Auflagefläche

Achtung!

- Geringere Festigkeit gegenüber gehärtetem Stahl.
- Bei Montage auf richtige Lage der Scheibenpaare achten!

Maße → **TI-103** Anziehungsmomente → **TI-247**
 Werkstoffeigensch. → **TI-236** Schraubensicherung → **TI-256**



für Schrauben M

HLB- 3,5S	S	200	380,00
HLB- 4S	S	200	380,00
HLB- 5S	S	200	385,00
HLB- 6S	S	200	410,00
HLB- 8S	S	200	520,00
HLB-10S	S	200	850,00
HLB-12S	S	100	1260,00
HLB-14S	S	100	1350,00
HLB-16S	S	100	1410,00
HLB-18S	S	100	2550,00
HLB-20S	S	100	2600,00
HLB-22S	S	50	4100,00
HLB-24S	S	50	6300,00
HLB-27S	S	25	6700,00

Abmessungen	VE	Stück	€/100/Obf.
Artikel	88035.940		
88035	A 4		

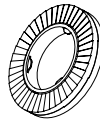

HEICO-LOCK Kombi-Scheiben, Standard, paarweise verbunden, mit Sicherungsring aus Kunststoff

Maße → **TI-104** Schraubensicherung → **TI-256**
 Werkstoffeigensch. → **TI-236**

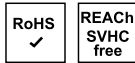

für Schrauben M

HKS- 8S	S	200	217,00 A4
HKS-10S	S	200	248,00 A4
HKS-12S	S	200	410,00 A4
HKS-16S	S	100	720,00 A4

Artikel	88035.944
88035	A 4 B

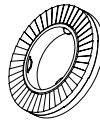

HEICO-LOCK Kombi-Scheiben, paarweise verbunden, mit Sicherungsring aus Kunststoff, B = mit großer Auflagefläche

Maße → **TI-104** Schraubensicherung → **TI-256**
 Werkstoffeigensch. → **TI-236**

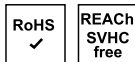

für Schrauben M

HKB- 8S	S	200	290,00 A4
HKB-10S	S	200	470,00 A4
HKB-12S	S	100	700,00 A4
HKB-16S	S	100	780,00 A4

Abmessungen	VE	Stück	€/100/Obf.
Artikel	88136.920		
88136	A 2	Typ 48	

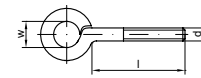

Gewindeösen Typ 48, mit metrischem Gewinde

Maße → **TI-36** Werkstoffeigensch. → **TI-236**



d x l x D

M 4	x	10 D 6	S	50	173,00 A2
M 4	x	15 D 6	S	50	167,00 A2
M 4	x	20 D 6	S	50	173,00 A2
M 4	x	30 D 6	S	50	180,00 A2
M 5	x	15 D 8	S	50	184,00 A2
M 5	x	20 D 8	S	50	193,00 A2
M 5	x	30 D 8	S	50	197,00 A2
M 5	x	40 D 8	S	50	209,00 A2
M 6	x	15 D 10	S	50	214,00 A2
M 6	x	20 D 10	S	50	232,00 A2
M 6	x	25 D 10	S	50	236,00 A2
M 6	x	30 D 10	S	50	248,00 A2
M 6	x	40 D 10	S	50	260,00 A2
M 6	x	50 D 10	S	50	270,00 A2
M 6	x	60 D 10	S	50	275,00 A2
M 8	x	20 D 12	S	50	405,00 A2
M 8	x	25 D 12	S	50	420,00 A2
M 8	x	30 D 12	S	50	440,00 A2
M 8	x	40 D 12	S	50	480,00 A2
M 8	x	50 D 12	S	50	510,00 A2
M 8	x	60 D 12	S	50	540,00 A2
M 10	x	40 D 14	S	50	800,00 A2
M 10	x	70 D 14	S	50	1260,00 A2

Artikel	88149.920
88149	A 2

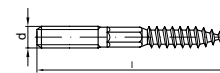

Stockschrauben mit metrischem und Holzschraubengewinde

Werkstoffeigensch. → **TI-236**

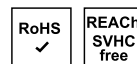

Ø M x Gesamtlänge

M 6	x	50	S	100	188,00 A2
M 6	x	60	S	100	226,00 A2
M 6	x	70	S	100	270,00 A2
M 6	x	80	S	100	310,00 A2
M 6	x	100	S	100	380,00 A2
M 6	x	120	S	100	460,00 A2
M 6	x	130	S	100	510,00 A2
M 6	x	140	S	100	540,00 A2
M 6	x	150	S	100	580,00 A2
M 6	x	160	S	100	620,00 A2
M 6	x	180	S	100	700,00 A2
M 8	x	50	S	100	255,00 A2

Abmessungen	VE	Stück	€/100/Obf.
M 8 x 60	S	100	305,00 A2
M 8 x 70	S	100	355,00 A2
M 8 x 80	S	50	445,00 A2
M 8 x 90	S	50	460,00 A2
M 8 x 100	S	50	510,00 A2
M 8 x 110	S	50	530,00 A2
M 8 x 120	S	50	560,00 A2
M 8 x 130	S	50	660,00 A2
M 8 x 140	S	50	710,00 A2
M 8 x 150	S	50	760,00 A2
M 8 x 160	S	50	810,00 A2
M 8 x 180	S	50	910,00 A2
M 8 x 200	S	50	1010,00 A2
M 10 x 80	S	25	670,00 A2
M 10 x 100	S	25	830,00 A2
M 10 x 120	S	25	920,00 A2
M 10 x 140	S	25	1080,00 A2
M 10 x 160	S	25	1330,00 A2
M 10 x 180	S	25	1500,00 A2
M 10 x 200	S	25	1650,00 A2

Artikel	88149.925
---------	-----------

88149 A 2 - 70 AS

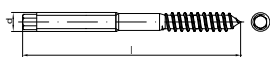

Stockschrauben mit metrischem und Holzschraubengewinde, AS = Außensechskant

Werkstoffeigensch. → TI-236

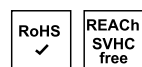

Ø M x Gesamtlänge / Schlüsselweite

M 10 x 180 SW7	S	25	1500,00 A2
M 10 x 200 SW7	S	25	1650,00 A2
M 10 x 250 SW7	S	25	2280,00 A2
M 12 x 180 SW9	S	25	2450,00 A2
M 12 x 200 SW9	S	25	2850,00 A2
M 12 x 250 SW9	S	25	3500,00 A2

Artikel	88151.920
---------	-----------

88151 A 2 RUV

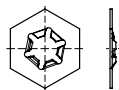

REYHER-Nonverlierbarkeits-Scheiben für Schrauben m. metr. Gewinde

zur Verwendung nach der EG-Maschinenrichtlinie

Zugehörige Schrauben → DIN 7964 A2

Werkstoffeigensch. → TI-236 Richtlinien → TI-263



Gewinde Ø x SW x Dicke

M 6 x 12 x 0,5	S	100	45,50 A2
M 8 x 16 x 0,5	S	100	47,50 A2
M 10 x 18 x 0,5	S	100	49,50 A2
M 12 x 21 x 0,6	S	50	72,00 A2
M 16 x 27 x 0,7	S	50	600,00 A2

Abmessungen	VE	Stück	€/100/Obf.
-------------	----	-------	------------

Artikel	88153.920
---------	-----------

88153 A 2 RUV



REYHER-Nonverlierbarkeits-Muttern

zur Verwendung nach der EG-Maschinenrichtlinie

Werkstoffeigensch. → TI-236 Richtlinien → TI-263



M 5	K	25	760,00 A2
M 6	K	25	800,00 A2
M 8	K	25	860,00 A2
M 10	K	10	950,00 A2
M 12	K	10	1120,00 A2

Artikel	88176.920
---------	-----------

88176 A 2 Form A

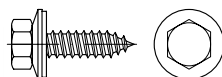

Fassadenschrauben mit montierter Dichtscheibe, A = mit Spitze

Schlüsselweite = 3/8", Ø Dichtscheibe = Ø 16 mm

Maße → TI-50

Werkstoffeigensch. → TI-236

A 6,5 x 16	S	500	66,00 A2
A 6,5 x 19	S	500	69,00 A2
A 6,5 x 25	S	500	77,00 A2
A 6,5 x 32	S	400	88,00 A2
A 6,5 x 38	S	400	103,00 A2
A 6,5 x 45	S	300	110,00 A2
A 6,5 x 50	S	250	112,00 A2
A 6,5 x 64	S	200	144,00 A2
A 6,5 x 75	S	200	161,00 A2
A 6,5 x 85	S	200	180,00 A2
A 6,5 x 90	S	150	180,00 A2
A 6,5 x 100	S	100	199,00 A2
A 6,5 x 115	S	100	212,00 A2
A 6,5 x 130	S	100	247,00 A2
A 6,5 x 150	S	100	300,00 A2
A 6,5 x 175	S	100	380,00 A2
A 6,5 x 200	S	100	470,00 A2

Abmessungen	VE	Stück	€/100/Obf.
-------------	----	-------	------------

Artikel	88276.920
---------	-----------

88276 A 2 Form BZ

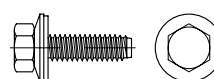

Fassadenschrauben mit montierter Dichtscheibe, BZ = mit Zapfen

Schlüsselweite = 3/8", Ø Dichtscheibe = Ø 16 mm

Kappen → Artikel 88008

Maße → TI-50

Werkstoffeigensch. → TI-236

BZ 6,3 x 16	S	500	69,00 A2
BZ 6,3 x 19	S	500	73,00 A2
BZ 6,3 x 25	S	500	77,00 A2
BZ 6,3 x 32	S	400	88,00 A2
BZ 6,3 x 38	S	400	103,00 A2
BZ 6,3 x 45	S	300	110,00 A2
BZ 6,3 x 50	S	250	112,00 A2
BZ 6,3 x 64	S	200	144,00 A2
BZ 6,3 x 75	S	200	161,00 A2
BZ 6,3 x 90	S	150	180,00 A2
BZ 6,3 x 100	S	100	199,00 A2
BZ 6,3 x 115	S	100	212,00 A2
BZ 6,3 x 130	S	100	247,00 A2
BZ 6,3 x 150	S	100	300,00 A2
BZ 6,3 x 175	S	100	380,00 A2

Artikel	88008.(*)
---------	-----------

88008 Kunststoff

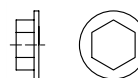

Zierkappen für Fassadenschrauben

weiß RAL 9010 (*630),
hellgrau RAL 9002 (*640),
hellelfenbein RAL 1015 (*670),
rotbraun RAL 8012 (*650)

REACH → TI-262

für Artikel 88176, 88276 mit Schlüsselweite 3/8"

F. SW 3/8	S	200	7,00 Kunstst
-----------	---	-----	--------------

Abmessungen	VE Stück	€/100/Obf.
Artikel 88277.920		
88277 A 2		

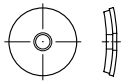

Dichtscheiben, gewölbte Metallscheiben mit aufvulkanisierter Dichtungslage

Dicke der Dichtung ca. 1,5 mm dick

Werkstoffeigensch. → **TI-236**

Aluminium → **646**

Außen Ø x Innen Ø x Dicke

16	x	6,8	x	1	S	1000	15,60 A2
19	x	6,8	x	1	S	1000	20,90 A2
25	x	6,8	x	1	S	1000	40,00 A2
25	x	8,5	x	1	S	1000	44,00 A2
29	x	6,8	x	1	S	1000	52,00 A2

Artikel 88296.924		
88296 A 2		ISR

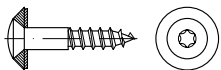

„Spenglerschrauben“ Liko-Holzschrauben DIN 7995, komplett mit Rosetten-/Dichtscheibe Ø 15, ISR = Innensechsrund-Antrieb T25

Werkstoffeigensch. → **TI-236**

Andere Scheiben Ø auf Anfrage

Ø x Länge-Scheiben Ø

4,5	x	25	-15	S	200	29,50 A2
4,5	x	35	-15	S	200	33,00 A2
4,5	x	45	-15	S	200	37,00 A2
4,5	x	55	-15	S	200	41,00 A2

Artikel 88302.910		
88302 A 1		Typ 302

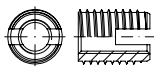

ENSAT-Gewindeeinsätze Typ 302, selbstschneidend m. Schneidschlitz, Innen = Regelgewinde

Produktinformation → **TI-152**

ENSAT-Setzwerkzeuge → **S. 437**



Innen-Nutzgewinde M x Länge

M 3	x	6	S	50	305,00 A1
M 4	x	8	S	50	305,00 A1

Abmessungen	VE Stück	€/100/Obf.			
M 5	x	10	S	50	315,00 A1
M 6	x	14	S	25	365,00 A1
M 8	x	15	S	25	495,00 A1
M 10	x	18	S	25	650,00 A1
M 12	x	22	S	25	880,00 A1
M 16	x	22	S	10	2450,00 A1
M 20	x	27	S	10	3200,00 A1

Artikel 88307.300		
88307 1.4105		Typ 307

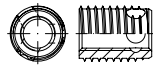

ENSAT-Gewindeeinsätze Typ 307, kurz, selbstschneidend, mit Schneidbohrungen, Innen = Regelgewinde

Produktinformation → **TI-152**

ENSAT-Setzwerkzeuge → **437**



Innen-Nutzgewinde M x Länge

M 5	x	7	S	50	350,00
M 6	x	8	S	25	405,00
M 8	x	9	S	25	485,00
M 10	x	10	S	25	600,00

Artikel 88330.921		
88330 A 2		Form A-SR



Gewindeeinsätze DIN 8140, mit Mitnehmer- (Abbrech-) Zapfen, A = für Nutz-Regelgewinde SR = AMECOIL Typ SR

Produktinformation → **TI-150**

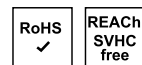

Nutzgewinde M x Länge eingebaut

M 3	x	3	S	25	65,00 A2
M 3	x	4,5	S	25	74,00 A2
M 3	x	6	S	25	81,00 A2
M 4	x	4	S	200	47,00 A2
M 4	x	4	K	25	55,00 A2
M 4	x	6	S	200	55,00 A2
M 4	x	6	K	25	64,00 A2
M 4	x	8	S	200	58,00 A2
M 4	x	8	K	25	66,00 A2
M 5	x	5	S	200	60,00 A2
M 5	x	5	K	25	68,00 A2
M 5	x	7,5	S	200	71,00 A2
M 5	x	7,5	K	25	77,00 A2
M 5	x	10	S	200	73,00 A2
M 5	x	10	K	25	81,00 A2
M 6	x	6	S	200	71,00 A2
M 6	x	6	K	25	77,00 A2
M 6	x	9	S	200	77,00 A2

Abmessungen	VE Stück	€/100/Obf.			
M 6	x	9	K	25	85,00 A2
M 6	x	12	S	200	81,00 A2
M 6	x	12	K	25	89,00 A2
M 6	x	15	S	200	95,00 A2
M 7	x	10,5	S	25	89,00 A2
M 8	x	8	S	100	73,00 A2
M 8	x	8	K	25	81,00 A2
M 8	x	12	S	100	85,00 A2
M 8	x	12	K	25	92,00 A2
M 8	x	16	S	100	90,00 A2
M 8	x	16	K	25	97,00 A2
M 8	x	20	S	100	106,00 A2
M 10	x	10	S	100	101,00 A2
M 10	x	10	K	25	109,00 A2
M 10	x	15	S	100	117,00 A2
M 10	x	15	K	25	125,00 A2
M 10	x	20	S	100	123,00 A2
M 10	x	20	K	25	131,00 A2
M 12	x	12	S	100	200,00 A2
M 12	x	12	K	15	212,00 A2
M 12	x	18	S	100	233,00 A2
M 12	x	18	K	15	244,00 A2
M 12	x	24	S	100	242,00 A2
M 12	x	24	K	15	255,00 A2
M 14	x	14	S	10	315,00 A2
M 14	x	21	S	10	355,00 A2
M 14	x	28	S	10	370,00 A2
M 16	x	16	S	50	395,00 A2
M 16	x	16	K	10	415,00 A2
M 16	x	24	S	50	460,00 A2
M 16	x	24	K	10	470,00 A2
M 16	x	32	S	50	480,00 A2
M 16	x	32	K	10	495,00 A2
M 18	x	18	S	10	485,00 A2
M 18	x	27	S	10	560,00 A2
M 20	x	20	S	10	550,00 A2
M 20	x	30	S	10	650,00 A2
M 20	x	40	S	10	670,00 A2
M 24	x	24	S	10	910,00 A2
M 24	x	36	S	10	1070,00 A2
M 24	x	48	S	10	1090,00 A2

Artikel 88331.926		
88331 A 2		Form A-Fein

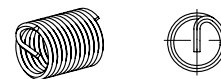

Gewindeeinsätze DIN 8140, mit Mitnehmer- (Abbrech-) Zapfen, A-Fein = für Nutz-Feingewinde

Produktinformation → **TI-150**

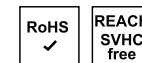

Nutzgewinde M x Länge eingebaut

M 8	x	1	x	8	S	25	81,00 A2
M 8	x	1	x	12	S	25	92,00 A2
M 8	x	1	x	16	S	25	97,00 A2
M 10	x	1	x	10	S	25	109,00 A2
M 10	x	1,25	x	10	S	25	109,00 A2
M 10	x	1	x	15	S	25	125,00 A2
M 10	x	1,25	x	15	S	25	125,00 A2
M 10	x	1	x	20	S	25	131,00 A2
M 10	x	1,25	x	20	S	25	131,00 A2
M 12	x	1,25	x	12	S	15	212,00 A2
M 12	x	1,5	x	12	S	15	212,00 A2
M 12	x	1,25	x	18	S	15	244,00 A2
M 12	x	1,5	x	18	S	15	244,00 A2

Abmessungen	VE	Stück	€/100/Obf.
M 12 x 1,25 x 24 S 15			255,00A2
M 12 x 1,5 x 24 S 15			255,00A2
M 14 x 1,25 x 8,4 S 15			185,00A2
M 14 x 1,25 x 12,4 S 15			185,00A2
M 14 x 1,5 x 14 S 10			315,00A2
M 14 x 1,25 x 16,4 S 15			185,00A2
M 14 x 1,5 x 21 S 10			355,00A2
M 14 x 1,5 x 28 S 10			370,00A2
M 16 x 1,5 x 16 S 10			415,00A2
M 16 x 1,5 x 24 S 10			470,00A2
M 16 x 1,5 x 32 S 10			495,00A2
M 20 x 1,5 x 20 S 10			550,00A2
M 20 x 2 x 20 S 10			550,00A2
M 20 x 1,5 x 30 S 10			650,00A2
M 20 x 2 x 30 S 10			650,00A2
M 20 x 1,5 x 40 S 10			670,00A2
M 20 x 2 x 40 S 10			670,00A2
M 24 x 1,5 x 24 S 10			910,00A2
M 24 x 2 x 24 S 10			910,00A2
M 24 x 1,5 x 36 S 10			1070,00A2
M 24 x 2 x 36 S 10			1070,00A2
M 24 x 1,5 x 48 S 10			1090,00A2
M 24 x 2 x 48 S 10			1290,00A2

Artikel 88333.000 **88333** Fein

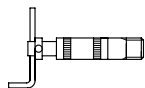

AMECOIL-Universal-Einbauwerkzeug, Grundwerkzeug ohne Spindel, ohne Vorspannpatrone
Fein = für Gewindeeins. Art. 88331

Produktinformation → TI-150

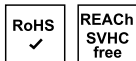

Größe / Einsatz-Nutzgewinde M

NR. 2 M 6 - M 8	S	1	2140,00
NR. 3 M10 - M12	S	1	2650,00
NR. 4 M14 - M16	S	1	3800,00

Artikel 88333.004 **88333** SR

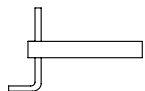

AMECOIL-Spezial-Einbauwerkzeug, Kurbel ohne Gewindespindel, SR = für Gewindeeinsätze
Artikel 88330 und 88346

Produktinformation → TI-150



Kurbel-Nr. / für Einsatz-Nutzgewinde M

Nr.1-M 2,5-M 8	S	1	2220,00
Nr.2-M10 -M16	S	1	2220,00

Abmessungen VE Stück €/100/Obf.
Artikel 88334.000 **88334** Fein

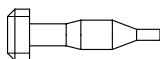

AMECOIL-Einbau-Zubehör, Spindel und Vorspannpatrone für Universal-Grundwerkzeug
Fein = für Gewindeeins. Art. 88331

Produktinformation → TI-150



Für Einsatz-Nutzgewinde M

M 8 x 1 S 1	2800,00
M 10 x 1 S 1	3100,00
M 10 x 1,25 S 1	3100,00
M 12 x 1,25 S 1	3200,00
M 12 x 1,5 S 1	3200,00
M 14 x 1,25 S 1	1880,00
M 14 x 1,5 S 1	1880,00
M 16 x 1,5 S 1	3700,00

Artikel 88334.004 **88334** SR



AMECOIL-Gewindespindel, für Spezial-Einbauwerkzeug, SR = für Gewindeeinsätze
Artikel 88330 und 88346

Produktinformation → TI-150



Für Einsatz-Nutzgewinde M / Kurbel-Nr.

M 3 / Nr.1 S 1	5600,00
M 4 / Nr.1 S 1	5600,00
M 5 / Nr.1 S 1	5600,00
M 6 / Nr.1 S 1	5600,00
M 7 / Nr.1 S 1	5600,00
M 8 / Nr.1 S 1	5600,00
M 10 / Nr.2 S 1	6800,00
M 12 / Nr.2 S 1	6800,00
M 14 / Nr.2 S 1	6800,00
M 16 / Nr.2 S 1	6800,00

Abmessungen VE Stück €/100/Obf.
Artikel 88335.000 **88335** Fein

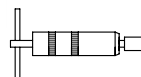

AMECOIL-Einbauwerkzeug, für je einen Durchmesser, Fein = für Gewindeeins. Art. 88331

Produktinformation → TI-150



Für Einsatz-Nutzgewinde M

M 20 x 1,5 S 1	10900,00
M 20 x 2 S 1	11200,00
M 24 x 1,5 S 1	11800,00
M 24 x 2 S 1	12300,00

Artikel 88335.004 **88335** SR

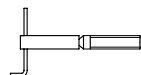

AMECOIL-Spezial-Einbauwerkzeug, für je einen Durchmesser, SR = für Gewindeeinsätze
Artikel 88330 und 88346

Produktinformation → TI-150

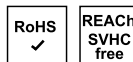

Für Einsatz-Nutzgewinde M

M 18 S 1	36600,00
M 20 S 1	36600,00
M 24 S 1	36600,00

Artikel 88336.000 **88336**



AMECOIL-Zapfenbrecher zur Entfernung des Mitnehmerzapfens, für Typen SR und Fein

Produktinformation → TI-150

Für Gewinde über Ø 18 spitze Zange verwenden

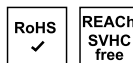

M 3 S 1	415,00
M 4 S 1	475,00
M 5 S 1	600,00
M 6 S 1	880,00

Abmessungen	VE	Stück	€/100/Obf.
M 8	S	1	940,00
M 10	S	1	950,00
M 12	S	1	1060,00
M 14	S	1	1140,00
M 16	S	1	1240,00
M 18	S	1	1320,00

Artikel 88337.000

88337

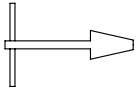

AMECOIL-Ausdrehwerkzeuge für Typen SR und Fein

Produktinformation → TI-150



Größe / für Einsatz-Nutzgewinde M

NR.1 M 2,5-M 8	S	1	1840,00
NR.2 M 5 -M 12	S	1	1970,00
NR.3 M 10 -M 24	S	1	2110,00

Artikel 88338.000

88338

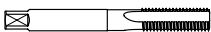

AMECOIL-Gewinde-Fertigschneider für Durchgangs- und Sacklöcher manuell oder maschinell, 2 Gang Anschnitt

Produktinformation → TI-150



Für Einsatz-Nutzgewinde M

M 3	S	1	1270,00
M 4	S	1	1310,00
M 5	S	1	1350,00
M 6	S	1	1510,00
M 7	S	1	1530,00
M 8	S	1	1860,00
M 8 x 1	S	1	2400,00
M 10	S	1	2380,00
M 10 x 1	S	1	2700,00
M 10 x 1,25	S	1	2750,00
M 12	S	1	3200,00
M 12 x 1,25	S	1	3700,00
M 12 x 1,5	S	1	3550,00
M 14	S	1	4000,00
M 14 x 1,25	S	1	4200,00
M 14 x 1,5	S	1	4200,00
M 16	S	1	4650,00
M 16 x 1,5	S	1	4800,00
M 18	S	1	6700,00
M 20	S	1	8500,00
M 20 x 1,5	S	1	7600,00
M 20 x 2	S	1	13100,00

Abmessungen	VE	Stück	€/100/Obf.
M 24	S	1	10500,00
M 24 x 1,5	S	1	9900,00
M 24 x 2	S	1	12100,00

Artikel 88339.000

88339

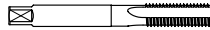

AMECOIL-Gewinde-Vorschneider für Durchgangs- und Sacklöcher, 4 Gang Anschnitt

Produktinformation → TI-150



Für Einsatz-Nutzgewinde M

M 18	S	1	7000,00
M 20	S	1	8800,00
M 22	S	1	9300,00
M 24	S	1	10900,00

Artikel 88342.000

88342 AMECOIL-Sortiment „MINIKIT“ Typ SR

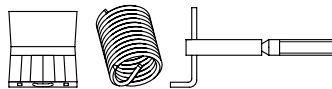

Inhalt: 5 Gewindeeinsätze nach Angabe mit Bohrer, Gewindegewinde, Einbauwerkzeug

M 4	S	1	8300,00
M 5	S	1	8300,00
M 6	S	1	8300,00
M 8	S	1	9100,00
M 10	S	1	11100,00

Artikel 88343.000

88343



AMECOIL-Werkstattkästen, unbefüllt

W-Kasten leer	S	1	2650,00
---------------	---	---	---------

Abmessungen	VE	Stück	€/100/Obf.
-------------	----	-------	------------

Artikel 88344.000

88344 AMECOIL-Sortiment Typ SR

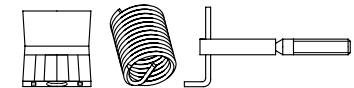

AMECOIL Sortimente, jeweils komplett mit Einbauwerkzeug

Nr. 1 = je 15 St. M 2,5-M 5, Länge 1,5 d
 Nr. 2 = je 15 St. M 4-M 8, Länge 1,5 d
 Nr. 3 = je 15 St. M 6-M 12, Länge 1,5 d

Nr.1	S	1	33200,00
Nr.2	S	1	33200,00
Nr.3	S	1	33200,00

Artikel 88346.922

88346 A 2 Form B-SR

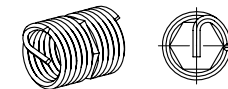

Gewindeeinsätze DIN 8140, mit Mitnehmer-(Abbrech-) Zapfen, B = Klemmend, für Regelgewinde M SR = AMECOIL Typ SR

Produktinformation → TI-150

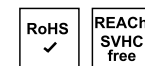

Nennmaß: Nutsgewinde M x Länge x Länge eingebaut

BM 3 x 3	S	25	77,00 A 2
BM 3 x 4,5	S	25	89,00 A 2
BM 3 x 6	S	25	97,00 A 2
BM 4 x 4	S	25	66,00 A 2
BM 4 x 6	S	25	75,00 A 2
BM 4 x 8	S	25	78,00 A 2
BM 5 x 5	S	25	81,00 A 2
BM 5 x 7,5	S	25	93,00 A 2
BM 5 x 10	S	25	96,00 A 2
BM 6 x 6	S	25	93,00 A 2
BM 6 x 9	S	25	101,00 A 2
BM 6 x 12	S	25	106,00 A 2
BM 8 x 8	S	25	96,00 A 2
BM 8 x 12	S	25	110,00 A 2
BM 8 x 16	S	25	115,00 A 2
BM 10 x 10	S	25	131,00 A 2
BM 10 x 15	S	25	150,00 A 2
BM 10 x 20	S	25	156,00 A 2
BM 12 x 12	S	15	255,00 A 2
BM 12 x 18	S	15	295,00 A 2
BM 12 x 24	S	15	310,00 A 2
BM 16 x 16	S	10	490,00 A 2
BM 16 x 24	S	10	570,00 A 2
BM 16 x 32	S	10	590,00 A 2
BM 20 x 20	S	10	670,00 A 2
BM 20 x 30	S	10	760,00 A 2
BM 20 x 40	S	10	790,00 A 2
BM 24 x 24	S	10	1090,00 A 2
BM 24 x 36	S	10	1280,00 A 2
BM 24 x 48	S	10	1300,00 A 2

Abmessungen	VE Stück	€/100/obf.
Artikel	88928.940	
88928	Mu A 4	HS 28/15

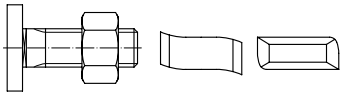

Hammerkopf-/Halben-Schrauben, Mu = mit Sechskantmutter

für Profile 28/15, 28/ 28/28, 26/26, Kopfformen: Lieferausführung freibleibend, Kopflänge ~22,5 mm

Werkstoffeigensch. → TI-236

Stahl → S. 442



Lieferausführung freibleibend

M 10	x	40	S	50	990,00 A4
M 10	x	50	S	50	1060,00 A4
M 10	x	80	S	25	1300,00 A4

Artikel	88938.940
88938	Mu A 4 HS 38/17

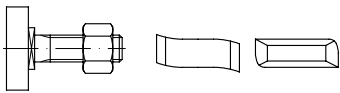

Hammerkopf-/Halben-Schrauben, Mu = mit Sechskantmutter

für Profile 38/17, 36/20, 36/36, 35/50, Kopfformen: Lieferausführung freibleibend, Kopflänge ~30,5 mm

Werkstoffeigensch. → TI-236

Stahl → S. 443

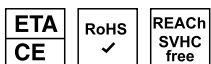

M 10	x	30	S	50	1380,00 A4
M 12	x	30	S	25	1400,00 A4
M 12	x	40	S	25	1440,00 A4
M 12	x	50	S	25	1550,00 A4
M 12	x	60	S	25	1790,00 A4
M 12	x	80	S	25	1830,00 A4
M 16	x	30	S	10	1880,00 A4
M 16	x	40	S	10	2120,00 A4
M 16	x	50	S	10	2230,00 A4
M 16	x	60	S	10	2330,00 A4
M 16	x	80	S	10	2800,00 A4
M 16	x	100	S	10	2950,00 A4

Abmessungen	VE Stück	€/100/obf.
Artikel	88940.940	
88940	Mu A 4	HS 40/22

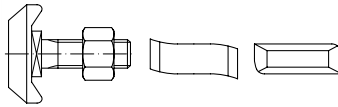

Hakenkopf-/Halben-Schrauben, Mu = mit Sechskantmutter

für Profile 40/22, 40/25, 422, Kopfformen: Lieferausführung freibleibend, Kopflänge ~32,5 mm

Werkstoffeigensch. → TI-236

Stahl → S. 443

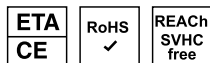

M 10	x	30	S	50	2900,00 A4
M 10	x	40	S	50	2950,00 A4
M 10	x	50	S	50	3050,00 A4
M 12	x	30	S	25	1860,00 A4
M 12	x	40	S	25	2270,00 A4
M 12	x	50	S	25	2650,00 A4
M 12	x	80	S	25	2800,00 A4
M 16	x	50	S	10	2700,00 A4
M 16	x	80	S	10	3000,00 A4
M 16	x	100	S	10	3600,00 A4

Artikel	88941.940
88941	Mu A 4 HZS 41/22

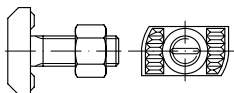

Hammerkopf-/Halben-Schrauben, Mu = mit Sechskantmutter

für Profile HZA/HZM 41/22, Kopflänge ~34,5 mm

Werkstoffeigensch. → TI-236

Stahl → S. 443

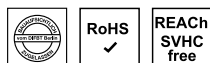

M 12	x	50	S	25	4700,00 A4
M 12	x	80	S	25	4950,00 A4
M 16	x	35	S	25	4650,00 A4
M 16	x	50	S	25	5200,00 A4

Abmessungen	VE Stück	€/100/obf.
Artikel	88943.940	
88943	Mu A 4	HZS 38/23

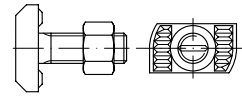

Hammerkopf-/Halben-Schrauben, Mu = mit Sechskantmutter

für Profil 38/23 DYNAGRIP, Kopflänge ~28,8 mm

Werkstoffeigensch. → TI-236

Stahl → S. 443



M 16	x	60	S	25	4450,00 A4
M 16	x	80	S	25	4850,00 A4

Achtung!

Feuerverzinkte Schrauben-/Mutter-Garnituren dürfen nur miteinander verschraubt werden, wenn Gewindenspiel/-Toleranzen dieser Garnituren entsprechend ISO 10684 passend aufeinander abgestimmt sind. Die Verwendung mit anderen Schrauben-/Mutter-Ausführungen kann zu Verschraubungsproblemen und/oder zum Versagen der Verbindung führen.



Artikel	88944.940
88944	Mu A 4 - 70 HZS 53/34

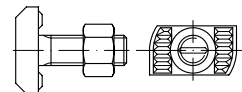

Hammerkopf-/Halben-Schrauben, Mu = mit Sechskantmutter

für Profil HZA 53/34, Kopflänge ~41,6 mm

Werkstoffeigensch. → TI-236

Stahl → S. 444

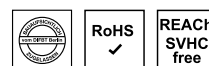

M 16	x	60	S	25	5500,00 A4
M 16	x	100	S	25	6100,00 A4
M 20	x	65	S	25	5900,00 A4
M 20	x	100	S	25	6700,00 A4

Abmessungen	VE Stück	€/100/Obf.
Artikel	88950.940	
88950	Mu A 4	HS 50/30

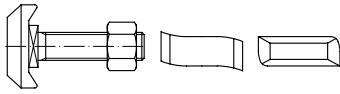

**Hakenkopf-/Halben-Schrauben,
Mu = mit Sechskantmutter**

für Profile 50/30, 50/40, 49/30, 52/34, 54/33, 486,
Kopfformen: Lieferausführung freibleibend,
Kopflänge ~41 mm

Werkstoffeigensch. → **TI-236**

Stahl → **S. 444**

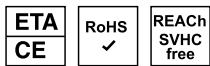

M 12	x	30	S	25	2310,00A4
M 12	x	40	S	25	2330,00A4
M 12	x	50	S	25	2550,00A4
M 16	x	40	S	10	4150,00A4
M 16	x	50	S	10	4400,00A4
M 16	x	60	S	10	4700,00A4
M 16	x	80	S	10	5600,00A4
M 20	x	55	S	10	4850,00A4
M 20	x	75	S	10	5500,00A4
M 20	x	100	S	10	5700,00A4

Artikel	88964.910
88964	A 1

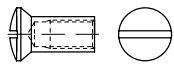

**Hülsenmuttern mit Linsensenkopf,
mit Innengewinde**

Maße → **TI-79**

Werkstoffeigensch. → **TI-236**

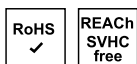

Innengewinde M x Länge

M 4	x	14	S	100	265,00A1
M 5	x	15	S	100	345,00A1
M 6	x	15	S	100	395,00A1
M 6	x	20	S	100	420,00A1
M 8	x	15	S	100	710,00A1
M 8	x	20	S	100	760,00A1

Abmessungen	VE Stück	€/100/Obf.
Artikel	89096.920	
89096	A 2	Ruko-Z



**Spanplattenschrauben,
Ruko = Halbrundkopf
Z = Pozidriv-Kreuzschlitz**

CE gemäß EN 14592 ab einer Gewindelänge 4 x d

**Achtung! Geringere Festigkeit gegenüber
gehärtetem Stahl.**

Maße → **TI-52**

Werkstoffeigensch. → **TI-236**

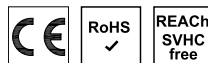

3	x	16 -Z	S	1000	11,00A2
3	x	20 -Z	S	1000	11,20A2
3	x	25 -Z	S	1000	11,50A2
3	x	30 -Z	S	1000	12,20A2
3,5	x	16 -Z	S	1000	12,20A2
3,5	x	20 -Z	S	1000	12,60A2
3,5	x	25 -Z	S	1000	13,10A2
3,5	x	30 -Z	S	1000	13,60A2
3,5	x	35 -Z	S	1000	15,60A2
3,5	x	40 -Z	S	1000	16,00A2
4	x	16 -Z	S	1000	14,10A2
4	x	20 -Z	S	1000	15,60A2
4	x	25 -Z	S	1000	16,50A2
4	x	30 -Z	S	1000	17,50A2
4	x	35 -Z	S	1000	20,40A2
4	x	40 -Z	S	1000	21,30A2
4	x	45 -Z	S	1000	22,30A2
4	x	50 -Z	S	1000	23,30A2
4,5	x	12 -Z	S	1000	20,90A2
4,5	x	16 -Z	S	1000	18,00A2
4,5	x	20 -Z	S	1000	16,50A2
4,5	x	25 -Z	S	1000	17,50A2
4,5	x	30 -Z	S	1000	19,40A2
4,5	x	35 -Z	S	500	20,40A2
4,5	x	40 -Z	S	500	22,30A2
4,5	x	45 -Z	S	500	24,30A2
4,5	x	50 -Z	S	500	31,50A2
4,5	x	60 -Z	S	500	41,00A2
5	x	20 -Z	S	1000	22,30A2
5	x	25 -Z	S	1000	22,90A2
5	x	30 -Z	S	1000	23,30A2
5	x	35 -Z	S	1000	29,50A2
5	x	40 -Z	S	1000	30,00A2
5	x	45 -Z	S	1000	34,00A2
5	x	50 -Z	S	500	35,00A2
5	x	60 -Z	S	500	39,00A2
5	x	70 -Z	S	500	62,00A2
6	x	40 -Z	S	500	46,50A2
6	x	45 -Z	S	500	49,50A2
6	x	50 -Z	S	200	54,00A2
6	x	60 -Z	S	200	60,00A2
6	x	70 -Z	S	200	78,00A2

Abmessungen	VE Stück	€/100/Obf.
Artikel	89097.920	
89097	A 2	Seko-Z



**Spanplattenschrauben,
Seko = Senkkopf
Z = Pozidriv-Kreuzschlitz**

CE gemäß EN 14592 ab einer Gewindelänge 4 x d

**Achtung! Geringere Festigkeit gegenüber
gehärtetem Stahl.**

Maße → **TI-52**

Werkstoffeigensch. → **TI-236**

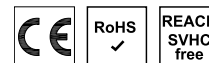

3	x	12 -Z	S	1000	10,00A2
3	x	12 -Z	K	200	13,90A2
3	x	16 -Z	S	1000	10,00A2
3	x	16 -Z	K	200	13,90A2
3	x	20 -Z	S	1000	10,90A2
3	x	20 -Z	K	200	14,80A2
3	x	25 -Z	S	1000	11,40A2
3	x	25 -Z	K	200	15,30A2
3	x	30 -Z	S	1000	12,10A2
3	x	30 -Z	K	200	15,90A2
3,5	x	16 -Z	S	1000	11,60A2
3,5	x	16 -Z	K	200	15,50A2
3,5	x	20 -Z	S	1000	12,10A2
3,5	x	20 -Z	K	200	15,90A2
3,5	x	25 -Z	S	1000	13,00A2
3,5	x	25 -Z	K	200	16,50A2
3,5	x	30 -Z	S	1000	13,40A2
3,5	x	30 -Z	K	200	17,30A2
3,5	x	35 -Z	S	1000	15,80A2
3,5	x	35 -Z	K	200	19,60A2
3,5	x	40 -Z	S	1000	16,20A2
3,5	x	40 -Z	K	200	20,10A2
3,5	x	45 -Z	S	1000	17,60A2
3,5	x	45 -Z	K	200	24,20A2
3,5	x	50 -Z	S	1000	21,80A2
3,5	x	50 -Z	K	200	27,50A2
4	x	16 -Z	S	1000	14,00A2
4	x	16 -Z	K	200	17,80A2
4	x	20 -Z	S	1000	15,10A2
4	x	20 -Z	K	200	19,00A2
4	x	25 -Z	S	1000	15,80A2
4	x	25 -Z	K	200	19,60A2
4	x	30 -Z	S	1000	17,60A2
4	x	30 -Z	K	200	21,40A2
4	x	35 -Z	S	1000	19,40A2
4	x	35 -Z	K	200	23,20A2
4	x	40 -Z	S	1000	20,50A2
4	x	40 -Z	K	200	24,40A2
4	x	45 -Z	S	1000	21,80A2
4	x	45 -Z	K	200	26,00A2
4	x	50 -Z	S	1000	22,90A2
4	x	50 -Z	K	200	27,00A2
4,5	x	20 -Z	S	1000	12,60A2
4,5	x	20 -Z	K	200	21,50A2
4,5	x	25 -Z	S	1000	18,00A2
4,5	x	25 -Z	K	200	22,50A2
4,5	x	30 -Z	S	1000	19,00A2
4,5	x	30 -Z	K	200	22,90A2
4,5	x	35 -Z	S	500	20,30A2
4,5	x	35 -Z	K	200	24,20A2
4,5	x	40 -Z	S	500	21,60A2

Abmessungen	VE	Stück	€/100/Obf.
4,5 x 40-Z	K	200	25,50A2
4,5 x 45-Z	S	500	23,70A2
4,5 x 45-Z	K	200	28,00A2
4,5 x 50-Z	S	500	30,00A2
4,5 x 50-Z	K	200	33,50A2
4,5 x 60-Z	S	500	40,00A2
4,5 x 60-Z	K	100	44,00A2
5 x 20-Z	S	1000	22,80A2
5 x 20-Z	K	200	28,50A2
5 x 25-Z	S	1000	22,40A2
5 x 25-Z	K	200	26,50A2
5 x 30-Z	S	1000	22,40A2
5 x 30-Z	K	200	26,50A2
5 x 35-Z	S	1000	28,50A2
5 x 35-Z	K	200	32,00A2
5 x 40-Z	S	1000	28,50A2
5 x 40-Z	K	200	32,50A2
5 x 50-Z	S	1000	34,50A2
5 x 50-Z	K	200	38,50A2
5 x 60-Z	S	500	48,50A2
5 x 60-Z	K	100	53,00A2
5 x 70-Z	S	500	62,00A2
5 x 70-Z	K	100	66,00A2
5 x 80-Z	S	500	69,00A2
5 x 80-Z	K	100	73,00A2
6 x 40-Z	S	500	36,50A2
6 x 40-Z	K	200	40,50A2
6 x 50-Z	S	200	51,00A2
6 x 50-Z	K	100	55,00A2
6 x 60-Z	S	200	59,00A2
6 x 60-Z	K	100	63,00A2
6 x 70-Z	S	200	77,00A2
6 x 70-Z	K	100	81,00A2
6 x 80-Z	S	200	83,00A2
6 x 80-Z	K	100	87,00A2

Artikel	89097.929
89097	A 2 Seko-Z-Tg



Spanplattenschrauben, Seko = Senkkopf Tg = Teilgewinde Z = Pozidriv-Kreuzschlitz

CE gemäß EN 14592 ab einer Gewindelänge 4 x d

Achtung! Geringere Festigkeit gegenüber gehärtetem Stahl.

Maße → TI-52

Werkstoffeigensch. → TI-236

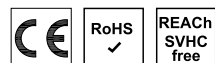

Abmessungen	VE	Stück	€/100/Obf.
4,5 x 45-Z	S	500	23,70A2
4,5 x 45-Z	K	200	28,00A2
4,5 x 50-Z	S	500	30,00A2
4,5 x 50-Z	K	200	33,50A2
4,5 x 60-Z	S	500	40,00A2
4,5 x 60-Z	K	100	44,00A2
4,5 x 70-Z	S	500	47,50A2
4,5 x 70-Z	K	100	54,00A2
5 x 50-Z	S	1000	34,50A2
5 x 50-Z	K	200	38,50A2
5 x 60-Z	S	500	48,50A2
5 x 60-Z	K	100	53,00A2
5 x 70-Z	S	500	62,00A2
5 x 70-Z	K	100	66,00A2
5 x 80-Z	S	500	69,00A2
5 x 80-Z	K	100	73,00A2
5 x 90-Z	S	200	75,00A2
5 x 90-Z	K	100	79,00A2
5 x 100-Z	S	200	83,00A2
5 x 100-Z	K	100	87,00A2
6 x 60-Z	S	200	59,00A2
6 x 60-Z	K	100	63,00A2
6 x 70-Z	S	200	77,00A2
6 x 70-Z	K	100	81,00A2
6 x 80-Z	S	200	83,00A2
6 x 80-Z	K	100	87,00A2
6 x 90-Z	S	200	90,00A2
6 x 90-Z	K	100	94,00A2
6 x 100-Z	S	100	98,00A2
6 x 110-Z	S	100	118,00A2
6 x 120-Z	S	100	119,00A2
6 x 130-Z	S	100	142,00A2
6 x 140-Z	S	100	161,00A2
6 x 150-Z	S	100	190,00A2

Artikel	89098.920
89098	A 2 Seko-ISR



Spanplattenschrauben mit Vollgewinde, Seko = Senkkopf ISR = Innensechsrund

CE gemäß EN 14592 ab einer Gewindelänge 4 x d

Achtung! Geringere Festigkeit gegenüber gehärtetem Stahl.

Zierkappen → Artikel 88006

Maße → TI-52

Werkstoffeigensch. → TI-236

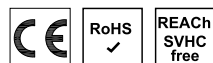

4 x 40-Z	S	1000	20,50A2
4 x 40-Z	K	200	24,40A2
4 x 45-Z	S	1000	21,80A2
4 x 45-Z	K	200	26,00A2
4 x 50-Z	S	1000	22,90A2
4 x 50-Z	K	200	27,00A2
4 x 60-Z	S	500	28,00A2
4 x 60-Z	K	100	32,00A2
4 x 70-Z	S	500	34,50A2
4 x 70-Z	K	100	39,00A2
4 x 80-Z	S	500	45,50A2
4 x 80-Z	K	100	53,00A2
4,5 x 40-Z	S	500	21,60A2
4,5 x 40-Z	K	200	25,50A2

3 x 12-T10	S	1000	17,50A2
3 x 12-T10	K	200	24,70A2
3 x 16-T10	S	1000	17,50A2
3 x 16-T10	K	200	24,70A2
3 x 20-T10	S	1000	19,20A2
3 x 20-T10	K	200	26,50A2
3 x 25-T10	S	1000	19,90A2
3 x 25-T10	K	200	27,00A2
3 x 30-T10	S	1000	21,20A2
3 x 30-T10	K	200	28,00A2
3 x 35-T10	S	1000	26,50A2
3 x 35-T10	K	200	34,50A2
3 x 40-T10	S	1000	35,00A2
3 x 40-T10	K	200	40,00A2

Abmessungen	VE	Stück	€/100/Obf.
3,5 x 16-T10	S	1000	20,40A2
3,5 x 16-T10	K	200	27,50A2
3,5 x 20-T10	S	1000	21,20A2
3,5 x 20-T10	K	200	28,00A2
3,5 x 25-T10	S	1000	22,30A2
3,5 x 25-T10	K	200	29,50A2
3,5 x 30-T10	S	1000	23,40A2
3,5 x 30-T10	K	200	30,50A2
3,5 x 35-T10	S	1000	28,00A2
3,5 x 35-T10	K	200	35,00A2
3,5 x 40-T10	S	1000	28,50A2
3,5 x 40-T10	K	200	35,50A2
4 x 16-T20	S	1000	24,70A2
4 x 16-T20	K	200	31,50A2
4 x 20-T20	S	1000	26,50A2
4 x 20-T20	K	200	33,50A2
4 x 25-T20	S	1000	28,00A2
4 x 25-T20	K	200	35,00A2
4 x 30-T20	S	1000	31,00A2
4 x 30-T20	K	200	38,00A2
4 x 35-T20	S	1000	34,00A2
4 x 35-T20	K	200	41,50A2
4 x 40-T20	S	1000	36,00A2
4 x 40-T20	K	200	43,00A2
4 x 45-T20	S	1000	38,50A2
4 x 45-T20	K	200	45,00A2
4 x 50-T20	S	1000	40,50A2
4 x 50-T20	K	200	47,50A2
4,5 x 16-T20	S	1000	28,50A2
4,5 x 16-T20	K	200	42,00A2
4,5 x 20-T20	S	1000	22,80A2
4,5 x 20-T20	K	200	38,00A2
4,5 x 25-T20	S	1000	32,00A2
4,5 x 25-T20	K	200	39,50A2
4,5 x 30-T20	S	1000	33,50A2
4,5 x 30-T20	K	200	40,50A2
4,5 x 35-T20	S	500	35,50A2
4,5 x 35-T20	K	200	43,00A2
4,5 x 40-T20	S	500	38,00A2
4,5 x 40-T20	K	200	45,00A2
4,5 x 45-T20	S	500	42,00A2
4,5 x 45-T20	K	200	48,50A2
4,5 x 50-T20	S	500	52,00A2
4,5 x 50-T20	K	200	59,00A2
4,5 x 60-T20	S	500	71,00A2
4,5 x 60-T20	K	100	78,00A2
4,5 x 70-T20	S	500	93,00A2
4,5 x 70-T20	K	100	106,00A2
5 x 20-T25	S	1000	40,00A2
5 x 20-T25	K	200	50,00A2
5 x 25-T25	S	1000	39,50A2
5 x 25-T25	K	200	47,50A2
5 x 30-T25	S	1000	39,50A2
5 x 30-T25	K	200	47,50A2
5 x 35-T25	S	1000	49,50A2
5 x 35-T25	K	200	57,00A2
5 x 40-T25	S	1000	50,00A2
5 x 40-T25	K	200	57,00A2
5 x 50-T25	S	1000	61,00A2
5 x 50-T25	K	200	68,00A2
5 x 60-T25	S	500	85,00A2
5 x 60-T25	K	100	92,00A2
5 x 70-T25	S	500	108,00A2
5 x 70-T25	K	100	115,00A2
5 x 80-T25	S	500	121,00A2
5 x 80-T25	K	100	129,00A2
6 x 40-T25	S	500	64,00A2
6 x 40-T25	K	200	71,00A2
6 x 50-T25	S	200	89,00A2
6 x 50-T25	K	100	97,00A2
6 x 60-T25	S	200	104,00A2
6 x 60-T25	K	100	111,00A2
6 x 70-T25	S	200	134,00A2
6 x 70-T25	K	100	141,00A2

Abmessungen	VE	Stück	€/100/Obf.
Artikel	89098.929		
89098	A 2	Seko-ISR-Tg	



**Spanplattenschrauben,
Seko = Senkkopf,
Tg = Teilgewinde,
ISR = Innensechsrund**

CE gemäß EN 14592 ab einer Gewindelänge 4 x d

Achtung! Geringere Festigkeit gegenüber gehärtetem Stahl.

Zierkappen → Artikel 88006

Maße → **TI-52**

Werkstoffeigensch. → **TI-236**



3,5	x	30-T10	S	1000	23,40A2
3,5	x	30-T10	K	200	30,50A2
3,5	x	35-T10	S	1000	28,00A2
3,5	x	35-T10	K	200	35,00A2
3,5	x	40-T10	S	1000	28,50A2
3,5	x	40-T10	K	200	35,50A2
4	x	30-T20	S	1000	31,00A2
4	x	30-T20	K	200	38,00A2
4	x	35-T20	S	1000	34,00A2
4	x	35-T20	K	200	41,50A2
4	x	40-T20	S	1000	36,00A2
4	x	40-T20	K	200	43,00A2
4	x	45-T20	S	1000	38,50A2
4	x	45-T20	K	200	45,00A2
4	x	50-T20	S	1000	40,50A2
4	x	50-T20	K	200	47,50A2
4	x	60-T20	S	500	49,00A2
4	x	60-T20	K	100	57,00A2
4	x	70-T20	S	500	61,00A2
4	x	70-T20	K	100	69,00A2
4	x	80-T20	S	500	80,00A2
4	x	80-T20	K	100	92,00A2
4,5	x	40-T20	S	500	38,00A2
4,5	x	40-T20	K	200	45,00A2
4,5	x	45-T20	S	500	42,00A2
4,5	x	45-T20	K	200	48,50A2
4,5	x	50-T20	S	500	52,00A2
4,5	x	50-T20	K	200	59,00A2
4,5	x	60-T20	S	500	71,00A2
4,5	x	60-T20	K	100	78,00A2
4,5	x	70-T20	S	500	93,00A2
4,5	x	70-T20	K	100	106,00A2
5	x	40-T25	S	1000	50,00A2
5	x	40-T25	K	200	57,00A2
5	x	45-T25	S	1000	58,00A2
5	x	45-T25	K	200	63,00A2
5	x	50-T25	S	1000	61,00A2
5	x	50-T25	K	200	68,00A2
5	x	60-T25	S	500	85,00A2
5	x	60-T25	K	100	92,00A2
5	x	70-T25	S	500	108,00A2
5	x	70-T25	K	100	115,00A2
5	x	80-T25	S	500	121,00A2
5	x	80-T25	K	100	129,00A2
5	x	90-T25	S	200	132,00A2
5	x	90-T25	K	100	139,00A2
5	x	100-T25	S	200	144,00A2
5	x	100-T25	K	100	152,00A2
5	x	120-T25	S	200	165,00A2

Abmessungen	VE	Stück	€/100/Obf.
5	x	120-T25	K 100 173,00A2
6	x	60-T25	S 200 104,00A2
6	x	60-T25	K 100 111,00A2
6	x	70-T25	S 200 134,00A2
6	x	70-T25	K 100 141,00A2
6	x	80-T25	S 200 152,00A2
6	x	80-T25	K 100 152,00A2
6	x	90-T25	S 200 157,00A2
6	x	90-T25	K 100 164,00A2
6	x	100-T25	S 100 171,00A2
6	x	110-T25	S 100 206,00A2
6	x	120-T25	S 100 237,00A2
6	x	130-T25	S 100 250,00A2
6	x	140-T25	S 100 285,00A2
6	x	150-T25	S 100 335,00A2
6	x	160-T25	S 100 260,00A2
6	x	180-T25	S 100 335,00A2
6	x	200-T25	S 100 430,00A2
8	x	70-T40	S 50 201,00A2
8	x	80-T40	S 50 228,00A2
8	x	90-T40	S 50 237,00A2
8	x	100-T40	S 50 260,00A2
8	x	120-T40	S 50 345,00A2
8	x	140-T40	S 50 475,00A2

Artikel	88002.(*)
88002	Kunststoff

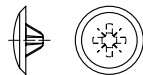

Zierkappen für Senkschrauben mit Pozidriv-Kreuzschlitz Z

weiß RAL 9010 (*630),
hellbraun RAL 8001 (*640),
dunkelbraun RAL 8014 (*650)

REACH → **TI-262**

Z-Kreuzschlitz-Nummer x Kappen Ø/für Schrauben Ø

1	x	8 / 3	S 1000	2,10 Kunstst
2	x	12 / 3,5-5	S 1000	2,10 Kunstst
3	x	13 / 5,5-6	S 1000	2,25 Kunstst

Abmessungen	VE	Stück	€/100/Obf.
Artikel	89192.902		
89192	Edelstah C1	ISR	

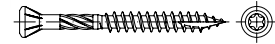

**Terrassenschrauben,
Senkkopf mit Fräsrippen,
ISR = Innensechsrund**

Werkstoffeigensch. → **TI-236**

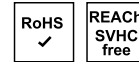

Nenn Ø x Nennlänge / Gewindelänge ca. Bit-Größe

5	x	40/26-T25	S 200	65,00
5	x	50/30-T25	S 200	79,00
5	x	60/36-T25	S 200	111,00
5	x	70/42-T25	S 200	141,00



- ✓ Große Artikelvielfalt
- ✓ Verlässliche Qualität
- ✓ Hohe Lieferbereitschaft

Abmessungen	VE Stück	€/100/Obf.
DIN	00084.704	
84	Messing	
	blank gedreht	

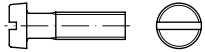

Zylinderschrauben mit Schlitz

Maße → **TI-37** Normumstellung → **TI-11**
 Werkstoffeigensch. → **TI-239** REACH → **TI-262**

Stahl → **S. 65**
 Rostfrei → **S. 455**

DIN 84 → wird ersetzt durch ISO 1207 (austauschbar)



M 1	x	2	S	100	52,00 Ms	gedr
M 1	x	3	S	100	53,00 Ms	gedr
M 1	x	4	S	100	53,00 Ms	gedr
M 1	x	5	S	100	56,00 Ms	gedr
M 1	x	6	S	100	61,00 Ms	gedr
M 1	x	8	S	100	68,00 Ms	gedr
M 1	x	10	S	100	77,00 Ms	gedr
M 1,4	x	3	S	100	50,00 Ms	gedr
M 1,4	x	4	S	100	52,00 Ms	gedr
M 1,4	x	5	S	100	53,00 Ms	gedr
M 1,4	x	6	S	100	58,00 Ms	gedr
M 1,4	x	8	S	100	67,00 Ms	gedr
M 1,4	x	10	S	100	75,00 Ms	gedr
M 1,4	x	12	S	100	93,00 Ms	gedr
M 1,4	x	16	S	100	98,00 Ms	gedr
M 1,6	x	4	S	100	46,50 Ms	gedr
M 1,6	x	5	S	100	47,50 Ms	gedr
M 1,6	x	6	S	100	49,00 Ms	gedr
M 1,6	x	8	S	100	56,00 Ms	gedr
M 1,6	x	10	S	100	58,00 Ms	gedr
M 1,6	x	12	S	100	65,00 Ms	gedr
M 1,6	x	16	S	100	73,00 Ms	gedr

Abmessungen	VE Stück	€/100/Obf.
DIN	00084.700	
84	Messing	

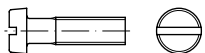

Zylinderschrauben mit Schlitz

Maße → **TI-37** Normumstellung → **TI-11**
 Werkstoffeigensch. → **TI-239** REACH → **TI-262**

Stahl → **S. 65**
 Rostfrei → **S. 455**

DIN 84 → wird ersetzt durch ISO 1207 (austauschbar)



M 2	x	4	K	200	14,10 Ms
M 2	x	5	K	200	13,30 Ms
M 2	x	6	K	200	12,40 Ms
M 2	x	8	K	200	11,00 Ms
M 2	x	10	K	200	11,40 Ms
M 2	x	12	K	200	12,00 Ms
M 2	x	16	K	200	13,30 Ms
M 2	x	20	K	200	14,60 Ms

M 2,5	x	3	K	200	27,00 Ms
M 2,5	x	4	K	200	11,20 Ms
M 2,5	x	5	K	200	11,70 Ms
M 2,5	x	6	K	200	11,60 Ms
M 2,5	x	8	K	200	11,00 Ms
M 2,5	x	10	K	200	11,40 Ms
M 2,5	x	12	K	200	12,00 Ms
M 2,5	x	16	K	200	13,30 Ms
M 2,5	x	20	K	200	14,60 Ms
M 3	x	4	S	1000	9,30 Ms
M 3	x	4	K	200	12,00 Ms
M 3	x	5	S	1000	8,70 Ms
M 3	x	5	K	200	11,30 Ms
M 3	x	6	S	1000	6,90 Ms
M 3	x	6	K	200	9,60 Ms
M 3	x	8	S	1000	7,10 Ms
M 3	x	8	K	200	9,70 Ms
M 3	x	10	S	1000	7,30 Ms
M 3	x	10	K	200	10,00 Ms
M 3	x	12	S	1000	7,70 Ms
M 3	x	12	K	200	10,40 Ms
M 3	x	16	S	1000	8,80 Ms
M 3	x	16	K	200	11,40 Ms
M 3	x	18	K	200	12,80 Ms
M 3	x	20	S	1000	10,10 Ms
M 3	x	20	K	200	13,10 Ms
M 3	x	25	S	1000	11,30 Ms
M 3	x	25	K	200	14,00 Ms
M 3	x	30	S	1000	13,80 Ms
M 3	x	30	K	200	16,50 Ms
M 3	x	35	K	200	17,30 Ms
M 3	x	40	K	200	23,40 Ms
M 3	x	45	K	200	31,00 Ms
M 3	x	50	K	200	37,00 Ms
M 3,5	x	8	K	200	13,80 Ms
M 3,5	x	10	K	200	14,40 Ms
M 3,5	x	12	K	200	14,60 Ms
M 3,5	x	16	K	200	17,00 Ms
M 3,5	x	20	K	200	19,40 Ms
M 4	x	5	S	1000	10,70 Ms
M 4	x	5	K	200	13,30 Ms
M 4	x	6	S	1000	9,50 Ms
M 4	x	6	K	200	12,10 Ms
M 4	x	8	S	1000	10,30 Ms
M 4	x	8	K	200	12,90 Ms
M 4	x	10	S	1000	10,70 Ms
M 4	x	10	K	200	13,30 Ms
M 4	x	12	S	1000	10,90 Ms
M 4	x	12	K	200	13,60 Ms
M 4	x	16	S	1000	13,00 Ms
M 4	x	16	K	200	15,70 Ms
M 4	x	20	S	1000	15,20 Ms
M 4	x	20	K	200	17,80 Ms
M 4	x	25	S	1000	16,00 Ms
M 4	x	25	K	200	18,60 Ms
M 4	x	30	S	1000	18,90 Ms
M 4	x	30	K	200	21,50 Ms
M 4	x	35	S	1000	21,00 Ms
M 4	x	35	K	200	23,60 Ms
M 4	x	40	S	1000	22,80 Ms
M 4	x	40	K	200	25,50 Ms
M 4	x	45	K	200	31,00 Ms
M 4	x	50	K	200	33,00 Ms
M 4	x	60	K	200	56,00 Ms
M 5	x	6	K	200	20,50 Ms
M 5	x	8	K	200	18,30 Ms
M 5	x	10	S	1000	16,00 Ms
M 5	x	10	K	200	18,60 Ms
M 5	x	12	S	1000	16,50 Ms
M 5	x	12	K	200	19,10 Ms
M 5	x	16	S	1000	18,90 Ms
M 5	x	16	K	200	21,50 Ms
M 5	x	20	S	1000	20,70 Ms
M 5	x	20	K	200	23,40 Ms
M 5	x	22	K	200	25,50 Ms

M 5	x	25	S	1000	23,10 Ms
M 5	x	25	K	200	26,00 Ms
M 5	x	30	S	1000	27,00 Ms
M 5	x	30	K	200	29,50 Ms
M 5	x	35	S	1000	34,50 Ms
M 5	x	35	K	200	37,50 Ms
M 5	x	40	S	500	37,00 Ms
M 5	x	40	K	200	39,50 Ms
M 5	x	45	K	200	43,00 Ms
M 5	x	50	K	200	45,50 Ms
M 5	x	60	K	200	56,00 Ms
M 5	x	70	K	200	69,00 Ms
M 6	x	8	K	200	29,50 Ms
M 6	x	10	S	1000	21,50 Ms
M 6	x	10	K	200	24,20 Ms
M 6	x	12	S	1000	24,20 Ms
M 6	x	12	K	200	27,00 Ms
M 6	x	16	S	1000	28,00 Ms
M 6	x	16	K	200	30,50 Ms
M 6	x	18	K	200	32,00 Ms
M 6	x	20	S	1000	30,50 Ms
M 6	x	20	K	200	33,50 Ms
M 6	x	25	S	1000	33,00 Ms
M 6	x	25	K	200	35,50 Ms
M 6	x	30	S	500	37,50 Ms
M 6	x	30	K	200	40,50 Ms
M 6	x	35	K	200	45,50 Ms
M 6	x	40	K	200	49,00 Ms
M 6	x	45	K	200	56,00 Ms
M 6	x	50	K	200	59,00 Ms
M 6	x	60	K	100	75,00 Ms
M 6	x	70	K	100	85,00 Ms
M 6	x	80	K	100	92,00 Ms
M 8	x	10	K	100	73,00 Ms
M 8	x	12	K	100	71,00 Ms
M 8	x	16	K	100	64,00 Ms
M 8	x	20	K	100	68,00 Ms
M 8	x	25	K	100	71,00 Ms
M 8	x	30	K	100	81,00 Ms
M 8	x	35	K	100	87,00 Ms
M 8	x	40	K	100	92,00 Ms
M 8	x	45	K	100	107,00 Ms
M 8	x	50	K	100	113,00 Ms
M 8	x	60	K	100	134,00 Ms
M 10	x	16	K	100	101,00 Ms
M 10	x	20	K	100	99,00 Ms
M 10	x	25	K	100	112,00 Ms
M 10	x	30	K	100	121,00 Ms
M 10	x	35	K	100	134,00 Ms
M 10	x	40	K	100	149,00 Ms
M 10	x	45	K	100	160,00 Ms
M 10	x	50	K	100	170,00 Ms

Abmessungen	VE Stück	€/100/Obf.
DIN	00084.730	
84	Messing	galvanisch vernickelt



Zylinderschrauben mit Schlitz

Maße → TI-37 Normumstellung → TI-11
 Werkstoffeigensch. → TI-239 REACH → TI-262
 Stahl → S. 65 Rostfrei → S. 455
 DIN 84 → wird ersetzt durch ISO 1207 (austauschbar)



M 2,5 x 6	K 200	10,30 Ms Ni
M 2,5 x 8	K 200	9,50 Ms Ni
M 2,5 x 10	K 200	9,90 Ms Ni
M 2,5 x 16	K 200	11,80 Ms Ni
M 3 x 6	K 200	8,10 Ms Ni
M 3 x 8	K 200	8,10 Ms Ni
M 3 x 10	K 200	8,40 Ms Ni
M 3 x 12	K 200	8,90 Ms Ni
M 3 x 16	K 200	10,00 Ms Ni
M 3 x 20	K 200	11,20 Ms Ni
M 3 x 25	K 200	12,40 Ms Ni
M 3 x 30	K 200	15,20 Ms Ni
M 4 x 6	K 200	10,70 Ms Ni
M 4 x 8	K 200	11,30 Ms Ni
M 4 x 10	K 200	11,80 Ms Ni
M 4 x 12	K 200	12,10 Ms Ni
M 4 x 16	K 200	14,40 Ms Ni
M 4 x 20	K 200	16,70 Ms Ni
M 4 x 25	K 200	17,80 Ms Ni
M 4 x 30	K 200	21,00 Ms Ni
M 4 x 40	K 200	25,50 Ms Ni
M 5 x 10	K 200	17,80 Ms Ni
M 5 x 16	K 200	21,30 Ms Ni
M 5 x 20	K 200	23,40 Ms Ni
M 5 x 30	K 200	30,50 Ms Ni
M 6 x 10	K 200	24,40 Ms Ni
M 6 x 16	K 200	31,50 Ms Ni
M 6 x 20	K 200	33,50 Ms Ni

Abmessungen	VE Stück	€/100/Obf.
DIN	00084.600	
84	Kunststoff PA	



Zylinderschrauben mit Schlitz

Achtung! Grobe Toleranzen nach VDI 2544.
 Muttern → DIN 555
 Maße → TI-37 REACH → TI-262
 Werkstoffeigensch. → TI-239
 Stahl → S. 65 Rostfrei → S. 455

M 2,5 x 6	S 200	8,20 Kunstst
M 2,5 x 8	S 200	8,30 Kunstst
M 2,5 x 10	S 200	8,40 Kunstst
M 2,5 x 16	S 200	8,50 Kunstst
M 3 x 4	S 200	5,80 Kunstst
M 3 x 5	S 200	5,90 Kunstst
M 3 x 6	S 200	6,00 Kunstst
M 3 x 8	S 200	6,10 Kunstst
M 3 x 10	S 200	6,20 Kunstst
M 3 x 12	S 200	6,30 Kunstst
M 3 x 16	S 200	6,40 Kunstst
M 3 x 20	S 200	6,50 Kunstst
M 3 x 25	S 200	6,60 Kunstst
M 3 x 30	S 200	6,80 Kunstst
M 4 x 6	S 200	6,00 Kunstst
M 4 x 8	S 200	6,10 Kunstst
M 4 x 10	S 200	6,30 Kunstst
M 4 x 12	S 200	6,50 Kunstst
M 4 x 16	S 200	6,60 Kunstst
M 4 x 20	S 200	6,90 Kunstst
M 4 x 25	S 200	7,20 Kunstst
M 4 x 30	S 200	7,70 Kunstst
M 4 x 35	S 200	8,10 Kunstst
M 4 x 40	S 200	8,30 Kunstst
M 5 x 6	S 200	6,80 Kunstst
M 5 x 8	S 200	6,90 Kunstst
M 5 x 10	S 200	7,20 Kunstst
M 5 x 12	S 200	7,40 Kunstst
M 5 x 16	S 200	7,90 Kunstst
M 5 x 20	S 200	9,20 Kunstst
M 5 x 25	S 200	9,60 Kunstst
M 5 x 30	S 200	10,30 Kunstst
M 5 x 35	S 200	11,00 Kunstst
M 5 x 40	S 200	11,60 Kunstst
M 5 x 50	S 200	12,90 Kunstst
M 6 x 8	S 200	18,60 Kunstst
M 6 x 10	S 200	8,20 Kunstst
M 6 x 12	S 200	8,30 Kunstst
M 6 x 16	S 200	8,70 Kunstst
M 6 x 20	S 200	9,60 Kunstst
M 6 x 25	S 200	10,40 Kunstst
M 6 x 30	S 200	12,60 Kunstst
M 6 x 35	S 200	13,20 Kunstst
M 6 x 40	S 200	13,60 Kunstst
M 6 x 45	S 200	14,00 Kunstst
M 6 x 50	S 200	14,40 Kunstst
M 6 x 60	S 100	15,70 Kunstst
M 6 x 70	S 100	16,60 Kunstst
M 8 x 16	S 200	17,30 Kunstst
M 8 x 20	S 200	18,90 Kunstst
M 8 x 25	S 200	20,10 Kunstst
M 8 x 30	S 200	21,60 Kunstst
M 8 x 40	S 100	23,90 Kunstst
M 8 x 50	S 100	25,50 Kunstst

Abmessungen	VE Stück	€/100/Obf.
DIN	00085.700	
85	Messing	



Flachkopfschrauben mit Schlitz

Maße → TI-37 Normumstellung → TI-11
 Werkstoffeigensch. → TI-239 REACH → TI-262
 Stahl → S. 67 Rostfrei → S. 457
 DIN 85 → wird ersetzt durch ISO 1580 (austauschbar)



M 3 x 4	K 200	10,00 Ms
M 3 x 5	K 200	9,20 Ms
M 3 x 6	K 200	7,50 Ms
M 3 x 8	K 200	7,60 Ms
M 3 x 10	K 200	7,90 Ms
M 3 x 12	K 200	8,40 Ms
M 3 x 16	K 200	9,60 Ms
M 3 x 20	K 200	10,90 Ms
M 3 x 25	K 200	12,40 Ms
M 3 x 30	K 200	15,20 Ms
M 4 x 6	K 200	10,40 Ms
M 4 x 8	K 200	11,00 Ms
M 4 x 10	K 200	11,60 Ms
M 4 x 12	K 200	11,80 Ms
M 4 x 16	K 200	14,10 Ms
M 4 x 20	K 200	16,50 Ms
M 4 x 25	K 200	17,30 Ms
M 4 x 30	K 200	20,50 Ms
M 4 x 35	K 200	23,10 Ms
M 4 x 40	K 200	25,00 Ms
M 5 x 6	K 200	19,40 Ms
M 5 x 8	K 200	17,00 Ms
M 5 x 10	K 200	17,30 Ms
M 5 x 12	K 200	17,80 Ms
M 5 x 16	K 200	20,50 Ms
M 5 x 20	K 200	22,60 Ms
M 5 x 25	K 200	25,50 Ms
M 5 x 30	K 200	29,50 Ms
M 5 x 35	K 200	38,00 Ms
M 5 x 40	K 200	40,00 Ms
M 6 x 10	K 200	23,60 Ms
M 6 x 12	K 200	27,00 Ms
M 6 x 16	K 200	30,50 Ms
M 6 x 20	K 200	34,00 Ms
M 6 x 25	K 200	36,00 Ms
M 6 x 30	K 200	41,50 Ms
M 6 x 35	K 200	47,00 Ms
M 6 x 40	K 200	51,00 Ms



- ✓ Große Artikelvielfalt
- ✓ Verlässliche Qualität
- ✓ Hohe Lieferbereitschaft

Abmessungen	VE Stück	€/100/Obf.
DIN 00085.600		
85	Kunststoff PA	

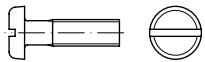

Flachkopfschrauben mit Schlitz

Achtung! Grobe Toleranzen nach VDI 2544.

Muttern → DIN 555

Maße → TI-37

REACH → TI-262

Werkstoffeigensch. → TI-239

Stahl → S. 67

Rostfrei → S. 457

M 3	x	6	S	200	6,40 Kunstst
M 3	x	8	S	200	6,50 Kunstst
M 3	x	10	S	200	6,90 Kunstst
M 3	x	12	S	200	7,20 Kunstst
M 4	x	5	S	200	10,00 Kunstst
M 4	x	6	S	200	10,50 Kunstst
M 4	x	8	S	200	12,00 Kunstst
M 4	x	10	S	200	7,00 Kunstst
M 4	x	12	S	200	7,10 Kunstst
M 4	x	16	S	200	7,30 Kunstst
M 4	x	20	S	200	7,60 Kunstst
M 5	x	8	S	200	7,70 Kunstst
M 5	x	10	S	200	7,90 Kunstst
M 5	x	12	S	200	8,30 Kunstst
M 5	x	16	S	200	8,70 Kunstst
M 5	x	20	S	200	10,10 Kunstst
M 6	x	10	S	200	9,00 Kunstst
M 6	x	16	S	200	9,60 Kunstst
M 6	x	20	S	200	10,60 Kunstst
M 6	x	25	S	200	12,50 Kunstst
M 6	x	30	S	200	13,80 Kunstst

DIN	00094.700
94	Messing



Splinte

Maße → TI-22

Normumstellung → TI-10

Werkstoffeigensch. → TI-239

REACH → TI-262

Stahl → S. 69

Rostfrei → S. 458

DIN 94 → wird ersetzt durch ISO 1234



Nenn Ø = Bohrungs Ø x Länge

1,6	x	10	S	200	12,80 Ms
1,6	x	12	S	200	12,90 Ms
1,6	x	16	S	200	13,00 Ms
1,6	x	20	S	200	13,20 Ms
1,6	x	25	S	200	14,10 Ms
2	x	10	S	100	15,40 Ms
2	x	12	S	100	15,60 Ms
2	x	16	S	100	15,80 Ms
2	x	20	S	100	16,00 Ms
2	x	25	S	100	17,00 Ms

Abmessungen	VE Stück	€/100/Obf.			
2	x	32	S	100	18,90 Ms
2	x	40	S	100	20,70 Ms
2	x	50	S	100	30,00 Ms
3,2	x	16	S	100	22,30 Ms
3,2	x	20	S	100	23,40 Ms
3,2	x	25	S	100	26,00 Ms
3,2	x	32	S	100	30,00 Ms
3,2	x	36	S	100	32,00 Ms
3,2	x	40	S	100	34,00 Ms
3,2	x	50	S	100	39,00 Ms
3,2	x	63	S	100	46,00 Ms
4	x	20	S	100	33,00 Ms
4	x	25	S	100	37,50 Ms
4	x	32	S	100	43,00 Ms
4	x	36	S	100	46,50 Ms
4	x	40	S	100	50,00 Ms
4	x	50	S	100	59,00 Ms
4	x	63	S	100	69,00 Ms
5	x	32	S	100	62,00 Ms
5	x	36	S	100	66,00 Ms
5	x	40	S	100	72,00 Ms
5	x	50	S	100	84,00 Ms
5	x	63	S	100	103,00 Ms
6,3	x	50	S	100	124,00 Ms
6,3	x	63	S	50	154,00 Ms
6,3	x	100	S	50	223,00 Ms

DIN	00094.301
94	Kupfer

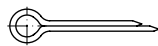

Splinte

Maße → TI-22

Normumstellung → TI-10

Werkstoffeigensch. → TI-239

Stahl → S. 69

Rostfrei → S. 458

DIN 94 → wird ersetzt durch ISO 1234



Nenn Ø = Bohrungs Ø x Länge

2	x	16	S	100	15,40 Cu
2	x	20	S	100	16,00 Cu
2	x	25	S	100	17,30 Cu
2	x	40	S	100	20,70 Cu
3,2	x	20	S	100	23,90 Cu
3,2	x	25	S	100	27,00 Cu
3,2	x	32	S	100	30,50 Cu
3,2	x	36	S	100	32,50 Cu
3,2	x	40	S	100	34,50 Cu
3,2	x	50	S	100	40,50 Cu
4	x	25	S	100	38,50 Cu
4	x	32	S	100	45,00 Cu
4	x	36	S	100	48,00 Cu
4	x	40	S	100	52,00 Cu
4	x	50	S	100	61,00 Cu
4	x	63	S	100	73,00 Cu
5	x	32	S	100	65,00 Cu
5	x	36	S	100	71,00 Cu
5	x	40	S	100	76,00 Cu
5	x	50	S	100	89,00 Cu
5	x	63	S	100	108,00 Cu
5	x	71	S	100	118,00 Cu
5	x	80	S	100	129,00 Cu
6,3	x	50	S	100	122,00 Cu
6,3	x	63	S	50	149,00 Cu
6,3	x	80	S	50	181,00 Cu

Abmessungen	VE Stück	€/100/Obf.
DIN 00095.700		
95	Messing	

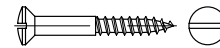

Linsensenk-Holzschrauben mit Schlitz

Maße → TI-50

REACH → TI-262

Werkstoffeigensch. → TI-239

Stahl → S. 70

Rostfrei → S. 459



1,6	x	10	S	500	5,90 Ms
1,6	x	12	S	500	6,00 Ms
2	x	8	S	500	6,10 Ms
2	x	10	S	500	6,20 Ms
2	x	12	S	500	6,40 Ms
2	x	16	S	500	6,80 Ms
2	x	20	S	500	7,10 Ms
2,5	x	10	S	500	5,60 Ms
2,5	x	12	S	500	5,70 Ms
2,5	x	16	S	500	5,80 Ms
2,5	x	20	S	500	6,30 Ms
2,5	x	25	S	500	8,40 Ms
3	x	10	S	200	5,50 Ms
3	x	12	S	200	5,60 Ms
3	x	16	S	200	5,80 Ms
3	x	20	S	200	6,20 Ms
3	x	25	S	200	6,60 Ms
3	x	30	S	200	6,90 Ms
3	x	35	S	200	9,30 Ms
3	x	40	S	200	12,40 Ms
3,5	x	10	S	200	8,10 Ms
3,5	x	12	S	200	7,90 Ms
3,5	x	16	S	200	5,10 Ms
3,5	x	20	S	200	5,60 Ms
3,5	x	25	S	200	6,80 Ms
3,5	x	30	S	200	8,10 Ms
3,5	x	35	S	200	9,30 Ms
3,5	x	40	S	200	12,40 Ms
3,5	x	45	S	200	14,90 Ms
3,5	x	50	S	200	18,10 Ms
4	x	12	S	200	10,70 Ms
4	x	16	S	200	7,70 Ms
4	x	20	S	200	7,50 Ms
4	x	25	S	200	8,30 Ms
4	x	30	S	200	9,50 Ms
4	x	35	S	200	10,70 Ms
4	x	40	S	200	12,00 Ms
4	x	45	S	200	13,80 Ms
4	x	50	S	200	16,40 Ms
4	x	55	S	200	27,50 Ms
4	x	60	S	200	30,50 Ms
4,5	x	16	S	200	15,30 Ms
4,5	x	20	S	200	11,00 Ms
4,5	x	25	S	200	11,50 Ms
4,5	x	30	S	200	13,60 Ms
4,5	x	35	S	200	14,10 Ms
4,5	x	40	S	200	14,60 Ms
4,5	x	45	S	200	16,50 Ms
4,5	x	50	S	200	18,90 Ms
4,5	x	60	S	200	24,60 Ms
4,5	x	70	S	200	53,00 Ms
5	x	16	S	200	23,40 Ms
5	x	20	S	200	16,70 Ms

Abmessungen	VE	Stück	€/100/Obf.
5 x 25	S	200	16,90 Ms
5 x 30	S	200	17,20 Ms
5 x 35	S	200	18,60 Ms
5 x 40	S	200	19,70 Ms
5 x 45	S	200	20,20 Ms
5 x 50	S	200	22,30 Ms
5 x 55	S	200	29,50 Ms
5 x 60	S	200	31,00 Ms
5 x 70	S	200	34,00 Ms
5 x 80	S	200	53,00 Ms
5 x 90	S	200	72,00 Ms
5 x 100	S	200	75,00 Ms
6 x 20	S	200	35,50 Ms
6 x 25	S	200	36,00 Ms
6 x 30	S	200	36,50 Ms
6 x 35	S	200	37,00 Ms
6 x 40	S	200	37,50 Ms
6 x 50	S	200	38,00 Ms
6 x 60	S	100	38,50 Ms
6 x 70	S	100	53,00 Ms
6 x 80	S	100	60,00 Ms
6 x 90	S	100	66,00 Ms
6 x 100	S	100	70,00 Ms
8 x 50	S	100	112,00 Ms

DIN 00095.730

95 Messing galvanisch vernickelt

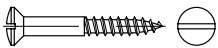

Linsenk-Holzschrauben mit Schlitz

Maße → **Ti-50** REACH → **Ti-262**
 Werkstoffeigensch. → **Ti-239**
 Stahl → **S. 70**
 Rostfrei → **S. 459**



1,6 x 10	S	500	7,10 Ms Ni
1,6 x 12	S	500	7,00 Ms Ni
2 x 10	S	500	6,80 Ms Ni
2 x 12	S	500	6,70 Ms Ni
2 x 16	S	500	8,10 Ms Ni
2,5 x 10	S	500	7,10 Ms Ni
2,5 x 12	S	500	6,90 Ms Ni
2,5 x 16	S	500	7,20 Ms Ni
2,5 x 20	S	500	8,10 Ms Ni
2,5 x 25	S	500	10,00 Ms Ni
3 x 10	S	200	6,40 Ms Ni
3 x 12	S	200	6,30 Ms Ni
3 x 16	S	200	5,70 Ms Ni
3 x 20	S	200	6,40 Ms Ni
3 x 25	S	200	7,50 Ms Ni
3 x 30	S	200	9,50 Ms Ni
3 x 35	S	200	11,40 Ms Ni
3 x 40	S	200	14,90 Ms Ni
3,5 x 12	S	200	8,90 Ms Ni
3,5 x 16	S	200	6,30 Ms Ni
3,5 x 20	S	200	6,90 Ms Ni
3,5 x 25	S	200	8,50 Ms Ni
3,5 x 30	S	200	10,00 Ms Ni
3,5 x 35	S	200	11,60 Ms Ni
3,5 x 40	S	200	15,00 Ms Ni
4 x 12	S	200	12,10 Ms Ni
4 x 16	S	200	8,90 Ms Ni
4 x 20	S	200	9,10 Ms Ni

Abmessungen	VE	Stück	€/100/Obf.
4 x 25	S	200	10,10 Ms Ni
4 x 30	S	200	11,60 Ms Ni
4 x 35	S	200	13,00 Ms Ni
4 x 40	S	200	14,60 Ms Ni
4 x 45	S	200	16,70 Ms Ni
4 x 50	S	200	19,70 Ms Ni
4 x 60	S	200	29,00 Ms Ni
4 x 70	S	200	53,00 Ms Ni
4,5 x 16	S	200	13,40 Ms Ni
4,5 x 20	S	200	12,90 Ms Ni
4,5 x 25	S	200	13,20 Ms Ni
4,5 x 30	S	200	16,20 Ms Ni
4,5 x 35	S	200	17,00 Ms Ni
4,5 x 40	S	200	17,80 Ms Ni
4,5 x 45	S	200	20,20 Ms Ni
4,5 x 50	S	200	23,00 Ms Ni
4,5 x 60	S	200	30,00 Ms Ni
5 x 20	S	200	19,00 Ms Ni
5 x 25	S	200	19,70 Ms Ni
5 x 30	S	200	20,10 Ms Ni
5 x 35	S	200	22,30 Ms Ni
5 x 40	S	200	23,60 Ms Ni
5 x 45	S	200	24,60 Ms Ni
5 x 50	S	200	27,50 Ms Ni
5 x 60	S	200	33,00 Ms Ni
5 x 70	S	200	41,50 Ms Ni
5 x 80	S	200	72,00 Ms Ni
6 x 40	S	200	40,50 Ms Ni
6 x 50	S	200	42,50 Ms Ni
6 x 60	S	100	47,50 Ms Ni
6 x 70	S	100	64,00 Ms Ni
6 x 80	S	100	74,00 Ms Ni
6 x 90	S	100	79,00 Ms Ni
6 x 100	S	100	81,00 Ms Ni

DIN 00095.740

95 Messing galvanisch verchromt

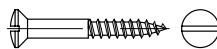

Linsenk-Holzschrauben mit Schlitz

Maße → **Ti-50** REACH → **Ti-262**
 Werkstoffeigensch. → **Ti-239**
 Stahl → **S. 70**
 Rostfrei → **S. 459**



3 x 12	S	200	7,50 Ms Gr
3 x 16	S	200	6,90 Ms Gr
3 x 20	S	200	7,90 Ms Gr
3 x 25	S	200	9,10 Ms Gr
3 x 30	S	200	11,60 Ms Gr
3 x 35	S	200	13,80 Ms Gr
3 x 40	S	200	17,50 Ms Gr
3,5 x 12	S	200	10,30 Ms Gr
3,5 x 16	S	200	7,90 Ms Gr
3,5 x 20	S	200	8,90 Ms Gr
3,5 x 25	S	200	10,80 Ms Gr
3,5 x 30	S	200	12,10 Ms Gr
3,5 x 35	S	200	14,80 Ms Gr
3,5 x 40	S	200	18,50 Ms Gr
3,5 x 45	S	200	21,30 Ms Gr
3,5 x 50	S	200	25,50 Ms Gr
4 x 16	S	200	11,00 Ms Gr
4 x 20	S	200	11,40 Ms Gr

Abmessungen	VE	Stück	€/100/Obf.
4 x 25	S	200	12,80 Ms Cr
4 x 30	S	200	14,90 Ms Cr
4 x 35	S	200	16,90 Ms Cr
4 x 40	S	200	18,70 Ms Cr
4 x 45	S	200	21,40 Ms Cr
4 x 50	S	200	24,70 Ms Cr
4 x 60	S	200	35,50 Ms Cr
4,5 x 16	S	200	16,00 Ms Cr
4,5 x 20	S	200	16,20 Ms Cr
4,5 x 25	S	200	16,60 Ms Cr
4,5 x 30	S	200	20,30 Ms Cr
4,5 x 35	S	200	21,70 Ms Cr
4,5 x 40	S	200	23,00 Ms Cr
4,5 x 45	S	200	26,00 Ms Cr
4,5 x 50	S	200	29,50 Ms Cr
4,5 x 60	S	200	37,50 Ms Cr
4,5 x 70	S	200	70,00 Ms Cr
5 x 20	S	200	23,00 Ms Cr
5 x 25	S	200	23,80 Ms Cr
5 x 30	S	200	25,50 Ms Cr
5 x 35	S	200	28,00 Ms Cr
5 x 40	S	200	30,00 Ms Cr
5 x 45	S	200	32,00 Ms Cr
5 x 50	S	200	35,00 Ms Cr
5 x 60	S	200	42,50 Ms Cr
5 x 70	S	200	53,00 Ms Cr
6 x 30	S	200	49,00 Ms Cr
6 x 35	S	200	50,00 Ms Cr
6 x 40	S	200	51,00 Ms Cr
6 x 45	S	200	52,00 Ms Cr
6 x 50	S	200	53,00 Ms Cr
6 x 60	S	100	61,00 Ms Cr
6 x 70	S	100	80,00 Ms Cr
6 x 80	S	100	93,00 Ms Cr
6 x 90	S	100	99,00 Ms Cr
6 x 100	S	100	102,00 Ms Cr

DIN 00095.750

95 Messing brüniert

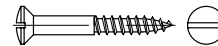

Linsenk-Holzschrauben mit Schlitz

Maße → **Ti-50** REACH → **Ti-262**
 Werkstoffeigensch. → **Ti-239**
 Stahl → **S. 70**
 Rostfrei → **S. 459**



3 x 16	S	200	6,40 Ms brün
3 x 20	S	200	7,20 Ms brün
3 x 25	S	200	8,30 Ms brün
3 x 30	S	200	10,70 Ms brün
3 x 35	S	200	13,40 Ms brün
3 x 40	S	200	17,10 Ms brün
3,5 x 16	S	200	6,90 Ms brün
3,5 x 20	S	200	7,90 Ms brün
3,5 x 25	S	200	9,50 Ms brün
3,5 x 30	S	200	11,30 Ms brün
3,5 x 35	S	200	12,90 Ms brün
3,5 x 40	S	200	16,70 Ms brün
4 x 16	S	200	10,80 Ms brün
4 x 20	S	200	11,00 Ms brün
4 x 25	S	200	11,30 Ms brün
4 x 30	S	200	13,00 Ms brün

Abmessungen	VE	Stück	€/100/Obf.
4 x 35	S	200	14,80 Ms brün
4 x 40	S	200	16,50 Ms brün
4 x 45	S	200	21,80 Ms brün
4 x 50	S	200	22,00 Ms brün
4,5 x 45	S	200	26,50 Ms brün
4,5 x 50	S	200	30,00 Ms brün
4,5 x 60	S	200	38,00 Ms brün

DIN	00096.700
96	Messing

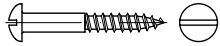

Halbrund-Holzschrauben mit Schlitz

Maße → **TI-51** REACH → **TI-262**
 Werkstoffeigensch. → **TI-239**
 Stahl → **S. 70**
 Rostfrei → **S. 460**



1,6 x 8	S	500	6,40 Ms
1,6 x 10	S	500	6,60 Ms
1,6 x 12	S	500	6,80 Ms
1,6 x 16	S	500	7,70 Ms
2 x 8	S	500	6,50 Ms
2 x 10	S	500	6,60 Ms
2 x 12	S	500	6,80 Ms
2 x 16	S	500	7,60 Ms
2 x 20	S	500	8,50 Ms
2,5 x 8	S	500	6,80 Ms
2,5 x 10	S	500	7,00 Ms
2,5 x 12	S	500	7,20 Ms
2,5 x 16	S	500	7,30 Ms
2,5 x 20	S	500	8,30 Ms
2,5 x 25	S	500	11,00 Ms
3 x 8	S	200	6,80 Ms
3 x 10	S	200	7,00 Ms
3 x 12	S	200	7,20 Ms
3 x 16	S	200	7,60 Ms
3 x 20	S	200	8,50 Ms
3 x 25	S	200	8,70 Ms
3 x 30	S	200	8,90 Ms
3 x 35	S	200	12,90 Ms
3 x 40	S	200	17,80 Ms
3,5 x 10	S	200	8,00 Ms
3,5 x 12	S	200	8,10 Ms
3,5 x 16	S	200	8,30 Ms
3,5 x 20	S	200	8,50 Ms
3,5 x 25	S	200	8,80 Ms
3,5 x 30	S	200	9,20 Ms
3,5 x 35	S	200	12,20 Ms
3,5 x 40	S	200	13,70 Ms
3,5 x 45	S	200	30,50 Ms
3,5 x 50	S	200	33,50 Ms
4 x 10	S	200	9,60 Ms
4 x 12	S	200	9,80 Ms
4 x 16	S	200	10,00 Ms
4 x 20	S	200	10,20 Ms
4 x 25	S	200	10,40 Ms
4 x 30	S	200	10,50 Ms
4 x 35	S	200	14,20 Ms
4 x 40	S	200	15,80 Ms
4 x 45	S	200	18,20 Ms
4 x 50	S	200	19,70 Ms
4 x 60	S	200	38,00 Ms
4,5 x 16	S	200	16,60 Ms

Abmessungen	VE	Stück	€/100/Obf.
4,5 x 20	S	200	16,20 Ms
4,5 x 25	S	200	12,10 Ms
4,5 x 30	S	200	14,80 Ms
4,5 x 35	S	200	15,60 Ms
4,5 x 40	S	200	19,00 Ms
4,5 x 45	S	200	20,20 Ms
4,5 x 50	S	200	25,50 Ms
4,5 x 60	S	200	39,50 Ms
5 x 12	S	200	18,50 Ms
5 x 16	S	200	19,00 Ms
5 x 20	S	200	19,50 Ms
5 x 25	S	200	20,00 Ms
5 x 30	S	200	20,50 Ms
5 x 35	S	200	21,00 Ms
5 x 40	S	200	22,00 Ms
5 x 45	S	200	25,50 Ms
5 x 50	S	200	27,50 Ms
5 x 60	S	200	36,00 Ms
5 x 70	S	200	38,50 Ms
5 x 80	S	200	65,00 Ms
6 x 20	S	200	35,00 Ms
6 x 25	S	200	36,00 Ms
6 x 30	S	200	37,00 Ms
6 x 35	S	200	38,00 Ms
6 x 40	S	200	39,00 Ms
6 x 45	S	200	40,00 Ms
6 x 50	S	200	42,00 Ms
6 x 60	S	100	51,00 Ms
6 x 70	S	100	60,00 Ms
6 x 80	S	100	70,00 Ms
6 x 100	S	100	117,00 Ms

DIN	00096.730
96	Messing galvanisch vernickelt

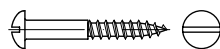

Halbrund-Holzschrauben mit Schlitz

Maße → **TI-51** REACH → **TI-262**
 Werkstoffeigensch. → **TI-239**
 Stahl → **S. 70**
 Rostfrei → **S. 460**



2 x 10	S	500	8,10 Ms Ni
2,5 x 12	S	500	8,50 Ms Ni
2,5 x 16	S	500	8,80 Ms Ni
3 x 16	S	200	9,10 Ms Ni
3 x 20	S	200	9,50 Ms Ni
3 x 25	S	200	9,80 Ms Ni
3,5 x 16	S	200	10,20 Ms Ni
3,5 x 20	S	200	10,50 Ms Ni
3,5 x 25	S	200	10,90 Ms Ni
4 x 16	S	200	11,10 Ms Ni
4 x 20	S	200	11,40 Ms Ni
4 x 25	S	200	12,90 Ms Ni
4 x 30	S	200	15,00 Ms Ni
4 x 35	S	200	19,10 Ms Ni
4 x 40	S	200	21,40 Ms Ni

Abmessungen	VE	Stück	€/100/Obf.
DIN	00097.700		
97	Messing		

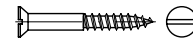

Senk-Holzschrauben mit Schlitz

Maße → **TI-51** REACH → **TI-262**
 Werkstoffeigensch. → **TI-239**
 Stahl → **S. 70**
 Rostfrei → **S. 460**



1,6 x 8	S	500	5,90 Ms
1,6 x 10	S	500	5,90 Ms
1,6 x 12	S	500	5,90 Ms
1,6 x 16	S	500	7,10 Ms
2 x 8	S	500	5,90 Ms
2 x 10	S	500	5,90 Ms
2 x 12	S	500	5,70 Ms
2 x 16	S	500	6,80 Ms
2 x 20	S	500	7,10 Ms
2,5 x 8	S	500	5,50 Ms
2,5 x 10	S	500	5,60 Ms
2,5 x 12	S	500	5,60 Ms
2,5 x 16	S	500	5,70 Ms
2,5 x 20	S	500	6,30 Ms
2,5 x 25	S	500	8,40 Ms
2,5 x 30	S	500	9,70 Ms
3 x 8	S	200	7,90 Ms
3 x 10	S	200	5,50 Ms
3 x 12	S	200	5,50 Ms
3 x 16	S	200	4,65 Ms
3 x 20	S	200	5,20 Ms
3 x 25	S	200	5,90 Ms
3 x 30	S	200	6,90 Ms
3 x 35	S	200	9,30 Ms
3 x 40	S	200	12,40 Ms
3 x 45	S	200	14,60 Ms
3 x 50	S	200	17,80 Ms
3,5 x 10	S	200	7,60 Ms
3,5 x 12	S	200	7,90 Ms
3,5 x 16	S	200	5,10 Ms
3,5 x 20	S	200	5,60 Ms
3,5 x 25	S	200	6,80 Ms
3,5 x 30	S	200	8,10 Ms
3,5 x 35	S	200	9,30 Ms
3,5 x 40	S	200	12,40 Ms
3,5 x 45	S	200	14,90 Ms
3,5 x 50	S	200	18,10 Ms
4 x 10	S	200	10,70 Ms
4 x 12	S	200	10,80 Ms
4 x 16	S	200	7,70 Ms
4 x 20	S	200	7,50 Ms
4 x 25	S	200	8,30 Ms
4 x 30	S	200	9,50 Ms
4 x 35	S	200	10,80 Ms
4 x 40	S	200	12,00 Ms
4 x 45	S	200	13,80 Ms
4 x 50	S	200	16,40 Ms
4 x 60	S	200	24,60 Ms
4,5 x 16	S	200	15,30 Ms
4,5 x 20	S	200	11,00 Ms
4,5 x 25	S	200	11,00 Ms
4,5 x 30	S	200	13,60 Ms
4,5 x 35	S	200	14,10 Ms
4,5 x 40	S	200	14,60 Ms

Abmessungen	VE	Stück	€/100/Obf.
4,5 x 45	S	200	16,50 Ms
4,5 x 50	S	200	18,90 Ms
4,5 x 60	S	200	24,60 Ms
5 x 16	S	200	23,40 Ms
5 x 20	S	200	16,70 Ms
5 x 25	S	200	16,90 Ms
5 x 30	S	200	16,90 Ms
5 x 35	S	200	18,60 Ms
5 x 40	S	200	19,70 Ms
5 x 45	S	200	20,20 Ms
5 x 50	S	200	22,30 Ms
5 x 55	S	200	29,00 Ms
5 x 60	S	200	27,00 Ms
5 x 70	S	200	34,00 Ms
5 x 80	S	200	53,00 Ms
5 x 90	S	200	72,00 Ms
5 x 100	S	200	75,00 Ms
5,5 x 35	S	200	27,50 Ms
5,5 x 40	S	200	27,00 Ms
5,5 x 45	S	200	27,50 Ms
5,5 x 50	S	200	28,50 Ms
5,5 x 60	S	100	32,50 Ms
6 x 20	S	200	35,50 Ms
6 x 25	S	200	34,50 Ms
6 x 30	S	200	35,00 Ms
6 x 35	S	200	36,00 Ms
6 x 40	S	200	34,00 Ms
6 x 45	S	200	34,50 Ms
6 x 50	S	200	34,50 Ms
6 x 60	S	100	38,50 Ms
6 x 70	S	100	53,00 Ms
6 x 80	S	100	60,00 Ms
6 x 90	S	100	66,00 Ms
6 x 100	S	100	66,00 Ms
8 x 50	S	100	112,00 Ms
8 x 60	S	100	116,00 Ms
8 x 70	S	100	123,00 Ms
8 x 80	S	100	169,00 Ms
8 x 100	S	100	211,00 Ms

DIN 00097.730

97 Messing galvanisch vernickelt

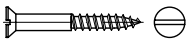

Senk-Holzschrauben mit Schlitz

Maße → TI-51 REACH → TI-262
 Werkstoffeigensch. → TI-239

Stahl → S. 70
 Rostfrei → S. 460



2,5 x 12	S	200	7,30 Ms Ni
2,5 x 16	S	200	7,60 Ms Ni
2,5 x 20	S	200	8,40 Ms Ni
3 x 10	S	200	6,40 Ms Ni
3 x 12	S	200	6,50 Ms Ni
3 x 16	S	200	5,70 Ms Ni
3 x 20	S	200	6,40 Ms Ni
3 x 25	S	200	7,30 Ms Ni
3 x 30	S	200	9,50 Ms Ni
3,5 x 16	S	200	6,10 Ms Ni
3,5 x 20	S	200	6,90 Ms Ni
3,5 x 25	S	200	8,40 Ms Ni
3,5 x 30	S	200	10,00 Ms Ni
4 x 20	S	200	9,10 Ms Ni

Abmessungen	VE	Stück	€/100/Obf.
4 x 25	S	200	10,50 Ms Ni
4 x 30	S	200	12,10 Ms Ni
4 x 35	S	200	13,70 Ms Ni
4 x 40	S	200	15,30 Ms Ni
4 x 50	S	200	20,50 Ms Ni
5 x 40	S	200	24,70 Ms Ni
5 x 50	S	200	28,50 Ms Ni

DIN 00125.701

125-1 Messing Form A

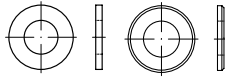

Scheiben, A = ohne Fase*

*ab 10,5 Ø Form B mit Fase

Maße → TI-84 Normumstellung → TI-84
 Werkstoffeigensch. → TI-239 REACH → TI-262

Stahl → S. 70
 Rostfrei → S. 461

DIN 125-1 Form A → wird ersetzt durch ISO 7089



Innen Ø x Außen Ø x Dicke

2,2 x 5 x 0,3	S	1000	2,65 Ms
2,2 x 5 x 0,3	K	100	8,30 Ms
2,5 x 6 x 0,5	S	1000	2,65 Ms
2,5 x 6 x 0,5	K	100	8,30 Ms
2,7 x 6 x 0,5	S	1000	2,65 Ms
2,7 x 6 x 0,5	K	100	8,30 Ms
2,8 x 7 x 0,5	S	1000	2,65 Ms
3,2 x 7 x 0,5	S	1000	1,85 Ms
3,2 x 7 x 0,5	K	100	7,50 Ms
3,7 x 8 x 0,5	K	100	9,10 Ms
4,3 x 9 x 0,8	S	1000	3,45 Ms
4,3 x 9 x 0,8	K	100	9,10 Ms
5,3 x 10 x 1	S	1000	4,15 Ms
5,3 x 10 x 1	K	100	9,60 Ms
6,4 x 12 x 1,6	S	1000	8,90 Ms
6,4 x 12 x 1,6	K	100	14,40 Ms
8,4 x 16 x 1,6	S	1000	17,00 Ms
8,4 x 16 x 1,6	K	100	25,00 Ms
10,5 x 20 x 2	S	500	41,50 Ms
10,5 x 20 x 2	K	100	54,00 Ms
13 x 24 x 2,5	S	500	47,50 Ms
13 x 24 x 2,5	K	100	56,00 Ms
15 x 28 x 2,5	S	250	66,00 Ms
15 x 28 x 2,5	K	100	76,00 Ms
17 x 30 x 3	S	250	85,00 Ms
17 x 30 x 3	K	100	93,00 Ms
19 x 34 x 3	S	50	136,00 Ms
21 x 37 x 3	S	50	141,00 Ms
23 x 39 x 3	S	25	290,00 Ms
25 x 44 x 4	S	25	390,00 Ms
28 x 50 x 4	S	25	465,00 Ms
31 x 56 x 4	S	25	580,00 Ms
33 x 60 x 5	S	25	830,00 Ms
37 x 66 x 5	S	1	1330,00 Ms
40 x 72 x 6	S	1	2050,00 Ms
43 x 78 x 7	S	1	2750,00 Ms
46 x 85 x 7	S	1	3600,00 Ms
50 x 92 x 8	S	1	3700,00 Ms

Abmessungen	VE	Stück	€/100/Obf.
DIN 00125.731			
125-1 Messing Form A			
galvanisch vernickelt			



Scheiben, A = ohne Fase

Maße → TI-84 Normumstellung → TI-84
 Werkstoffeigensch. → TI-239 REACH → TI-262

Stahl → S. 70
 Rostfrei → S. 461

DIN 125-1 Form A → wird ersetzt durch ISO 7089



Innen Ø x Außen Ø x Dicke

3,2 x 7 x 0,5	S	1000	2,75 Ms Ni
4,3 x 9 x 0,8	S	1000	5,40 Ms Ni
5,3 x 10 x 1	S	1000	6,40 Ms Ni
6,4 x 12 x 1,6	S	1000	14,10 Ms Ni
8,4 x 16 x 1,6	S	1000	27,00 Ms Ni

Abmessungen	VE	Stück	€/100/Obf.
DIN 00125.704			
125-1 Messing Form B			
gedreht			

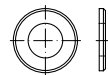

Scheiben, B = mit Fase

Maße → TI-84 Normumstellung → TI-84
 Werkstoffeigensch. → TI-239 REACH → TI-262

Stahl → S. 72
 Rostfrei → S. 461

DIN 125-1 Form B → wird ersetzt durch ISO 7090



Innen Ø x Außen Ø x Dicke

1,1 x 3 x 0,3	S	100	46,50 Ms gedr
1,3 x 3,5 x 0,3	S	100	46,50 Ms gedr
1,5 x 4 x 0,3	S	100	46,50 Ms gedr
1,7 x 4 x 0,3	S	100	45,00 Ms gedr
2,2 x 5 x 0,3	S	100	45,00 Ms gedr
2,7 x 6 x 0,5	S	100	45,00 Ms gedr
3,2 x 7 x 0,5	S	100	48,00 Ms gedr
4,3 x 9 x 0,8	S	100	58,00 Ms gedr
5,3 x 10 x 1	S	100	63,00 Ms gedr
6,4 x 12 x 1,6	S	100	84,00 Ms gedr
8,4 x 16 x 1,6	S	100	103,00 Ms gedr
10,5 x 20 x 2	S	100	120,00 Ms gedr

Abmessungen	VE Stück	€/100/Obf.
DIN	00125.300	
125-1	Kupfer	Form A

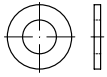

**Scheiben,
A = ohne Fase**

Maße → **TI-84** Normumstellung → **TI-84**
 Werkstoffeigensch. → **TI-239**

Stahl → **S. 70**
 Rostfrei → **S. 461**

DIN 125-1 Form A → wird ersetzt durch ISO 7089



Innen Ø x Außen Ø x Dicke

5,3	x	10	x	1	S	100	38,50 Cu
6,4	x	12	x	1,6	S	100	61,00 Cu
8,4	x	16	x	1,6	S	100	91,00 Cu
10,5	x	20	x	2	S	100	152,00 Cu
13	x	24	x	2,5	S	100	223,00 Cu
17	x	30	x	3	S	100	405,00 Cu

DIN	00125.301
125-1	Aluminium Form A

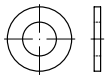

**Scheiben,
A = ohne Fase**

Maße → **TI-84** Normumstellung → **TI-84**
 Werkstoffeigensch. → **TI-239** REACH → **TI-262**

Stahl → **S. 70**
 Rostfrei → **S. 461**

DIN 125-1 Form A → wird ersetzt durch ISO 7089



Innen Ø x Außen Ø x Dicke

3,2	x	7	x	0,5	K	500	2,90 Al
4,3	x	9	x	0,8	S	1000	3,00 Al
4,3	x	9	x	0,8	K	100	5,30 Al
5,3	x	10	x	1	S	1000	3,35 Al
5,3	x	10	x	1	K	100	4,70 Al
6,4	x	12	x	1,6	S	1000	5,20 Al
6,4	x	12	x	1,6	K	100	6,70 Al
8,4	x	16	x	1,6	S	500	6,50 Al
8,4	x	16	x	1,6	K	100	7,90 Al
10,5	x	20	x	2	S	500	10,30 Al
10,5	x	20	x	2	K	100	12,20 Al
13	x	24	x	2,5	S	100	19,90 Al
17	x	30	x	3	S	50	44,50 Al

Abmessungen	VE Stück	€/100/Obf.
DIN	00125.601	
125-1	Kunststoff PA	Form A

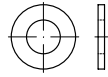

**Scheiben,
A = ohne Fase**

Produktklasse C nach ISO 4759-3

Maße → **TI-84** REACH → **TI-262**
 Werkstoffeigensch. → **TI-239**

Stahl → **S. 70**
 Rostfrei → **S. 461**

Weitgehend identisch mit DIN 34815

Innen Ø x Außen Ø x Dicke

2,2	x	5	x	0,3	S	1000	7,50 Kunstst
2,7	x	6	x	0,5	S	1000	6,10 Kunstst
3,2	x	7	x	0,5	S	1000	2,55 Kunstst
3,2	x	7	x	0,5	K	200	4,20 Kunstst
4,3	x	9	x	0,8	S	1000	2,55 Kunstst
4,3	x	9	x	0,8	K	200	4,20 Kunstst
5,3	x	10	x	1	S	1000	3,25 Kunstst
5,3	x	10	x	1	K	200	5,00 Kunstst
6,4	x	12	x	1,6	S	1000	4,00 Kunstst
6,4	x	12	x	1,6	K	200	5,80 Kunstst
8,4	x	16	x	1,6	S	1000	5,30 Kunstst
8,4	x	16	x	1,6	K	200	7,30 Kunstst
10,5	x	20	x	2	S	500	8,20 Kunstst
10,5	x	20	x	2	K	200	10,60 Kunstst
13	x	24	x	2,5	S	500	11,50 Kunstst
13	x	24	x	2,5	K	100	13,40 Kunstst
15	x	28	x	2,5	S	100	14,90 Kunstst
17	x	30	x	3	S	250	15,20 Kunstst
17	x	30	x	3	K	100	17,20 Kunstst
21	x	37	x	3	S	100	24,00 Kunstst
23	x	39	x	3	S	100	60,00 Kunstst
25	x	44	x	4	S	100	65,00 Kunstst
28	x	50	x	4	S	50	114,00 Kunstst
31	x	56	x	4	S	50	130,00 Kunstst
34	x	60	x	5	S	50	150,00 Kunstst

DIN	00127.702
127	Bronze Form B



**Federringe,
B = glatt**

Achtung! Reduzierte Federkräfte.

Maße → **TI-88** REACH → **TI-262**
 Werkstoffeigensch. → **TI-239**

Federstahl → **S. 74**
 Rostfrei → **S. 462**



B 3	S	1000	5,50 Bronze
B 4	S	1000	7,10 Bronze
B 5	S	1000	10,10 Bronze
B 6	S	1000	16,50 Bronze

Abmessungen	VE Stück	€/100/Obf.	
B 8	S	500	41,00 Bronze
B 10	S	500	44,00 Bronze
B 12	S	500	67,00 Bronze

DIN	00315.700
315	Messing



**Flügelmuttern, runde Flügelform,
Produktklasse C (g)**

Maße → **TI-72** REACH → **TI-262**
 Werkstoffeigensch. → **TI-239**

Temperguss → **S. 77**
 Rostfrei → **S. 464**



M 3	S	100	44,00 Ms
M 4	S	100	44,00 Ms
M 5	S	100	55,00 Ms
M 6	S	100	83,00 Ms
M 8	S	100	144,00 Ms
M 10	S	100	239,00 Ms
M 12	S	50	425,00 Ms
M 16	S	10	730,00 Ms
M 20	S	1	1750,00 Ms

DIN	00315.730
315	Messing galvanisch vernickelt



**Flügelmuttern, runde Flügelform,
Produktklasse C (g)**

Maße → **TI-72** REACH → **TI-262**
 Werkstoffeigensch. → **TI-239**

Temperguss → **S. 77**
 Rostfrei → **S. 464**



M 6	S	100	95,00 gal Ni
M 8	S	100	167,00 gal Ni
M 10	S	100	290,00 gal Ni

Abmessungen	VE Stück	€/100/Obf.
DIN	00316.700	
316	Messing	

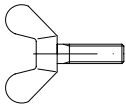

Flügel schrauben, runde Flügel form, Produktklasse C (g)

Maße → **TI-29** REACH → **TI-262**
 Werkstoffeigensch. → **TI-239**
 Temporguss → **S. 78**
 Rostfrei → **S. 464**



M 4	x	10	S	100	99,00 Ms
M 4	x	12	S	100	103,00 Ms
M 4	x	16	S	100	113,00 Ms
M 4	x	20	S	100	121,00 Ms
M 5	x	10	S	100	109,00 Ms
M 5	x	16	S	100	125,00 Ms
M 5	x	20	S	100	152,00 Ms
M 5	x	25	S	100	160,00 Ms
M 5	x	30	S	100	173,00 Ms
M 6	x	10	S	100	167,00 Ms
M 6	x	12	S	100	175,00 Ms
M 6	x	16	S	100	189,00 Ms
M 6	x	20	S	100	210,00 Ms
M 6	x	25	S	100	220,00 Ms
M 6	x	30	S	100	244,00 Ms
M 6	x	40	S	100	285,00 Ms
M 8	x	10	S	50	255,00 Ms
M 8	x	12	S	50	270,00 Ms
M 8	x	16	S	50	275,00 Ms
M 8	x	20	S	50	310,00 Ms
M 8	x	25	S	50	335,00 Ms
M 8	x	30	S	50	350,00 Ms
M 8	x	40	S	50	415,00 Ms
M 8	x	50	S	50	480,00 Ms
M 10	x	16	S	25	500,00 Ms
M 10	x	20	S	25	530,00 Ms
M 10	x	25	S	25	550,00 Ms
M 10	x	30	S	25	560,00 Ms
M 10	x	35	S	25	590,00 Ms
M 10	x	40	S	25	620,00 Ms
M 10	x	50	S	25	720,00 Ms
M 12	x	30	S	10	990,00 Ms
M 12	x	40	S	10	1050,00 Ms
M 12	x	50	S	10	1100,00 Ms

Abmessungen	VE Stück	€/100/Obf.
DIN	00319.633	
319	Kunststoff schwarz	Form C



Kugelköpfe, C = mit Innengewinde (ohne Buchseneinsatz)

Maße → **TI-125** REACH → **TI-262**

Kugel Ø – Innengewinde

16	M 4	S	25	77,00 Kunstst
20	M 5	S	25	83,00 Kunstst
25	M 6	S	25	97,00 Kunstst
32	M 8	S	10	142,00 Kunstst
40	M 10	S	10	226,00 Kunstst
50	M 12	S	10	385,00 Kunstst

DIN	00319.644
319	Kunststoff schwarz Form E-St



Kugelköpfe, E = mit Gewindebuchse Stahl verzinkt

Maße → **TI-125** REACH → **TI-262**

Kugel Ø – Innengewinde

20	M 5	S	25	122,00 Kunstst
25	M 6	S	25	154,00 Kunstst
32	M 8	S	10	260,00 Kunstst
40	M 10	S	10	360,00 Kunstst
50	M 12	S	10	590,00 Kunstst

DIN	00319.634
319	Kunststoff schwarz Form E-Ms



Kugelköpfe, E = mit Gewindebuchse Messing

Maße → **TI-125** REACH → **TI-262**

Kugel Ø – Innengewinde

16	M 4	S	25	120,00 Kunstst
20	M 5	S	25	139,00 Kunstst
25	M 6	S	25	164,00 Kunstst
32	M 8	S	10	290,00 Kunstst
40	M 10	S	10	385,00 Kunstst
50	M 12	S	10	650,00 Kunstst

Abmessungen	VE Stück	€/100/Obf.
DIN	00431.702	
431	Messing	Form B

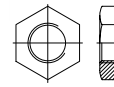

Rohrmuttern mit zölligem Rohrgewinde G, B = einseitige Gewindeansenkung

Maße → **TI-60** REACH → **TI-262**
 Werkstoffeigensch. → **TI-239**

Stahl → **S. 80**
 Rostfrei → **S. 465**

Muttern mit ISO-Schlüsselweiten auf Anfrage



Form/Gewinde – (Schlüsselweite)

BG 1/4 SW22	S	50	236,00 Ms
BG 3/8	S	50	290,00 Ms
BG 1/2 SW32	S	50	425,00 Ms
BG 3/4	S	25	680,00 Ms
BG 1	S	10	1160,00 Ms
BG 1 1/4	S	10	1890,00 Ms
BG 1 1/2	S	10	2500,00 Ms

DIN	00433.700
433-1	Messing

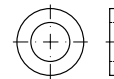

Scheiben

vorzugsweise für Zylinderschrauben

Maße → **TI-84** Normumstellung → **TI-84**
 Werkstoffeigensch. → **TI-239** REACH → **TI-262**

Stahl → **S. 80**
 Rostfrei → **S. 466**

DIN 433 → wird ersetzt durch ISO 7092



Innen Ø x Außen Ø x Dicke

2,2	x	4,5	x	0,3	S	5000	1,15 Ms
2,2	x	4,5	x	0,3	K	500	1,95 Ms
2,7	x	5	x	0,5	S	5000	1,40 Ms
2,7	x	5	x	0,5	K	500	2,35 Ms
3,2	x	6	x	0,5	S	5000	1,15 Ms
3,2	x	6	x	0,5	K	500	1,80 Ms
4,3	x	8	x	0,5	S	5000	1,45 Ms
4,3	x	8	x	0,5	K	500	2,30 Ms
5,3	x	9	x	1	S	1000	4,15 Ms
5,3	x	9	x	1	K	100	8,40 Ms
6,4	x	11	x	1,6	S	1000	7,20 Ms
6,4	x	11	x	1,6	K	100	11,60 Ms
8,4	x	15	x	1,6	S	1000	13,80 Ms
8,4	x	15	x	1,6	K	100	20,20 Ms
10,5	x	18	x	1,6	S	1000	18,10 Ms
10,5	x	18	x	1,6	K	100	27,50 Ms
13	x	20	x	2	S	500	30,50 Ms
13	x	20	x	2	K	100	37,00 Ms

Abmessungen	VE	Stück	€/100/Obf.
15 x 24 x 2,5 S	100	55,00 Ms	
17 x 28 x 2,5 S	100	64,00 Ms	
21 x 34 x 3 S	50	194,00 Ms	

DIN	00439.702
439	Messing Form B

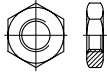

Sechskantmuttern, niedrige Form, B = mit Fasen

Maße → **TI-61** Normumstellung → **TI-7**
 Werkstoffeigensch. → **TI-239** REACH → **TI-262**

Stahl → **S. 82**
 Rostfrei → **S. 467**

DIN 439 → wird ersetzt durch ISO 4035



BM 2	S 1000	3,85 Ms
BM 2	K 100	7,90 Ms
BM 2,5	K 100	7,70 Ms
BM 3	S 1000	3,75 Ms
BM 3	K 100	7,70 Ms
BM 4	S 1000	4,65 Ms
BM 4	K 100	8,70 Ms
BM 5	S 1000	6,00 Ms
BM 5	K 100	10,10 Ms
BM 6	S 1000	8,70 Ms
BM 6	K 100	14,60 Ms
BM 8	S 500	18,60 Ms
BM 8	K 100	23,90 Ms
BM 10	S 500	31,50 Ms
BM 10	K 100	40,50 Ms
BM 12	S 100	75,00 Ms
BM 16	S 50	160,00 Ms
BM 20	S 50	295,00 Ms

DIN	00439.732
439	Messing Form B galvanisch vernickelt

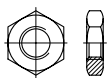

Sechskantmuttern, niedrige Form, B = mit Fasen

Maße → **TI-61** Normumstellung → **TI-7**
 Werkstoffeigensch. → **TI-239** REACH → **TI-262**

Stahl → **S. 82**
 Rostfrei → **S. 467**

DIN 439 → wird ersetzt durch ISO 4035



BM 3	S 100	10,70 gal Ni
BM 4	S 100	16,00 gal Ni
BM 5	S 100	19,90 gal Ni
BM 6	S 100	27,00 gal Ni
BM 8	S 100	40,00 gal Ni
BM 10	S 100	61,00 gal Ni

Abmessungen	VE	Stück	€/100/Obf.
BM 12	S	100	112,00 gal Ni
BM 16	S	50	226,00 gal Ni
BM 20	S	50	400,00 gal Ni

DIN	00444.702
444	Messing Form B

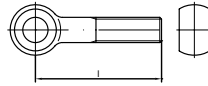

Augenschrauben, B = Produktklasse B (mg)

Maße → **TI-30** REACH → **TI-262**
 Werkstoffeigensch. → **TI-239**

Stahl → **S. 85**
 Rostfrei → **S. 468**



Gewinde M x Länge l

BM 6	x	40	S	25	410,00 Ms
BM 6	x	50	S	25	430,00 Ms
BM 6	x	60	S	25	460,00 Ms
BM 8	x	40	S	25	530,00 Ms
BM 8	x	50	S	25	560,00 Ms
BM 8	x	60	S	25	600,00 Ms
BM 8	x	70	S	25	640,00 Ms
BM 8	x	80	S	25	710,00 Ms
BM 10	x	50	S	10	720,00 Ms
BM 10	x	60	S	10	770,00 Ms
BM 10	x	70	S	10	840,00 Ms
BM 10	x	80	S	10	910,00 Ms
BM 10	x	90	S	10	960,00 Ms
BM 10	x	100	S	10	1030,00 Ms
BM 12	x	60	S	10	960,00 Ms
BM 12	x	70	S	10	1010,00 Ms
BM 12	x	80	S	10	1120,00 Ms
BM 12	x	90	S	10	1170,00 Ms
BM 12	x	100	S	10	1300,00 Ms
BM 16	x	70	S	10	1750,00 Ms
BM 16	x	80	S	10	1860,00 Ms
BM 16	x	90	S	10	1970,00 Ms
BM 16	x	100	S	1	2050,00 Ms
BM 16	x	110	S	1	2200,00 Ms
BM 16	x	120	S	1	2310,00 Ms
BM 16	x	130	S	1	2500,00 Ms
BM 16	x	140	S	1	2750,00 Ms
BM 20	x	80	S	1	3050,00 Ms
BM 20	x	90	S	1	3150,00 Ms
BM 20	x	100	S	1	3350,00 Ms
BM 20	x	110	S	1	3550,00 Ms
BM 20	x	120	S	1	3950,00 Ms
BM 20	x	130	S	1	4100,00 Ms
BM 20	x	140	S	1	4250,00 Ms

Abmessungen	VE	Stück	€/100/Obf.
~DIN	00463.700		

463 Messing

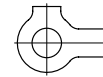

Scheiben mit 2 Lappen

Maße → **TI-91** REACH → **TI-262**
 Werkstoffeigensch. → **TI-239**

Stahl → **S. 87**
 Rostfrei → **S. 469**



13	S	50	370,00 Ms
17	S	50	750,00 Ms
21	S	25	950,00 Ms
23	S	25	1180,00 Ms
25	S	25	1220,00 Ms

DIN	00464.700
464	Messing

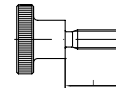

Rändelschrauben, hohe Form

Maße → **TI-30** REACH → **TI-262**
 Werkstoffeigensch. → **TI-239**

Stahl → **S. 87**
 Rostfrei → **S. 469**



Gewinde M x Länge l

M 3	x	6	S	50	152,00 Ms
M 3	x	8	S	50	152,00 Ms
M 3	x	10	S	50	162,00 Ms
M 3	x	12	S	50	178,00 Ms
M 3	x	16	S	50	199,00 Ms
M 4	x	8	S	50	199,00 Ms
M 4	x	10	S	50	202,00 Ms
M 4	x	12	S	25	215,00 Ms
M 4	x	16	S	25	226,00 Ms
M 4	x	20	S	25	247,00 Ms
M 4	x	25	S	25	280,00 Ms
M 5	x	8	S	50	315,00 Ms
M 5	x	10	S	50	315,00 Ms
M 5	x	12	S	25	325,00 Ms
M 5	x	16	S	25	345,00 Ms
M 5	x	20	S	25	375,00 Ms
M 5	x	25	S	25	420,00 Ms
M 5	x	30	S	25	475,00 Ms
M 6	x	8	S	25	480,00 Ms
M 6	x	10	S	25	480,00 Ms
M 6	x	12	S	25	500,00 Ms
M 6	x	16	S	25	530,00 Ms
M 6	x	20	S	25	600,00 Ms
M 6	x	25	S	25	650,00 Ms
M 6	x	30	S	25	760,00 Ms
M 8	x	30	S	10	1040,00 Ms

Abmessungen	VE Stück	€/100/Obf.
DIN	00466.700	
466 Messing		



Rändelmuttern, hohe Form

Maße → [TI-72](#) REACH → [TI-262](#)
 Werkstoffeigensch. → [TI-239](#)
 Stahl → [S. 88](#)
 Rostfrei → [S. 469](#)



M 3	S 100	62,00 Ms
M 4	S 100	97,00 Ms
M 5	S 50	160,00 Ms
M 6	S 50	275,00 Ms
M 8	S 25	495,00 Ms
M 10	S 10	800,00 Ms

DIN	00467.700
467 Messing	



Rändelmuttern, niedrige Form

Maße → [TI-72](#) REACH → [TI-262](#)
 Werkstoffeigensch. → [TI-239](#)
 Stahl → [S. 88](#)
 Rostfrei → [S. 469](#)



M 3	S 100	48,50 Ms
M 4	S 100	72,00 Ms
M 5	S 50	101,00 Ms
M 6	S 50	173,00 Ms
M 8	S 25	365,00 Ms
M 10	S 10	560,00 Ms



- ✓ Große Artikelvielfalt
- ✓ Verlässliche Qualität
- ✓ Hohe Lieferbereitschaft

Abmessungen	VE Stück	€/100/Obf.
DIN	00546.700	
546 Messing		

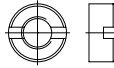

Schlitzmuttern

Maße → [TI-72](#) REACH → [TI-262](#)
 Werkstoffeigensch. → [TI-239](#)
 Stahl → [S. 92](#)
 Rostfrei → [S. 470](#)



M 3	S 100	24,20 Ms
M 4	S 100	32,00 Ms
M 5	S 100	45,00 Ms

DIN	00551.700
551 Messing	



Gewindestifte mit Kegelhülse, mit Schlitz

Maße → [TI-19](#) Normumstellung → [TI-6](#)
 Werkstoffeigensch. → [TI-239](#) REACH → [TI-262](#)
 Stahl → [S. 93](#)
 Rostfrei → [S. 470](#)

DIN 551 → wird ersetzt durch ISO 4766 (austauschbar)



M 3	x 3	S 100	13,60 Ms
M 3	x 4	S 100	13,60 Ms
M 3	x 5	S 100	13,80 Ms
M 3	x 6	S 100	14,40 Ms
M 3	x 8	S 100	14,90 Ms
M 3	x 10	S 100	15,20 Ms
M 3	x 12	S 100	16,00 Ms
M 3	x 16	S 100	17,00 Ms
M 4	x 4	S 100	13,80 Ms
M 4	x 5	S 100	14,10 Ms
M 4	x 6	S 100	14,40 Ms
M 4	x 8	S 100	14,60 Ms
M 4	x 10	S 100	16,20 Ms
M 4	x 12	S 100	17,00 Ms
M 4	x 16	S 100	17,80 Ms
M 5	x 5	S 100	14,60 Ms
M 5	x 6	S 100	15,70 Ms
M 5	x 8	S 100	16,00 Ms
M 5	x 10	S 100	17,00 Ms
M 5	x 12	S 100	18,30 Ms
M 5	x 16	S 100	20,50 Ms
M 6	x 6	S 100	16,50 Ms
M 6	x 8	S 100	18,30 Ms
M 6	x 10	S 100	18,90 Ms
M 6	x 12	S 100	21,80 Ms
M 6	x 16	S 100	23,40 Ms
M 6	x 20	S 100	28,50 Ms

Abmessungen	VE Stück	€/100/Obf.
M 6 x 25	S 100	31,00 Ms
M 6 x 30	S 100	40,00 Ms
M 8 x 10	S 100	54,00 Ms
M 8 x 12	S 100	61,00 Ms
M 8 x 16	S 100	67,00 Ms
M 8 x 20	S 100	72,00 Ms
M 8 x 25	S 100	77,00 Ms
M 8 x 35	S 100	77,00 Ms
M 8 x 40	S 100	84,00 Ms
M 8 x 45	S 100	88,00 Ms
M 8 x 50	S 100	88,00 Ms
M 10 x 8	S 100	146,00 Ms
M 10 x 12	S 100	149,00 Ms
M 10 x 16	S 100	112,00 Ms
M 10 x 20	S 100	154,00 Ms

DIN	00551.600
551 Kunststoff PA	

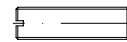

Gewindestifte mit Kegelhülse, mit Schlitz

Maße → [TI-19](#) REACH → [TI-262](#)
 Werkstoffeigensch. → [TI-239](#)
 Stahl → [S. 93](#)
 Rostfrei → [S. 470](#)

M 4	x 6	S 100	22,00 Kunstst
M 4	x 8	S 100	23,00 Kunstst
M 4	x 10	S 100	23,00 Kunstst
M 4	x 12	S 100	24,00 Kunstst
M 4	x 16	S 100	26,00 Kunstst
M 4	x 20	S 100	28,00 Kunstst
M 4	x 25	S 100	30,00 Kunstst
M 5	x 6	S 100	24,00 Kunstst
M 5	x 8	S 100	25,00 Kunstst
M 5	x 10	S 100	26,00 Kunstst
M 5	x 12	S 100	28,00 Kunstst
M 5	x 16	S 100	30,00 Kunstst
M 6	x 6	S 100	5,70 Kunstst
M 6	x 8	S 100	27,00 Kunstst
M 6	x 10	S 100	28,00 Kunstst
M 6	x 12	S 100	29,00 Kunstst
M 6	x 16	S 100	30,00 Kunstst
M 6	x 20	S 100	32,00 Kunstst
M 6	x 25	S 100	34,00 Kunstst
M 8	x 8	S 100	30,00 Kunstst
M 8	x 10	S 100	32,00 Kunstst
M 8	x 12	S 100	35,00 Kunstst
M 8	x 16	S 100	38,00 Kunstst
M 10	x 16	S 100	40,00 Kunstst
M 10	x 20	S 100	45,00 Kunstst
M 10	x 30	S 100	50,00 Kunstst
M 10	x 40	S 100	55,00 Kunstst

Abmessungen	VE Stück	€/100/Obf.
DIN	00553.700	
553	Messing	



Gewindestifte mit Spitze, mit Schlitz

Maße → **TI-19** Normumstellung → **TI-6**
 Werkstoffeigensch. → **TI-239** REACH → **TI-262**

Stahl → **S. 94**
 Rostfrei → **S. 471**

DIN 553 → wird ersetzt durch ISO 7434 (austauschbar)



M 3	x	4	S	100	13,60 Ms
M 3	x	5	S	100	13,80 Ms
M 3	x	6	S	100	14,40 Ms
M 4	x	4	S	100	13,80 Ms
M 4	x	5	S	100	14,10 Ms
M 4	x	6	S	100	14,40 Ms
M 4	x	8	S	100	14,60 Ms
M 5	x	5	S	100	14,60 Ms
M 5	x	6	S	100	15,70 Ms
M 5	x	8	S	100	16,00 Ms
M 5	x	10	S	100	17,00 Ms
M 5	x	12	S	100	18,30 Ms
M 5	x	16	S	100	20,50 Ms
M 6	x	6	S	100	16,50 Ms
M 6	x	8	S	100	18,30 Ms
M 6	x	10	S	100	18,90 Ms
M 6	x	20	S	100	28,50 Ms

DIN	00555.600
555	Kunststoff PA

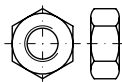

Sechskantmuttern

DIN-Schlüsselweiten

Achtung! Grobe Toleranzen nach VDI 2544

Maße → **(TI-62 ~ ISO 4032)** REACH → **TI-262**
 Werkstoffeigensch. → **TI-239**

Weitgehend identisch mit DIN 34814

M 3	S	1000	6,50 Kunstst
M 3	K	200	8,20 Kunstst
M 4	S	1000	7,10 Kunstst
M 4	K	200	8,90 Kunstst
M 5	S	1000	8,10 Kunstst
M 5	K	200	10,10 Kunstst
M 6	S	1000	8,70 Kunstst
M 6	K	100	10,80 Kunstst
M 8	S	100	13,50 Kunstst
M 10	S	100	23,60 Kunstst
M 12	S	100	28,50 Kunstst
M 16	S	100	50,00 Kunstst
M 20	S	100	85,00 Kunstst

Abmessungen	VE Stück	€/100/Obf.
DIN	00603.704	
603	Messing	

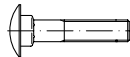

Flachrundschrauben mit Vierkantsatz

Muttern → DIN 934/ISO 4032-4034

Maße → **TI-32** REACH → **TI-262**
 Werkstoffeigensch. → **TI-239**

Stahl → **S. 103**
 Rostfrei → **S. 473**



M 5	x	16	S	100	78,00 Ms
M 5	x	20	S	100	53,00 Ms
M 5	x	25	S	100	110,00 Ms
M 5	x	30	S	100	62,00 Ms
M 5	x	35	S	100	71,00 Ms
M 5	x	40	S	100	75,00 Ms
M 5	x	45	S	100	82,00 Ms
M 5	x	50	S	100	85,00 Ms
M 5	x	60	S	100	116,00 Ms
M 5	x	70	S	100	144,00 Ms
M 6	x	16	S	100	71,00 Ms
M 6	x	20	S	100	80,00 Ms
M 6	x	25	S	100	84,00 Ms
M 6	x	30	S	100	92,00 Ms
M 6	x	35	S	100	110,00 Ms
M 6	x	40	S	100	121,00 Ms
M 6	x	45	S	100	130,00 Ms
M 6	x	50	S	100	125,00 Ms
M 6	x	60	S	100	154,00 Ms
M 6	x	65	S	100	210,00 Ms
M 6	x	70	S	100	191,00 Ms
M 6	x	80	S	100	202,00 Ms
M 8	x	25	S	50	186,00 Ms
M 8	x	30	S	50	178,00 Ms
M 8	x	40	S	50	236,00 Ms
M 8	x	45	S	50	295,00 Ms
M 8	x	50	S	50	270,00 Ms
M 8	x	55	S	50	345,00 Ms
M 8	x	60	S	50	315,00 Ms
M 8	x	70	S	50	385,00 Ms
M 8	x	80	S	50	415,00 Ms

Abmessungen	VE Stück	€/100/Obf.
DIN	00660.700	
660	Messing	

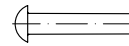

Halbrundniete

Maße → **TI-134** REACH → **TI-262**
 Werkstoffeigensch. → **TI-239**

Stahl → **S. 109**
 Rostfrei → **S. 474**
 Kupfer, Aluminium → **S. 621**



2	x	4	S	1000	4,55 Ms
2	x	6	S	1000	4,65 Ms
2	x	8	S	1000	4,95 Ms
2	x	10	S	1000	5,20 Ms
3	x	4	S	1000	6,50 Ms
3	x	5	S	1000	6,70 Ms
3	x	6	S	1000	6,90 Ms
3	x	8	S	1000	7,90 Ms
3	x	10	S	1000	9,10 Ms
3	x	12	S	1000	9,90 Ms
3	x	20	S	1000	14,40 Ms
3	x	25	S	1000	17,80 Ms
4	x	6	S	1000	11,60 Ms
4	x	8	S	1000	12,60 Ms
4	x	10	S	1000	14,90 Ms
4	x	12	S	1000	16,70 Ms
4	x	16	S	1000	19,90 Ms
4	x	20	S	1000	24,20 Ms
4	x	25	S	500	29,50 Ms
4	x	30	S	500	36,50 Ms
5	x	8	S	1000	22,30 Ms
5	x	12	S	1000	27,00 Ms
5	x	16	S	1000	32,00 Ms
5	x	20	S	500	39,00 Ms
6	x	10	S	500	38,00 Ms
6	x	30	S	250	80,00 Ms

DIN	00660.300
660	Kupfer

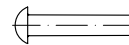

Halbrundniete

Maße → **TI-134** Werkstoffeigensch. → **TI-239**

Stahl → **S. 109**
 Rostfrei → **S. 474**
 Messing, Aluminium → **S. 621**



2	x	3	S	1000	4,55 Cu
2	x	4	S	1000	4,55 Cu
2	x	5	S	1000	4,55 Cu
2	x	6	S	1000	4,65 Cu
2	x	8	S	1000	4,95 Cu

Abmessungen	VE	Stück	€/100/Obf.
2 x 10	S	1000	5,20 Cu
2 x 12	S	1000	5,90 Cu
2 x 16	S	1000	7,10 Cu
2,5 x 5	S	1000	4,95 Cu
2,5 x 6	S	1000	5,20 Cu
2,5 x 8	S	1000	5,90 Cu
2,5 x 12	S	1000	7,70 Cu
2,5 x 16	S	1000	9,30 Cu
3 x 4	S	1000	6,50 Cu
3 x 5	S	1000	6,70 Cu
3 x 6	S	1000	6,90 Cu
3 x 8	S	1000	7,90 Cu
3 x 10	S	1000	9,10 Cu
3 x 12	S	1000	9,90 Cu
3 x 16	S	1000	11,80 Cu
3 x 20	S	1000	14,40 Cu
3 x 25	S	1000	17,80 Cu
3 x 30	S	1000	22,60 Cu
4 x 6	S	1000	11,60 Cu
4 x 8	S	1000	12,60 Cu
4 x 10	S	1000	14,90 Cu
4 x 12	S	1000	16,70 Cu
4 x 16	S	1000	19,90 Cu
4 x 20	S	1000	24,20 Cu
4 x 25	S	500	29,50 Cu
4 x 30	S	500	36,50 Cu
4 x 40	S	250	50,00 Cu
5 x 6	S	1000	22,30 Cu
5 x 8	S	1000	22,30 Cu
5 x 10	S	1000	24,20 Cu
5 x 12	S	1000	27,00 Cu
5 x 16	S	1000	32,00 Cu
5 x 20	S	500	39,00 Cu
5 x 25	S	500	46,50 Cu
5 x 30	S	500	54,00 Cu
5 x 40	S	250	72,00 Cu
6 x 10	S	500	38,00 Cu
6 x 12	S	500	41,00 Cu
6 x 16	S	500	48,00 Cu
6 x 18	S	500	60,00 Cu
6 x 20	S	500	60,00 Cu
6 x 25	S	250	69,00 Cu
6 x 30	S	250	80,00 Cu
6 x 40	S	250	100,00 Cu
6 x 45	S	250	110,00 Cu
6 x 50	S	250	121,00 Cu
8 x 12	S	250	83,00 Cu
8 x 16	S	250	93,00 Cu
8 x 20	S	250	108,00 Cu
8 x 25	S	250	125,00 Cu
8 x 30	S	250	144,00 Cu
8 x 40	S	100	178,00 Cu

Abmessungen	VE	Stück	€/100/Obf.
DIN	00660.301		
660	Aluminium 99.5		

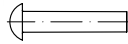

Halbrundniete

Maße → **TI-134** REACH → **TI-262**
 Werkstoffeigensch. → **TI-239**
 Stahl → **S. 109**
 Rostfrei → **S. 474**
 Messing, Kupfer → **S. 621**
 Ø ≤ 9 = DIN 660
 Ø 10 = DIN 124



1 x 4	S	1000	4,50 Al
2 x 3	S	1000	1,80 Al
2 x 4	S	1000	1,80 Al
2 x 5	S	1000	1,80 Al
2 x 6	S	1000	1,85 Al
2 x 8	S	1000	1,85 Al
2 x 10	S	1000	1,90 Al
2 x 12	S	1000	1,95 Al
2 x 16	S	1000	2,15 Al
2,5 x 3	S	1000	1,80 Al
2,5 x 4	S	1000	1,80 Al
2,5 x 5	S	1000	1,85 Al
2,5 x 6	S	1000	1,85 Al
2,5 x 8	S	1000	1,90 Al
2,5 x 10	S	1000	1,90 Al
2,5 x 16	S	1000	2,40 Al
3 x 4	S	1000	1,90 Al
3 x 5	S	1000	1,90 Al
3 x 6	S	1000	1,90 Al
3 x 8	S	1000	2,00 Al
3 x 10	S	1000	2,20 Al
3 x 12	S	1000	2,30 Al
3 x 16	S	1000	2,75 Al
3 x 20	S	1000	3,50 Al
3 x 25	S	1000	4,30 Al
3 x 30	S	1000	5,10 Al
3 x 40	S	500	7,00 Al
4 x 6	S	1000	2,95 Al
4 x 8	S	1000	3,05 Al
4 x 10	S	1000	3,45 Al
4 x 12	S	1000	3,90 Al
4 x 16	S	1000	4,65 Al
4 x 18	S	1000	5,40 Al
4 x 20	S	1000	5,70 Al
4 x 25	S	500	7,10 Al
4 x 30	S	500	8,40 Al
4 x 35	S	500	9,70 Al
4 x 40	S	250	10,90 Al
4 x 50	S	250	13,80 Al
5 x 8	S	1000	5,00 Al
5 x 10	S	1000	5,10 Al
5 x 12	S	1000	5,70 Al
5 x 16	S	1000	6,70 Al
5 x 18	S	500	7,70 Al
5 x 20	S	500	8,30 Al
5 x 25	S	500	9,90 Al
5 x 30	S	500	11,20 Al
5 x 35	S	250	13,20 Al
5 x 40	S	250	14,60 Al
5 x 50	S	250	18,20 Al
5 x 60	S	100	21,70 Al

Abmessungen	VE	Stück	€/100/Obf.
6 x 10	S	500	8,00 Al
6 x 12	S	500	8,60 Al
6 x 16	S	500	9,60 Al
6 x 18	S	500	10,90 Al
6 x 20	S	500	11,60 Al
6 x 25	S	250	14,00 Al
6 x 30	S	250	15,80 Al
6 x 35	S	250	18,20 Al
6 x 40	S	250	20,20 Al
6 x 50	S	250	24,70 Al
6 x 60	S	100	29,50 Al
8 x 12	S	250	17,90 Al
8 x 16	S	250	18,70 Al
8 x 20	S	250	21,80 Al
8 x 25	S	250	25,50 Al
8 x 30	S	250	28,50 Al
8 x 35	S	100	32,00 Al
8 x 40	S	100	35,50 Al
8 x 50	S	100	42,50 Al
8 x 55	S	100	47,00 Al
10 x 20	S	100	34,00 Al
10 x 25	S	100	39,00 Al
10 x 30	S	100	44,00 Al

Abmessungen	VE	Stück	€/100/Obf.
DIN	00661.700		
661	Messing		

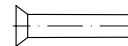

Senkniete

Maße → **TI-134** REACH → **TI-262**
 Werkstoffeigensch. → **TI-239**
 Stahl → **S. 109**
 Rostfrei → **S. 475**
 Kupfer, Aluminium → **S. 623**



3 x 6	S	1000	6,90 Ms
3 x 8	S	1000	7,90 Ms
3 x 10	S	1000	9,10 Ms
3 x 12	S	1000	9,90 Ms
4 x 10	S	1000	14,90 Ms
4 x 12	S	1000	16,70 Ms
4 x 16	S	1000	19,90 Ms
4 x 20	S	1000	24,20 Ms
4 x 30	S	500	36,50 Ms



- ✓ Große Artikelvielfalt
- ✓ Verlässliche Qualität
- ✓ Hohe Lieferbereitschaft

Abmessungen	VE Stück	€/100/Obf.
DIN 00661.300		
661	Kupfer	

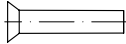

Senkniete

Maße → [TI-134](#) Werkstoffeigensch. → [TI-239](#)
 Stahl → [S. 109](#)
 Rostfrei → [S. 475](#)
 Messing, Aluminium → [S. 622](#)



2	x	4	S	1000	4,55 Cu
2	x	5	S	1000	4,55 Cu
2	x	6	S	1000	4,65 Cu
2	x	10	S	1000	5,20 Cu
2	x	12	S	1000	5,90 Cu
2	x	16	S	1000	7,10 Cu
2,5	x	6	S	1000	5,20 Cu
2,5	x	8	S	1000	5,90 Cu
2,5	x	10	S	1000	6,70 Cu
3	x	5	S	1000	6,70 Cu
3	x	6	S	1000	6,90 Cu
3	x	8	S	1000	7,90 Cu
3	x	10	S	1000	9,10 Cu
3	x	12	S	1000	9,90 Cu
3	x	16	S	1000	11,80 Cu
3	x	20	S	1000	14,40 Cu
3	x	25	S	1000	17,80 Cu
3	x	30	S	1000	22,60 Cu
3	x	40	S	500	31,50 Cu
4	x	6	S	1000	11,60 Cu
4	x	8	S	1000	12,60 Cu
4	x	10	S	1000	14,90 Cu
4	x	12	S	1000	16,70 Cu
4	x	16	S	1000	19,90 Cu
4	x	18	S	1000	24,20 Cu
4	x	20	S	1000	24,20 Cu
4	x	25	S	500	29,50 Cu
4	x	30	S	500	36,50 Cu
4	x	40	S	250	50,00 Cu
5	x	10	S	1000	24,20 Cu
5	x	12	S	1000	27,00 Cu
5	x	16	S	1000	32,00 Cu
5	x	20	S	500	39,00 Cu
5	x	25	S	500	46,50 Cu
5	x	30	S	500	54,00 Cu
5	x	35	S	250	61,00 Cu
5	x	40	S	250	72,00 Cu
5	x	50	S	250	91,00 Cu
6	x	10	S	500	38,00 Cu
6	x	12	S	500	41,00 Cu
6	x	16	S	500	48,00 Cu
6	x	18	S	500	60,00 Cu
6	x	20	S	500	60,00 Cu
6	x	25	S	250	69,00 Cu
6	x	30	S	250	80,00 Cu
6	x	35	S	250	89,00 Cu
6	x	40	S	250	100,00 Cu
6	x	45	S	250	110,00 Cu
6	x	50	S	250	121,00 Cu
8	x	12	S	250	83,00 Cu
8	x	16	S	250	93,00 Cu
8	x	20	S	250	108,00 Cu
8	x	25	S	250	125,00 Cu
8	x	30	S	250	144,00 Cu

Abmessungen	VE Stück	€/100/Obf.			
8	x	35	S	100	160,00 Cu
8	x	40	S	100	178,00 Cu
8	x	45	S	100	197,00 Cu
8	x	50	S	100	215,00 Cu
8	x	60	S	100	270,00 Cu

DIN	00661.301
661	Aluminium 99.5

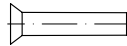

Senkniete

Maße → [TI-134](#) REACH → [TI-262](#)
 Werkstoffeigensch. → [TI-239](#)
 Stahl → [S. 109](#)
 Rostfrei → [S. 475](#)
 Messing, Kupfer → [S. 622](#)

Ø ≤ 9 = DIN 661
 Ø 10 = DIN 124



2	x	4	S	1000	1,80 Al
2	x	5	S	1000	1,80 Al
2	x	6	S	1000	1,85 Al
2	x	8	S	1000	1,85 Al
2	x	10	S	1000	1,90 Al
2	x	16	S	1000	2,15 Al
2,5	x	6	S	1000	1,85 Al
2,5	x	8	S	1000	1,90 Al
2,5	x	10	S	1000	1,90 Al
2,5	x	12	S	1000	2,00 Al
3	x	6	S	1000	1,90 Al
3	x	8	S	1000	2,00 Al
3	x	10	S	1000	2,20 Al
3	x	12	S	1000	2,30 Al
3	x	16	S	1000	2,75 Al
3	x	18	S	1000	3,15 Al
3	x	20	S	1000	3,50 Al
3	x	25	S	1000	4,30 Al
3	x	30	S	1000	5,10 Al
4	x	6	S	1000	2,95 Al
4	x	8	S	1000	3,05 Al
4	x	10	S	1000	3,45 Al
4	x	12	S	1000	3,90 Al
4	x	14	S	1000	4,35 Al
4	x	16	S	1000	4,65 Al
4	x	18	S	1000	5,40 Al
4	x	20	S	1000	5,70 Al
4	x	25	S	500	7,10 Al
4	x	30	S	500	8,40 Al
4	x	40	S	250	10,90 Al
5	x	8	S	1000	5,00 Al
5	x	10	S	1000	5,10 Al
5	x	12	S	1000	5,70 Al
5	x	16	S	1000	6,70 Al
5	x	20	S	500	8,30 Al
5	x	25	S	500	9,90 Al
5	x	30	S	500	11,20 Al
5	x	35	S	250	13,20 Al
5	x	40	S	250	14,60 Al
5	x	50	S	250	18,20 Al
6	x	10	S	500	8,00 Al
6	x	12	S	500	8,60 Al
6	x	16	S	500	9,60 Al
6	x	18	S	500	10,90 Al
6	x	20	S	500	11,60 Al

Abmessungen	VE Stück	€/100/Obf.			
6	x	25	S	250	14,00 Al
6	x	30	S	250	15,80 Al
6	x	35	S	250	18,20 Al
6	x	40	S	250	20,20 Al
6	x	50	S	250	24,70 Al
6	x	60	S	100	29,50 Al
8	x	16	S	250	18,70 Al
8	x	20	S	250	21,80 Al
8	x	25	S	250	25,50 Al
8	x	30	S	250	28,50 Al
8	x	35	S	100	32,00 Al
8	x	40	S	100	35,50 Al
8	x	45	S	100	39,00 Al
8	x	50	S	100	42,50 Al
8	x	60	S	100	51,00 Al

DIN	00662.700
662	Kupfer

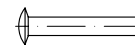

Linsenniete

Maße → [TI-134](#) Werkstoffeigensch. → [TI-239](#)
 Stahl → [S. 110](#)
 Aluminium → [S. 623](#)

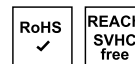

2	x	4	S	2000	4,55 Cu
2,5	x	5	S	1000	4,95 Cu
3	x	6	S	1000	6,90 Cu
3,5	x	8	S	1000	10,30 Cu
4	x	8	S	1000	12,60 Cu
5	x	12	S	500	27,00 Cu

DIN	00662.300
662	Aluminium 99.5

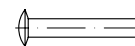

Linsenniete

Maße → [TI-134](#) REACH → [TI-262](#)
 Werkstoffeigensch. → [TI-239](#)
 Stahl → [S. 110](#)
 Kupfer → [S. 623](#)



3	x	6	S	1000	1,90 Al
3,5	x	8	S	1000	6,20 Al
4	x	8	S	1000	3,05 Al
5	x	12	S	500	5,70 Al
6	x	16	S	500	9,60 Al

Abmessungen	VE Stück	€/100/Obf.
DIN	00906.700	
906	Messing	keg.-Fein

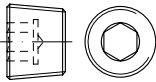

Verschlusschrauben mit Innensechskant, mit kegeligem Feingewinde

Maße → [TI-22](#) REACH → [TI-262](#)
 Werkstoffeigensch. → [TI-239](#)
 Stahl → [S. 112](#)
 Rostfrei → [S. 476](#)



M 10	x	1	S	100	93,00 Ms
M 12	x	1,5	S	50	138,00 Ms
M 14	x	1,5	S	50	146,00 Ms
M 16	x	1,5	S	25	181,00 Ms
M 20	x	1,5	S	25	315,00 Ms
M 22	x	1,5	S	25	330,00 Ms
M 24	x	1,5	S	25	490,00 Ms
M 30	x	1,5	S	10	610,00 Ms

DIN	00906.704
906	Messing keg.-Rohr R

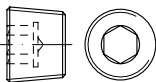

Verschlusschrauben mit Innensechskant, R = mit kegeligem Rohrgewinde

Maße → [TI-22](#) REACH → [TI-262](#)
 Werkstoffeigensch. → [TI-239](#)
 Stahl → [S. 112](#)
 Rostfrei → [S. 476](#)



R 1/8	S	100	103,00 Ms
R 1/4	S	100	129,00 Ms
R 3/8	S	50	191,00 Ms
R 1/2	S	50	295,00 Ms
R 3/4	S	25	930,00 Ms
R 1	S	10	1170,00 Ms

Abmessungen	VE Stück	€/100/Obf.
DIN	00908.704	
908	Messing	zyl.-Rohr G

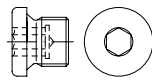

Verschlusschrauben mit Bund und Innensechskant, G = mit zylindrischem Rohrgewinde

Maße → [TI-22](#) REACH → [TI-262](#)
 Werkstoffeigensch. → [TI-239](#)
 Stahl → [S. 113](#)
 Rostfrei → [S. 476](#)



G 1/8 A	S	100	450,00 Ms
G 1/4 A	S	100	170,00 Ms
G 3/8 A	S	50	305,00 Ms
G 1/2 A	S	50	410,00 Ms
G 3/4 A	S	25	610,00 Ms

DIN	00910.700
910	Messing zyl.-Fein

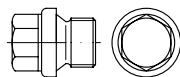

Verschlusschrauben mit Bund und Außensechskant, schwer, mit zylindrischem Feingewinde

Maße → [TI-23](#) REACH → [TI-262](#)
 Werkstoffeigensch. → [TI-239](#)
 Stahl → [S. 114](#)
 Rostfrei → [S. 476](#)



M 10	x	1	S	100	165,00 Ms
M 12	x	1,5	S	50	300,00 Ms
M 14	x	1,5	S	50	320,00 Ms
M 16	x	1,5	S	25	340,00 Ms
M 18	x	1,5	S	25	410,00 Ms
M 20	x	1,5	S	25	490,00 Ms
M 22	x	1,5	S	25	640,00 Ms
M 24	x	1,5	S	25	830,00 Ms
M 30	x	1,5	S	10	1210,00 Ms

Abmessungen	VE Stück	€/100/Obf.
DIN	00910.704	
910	Messing	zyl.-Rohr G

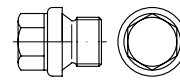

Verschlusschrauben mit Bund und Außensechskant, schwer, G = mit zylindrischem Rohrgewinde

Maße → [TI-23](#) REACH → [TI-262](#)
 Werkstoffeigensch. → [TI-239](#)
 Stahl → [S. 114](#)
 Rostfrei → [S. 477](#)



G 1/8 A	S	100	152,00 Ms
G 1/4 A	S	100	199,00 Ms
G 3/8 A	S	50	280,00 Ms
G 1/2 A	S	50	430,00 Ms
G 5/8 A	S	25	970,00 Ms
G 3/4 A	S	25	960,00 Ms
G 1 A	S	10	1260,00 Ms
G 1 1/4 A	S	1	2180,00 Ms
G 1 1/2 A	S	1	2650,00 Ms
G 2 A	S	1	5300,00 Ms

DIN	00917.700
917	Messing

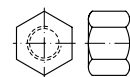

Sechskant-Hutmuttern, niedrige Form

ab M 12 mit Rille oder entsprechender Einschraubtiefe t min.

Maße → [TI-62](#) REACH → [TI-262](#)
 Werkstoffeigensch. → [TI-239](#)
 Stahl → [S. 141](#)
 Rostfrei → [S. 485](#)



M 4	S	1000	19,40 Ms
M 4	K	100	29,00 Ms
M 5	S	1000	24,40 Ms
M 5	K	100	34,00 Ms
M 6	S	1000	36,00 Ms
M 6	K	100	48,50 Ms
M 8	S	500	88,00 Ms
M 8	K	100	104,00 Ms
M 10 SW 17	S	100	132,00 Ms
M 12 SW 19	S	50	194,00 Ms
M 16	S	25	350,00 Ms
M 20	S	25	590,00 Ms

Abmessungen	VE Stück	€/100/Obf.
DIN	00931.700	
931	Messing	

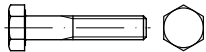

Sechskantschrauben mit Schaft

Maße → **TI-15** Normumstellung → **TI-6**
 Werkstoffeigensch. → **TI-239** REACH → **TI-262**
 Anziehmomente → **TI-250**

Stahl → **S. 143**
 Rostfrei → **S. 486**

DIN 931 → wird ersetzt durch ISO 4014



M 8	x	40	S	100	270,00 Ms
M 8	x	50	S	100	320,00 Ms
M 8	x	60	S	100	370,00 Ms
M 10	x	50	S	100	680,00 Ms
M 10	x	60	S	100	870,00 Ms
M 12	x	50	S	50	830,00 Ms
M 12	x	60	S	50	1050,00 Ms
M 12	x	70	S	50	1210,00 Ms

Abmessungen	VE Stück	€/100/Obf.
DIN	00933.700	
933	Messing	

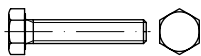

Sechskantschrauben mit Gewinde bis Kopf

Maße → **TI-15** Normumstellung → **TI-6**
 Werkstoffeigensch. → **TI-239** REACH → **TI-262**
 Anziehmomente → **TI-250**

Stahl → **S. 156**
 Rostfrei → **S. 490**

DIN 933 → wird ersetzt durch ISO 4017



M 4	x	6	S	100	25,50 Ms
M 4	x	8	S	100	12,80 Ms
M 4	x	10	S	100	12,80 Ms
M 4	x	12	S	100	14,10 Ms
M 4	x	16	S	100	15,20 Ms
M 4	x	20	S	100	16,70 Ms
M 4	x	25	S	100	19,10 Ms
M 4	x	30	S	100	21,80 Ms
M 4	x	35	S	100	24,40 Ms
M 4	x	40	S	100	27,00 Ms
M 4	x	50	S	100	42,50 Ms
M 4	x	60	S	100	48,00 Ms
M 5	x	8	S	100	17,50 Ms
M 5	x	10	S	100	17,50 Ms
M 5	x	12	S	100	19,40 Ms
M 5	x	16	S	100	21,00 Ms
M 5	x	20	S	100	23,90 Ms
M 5	x	25	S	100	27,50 Ms
M 5	x	30	S	100	30,00 Ms

M 5	x	35	S	100	33,50 Ms
M 5	x	40	S	100	34,50 Ms
M 5	x	45	S	100	47,50 Ms
M 5	x	50	S	100	43,00 Ms
M 5	x	60	S	100	56,00 Ms
M 6	x	8	S	100	27,00 Ms
M 6	x	10	S	100	27,00 Ms
M 6	x	12	S	100	27,50 Ms
M 6	x	16	S	100	30,00 Ms
M 6	x	20	S	100	33,00 Ms
M 6	x	25	S	100	37,00 Ms
M 6	x	30	S	100	41,00 Ms
M 6	x	35	S	100	45,00 Ms
M 6	x	40	S	100	49,50 Ms
M 6	x	45	S	100	59,00 Ms
M 6	x	50	S	100	59,00 Ms
M 6	x	60	S	100	76,00 Ms
M 8	x	10	S	100	59,00 Ms
M 8	x	12	S	100	61,00 Ms
M 8	x	16	S	100	65,00 Ms
M 8	x	20	S	100	71,00 Ms
M 8	x	25	S	100	80,00 Ms
M 8	x	30	S	100	88,00 Ms
M 8	x	35	S	100	95,00 Ms
M 8	x	40	S	100	103,00 Ms
M 8	x	45	S	100	118,00 Ms
M 8	x	50	S	100	118,00 Ms
M 8	x	55	S	100	130,00 Ms
M 8	x	60	S	100	130,00 Ms
M 8	x	65	S	100	157,00 Ms
M 8	x	70	S	100	157,00 Ms
M 8	x	80	S	100	173,00 Ms
M 8	x	90	S	100	191,00 Ms
M 10	x	10	S	100	395,00 Ms
M 10	x	12	S	100	132,00 Ms
M 10	x	16	S	100	120,00 Ms
M 10	x	20	S	100	113,00 Ms
M 10	x	25	S	100	141,00 Ms
M 10	x	30	S	100	149,00 Ms
M 10	x	35	S	100	162,00 Ms
M 10	x	40	S	100	173,00 Ms
M 10	x	45	S	100	197,00 Ms
M 10	x	50	S	100	197,00 Ms
M 10	x	60	S	100	220,00 Ms
M 10	x	65	S	100	255,00 Ms
M 10	x	70	S	100	255,00 Ms
M 10	x	80	S	100	295,00 Ms
M 10	x	100	S	50	400,00 Ms
M 12	x	16	S	50	183,00 Ms
M 12	x	20	S	50	194,00 Ms
M 12	x	25	S	50	215,00 Ms
M 12	x	30	S	50	223,00 Ms
M 12	x	35	S	50	247,00 Ms
M 12	x	40	S	50	260,00 Ms
M 12	x	45	S	50	280,00 Ms
M 12	x	50	S	50	280,00 Ms
M 12	x	55	S	50	295,00 Ms
M 12	x	60	S	50	290,00 Ms
M 12	x	70	S	50	340,00 Ms
M 12	x	80	S	50	455,00 Ms
M 12	x	90	S	50	460,00 Ms
M 12	x	100	S	50	530,00 Ms
M 16	x	20	S	50	660,00 Ms
M 16	x	25	S	50	720,00 Ms
M 16	x	30	S	50	790,00 Ms
M 16	x	35	S	50	870,00 Ms
M 16	x	40	S	50	970,00 Ms
M 16	x	45	S	25	1040,00 Ms
M 16	x	50	S	25	1100,00 Ms
M 16	x	55	S	25	1170,00 Ms
M 16	x	60	S	10	1260,00 Ms
M 16	x	65	S	10	1360,00 Ms
M 16	x	70	S	10	1440,00 Ms
M 16	x	80	S	10	1570,00 Ms
M 16	x	90	S	10	1780,00 Ms

Abmessungen	VE Stück	€/100/Obf.			
M 16	x	100	S	10	1910,00 Ms
M 20	x	30	S	10	1360,00 Ms
M 20	x	40	S	10	1490,00 Ms
M 20	x	50	S	10	1730,00 Ms
M 20	x	60	S	10	2020,00 Ms
M 20	x	80	S	1	2600,00 Ms
M 20	x	100	S	1	3200,00 Ms

Abmessungen	VE Stück	€/100/Obf.
DIN	00933.600	
933	Kunststoff PA	

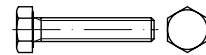

Sechskantschrauben mit Gewinde bis Kopf*

*Gewindelänge max. 50 mm

Achtung! Grobe Toleranzen, evtl. Lunkenbildung nach VDI 2544/Abs. 8

Muttern → DIN 555

Maße → **TI-15** REACH → **TI-262**
 Werkstoffeigensch. → **TI-239**

Stahl → **S. 156**
 Rostfrei → **S. 490**

Weitgehend identisch mit DIN 34810

M 3	x	8	S	200	7,50 Kunstst
M 3	x	10	S	200	7,70 Kunstst
M 3	x	12	S	200	7,70 Kunstst
M 3	x	16	S	200	7,90 Kunstst
M 3	x	20	S	200	8,40 Kunstst
M 3	x	25	S	200	8,60 Kunstst
M 3	x	30	S	200	8,80 Kunstst
M 4	x	8	S	200	7,90 Kunstst
M 4	x	10	S	200	8,20 Kunstst
M 4	x	12	S	200	8,30 Kunstst
M 4	x	16	S	200	8,50 Kunstst
M 4	x	20	S	200	9,10 Kunstst
M 4	x	25	S	200	9,50 Kunstst
M 4	x	30	S	200	10,00 Kunstst
M 5	x	10	S	200	9,20 Kunstst
M 5	x	12	S	200	9,50 Kunstst
M 5	x	16	S	200	10,10 Kunstst
M 5	x	20	S	200	11,80 Kunstst
M 5	x	25	S	200	12,40 Kunstst
M 5	x	30	S	200	13,20 Kunstst
M 5	x	40	S	200	14,50 Kunstst
M 6	x	10	S	200	10,50 Kunstst
M 6	x	12	S	200	10,70 Kunstst
M 6	x	16	S	200	11,20 Kunstst
M 6	x	20	S	200	12,30 Kunstst
M 6	x	25	S	200	13,40 Kunstst
M 6	x	30	S	200	16,10 Kunstst
M 6	x	35	S	200	16,80 Kunstst
M 6	x	40	S	200	17,40 Kunstst
M 6	x	50	S	200	18,40 Kunstst
M 8	x	10	S	200	20,10 Kunstst
M 8	x	12	S	200	21,00 Kunstst
M 8	x	16	S	200	22,10 Kunstst
M 8	x	20	S	200	24,00 Kunstst
M 8	x	25	S	200	26,00 Kunstst
M 8	x	30	S	200	27,50 Kunstst
M 8	x	35	S	200	28,50 Kunstst
M 8	x	40	S	200	30,00 Kunstst
M 8	x	50	S	200	32,00 Kunstst
M 8	x	60	S	200	41,50 Kunstst
M 8	x	70	S	200	45,50 Kunstst
M 10	x	20	S	200	44,50 Kunstst

Abmessungen	VE	Stück	€/100/Obf.
M 10 x 25	S	200	49,00 Kunstst
M 10 x 30	S	200	54,00 Kunstst
M 10 x 35	S	200	58,00 Kunstst
M 10 x 40	S	200	62,00 Kunstst
M 10 x 45	S	200	65,00 Kunstst
M 10 x 50	S	200	67,00 Kunstst
M 10 x 60	S	100	85,00 Kunstst
M 12 x 20	S	100	56,00 Kunstst
M 12 x 25	S	100	62,00 Kunstst
M 12 x 30	S	100	67,00 Kunstst
M 12 x 35	S	100	70,00 Kunstst
M 12 x 40	S	100	73,00 Kunstst
M 12 x 50	S	100	81,00 Kunstst
M 12 x 60	S	100	84,00 Kunstst

DIN	00934.700
934	Messing

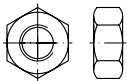

Sechskantmuttern

Maße → **TI-62** Normumstellung → **TI-7**
 Werkstoffeigensch. → **TI-239** REACH → **TI-262**
 Anziehmomente → **TI-250**

Stahl → **S. 168**
 Rostfrei → **S. 495**

DIN 934 → wird ersetzt durch ISO 4032



M 1	K	100	68,00 Ms
M 1,2	K	100	45,00 Ms
M 1,4	K	100	43,00 Ms
M 1,6	K	100	30,50 Ms
M 1,7	K	100	29,50 Ms
M 2	S	1000	3,85 Ms
M 2	K	100	8,00 Ms
M 2,3	S	1000	3,85 Ms
M 2,3	K	100	8,00 Ms
M 2,5	S	1000	3,85 Ms
M 2,5	K	100	8,00 Ms
M 2,6	S	1000	3,85 Ms
M 2,6	K	100	8,00 Ms
M 3	S	1000	3,85 Ms
M 3	K	100	8,00 Ms
M 3,5	K	100	9,20 Ms
M 4	S	1000	5,70 Ms
M 4	K	100	9,70 Ms
M 5	S	1000	7,20 Ms
M 5	K	100	11,20 Ms
M 6	S	1000	10,90 Ms
M 6	K	100	17,00 Ms
M 7	K	100	17,50 Ms
M 8	S	1000	21,50 Ms
M 8	K	100	27,50 Ms
M 10	S	500	41,50 Ms
M 10	K	100	51,00 Ms
M 12	S	250	66,00 Ms
M 12	K	100	75,00 Ms
M 14	S	250	107,00 Ms
M 14	K	50	125,00 Ms
M 16	S	250	125,00 Ms
M 16	K	50	141,00 Ms
M 18	S	25	247,00 Ms
M 20	S	25	310,00 Ms
M 22	S	10	510,00 Ms
M 24	S	10	570,00 Ms

Abmessungen	VE	Stück	€/100/Obf.
M 27	S	1	880,00 Ms
M 30	S	1	1070,00 Ms
M 33	S	1	2440,00 Ms
M 36	S	1	2440,00 Ms
M 42	S	1	6600,00 Ms

DIN	00934.730
934	Messing galvanisch vernickelt

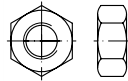

Sechskantmuttern

Maße → **TI-62** Normumstellung → **TI-7**
 Werkstoffeigensch. → **TI-239** REACH → **TI-262**
 Anziehmomente → **TI-250**

Stahl → **S. 168**
 Rostfrei → **S. 495**

DIN 934 → wird ersetzt durch ISO 4032



M 2	S	1000	4,55 Ms Ni
M 2,5	S	1000	4,65 Ms Ni
M 3	S	1000	4,65 Ms Ni
M 3,5	S	1000	4,80 Ms Ni
M 4	S	1000	6,90 Ms Ni
M 5	S	1000	8,80 Ms Ni
M 6	S	1000	16,00 Ms Ni
M 8	S	100	34,50 Ms Ni
M 10	S	100	67,00 Ms Ni
M 12	S	100	120,00 Ms Ni
M 16	S	100	239,00 Ms Ni

DIN	00934.740
934	Messing galvanisch verchromt

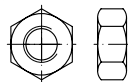

Sechskantmuttern

Maße → **TI-62** Normumstellung → **TI-7**
 Werkstoffeigensch. → **TI-239** REACH → **TI-262**
 Anziehmomente → **TI-250**

Stahl → **S. 168**
 Rostfrei → **S. 495**

DIN 934 → wird ersetzt durch ISO 4032



M 3	S	100	16,70 Ms Cr
M 4	S	100	20,70 Ms Cr
M 5	S	100	30,50 Ms Cr
M 6	S	100	37,00 Ms Cr
M 8	S	100	63,00 Ms Cr

Abmessungen	VE	Stück	€/100/Obf.
DIN		00934.705	
934	Messing		Fein

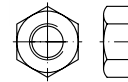

Sechskantmuttern mit metrischem Feingewinde

Maße → **TI-62** Normumstellung → **TI-7**
 Werkstoffeigensch. → **TI-239** REACH → **TI-262**
 Anziehmomente → **TI-250**

Stahl → **S. 168**
 Rostfrei → **S. 496**

DIN 934 Feingew. → wird ersetzt durch ISO 8673



M 8 x 1	S	100	47,00 Ms
M 10 x 1	S	100	65,00 Ms
M 14 x 1,5	S	50	141,00 Ms
M 16 x 1,5	S	25	205,00 Ms
M 20 x 1,5	S	10	410,00 Ms
M 22 x 1,5	S	10	580,00 Ms

DIN	00934.302
934	CuNiSi

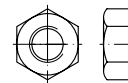

Sechskantmuttern

Maße → **TI-62** Normumstellung → **TI-7**
 Werkstoffeigensch. → **TI-239**

Stahl → **S. 168**
 Rostfrei → **S. 495**
 Messing, Aluminium, Titan → **S. 626**

DIN 934 → wird ersetzt durch ISO 4032

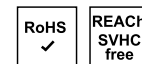

M 6	S	100	71,00 CuNiSi
M 8	S	100	138,00 CuNiSi
M 10	S	100	228,00 CuNiSi
M 12	S	100	360,00 CuNiSi
M 16	S	100	710,00 CuNiSi
M 20	S	1	3300,00 CuNiSi
M 24	S	1	5400,00 CuNiSi

Abmessungen	VE Stück	€/100/Obf.
DIN	00934.303	
934 Aluminium		

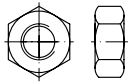

Sechskantmuttern

Maße → **TI-62** Normumstellung → **TI-7**
 Werkstoffeigensch. → **TI-239** REACH → **TI-262**

Stahl → **S. 168**
 Rostfrei → **S. 495**
 Messing, Kupfer, Titan → **S. 626**

DIN 934 → wird ersetzt durch ISO 4032



M 4	S	100	6,50 Al
M 5	S	100	8,40 Al
M 6	S	100	10,00 Al
M 8	S	100	20,30 Al
M 10	S	100	38,50 Al
M 12	S	50	53,00 Al
M 16	S	50	104,00 Al

DIN	00934.308
934 Titan (Grade 2)	

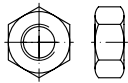

Sechskantmuttern

Maße → **TI-62** Normumstellung → **TI-7**
 Werkstoffeigensch. → **TI-239**

Stahl → **S. 168**
 Rostfrei → **S. 495**
 Messing, Kupfer, Aluminium → **S. 626**

DIN 934 → wird ersetzt durch ISO 4032



M 6	S	50	490,00 Ti
M 8	S	50	660,00 Ti
M 10	S	50	1010,00 Ti
M 12	S	25	1300,00 Ti
M 16	S	25	4300,00 Ti

Abmessungen	VE Stück	€/100/Obf.
DIN	00936.700	
936 Messing		

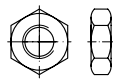

Sechskantmuttern, niedrige Form

Maße → **TI-63** Normumstellung → **TI-7**
 Werkstoffeigensch. → **TI-239** REACH → **TI-262**

Stahl → **S. 174**
 Rostfrei → **S. 497**

Muttern nach ISO → ISO 4035 (DIN 439)



M 12	S	100	69,00 Ms
M 14	S	50	121,00 Ms
M 16	S	50	141,00 Ms
M 20	S	25	265,00 Ms
M 24	S	25	500,00 Ms
M 36	S	1	2420,00 Ms

DIN	00936.705
936 Messing Fein	

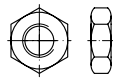

Sechskantmuttern, niedrige Form, mit metrischem Feingewinde

Maße → **TI-63** Normumstellung → **TI-7**
 Werkstoffeigensch. → **TI-239** REACH → **TI-262**

Stahl → **S. 175**
 Rostfrei → **S. 498**

Muttern nach ISO → ISO 8675 (DIN 439)



M 10	x	1	S	100	52,00 Ms
M 12	x	1,5	S	100	76,00 Ms
M 14	x	1,5	S	50	132,00 Ms
M 16	x	1,5	S	50	154,00 Ms
M 18	x	1,5	S	25	265,00 Ms
M 20	x	1,5	S	25	290,00 Ms
M 24	x	1,5	S	25	550,00 Ms
M 30	x	1,5	S	10	1290,00 Ms

Abmessungen	VE Stück	€/100/Obf.
DIN	00963.704	
963 Messing blank gedreht		



Senkschrauben mit Schlitz

Maße → **TI-27** Normumstellung → **TI-11**
 Werkstoffeigensch. → **TI-239** REACH → **TI-262**

Stahl → **S. 187**
 Rostfrei → **S. 500**

DIN 963 → wird ersetzt durch ISO 2009



M 1,6	x	4	S	100	27,00 Ms gedr
M 1,6	x	6	S	100	28,00 Ms gedr
M 1,6	x	10	S	100	36,00 Ms gedr

DIN	00963.700
963 Messing	

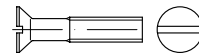

Senkschrauben mit Schlitz

Maße → **TI-27** Normumstellung → **TI-11**
 Werkstoffeigensch. → **TI-239** REACH → **TI-262**

Stahl → **S. 187**
 Rostfrei → **S. 500**

DIN 963 → wird ersetzt durch ISO 2009



M 2	x	4	K	200	11,30 Ms
M 2	x	5	K	200	10,40 Ms
M 2	x	6	K	200	9,50 Ms
M 2	x	8	K	200	8,40 Ms
M 2	x	10	K	200	8,80 Ms
M 2	x	12	K	200	9,30 Ms
M 2	x	16	K	200	10,70 Ms
M 2	x	20	K	200	12,00 Ms
M 2,5	x	4	K	200	11,60 Ms
M 2,5	x	5	K	200	10,10 Ms
M 2,5	x	6	K	200	8,70 Ms
M 2,5	x	8	K	200	8,40 Ms
M 2,5	x	10	K	200	8,80 Ms
M 2,5	x	12	K	200	9,30 Ms
M 2,5	x	16	K	200	10,70 Ms
M 2,5	x	18	K	200	18,10 Ms
M 2,5	x	20	K	200	12,00 Ms
M 3	x	4	S	1000	8,70 Ms
M 3	x	4	K	200	8,70 Ms
M 3	x	5	K	200	8,10 Ms
M 3	x	6	S	1000	6,90 Ms
M 3	x	6	K	200	6,90 Ms
M 3	x	8	S	1000	7,10 Ms
M 3	x	8	K	200	7,10 Ms
M 3	x	10	S	1000	7,30 Ms
M 3	x	10	K	200	7,30 Ms
M 3	x	12	S	1000	7,70 Ms

Abmessungen	VE	Stück	€/100/Obf.
M 3 x 12	K	200	7,70 Ms
M 3 x 16	S	1000	8,80 Ms
M 3 x 16	K	200	8,80 Ms
M 3 x 18	K	200	15,20 Ms
M 3 x 20	S	1000	10,10 Ms
M 3 x 20	K	200	10,10 Ms
M 3 x 25	K	200	11,30 Ms
M 3 x 30	K	200	13,80 Ms
M 3 x 35	K	200	14,60 Ms
M 3 x 40	K	200	20,70 Ms
M 4 x 5	K	200	10,70 Ms
M 4 x 6	S	1000	9,50 Ms
M 4 x 6	K	200	9,50 Ms
M 4 x 8	S	1000	10,30 Ms
M 4 x 8	K	200	10,30 Ms
M 4 x 10	S	1000	10,70 Ms
M 4 x 10	K	200	10,70 Ms
M 4 x 12	S	1000	10,90 Ms
M 4 x 12	K	200	10,90 Ms
M 4 x 16	S	1000	13,00 Ms
M 4 x 16	K	200	13,00 Ms
M 4 x 18	K	200	22,60 Ms
M 4 x 20	S	1000	15,20 Ms
M 4 x 20	K	200	15,20 Ms
M 4 x 25	S	1000	16,00 Ms
M 4 x 25	K	200	16,00 Ms
M 4 x 30	S	1000	18,90 Ms
M 4 x 30	K	200	18,90 Ms
M 4 x 35	K	200	21,00 Ms
M 4 x 40	K	200	22,80 Ms
M 4 x 45	K	200	28,50 Ms
M 4 x 50	K	200	30,50 Ms
M 5 x 8	K	200	15,70 Ms
M 5 x 10	S	1000	16,00 Ms
M 5 x 10	K	200	16,00 Ms
M 5 x 12	S	1000	16,50 Ms
M 5 x 12	K	200	16,50 Ms
M 5 x 16	S	1000	18,90 Ms
M 5 x 16	K	200	18,90 Ms
M 5 x 18	K	200	30,50 Ms
M 5 x 20	S	1000	20,50 Ms
M 5 x 20	K	200	20,50 Ms
M 5 x 25	S	1000	23,10 Ms
M 5 x 25	K	200	23,10 Ms
M 5 x 30	S	1000	27,00 Ms
M 5 x 30	K	200	27,00 Ms
M 5 x 35	K	200	34,50 Ms
M 5 x 40	K	200	36,50 Ms
M 5 x 45	K	200	39,50 Ms
M 5 x 50	K	200	42,00 Ms
M 5 x 60	K	200	54,00 Ms
M 6 x 10	S	1000	21,50 Ms
M 6 x 10	K	200	21,50 Ms
M 6 x 12	S	1000	24,20 Ms
M 6 x 12	K	200	24,20 Ms
M 6 x 16	S	1000	28,00 Ms
M 6 x 16	K	200	28,00 Ms
M 6 x 20	S	1000	30,50 Ms
M 6 x 20	K	200	30,50 Ms
M 6 x 25	S	1000	32,50 Ms
M 6 x 25	K	200	32,50 Ms
M 6 x 30	K	200	37,50 Ms
M 6 x 35	K	200	43,00 Ms
M 6 x 40	K	200	46,50 Ms
M 6 x 45	K	200	54,00 Ms
M 6 x 50	K	200	56,00 Ms
M 6 x 60	K	100	72,00 Ms
M 6 x 70	K	100	83,00 Ms
M 6 x 80	K	100	89,00 Ms
M 8 x 12	K	100	71,00 Ms
M 8 x 16	K	100	61,00 Ms
M 8 x 20	K	100	65,00 Ms
M 8 x 25	K	100	68,00 Ms
M 8 x 30	K	100	79,00 Ms
M 8 x 35	K	100	84,00 Ms

Abmessungen	VE	Stück	€/100/Obf.
M 8 x 40	K	100	89,00 Ms
M 8 x 45	K	100	104,00 Ms
M 8 x 50	K	100	110,00 Ms
M 8 x 60	K	100	132,00 Ms
M 8 x 70	K	100	162,00 Ms
M 8 x 80	K	100	173,00 Ms
M 10 x 16	K	100	99,00 Ms
M 10 x 20	K	100	96,00 Ms
M 10 x 25	K	100	109,00 Ms
M 10 x 30	K	100	118,00 Ms
M 10 x 35	K	100	132,00 Ms
M 10 x 40	K	100	146,00 Ms
M 10 x 45	K	100	157,00 Ms
M 10 x 50	K	100	167,00 Ms
M 10 x 60	K	100	189,00 Ms
M 10 x 70	K	100	244,00 Ms
M 10 x 80	K	100	270,00 Ms
M 12 x 20	K	50	290,00 Ms
M 12 x 25	K	50	295,00 Ms
M 12 x 30	K	50	330,00 Ms
M 12 x 35	K	50	360,00 Ms
M 12 x 40	K	50	390,00 Ms
M 12 x 45	K	50	420,00 Ms
M 12 x 50	K	50	455,00 Ms
M 12 x 70	K	50	590,00 Ms
M 16 x 25	K	25	1170,00 Ms
M 16 x 30	K	25	1170,00 Ms
M 16 x 35	K	25	1260,00 Ms
M 16 x 40	K	25	1360,00 Ms
M 16 x 45	K	25	1460,00 Ms
M 16 x 50	K	25	1570,00 Ms

DIN	00963.730
963	Messing galvanisch vernickelt



Senkschrauben mit Schlitz

Maße → **TI-27** Normumstellung → **TI-11**
 Werkstoffeigensch. → **TI-239** REACH → **TI-262**
 Stahl → **S. 187**
 Rostfrei → **S. 500**

DIN 963 → wird ersetzt durch ISO 2009



Abmessungen	VE	Stück	€/100/Obf.
M 3 x 10	K	200	8,40 gal Ni
M 3 x 16	K	200	10,00 gal Ni
M 3 x 20	K	200	11,20 gal Ni
M 3 x 30	K	200	14,90 gal Ni
M 4 x 10	K	200	11,80 gal Ni
M 4 x 16	K	200	14,10 gal Ni
M 4 x 20	K	200	16,50 gal Ni
M 4 x 30	K	200	20,70 gal Ni
M 5 x 10	K	200	17,00 gal Ni
M 5 x 16	K	200	20,50 gal Ni
M 5 x 20	K	200	22,60 gal Ni
M 6 x 10	K	200	23,40 gal Ni
M 6 x 16	K	200	30,50 gal Ni
M 6 x 20	K	200	34,00 gal Ni

Abmessungen	VE	Stück	€/100/Obf.
DIN	00963.600		
963	Kunststoff PA		

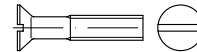

Senkschrauben mit Schlitz

Achtung! Grobe Toleranzen nach VDI 2544.

Muttern → DIN 555

Maße → **TI-27** REACH → **TI-262**

Werkstoffeigensch. → **TI-239**

Stahl → **S. 187**

Rostfrei → **S. 500**

Abmessungen	VE	Stück	€/100/Obf.
M 3 x 6	S	200	5,50 Kunstst
M 3 x 8	S	200	5,70 Kunstst
M 3 x 10	S	200	5,90 Kunstst
M 3 x 12	S	200	6,00 Kunstst
M 3 x 16	S	200	6,10 Kunstst
M 3 x 20	S	200	6,40 Kunstst
M 4 x 10	S	200	6,80 Kunstst
M 4 x 12	S	200	7,10 Kunstst
M 4 x 16	S	200	7,20 Kunstst
M 4 x 20	S	200	7,50 Kunstst
M 4 x 25	S	200	7,80 Kunstst
M 4 x 30	S	200	8,20 Kunstst
M 5 x 10	S	200	7,30 Kunstst
M 5 x 12	S	200	7,80 Kunstst
M 5 x 16	S	200	8,50 Kunstst
M 5 x 20	S	200	9,40 Kunstst
M 5 x 25	S	200	10,00 Kunstst
M 6 x 10	S	200	8,20 Kunstst
M 6 x 12	S	200	9,00 Kunstst
M 6 x 16	S	200	9,50 Kunstst
M 6 x 20	S	200	10,50 Kunstst
M 6 x 25	S	200	12,00 Kunstst
M 6 x 30	S	200	13,00 Kunstst
M 8 x 16	S	200	17,40 Kunstst
M 8 x 20	S	200	18,50 Kunstst
M 8 x 25	S	200	20,60 Kunstst
M 8 x 30	S	200	23,50 Kunstst
M 8 x 40	S	200	27,50 Kunstst

DIN	00964.700		
964	Messing		



Linsensenkschrauben mit Schlitz

Maße → **TI-39** Normumstellung → **TI-11**
 Werkstoffeigensch. → **TI-239** REACH → **TI-262**

Stahl → **S. 189**

Rostfrei → **S. 502**

DIN 964 → wird ersetzt durch ISO 2010



Abmessungen	VE	Stück	€/100/Obf.
M 3 x 5	K	200	8,10 Ms
M 3 x 6	K	200	6,90 Ms
M 3 x 8	K	200	7,10 Ms

Abmessungen	VE	Stück	€/100/Obf.
M 3 x 10	K	200	7,30 Ms
M 3 x 12	K	200	7,70 Ms
M 3 x 16	K	200	8,80 Ms
M 3 x 20	K	200	10,10 Ms
M 3 x 25	K	200	11,30 Ms
M 3 x 30	K	200	13,80 Ms
M 3 x 35	K	200	14,60 Ms
M 3 x 40	K	200	20,70 Ms
M 4 x 5	K	200	10,70 Ms
M 4 x 6	K	200	9,50 Ms
M 4 x 8	K	200	10,30 Ms
M 4 x 10	K	200	10,70 Ms
M 4 x 12	K	200	10,90 Ms
M 4 x 16	K	200	13,00 Ms
M 4 x 20	K	200	15,20 Ms
M 4 x 25	K	200	16,00 Ms
M 4 x 30	K	200	18,90 Ms
M 4 x 35	K	200	21,00 Ms
M 4 x 40	K	200	22,80 Ms
M 4 x 45	K	200	28,50 Ms
M 4 x 50	K	200	29,50 Ms
M 4 x 60	K	200	54,00 Ms
M 5 x 8	K	200	15,70 Ms
M 5 x 10	K	200	16,00 Ms
M 5 x 12	K	200	16,50 Ms
M 5 x 16	K	200	18,90 Ms
M 5 x 20	K	200	20,70 Ms
M 5 x 25	K	200	23,10 Ms
M 5 x 30	K	200	27,00 Ms
M 5 x 35	K	200	34,50 Ms
M 5 x 40	K	200	36,50 Ms
M 5 x 45	K	200	39,50 Ms
M 5 x 50	K	200	42,00 Ms
M 5 x 60	K	200	54,00 Ms
M 5 x 70	K	200	66,00 Ms
M 5 x 80	K	200	83,00 Ms
M 5 x 100	K	200	136,00 Ms
M 6 x 8	K	200	27,00 Ms
M 6 x 10	K	200	21,50 Ms
M 6 x 12	K	200	24,20 Ms
M 6 x 16	K	200	28,00 Ms
M 6 x 20	K	200	30,50 Ms
M 6 x 25	K	200	32,50 Ms
M 6 x 30	K	200	37,50 Ms
M 6 x 35	K	200	43,00 Ms
M 6 x 40	K	200	46,50 Ms
M 6 x 45	K	200	54,00 Ms
M 6 x 50	K	200	56,00 Ms
M 6 x 60	K	100	72,00 Ms
M 6 x 70	K	100	83,00 Ms
M 6 x 80	K	100	89,00 Ms
M 6 x 100	S	100	100,00 Ms
M 8 x 16	K	100	61,00 Ms
M 8 x 20	K	100	65,00 Ms
M 8 x 25	K	100	68,00 Ms
M 8 x 30	K	100	79,00 Ms
M 8 x 35	K	100	84,00 Ms
M 8 x 40	K	100	89,00 Ms
M 8 x 50	K	100	110,00 Ms
M 8 x 60	K	100	132,00 Ms

Abmessungen	VE	Stück	€/100/Obf.
DIN	00964.730		
964	Messing galvanisch vernickelt		



Linsensenschrauben mit Schlitz

Maße → **TI-39** Normumstellung → **TI-11**
 Werkstoffeigensch. → **TI-239** REACH → **TI-262**

Stahl → **S. 189**
 Rostfrei → **S. 502**

DIN 964 → wird ersetzt durch ISO 2010



M 3 x 8	K	200	8,10 Ms Ni
M 3 x 10	K	200	8,40 Ms Ni
M 3 x 12	K	200	8,90 Ms Ni
M 3 x 16	K	200	10,00 Ms Ni
M 3 x 20	K	200	11,20 Ms Ni
M 3 x 25	K	200	12,40 Ms Ni
M 4 x 8	K	200	11,30 Ms Ni
M 4 x 10	K	200	11,80 Ms Ni
M 4 x 12	K	200	12,00 Ms Ni
M 4 x 16	K	200	14,40 Ms Ni
M 4 x 20	K	200	16,50 Ms Ni
M 4 x 25	K	200	17,50 Ms Ni
M 4 x 30	K	200	20,70 Ms Ni
M 4 x 35	K	200	23,40 Ms Ni
M 4 x 40	K	200	25,50 Ms Ni
M 4 x 45	K	200	29,50 Ms Ni
M 4 x 50	K	200	33,50 Ms Ni
M 4 x 60	K	200	59,00 Ms Ni
M 5 x 10	K	200	17,30 Ms Ni
M 5 x 12	K	200	18,10 Ms Ni
M 5 x 16	K	200	20,70 Ms Ni
M 5 x 20	K	200	22,80 Ms Ni
M 5 x 25	K	200	26,00 Ms Ni
M 5 x 30	K	200	30,00 Ms Ni
M 5 x 35	K	200	38,00 Ms Ni
M 5 x 40	K	200	40,50 Ms Ni
M 5 x 45	K	200	44,00 Ms Ni
M 5 x 50	K	200	47,00 Ms Ni
M 5 x 60	K	200	59,00 Ms Ni
M 5 x 70	K	200	73,00 Ms Ni
M 5 x 80	K	200	91,00 Ms Ni
M 6 x 10	K	200	23,60 Ms Ni
M 6 x 12	K	200	27,00 Ms Ni
M 6 x 16	K	200	30,50 Ms Ni
M 6 x 20	K	200	34,00 Ms Ni
M 6 x 25	K	200	35,00 Ms Ni
M 6 x 30	K	200	42,50 Ms Ni
M 6 x 35	K	200	48,00 Ms Ni
M 6 x 40	K	200	53,00 Ms Ni
M 6 x 45	K	200	60,00 Ms Ni
M 6 x 50	K	200	63,00 Ms Ni
M 6 x 60	K	100	80,00 Ms Ni
M 6 x 70	K	100	92,00 Ms Ni
M 6 x 80	K	100	101,00 Ms Ni

Abmessungen	VE	Stück	€/100/Obf.
DIN	00964.740		
964	Messing galvanisch verchromt		



Linsensenschrauben mit Schlitz

Maße → **TI-39** Normumstellung → **TI-11**
 Werkstoffeigensch. → **TI-239** REACH → **TI-262**

Stahl → **S. 189**
 Rostfrei → **S. 502**

DIN 964 → wird ersetzt durch ISO 2010



M 3 x 8	K	200	13,80 Ms Gr
M 3 x 10	K	200	15,20 Ms Gr
M 3 x 12	K	200	16,50 Ms Gr
M 3 x 16	K	200	19,40 Ms Gr
M 3 x 20	K	200	22,80 Ms Gr
M 3 x 25	K	200	17,50 Ms Gr
M 3 x 30	K	200	31,50 Ms Gr
M 4 x 8	K	200	17,30 Ms Gr
M 4 x 10	K	200	18,30 Ms Gr
M 4 x 12	K	200	19,40 Ms Gr
M 4 x 16	K	200	23,40 Ms Gr
M 4 x 20	K	200	27,50 Ms Gr
M 4 x 25	K	200	30,50 Ms Gr
M 4 x 30	K	200	36,00 Ms Gr
M 4 x 35	K	200	40,50 Ms Gr
M 4 x 40	K	200	44,50 Ms Gr
M 4 x 45	K	200	52,00 Ms Gr
M 4 x 50	K	200	57,00 Ms Gr
M 4 x 60	K	200	85,00 Ms Gr
M 5 x 10	K	200	28,00 Ms Gr
M 5 x 12	K	200	30,00 Ms Gr
M 5 x 16	K	200	36,00 Ms Gr
M 5 x 20	K	200	40,50 Ms Gr
M 5 x 25	K	200	47,00 Ms Gr
M 5 x 30	K	200	54,00 Ms Gr
M 5 x 35	K	200	65,00 Ms Gr
M 5 x 40	K	200	72,00 Ms Gr
M 5 x 45	K	200	53,00 Ms Gr
M 5 x 50	K	200	85,00 Ms Gr
M 5 x 60	K	200	104,00 Ms Gr
M 5 x 70	K	200	125,00 Ms Gr
M 6 x 10	K	200	40,00 Ms Gr
M 6 x 16	K	200	54,00 Ms Gr
M 6 x 20	K	200	60,00 Ms Gr
M 6 x 25	K	200	69,00 Ms Gr
M 6 x 30	K	200	79,00 Ms Gr
M 6 x 35	K	200	89,00 Ms Gr
M 6 x 40	K	200	99,00 Ms Gr
M 6 x 50	K	200	118,00 Ms Gr
M 6 x 60	K	100	146,00 Ms Gr
M 6 x 80	K	100	186,00 Ms Gr
M 8 x 20	K	100	112,00 Ms Gr
M 8 x 25	K	100	122,00 Ms Gr

Abmessungen	VE Stück	€/100/Obf.
~DIN	00975.700	
975*	Messing	



Gewindestangen, Länge 1000 mm

(entsprechend DIN 976-1, Form A)

Werkstoffeigensch. → TI-239 REACH → TI-262

Stahl → S. 192
Rostfrei → S. 507



M 2	S	1	1940,00 Ms
M 3	S	1	960,00 Ms
M 4	S	1	850,00 Ms
M 5	S	1	1300,00 Ms
M 6	S	1	1520,00 Ms
M 8	S	1	2340,00 Ms
M 10	S	1	3450,00 Ms
M 12	S	1	4600,00 Ms
M 14	S	1	6600,00 Ms
M 16	S	1	8700,00 Ms
M 18	S	1	12900,00 Ms
M 20	S	1	13700,00 Ms
M 24	S	1	17400,00 Ms

~DIN	00975.600
975*	Kunststoff PA



Gewindestangen, Länge 1000 mm

(entsprechend DIN 976-1, Form A)

Achtung! Grobe Toleranzen nach VDI 2544.

Werkstoffeigensch. → TI-239 REACH → TI-262

Stahl → S. 192
Rostfrei → S. 507

M 5	S	1	1080,00 Kunstst
M 6	S	1	1100,00 Kunstst
M 8	S	1	1350,00 Kunstst
M 10	S	1	1730,00 Kunstst
M 12	S	1	2190,00 Kunstst
M 16	S	1	3000,00 Kunstst
M 20	S	1	4500,00 Kunstst

Abmessungen	VE Stück	€/100/Obf.
~DIN	00985.700	
985	Messing	

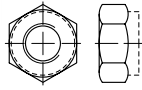

Sechskantmutter mit Klemmteil, mit nichtmetallischem Einsatz, niedrige Form

für Temperatur-Einsatz von -50 bis +120 °C

Maße → TI-9 Normumstellung → TI-9
Werkstoffeigensch. → TI-239 REACH → TI-262

Stahl → S. 201
Rostfrei → S. 512

DIN 985 → wird ersetzt durch ISO 10511

M 4	S	100	30,00 Ms
M 5	S	100	33,00 Ms
M 6	S	100	34,00 Ms
M 8	S	100	58,00 Ms
M 10	S	100	110,00 Ms
M 12	S	50	170,00 Ms

Wichtiger Hinweis!

Die gültigen Normen für Sechskantmutter mit Klemmteil gelten für die Ausführung Stahl in den Festigkeitsklassen 5, (6), 8, 10 bzw. 12. Die Verwendung von Muttern mit Klemmteil aus anderen Werkstoffen (z.B. nichtrostenden Stählen, Messing, Aluminium) erfolgt auf eigenes Risiko. Muttern mit Klemmteil aus diesen weicheren Werkstoffen neigen manchmal wegen des hohen Gewindeflankendrucks beim Einformen des Bolzen- gewindes in den Sicherungsring zum Festfressen. Hier hilft in der Regel die Verwendung eines Schmiermittels. Die veränderten Reibwerte sind beim Anziehen der Verbindung entsprechend zu berücksichtigen.



ISO	01207.705
1207	Messing blank gedreht

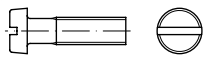

Zylinderschrauben mit Schlitz

Maße → TI-37 Normumstellung → TI-11
Werkstoffeigensch. → TI-239 REACH → TI-262

Stahl → S. 205
Rostfrei → S. 513

ISO 1207 → ersetzt DIN 84 (austauschbar)



M 1	x	2	S	100	52,00 Ms gedr
M 1	x	3	S	100	53,00 Ms gedr

Abmessungen	VE Stück	€/100/Obf.			
M 1	x	4	S	100	53,00 Ms gedr
M 1	x	5	S	100	56,00 Ms gedr
M 1	x	6	S	100	61,00 Ms gedr
M 1	x	8	S	100	68,00 Ms gedr
M 1	x	10	S	100	77,00 Ms gedr
M 1,4	x	3	S	100	50,00 Ms gedr
M 1,4	x	4	S	100	52,00 Ms gedr
M 1,4	x	5	S	100	53,00 Ms gedr
M 1,4	x	6	S	100	58,00 Ms gedr
M 1,4	x	8	S	100	67,00 Ms gedr
M 1,4	x	10	S	100	75,00 Ms gedr
M 1,4	x	12	S	100	93,00 Ms gedr
M 1,4	x	16	S	100	98,00 Ms gedr
M 1,6	x	4	S	100	46,50 Ms gedr
M 1,6	x	5	S	100	47,50 Ms gedr
M 1,6	x	6	S	100	49,00 Ms gedr
M 1,6	x	8	S	100	56,00 Ms gedr
M 1,6	x	10	S	100	58,00 Ms gedr
M 1,6	x	12	S	100	65,00 Ms gedr
M 1,6	x	16	S	100	73,00 Ms gedr

ISO	01207.700
1207	Messing

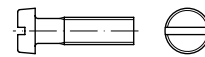

Zylinderschrauben mit Schlitz

Maße → TI-37 Normumstellung → TI-11
Werkstoffeigensch. → TI-239 REACH → TI-262

Stahl → S. 205
Rostfrei → S. 513

ISO 1207 → ersetzt DIN 84 (austauschbar)



M 2	x	4	K	200	14,10 Ms
M 2	x	5	K	200	13,30 Ms
M 2	x	6	K	200	12,40 Ms
M 2	x	8	K	200	11,00 Ms
M 2	x	10	K	200	11,40 Ms
M 2	x	12	K	200	12,00 Ms
M 2	x	16	K	200	13,30 Ms
M 2	x	20	K	200	14,60 Ms
M 2,5	x	3	K	200	27,00 Ms
M 2,5	x	4	K	200	11,20 Ms
M 2,5	x	5	K	200	11,70 Ms
M 2,5	x	6	K	200	11,60 Ms
M 2,5	x	8	K	200	11,00 Ms
M 2,5	x	10	K	200	11,40 Ms
M 2,5	x	12	K	200	12,00 Ms
M 2,5	x	16	K	200	13,30 Ms
M 2,5	x	20	K	200	14,60 Ms
M 3	x	4	S	1000	9,30 Ms
M 3	x	4	K	200	12,00 Ms
M 3	x	5	S	1000	8,70 Ms
M 3	x	5	K	200	11,30 Ms
M 3	x	6	S	1000	6,90 Ms
M 3	x	6	K	200	9,60 Ms
M 3	x	8	S	1000	7,10 Ms
M 3	x	8	K	200	9,70 Ms
M 3	x	10	S	1000	7,30 Ms
M 3	x	10	K	200	10,00 Ms
M 3	x	12	S	1000	7,70 Ms
M 3	x	12	K	200	10,40 Ms
M 3	x	16	S	1000	8,80 Ms
M 3	x	16	K	200	11,40 Ms
M 3	x	18	K	200	12,80 Ms

Abmessungen	VE	Stück	€/100/Obf.
M 3 x 20	S	1000	10,10 Ms
M 3 x 20	K	200	13,10 Ms
M 3 x 25	S	1000	11,30 Ms
M 3 x 25	K	200	14,00 Ms
M 3 x 30	S	1000	13,80 Ms
M 3 x 30	K	200	16,50 Ms
M 3 x 35	K	200	17,30 Ms
M 3 x 40	K	200	23,40 Ms
M 3 x 45	K	200	31,00 Ms
M 3 x 50	K	200	37,00 Ms
M 3,5 x 8	K	200	13,80 Ms
M 3,5 x 10	K	200	14,40 Ms
M 3,5 x 12	K	200	14,60 Ms
M 3,5 x 16	K	200	17,00 Ms
M 3,5 x 20	K	200	19,40 Ms
M 4 x 5	S	1000	10,70 Ms
M 4 x 5	K	200	13,30 Ms
M 4 x 6	S	1000	9,50 Ms
M 4 x 6	K	200	12,10 Ms
M 4 x 8	S	1000	10,30 Ms
M 4 x 8	K	200	12,90 Ms
M 4 x 10	S	1000	10,70 Ms
M 4 x 10	K	200	13,30 Ms
M 4 x 12	S	1000	10,90 Ms
M 4 x 12	K	200	13,60 Ms
M 4 x 16	S	1000	13,00 Ms
M 4 x 16	K	200	15,70 Ms
M 4 x 20	S	1000	15,20 Ms
M 4 x 20	K	200	17,80 Ms
M 4 x 25	S	1000	16,00 Ms
M 4 x 25	K	200	18,60 Ms
M 4 x 30	S	1000	18,90 Ms
M 4 x 30	K	200	21,50 Ms
M 4 x 35	S	1000	21,00 Ms
M 4 x 35	K	200	23,60 Ms
M 4 x 40	S	1000	22,80 Ms
M 4 x 40	K	200	25,50 Ms
M 4 x 45	K	200	31,00 Ms
M 4 x 50	K	200	33,00 Ms
M 4 x 60	K	200	56,00 Ms
M 5 x 6	K	200	20,50 Ms
M 5 x 8	K	200	18,30 Ms
M 5 x 10	S	1000	16,00 Ms
M 5 x 10	K	200	18,60 Ms
M 5 x 12	S	1000	16,50 Ms
M 5 x 12	K	200	19,10 Ms
M 5 x 16	S	1000	18,90 Ms
M 5 x 16	K	200	21,50 Ms
M 5 x 20	S	1000	20,70 Ms
M 5 x 20	K	200	23,40 Ms
M 5 x 22	K	200	25,50 Ms
M 5 x 25	S	1000	23,10 Ms
M 5 x 25	K	200	26,00 Ms
M 5 x 30	S	1000	27,00 Ms
M 5 x 30	K	200	29,50 Ms
M 5 x 35	S	1000	34,50 Ms
M 5 x 35	K	200	37,50 Ms
M 5 x 40	S	500	37,00 Ms
M 5 x 40	K	200	39,50 Ms
M 5 x 45	K	200	43,00 Ms
M 5 x 50	K	200	45,50 Ms
M 5 x 60	K	200	56,00 Ms
M 5 x 70	K	200	69,00 Ms
M 6 x 8	K	200	29,50 Ms
M 6 x 10	S	1000	21,50 Ms
M 6 x 10	K	200	24,20 Ms
M 6 x 12	S	1000	24,20 Ms
M 6 x 12	K	200	27,00 Ms
M 6 x 16	S	1000	28,00 Ms
M 6 x 16	K	200	30,50 Ms
M 6 x 18	K	200	32,00 Ms
M 6 x 20	S	1000	30,50 Ms
M 6 x 20	K	200	33,50 Ms
M 6 x 25	S	1000	33,00 Ms
M 6 x 25	K	200	35,50 Ms

Abmessungen	VE	Stück	€/100/Obf.
M 6 x 30	S	500	37,50 Ms
M 6 x 30	K	200	40,50 Ms
M 6 x 35	K	200	45,50 Ms
M 6 x 40	K	200	49,00 Ms
M 6 x 45	K	200	56,00 Ms
M 6 x 50	K	200	59,00 Ms
M 6 x 60	K	100	75,00 Ms
M 6 x 70	K	100	85,00 Ms
M 6 x 80	K	100	92,00 Ms
M 8 x 10	K	100	73,00 Ms
M 8 x 12	K	100	71,00 Ms
M 8 x 16	K	100	64,00 Ms
M 8 x 20	K	100	68,00 Ms
M 8 x 25	K	100	71,00 Ms
M 8 x 30	K	100	81,00 Ms
M 8 x 35	K	100	87,00 Ms
M 8 x 40	K	100	92,00 Ms
M 8 x 45	K	100	107,00 Ms
M 8 x 50	K	100	113,00 Ms
M 8 x 60	K	100	134,00 Ms
M 10 x 16	K	100	101,00 Ms
M 10 x 20	K	100	99,00 Ms
M 10 x 25	K	100	112,00 Ms
M 10 x 30	K	100	121,00 Ms
M 10 x 35	K	100	134,00 Ms
M 10 x 40	K	100	149,00 Ms
M 10 x 45	K	100	160,00 Ms
M 10 x 50	K	100	170,00 Ms

ISO	01207.730
1207	Messing galvanisch vernickelt



Zylinderschrauben mit Schlitz

Maße → **TI-37** Normumstellung → **TI-11**
 Werkstoffeigensch. → **TI-239** REACH → **TI-262**

Stahl → **S. 205**
 Rostfrei → **S. 513**

ISO 1207 → ersetzt DIN 84 (austauschbar)



M 2,5 x 6	K	200	10,30 Ms Ni
M 2,5 x 8	K	200	9,50 Ms Ni
M 2,5 x 10	K	200	9,90 Ms Ni
M 2,5 x 16	K	200	11,80 Ms Ni
M 3 x 6	K	200	8,10 Ms Ni
M 3 x 8	K	200	8,10 Ms Ni
M 3 x 10	K	200	8,40 Ms Ni
M 3 x 12	K	200	8,90 Ms Ni
M 3 x 16	K	200	10,00 Ms Ni
M 3 x 20	K	200	11,20 Ms Ni
M 3 x 25	K	200	12,40 Ms Ni
M 3 x 30	K	200	15,20 Ms Ni
M 4 x 6	K	200	10,70 Ms Ni
M 4 x 8	K	200	11,30 Ms Ni
M 4 x 10	K	200	11,80 Ms Ni
M 4 x 12	K	200	12,10 Ms Ni
M 4 x 16	K	200	14,40 Ms Ni
M 4 x 20	K	200	16,70 Ms Ni
M 4 x 25	K	200	17,80 Ms Ni
M 4 x 30	K	200	21,00 Ms Ni
M 4 x 40	K	200	25,50 Ms Ni
M 5 x 10	K	200	17,80 Ms Ni
M 5 x 16	K	200	21,30 Ms Ni
M 5 x 20	K	200	23,40 Ms Ni

Abmessungen	VE	Stück	€/100/Obf.
M 5 x 30	K	200	30,50 Ms Ni
M 6 x 10	K	200	24,40 Ms Ni
M 6 x 16	K	200	31,50 Ms Ni
M 6 x 20	K	200	33,50 Ms Ni

ISO	01207.600
1207	Kunststoff PA

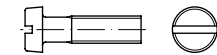

Zylinderschrauben mit Schlitz

Achtung! Grobe Toleranzen nach VDI 2544.

Muttern → **DIN 555**

Maße → **TI-37**

REACH → **TI-262**

Werkstoffeigensch. → **TI-239**

Stahl → **S. 205**

Rostfrei → **S. 513**

M 2,5 x 6	S	200	8,20 Kunstst
M 2,5 x 10	S	200	8,40 Kunstst
M 2,5 x 16	S	200	8,50 Kunstst
M 3 x 4	S	200	5,80 Kunstst
M 3 x 5	S	200	5,90 Kunstst
M 3 x 6	S	200	6,00 Kunstst
M 3 x 8	S	200	6,10 Kunstst
M 3 x 10	S	200	6,20 Kunstst
M 3 x 12	S	200	6,30 Kunstst
M 3 x 16	S	200	6,40 Kunstst
M 3 x 20	S	200	6,50 Kunstst
M 3 x 25	S	200	6,60 Kunstst
M 3 x 30	S	200	6,80 Kunstst
M 4 x 6	S	200	6,00 Kunstst
M 4 x 8	S	200	6,10 Kunstst
M 4 x 10	S	200	6,30 Kunstst
M 4 x 12	S	200	6,50 Kunstst
M 4 x 16	S	200	6,60 Kunstst
M 4 x 20	S	200	6,90 Kunstst
M 4 x 25	S	200	7,20 Kunstst
M 4 x 30	S	200	7,70 Kunstst
M 4 x 35	S	200	8,10 Kunstst
M 4 x 40	S	200	8,30 Kunstst
M 5 x 6	S	200	6,80 Kunstst
M 5 x 8	S	200	6,90 Kunstst
M 5 x 10	S	200	7,20 Kunstst
M 5 x 12	S	200	7,40 Kunstst
M 5 x 16	S	200	7,90 Kunstst
M 5 x 20	S	200	9,20 Kunstst
M 5 x 25	S	200	9,60 Kunstst
M 5 x 30	S	200	10,30 Kunstst
M 5 x 35	S	200	11,00 Kunstst
M 5 x 40	S	200	11,60 Kunstst
M 5 x 50	S	200	12,90 Kunstst
M 6 x 8	S	200	18,60 Kunstst
M 6 x 10	S	200	8,20 Kunstst
M 6 x 12	S	200	8,30 Kunstst
M 6 x 16	S	200	8,70 Kunstst
M 6 x 20	S	200	9,60 Kunstst
M 6 x 25	S	200	10,40 Kunstst
M 6 x 30	S	200	12,60 Kunstst
M 6 x 35	S	200	13,20 Kunstst
M 6 x 40	S	200	13,60 Kunstst
M 6 x 45	S	200	14,00 Kunstst
M 6 x 50	S	200	14,40 Kunstst
M 6 x 60	S	100	15,70 Kunstst
M 6 x 70	S	100	16,60 Kunstst
M 8 x 16	S	200	17,30 Kunstst
M 8 x 20	S	200	18,90 Kunstst

Abmessungen	VE	Stück	€/100/Obf.
M 8 x 25	S	200	20,10 Kunstst
M 8 x 30	S	200	21,60 Kunstst
M 8 x 40	S	100	23,90 Kunstst
M 8 x 50	S	100	25,50 Kunstst

ISO	01234.700
1234	Messing

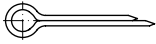

Splinte

Maße → **TI-22** Normumstellung → **TI-10**
 Werkstoffeigensch. → **TI-239** REACH → **TI-262**

Stahl → **S. 205**
 Rostfrei → **S. 513**

ISO 1234 → ersetzt DIN 94 (austauschbar)



Nenn Ø = Bohrungs Ø x Länge

1,6 x 10	S	200	12,80 Ms
1,6 x 12	S	200	12,90 Ms
1,6 x 16	S	200	13,00 Ms
1,6 x 20	S	200	13,20 Ms
1,6 x 25	S	200	14,10 Ms
2 x 10	S	100	15,40 Ms
2 x 12	S	100	15,60 Ms
2 x 16	S	100	15,80 Ms
2 x 20	S	100	16,00 Ms
2 x 25	S	100	17,00 Ms
2 x 32	S	100	18,90 Ms
2 x 40	S	100	20,70 Ms
2 x 50	S	100	30,00 Ms
3,2 x 16	S	100	22,30 Ms
3,2 x 20	S	100	23,40 Ms
3,2 x 25	S	100	26,00 Ms
3,2 x 32	S	100	30,00 Ms
3,2 x 36	S	100	32,00 Ms
3,2 x 40	S	100	34,00 Ms
3,2 x 50	S	100	39,00 Ms
3,2 x 63	S	100	46,00 Ms
4 x 20	S	100	33,00 Ms
4 x 25	S	100	37,50 Ms
4 x 32	S	100	43,00 Ms
4 x 36	S	100	46,50 Ms
4 x 40	S	100	50,00 Ms
4 x 50	S	100	59,00 Ms
4 x 63	S	100	69,00 Ms
5 x 32	S	100	62,00 Ms
5 x 36	S	100	66,00 Ms
5 x 40	S	100	72,00 Ms
5 x 50	S	100	84,00 Ms
5 x 63	S	100	103,00 Ms
6,3 x 50	S	100	124,00 Ms
6,3 x 63	S	50	154,00 Ms
6,3 x 100	S	50	223,00 Ms

Abmessungen	VE	Stück	€/100/Obf.
ISO	01234.301		
1234	Kupfer		

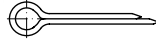

Splinte

Maße → **TI-22** Normumstellung → **TI-10**
 Werkstoffeigensch. → **TI-239**

Stahl → **S. 208**
 Rostfrei → **S. 516**

ISO 1234 → ersetzt DIN 94 (austauschbar)

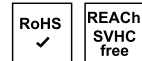

Nenn Ø = Bohrungs Ø x Länge

2 x 16	S	100	15,40 Cu
2 x 20	S	100	16,00 Cu
2 x 25	S	100	17,30 Cu
2 x 40	S	100	20,70 Cu
3,2 x 20	S	100	23,90 Cu
3,2 x 25	S	100	27,00 Cu
3,2 x 32	S	100	30,50 Cu
3,2 x 36	S	100	32,50 Cu
3,2 x 40	S	100	34,50 Cu
3,2 x 50	S	100	40,50 Cu
4 x 25	S	100	38,50 Cu
4 x 32	S	100	45,00 Cu
4 x 36	S	100	48,00 Cu
4 x 40	S	100	52,00 Cu
4 x 50	S	100	61,00 Cu
4 x 63	S	100	73,00 Cu
5 x 32	S	100	65,00 Cu
5 x 36	S	100	71,00 Cu
5 x 40	S	100	76,00 Cu
5 x 50	S	100	89,00 Cu
5 x 63	S	100	108,00 Cu
5 x 71	S	100	118,00 Cu
5 x 80	S	100	129,00 Cu
6,3 x 50	S	100	122,00 Cu
6,3 x 63	S	50	149,00 Cu
6,3 x 80	S	50	181,00 Cu

DIN	01476.700
1476	Messing

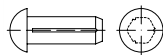

Halbrundkerbnägel

Maße → **TI-120** Normumstellung → **TI-10**
 Werkstoffeigensch. → **TI-239** REACH → **TI-262**

Stahl → **S. 213**
 Rostfrei → **S. 518**

DIN 1476 → wird ersetzt durch ISO 8746 (austauschbar)



2 x 3	K	200	16,00 Ms
2 x 4	S	1000	11,80 Ms
2 x 4	K	200	16,20 Ms

Abmessungen	VE	Stück	€/100/Obf.
2 x 5	S	1000	12,10 Ms
2 x 5	K	200	16,50 Ms
2 x 6	S	1000	12,40 Ms
2 x 6	K	200	16,70 Ms
2 x 8	K	200	18,10 Ms
3 x 5	K	200	21,80 Ms
3 x 6	S	1000	18,30 Ms
3 x 6	K	200	22,60 Ms
3 x 8	S	1000	19,70 Ms
3 x 8	K	200	24,20 Ms
3 x 10	S	1000	22,00 Ms
3 x 10	K	200	27,00 Ms
3 x 12	S	1000	24,70 Ms

DIN	01476.300
1476	Aluminium

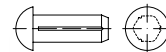

Halbrundkerbnägel

Maße → **TI-120** Normumstellung → **TI-10**
 Werkstoffeigensch. → **TI-239** REACH → **TI-262**

Stahl → **S. 213**
 Rostfrei → **S. 518**

DIN 1476 → wird ersetzt durch ISO 8746 (austauschbar)



1,4 x 4	S	500	2,20 Al
1,6 x 4	S	500	2,40 Al
1,6 x 5	S	500	2,40 Al
1,6 x 6	S	500	2,55 Al
2 x 3	S	500	2,45 Al
2 x 4	S	500	2,45 Al
2 x 5	S	500	2,45 Al
2 x 6	S	500	2,45 Al
2 x 8	S	500	2,55 Al
2 x 10	S	500	2,70 Al
2,3 x 5	S	500	2,70 Al
2,5 x 5	S	500	2,75 Al
2,5 x 6	S	500	2,75 Al
2,5 x 8	S	500	2,75 Al
3 x 4	S	500	3,15 Al
3 x 5	S	500	3,15 Al
3 x 6	S	500	3,15 Al
3 x 8	S	500	3,20 Al
3 x 10	S	500	3,45 Al
3 x 12	S	500	3,45 Al
4 x 6	S	500	5,10 Al
4 x 8	S	500	5,20 Al
4 x 10	S	500	5,20 Al
5 x 12	S	500	8,70 Al

Abmessungen	VE Stück	€/100/Obf.
ISO	01580.700	
1580 Messing		

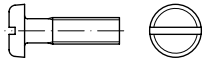

Flachkopfschrauben mit Schlitz

Maße → **TI-37** Normumstellung → **TI-11**
 Werkstoffeigensch. → **TI-239** REACH → **TI-262**

Stahl → **S. 220**
 Rostfrei → **S. 520**

ISO 1580 → ersetzt DIN 85 (austauschbar)



M 3	x	4	K	200	10,00 Ms
M 3	x	5	K	200	9,20 Ms
M 3	x	6	K	200	7,50 Ms
M 3	x	8	K	200	7,60 Ms
M 3	x	10	K	200	7,90 Ms
M 3	x	12	K	200	8,40 Ms
M 3	x	16	K	200	9,60 Ms
M 3	x	20	K	200	10,90 Ms
M 3	x	25	K	200	12,40 Ms
M 3	x	30	K	200	15,20 Ms
M 4	x	6	K	200	10,40 Ms
M 4	x	8	K	200	11,00 Ms
M 4	x	10	K	200	11,60 Ms
M 4	x	12	K	200	11,80 Ms
M 4	x	16	K	200	14,10 Ms
M 4	x	20	K	200	16,50 Ms
M 4	x	25	K	200	17,30 Ms
M 4	x	30	K	200	20,50 Ms
M 4	x	35	K	200	23,10 Ms
M 4	x	40	K	200	25,00 Ms
M 5	x	6	K	200	19,40 Ms
M 5	x	8	K	200	17,00 Ms
M 5	x	10	K	200	17,30 Ms
M 5	x	12	K	200	17,80 Ms
M 5	x	16	K	200	20,50 Ms
M 5	x	20	K	200	22,60 Ms
M 5	x	25	K	200	25,50 Ms
M 5	x	30	K	200	29,50 Ms
M 5	x	35	K	200	38,00 Ms
M 5	x	40	K	200	40,00 Ms
M 6	x	10	K	200	23,60 Ms
M 6	x	12	K	200	27,00 Ms
M 6	x	16	K	200	30,50 Ms
M 6	x	20	K	200	34,00 Ms
M 6	x	25	K	200	36,00 Ms
M 6	x	30	K	200	41,50 Ms
M 6	x	35	K	200	47,00 Ms
M 6	x	40	K	200	51,00 Ms

Abmessungen	VE Stück	€/100/Obf.
ISO	01580.600	
1580 Kunststoff PA		

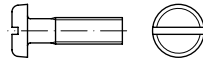

Flachkopfschrauben mit Schlitz

Achtung! Grobe Toleranzen nach VDI 2544.

Muttern → DIN 555

Maße → **TI-37** REACH → **TI-262**
 Werkstoffeigensch. → **TI-239**

Stahl → **S. 220**
 Rostfrei → **S. 520**

M 3	x	6	S	200	6,40 Kunstst
M 3	x	8	S	200	6,50 Kunstst
M 3	x	10	S	200	6,90 Kunstst
M 3	x	12	S	200	7,20 Kunstst
M 4	x	5	S	200	10,00 Kunstst
M 4	x	6	S	200	10,50 Kunstst
M 4	x	8	S	200	12,00 Kunstst
M 4	x	10	S	200	7,00 Kunstst
M 4	x	12	S	200	7,10 Kunstst
M 4	x	16	S	200	7,30 Kunstst
M 4	x	20	S	200	7,60 Kunstst
M 5	x	8	S	200	7,70 Kunstst
M 5	x	10	S	200	7,90 Kunstst
M 5	x	12	S	200	8,30 Kunstst
M 5	x	16	S	200	8,70 Kunstst
M 5	x	20	S	200	10,10 Kunstst
M 6	x	10	S	200	9,00 Kunstst
M 6	x	16	S	200	9,60 Kunstst
M 6	x	20	S	200	10,60 Kunstst
M 6	x	25	S	200	12,50 Kunstst
M 6	x	30	S	200	13,80 Kunstst

DIN	01587.700
1587 Messing	

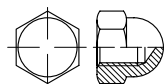

Sechskant-Hutmuttern, hohe Form

ab M 12 mit Rille oder entsprechender
 Einschraubtiefe t min.

Maße → **TI-63** REACH → **TI-262**
 Werkstoffeigensch. → **TI-239**

Stahl → **S. 221**
 Rostfrei → **S. 521**



M 3	S	1000	17,50 Ms
M 3	K	100	26,50 Ms
M 4	S	1000	19,10 Ms
M 4	K	100	28,00 Ms
M 5	S	500	24,20 Ms
M 5	K	100	33,00 Ms
M 6	S	500	35,00 Ms
M 6	K	100	44,50 Ms
M 8	S	250	79,00 Ms

Abmessungen	VE Stück	€/100/Obf.	
M 8	K	100	93,00 Ms
M 10 SW 17	S	100	149,00 Ms
M 12 SW 19	S	50	202,00 Ms
M 14 SW 22	S	50	365,00 Ms
M 16	S	25	425,00 Ms
M 18	S	25	1030,00 Ms
M 20	S	25	710,00 Ms
M 24	S	1	1460,00 Ms

DIN	01587.730
1587 Messing galvanisch vernickelt	

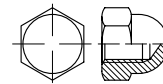

Sechskant-Hutmuttern, hohe Form

ab M 12 mit Rille oder entsprechender
 Einschraubtiefe t min.

Maße → **TI-63** REACH → **TI-262**
 Werkstoffeigensch. → **TI-239**

Stahl → **S. 221**
 Rostfrei → **S. 521**



M 3	S	100	28,00 gal Ni
M 4	S	100	29,00 gal Ni
M 5	S	100	34,50 gal Ni
M 6	S	100	48,00 gal Ni
M 8	S	100	100,00 gal Ni
M 10 SW 17	S	100	162,00 gal Ni
M 12 SW 19	S	50	215,00 gal Ni

DIN	01587.740
1587 Messing galvanisch verchromt	



Sechskant-Hutmuttern, hohe Form

ab M 12 mit Rille oder entsprechender
 Einschraubtiefe t min.

Maße → **TI-63** REACH → **TI-262**
 Werkstoffeigensch. → **TI-239**

Stahl → **S. 221**
 Rostfrei → **S. 521**



M 3	K	100	37,50 Ms Gr
M 4	S	1000	38,00 Ms Gr
M 4	K	100	45,50 Ms Gr
M 5	S	500	42,00 Ms Gr
M 5	K	100	49,00 Ms Gr
M 6	S	500	54,00 Ms Gr
M 6	K	100	65,00 Ms Gr
M 8	S	250	112,00 Ms Gr
M 8	K	100	128,00 Ms Gr
M 10 SW 17	S	100	207,00 Ms Gr
M 12 SW 19	S	50	300,00 Ms Gr

Abmessungen	VE	Stück	€/100/Obf.
M 14	S	50	400,00 Ms Cr
M 16	S	25	730,00 Ms Cr
M 20	S	25	1000,00 Ms Cr

DIN	01587.600
1587	Kunststoff PA

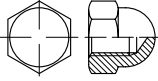

Sechskant-Hutmuttern, hohe Form

Achtung! Grobe Toleranzen nach VDI 2544

Maße → **TI-63** REACH → **TI-262**

Werkstoffeigensch. → **TI-239**

Stahl → **S. 221**

Rostfrei → **S. 521**

M 3	S	100	12,50 Kunstst
M 4	S	100	15,00 Kunstst
M 5	S	100	17,00 Kunstst
M 6	S	100	18,50 Kunstst
M 8	S	100	23,00 Kunstst
M 10 SW 17	S	100	42,00 Kunstst
M 12 SW 19	S	100	47,50 Kunstst
M 16	S	100	285,00 Kunstst

ISO	02009.704
2009	Messing blank gedreht

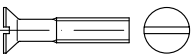

Senkschrauben mit Schlitz

Maße → **TI-27** Normumstellung → **TI-11**

Werkstoffeigensch. → **TI-239** REACH → **TI-262**

Stahl → **S. 225**

Rostfrei → **S. 522**

ISO 2009 → ersetzt DIN 963



M 1,6 x 4	S	100	27,00 Ms gedr
M 1,6 x 6	S	100	28,00 Ms gedr
M 1,6 x 10	S	100	36,00 Ms gedr

Abmessungen	VE	Stück	€/100/Obf.
ISO	02009.700		
2009	Messing		

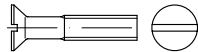

Senkschrauben mit Schlitz

Maße → **TI-27**

Normumstellung → **TI-11**

Werkstoffeigensch. → **TI-239**

REACH → **TI-262**

Stahl → **S. 225**

Rostfrei → **S. 522**

ISO 2009 → ersetzt DIN 963



M 2 x 4	K	200	11,30 Ms
M 2 x 5	K	200	10,40 Ms
M 2 x 6	K	200	9,50 Ms
M 2 x 8	K	200	8,40 Ms
M 2 x 10	K	200	8,80 Ms
M 2 x 12	K	200	9,30 Ms
M 2 x 16	K	200	10,70 Ms
M 2 x 20	K	200	12,00 Ms
M 2,5 x 4	K	200	11,60 Ms
M 2,5 x 5	K	200	10,10 Ms
M 2,5 x 6	K	200	8,70 Ms
M 2,5 x 8	K	200	8,40 Ms
M 2,5 x 10	K	200	8,80 Ms
M 2,5 x 12	K	200	9,30 Ms
M 2,5 x 16	K	200	10,70 Ms
M 2,5 x 18	K	200	18,10 Ms
M 2,5 x 20	K	200	12,00 Ms
M 3 x 4	S	1000	8,70 Ms
M 3 x 4	K	200	8,70 Ms
M 3 x 5	K	200	8,10 Ms
M 3 x 6	S	1000	6,90 Ms
M 3 x 6	K	200	6,90 Ms
M 3 x 8	S	1000	7,10 Ms
M 3 x 8	K	200	7,10 Ms
M 3 x 10	S	1000	7,30 Ms
M 3 x 10	K	200	7,30 Ms
M 3 x 12	S	1000	7,70 Ms
M 3 x 12	K	200	7,70 Ms
M 3 x 16	S	1000	8,80 Ms
M 3 x 16	K	200	8,80 Ms
M 3 x 18	K	200	15,20 Ms
M 3 x 20	S	1000	10,10 Ms
M 3 x 20	K	200	10,10 Ms
M 3 x 25	K	200	11,30 Ms
M 3 x 30	K	200	13,80 Ms
M 3 x 35	K	200	14,60 Ms
M 3 x 40	K	200	20,70 Ms
M 4 x 5	K	200	10,70 Ms
M 4 x 6	S	1000	9,50 Ms
M 4 x 6	K	200	9,50 Ms
M 4 x 8	S	1000	10,30 Ms
M 4 x 8	K	200	10,30 Ms
M 4 x 10	S	1000	10,70 Ms
M 4 x 10	K	200	10,70 Ms
M 4 x 12	S	1000	10,90 Ms
M 4 x 12	K	200	10,90 Ms
M 4 x 16	S	1000	13,00 Ms
M 4 x 16	K	200	13,00 Ms
M 4 x 18	K	200	22,60 Ms
M 4 x 20	S	1000	15,20 Ms
M 4 x 20	K	200	15,20 Ms
M 4 x 25	S	1000	16,00 Ms
M 4 x 25	K	200	16,00 Ms

Abmessungen	VE	Stück	€/100/Obf.
M 4 x 30	S	1000	18,90 Ms
M 4 x 30	K	200	18,90 Ms
M 4 x 35	K	200	21,00 Ms
M 4 x 40	K	200	22,80 Ms
M 4 x 45	K	200	28,50 Ms
M 4 x 50	K	200	30,50 Ms
M 5 x 8	K	200	15,70 Ms
M 5 x 10	S	1000	16,00 Ms
M 5 x 10	K	200	16,00 Ms
M 5 x 12	S	1000	16,50 Ms
M 5 x 12	K	200	16,50 Ms
M 5 x 16	S	1000	18,90 Ms
M 5 x 16	K	200	18,90 Ms
M 5 x 18	K	200	30,50 Ms
M 5 x 20	S	1000	20,50 Ms
M 5 x 20	K	200	20,50 Ms
M 5 x 25	S	1000	23,10 Ms
M 5 x 25	K	200	23,10 Ms
M 5 x 30	S	1000	27,00 Ms
M 5 x 30	K	200	27,00 Ms
M 5 x 35	K	200	34,50 Ms
M 5 x 40	K	200	36,50 Ms
M 5 x 45	K	200	39,50 Ms
M 5 x 50	K	200	42,00 Ms
M 5 x 60	K	200	54,00 Ms
M 6 x 10	S	1000	21,50 Ms
M 6 x 10	K	200	21,50 Ms
M 6 x 12	S	1000	24,20 Ms
M 6 x 12	K	200	24,20 Ms
M 6 x 16	S	1000	28,00 Ms
M 6 x 16	K	200	28,00 Ms
M 6 x 20	S	1000	30,50 Ms
M 6 x 20	K	200	30,50 Ms
M 6 x 25	S	1000	32,50 Ms
M 6 x 25	K	200	32,50 Ms
M 6 x 30	K	200	37,50 Ms
M 6 x 35	K	200	43,00 Ms
M 6 x 40	K	200	46,50 Ms
M 6 x 45	K	200	54,00 Ms
M 6 x 50	K	200	56,00 Ms
M 6 x 60	K	100	72,00 Ms
M 6 x 70	K	100	83,00 Ms
M 6 x 80	K	100	89,00 Ms
M 8 x 12	K	100	71,00 Ms
M 8 x 16	K	100	61,00 Ms
M 8 x 20	K	100	65,00 Ms
M 8 x 25	K	100	68,00 Ms
M 8 x 30	K	100	79,00 Ms
M 8 x 35	K	100	84,00 Ms
M 8 x 40	K	100	89,00 Ms
M 8 x 45	K	100	104,00 Ms
M 8 x 50	K	100	110,00 Ms
M 8 x 60	K	100	132,00 Ms
M 8 x 70	K	100	162,00 Ms
M 8 x 80	K	100	173,00 Ms
M 10 x 16	K	100	99,00 Ms
M 10 x 20	K	100	96,00 Ms
M 10 x 25	K	100	109,00 Ms
M 10 x 30	K	100	118,00 Ms
M 10 x 35	K	100	132,00 Ms
M 10 x 40	K	100	146,00 Ms
M 10 x 45	K	100	157,00 Ms
M 10 x 50	K	100	167,00 Ms
M 10 x 60	K	100	189,00 Ms
M 10 x 70	K	100	244,00 Ms
M 10 x 80	K	100	270,00 Ms
M 12 x 20	K	50	290,00 Ms
M 12 x 25	K	50	295,00 Ms
M 12 x 30	K	50	330,00 Ms
M 12 x 35	K	50	360,00 Ms
M 12 x 40	K	50	390,00 Ms
M 12 x 45	K	50	420,00 Ms
M 12 x 50	K	50	455,00 Ms
M 12 x 70	K	50	590,00 Ms
M 16 x 25	K	25	1170,00 Ms

Abmessungen	VE	Stück	€/100/Obf.
M 16 x 30	K	25	1170,00 Ms
M 16 x 35	K	25	1260,00 Ms
M 16 x 40	K	25	1360,00 Ms
M 16 x 45	K	25	1460,00 Ms
M 16 x 50	K	25	1570,00 Ms

ISO	02009.730
2009	Messing galvanisch vernickelt

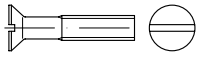

Senkschrauben mit Schlitz

Maße → **TI-27** Normumstellung → **TI-11**
 Werkstoffeigensch. → **TI-239** REACH → **TI-262**
 Stahl → **S. 225**
 Rostfrei → **S. 522**
 ISO 2009 → ersetzt DIN 963



M 3 x 10	K	200	8,40 gal Ni
M 3 x 16	K	200	10,00 gal Ni
M 3 x 20	K	200	11,20 gal Ni
M 3 x 30	K	200	14,90 gal Ni
M 4 x 10	K	200	11,80 gal Ni
M 4 x 16	K	200	14,10 gal Ni
M 4 x 20	K	200	16,50 gal Ni
M 4 x 30	K	200	20,70 gal Ni
M 5 x 10	K	200	17,00 gal Ni
M 5 x 16	K	200	20,50 gal Ni
M 5 x 20	K	200	22,60 gal Ni
M 6 x 10	K	200	23,40 gal Ni
M 6 x 16	K	200	30,50 gal Ni
M 6 x 20	K	200	34,00 gal Ni

ISO	02009.600
2009	Kunststoff PA

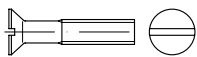

Senkschrauben mit Schlitz

Achtung! Grobe Toleranzen nach VDI 2544.
 Muttern → DIN 555
 Maße → **TI-27** REACH → **TI-262**
 Werkstoffeigensch. → **TI-239**
 Stahl → **S. 225**
 Rostfrei → **S. 522**

M 3 x 6	S	200	5,50 Kunstst
M 3 x 8	S	200	5,70 Kunstst
M 3 x 10	S	200	5,90 Kunstst
M 3 x 12	S	200	6,00 Kunstst
M 3 x 16	S	200	6,10 Kunstst
M 3 x 20	S	200	6,40 Kunstst
M 4 x 10	S	200	6,80 Kunstst
M 4 x 12	S	200	7,10 Kunstst
M 4 x 16	S	200	7,20 Kunstst
M 4 x 20	S	200	7,50 Kunstst
M 4 x 25	S	200	7,80 Kunstst

Abmessungen	VE	Stück	€/100/Obf.
M 4 x 30	S	200	8,20 Kunstst
M 5 x 10	S	200	7,30 Kunstst
M 5 x 12	S	200	7,80 Kunstst
M 5 x 16	S	200	8,50 Kunstst
M 5 x 20	S	200	9,40 Kunstst
M 5 x 25	S	200	10,00 Kunstst
M 6 x 10	S	200	8,20 Kunstst
M 6 x 12	S	200	9,00 Kunstst
M 6 x 16	S	200	9,50 Kunstst
M 6 x 20	S	200	10,50 Kunstst
M 6 x 25	S	200	12,00 Kunstst
M 6 x 30	S	200	13,00 Kunstst
M 8 x 16	S	200	17,40 Kunstst
M 8 x 20	S	200	18,50 Kunstst
M 8 x 25	S	200	20,60 Kunstst
M 8 x 30	S	200	23,50 Kunstst
M 8 x 40	S	200	27,50 Kunstst

ISO	02010.700
2010	Messing



Linsensenkschrauben mit Schlitz

Maße → **TI-39** Normumstellung → **TI-11**
 Werkstoffeigensch. → **TI-239** REACH → **TI-262**
 Stahl → **S. 227**
 Rostfrei → **S. 524**
 ISO 2010 → ersetzt DIN 964



M 3 x 5	K	200	8,10 Ms
M 3 x 6	K	200	6,90 Ms
M 3 x 8	K	200	7,10 Ms
M 3 x 10	K	200	7,30 Ms
M 3 x 12	K	200	7,70 Ms
M 3 x 16	K	200	8,80 Ms
M 3 x 20	K	200	10,10 Ms
M 3 x 25	K	200	11,30 Ms
M 3 x 30	K	200	13,80 Ms
M 3 x 35	K	200	14,60 Ms
M 3 x 40	K	200	20,70 Ms
M 4 x 5	K	200	10,70 Ms
M 4 x 6	K	200	9,50 Ms
M 4 x 8	K	200	10,30 Ms
M 4 x 10	K	200	10,70 Ms
M 4 x 12	K	200	10,90 Ms
M 4 x 16	K	200	13,00 Ms
M 4 x 20	K	200	15,20 Ms
M 4 x 25	K	200	16,00 Ms
M 4 x 30	K	200	18,90 Ms
M 4 x 35	K	200	21,00 Ms
M 4 x 40	K	200	22,80 Ms
M 4 x 45	K	200	28,50 Ms
M 4 x 50	K	200	29,50 Ms
M 4 x 60	K	200	54,00 Ms
M 5 x 8	K	200	15,70 Ms
M 5 x 10	K	200	16,00 Ms
M 5 x 12	K	200	16,50 Ms
M 5 x 16	K	200	18,90 Ms
M 5 x 20	K	200	20,70 Ms
M 5 x 25	K	200	23,10 Ms
M 5 x 30	K	200	27,00 Ms
M 5 x 35	K	200	34,50 Ms
M 5 x 40	K	200	36,50 Ms
M 5 x 45	K	200	39,50 Ms

Abmessungen	VE	Stück	€/100/Obf.
M 5 x 50	K	200	42,00 Ms
M 5 x 60	K	200	54,00 Ms
M 5 x 70	K	200	66,00 Ms
M 5 x 80	K	200	83,00 Ms
M 5 x 100	K	200	136,00 Ms
M 6 x 8	K	200	27,00 Ms
M 6 x 10	K	200	21,50 Ms
M 6 x 12	K	200	24,20 Ms
M 6 x 16	K	200	28,00 Ms
M 6 x 20	K	200	30,50 Ms
M 6 x 25	K	200	32,50 Ms
M 6 x 30	K	200	37,50 Ms
M 6 x 35	K	200	43,00 Ms
M 6 x 40	K	200	46,50 Ms
M 6 x 45	K	200	54,00 Ms
M 6 x 50	K	200	56,00 Ms
M 6 x 60	K	100	72,00 Ms
M 6 x 70	K	100	83,00 Ms
M 6 x 80	K	100	89,00 Ms
M 6 x 100	S	100	100,00 Ms
M 8 x 16	K	100	61,00 Ms
M 8 x 20	K	100	65,00 Ms
M 8 x 25	K	100	68,00 Ms
M 8 x 30	K	100	79,00 Ms
M 8 x 35	K	100	84,00 Ms
M 8 x 40	K	100	89,00 Ms
M 8 x 50	K	100	110,00 Ms
M 8 x 60	K	100	132,00 Ms

ISO	02010.730
2010	Messing galvanisch vernickelt



Linsensenkschrauben mit Schlitz

Maße → **TI-39** Normumstellung → **TI-11**
 Werkstoffeigensch. → **TI-239** REACH → **TI-262**
 Stahl → **S. 227**
 Rostfrei → **S. 524**
 ISO 2010 → ersetzt DIN 964



M 3 x 8	K	200	8,10 Ms Ni
M 3 x 10	K	200	8,40 Ms Ni
M 3 x 12	K	200	8,90 Ms Ni
M 3 x 16	K	200	10,00 Ms Ni
M 3 x 20	K	200	11,20 Ms Ni
M 3 x 25	K	200	12,40 Ms Ni
M 4 x 8	K	200	11,30 Ms Ni
M 4 x 10	K	200	11,80 Ms Ni
M 4 x 12	K	200	12,00 Ms Ni
M 4 x 16	K	200	14,40 Ms Ni
M 4 x 20	K	200	16,50 Ms Ni
M 4 x 25	K	200	17,50 Ms Ni
M 4 x 30	K	200	20,70 Ms Ni
M 4 x 35	K	200	23,40 Ms Ni
M 4 x 40	K	200	25,50 Ms Ni
M 4 x 45	K	200	29,50 Ms Ni
M 4 x 50	K	200	33,50 Ms Ni
M 4 x 60	K	200	59,00 Ms Ni
M 5 x 10	K	200	17,30 Ms Ni
M 5 x 12	K	200	18,10 Ms Ni
M 5 x 16	K	200	20,70 Ms Ni
M 5 x 20	K	200	22,80 Ms Ni
M 5 x 25	K	200	26,00 Ms Ni
M 5 x 30	K	200	30,00 Ms Ni

Abmessungen	VE	Stück	€/100/Obf.
M 5 x 35	K	200	38,00 Ms Ni
M 5 x 40	K	200	40,50 Ms Ni
M 5 x 45	K	200	44,00 Ms Ni
M 5 x 50	K	200	47,00 Ms Ni
M 5 x 60	K	200	59,00 Ms Ni
M 5 x 70	K	200	73,00 Ms Ni
M 5 x 80	K	200	91,00 Ms Ni
M 6 x 10	K	200	23,60 Ms Ni
M 6 x 12	K	200	27,00 Ms Ni
M 6 x 16	K	200	30,50 Ms Ni
M 6 x 20	K	200	34,00 Ms Ni
M 6 x 25	K	200	35,00 Ms Ni
M 6 x 30	K	200	42,50 Ms Ni
M 6 x 35	K	200	48,00 Ms Ni
M 6 x 40	K	200	53,00 Ms Ni
M 6 x 45	K	200	60,00 Ms Ni
M 6 x 50	K	200	63,00 Ms Ni
M 6 x 60	K	100	80,00 Ms Ni
M 6 x 70	K	100	92,00 Ms Ni
M 6 x 80	K	100	101,00 Ms Ni

ISO	02010.740
2010	Messing galvanisch verchromt



Linsensenschrauben mit Schlitz

Maße → **TI-39** Normumstellung → **TI-11**
 Werkstoffeigensch. → **TI-239** REACH → **TI-262**

Stahl → **S. 227**
 Rostfrei → **S. 524**

ISO 2010 → ersetzt DIN 964



M 3 x 8	K	200	13,80 Ms Cr
M 3 x 10	K	200	15,20 Ms Cr
M 3 x 12	K	200	16,50 Ms Cr
M 3 x 16	K	200	19,40 Ms Cr
M 3 x 20	K	200	22,80 Ms Cr
M 3 x 30	K	200	31,50 Ms Cr
M 4 x 8	K	200	17,30 Ms Cr
M 4 x 10	K	200	18,30 Ms Cr
M 4 x 12	K	200	19,40 Ms Cr
M 4 x 16	K	200	23,40 Ms Cr
M 4 x 20	K	200	27,50 Ms Cr
M 4 x 25	K	200	30,50 Ms Cr
M 4 x 30	K	200	36,00 Ms Cr
M 4 x 35	K	200	40,50 Ms Cr
M 4 x 40	K	200	44,50 Ms Cr
M 4 x 45	K	200	52,00 Ms Cr
M 4 x 50	K	200	57,00 Ms Cr
M 4 x 60	K	200	85,00 Ms Cr
M 5 x 10	K	200	28,00 Ms Cr
M 5 x 12	K	200	30,00 Ms Cr
M 5 x 16	K	200	36,00 Ms Cr
M 5 x 20	K	200	40,50 Ms Cr
M 5 x 25	K	200	47,00 Ms Cr
M 5 x 30	K	200	54,00 Ms Cr
M 5 x 35	K	200	65,00 Ms Cr
M 5 x 40	K	200	72,00 Ms Cr
M 5 x 50	K	200	85,00 Ms Cr
M 5 x 60	K	200	104,00 Ms Cr
M 5 x 70	K	200	125,00 Ms Cr
M 6 x 10	K	200	40,00 Ms Cr
M 6 x 16	K	200	54,00 Ms Cr
M 6 x 20	K	200	60,00 Ms Cr

Abmessungen	VE	Stück	€/100/Obf.
M 6 x 25	K	200	69,00 Ms Cr
M 6 x 30	K	200	79,00 Ms Cr
M 6 x 35	K	200	89,00 Ms Cr
M 6 x 40	K	200	99,00 Ms Cr
M 6 x 50	K	200	118,00 Ms Cr
M 6 x 60	K	100	146,00 Ms Cr
M 6 x 80	K	100	186,00 Ms Cr
M 8 x 20	K	100	112,00 Ms Cr
M 8 x 25	K	100	122,00 Ms Cr

DIN	03404.700
3404	Messing MF



Flachschmiernippel, mit rundem Kopf/Sechskant-Antrieb, MF = mit metrischem Feingewinde

Maße → **TI-25** REACH → **TI-262**
 Werkstoffeigensch. → **TI-239**

Stahl → **S. 234**



Gewinde M x Steigung – Schlüsselweite

M 10	x	1 SW 17	S	100	930,00 Ms
------	---	---------	---	-----	-----------

ISO	04014.700
4014	Messing



Sechskantschrauben mit Schaft

*M 10/12/14/22 = RAZ 3210 übrige Ø = RAZ 400

Maße → **TI-15** Normumstellung → **TI-6**
 Werkstoffeigensch. → **TI-239** REACH → **TI-262**
 Anziehmomente → **TI-250**

Stahl → **S. 236**
 Rostfrei → **S. 529**

ISO 4014 → ersetzt DIN 931



M 8 x 40	S	100	270,00 Ms
M 8 x 50	S	100	320,00 Ms
M 8 x 60	S	100	370,00 Ms
M 10 x 50	S	100	680,00 Ms
M 10 x 60	S	100	870,00 Ms
M 12 x 50	S	50	830,00 Ms
M 12 x 60	S	50	1050,00 Ms
M 12 x 70	S	50	1210,00 Ms

Abmessungen	VE	Stück	€/100/Obf.
ISO	04017.700		
4017	Messing		



Sechskantschrauben mit Gewinde bis Kopf

*M 10/12/14/22 = RAZ 3210 übrige Ø = RAZ 400

Maße → **TI-15** Normumstellung → **TI-6**
 Werkstoffeigensch. → **TI-239** REACH → **TI-262**
 Anziehmomente → **TI-250**

Stahl → **S. 254**
 Rostfrei → **S. 534**

ISO 4017 → ersetzt DIN 933



M 4 x 6	S	100	25,50 Ms
M 4 x 8	S	100	12,80 Ms
M 4 x 10	S	100	12,80 Ms
M 4 x 12	S	100	14,10 Ms
M 4 x 16	S	100	15,20 Ms
M 4 x 20	S	100	16,70 Ms
M 4 x 25	S	100	19,10 Ms
M 4 x 30	S	100	21,80 Ms
M 4 x 35	S	100	24,40 Ms
M 4 x 40	S	100	27,00 Ms
M 4 x 50	S	100	42,50 Ms
M 4 x 60	S	100	48,00 Ms
M 5 x 8	S	100	17,50 Ms
M 5 x 10	S	100	17,50 Ms
M 5 x 12	S	100	19,40 Ms
M 5 x 16	S	100	21,00 Ms
M 5 x 20	S	100	23,90 Ms
M 5 x 25	S	100	27,50 Ms
M 5 x 30	S	100	30,00 Ms
M 5 x 35	S	100	33,50 Ms
M 5 x 40	S	100	34,50 Ms
M 5 x 45	S	100	47,50 Ms
M 5 x 50	S	100	43,00 Ms
M 5 x 60	S	100	56,00 Ms
M 6 x 8	S	100	27,00 Ms
M 6 x 10	S	100	27,00 Ms
M 6 x 12	S	100	27,50 Ms
M 6 x 16	S	100	30,00 Ms
M 6 x 20	S	100	33,00 Ms
M 6 x 25	S	100	37,00 Ms
M 6 x 30	S	100	41,00 Ms
M 6 x 35	S	100	45,00 Ms
M 6 x 40	S	100	49,50 Ms
M 6 x 45	S	100	59,00 Ms
M 6 x 50	S	100	59,00 Ms
M 6 x 60	S	100	76,00 Ms
M 8 x 10	S	100	59,00 Ms
M 8 x 12	S	100	61,00 Ms
M 8 x 16	S	100	65,00 Ms
M 8 x 20	S	100	71,00 Ms
M 8 x 25	S	100	80,00 Ms
M 8 x 30	S	100	88,00 Ms
M 8 x 35	S	100	95,00 Ms
M 8 x 40	S	100	103,00 Ms
M 8 x 45	S	100	118,00 Ms
M 8 x 50	S	100	118,00 Ms
M 8 x 55	S	100	130,00 Ms
M 8 x 60	S	100	130,00 Ms
M 8 x 65	S	100	157,00 Ms

Abmessungen	VE	Stück	€/100/Obf.
M 8 x 70	S	100	157,00 Ms
M 8 x 80	S	100	173,00 Ms
M 8 x 90	S	100	191,00 Ms
M 10 x 10	S	100	395,00 Ms
M 10 x 12	S	100	132,00 Ms
M 10 x 16	S	100	120,00 Ms
M 10 x 20	S	100	113,00 Ms
M 10 x 25	S	100	141,00 Ms
M 10 x 30	S	100	149,00 Ms
M 10 x 35	S	100	162,00 Ms
M 10 x 40	S	100	173,00 Ms
M 10 x 45	S	100	197,00 Ms
M 10 x 50	S	100	197,00 Ms
M 10 x 60	S	100	220,00 Ms
M 10 x 65	S	100	255,00 Ms
M 10 x 70	S	100	255,00 Ms
M 10 x 80	S	100	295,00 Ms
M 10 x 100	S	50	400,00 Ms
M 12 x 16	S	50	183,00 Ms
M 12 x 20	S	50	194,00 Ms
M 12 x 25	S	50	215,00 Ms
M 12 x 30	S	50	223,00 Ms
M 12 x 35	S	50	247,00 Ms
M 12 x 40	S	50	260,00 Ms
M 12 x 45	S	50	280,00 Ms
M 12 x 50	S	50	280,00 Ms
M 12 x 55	S	50	290,00 Ms
M 12 x 60	S	50	290,00 Ms
M 12 x 70	S	50	340,00 Ms
M 12 x 80	S	50	405,00 Ms
M 12 x 90	S	50	460,00 Ms
M 12 x 100	S	50	530,00 Ms
M 16 x 20	S	50	660,00 Ms
M 16 x 25	S	50	720,00 Ms
M 16 x 30	S	50	790,00 Ms
M 16 x 35	S	50	870,00 Ms
M 16 x 40	S	50	970,00 Ms
M 16 x 45	S	25	1040,00 Ms
M 16 x 50	S	25	1100,00 Ms
M 16 x 55	S	25	1170,00 Ms
M 16 x 60	S	10	1260,00 Ms
M 16 x 65	S	10	1360,00 Ms
M 16 x 70	S	10	1440,00 Ms
M 16 x 80	S	10	1570,00 Ms
M 16 x 90	S	10	1780,00 Ms
M 16 x 100	S	10	1910,00 Ms
M 20 x 30	S	10	1360,00 Ms
M 20 x 40	S	10	1490,00 Ms
M 20 x 50	S	10	1730,00 Ms
M 20 x 60	S	10	2020,00 Ms
M 20 x 80	S	1	2600,00 Ms
M 20 x 100	S	1	3200,00 Ms

Abmessungen	VE	Stück	€/100/Obf.
ISO			04032.700
4032			Messing

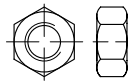

Sechskantmuttern, ISO-Typ 1

*M 5 - M 39 = RAZ 3310 übrige Ø = RAZ 410

Maße → TI-62 Normumstellung → TI-7
 Werkstoffeigensch. → TI-239 REACH → TI-262
 Anziehmomente → TI-250

Stahl → S. 278
 Rostfrei → S. 544

ISO 4032 → ersetzt DIN 934



M 1	K	100	68,00 Ms
M 1,2	K	100	45,00 Ms
M 1,4	K	100	43,00 Ms
M 1,6	K	100	30,50 Ms
M 1,7	K	100	29,50 Ms
M 2	S	1000	3,85 Ms
M 2	K	100	8,00 Ms
M 2,3	S	1000	3,85 Ms
M 2,3	K	100	8,00 Ms
M 2,5	S	1000	3,85 Ms
M 2,5	K	100	8,00 Ms
M 2,6	S	1000	3,85 Ms
M 2,6	K	100	8,00 Ms
M 3	S	1000	3,85 Ms
M 3	K	100	8,00 Ms
M 3,5	K	100	9,20 Ms
M 4	S	1000	5,70 Ms
M 4	K	100	9,70 Ms
M 5	S	1000	7,20 Ms
M 6	S	1000	10,90 Ms
M 8	S	1000	21,50 Ms
M 10	S	500	41,50 Ms
M 12	S	250	66,00 Ms
M 14	S	100	107,00 Ms
M 16	S	100	125,00 Ms
M 18	S	25	247,00 Ms
M 20	S	25	310,00 Ms
M 22	S	10	510,00 Ms
M 24	S	10	570,00 Ms
M 27	S	10	880,00 Ms
M 30	S	10	1070,00 Ms
M 33	S	5	2440,00 Ms
M 36	S	5	2440,00 Ms
M 42	S	1	6600,00 Ms

Abmessungen	VE	Stück	€/100/Obf.
ISO			04032.730
4032			Messing galvanisch vernickelt

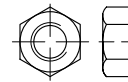

Sechskantmuttern, ISO-Typ 1

*M 5 - M 39 = RAZ 3310 übrige Ø = RAZ 410

Maße → TI-62 Normumstellung → TI-7
 Werkstoffeigensch. → TI-239 REACH → TI-262
 Anziehmomente → TI-250

Stahl → S. 278
 Rostfrei → S. 544

ISO 4032 → ersetzt DIN 934



M 2	S	1000	4,55 Ms Ni
M 2,5	S	1000	4,65 Ms Ni
M 3	S	1000	4,65 Ms Ni
M 3,5	S	1000	4,80 Ms Ni
M 4	S	1000	6,90 Ms Ni
M 5	S	1000	8,80 Ms Ni
M 6	S	1000	16,00 Ms Ni
M 8	S	100	34,50 Ms Ni
M 10	S	100	67,00 Ms Ni
M 12	S	100	120,00 Ms Ni
M 16	S	250	170,00 Ms Ni

Abmessungen	VE	Stück	€/100/Obf.
ISO			04032.740
4032			Messing galvanisch verchromt



Sechskantmuttern, ISO-Typ 1

*M 5 - M 39 = RAZ 3310 übrige Ø = RAZ 410

Maße → TI-62 Normumstellung → TI-7
 Werkstoffeigensch. → TI-239 REACH → TI-262
 Anziehmomente → TI-250

Stahl → S. 278
 Rostfrei → S. 544

ISO 4032 → ersetzt DIN 934



M 3	S	100	16,70 Ms Cr
M 4	S	100	20,70 Ms Cr
M 5	S	100	30,50 Ms Cr
M 6	S	100	37,00 Ms Cr
M 8	S	100	63,00 Ms Cr

- ✓ Große Artikelvielfalt
- ✓ Verlässliche Qualität
- ✓ Hohe Lieferbereitschaft

Abmessungen	VE Stück	€/100/Obf.
ISO	04032.302	
4032	CuNiSi	

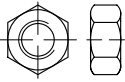

Sechskantmuttern, ISO-Typ 1

*M 5 - M 39 = RAZ 3310 übrige Ø = RAZ 410

Maße → [TI-62](#) Normumstellung → [TI-7](#)
 Werkstoffeigensch. → [TI-239](#)
 Stahl → [S. 278](#)
 Rostfrei → [S. 544](#)

ISO 4032 → ersetzt DIN 934

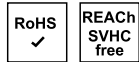

M 6	S	100	71,00 CuNiSi
M 8	S	100	138,00 CuNiSi
M 10	S	100	228,00 CuNiSi
M 12	S	100	360,00 CuNiSi
M 16	S	100	710,00 CuNiSi
M 20	S	25	1750,00 CuNiSi
M 24	S	25	3350,00 CuNiSi

ISO	04032.303
4032	Aluminium

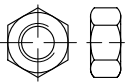

Sechskantmuttern, ISO-Typ 1

*M 5 - M 39 = RAZ 3310 übrige Ø = RAZ 410

Maße → [TI-62](#) Normumstellung → [TI-7](#)
 Werkstoffeigensch. → [TI-239](#) REACH → [TI-262](#)
 Stahl → [S. 278](#)
 Rostfrei → [S. 544](#)

ISO 4032 → ersetzt DIN 934



M 4	S	100	6,50 Al
M 5	S	100	8,40 Al
M 6	S	100	10,00 Al
M 8	S	100	20,30 Al
M 10	S	100	38,50 Al
M 12	S	50	53,00 Al
M 16	S	50	104,00 Al

Abmessungen	VE Stück	€/100/Obf.
ISO	04032.305	
4032	Titan (Grade 2)	

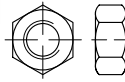

Sechskantmuttern, ISO-Typ 1

*M 5 - M 39 = RAZ 3310 übrige Ø = RAZ 410

Maße → [TI-62](#) Normumstellung → [TI-7](#)
 Werkstoffeigensch. → [TI-239](#)
 Stahl → [S. 278](#)
 Rostfrei → [S. 544](#)

ISO 4032 → ersetzt DIN 934



M 6	S	50	490,00 Ti
M 8	S	50	660,00 Ti
M 10	S	50	1010,00 Ti
M 12	S	25	1300,00 Ti
M 16	S	25	4300,00 Ti

ISO	04035.700
4035	Messing

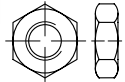

Sechskantmuttern, niedrige Form, mit Fasen

*M 5 - M 39 = RAZ 3370 übrige Ø = RAZ 170

Maße → [TI-61](#) Normumstellung → [TI-7](#)
 Werkstoffeigensch. → [TI-239](#) REACH → [TI-262](#)
 Stahl → [S. 284](#)
 Rostfrei → [S. 547](#)

ISO 4035 → ersetzt DIN 439 Form B



M 2	S	1000	3,85 Ms
M 2	K	100	7,90 Ms
M 2,5	K	100	7,70 Ms
M 3	S	1000	3,75 Ms
M 3	K	100	7,70 Ms
M 4	S	1000	4,65 Ms
M 4	K	100	8,70 Ms
M 5	S	1000	6,00 Ms
M 5	K	100	10,10 Ms
M 6	S	1000	8,70 Ms
M 6	K	100	14,60 Ms
M 8	S	500	18,60 Ms
M 8	K	100	23,90 Ms
M 10	S	500	31,50 Ms
M 12	S	100	69,00 Ms
M 14	S	50	121,00 Ms
M 16	S	50	160,00 Ms
M 20	S	50	295,00 Ms

Abmessungen	VE Stück	€/100/Obf.
ISO	04035.730	
4035	Messing galvanisch vernickelt	

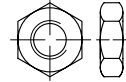

Sechskantmuttern, niedrige Form, mit Fasen

*M 10, 12 = RAZ 3370

Maße → [TI-61](#) Normumstellung → [TI-7](#)
 Werkstoffeigensch. → [TI-239](#) REACH → [TI-262](#)
 Stahl → [S. 284](#)
 Rostfrei → [S. 547](#)

ISO 4035 → ersetzt DIN 439 Form B



M 3	S	100	10,70 gal Ni
M 4	S	100	16,00 gal Ni
M 5	S	100	19,90 gal Ni
M 6	S	100	27,00 gal Ni
M 8	S	100	40,00 gal Ni
M 10	S	100	61,00 gal Ni
M 12	S	100	112,00 gal Ni
M 16	S	50	226,00 gal Ni
M 20	S	50	400,00 gal Ni

ISO	04766.700
4766	Messing

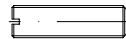

Gewindestifte mit Kegelkuppe, mit Schlitz

Maße → [TI-19](#) Normumstellung → [TI-6](#)
 Werkstoffeigensch. → [TI-239](#) REACH → [TI-262](#)

Stahl → [S. 305](#)
 Rostfrei → [S. 552](#)

ISO 4766 → ersetzt DIN 551 (austauschbar)



M 3	x	3	S	100	13,60 Ms
M 3	x	4	S	100	13,60 Ms
M 3	x	5	S	100	13,80 Ms
M 3	x	6	S	100	14,40 Ms
M 3	x	8	S	100	14,90 Ms
M 3	x	10	S	100	15,20 Ms
M 3	x	12	S	100	16,00 Ms
M 3	x	16	S	100	17,00 Ms
M 4	x	4	S	100	13,80 Ms
M 4	x	5	S	100	14,10 Ms
M 4	x	6	S	100	14,40 Ms
M 4	x	8	S	100	14,60 Ms
M 4	x	10	S	100	16,20 Ms
M 4	x	12	S	100	17,00 Ms
M 4	x	16	S	100	17,80 Ms
M 5	x	5	S	100	14,60 Ms
M 5	x	6	S	100	15,70 Ms

Abmessungen	VE	Stück	€/100/Obf.
M 5 x 8	S	100	16,00 Ms
M 5 x 10	S	100	17,00 Ms
M 5 x 12	S	100	18,30 Ms
M 5 x 16	S	100	20,50 Ms
M 6 x 6	S	100	16,50 Ms
M 6 x 8	S	100	18,30 Ms
M 6 x 10	S	100	18,90 Ms
M 6 x 12	S	100	21,80 Ms
M 6 x 16	S	100	23,40 Ms
M 6 x 20	S	100	28,50 Ms
M 6 x 25	S	100	31,00 Ms
M 6 x 30	S	100	40,00 Ms
M 8 x 10	S	100	54,00 Ms
M 8 x 12	S	100	61,00 Ms
M 8 x 16	S	100	67,00 Ms
M 8 x 20	S	100	72,00 Ms
M 8 x 25	S	100	77,00 Ms
M 8 x 35	S	100	77,00 Ms
M 8 x 40	S	100	84,00 Ms
M 8 x 45	S	100	88,00 Ms
M 8 x 50	S	100	88,00 Ms
M 10 x 8	S	100	146,00 Ms
M 10 x 12	S	100	149,00 Ms
M 10 x 16	S	100	112,00 Ms
M 10 x 20	S	100	154,00 Ms

ISO	04766.600
4766	Kunststoff PA



Gewindestifte mit Kegelkuppe, mit Schlitz

Maße → [TI-19](#) REACH → [TI-262](#)
 Werkstoffeigensch. → [TI-239](#)
 Stahl → [S. 305](#)
 Rostfrei → [S. 552](#)

M 4 x 6	S	100	22,00 Kunstst
M 4 x 8	S	100	23,00 Kunstst
M 4 x 10	S	100	23,00 Kunstst
M 4 x 12	S	100	24,00 Kunstst
M 4 x 16	S	100	26,00 Kunstst
M 4 x 20	S	100	28,00 Kunstst
M 4 x 25	S	100	30,00 Kunstst
M 5 x 6	S	100	24,00 Kunstst
M 5 x 8	S	100	25,00 Kunstst
M 5 x 10	S	100	26,00 Kunstst
M 5 x 12	S	100	28,00 Kunstst
M 5 x 16	S	100	30,00 Kunstst
M 6 x 6	S	100	5,70 Kunstst
M 6 x 8	S	100	27,00 Kunstst
M 6 x 10	S	100	28,00 Kunstst
M 6 x 12	S	100	29,00 Kunstst
M 6 x 16	S	100	30,00 Kunstst
M 6 x 20	S	100	32,00 Kunstst
M 6 x 25	S	100	34,00 Kunstst
M 8 x 8	S	100	30,00 Kunstst
M 8 x 10	S	100	32,00 Kunstst
M 8 x 12	S	100	35,00 Kunstst
M 8 x 16	S	100	38,00 Kunstst
M 10 x 16	S	100	40,00 Kunstst
M 10 x 20	S	100	45,00 Kunstst
M 10 x 30	S	100	50,00 Kunstst
M 10 x 40	S	100	55,00 Kunstst

Abmessungen	VE	Stück	€/100/Obf.
DIN	06335.634		
6335	Kunststoff	Form K-St	
	schwarz		

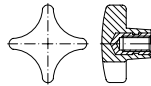

Kreuzgriffe, K = mit Gewindebuchse*

*Stahl, verzinkt

Maße → [TI-126](#) REACH → [TI-262](#)

Griff Ø – Innengewinde

K 25 M 5	S	10	187,00 KU-St
K 32 M 6	S	10	204,00 KU-St
K 40 M 8	S	10	265,00 KU-St
K 50 M 10	S	10	350,00 KU-St
K 63 M 12	S	10	500,00 KU-St
K 80 M 16	S	10	970,00 KU-St
K 100 M 20	S	5	2300,00 KU-St

DIN	06336.644
6336	Kunststoff
	schwarz
	Form K-St

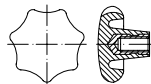

Sterngriffe, K = mit Gewindebuchse*

*Stahl, verzinkt

Maße → [TI-126](#) REACH → [TI-262](#)

Griff Ø – Innengewinde

K 25 M 5	S	10	255,00 KU-St
K 32 M 6	S	10	270,00 KU-St
K 40 M 6	S	10	325,00 KU-St
K 40 M 8	S	10	340,00 KU-St
K 50 M 8	S	10	460,00 KU-St
K 50 M 10	S	10	490,00 KU-St
K 63 M 10	S	10	690,00 KU-St
K 63 M 12	S	10	780,00 KU-St
K 80 M 12	S	10	1440,00 KU-St
K 80 M 16	S	10	1620,00 KU-St

DIN	06336.634
6336	Kunststoff
	schwarz
	Form K-Ms

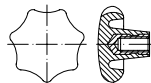

Sterngriffe, K = mit Gewindebuchse*

*Messing

Maße → [TI-126](#) REACH → [TI-262](#)

Griff Ø – Innengewinde

K 20 M 4	S	10	248,00 KU-Ms
K 25 M 5	S	10	255,00 KU-Ms
K 32 M 6	S	10	270,00 KU-Ms
K 40 M 8	S	10	350,00 KU-Ms
K 50 M 8	S	10	450,00 KU-Ms

Abmessungen	VE	Stück	€/100/Obf.
K 50 M 10	S	10	620,00 KU-Ms
K 63 M 10	S	10	740,00 KU-Ms
K 63 M 12	S	10	1000,00 KU-Ms
K 80 M 12	S	5	1550,00 KU-Ms
K 80 M 16	S	5	2080,00 KU-Ms

~DIN	06798.701
6798	CuSn8 (Bronze)
	Form A

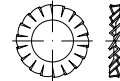

Fächerscheiben, A = außengezahnt

Achtung! Reduzierte Federkräfte.

Maße → [TI-99](#) REACH → [TI-262](#)

Werkstoffeigensch. → [TI-239](#)

Federstahl → [S. 313](#)

Rostfrei → [S. 554](#)



A 3,2	S	2000	9,60 Bronze
A 3,2	K	100	16,20 Bronze
A 4,3	S	1000	12,60 Bronze
A 4,3	K	100	19,70 Bronze
A 5,3	S	1000	21,50 Bronze
A 5,3	K	100	29,50 Bronze
A 6,4	S	1000	28,00 Bronze
A 6,4	K	100	36,00 Bronze
A 8,4	S	1000	52,00 Bronze
A 8,4	K	100	63,00 Bronze
A 10,5	S	1000	92,00 Bronze
A 10,5	K	100	105,00 Bronze

ISO	07089.700
7089	Messing



Flache Scheiben, normale Reihe, Produktklasse A, ohne Fase

Maße → [TI-84](#) Normumstellung → [TI-84](#)
 Werkstoffeigensch. → [TI-239](#) REACH → [TI-262](#)

Stahl → [S. 333](#)

Rostfrei → [S. 568](#)

ISO 7089 → ersetzt DIN 125 Form A



für Schrauben M

2	S	1000	2,65 Ms
2	K	100	8,30 Ms
2,3	S	1000	2,65 Ms
2,3	K	100	8,30 Ms
2,5	S	1000	2,65 Ms
2,5	K	100	8,30 Ms
2,6	S	1000	2,65 Ms
3	S	1000	1,85 Ms
3	K	100	7,50 Ms
3,5	K	100	9,10 Ms

Abmessungen	VE	Stück	€/100/Obf.
4	K	100	9,10 Ms
4	S	1000	3,45 Ms
5	K	100	9,60 Ms
5	S	1000	4,15 Ms
6	K	100	14,40 Ms
6	S	1000	8,90 Ms
8	K	100	25,00 Ms
8	S	1000	17,00 Ms

ISO	07089.730
7089	Messing galvanisch vernickelt

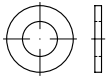

Flache Scheiben, normale Reihe, Produktklasse A, ohne Fase

Maße → **TI-84** Normumstellung → **TI-84**
 Werkstoffeigensch. → **TI-239** REACH → **TI-262**

Stahl → **S. 333**
 Rostfrei → **S. 568**

ISO 7089 → ersetzt DIN 125 Form A



für Schrauben M

3	S	1000	2,75 Ms Ni
4	S	1000	5,40 Ms Ni
5	S	1000	6,40 Ms Ni
6	S	1000	14,10 Ms Ni
8	S	1000	27,00 Ms Ni

ISO	07089.310
7089	Kupfer

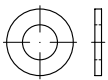

Flache Scheiben, normale Reihe, Produktklasse A, ohne Fase

Maße → **TI-84** Normumstellung → **TI-84**
 Werkstoffeigensch. → **TI-239**

Stahl → **S. 333**
 Rostfrei → **S. 568**

ISO 7089 → ersetzt DIN 125 Form A

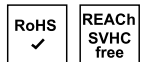

für Schrauben M

5	S	100	38,50 Cu
6	S	100	61,00 Cu
8	S	100	91,00 Cu
10	S	100	152,00 Cu
12	S	100	223,00 Cu
16	S	100	405,00 Cu

Abmessungen	VE	Stück	€/100/Obf.
ISO	07089.311		
7089	Aluminium		

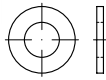

Flache Scheiben, normale Reihe, Produktklasse A, ohne Fase

Maße → **TI-84** Normumstellung → **TI-84**
 Werkstoffeigensch. → **TI-239** REACH → **TI-262**

Stahl → **S. 333**
 Rostfrei → **S. 568**

ISO 7089 → ersetzt DIN 125 Form A



für Schrauben M

3	K	500	2,90 Al
4	S	1000	3,00 Al
4	K	100	5,30 Al
5	S	1000	3,35 Al
5	K	100	4,70 Al
6	S	1000	5,20 Al
6	K	100	6,70 Al
8	S	500	6,50 Al
8	K	100	7,90 Al
10	S	500	10,30 Al
10	K	100	12,20 Al
12	S	100	19,90 Al
16	S	50	44,50 Al

ISO	07089.600
7089	Kunststoff PA

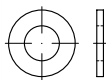

Flache Scheiben, normale Reihe, Produktklasse C*, ohne Fase

*nach ISO 4759-3

Maße → **TI-84** REACH → **TI-262**
 Werkstoffeigensch. → **TI-239**

Stahl → **S. 333**
 Rostfrei → **S. 568**

für Schrauben M

2	S	1000	7,50 Kunstst
2,5	S	1000	6,10 Kunstst
3	S	1000	2,55 Kunstst
3,2	K	200	4,20 Kunstst
4	S	1000	2,55 Kunstst
4	K	200	4,20 Kunstst
5	K	200	5,00 Kunstst
6	S	1000	4,00 Kunstst
6	K	200	5,80 Kunstst
8	S	1000	5,30 Kunstst
8	K	200	7,30 Kunstst
10	S	500	8,20 Kunstst
10	K	200	10,60 Kunstst
12	S	500	11,50 Kunstst
12	K	100	13,40 Kunstst
16	S	250	15,20 Kunstst
16	K	100	17,20 Kunstst
20	S	100	24,00 Kunstst

Abmessungen	VE	Stück	€/100/Obf.
22	S	100	60,00 Kunstst
24	S	100	65,00 Kunstst
27	S	50	114,00 Kunstst
30	S	50	130,00 Kunstst
33	S	50	150,00 Kunstst

ISO	07090.707
7090	Messing gedreht



Flache Scheiben, mit Fase, normale Reihe, Produktklasse A

Maße → **TI-84** Normumstellung → **TI-84**
 Werkstoffeigensch. → **TI-239** REACH → **TI-262**

Stahl → **S. 335**
 Rostfrei → **S. 569**

ISO 7090 → ersetzt DIN 125 Form B



für Schrauben M

1	S	100	46,50 Ms
1,2	S	100	46,50 Ms
1,4	S	100	46,50 Ms
1,6	S	100	45,00 Ms
2	S	100	45,00 Ms
2,5	S	100	45,00 Ms
3	S	100	48,00 Ms
4	S	100	58,00 Ms
5	S	100	63,00 Ms
6	S	100	84,00 Ms
8	S	100	103,00 Ms
10	S	100	120,00 Ms

ISO	07090.700
7090	Messing

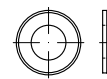

Flache Scheiben, mit Fase, normale Reihe, Produktklasse A

*ab \varnothing 39 RAZ = 3380

Maße → **TI-84** Normumstellung → **TI-84**
 Werkstoffeigensch. → **TI-239** REACH → **TI-262**

Stahl → **S. 335**
 Rostfrei → **S. 569**

ISO 7090 → ersetzt DIN 125 Form B



Innen \varnothing x Außen \varnothing x Dicke

10	S	500	41,50 Ms
10	K	100	54,00 Ms
12	S	500	47,50 Ms
12	K	100	56,00 Ms
14	S	250	66,00 Ms
14	K	100	76,00 Ms
16	S	250	85,00 Ms
16	K	100	93,00 Ms

Abmessungen	VE	Stück	€/100/Obf.
18	S	50	136,00 Ms
20	S	50	141,00 Ms
22	S	25	290,00 Ms
24	S	25	390,00 Ms
27	S	25	465,00 Ms
30	S	25	580,00 Ms
36	S	1	1330,00 Ms
39	S	1	2050,00 Ms
42	S	1	2750,00 Ms
45	S	1	3600,00 Ms
48	S	1	3700,00 Ms

ISO	07092.700
7092	Messing

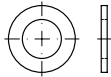

Flache Scheiben, kleine Reihe, Produktklasse A

vorzugsweise für Zylinderschrauben

Maße → **TI-84** Normumstellung → **TI-84**
 Werkstoffeigensch. → **TI-239** REACH → **TI-262**

Stahl → **S. 338**
 Rostfrei → **S. 569**

ISO 7092 → ersetzt DIN 433



für Schrauben M

2	S	5000	1,15 Ms
2	K	500	1,95 Ms
2,5	S	5000	1,40 Ms
2,5	K	500	2,35 Ms
3	S	5000	1,15 Ms
3	K	500	1,80 Ms
4	S	5000	1,45 Ms
4	K	500	2,30 Ms
5	S	1000	4,15 Ms
5	K	100	8,40 Ms
6	S	1000	7,20 Ms
6	K	100	11,60 Ms
8	S	1000	13,80 Ms
8	K	100	20,20 Ms
10	S	1000	18,10 Ms
10	K	100	27,50 Ms
12	S	500	30,50 Ms
12	K	100	37,00 Ms
14	S	100	55,00 Ms
16	S	100	64,00 Ms
20	S	50	194,00 Ms

Abmessungen	ISO	07093.702
	7093-2	Messing

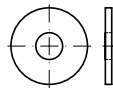

Flache Scheiben, große Reihe, Produktklasse C

Maße → **TI-85** Normumstellung → **TI-84**
 Werkstoffeigensch. → **TI-239** REACH → **TI-262**

Stahl → **S. 338**
 Rostfrei → **S. 570**

ISO 7093 → ersetzt DIN 9021



für Schrauben M

3	S	1000	4,80 Ms
3	K	100	8,50 Ms
4	S	1000	6,70 Ms
4	K	100	10,30 Ms
5	S	1000	11,30 Ms
5	K	100	16,70 Ms
6	S	1000	16,00 Ms
6	K	100	21,50 Ms
8	S	500	38,50 Ms
8	K	100	45,00 Ms
10	S	100	80,00 Ms
12	S	100	157,00 Ms
14	S	50	218,00 Ms
16	S	50	265,00 Ms

Abmessungen	DIN	07338.702
	7338	Kupfer Form B

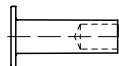

Niete für Brems- und Kupplungsbeläge, B = Halbhohlните

Maße → **TI-135** Werkstoffeigensch. → **TI-239**



B 3	x	8	S	100	10,90 Cu
B 3	x	10	S	100	11,80 Cu
B 3	x	12	S	100	26,50 Cu
B 3	x	18	S	100	28,00 Cu
B 4	x	8	S	100	13,80 Cu
B 4	x	10	S	100	16,50 Cu
B 4	x	12	S	100	20,50 Cu
B 5	x	10	S	100	24,70 Cu
B 5	x	12	S	100	29,00 Cu
B 5	x	15	S	100	34,50 Cu
B 6	x	12	S	100	37,50 Cu
B 6	x	15	S	100	44,50 Cu
B 8	x	20	S	100	80,00 Cu
B 8	x	25	S	100	178,00 Cu
B 8	x	30	S	100	226,00 Cu

Abmessungen	DIN	07338.703
	7338	Kupfer Form C

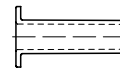

Niete für Brems- und Kupplungsbeläge, C = Hohlните

Maße → **TI-135** Werkstoffeigensch. → **TI-239**

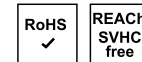

C 4	x	8	S	100	18,90 Cu
C 4	x	10	S	100	20,20 Cu
C 4	x	12	S	100	26,00 Cu
C 4	x	15	S	100	38,00 Cu
C 5	x	10	S	100	26,00 Cu
C 5	x	12	S	100	30,00 Cu
C 5	x	15	S	100	40,00 Cu
C 5	x	20	S	100	56,00 Cu
C 6	x	15	S	100	42,50 Cu
C 6	x	20	S	100	75,00 Cu
C 6	x	25	S	100	100,00 Cu
C 8	x	20	S	100	76,00 Cu
C 8	x	25	S	100	141,00 Cu
C 8	x	30	S	100	194,00 Cu

Abmessungen	ISO	07434.700
	7434	Messing

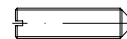

Gewindestifte mit Kegelhülse, mit Schlitz

Maße → **TI-19** REACH → **TI-262**
 Werkstoffeigensch. → **TI-239**

Stahl → **S. 345**
 Rostfrei → **S. 573**

ISO 7434 → ersetzt DIN 553 (austauschbar)



M 3	x	4	S	100	13,60 Ms
M 3	x	5	S	100	13,80 Ms
M 3	x	6	S	100	14,40 Ms
M 4	x	4	S	100	13,80 Ms
M 4	x	5	S	100	14,10 Ms
M 4	x	6	S	100	14,40 Ms
M 4	x	8	S	100	14,60 Ms
M 5	x	5	S	100	14,60 Ms
M 5	x	6	S	100	15,70 Ms
M 5	x	8	S	100	16,00 Ms
M 5	x	10	S	100	17,00 Ms
M 5	x	12	S	100	18,30 Ms
M 5	x	16	S	100	20,50 Ms
M 6	x	6	S	100	16,50 Ms
M 6	x	8	S	100	18,30 Ms
M 6	x	10	S	100	18,90 Ms
M 6	x	20	S	100	28,50 Ms

Abmessungen	VE Stück	€/100/Obf.
DIN	07603.701	
7603	Kupfer	Form A



Dichtringe für Rohrverschraubungen und Verschlusschrauben, A = Flachdichtringe

Maße → **TI-87** Werkstoffeigensch. → **TI-239**

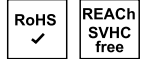

4	x	8	x	1	S	100	33,00 Cu
5	x	7,5	x	1	S	100	35,50 Cu
5	x	9	x	1	S	100	37,50 Cu
6	x	10	x	1	S	100	38,00 Cu
6	x	12	x	1	S	100	41,00 Cu
6,5	x	9,5	x	1	S	100	39,00 Cu
6,5	x	11	x	1	S	100	66,00 Cu
8	x	11,5	x	1	S	100	66,00 Cu
8	x	12	x	1	S	100	44,50 Cu
8	x	12	x	1,5	S	100	45,50 Cu
8	x	14	x	1	S	100	69,00 Cu
8	x	14	x	1,5	S	100	47,00 Cu
10	x	13,5	x	1	S	100	68,00 Cu
10	x	13,5	x	1,5	S	100	46,00 Cu
10	x	14	x	1	S	100	46,00 Cu
10	x	14	x	1,5	S	100	47,00 Cu
10	x	15	x	1	S	100	49,50 Cu
10	x	16	x	1	S	100	81,00 Cu
10	x	16	x	1,5	S	100	57,00 Cu
10	x	18	x	1,5	S	100	57,00 Cu
12	x	15,5	x	1,5	S	100	89,00 Cu
12	x	16	x	1,5	S	100	93,00 Cu
12	x	17	x	1,5	S	100	114,00 Cu
12	x	18	x	1,5	S	100	75,00 Cu
12	x	19	x	1,5	S	100	136,00 Cu
13	x	18	x	1,5	S	100	114,00 Cu
14	x	18	x	1,5	S	100	78,00 Cu
14	x	18	x	1	S	100	77,00 Cu
14	x	20	x	1,5	S	100	82,00 Cu
15	x	19	x	1,5	S	100	154,00 Cu
16	x	20	x	1,5	S	100	152,00 Cu
16	x	22	x	1,5	S	100	101,00 Cu
16	x	27	x	2,5	S	100	141,00 Cu
16	x	30	x	1,5	S	100	144,00 Cu
17	x	21	x	1,5	S	100	152,00 Cu
17	x	22	x	1,5	S	100	160,00 Cu
17	x	23	x	1,5	S	100	107,00 Cu
17	x	22	x	2	S	100	178,00 Cu
18	x	22	x	1,5	S	100	110,00 Cu
18	x	24	x	1,5	S	100	114,00 Cu
20	x	24	x	1,5	S	100	181,00 Cu
20	x	26	x	1,5	S	100	121,00 Cu
21	x	26	x	1,5	S	100	181,00 Cu
22	x	27	x	1,5	S	100	131,00 Cu
22	x	29	x	1,5	S	100	239,00 Cu
23	x	28	x	2	S	100	160,00 Cu
24	x	29	x	2	S	100	242,00 Cu
24	x	32	x	2	S	100	170,00 Cu
26	x	31	x	2	S	100	270,00 Cu
26	x	32	x	2	S	100	295,00 Cu
26	x	34	x	2	S	100	198,00 Cu
27	x	32	x	2	S	100	184,00 Cu
28	x	33	x	2	S	100	280,00 Cu
30	x	36	x	2	S	100	280,00 Cu
32	x	38	x	2	S	100	195,00 Cu

Abmessungen	VE Stück	€/100/Obf.
33	x 39 x 2 S 100	345,00 Cu
33	x 41 x 2 S 100	213,00 Cu
36	x 42 x 2 S 50	390,00 Cu
38	x 44 x 2 S 50	270,00 Cu
42	x 49 x 2 S 50	495,00 Cu
45	x 52 x 2 S 50	510,00 Cu
48	x 55 x 2 S 50	600,00 Cu
60	x 68 x 2,5 S 25	1170,00 Cu

DIN	07603.300
7603	Aluminium Form A



Dichtringe für Rohrverschraubungen und Verschlusschrauben, A = Flachdichtringe

Maße → **TI-87** REACH → **TI-262**
Werkstoffeigensch. → **TI-239**



5	x	9	x	1	S	100	9,30 Al
6	x	10	x	1	S	100	10,30 Al
6,5	x	9,5	x	1	S	100	12,00 Al
8	x	11,5	x	1	S	100	13,70 Al
10	x	13,5	x	1	S	100	14,50 Al
10	x	14	x	1	S	100	14,90 Al
10	x	15	x	1	S	1	15,10 Al
12	x	15,5	x	1,5	S	100	15,40 Al
14	x	18	x	1,5	S	100	18,30 Al
16	x	20	x	1,5	S	100	26,50 Al
17	x	21	x	1,5	S	100	28,00 Al
18	x	22	x	1,5	S	100	28,50 Al
18	x	24	x	1,5	S	100	30,50 Al
20	x	24	x	1,5	S	100	32,00 Al
21	x	26	x	1,5	S	100	32,50 Al
22	x	27	x	1,5	S	100	33,50 Al
24	x	29	x	2	S	100	34,00 Al
27	x	32	x	2	S	100	34,50 Al
30	x	36	x	2	S	100	46,00 Al
33	x	39	x	2	S	100	142,00 Al
42	x	49	x	2	S	100	171,00 Al
48	x	55	x	2	S	50	214,00 Al

Abmessungen	VE Stück	€/100/Obf.
DIN	07965.700	
7965	Messing	

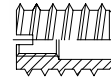

Einschraubmuttern "RAMPA" (Schraubdübel)

Maße → **TI-79** REACH → **TI-262**
Werkstoffeigensch. → **TI-239**
Stahl → **S. 352**



Nennmaß = Innennutzgewinde x Länge

M 3	x	8	S	100	83,00 Ms
M 3	x	10	S	100	87,00 Ms
M 4	x	8	S	100	77,00 Ms
M 4	x	10	S	100	84,00 Ms
M 4	x	12	S	100	100,00 Ms
M 4	x	15	S	100	114,00 Ms
M 5	x	12	S	100	121,00 Ms
M 5	x	15	S	100	141,00 Ms
M 5	x	20	S	100	199,00 Ms
M 6	x	12	S	100	146,00 Ms
M 6	x	20	S	100	220,00 Ms
M 8	x	18	S	100	365,00 Ms
M 8	x	30	S	100	630,00 Ms
M 10	x	20	S	100	510,00 Ms
M 10	x	30	S	100	730,00 Ms
M 12	x	25	S	100	970,00 Ms
M 12	x	30	S	50	1170,00 Ms

ISO	08673.700
8673	Messing

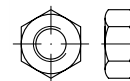

Sechskantmuttern, ISO-Typ 1, mit metrischem Feingewinde

Maße → **TI-62** Normumstellung → **TI-7**
Werkstoffeigensch. → **TI-239** REACH → **TI-262**
Anziehmomente → **TI-250**

Stahl → **S. 369**
Rostfrei → **S. 582**

ISO 8673 → ersetzt DIN 934 Feingewinde



M 8	x	1	S	100	47,00 Ms
M 10	x	1	S	100	65,00 Ms
M 14	x	1,5	S	50	141,00 Ms
M 16	x	1,5	S	25	205,00 Ms
M 20	x	1,5	S	10	410,00 Ms
M 22	x	1,5	S	10	580,00 Ms

Abmessungen	VE Stück	€/100/Obf.
ISO	08675.700	
8675	Messing	

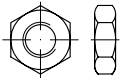

Sechskantmutter, niedrige Form, mit Fasen, mit metrischem Feingewinde

Maße → **TI-61** Normumstellung → **TI-7**
 Werkstoffeigensch. → **TI-239** REACH → **TI-262**
 Stahl → **S. 371**
 Rostfrei → **S. 582**

ISO 8675 → ersetzt DIN 439 Feingewinde



M 10	x	1	S	100	52,00 Ms
M 12	x	1,5	S	100	76,00 Ms
M 14	x	1,5	S	50	132,00 Ms

ISO	08746.700	
8746	Messing	Form A

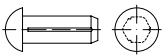

Halbrundkerbnägel, A = mit Fase

Maße → **TI-120** Normumstellung → **TI-10**
 Werkstoffeigensch. → **TI-239** REACH → **TI-262**
 Stahl → **S. 380**
 Rostfrei → **S. 584**

ISO 8746 → ersetzt DIN 1476 (austauschbar)



2	x	3	K	200	16,00 Ms
2	x	4	S	1000	11,80 Ms
2	x	4	K	200	16,20 Ms
2	x	5	S	1000	12,10 Ms
2	x	5	K	200	16,50 Ms
2	x	6	S	1000	12,40 Ms
2	x	6	K	200	16,70 Ms
2	x	8	K	200	18,10 Ms
3	x	5	K	200	21,80 Ms
3	x	6	S	1000	18,30 Ms
3	x	6	K	200	22,60 Ms
3	x	8	S	1000	19,70 Ms
3	x	8	K	200	24,20 Ms
3	x	10	S	1000	22,00 Ms
3	x	10	K	200	27,00 Ms
3	x	12	S	1000	24,70 Ms

Abmessungen	VE Stück	€/100/Obf.
ISO	08746.300	
8746	Aluminium	Form A

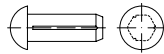

Halbrundkerbnägel, A = mit Fase

Maße → **TI-120** Normumstellung → **TI-10**
 Werkstoffeigensch. → **TI-239** REACH → **TI-262**
 Stahl → **S. 380**
 Rostfrei → **S. 584**

ISO 8746 → ersetzt DIN 1476 (austauschbar)



1,4	x	4	S	500	2,20 Al
1,6	x	4	S	500	2,40 Al
1,6	x	5	S	500	2,40 Al
1,6	x	6	S	500	2,55 Al
2	x	3	S	500	2,45 Al
2	x	4	S	500	2,45 Al
2	x	5	S	500	2,45 Al
2	x	6	S	500	2,45 Al
2	x	8	S	500	2,55 Al
2	x	10	S	500	2,70 Al
2,3	x	5	S	500	2,70 Al
2,5	x	5	S	500	2,75 Al
2,5	x	6	S	500	2,75 Al
2,5	x	8	S	500	2,75 Al
3	x	4	S	500	3,15 Al
3	x	5	S	500	3,15 Al
3	x	6	S	500	3,15 Al
3	x	8	S	500	3,20 Al
3	x	10	S	500	3,45 Al
3	x	12	S	500	3,45 Al
4	x	6	S	500	5,10 Al
4	x	8	S	500	5,20 Al
4	x	10	S	500	5,20 Al
5	x	12	S	500	8,70 Al

DIN	09021.700	
9021	Messing	

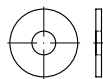

Scheiben, Außen Ø ≈ 3 x Schrauben Ø

Maße → **TI-85** Normumstellung → **TI-84**
 Werkstoffeigensch. → **TI-239** REACH → **TI-262**
 Stahl → **S. 387**
 Rostfrei → **S. 586**

DIN 9021 → wird ersetzt durch ISO 7093



Innen Ø x Außen Ø x Dicke

3,2	x	9	x	0,8	S	1000	4,80 Ms
3,2	x	9	x	0,8	K	100	8,50 Ms
4,3	x	12	x	1	S	1000	6,70 Ms
4,3	x	12	x	1	K	100	10,30 Ms

Abmessungen	VE Stück	€/100/Obf.					
5,3	x	15	x	1,2	S	1000	11,30 Ms
5,3	x	15	x	1,2	K	100	16,70 Ms
6,4	x	18	x	1,6	S	1000	16,00 Ms
6,4	x	18	x	1,6	K	100	21,50 Ms
8,4	x	24	x	2	S	500	38,50 Ms
8,4	x	24	x	2	K	100	45,00 Ms
10,5	x	30	x	2,5	S	100	80,00 Ms
13	x	37	x	3	S	100	157,00 Ms
15	x	44	x	3	S	50	218,00 Ms
17	x	50	x	3	S	50	265,00 Ms

DIN	09021.600	
9021	Kunststoff PA	

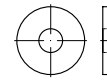

Scheiben, Außen Ø ≈ 3 x Schrauben Ø

Produktklasse C nach ISO 4759-3

Maße → **TI-85** REACH → **TI-262**
 Werkstoffeigensch. → **TI-239**

Stahl → **S. 387**
 Rostfrei → **S. 586**

Weitgehend identisch mit DIN 34816

Innen Ø x Außen Ø x Dicke

3,2	x	9	x	0,8	S	200	5,20 Kunstst
4,3	x	12	x	1	S	1000	6,60 Kunstst
4,3	x	12	x	1	K	100	9,10 Kunstst
5,3	x	15	x	1,2	S	1000	6,90 Kunstst
5,3	x	15	x	1,2	K	100	9,40 Kunstst
6,4	x	18	x	1,6	S	1000	7,60 Kunstst
6,4	x	18	x	1,6	K	100	10,10 Kunstst
8,4	x	24	x	2	S	500	13,60 Kunstst
8,4	x	24	x	2	K	100	16,10 Kunstst
10,5	x	30	x	2,5	S	250	21,40 Kunstst
10,5	x	30	x	2,5	K	100	23,90 Kunstst
13	x	37	x	3	S	100	49,50 Kunstst
17	x	50	x	3	S	100	58,00 Kunstst
22	x	60	x	4	S	100	85,00 Kunstst

~ISO	10511.700	
10511	Messing	

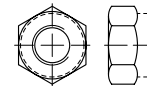

Sechskantmutter mit Klemmteil, mit nichtmetallischem Einsatz, niedrige Form

für Temperatur-Einsatz von -50 bis +120 °C

Maße → **TI-9** Normumstellung → **TI-9**
 Werkstoffeigensch. → **TI-239** REACH → **TI-262**

Stahl → **S. 388**
 Rostfrei → **S. 587**

ISO 10511 → ersetzt DIN 985

M 4	S	100	30,00
M 5	S	100	33,00
M 6	S	100	34,00

Abmessungen	VE Stück	€/100/Obf.
M 8	S 100	58,00
M 10	S 100	110,00
M 12	S 50	170,00

Wichtiger Hinweis!



Die gültigen Normen für Sechskantmutter mit Klemmteil gelten für die Ausführung Stahl in den Festigkeitsklassen 5, (6), 8, 10 bzw. 12. Die Verwendung von Muttern mit Klemmteil aus anderen Werkstoffen (z.B. nichtrostenden Stählen, Messing, Aluminium) erfolgt auf eigenes Risiko. Muttern mit Klemmteil aus diesen weicheren Werkstoffen neigen manchmal wegen des hohen Gewindeflankendrucks beim Einformen des Bolzen- gewindes in den Sicherungsring zum Festfressen. Hier hilft in der Regel die Verwendung eines Schmiermittels. Die veränderten Reibwerte sind beim Anziehen der Verbindung entsprechend zu berücksichtigen.

DIN	34810.600
34810	Kunststoff PA

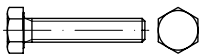

Sechskantschrauben mit Gewinde bis Kopf*

*Gewindelänge max. 50 mm

Achtung! Grobe Toleranzen, evtl. Lunkerbildung nach VDI 2544/Abs. 8

Muttern → DIN 555

Maße → TI-15 REACH → TI-262
Werkstoffeigensch. → TI-239

Weitgehend identisch mit DIN 933

M 3	x	8	S	200	7,50 Kunstst
M 3	x	10	S	200	7,70 Kunstst
M 3	x	12	S	200	7,70 Kunstst
M 3	x	16	S	200	7,90 Kunstst
M 3	x	20	S	200	8,40 Kunstst
M 3	x	25	S	200	8,60 Kunstst
M 3	x	30	S	200	8,80 Kunstst
M 4	x	8	S	200	7,90 Kunstst
M 4	x	10	S	200	8,20 Kunstst
M 4	x	12	S	200	8,30 Kunstst
M 4	x	16	S	200	8,50 Kunstst
M 4	x	20	S	200	9,10 Kunstst
M 4	x	25	S	200	9,50 Kunstst
M 4	x	30	S	200	10,00 Kunstst
M 5	x	10	S	200	9,20 Kunstst
M 5	x	12	S	200	9,50 Kunstst
M 5	x	16	S	200	10,10 Kunstst
M 5	x	20	S	200	11,80 Kunstst
M 5	x	25	S	200	12,40 Kunstst
M 5	x	30	S	200	13,20 Kunstst
M 5	x	40	S	200	14,50 Kunstst
M 6	x	10	S	200	10,50 Kunstst
M 6	x	12	S	200	10,70 Kunstst
M 6	x	16	S	200	11,20 Kunstst
M 6	x	20	S	200	12,30 Kunstst
M 6	x	25	S	200	13,40 Kunstst
M 6	x	30	S	200	16,10 Kunstst

Abmessungen	VE Stück	€/100/Obf.
M 6	x 35	S 200 16,80 Kunstst
M 6	x 40	S 200 17,40 Kunstst
M 6	x 50	S 200 18,40 Kunstst
M 8	x 10	S 200 20,10 Kunstst
M 8	x 12	S 200 21,00 Kunstst
M 8	x 16	S 200 22,10 Kunstst
M 8	x 20	S 200 24,00 Kunstst
M 8	x 25	S 200 26,00 Kunstst
M 8	x 30	S 200 27,50 Kunstst
M 8	x 35	S 200 28,50 Kunstst
M 8	x 40	S 200 30,00 Kunstst
M 8	x 50	S 200 32,00 Kunstst
M 8	x 60	S 200 41,50 Kunstst
M 8	x 70	S 200 45,50 Kunstst
M 10	x 20	S 200 44,50 Kunstst
M 10	x 25	S 200 49,00 Kunstst
M 10	x 30	S 200 54,00 Kunstst
M 10	x 35	S 200 58,00 Kunstst
M 10	x 40	S 200 62,00 Kunstst
M 10	x 45	S 200 65,00 Kunstst
M 10	x 50	S 200 67,00 Kunstst
M 10	x 60	S 100 85,00 Kunstst
M 12	x 20	S 100 56,00 Kunstst
M 12	x 25	S 100 62,00 Kunstst
M 12	x 30	S 100 67,00 Kunstst
M 12	x 35	S 100 70,00 Kunstst
M 12	x 40	S 100 73,00 Kunstst
M 12	x 50	S 100 81,00 Kunstst
M 12	x 60	S 100 84,00 Kunstst

DIN	80701.700
80701	Messing

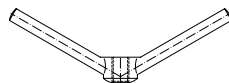

Knebelmuttern

Maße → TI-129 REACH → TI-262
Werkstoffeigensch. → TI-239



DIN	80704.700
80704	Messing



Korbmuttern

Maße → TI-129 REACH → TI-262
Werkstoffeigensch. → TI-239



M 6	S	10	810,00 Ms
M 8	S	10	1080,00 Ms
M 10	S	10	1080,00 Ms

Abmessungen	VE Stück	€/100/Obf.
M 12	S	10 1380,00 Ms
M 16	S	10 1990,00 Ms
M 20	S	1 3050,00 Ms
M 22	S	1 4850,00 Ms
M 24	S	1 5600,00 Ms

Artikel	88001.(*)
88001	Kunststoff IL

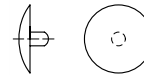

Zierkappen mit Stift für Spanplatten/ SPAX-Schrauben mit Innenloch

weiß RAL 9010 (*630),
hellbraun RAL 8001 (*640),
dunkelbraun RAL 8014 (*650)

REACH → TI-262

passend für Schrauben Ø 4,5 - 6,0

Stift Ø x Kappen Ø

2,5	x	12	S	1000	2,40 Kunstst
2,5	x	15	S	1000	2,40 Kunstst

Artikel	88002.(*)
88002	Kunststoff Z

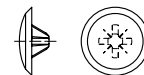

Zierkappen für Senkschrauben mit Pozidriv-Kreuzschlitz Z

weiß RAL 9010 (*630),
hellbraun RAL 8001 (*640),
dunkelbraun RAL 8014 (*650)

REACH → TI-262

Z-Kreuzschlitz-Nummer x Kappen Ø/für Schrauben Ø

1	x	8 / 3	S	1000	2,10
2	x	12 / 3,5-5	S	1000	2,10
3	x	13 / 5,5-6	S	1000	2,25

Artikel	88003.*
88003	Kunststoff



Zierkappen für Kappenschrauben Artikel 88981 Ø 3,9

weiß RAL 9010 (*630),
grau RAL 7001 (*640),
schwarz RAL 9005 (*650)

REACH → TI-262

F. 3,9	S	1000	8,60
--------	---	------	------

Abmessungen	VE Stück	€/100/Obf.
Artikel	88004.(*)	
88004	Kunststoff	KS-H

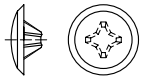

Zierkappen für Senkschrauben mit Phillips-Kreuzschlitz H

weiß RAL 9010 (*630),
hellbraun RAL 8001 (*640),
dunkelbraun RAL 8014 (*650)

REACH → TI-262

H-Kreuzschlitz-Nummer x Kappen Ø für Schrauben Ø

2	x 12 / 3,5-5	S 1000	3,10
---	--------------	--------	------

Artikel	88005.630
88005	Kunststoff
	schwarz

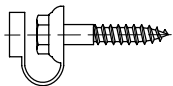

Kombi-Dichtungen (Regenhütchen) für Sechskant-Holzschrauben

für Welldachplatten

DIN 571 Ø 7 mm

REACH → TI-262

KD	S 100	6,40
----	-------	------

Artikel	88006.(*)
88006	Kunststoff
	ISR

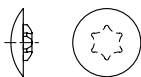

Zierkappen für Senkschrauben mit Innensechsrund-Antrieb T

weiß RAL 9010 (*630),
hellbraun RAL 8001 (*640),
dunkelbraun RAL 8014 (*650),
rehsbraun RAL 8007 (*660)

REACH → TI-262

ISR-Nummer x Kappen Ø / für Schrauben Ø

15	x 12 / 3,5	S 1000	3,45
20	x 12 / 4-4,5	S 1000	3,45
25	x 13,5/5	S 1000	3,45
30	x 16,5/6	S 1000	3,45

Abmessungen	VE Stück	€/100/Obf.
Artikel	88008.(*)	
88008	Kunststoff	

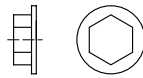

Zierkappen für Fassadenschrauben

weiß RAL 9010 (*630),
hellgrau RAL 9002 (*640),
hellelfenbein RAL 1015 (*670),
rotbraun RAL 8012 (*650)

REACH → TI-262

für Artikel 88176, 88276 mit Schlüsselweite 3/8"

F. SW 3/8	S 200	7,00 Kunstst
-----------	-------	--------------

Artikel	88095.700
88095	Messing
	Liko-Z



Spanplattenschrauben, Liko = Linsenkopf, Z = Pozidriv-Kreuzschlitz

Achtung! Geringere Festigkeit gegenüber gehärtetem Stahl.

Maße → TI-52

REACH → TI-262

Werkstoffeigensch. → TI-239



3,5	x 16 -Z	S 1000	16,00 Ms
3,5	x 20 -Z	S 1000	15,40 Ms
3,5	x 25 -Z	S 1000	13,60 Ms
3,5	x 30 -Z	S 1000	14,40 Ms
4	x 20 -Z	S 1000	16,50 Ms
4	x 25 -Z	S 1000	16,70 Ms
4	x 30 -Z	S 1000	16,70 Ms
4	x 35 -Z	S 1000	17,50 Ms
4	x 40 -Z	S 1000	18,30 Ms

Artikel	88101.700
88101	CuAl*
	„Cupal“

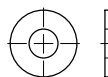

Flache Scheiben / „Cupal“-Scheiben

*ca. 70 % Cu/30 % Al



Nenn-Nr. / Innen Ø x Außen Ø x Dicke

4 / 4,5	x 10 x 1	S 200	167,00 Cu-Al
6 / 6,5	x 15 x 1	S 200	189,00 Cu-Al

Abmessungen	VE Stück	€/100/Obf.
Artikel	88152.601	
88152	Kunststoff	RUV - A



REYHER-Unverlierbarkeits-Scheiben für Schrauben m. metr. Gewinde

zur Verwendung nach der EG-Maschinenrichtlinie

Zugehörige Schrauben → DIN 7964 A2

Richtlinien → TI-263 REACH → TI-262

Für Gewinde M x Innen Ø x Außen Ø x Dicke

4/4,2	x 9	x 1,2	S 100	3,45
5/5,0	x 10,1	x 1,6	S 100	4,30
6/6,3	x 12,5	x 1,3	S 100	5,90
8/8,2	x 16,2	x 1,6	S 100	8,00
10/10,5	x 15	x 2,1	S 100	10,80

Artikel	88152.602
88152	Kunststoff
	RUV - B

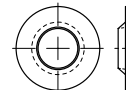

REYHER-Unverlierbarkeits-Scheiben für Blech-Schrauben

zur Verwendung nach der EG-Maschinenrichtlinie

Richtlinien → TI-263 REACH → TI-262

Baugleich mit R 88152 Form A

Für Gewinde ST x Innen Ø x Außen Ø x Dicke

4,2/4,2	x 9	x 1,2	S 100	3,45
4,8/5	x 10,1	x 1,6	S 100	4,30

Artikel	88251.630
88251	Kunststoff
	grau

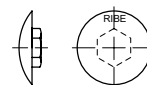

Kappen

für Innensechskantschrauben
DIN 912, 6912, ISO 4762

REACH → TI-262

Nennmaß / für Schrauben

4 M 5	S 500	12,10 Kunstst
5 M 6	S 500	14,60 Kunstst
6 M 8	S 500	15,30 Kunstst
8 M 10	S 500	19,60 Kunstst
10 M 12	S 200	21,40 Kunstst
12 M 14	S 200	26,50 Kunstst
14 M 16, M 18	S 200	30,00 Kunstst
17 M 20, M 22	S 200	37,50 Kunstst

Abmessungen VE Stück €/100/Obf.

Artikel	88277.700
---------	-----------

88277 Aluminium

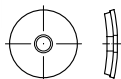

Dichtscheiben, gewölbte Metallscheiben mit aufvulkanisierter Dichtungslage

Dicke der Dichtung ca. 1,5 mm dick

Werkstoffeigensch. → [TI-239](#) REACH → [TI-262](#)

Rostfrei → [S. 603](#)



Außen Ø x Innen Ø x Dicke

16	x	6,8	x	1	S	1000	7,90 Al
----	---	-----	---	---	---	------	---------

Artikel	88494.600
---------	-----------

88494 Kunststoff PA 6 naturfarben



DUBO-Profilscheiben für Sechskantschrauben

Maße → [TI-109](#) REACH → [TI-262](#)

Werkstoffeigensch. → [TI-239](#)

Nenn-Nummer – für Schrauben x Profilhöhe

198 - M 3	x	2,2	S	100	22,60
199 - M 4	x	2,6	S	100	24,90
200 - M 5	x	3	S	100	26,50
201 - M 6	x	3,5	S	100	30,00
203 - M 8	x	4	S	100	38,50
205 - M 10	x	4,7	S	100	48,00
207 - M 12	x	5	S	100	71,00
209 - M 14	x	5,5	S	50	141,00
211 - M 16	x	6	S	50	114,00
213 - M 18	x	6,5	S	50	231,00
215 - M 20	x	7	S	50	179,00
217 - M 22	x	7,5	S	25	295,00
219 - M 24	x	8	S	25	295,00
222 - M 27	x	8,5	S	25	395,00
225 - M 30	x	8,5	S	25	400,00
231 - M 36	x	10	S	1	720,00
243 - M 48	x	17	S	1	1400,00

Abmessungen VE Stück €/100/Obf.

Artikel	88495.600
---------	-----------

88495 Kunststoff PA 6 naturfarben



DUBO-Profilscheiben für Zylinderschrauben mit Innensechskant

Maße → [TI-110](#) REACH → [TI-262](#)

Werkstoffeigensch. → [TI-239](#)

Nenn-Nummer – für Schrauben x Profilhöhe

299 - M 4	x	2	S	100	22,30
300 - M 5	x	3	S	100	23,60
301 - M 6	x	2,5	S	100	22,90
303 - M 8	x	3,3	S	100	31,00
305 - M 10	x	3,8	S	100	38,50
307 - M 12	x	4,4	S	100	48,50
311 - M 16	x	5,6	S	50	90,00
315 - M 20	x	6,5	S	50	111,00

Artikel	88496.010
---------	-----------

88496 Stahl galvanisch verzinkt

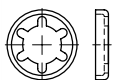

DUBO-Zahn-Tellerringe für DUBO-Profilscheiben

Maße → [TI-110](#) Korrosionsschutz → [TI-228](#)

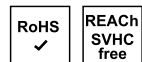

Nenn-Nummer – lichte Innenweite x Loch Ø

404-11,2	x	6,8	S	100	45,50 gal Zn
406-13,2	x	9	S	100	48,50 gal Zn
408-17,2	x	12	S	100	59,00 gal Zn
410-21,3	x	13,5	S	100	75,00 gal Zn
412-24,5	x	15,5	S	100	85,00 gal Zn
414-27	x	17,5	S	50	95,00 gal Zn
416-31,25	x	21	S	50	128,00 gal Zn
417-33	x	23	S	50	128,00 gal Zn
418-37,5	x	26	S	50	148,00 gal Zn
419-39,5	x	27	S	50	630,00 gal Zn
422-44	x	30,5	S	25	217,00 gal Zn
427-50,5	x	35	S	25	247,00 gal Zn
430-56	x	40	S	25	510,00 gal Zn
433-61	x	45	S	1	580,00 gal Zn
436-67	x	50	S	1	640,00 gal Zn

Abmessungen VE Stück €/100/Obf.

Artikel	88497.(*)
---------	-----------

88497 Kunststoff



KORREX-Schutzkappen für Sechskantmuttern

weiß (*630), grau (*640), schwarz (*650)

REACH → [TI-262](#)

Temperaturbeständigkeit: -50 °C bis +110 °C

für Muttern / Schlüsselweite

f. M 4 / SW 7	S	100	12,20 Kunstst
f. M 5 / SW 8	S	100	17,40 Kunstst
f. M 6 / SW 10	S	100	15,00 Kunstst
f. M 7 / SW 11	S	100	20,20 Kunstst
f. M 8 / SW 13	S	100	16,30 Kunstst
f. M 10 / SW 17	S	100	19,70 Kunstst
f. M 12 / SW 19	S	100	30,00 Kunstst
f. M 16 / SW 24	S	50	49,50 Kunstst
f. M 20 / SW 30	S	50	77,00 Kunstst
f. M 24 / SW 36	S	50	450,00 Kunstst

Artikel	88498.630
---------	-----------

88498 Kunststoff PA 6 weiss



KORREX-Isolierhülsen

Achtung!
Größere Durchgangsbohrung erforderlich.

Maße → [TI-114](#) REACH → [TI-262](#)

Werkstoffeigensch. → [TI-239](#)

für Schrauben x Hülsenschaftlänge

M 4	x	10	S	100	18,80
M 4	x	15	S	100	19,60
M 4	x	20	S	100	20,40
M 5	x	10	S	100	21,90
M 5	x	15	S	100	22,70
M 5	x	20	S	100	23,50
M 6	x	10	S	100	28,00
M 6	x	15	S	100	29,00
M 6	x	20	S	100	30,50
M 8	x	10	S	100	32,00
M 8	x	15	S	100	33,50
M 8	x	22	S	100	35,00
M 10	x	10	S	100	41,00
M 10	x	20	S	100	43,50
M 10	x	25	S	100	46,00
M 12	x	15	S	100	57,00
M 12	x	25	S	100	64,00
M 16	x	10	S	100	75,00
M 16	x	15	S	100	81,00
M 16	x	20	S	100	85,00
M 16	x	25	S	100	88,00
M 20	x	15	S	100	95,00
M 20	x	20	S	100	100,00
M 20	x	25	S	100	103,00

Abmessungen	VE Stück	€/100/Obf.
Artikel	88499.630	
88499	Kunststoff PA 6 weiss	



KORREX-Rosetten für Senk- und Linsenköpfe

Maße → **TI-114** REACH → **TI-262**
 Werkstoffeigensch. → **TI-239**

Nenn-Nummer – für Schrauben Ø x Höhe

803 - M 3	x	2,0	S	100	9,00
804 - M 4	x	3,1	S	100	12,70
805 - M 5	x	3,5	S	100	16,40
806 - M 6	x	4,6	S	100	23,30
808 - M 8	x	6,0	S	100	36,50

Artikel	88917.334
88917	EPDM schwarz

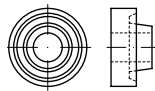

EPDM-Dichtung zur Verwendung mit Stockschrauben in Solaranlagen für Gewinde Ø M 10 und M 12

REACH → **TI-262**

für M 10/ M 12	S	5000	275,00 EPDM
----------------	---	------	-------------

Abmessungen	VE Stück	€/100/Obf.
Artikel	88964.730	
88964	Messing galvanisch vernickelt	

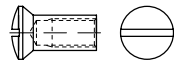

Hülsenmuttern mit Linsenkopf, mit Innengewinde

Maße → **TI-79** REACH → **TI-262**
 Werkstoffeigensch. → **TI-239**



Innengewinde M x Länge

M 4	x	7	S	200	57,00 Ms Ni
M 4	x	12	S	200	34,00 Ms Ni
M 4	x	20	S	200	97,00 Ms Ni
M 5	x	15	S	100	55,00 Ms Ni
M 6	x	15	S	100	59,00 Ms Ni
M 6	x	20	S	100	96,00 Ms Ni
M 8	x	20	S	100	154,00 Ms Ni

Artikel	88965.730
88965	Messing Form R 1 galvanisch vernickelt



Rosettenscheiben, Auflage offen, für Senk- und Linsenköpfe

Innensenkung 90°

Maße → **TI-115** REACH → **TI-262**
 Werkstoffeigensch. → **TI-239**



Loch Ø x für Kopf bis Ø x Höhe

3,0	x	7,0	x	2,1	S	1000	35,00 Ms Ni
4,1	x	6,5	x	1,8	S	1000	40,50 Ms Ni
5,0	x	9,0	x	2,3	S	1000	45,50 Ms Ni
6,0	x	10,0	x	2,3	S	1000	47,00 Ms Ni
7,0	x	12,5	x	3,2	S	100	119,00 Ms Ni
8,6	x	13,0	x	3	S	100	181,00 Ms Ni

Abmessungen	VE Stück	€/100/Obf.
Artikel	88966.730	
88966	Messing Form R 4 galvanisch vernickelt	



Rosettenscheiben, Auflage geschlossen, für Senk- und Linsenköpfe

Innensenkung 90°

Maße → **TI-115** REACH → **TI-262**
 Werkstoffeigensch. → **TI-239**



Loch Ø x für Kopf bis Ø x Höhe

4,8	x	8,8	x	2,7	S	200	59,00 Ms Ni
5,0	x	8,0	x	2,4	S	200	64,00 Ms Ni
6,0	x	10,5	x	3	S	100	80,00 Ms Ni
7,0	x	12,0	x	3,4	S	100	96,00 Ms Ni



- ✓ Große Artikelvielfalt
- ✓ Verlässliche Qualität
- ✓ Hohe Lieferbereitschaft

Abmessungen	VE Stück	€/100/Obf.
Artikel 82500.604		
82500 PA 6.6 natur (NA)	T	

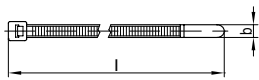

Kabelbinder, innenverzahnt, T = Standard

Produktinformation → TI-144

HF Halogenfrei	Brandschutz UL94 V2	RoHS	REACH SVHC free
----------------	---------------------	------	-----------------

Breite B x Länge l ges./Bündel Ø max.

2,3	x	83 / 16	S	1000	6,40
2,5	x	100 / 22	S	100	5,80
2,5	x	145 / 35	S	100	8,90
2,5	x	200 / 50	S	100	10,70
2,8	x	240 / 65	S	100	16,80
3,3	x	260 / 65	S	100	23,50
3,5	x	150 / 35	S	100	10,20
3,5	x	200 / 50	S	100	14,40
3,5	x	285 / 80	S	100	28,00
4,0	x	175 / 40	S	100	13,10
4,6	x	150 / 35	S	100	13,80
4,6	x	390 / 108	S	100	37,00
4,7	x	210 / 55	S	100	13,50
4,7	x	300 / 85	S	100	37,00
7,6	x	225 / 55	S	50	63,00
7,6	x	365 / 100	S	100	49,00
7,6	x	390 / 108	S	100	55,00
7,6	x	460 / 125	S	100	78,00
7,6	x	760 / 220	S	50	136,00
8,9	x	530 / 150	S	25	104,00
8,8	x	820 / 245	S	25	153,00
8,9	x	1095 / 330	S	25	280,00

Artikel	82505.600
82505 PA 6.6 HS natur (NA)	T-HS

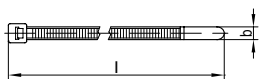

Kabelbinder, innenverzahnt, T = Standard HS = hitzestabil

Produktinformation → TI-144

HF Halogenfrei	Brandschutz UL94 V2	RoHS	REACH SVHC free
----------------	---------------------	------	-----------------

Breite B x Länge l ges./Bündel Ø max.

2,5	x	100 / 22	S	100	6,80
2,5	x	145 / 35	S	1000	10,70
2,5	x	200 / 50	S	100	12,70
3,3	x	260 / 65	S	100	29,00
3,5	x	150 / 35	S	100	12,30
3,5	x	200 / 50	S	100	17,50
3,5	x	300 / 75	S	100	49,50
4,0	x	180 / 42	S	100	15,70
4,6	x	150 / 35	S	100	16,50
4,6	x	300 / 81	S	100	34,00
4,7	x	210 / 55	S	100	16,20
4,7	x	390 / 110	S	100	44,00

Abmessungen	VE Stück	€/100/Obf.
7,5 x 360 / 100	S 100	59,00
7,5 x 390 / 108	S 100	67,00

Artikel	82505.630
82505 PA 6.6 HS schwarz (BK)	T-HS

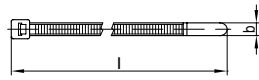

Kabelbinder, innenverzahnt, T = Standard HS = hitzestabil

Produktinformation → TI-144

HF Halogenfrei	Brandschutz UL94 V2	RoHS	REACH SVHC free
----------------	---------------------	------	-----------------

Breite B x Länge l ges./Bündel Ø max.

2,5	x	100 / 22	S	100	6,50
3,5	x	150 / 35	S	100	11,80
4,6	x	150 / 35	S	100	15,80
4,6	x	300 / 81*	S	1000	53,00
7,6	x	365 / 100	S	100	57,00
7,6	x	760 / 220	S	50	145,00

Artikel	82510.630
82510 PA 6.6 W schwarz (BK)	T-W

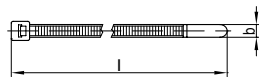

Kabelbinder, innenverzahnt, T = Standard W = witterungsstabil

Produktinformation → TI-144

HF Halogenfrei	Brandschutz UL94 V2	RoHS	REACH SVHC free
----------------	---------------------	------	-----------------

Breite B x Länge l ges./Bündel Ø max.

2,5	x	100 / 22	S	100	6,80
2,5	x	145 / 35	S	100	10,70
2,5	x	200 / 50	S	100	12,70
2,8	x	330 / 95	S	100	40,50
3,3	x	260 / 65	S	100	29,00
3,5	x	150 / 35	S	100	12,30
3,5	x	190 / 50	S	100	17,50
3,5	x	285 / 80	S	100	39,50
4,0	x	180 / 42	S	100	15,70
4,6	x	150 / 35	S	100	16,50
4,7	x	210 / 55	S	100	16,20
4,7	x	300 / 85	S	100	44,50
4,7	x	390 / 110	S	100	44,00
7,6	x	225 / 55	S	50	73,00
7,6	x	365 / 100	S	100	59,00
7,6	x	390 / 108	S	100	67,00
7,6	x	465 / 130	S	100	69,00
7,6	x	760 / 220	S	50	151,00
8,8	x	813 / 222	S	25	197,00
8,9	x	525 / 150	S	25	166,00

Abmessungen	VE Stück	€/100/Obf.
Artikel 82515.600		
82515 PA 4.6 HR/N46 natur (NA)	T-HR	

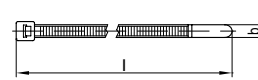

Kabelbinder, innenverzahnt, T = Standard HR = hochtemperaturbeständig

Produktinformation → TI-144

HF Halogenfrei	Brandschutz UL94 V2	RoHS	REACH SVHC free
----------------	---------------------	------	-----------------

Breite B x Länge l ges./Bündel Ø max.

2,5	x	100 / 22	S	1000	32,50
3,5	x	150 / 35	S	100	65,00
4,6	x	200 / 50	S	100	129,00
4,6	x	390 / 110	S	100	320,00
7,6	x	390 / 108	S	100	420,00

Artikel	82520.600
82520 PA 6.6 natur (NA)	LK 2/LK 5

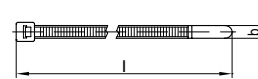

Kabelbinder, innenverzahnt, LK = erhöhte Abbindekraft LK 2 = 4,8 Ø, LK 5: Breite = 13,2 Ø

Produktinformation → TI-145

HF Halogenfrei	Brandschutz UL94 V2	RoHS	REACH SVHC free
----------------	---------------------	------	-----------------

Breite B x Länge l ges./Bündel Ø max.

4,8	x	120 / 28	S	200	17,50
13,0	x	535 / 150	S	50	207,00

Artikel	82516.630
82516 PA 11 schwarz (BK)	Robusto

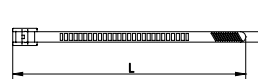

Kabelbinder, außenverzahnt, Robusto-Serie, mit flacher Kopfgeometrie

Produktinformation → TI-145

HF Halogenfrei	Brandschutz UL94 HB	RoHS	REACH SVHC free
----------------	---------------------	------	-----------------

Breite B x Länge l ges./Bündel Ø max.

9,0	x	180 / 42	S	100	71,00
9,0	x	260 / 62	S	100	104,00
9,0	x	355 / 92	S	100	148,00

Abmessungen	VE Stück	€/100/Obf.
Artikel 82517.630		
82517 PA66W* Q-tie		
		schwarz (BK)



Kabelbinder, innenverzahnt, Q-tie = mit offenen Bindekopf und Vorverriegelung

*W = UV-Witterungsstabil

Produktinformation → TI-145

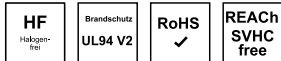

Breite B x Länge l ges./Bündel Ø max.

3,6	x 160 / 38	S 100	13,50
4,7	x 210 / 50	S 100	20,30
7,7	x 420 / 110	S 100	89,00

Artikel	82518.630	
82518 PA66HIR* Coupler		
		schwarz (BK)



Kabelbinder mit Befestigungselement, 2-teilig zur Parallelführung zweier Kabelbündel

*HIR = schlagzäh

Produktinformation → TI-145

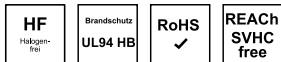

Breite B x Länge l ges./Bündel Ø max.

4,6	x 200 / 50	S 500	172,00
7,6	x 380 / 100	S 250	265,00

Artikel	82521.634	
82521 PA66W* EdgeCl. 0-A		
		schwarz (BK)

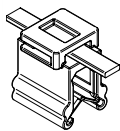

Kantenbefestigungsbinder 2-teilig, für Kantenbreite 1 - 3 mm, 0 = Aufnahme oben A = Binderführung axial

*W = UV-Witterungsstabil

Produktinformation → TI-146

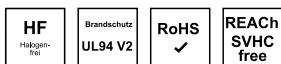

Breite B x Länge l ges./Bündel Ø max.

4,6	x 200 / 45	S 500	161,00
-----	------------	-------	--------

Abmessungen	VE Stück	€/100/Obf.
Artikel 82522.635		
82522 PA66HS* EdgeCl. S-A		
		schwarz (BK)

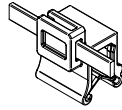

Kantenbefestigungsbinder 2-teilig, für Kantenbreite 1 - 3 mm, S = Aufnahme seitlich A = Binderführung axial

*HS = hitzestabil

Produktinformation → TI-146



Breite B x Länge l ges./Bündel Ø max.

4,6	x 150 / 31	S 500	128,00
4,6	x 200 / 45	S 500	135,00

Artikel	82522.634	
82522 PA66HS* EdgeCl. S-Q		
		schwarz (BK)

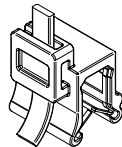

Kantenbefestigungsbinder 2-teilig, für Kantenbreite 1 - 3 mm, S = Aufnahme seitlich Q = Binderführung quer

*HS = hitzestabil

Produktinformation → TI-146



Breite B x Länge l ges./Bündel Ø max.

3,6	x 150 / 33	S 500	127,00
4,6	x 200 / 45	S 500	132,00

Abmessungen	VE Stück	€/100/Obf.
Artikel 82523.634		
82523 PA66HS* EdgeCl. 0-A		
		schwarz (BK)

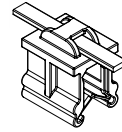

Kantenbefestigungsbinder 2-teilig, für Kantenbreite 3 - 6 mm, 0 = Aufnahme oben A = Binderführung axial

*HS = hitzestabil

Produktinformation → TI-147



Breite B x Länge l ges./Bündel Ø max.

4,6	x 200 / 45	S 500	207,00
-----	------------	-------	--------

Artikel	82523.635	
82523 PA66HS* EdgeCl. 0-Q		
		schwarz (BK)

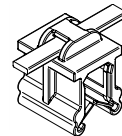

Kantenbefestigungsbinder 2-teilig, für Kantenbreite 3 - 6 mm, 0 = Aufnahme oben Q = Binderführung quer

*HS = hitzestabil

Produktinformation → TI-147



Breite B x Länge l ges./Bündel Ø max.

4,6	x 150 / 35	S 500	204,00
4,6	x 200 / 45	S 500	207,00



- ✓ Große Artikelvielfalt
- ✓ Verlässliche Qualität
- ✓ Hohe Lieferbereitschaft

Abmessungen	VE Stück	€/100/Obf.
Artikel	82523.637	
82523	PA66HS*	EdgeCl. S-A
	schwarz (BK)	

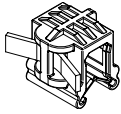

Kantenbefestigungsbinder 2-teilig, für Kantenbreite 3 - 6 mm, S = Aufnahme seitlich A = Binderführung axial

*HS = hitzestabil

Produktinformation → [TI-147](#)

HF Halogenfrei	Brandschutz UL94 V2	Brandschutz UL94 HB	RoHS ✓	REACH SVHC free
-------------------	------------------------	------------------------	-----------	--------------------

Breite B x Länge l ges./Bündel Ø max.

4,6	x	200/45	S	500	232,00
-----	---	--------	---	-----	--------

Artikel	82523.636
82523	PA66HS*
	schwarz (BK)
	EdgeCl. S-Q

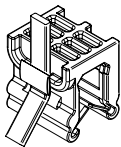

Kantenbefestigungsbinder 2-teilig, für Kantenbreite 3 - 6 mm, S = Aufnahme seitlich Q = Binderführung quer

*HS = hitzestabil

Produktinformation → [TI-147](#)

HF Halogenfrei	Brandschutz UL94 V2	Brandschutz UL94 HB	RoHS ✓	REACH SVHC free
-------------------	------------------------	------------------------	-----------	--------------------

Breite B x Länge l ges./Bündel Ø max.

4,6	x	200	S	500	232,00
-----	---	-----	---	-----	--------

Abmessungen	VE Stück	€/100/Obf.
Artikel	82535.000	
82535	Kunststoff	EV07

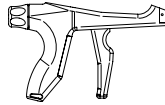

Manuelles Verarbeitungswerkzeug für Abbinden von Kabelbindern mit geringem Kraftaufwand, mit Schneidevorrichtung

max. Binderbreite 4,8 mm
max. Binderstärke 1,5 mm
Gewicht 0,28 kg

Produktinformation → [TI-147](#)

REACH SVHC free

EV07	S	1	61900,00
------	---	---	----------

Artikel	82540.600
82540	PA 6.6
	natur (NA)
	TY-G1/SK

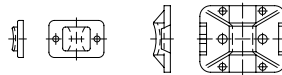

Befestigungssockel für Kabelbinder, Typ TY-G1, SK = selbstklebend*

*Acrylat

Produktinformation → [TI-148](#)

HF Halogenfrei	Brandschutz UL94 V2	RoHS ✓	REACH SVHC free
-------------------	------------------------	-----------	--------------------

Für Kabelbinder-Breite max.

4	S	100	106,00
8	S	100	137,00

Artikel	82543.600
82543	PA 6.6
	natur (NA)
	NY/SB

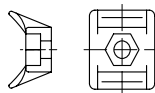

Befestigungssockel für Kabelbinder, Typ NY, SB = schraubbar

Produktinformation → [TI-148](#)

HF Halogenfrei	Brandschutz UL94 V2	RoHS ✓	REACH SVHC free
-------------------	------------------------	-----------	--------------------

Für Kabelbinder-Breite max.

8	S	1000	20,70
---	---	------	-------

Abmessungen	VE Stück	€/100/Obf.
Artikel	82546.600	
82546	PA 6.6	LKC/SB
	natur (NA)	

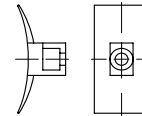

Befestigungssockel für Kabelbinder, Typ LKC, SB = schraubbar

Produktinformation → [TI-148](#)

HF Halogenfrei	Brandschutz UL94 V2	RoHS ✓	REACH SVHC free
-------------------	------------------------	-----------	--------------------

Für Kabelbinder-Breite max.

8	S	100	37,00
---	---	-----	-------

Artikel	82550.600
82550	PA 6.6
	natur (NA)
	MB-CA/SK

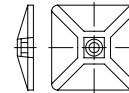

Befestigungssockel für Kabelbinder, Typ MB-CA, SK = selbstklebend*

*synthetischer Kautschuk

Produktinformation → [TI-148](#)

HF Halogenfrei	Brandschutz UL94 V2	RoHS ✓	REACH SVHC free
-------------------	------------------------	-----------	--------------------

Für Kabelbinder-Breite max.

5,4	S	100	127,00
-----	---	-----	--------

Artikel	82553.600
82553	PA 6.6
	natur (NA)
	MB-A/SK

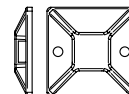

Befestigungssockel für Kabelbinder, Typ MB-A, SK = selbstklebend*

*synthetischer Kautschuk

Produktinformation → [TI-148](#)

HF Halogenfrei	Brandschutz UL94 V2	RoHS ✓	REACH SVHC free
-------------------	------------------------	-----------	--------------------

Für Kabelbinder-Breite max.

5,4	S	100	137,00
-----	---	-----	--------

Abmessungen	VE Stück	€/100/Obf.
Artikel	82554.600	
82554	PA 6.6 MB-AT	
	natur (NA)	

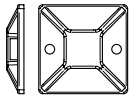

Befestigungssockel für Kabelbinder mit Spezialkleber*, SolidTack-Serie Typ MB-AT

*mod. Acrylat

Produktinformation → TI-149



Für Kabelbinder-Breite max. - L x B

4,1 - 19	x	19	S	100	199,00
5,4 - 28	x	28	S	100	265,00

Artikel	82554.630	
82554	PA 6.6 MB-AT	
	schwarz (BK)	

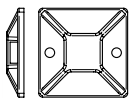

Befestigungssockel für Kabelbinder mit Spezialkleber*, SolidTack-Serie Typ MB-AT

*mod. Acrylat

Produktinformation → TI-149

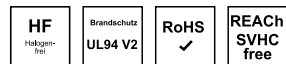

Für Kabelbinder-Breite max. - L x B

4,1 - 19	x	19	S	100	199,00
5,4 - 28	x	28	S	100	265,00
10 - 38	x	38	S	100	530,00

Artikel	82560.600	
82560	PA 6.6 CL 8/SB	
	natur (NA)	

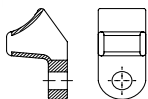

Befestigungsösen für Kabelbinder, Typ CL 8, SB = schraubbar

Produktinformation → TI-149

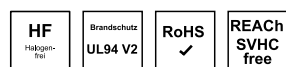

Für Kabelbinder-Breite max.

8	S	100	23,10
---	---	-----	-------

Abmessungen	VE Stück	€/100/Obf.
Artikel	82580.640	
82580	PP HWPP	
	grau	

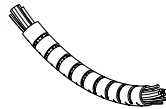

Kabelbündelschlauch Helawrap, Länge = 2 m, inklusive Aufziehwerkzeug

Betriebstemperatur -60 bis +110 °C
kurzzeitig bis +140 °C

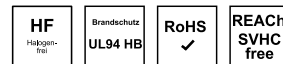

für Bündel Ø

16	S	1	3100,00
27	S	1	4050,00

Artikel	82580.630	
82580	PP HWPP	
	schwarz	

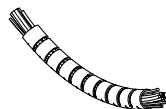

Kabelbündelschlauch Helawrap, Länge = 2 m, inklusive Aufziehwerkzeug

Betriebstemperatur -60 bis +110 °C
kurzzeitig bis +140 °C



für Bündel Ø

16	S	1	3100,00
27	S	1	4050,00

Artikel	82565.000	
82565	PA 6.6 BMS-100	
	natur schw. (NA/BK)	



Sortimentsbox "BMS - 100" mit Befestigungsteilen für Kabelbinder, 12 Fächer/17 Sorten/192 Stück Sockel, Schellen, Snapper

Setzwerkzeuge auf Anfrage



BMS - 100	S	1	12000,00
-----------	---	---	----------

Abmessungen	VE Stück	€/100/Obf.
Artikel	82001.014	
82001	GTW 40 A-K	
	galvanisch verzinkt	

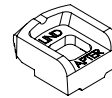

LINDAPTER-Klemmen A-K, A = mit Rezz (Kopf-Drehsperr) K = kurze Nockenhöhe

Ausgleichscheibe CW → 82011
Ausgleichscheibe P1K → 82012
Ausgleichscheibe P2K → 82013
Rezzfüllplatte W → 82021

Produktinformation → TI-156

Für hohe Schubkräfte
→ Typ AF → Artikel 82040-82044
ETA-13/0300, DoP003



Für Schr. Ø / Nockenhöhe

KM 10 / 4,0**	S	1	194,00
KM 12 / 4,5	S	1	270,00
KM 16 / 5,5	S	1	373,00
KM 20 / 7,0	S	1	524,00
KM 24 / 9,0	S	1	1426,00

Artikel	82001.016	
82001	GTW 40 A-M	
	galvanisch verzinkt	

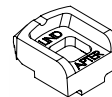

LINDAPTER-Klemmen A-M, A = mit Rezz (Kopf-Drehsperr) M = mittlere Nockenhöhe

Ausgleichscheibe CW → 82011
Ausgleichscheibe P1K → 82012
Ausgleichscheibe P2K → 82013
Rezzfüllplatte W → 82021

Produktinformation → TI-156

Für hohe Schubkräfte → Typ AF
→ Artikel 82040-82044
ETA-13/0300, DoP003



Für Schr. Ø / Nockenhöhe

MM 8 / 4,0**	S	1	98,00
MM 10 / 5,0**	S	1	194,00
MM 12 / 6,0	S	1	270,00
MM 16 / 8,0	S	1	373,00
MM 20 / 10,0	S	1	524,00
MM 24 / 12,0	S	1	1426,00

Abmessungen	VE Stück	€/100/Obf.
Artikel 82001.015	GTW 40	A-L
82001	galvanisch verzinkt	

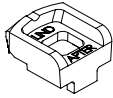

LINDAPTER-Klemmen A-L,
A = mit Rezz (Kopf-Drehsperr)
L = lange Nockenhöhe

Ausgleichscheibe CW → 82011
 Ausgleichscheibe P1K → 82012
 Ausgleichscheibe P2K → 82013
 Rezzfüllplatte W → 82021

Produktinformation → [TI-156](#)

Für hohe Schubkräfte → Typ AF
 → Artikel 82040-82044
 ETA-13/0300, DoP003



Für Schrauben Ø / Nockenhöhe

LM 10 / 7,0**	S	1	194,00
LM 12 / 9,5	S	1	270,00
LM 16 / 11,0	S	1	373,00
LM 20 / 12,5	S	1	524,00
LM 24 / 16,0	S	1	1426,00

Artikel	82001.024
82001	GTW 40
	feuerverzinkt
	A-K

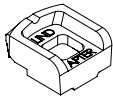

LINDAPTER-Klemmen A-K,
A = mit Rezz (Kopf-Drehsperr)
K = kurze Nockenhöhe

Ausgleichscheibe CW → [82011](#)
 Ausgleichscheibe P1K → [82012](#)
 Ausgleichscheibe P2K → [82013](#)
 Rezzfüllplatte W → [82021](#)

Produktinformation → [TI-156](#)

Für hohe Schubkräfte → Typ AF
 → Artikel 82040-82044
 ETA-13/0300, DoP003



Für Schrb. Ø / Nockenhöhe

KM 10 / 4,0	S	1	233,00
KM 12 / 4,5	S	1	323,00
KM 16 / 5,5	S	1	448,00
KM 20 / 7,0	S	1	630,00
KM 24 / 9,0	S	1	1711,00

Abmessungen	VE Stück	€/100/Obf.
Artikel 82001.026	GTW 40	A-M
82001	feuerverzinkt	

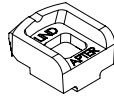

LINDAPTER-Klemmen A-M,
A = mit Rezz (Kopf-Drehsperr)
M = mittlere Nockenhöhe

Ausgleichscheibe CW → 82011
 Ausgleichscheibe P1K → 82012
 Ausgleichscheibe P2K → 82013
 Rezzfüllplatte W → 82021

Produktinformation → [TI-156](#)

Für hohe Schubkräfte → Typ AF
 → Artikel 82040-82044
 ETA-13/0300, DoP003



Für Schrb. Ø / Nockenhöhe

MM 10 / 5,0**	S	1	233,00
MM 12 / 6,0	S	1	323,00
MM 16 / 8,0	S	1	448,00
MM 20 / 10,0	S	1	630,00
MM 24 / 12,0	S	1	1711,00

Artikel	82001.025
82001	GTW 40
	feuerverzinkt
	A-L

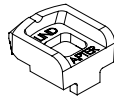

LINDAPTER-Klemmen A-L,
A = mit Rezz (Kopf-Drehsperr)
L = lange Nockenhöhe

Ausgleichscheibe CW → 82011
 Ausgleichscheibe P1K → 82012
 Ausgleichscheibe P2K → 82013
 Rezzfüllplatte W → 82021

Produktinformation → [TI-156](#)

Für hohe Schubkräfte → Typ AF
 → Artikel 82040-82044
 ETA-13/0300, DoP003



Für Schrb. Ø / Nockenhöhe

LM 10 / 7,0**	S	1	233,00
LM 12 / 9,5	S	1	323,00
LM 16 / 11,0	S	1	448,00
LM 20 / 12,5	S	1	630,00
LM 24 / 16,0	S	1	1711,00

Abmessungen	VE Stück	€/100/Obf.
Artikel 82002.014	GTW 40	B-K
82002	galvanisch verzinkt	

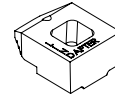

LINDAPTER-Klemmen B-K,
B = mit glatter Auflage
K = kurze Nockenhöhe

Ausgleichscheibe CW → 82011
 Ausgleichscheibe P1K → 82012
 Ausgleichscheibe P2K → 82013
 Rezzfüllplatte W → 82021

Produktinformation → [TI-156](#)

Für hohe Schubkräfte → Typ AF
 → Artikel 82040-82044
 ETA-13/0300, DoP003



Für Schrb. Ø / Nockenhöhe

KM 10 / 4,0**	S	1	263,00
KM 12 / 4,5	S	1	353,00
KM 16 / 5,5	S	1	533,00
KM 20 / 7,0	S	1	876,00
KM 24 / 9,0	S	1	1858,00

Artikel	82002.016
82002	GTW 40
	galvanisch verzinkt
	B-M

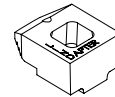

LINDAPTER-Klemmen B-M,
B = mit glatter Auflage
M = mittlere Nockenhöhe

Ausgleichscheibe CW → 82011
 Ausgleichscheibe P1K → 82012
 Ausgleichscheibe P2K → 82013
 Rezzfüllplatte W → 82021

Produktinformation → [TI-156](#)

Für hohe Schubkräfte → Typ AF
 → Artikel 82040-82044
 ETA-13/0300, DoP003



Für Schrb. Ø / Nockenhöhe

MM 8 / 4,0**	S	1	138,00
MM 10 / 5,0**	S	1	263,00
MM 12 / 6,0	S	1	353,00
MM 16 / 8,0	S	1	533,00
MM 20 / 10,0	S	1	876,00
MM 24 / 12,0	S	1	1858,00

Abmessungen	VE Stück	€/100/Obf.
Artikel 82002.015	GTW 40	B-L
82002	galvanisch verzinkt	

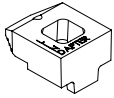

LINDAPTER-Klemmen B-L, B = mit glatter Auflage L = lange Nockenhöhe

Ausgleichscheibe CW → 82011
Ausgleichscheibe P1K → 82012
Ausgleichscheibe P2K → 82013
Rezessfüllplatte W → 82021

Produktinformation → [TI-156](#)

Für hohe Schubkräfte → Typ AF
→ Artikel 82040-82044
ETA-13/0300, DoP003



Für Schrb. Ø / Nockenhöhe

LM 10 / 7,0**	S	1	263,00
LM 12 / 9,5	S	1	353,00
LM 16 / 11,0	S	1	533,00
LM 20 / 12,5	S	1	876,00
LM 24 / 16,0	S	1	1858,00

Artikel	82002.024		
82002	GTW 40	B-K	
	feuerverzinkt		

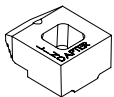

LINDAPTER-Klemmen B-K, B = mit glatter Auflage K = kurze Nockenhöhe

Ausgleichscheibe CW → 82011
Ausgleichscheibe P1K → 82012
Ausgleichscheibe P2K → 82013
Rezessfüllplatte W → 82021

Produktinformation → [TI-156](#)

Für hohe Schubkräfte → Typ AF
→ Artikel 82040-82044
ETA-13/0300, DoP003



Für Schrb. Ø / Nockenhöhe

KM 10 / 4,0**	S	1	315,00
KM 12 / 4,5	S	1	424,00
KM 16 / 5,5	S	1	639,00
KM 20 / 7,0	S	1	1052,00
KM 24 / 9,0	S	1	2230,00

Abmessungen	VE Stück	€/100/Obf.
Artikel 82002.026	GTW 40	B-M
82002	feuerverzinkt	

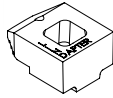

LINDAPTER-Klemmen B-M, B = mit glatter Auflage M = mittlere Nockenhöhe

Ausgleichscheibe CW → 82011
Ausgleichscheibe P1K → 82012
Ausgleichscheibe P2K → 82013
Rezessfüllplatte W → 82021

Produktinformation → [TI-156](#)

Für hohe Schubkräfte → Typ AF
→ Artikel 82040-82044
ETA-13/0300, DoP003



Für Schrb. Ø / Nockenhöhe

MM 10 / 5,0**	S	1	315,00
MM 12 / 6,0	S	1	424,00
MM 16 / 8,0	S	1	639,00
MM 20 / 10,0	S	1	1052,00
MM 24 / 12,0	S	1	2230,00

Artikel	82002.025		
82002	GTW 40	B-L	
	feuerverzinkt		

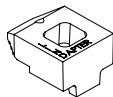

LINDAPTER-Klemmen B-L, B = mit glatter Auflage L = lange Nockenhöhe

Ausgleichscheibe CW → 82011
Ausgleichscheibe P1K → 82012
Ausgleichscheibe P2K → 82013
Rezessfüllplatte W → 82021

Produktinformation → [TI-156](#)

Für hohe Schubkräfte → Typ AF
→ Artikel 82040-82044
ETA-13/0300, DoP003



Für Schrb. Ø / Nockenhöhe

LM 10 / 7,0**	S	1	315,00
LM 12 / 9,5	S	1	424,00
LM 16 / 11,0	S	1	639,00
LM 20 / 12,5	S	1	1052,00
LM 24 / 16,0	S	1	2230,00

Abmessungen	VE Stück	€/100/Obf.
Artikel 82011.010	Stahl	CW
82011	galvanisch verzinkt	



LINDAPTER-Ausgleichscheiben CW

für Klemmen A, B, BS

Produktinformation → [TI-156](#)

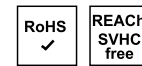

Für Schrauben Ø / Dicke t

M 8 / 2,0	S	1	49,00
M 10 / 2,0**	S	1	49,00
M 12 / 2,5	S	1	57,00
M 16 / 3,0	S	1	93,00
M 20 / 4,0	S	1	111,00
M 24 / 4,0	S	1	256,00

Artikel	82011.020		
82011	Stahl	CW	
	feuerverzinkt		



LINDAPTER-Ausgleichscheiben CW

für Klemmen A, B, BS

Produktinformation → [TI-156](#)

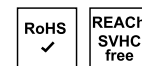

Für Schrauben Ø / Dicke t

M 12 / 2,5	S	1	69,00
M 16 / 3,0	S	1	112,00
M 20 / 4,0	S	1	134,00
M 24 / 4,0	S	1	308,00

Artikel	82012.014		
82012	GTW 40	P 1-K	
	galvanisch verzinkt		

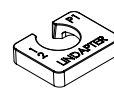

LINDAPTER-Ausgleichscheiben P 1, K = kurz

für Klemmen A, B, BS

Produktinformation → [TI-156](#)

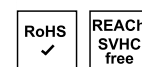

Für Schrauben Ø / Dicke t

M 8 / 4,0**	S	1	122,00
M 10 / 5,0**	S	1	93,00
M 12 / 6,0	S	1	104,00
M 16 / 8,0	S	1	133,00

Abmessungen	VE	Stück	€/100/Obf.
M 20 / 10,0	S	1	235,00
M 24 / 12,0	S	1	533,00

Artikel	82012.024
82012	GTW 40 P 1-K feuerverzinkt

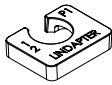

LINDAPTER-Ausgleichscheiben P 1, K = kurz

für Klemmen A, B, BS

Produktinformation → [TI-156](#)



Für Schrauben Ø / Dicke t

M 12 / 6,0	S	1	126,00
M 16 / 8,0	S	1	160,00
M 20 / 10,0	S	1	282,00
M 24 / 12,0	S	1	639,00

Artikel	82013.014
82013	Temperguss P 2-K galvanisch verzinkt

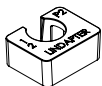

LINDAPTER-Ausgleichscheiben P 2, K = kurz

für Klemmen A, B, BS

Produktinformation → [TI-156](#)



Für Schrauben Ø / Dicke t

M 10 / 10,0 **	S	1	138,00
M 12 / 12,0	S	1	153,00
M 16 / 16,0	S	1	235,00
M 20 / 20,0	S	1	421,00
M 24 / 24,0	S	1	1295,00

Abmessungen	VE	Stück	€/100/Obf.
-------------	----	-------	------------

Artikel	82013.024
82013	Temperguss P 2-K feuerverzinkt

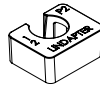

LINDAPTER-Ausgleichscheiben P 2, K = kurz

für Klemmen A, B, BS

Produktinformation → [TI-156](#)

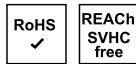

Für Schrauben Ø / Dicke t

M 10 / 10,0 **	S	1	166,00
M 12 / 12,0	S	1	184,00
M 16 / 16,0	S	1	282,00
M 20 / 20,0	S	1	507,00
M 24 / 24,0	S	1	1554,00

Artikel	82021.010
82021	Stahl W galvanisch verzinkt

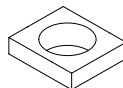

LINDAPTER-Rezessfüllplatten W, zur Erzielung glatter Auflagen

für Klemmen A, C1, D2

Produktinformation → [TI-156](#)

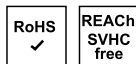

Für Schrauben Ø / Dicke t

W 10 / 5,5	S	1	202,00
W 12 / 6,5	S	1	250,00
W 16 / 8,0	S	1	345,00

Artikel	82021.020
82021	Stahl W feuerverzinkt

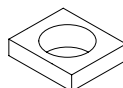

LINDAPTER-Rezessfüllplatten W, zur Erzielung glatter Auflagen

für Klemmen A, C1, D2

Produktinformation → [TI-156](#)



Für Schrauben Ø / Dicke t

W 10 / 5,5	S	1	242,00
------------	---	---	--------

Abmessungen	VE	Stück	€/100/Obf.
-------------	----	-------	------------

Artikel	82040.024
82040	Sphäroguß AF-K feuerverzinkt

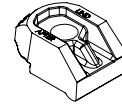

LINDAPTER-Klemmen AF für hohe Schubkräfte, K = kurze Nockenhöhe

Ausgleichscheibe AFCW → 82042
Ausgleichscheibe AFP1 → 82043
Ausgleichscheibe AFP2 → 82044
Rezessfüllplatte AFW → 82041

Produktinformation → [TI-156](#)

Zum Einsatz mit Schrauben Festigkeitsklasse 8.8 und 10.9 (HV-Schrauben nach EN 14399-4) ETA-15/0537, DoP004



Für Schrauben Ø

KM 12	S	1	888,00
KM 16	S	1	1240,00
KM 20	S	1	1572,00

Artikel	82040.025
82040	Sphäroguß AF-M feuerverzinkt

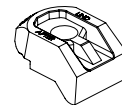

LINDAPTER-Klemmen AF für hohe Schubkräfte, M = mittlere Nockenhöhe

Ausgleichscheibe AFCW → 82042
Ausgleichscheibe AFP1 → 82043
Ausgleichscheibe AFP2 → 82044
Rezessfüllplatte AFW → 82041

Produktinformation → [TI-156](#)

Zum Einsatz mit Schrauben Festigkeitsklasse 8.8 und 10.9 (HV-Schrauben nach EN 14399-4) ETA-15/0537, DoP004



Für Schrauben Ø

MM 12	S	1	888,00
MM 16	S	1	1240,00
MM 20	S	1	1572,00

Abmessungen	VE Stück	€/100/Obf.
Artikel	82049.020	
82049	Sphäroguß	AAF
	feuerverzinkt	



LINDAPTER-Klemmen AAF für hohe Schubkräfte

Ausgleichscheibe AFCW → 82042
Ausgleichscheibe AFP1 → 82043
Ausgleichscheibe AFP2 → 82044
Rezessfüllplatte AFW → 82041

Produktinformation → [TI-156](#)

Zum Einsatz mit Schrauben Festigkeitsklasse 8.8 und 10.9 (HV-Schrauben nach EN 14399-4)
ETA-15/0537, DoP005



Für Schrauben Ø

M	S	1	Preis
M 12	S	1	1320,00
M 16	S	1	2120,00
M 20	S	1	4433,00

Artikel	82051.000	
82051		ALP

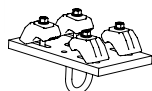

LINDAPTER-Hebeöse ALP für Montage- und Hebeaufgaben

für Lasten bis 3 Tonnen (29,4 kN) an Stahlträgern unter einem Hebewinkel von +/- 18°

Produktinformation → [TI-156](#)



ALP 3T-1	S	1	51800,00

Abmessungen	VE Stück	€/100/Obf.
Artikel	82045.020	
82045	GTW 40	CF
	feuerverzinkt	

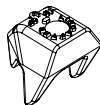

LINDAPTER-Klemmen CF mit Nase

für Profile, mit Stütznocke

Produktinformation → [TI-156](#)

ETA-15/0857, DoP011



Für Schrauben Ø

M	S	1	Preis
M 12	S	1	579,00
M 16	S	1	1169,00
M 20	S	1	1499,00

Artikel	82042.020	
82042	Stahl	AF-CW
	feuerverzinkt	

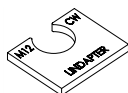

LINDAPTER-Ausgleichscheiben AF-CW, Dicke = 2 mm

für Klemmen AF

Produktinformation → [TI-156](#)

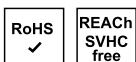

Für Schrauben Ø

AF M	S	1	Preis
AF M 12 CW	S	1	70,00
AF M 16 CW	S	1	84,00
AF M 20 CW	S	1	91,00

Artikel	82043.020	
82043	Stahl	AF-P 1
	feuerverzinkt	

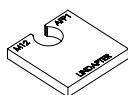

LINDAPTER-Ausgleichscheiben AF-P 1, Dicke = 5 mm

für Klemmen AF

Produktinformation → [TI-156](#)

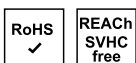

Für Schrauben Ø

AF M	S	1	Preis
AF M 12 P1	S	1	132,00
AF M 16 P1	S	1	167,00
AF M 20 P1	S	1	181,00
AF M 24 P1	S	1	750,00

Abmessungen	VE Stück	€/100/Obf.
Artikel	82044.020	
82044	Stahl	AF-P 2
	feuerverzinkt	

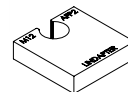

LINDAPTER-Ausgleichscheiben AF-P 2, Dicke = 10 mm

für Klemmen AF

Produktinformation → [TI-156](#)



Für Schrauben Ø

AF M	S	1	Preis
AF M 12 P2	S	1	368,00
AF M 16 P2	S	1	373,00
AF M 20 P2	S	1	448,00
AF M 24 P2	S	1	1000,00

Artikel	82041.020	
82041	Stahl	AF-W
	feuerverzinkt	

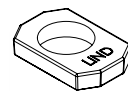

LINDAPTER-Rezessfüllplatten AF-W zur Erzielung glatter Auflagen

für Klemmen AF

Produktinformation → [TI-156](#)

- Erforderlich für Muttermontage
- Umgedreht eingelegt als Verdrehsicherung für HV-Schrauben M12 - M20



Für Schrauben Ø

AFW M	S	1	Preis
AFW M 12	S	1	367,00
AFW M 16	S	1	255,00
AFW M 20	S	1	420,00
AFW M 24	S	1	602,00

Abmessungen	VE Stück	€/100/Obf.
Artikel 82010.010		
82010 GTW 40 LR		
galvanisch verzinkt		

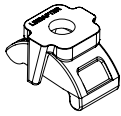

LINDAPTER-Klemmen LR, zweiteilig, Klemme mit Langloch und Sattel mit Verdreh Sperre

Ausgleichscheibe P1L → 82015
 Ausgleichscheibe P2L → 82016
 Rezessfüllplatte W → 82021

Produktinformation → [TI-156](#)

ETA-15/0857, DoP006



Für Schrauben Ø / Klemmbereich min - max.

M 10 / 3 - 10	S	1	359,00
M 12 / 3 - 12	S	1	484,00
M 16 / 3 - 16	S	1	883,00
M 20 / 3 - 20	S	1	1598,00
M 24 / 3 - 24	S	1	2534,00

Artikel	82010.020
82010 GTW 40 LR	
feuerverzinkt	

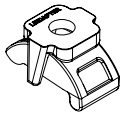

LINDAPTER-Klemmen LR, zweiteilig, Klemme mit Langloch und Sattel mit Verdreh Sperre

Ausgleichscheibe P1L → 82015
 Ausgleichscheibe P2L → 82016
 Rezessfüllplatte W → 82021

Produktinformation → [TI-156](#)

ETA-15/0857, DoP006



Für Schrauben Ø / Klemmbereich min. -max.

M 10 / 3 - 10	S	1	432,00
M 12 / 3 - 12	S	1	581,00
M 16 / 3 - 16	S	1	1059,00
M 20 / 3 - 20	S	1	1918,00
M 24 / 3 - 24	S	1	3042,00

Abmessungen	VE Stück	€/100/Obf.
Artikel 82007.010		
82007 GTW 40 D 2		
galvanisch verzinkt		

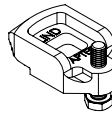

LINDAPTER-Klemmen D 2 m. Stellschraube = „variable Nocke“, mit Rezess (Kopf-Dreh Sperre)

Ausgleichscheibe P1L → 82015
 Ausgleichscheibe P2L → 82016
 Rezessfüllplatte W → 82021

Produktinformation → [TI-156](#)

ETA-15/0857, DoP007



Für Schrauben Ø / Stellhöhe min - max.

M 10 / 10 - 20	S	1	620,00
M 12 / 10 - 22	S	1	636,00
M 16 / 13 - 20	S	1	896,00
M 20 / 17 - 24	S	1	1225,00

Artikel	82015.014
82015 Stahl P 1-L	
galvanisch verzinkt	



LINDAPTER-Ausgleichscheiben P 1-L, L = lang

für Klemmen D2, D3, LR

Produktinformation → [TI-156](#)

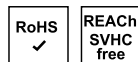

Für Schrauben Ø / Dicke t

M 10 / 5,0	S	1	235,00
M 12 / 6,0	S	1	284,00
M 16 / 8,0	S	1	333,00
M 20 / 10,0	S	1	785,00
M 24 / 12,0	S	1	952,00

Abmessungen	VE Stück	€/100/Obf.
Artikel 82015.024		
82015 Stahl P 1-L		
feuerverzinkt		

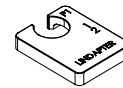

LINDAPTER-Ausgleichscheiben P 1-L, L = lang

für Klemmen D2, D3, LR

Produktinformation → [TI-156](#)

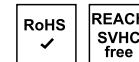

Für Schrauben Ø / Dicke t

M 10 / 5,0	S	1	282,00
M 12 / 6,0	S	1	342,00
M 16 / 8,0	S	1	400,00
M 20 / 10,0	S	1	941,00
M 24 / 12,0	S	1	1142,00

Artikel	82016.014
82016 Stahl P 2-L	
galvanisch verzinkt	

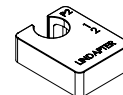

LINDAPTER-Ausgleichscheiben P 2-L, L = lang

für Klemmen D2, D3, LR

Produktinformation → [TI-156](#)

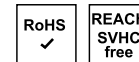

Für Schrauben Ø / Dicke t

M 10 / 10,0	S	1	242,00
M 12 / 12,0	S	1	310,00
M 16 / 16,0	S	1	457,00
M 20 / 20,0	S	1	883,00
M 24 / 24,0	S	1	1750,00



- ✓ Große Artikelvielfalt
- ✓ Verlässliche Qualität
- ✓ Hohe Lieferbereitschaft

Abmessungen	VE Stück	€/100/Obf.
Artikel 82016.024		
82016 Stahl feuerverzinkt	P 2-L	

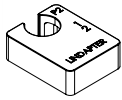

LINDAPTER-Ausgleichscheiben P 2-L, L = lang

für Klemmen D2, D3, LR

Produktinformation → [TI-156](#)

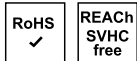

für Schrauben Ø / Dicke t

M	S	1	Preis
M 10 / 10,0	S	1	290,00
M 12 / 12,0	S	1	373,00
M 16 / 16,0	S	1	548,00
M 20 / 20,0	S	1	1059,00
M 24 / 24,0	S	1	2100,00

Artikel	82046.940
82046 A 4	LS

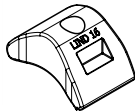

LINDAPTER-Klemmen LS für stufenlosen Klammereich

Ausgleichscheibe LSP2 → 82047

Produktinformation → [TI-156](#)

ETA-15/0857, DoP008



für Schrauben Ø/Klammereich

LS	S	1	Preis
LS 10/3 - 15	S	1	1603,00
LS 12/3 - 20	S	1	1783,00
LS 16/3 - 25	S	1	2490,00
LS 20/3 - 30	S	1	3612,00



Wir versorgen Sie mit Verbindungselementen und Befestigungstechnik!

Abmessungen	VE Stück	€/100/Obf.
Artikel 82047.940		
82047 A 4	LS-P2	

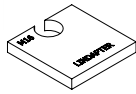

LINDAPTER-Ausgleichscheiben LS-P2, Dicke 10 mm

für Klemmen LS

Produktinformation → [TI-156](#)

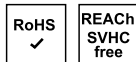

für Schrauben Ø

LS	S	1	Preis
LS 10 P2	S	1	1354,00
LS 12 P2	S	1	1372,00
LS 16 P2	S	1	1513,00
LS 20 P2	S	1	2273,00

Artikel	82048.014
82048 Temperguss galvanisch verzinkt	BR-K

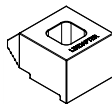

LINDAPTER-Klemmen BR für Schienenprofile und Stahlträger, K = kurze Nockenhöhe

Ausgleichscheibe CW → 82011
Ausgleichscheibe P1K → 82012
Ausgleichscheibe P2K → 82013

Produktinformation → [TI-156](#)



für Schrauben Ø / Nockenhöhe

BR	S	1	Preis
BR 12 / 4,0	S	1	353,00
BR 16 / 6,0	S	1	533,00
BR 20 / 7,0	S	1	876,00

Abmessungen	VE Stück	€/100/Obf.
Artikel 82048.015		
82048 Temperguss galvanisch verzinkt	BR-M	

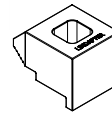

LINDAPTER-Klemmen BR für Schienenprofile und Stahlträger, M = mittlere Nockenhöhe

Ausgleichscheibe CW → 82011
Ausgleichscheibe P1K → 82012
Ausgleichscheibe P2K → 82013

Produktinformation → [TI-156](#)



für Schrauben Ø / Nockenhöhe

BR	S	1	Preis
BR 12 / 6,0	S	1	353,00
BR 16 / 8,0	S	1	533,00
BR 20 / 10,0	S	1	876,00

Artikel	82048.024
82048 Temperguss feuerverzinkt	BR-K

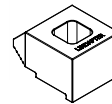

LINDAPTER-Klemmen BR für Schienenprofile und Stahlträger, K = kurze Nockenhöhe

Ausgleichscheibe CW → 82011
Ausgleichscheibe P1K → 82012
Ausgleichscheibe P2K → 82013

Produktinformation → [TI-156](#)

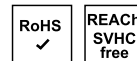

für Schrauben Ø / Nockenhöhe

BR	S	1	Preis
BR 12 / 4,0	S	1	424,00
BR 16 / 6,0	S	1	639,00
BR 20 / 7,0	S	1	1052,00

Abmessungen	VE Stück	€/100/Obf.
Artikel 82048.025		
82048 Temperguss BR-M		
		feuerverzinkt

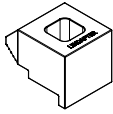

LINDAPTER-Klemmen BR für Schienenprofile und Stahlträger, M = mittlere Nockenhöhe

Ausgleichscheibe CW → 82011
Ausgleichscheibe P1K → 82012
Ausgleichscheibe P2K → 82013

Produktinformation → TI-156



für Schrauben Ø / Nockenhöhe

BR 12 / 6,0	S	1	424,00
BR 16 / 8,0	S	1	639,00
BR 20 / 10,0	S	1	1052,00

Artikel	82003.010		
82003 GTW 40 BSNT			
			galvanisch verzinkt

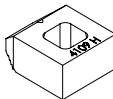

LINDAPTER-Klemmen BSNT mit glatter Auflage, ohne Nocken

Produktinformation → TI-156

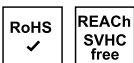

Für Schrauben Ø

M 12	S	1	580,00
------	---	---	--------

Artikel	82009.010		
82009 Temperguss F 9			
			galvanisch verzinkt



LINDAPTER-Klemmen F 9, zweiteilig, mit verzinkten Schrauben, Muttern und Scheiben

Produktinformation → TI-156

ETA-15/0857, DoP010



Schrauben Ø / Klemmbereich min - max.

M 10 / 19 - 42	S	1	1158,00
M 12 / 26 - 60	S	1	2286,00

Abmessungen	VE Stück	€/100/Obf.	
M 16 / 29 - 69	S	1	3290,00
M 20 / 32 - 82	S	1	4694,00

Artikel	82009.020		
82009 Temperguss F 9			
			feuerverzinkt



LINDAPTER-Klemmen F 9, zweiteilig, mit verzinkten Schrauben, Muttern und Scheiben

Produktinformation → TI-156

ETA-15/0857, DoP010



Schrauben Ø / Klemmbereich min - max.

M 10 / 19 - 42	S	1	1389,00
M 12 / 26 - 60	S	1	2743,00
M 16 / 29 - 69	S	1	3949,00
M 20 / 32 - 82	S	1	5634,00
M 24 / 45 - 95	S	1	15116,00

Artikel	82031.010		
82031 Stahl HB			
			galvanisch verzinkt*

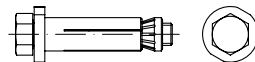

LINDAPTER-HOLLO-BOLT HB für Befestigungen an Hohlprofilen, mit Sechskantschrauben 8.8

*mit Versiegelung JS500 (400h SS-Test)

Produktinformation → TI-156

ETA-10/0416, DoP001

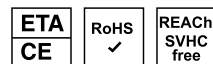

Schrauben Ø - Längenziffer (Länge / max. Klemmstärke)

HB 08-1 (50/22)	S	1	535,00
HB 08-2 (70/41)	S	1	1099,00
HB 08-3 (90/60)	S	1	1197,00
HB 10-1 (55/22)	S	1	658,00
HB 10-2 (70/41)	S	1	1355,00
HB 10-3 (90/60)	S	1	1482,00
HB 12-1 (60/25)	S	1	756,00
HB 12-2 (80/47)	S	1	1630,00
HB 12-3 (100/69)	S	1	1795,00
HB 16-1 (75/29)	S	1	1037,00
HB 16-2 (100/50)	S	1	1747,00
HB 16-3 (120/71)	S	1	2019,00
HB 20-1 (90/34)	S	1	2276,00
HB 20-2 (120/60)	S	1	3531,00
HB 20-3 (150/86)	S	1	3779,00

Abmessungen	VE Stück	€/100/Obf.
Artikel 82031.020		
82031 Stahl HB		
		feuerverzinkt

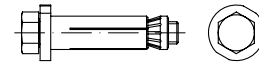

LINDAPTER-HOLLO-BOLT HB für Befestigungen an Hohlprofilen, mit Sechskantschrauben 8.8

Produktinformation → TI-156

ETA-10/0416, DoP001

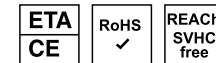

Schrauben Ø - Längenziffer (Länge / max. Klemmstärke)

HB 08-1 (50/22)	S	1	616,00
HB 08-2 (70/41)	S	1	1286,00
HB 08-3 (90/60)	S	1	1411,00
HB 10-1 (55/22)	S	1	773,00
HB 10-2 (70/41)	S	1	1580,00
HB 10-3 (90/60)	S	1	1724,00
HB 12-1 (60/25)	S	1	904,00
HB 12-2 (80/47)	S	1	1901,00
HB 12-3 (100/69)	S	1	2101,00
HB 16-1 (75/29)	S	1	1224,00
HB 16-2 (100/50)	S	1	2129,00
HB 16-3 (120/71)	S	1	2461,00
HB 20-1 (90/34)	S	1	2540,00
HB 20-2 (120/60)	S	1	4116,00
HB 20-3 (150/86)	S	1	4423,00

Artikel	82031.940		
82031 A 4 HB			

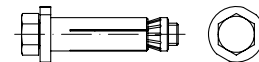

LINDAPTER-HOLLO-BOLT HB für Befestigungen an Hohlprofilen, mit Sechskantschrauben

Produktinformation → TI-156

ETA-10/0416, DoP001

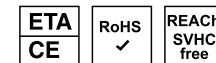

Schrauben Ø - Längenziffer (Länge / max. Klemmstärke)

HB 08-1 (50/22)	S	1	1630,00
HB 08-2 (70/41)	S	1	2475,00
HB 08-3 (90/60)	S	1	2989,00
HB 10-1 (55/22)	S	1	2210,00
HB 10-2 (70/41)	S	1	2877,00
HB 10-3 (90/60)	S	1	3405,00
HB 12-1 (60/25)	S	1	3002,00
HB 12-2 (80/47)	S	1	4507,00
HB 12-3 (100/69)	S	1	4960,00
HB 16-1 (75/29)	S	1	4851,00
HB 16-2 (100/50)	S	1	6044,00
HB 16-3 (120/71)	S	1	7025,00
HB 20-1 (90/34)	S	1	7068,00
HB 20-2 (120/60)	S	1	8224,00
HB 20-3 (150/86)	S	1	9112,00

Abmessungen VE Stück €/100/Obf.

Artikel	82031.013	
82031	Stahl	HBCSK
	galvanisch verzinkt*	

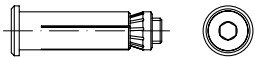

LINDAPTER-HOLLO-BOLT HBCSK für Befestigungen an Hohlprofilen, mit Senkschrauben 10.9

*mit Versiegelung JS500 (400h SS-Test)

Produktinformation → [TI-156](#)

ETA-10/0416, DoP001

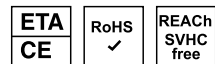

Schrauben Ø - Längenziffer (Länge / max. Klemmstärke)

HBCSK 08-1 (50/22)	S	1	862,00
HBCSK 10-1 (50/22)	S	1	1078,00
HBCSK 12-1 (55/25)	S	1	1248,00
HBCSK 16-1 (70/29)	S	1	1643,00

Artikel	82031.943	
82031	A 4	HBCSK

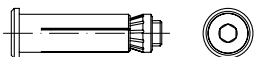

LINDAPTER-HOLLO-BOLT HBCSK für Befestigungen an Hohlprofilen, mit Senkschrauben

Produktinformation → [TI-156](#)

ETA-10/0416, DoP001

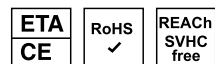

Schrauben Ø - Längenziffer (Länge / max. Klemmstärke)

HBCSK 08-1 (50/22)	S	1	2137,00
HBCSK 10-1 (50/22)	S	1	3094,00
HBCSK 12-1 (55/25)	S	1	3726,00
HBCSK 16-1 (70/29)	S	1	5921,00

Abmessungen VE Stück €/100/Obf.

Artikel	82031.014	
82031	Stahl	HBFF
	galvanisch verzinkt*	

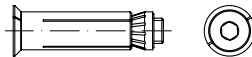

LINDAPTER-HOLLO-BOLT Flush Fit für Befestigungen an Hohlprofilen, vollständig versenkbar, mit Senkschrauben 10.9

*mit Versiegelung JS500 (400h SS-Test)

Montagemutter → Artikel 82033

Produktinformation → [TI-156](#)

ETA-10/0416, DoP001

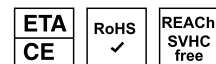

Schrauben Ø - Längenziffer (Länge / max. Klemmstärke)

HBFF 08-1 (50/27)	S	1	762,00
HBFF 08-2 (70/45)	S	1	2476,00
HBFF 08-3 (90/64)	S	1	2883,00
HBFF 10-1 (50/27)	S	1	1138,00
HBFF 10-2 (70/45)	S	1	3387,00
HBFF 10-3 (90/64)	S	1	4152,00
HBFF 12-1 (55/30)	S	1	1309,00
HBFF 12-2 (80/52)	S	1	3998,00
HBFF 12-3 (100/74)	S	1	4574,00

Artikel	82031.944	
82031	A 4	HBFF

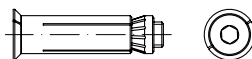

LINDAPTER HOLLO-BOLT Flush Fit für Befestigungen an Hohlprofilen, vollständig versenkbar, mit Senkschrauben

Montagemutter → Artikel 82033

Produktinformation → [TI-156](#)

ETA-10/0416, DoP001

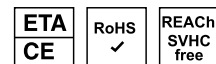

Schrauben Ø - Längenziffer (Länge / max. Klemmstärke)

HBFF 08-1 (50/27)	S	1	2234,00
HBFF 08-2 (70/45)	S	1	3140,00
HBFF 08-3 (90/64)	S	1	3411,00
HBFF 10-1 (50/27)	S	1	3367,00
HBFF 10-2 (70/45)	S	1	3570,00
HBFF 10-3 (90/64)	S	1	4420,00
HBFF 12-1 (55/30)	S	1	3900,00
HBFF 12-2 (80/52)	S	1	5338,00
HBFF 12-3 (100/74)	S	1	6850,00

Abmessungen VE Stück €/100/Obf.

Artikel	82033.000	
82033	Stahl	galvanisch verzinkt

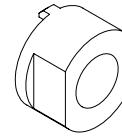

LINDAPTER Montage-Mutter für HOLLO-BOLT Flush Fit HBFF

Produktinformation → [TI-156](#) REACH → [TI-262](#)



für Schrauben Ø

HBFF08	S	1	2017,00
HBFF10	S	1	2017,00
HBFF12	S	1	2017,00

Artikel	82024.010	
82024	GTW 40	TC
	galvanisch verzinkt	

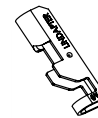

LINDAPTER-Kipp-Dübel TC mit Innengewinde M für Hohlraumbefestigung

Produktinformation → [TI-156](#)

- Bohrloch Ø:
M 8 → Ø 22
M10 → Ø 25
- Hohlraumtiefe min. 75

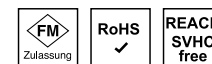

Für Schrauben Ø

TC 8	S	1	215,00
TC 10	S	1	215,00

Abmessungen	VE Stück	€/100/Obf.
Artikel 82008.010		
82008 GTW 40 FL-D		
galvanisch verzinkt		



LINDAPTER-Klemmen FL-D mit Schraube und Kontermutter, D = mit Durchgangsbohrung

Produktinformation → [TI-156](#)

Spannbereich:
 FL 1 = 3 - 17 mm
 FL 2 = 3 - 19 mm
 FL 3 = 3 - 23 mm
 FL 4 = 3 - 28 mm



Typ-Nr. - Bohrungs Ø

FL 1 - D 9	S	1	319,00
FL 1 - D 7	S	1	319,00
FL 2 - D 11	S	1	380,00
FL 3 - D 13	S	1	387,00
FL 4 - D 13	S	1	428,00

Artikel	82058.010
82058 GTW 40 FL-M	
galvanisch verzinkt	

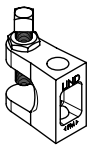

LINDAPTER-Klemmen FL-M mit Schraube und Kontermutter, M = mit Anschlussgewinde

Produktinformation → [TI-156](#)

Spannbereich:
 FL 1 = 3 - 17 mm
 FL 2 = 3 - 19 mm
 FL 3 = 3 - 23 mm
 FL 4 = 3 - 28 mm



Typ-Nr. - Anschlussgewinde M

FL 1 - M 6	S	1	333,00
FL 1 - M 8	S	1	333,00
FL 2 - M 10	S	1	393,00
FL 3 - M 12	S	1	400,00
FL 4 - M 10	S	1	484,00

Abmessungen	VE Stück	€/100/Obf.
Artikel 82025.010		
82025 GTW 40 LC		
galvanisch verzinkt		

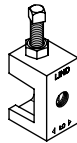

LINDAPTER-Klemmen LC mit 2 Anschlussgewinden, mit Schraube und Kontermutter M 6

Anschlussgewinde seitlich und unten

Produktinformation → [TI-156](#)

Spannbereich = 0 - 20 mm

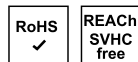

Anschlussgewinde M

M 6	S	1	235,00
M 8	S	1	263,00

Artikel	82022.020
82022 GTW 40 F 3	
feuerverzinkt*	



LINDAPTER-Flanschklemmen F 3, zweiteilig, ohne Schrauben/Muttern**

*M6 = galvanisch verzinkt
 **DIN 603 + 934/ISO 4032

Produktinformation → [TI-156](#)

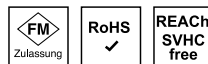

Für Schrauben Ø / Spannbereich 0 - max.

M 8 / 25	S	1	551,00
M 10 / 30	S	1	794,00
M 12 / 40	S	1	1212,00
M 16 / 55	S	1	2437,00
M 20 / 70	S	1	4336,00

Abmessungen	VE Stück	€/100/Obf.
Artikel 82019.010		
82019 Temperguss FF		
galvanisch verzinkt		

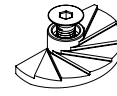

LINDAPTER-FLOOR-FAST-FF für Bodenplatten-Befestigungen, mit Innensechskant-Senkschraube

Produktinformation → [TI-156](#)

ETA-15/0538, DoP013



Nennmaß = Schrauben Ø

M 8	S	1	491,00
M 10	S	1	491,00
M 12	S	1	491,00

Artikel	82019.940
82019 A 4 (1.4408) FF	
galvanisch verzinkt	

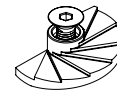

LINDAPTER-FLOOR-FAST-FF für Bodenplatten-Befestigungen, mit Innensechskant-Senkschraube

Produktinformation → [TI-156](#)

ETA-15/0538, DoP013



Nennmaß = Schrauben Ø

FF 08	S	1	2714,00
FF 10	S	1	2714,00
FF 12	S	1	2714,00

Artikel	82400.010
82400 C45+N	
galvanisch verzinkt	

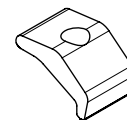

MTH-Klemmplatten Nova Grip

Bauaufsichtliche Zulassung nach Z-14.4-493

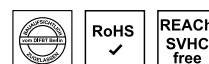

für Schrauben Ø

M 10	S	200	116,00 gal Zn
M 12	S	200	144,00 gal Zn
M 16	S	80	221,00 gal Zn
M 20	S	40	580,00 gal Zn

Abmessungen	VE Stück	€/100/Obf.
Artikel	88579.008	
88579	Mörtel	FHB II-PF-L

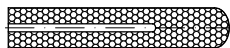

FISCHER Mörtelpatronen FHB II-PF-L

besonders schnelle Aushärtung

L = zur Verwendung mit Highbond-Anker FHB II-A L

Produktinformation → TI-164

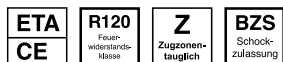

Für Gewinde-Anker Ø x Verankerungstiefe

FHBII-PF 24	x	170	S	10	257,95
FHBII-PF 10	x	95	S	10	328,60
FHBII-PF 12	x	100	S	10	377,65
FHBII-PF 12	x	120	S	10	405,85
FHBII-PF 16	x	125	S	10	528,55
FHBII-PF 16	x	145	S	10	569,65
FHBII-PF 16	x	160	S	10	583,60
FHBII-PF 20	x	210	S	4	1176,65
FHBII-PF 24	x	210	S	4	1204,85

Artikel	88579.007
88579	Mörtel FHB II-PF-S

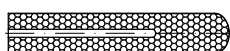

FISCHER Mörtelpatronen FHB II-PF-S

besonders schnelle Aushärtung

S = zur Verwendung mit Highbond-Anker FHB II-A S

Produktinformation → TI-164



Für Gewinde-Anker Ø x Verankerungstiefe

FHBII-PF 10	x	60	S	10	293,05
FHBII-PF 10	x	75	S	10	305,15
FHBII-PF 12	x	75	S	10	330,60
FHBII-PF 16	x	95	S	10	471,30
FHBII-PF 20	x	170	S	4	1037,60
FHBII-PF 24	x	170	S	4	1103,40

Abmessungen	VE Stück	€/100/Obf.
Artikel	88579.004	
88579	Mörtel	FHB II-P-L

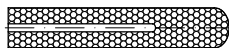

FISCHER Mörtelpartonen FHB II-P-L

L = zur Verwendung mit Highbond-Anker FHB II-A L

Produktinformation → TI-164



Für Gewinde-Anker Ø x Verankerungstiefe

FHBII-P 8	x	60	S	10	257,95
FHBII-P 10	x	95	S	10	328,60
FHBII-P 12	x	100	S	10	377,65
FHBII-P 12	x	120	S	10	405,85
FHBII-P 16	x	125	S	10	528,55
FHBII-P 16	x	145	S	10	569,65
FHBII-P 16	x	160	S	10	583,60
FHBII-P 20	x	210	S	4	1176,65
FHBII-P 24	x	210	S	4	1204,85

Artikel	88579.005
88579	Mörtel FHB II-P-S



FISCHER Mörtelpatronen FHB II-P-S

S = zur Verwendung mit Highbond-Anker FHB II-A S

Produktinformation → TI-164



Für Gewinde-Anker Ø x Verankerungstiefe

FHBII-P 10	x	60	S	10	293,05
FHBII-P 12	x	75	S	10	330,60
FHBII-P 16	x	95	S	10	471,30
FHBII-P 20	x	170	S	4	1037,60
FHBII-P 24	x	170	S	4	1103,40

Abmessungen	VE Stück	€/100/Obf.
Artikel	88687.001	
88687	Mörtel	RSB

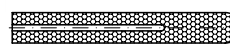

FISCHER Mörtelpatronen RSB

zur Verwendung mit Ankerstangen RG M

Produktinformation → TI-166



für Gewinde-Anker RG M

RSB 8	S	10	252,75
RSB 10 mini	S	10	259,00
RSB 10	S	10	264,25
RSB 12 mini	S	10	275,60
RSB 12	S	10	287,70
RSB 16 mini	S	10	410,55
RSB 16	S	10	427,80
RSB 16 E	S	10	527,40
RSB 20	S	10	522,85
RSB 20 E / 24	S	5	736,75
RSB 30	S	5	1151,45

Artikel	88578.000
88578	Mörtel FIS HB

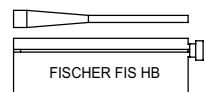

FISCHER Injektionsmörtel FIS HB

inkl. 2 Statikmischer/Kartusche

Verkauf nur als ganze Verpackungseinheit

zur Verwendung mit Highbond-Anker FHB II



Inhalt je Kartusche (ml)

FIS HB 150 C	S	6	2900,00
FIS HB 345	S	1	6200,00



- ✓ Große Artikelvielfalt
- ✓ Verlässliche Qualität
- ✓ Hohe Lieferbereitschaft

Abmessungen	VE Stück	€/100/Obf.
Artikel 88522.000		
88522 Mörtel		FIS V

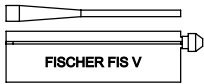

FISCHER Hochleistungsmörtel FIS V

inkl. 2 Statikmischer/Kartusche
Verkauf nur als ganze Verpackungseinheit

zur Verwendung mit Ankerstangen FIS A, RG M und Innengewindeanker RG MI



Inhalt je Kartusche (ml)

FIS V 360 S	S	6	5285,00
FIS V 300 T	S	12	4405,00

Artikel	88522.005	Mörtel	FIS EM 390 S
88522			

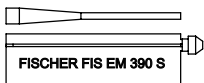

FISCHER Injektionsmörtel FIS EM 390 S

inkl. 2 Statikmischer/Kartusche
Verkauf nur als ganze Verpackungseinheit

zur Verwendung mit Bewehrungsankern und Abstandsmontagesystemen



Inhalt je Kartusche (ml)

FIS EM 390 S	S	6	5370,00
--------------	---	---	---------

Artikel	88686.000	Mörtel	FIS SB
88686			

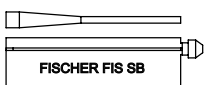

FISCHER Superbond Mörtel FIS SB

inkl. 2 Statikmischer/Kartusche
Verkauf nur als ganze Verpackungseinheit

zur Verwendung mit Ankerstangen FIS A, RG M und Innengewindeanker RG MI



Inhalt je Kartusche (ml)

FIS SB 390 S	S	6	5285,00
FIS SB 1500 S	S	4	13550,00

Abmessungen	VE Stück	€/100/Obf.
Artikel 88527.(*)		
88527 Mörtel		

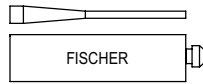

FISCHER Montagemörtel

inkl. 2 Statikmischer/Kartusche
Verkauf nur als ganze Verpackungseinheit
(*): 150 C (D) = (003), 300 T (D) = (004)

zur Verwendung mit Ankerstangen FIS A und Innengewindeanker RG MI



Inhalt je Kartusche (ml)

150 C(D)	S	10	2285,00
300 T	S	1	2685,00

Artikel	88525.602	Kunststoff	FIS MR
88525			

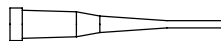

FISCHER Statikmischer FIS Mixer Red

zur Verwendung mit allen FISCHER Injektionsmörtelkartuschen



FIS Mixer Red	S	10	221,35
---------------	---	----	--------

Artikel	88579.006	Stahl	BS
88579			



FISCHER Reinigungsbürsten BS, für Bohrlochreinigung



für Bohrloch Ø

FHB-BS 10	S	1	1540,00
FHB-BS 12	S	1	1590,00
FHB-BS 14	S	1	1645,00
FHB-BS 16/18	S	1	1715,00
FHB-BS 24	S	1	1835,00
FHB-BS 25	S	1	1850,00
FHB-BS 28	S	1	1875,00

Abmessungen	VE Stück	€/100/Obf.
Artikel 88685.600		
88685 Kunststoff		ABG

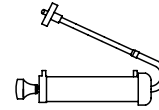

FISCHER Ausbläser ABG, groß



ABG groß	S	1	3100,00
----------	---	---	---------

Artikel	88524.002	Kunststoff	FIS DMS
88524			

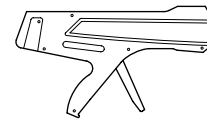

FISCHER Auspresspistole FIS DMS

zur Verwendung mit allen FISCHER Injektionsmörtelkartuschen



FIS DMS	S	1	18840,00
---------	---	---	----------

Artikel	88524.004	Metall	FIS AM
88524			

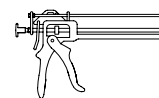

FISCHER Auspresspistole FIS AM

zur Verwendung mit allen FISCHER Injektionsmörtelkartuschen



FIS - AM	S	1	8085,00
----------	---	---	---------

Abmessungen	VE Stück	€/100/Obf.
Artikel	88684.000	
88684	Kunststoff	FIS VLS



FISCHER Verlängerungsschlauch FIS VLS, Länge 1000 mm



FIS-VLS 5 1 229,70

Artikel	88579.014
88579	Stahl FHB II-A L galvanisch verzinkt

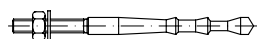

FISCHER Highbond-Anker FHB II-A L, L = große Verankerungstiefe mit max. Lastwerten

zur Verwendung mit Injektionsmörtel FIS HB, Mörtelpatronen FHB II-P und FHB II-PF

Produktinformation → TI-164



Dübel Ø x Dübellänge / Klemmlänge

M 8	x 60 / 10	S 10	487,40
M 8	x 60 / 30	S 10	561,75
M 8	x 60 / 50	S 10	707,70
M 10	x 95 / 10	S 10	710,90
M 10	x 95 / 20	S 10	808,75
M 10	x 95 / 60	S 10	1002,60
M 10	x 95 / 100	S 10	1349,15
M 12	x 100 / 10	S 10	838,60
M 12	x 100 / 25	S 10	908,95
M 12	x 100 / 60	S 10	1042,00
M 12	x 100 / 100	S 10	1365,60
M 12	x 120 / 10	S 10	1035,40
M 12	x 120 / 25	S 10	1160,30
M 12	x 120 / 60	S 10	1344,65
M 12	x 120 / 100	S 10	1647,65
M 16	x 125 / 30	S 10	1220,80
M 16	x 125 / 60	S 10	1426,10
M 16	x 125 / 100	S 10	1851,80
M 16	x 160 / 30	S 10	1614,65
M 16	x 160 / 60	S 10	1885,40
M 16	x 160 / 100	S 10	2395,75
M 20	x 210 / 50	S 4	2865,55
M 20	x 210 / 150	S 8	4833,65
M 24	x 210 / 50	S 4	3497,10

Abmessungen	VE Stück	€/100/Obf.
Artikel	88579.944	
88579	A 4	FHB II-A L



FISCHER Highbond-Anker FHB II-A L, L = große Verankerungstiefe mit max. Lastwerten

zur Verwendung mit Injektionsmörtel FIS HB, Mörtelpatronen FHB II-P und FHB II-PF

Produktinformation → TI-164



Dübel Ø x Dübellänge / Klemmlänge

M 8	x 60 / 10	S 10	828,35
M 8	x 60 / 30	S 10	938,60
M 8	x 60 / 50	S 10	1035,30
M 10	x 95 / 10	S 10	1381,05
M 10	x 95 / 20	S 10	1573,55
M 10	x 95 / 40	S 10	1780,15
M 10	x 95 / 60	S 10	1846,70
M 10	x 95 / 100	S 10	2359,65
M 12	x 100 / 10	S 10	1556,10
M 12	x 100 / 25	S 10	1675,95
M 12	x 100 / 40	S 10	1790,35
M 12	x 100 / 60	S 10	2002,65
M 12	x 100 / 100	S 10	2551,05
M 12	x 120 / 10	S 10	2001,00
M 12	x 120 / 25	S 10	2174,65
M 12	x 120 / 40	S 10	2412,90
M 12	x 120 / 60	S 10	2713,70
M 12	x 120 / 100	S 10	3469,60
M 16	x 125 / 30	S 10	2750,25
M 16	x 125 / 60	S 10	3020,85
M 16	x 125 / 100	S 10	3577,75
M 16	x 145 / 30	S 10	3269,00
M 16	x 145 / 60	S 10	3609,55
M 16	x 145 / 100	S 10	4202,95
M 16	x 160 / 30	S 10	3687,85
M 16	x 160 / 60	S 10	3916,40
M 16	x 160 / 100	S 10	4578,00
M 20	x 210 / 50	S 4	5841,50
M 24	x 210 / 50	S 4	7274,20

Abmessungen	VE Stück	€/100/Obf.
Artikel	88579.015	
88579	Stahl galvanisch verzinkt	FHB II-A S

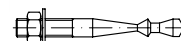

FISCHER Highbond-Anker FHB II-A S, S = reduzierte Verankerungstiefe für optimierten Montageaufwand

zur Verwendung mit Injektionsmörtel FIS HB, Mörtelpatronen FHB II-P und FHB II-PF

Produktinformation → TI-164



Dübel Ø x Dübellänge / Klemmlänge

M 10	x 60 / 10	S 10	494,40
M 10	x 60 / 20	S 10	547,75
M 10	x 60 / 60	S 10	701,40
M 10	x 60 / 100	S 10	905,55
M 10	x 75 / 10	S 10	519,35
M 10	x 75 / 20	S 10	587,95
M 10	x 75 / 60	S 10	730,85
M 10	x 75 / 100	S 10	960,50
M 12	x 75 / 10	S 10	612,95
M 12	x 75 / 25	S 10	673,45
M 12	x 75 / 60	S 10	740,15
M 12	x 75 / 100	S 10	980,75
M 12	x 75 / 165	S 10	1307,90
M 16	x 95 / 30	S 10	889,30
M 16	x 95 / 60	S 10	1058,80
M 16	x 95 / 100	S 10	1337,35
M 16	x 95 / 165	S 10	1697,60
M 20	x 170 / 50	S 4	2410,40
M 24	x 170 / 50	S 4	2660,05

Artikel	88579.946
88579	A 4 FHB II-A S

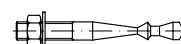

FISCHER Highbond-Anker FHB II-A S, S = reduzierte Verankerungstiefe für optimierten Montageaufwand

zur Verwendung mit Injektionsmörtel FIS HB, Mörtelpatronen FHB II-P und FHB II-PF

Produktinformation → TI-164



Dübel Ø x Dübellänge / Klemmlänge

M 10	x 60 / 10	S 10	820,00
M 10	x 60 / 20	S 10	909,75
M 10	x 60 / 40	S 10	1017,35
M 10	x 60 / 60	S 10	1171,90
M 10	x 60 / 100	S 10	1556,55
M 12	x 75 / 10	S 10	1114,25
M 12	x 75 / 25	S 10	1201,75
M 12	x 75 / 40	S 10	1276,95
M 12	x 75 / 60	S 10	1418,75
M 12	x 75 / 100	S 10	1819,90
M 12	x 75 / 165	S 10	2525,20

Abmessungen	VE	Stück	€/100/Obf.
M 16 x 95 / 165	S	10	3022,15
M 16 x 95 / 30	S	10	1995,05
M 16 x 95 / 60	S	10	2211,35
M 16 x 95 / 100	S	10	2578,85
M 20 x 170 / 50	S	4	4507,50
M 24 x 170 / 50	S	4	4892,30

Artikel	88579.300
88579	Stahl FHB-A dyn galvanisch verzinkt

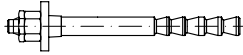

FISCHER Highbond-Anker FHB-A dyn, für dynamische Belastung

zur Verwendung mit Injektionsmörtel FIS HB

Produktinformation → TI-164



Dübel Ø x Dübellänge / Klemmlänge

dyn 12 x 100/25	S	10	1307,90
dyn 12 x 100/50	S	10	1567,20
dyn 16 x 125/25	S	10	1711,30
dyn 16 x 125/50	S	10	1990,30
dyn 20 x 170/50	S	10	3165,35
dyn 24 x 220/50	S	5	4934,90

Artikel	88534.010
88534	Stahl galvanisch verzinkt

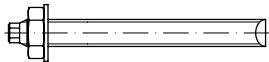

FISCHER Ankerstangen RG M, mit Mutter und Scheibe

zur Verwendung mit Mörtelpatronen RM und RSB

Produktinformation → TI-166



Ø M x Länge

RG M 8 x 110	S	10	132,45
RG M 10 x 130	S	10	181,65
RG M 10 x 165	S	10	223,65
RG M 10 x 190	S	10	253,70
RG M 10 x 250	S	10	393,55
RG M 10 x 350	S	10	622,15
RG M 12 x 160	S	10	256,05
RG M 12 x 220	S	10	320,00
RG M 12 x 250	S	10	364,70
RG M 12 x 300	S	10	447,95
RG M 12 x 380	S	10	684,40
RG M 16 x 190	S	10	486,60
RG M 16 x 165	S	10	411,05
RG M 16 x 250	S	10	565,90
RG M 16 x 300	S	10	621,05
RG M 16 x 380	S	10	897,45
RG M 16 x 500	S	10	1316,40
RG M 20 x 260	S	10	982,95
RG M 20 x 350	S	10	1483,80
RG M 20 x 500	S	10	2119,50
RG M 24 x 300	S	10	1514,90

Abmessungen	VE	Stück	€/100/Obf.
RG M 24 x 400	S	10	2393,55
RG M 24 x 600	S	10	3407,90
RG M 30 x 380	S	5	3436,70
RG M 30 x 500	S	5	4141,45

Artikel	88534.020
88534	Stahl feuerverzinkt

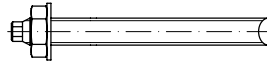

FISCHER Ankerstangen RG M, mit Mutter und Scheibe

zur Verwendung mit Mörtelpatronen RM und RSB

Produktinformation → TI-166



Ø M x Länge

RG M 12 x 160	S	10	310,45
RG M 16 x 190	S	10	595,75

Artikel	88534.810
88534	8.8 galvanisch verzinkt



FISCHER Ankerstangen RG M, mit Mutter und Scheibe

zur Verwendung mit Mörtelpatronen RM und RSB

Produktinformation → TI-166



Ø M x Länge

RG M 8 x 150	S	10	272,30
RG M 10 x 220	S	10	345,95
RG M 12 x 220	S	10	364,25
RG M 16 x 270	S	10	645,40
RG M 20 x 290	S	10	1251,25
RG M 24 x 295	S	10	1718,50

Abmessungen	VE	Stück	€/100/Obf.
Artikel	88534.940		
88534	A 4	RG M	

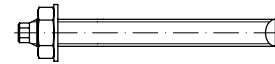

FISCHER Ankerstangen RG M, mit Mutter und Scheibe

zur Verwendung mit Mörtelpatronen RM und RSB

Produktinformation → TI-166



Ø M x Länge

RG M 8 x 110	S	10	416,85
RG M 8 x 150	S	10	587,65
RG M 10 x 130	S	10	700,10
RG M 10 x 165	S	10	866,15
RG M 10 x 190	S	10	1010,20
RG M 10 x 250	S	10	1284,00
RG M 10 x 350	S	10	1846,85
RG M 12 x 160	S	10	916,40
RG M 12 x 220	S	10	1200,90
RG M 12 x 250	S	10	1539,55
RG M 12 x 300	S	10	1819,85
RG M 12 x 380	S	10	2429,55
RG M 16 x 190	S	10	1635,65
RG M 16 x 165	S	10	1469,15
RG M 16 x 250	S	10	2222,60
RG M 16 x 300	S	10	2617,40
RG M 16 x 380	S	10	3498,15
RG M 16 x 500	S	10	4845,90
RG M 20 x 260	S	10	4102,55
RG M 20 x 350	S	10	5703,50
RG M 24 x 300	S	10	6999,20
RG M 24 x 400	S	10	9342,35

Artikel	88523.011
88523	Stahl galvanisch verzinkt

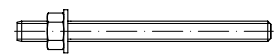

FISCHER Ankerstangen FIS A, mit Mutter und Scheibe

zur Verwendung mit Montagemörtel, FIS V und FIS SB

Produktinformation → TI-167



Ø M x Länge

FIS A M 6 x 75	S	20	101,75
FIS A M 6 x 85	S	20	111,95
FIS A M 6 x 110	S	20	126,60
FIS A M 8 x 90	S	10	115,15
FIS A M 8 x 110	S	10	129,80
FIS A M 8 x 130	S	10	176,65
FIS A M 10 x 110	S	10	164,90
FIS A M 10 x 130	S	10	177,80
FIS A M 10 x 150	S	10	202,05
FIS A M 10 x 200	S	10	271,80
FIS A M 10 x 170	S	10	225,85

Abmessungen	VE	Stück	€/100/Obf.
FIS A M 12 x 140	S	10	236,20
FIS A M 12 x 160	S	10	250,10
FIS A M 12 x 180	S	10	275,65
FIS A M 12 x 210	S	10	304,10
FIS A M 12 x 260	S	10	371,20
FIS A M 16 x 175	S	10	450,60
FIS A M 16 x 200	S	10	500,10
FIS A M 16 x 250	S	10	553,10
FIS A M 16 x 300	S	10	607,65
FIS A M 20 x 245	S	10	894,75
FIS A M 20 x 290	S	10	1094,75
FIS A M 24 x 290	S	5	1418,80
FIS A M 24 x 380	S	5	1873,40
FIS A M 30 x 430	S	5	2876,15

Artikel	88523.941
88523	A 4 FIS A



FISCHER Ankerstangen FIS A, mit Mutter und Scheibe

zur Verwendung mit Montagemörtel, FIS V und FIS SB

Produktinformation → TI-167



Ø M x Länge

FIS A M 6 x 75	S	20	324,15
FIS A M 6 x 110	S	20	403,60
FIS A M 8 x 90	S	10	365,60
FIS A M 8 x 110	S	10	407,85
FIS A M 8 x 130	S	10	504,90
FIS A M 10 x 110	S	10	631,25
FIS A M 10 x 130	S	10	684,25
FIS A M 10 x 150	S	10	798,05
FIS A M 10 x 200	S	10	1076,60
FIS A M 12 x 120	S	10	766,05
FIS A M 12 x 140	S	10	823,20
FIS A M 12 x 160	S	10	895,55
FIS A M 12 x 180	S	10	983,15
FIS A M 12 x 210	S	10	1174,70
FIS A M 12 x 260	S	10	1579,30
FIS A M 16 x 130	S	10	1348,25
FIS A M 16 x 175	S	10	1563,55
FIS A M 16 x 200	S	10	1756,55
FIS A M 16 x 250	S	10	2177,50
FIS A M 16 x 300	S	10	2615,50
FIS A M 20 x 245	S	10	3893,30
FIS A M 20 x 290	S	10	4622,80
FIS A M 24 x 290	S	5	6428,45
FIS A M 24 x 380	S	5	8238,55
FIS A M 30 x 430	S	5	14467,90

Abmessungen	VE	Stück	€/100/Obf.
Artikel	88529.010		
88529	Stahl galvanisch verzinkt	FIS E	



FISCHER Innengewindeanker FIS E

Produktinformation → TI-168



Passend zu FIS-HM-Hülse/Innengewinde M

FIS E11 x 85 M 6	S	10	264,50
FIS E11 x 85 M 8	S	10	285,70
FIS E15 x 85 M10	S	10	343,75
FIS E15 x 85 M12	S	10	370,15

Artikel	88562.600		
88562	Kunststoff	FIS H K	



FISCHER Injektions-Ankerhülsen FIS H K

für Verwendung mit FIS A und FIS E

Produktinformation → TI-168



Bohrungs Ø x Verankerungstiefe

FIS H 12 x 50 K	S	50	60,25
FIS H 12 x 85 K	S	50	71,65
FIS H 16 x 85 K	S	50	88,60
FIS H 16 x 130 K	S	20	121,95
FIS H 20 x 85 K	S	20	96,45
FIS H 20 x 130 K	S	20	216,00
FIS H 20 x 200 K	S	20	291,90

Artikel	88526.600		
88526	Kunststoff	FIS H N	



FISCHER Injektions-Ankerhülsen mit Netz FIS H N

Produktinformation → TI-169



Bohr Ø x Dübellänge - Einbautiefe

FIS H 16 x 85 N	S	20	172,85
FIS H 18 x 85 N	S	20	181,45
FIS H 20 x 85 N	S	20	216,40

Abmessungen	VE	Stück	€/100/Obf.
Artikel	88526.000		
88526	Metall	FIS H L	

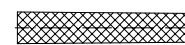

FISCHER Injektions-Ankerhülsen FIS H L, Meterware

Produktinformation → TI-169



Bohr Ø x Länge

FIS H 12 x 1000 L	S	1	1351,25
FIS H 16 x 1000 L	S	1	1436,50
FIS H 22 x 1000 L	S	1	1570,45

Artikel	88561.010		
88561	Stahl galvanisch verzinkt	FAZ II	

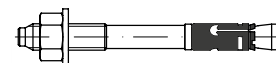

FISCHER Bolzenanker FAZ II mit Mutter und Scheibe

Produktinformation → TI-170



Dübel-/Bohr Ø x Klemmlänge

FAZ II 8/ 10	S	50	108,80
FAZ II 8/ 30	S	50	131,00
FAZ II 8/ 50	S	50	161,00
FAZ II 10/ 10	S	50	135,60
FAZ II 10/ 20	S	25	149,60
FAZ II 10/ 30	S	25	164,30
FAZ II 10/ 50	S	20	183,65
FAZ II 10/ 80	S	20	223,70
FAZ II 10/ 100	S	20	256,10
FAZ II 10/ 160	S	20	369,70
FAZ II 12/ 10	S	20	204,95
FAZ II 12/ 20	S	20	221,45
FAZ II 12/ 30	S	20	240,50
FAZ II 12/ 50	S	20	288,60
FAZ II 12/ 80	S	20	387,80
FAZ II 12/ 100	S	20	447,25
FAZ II 12/ 160	S	10	539,35
FAZ II 12/ 200	S	10	669,35
FAZ II 16/ 5	S	10	402,75
FAZ II 16/ 25	S	10	487,75
FAZ II 16/ 50	S	10	587,75
FAZ II 16/ 100	S	10	797,75
FAZ II 16/ 160	S	10	1053,30
FAZ II 16/ 200	S	10	1156,45
FAZ II 16/ 250	S	10	1247,50
FAZ II 20/ 30	S	5	1020,75
FAZ II 20/ 60	S	5	1316,15
FAZ II 20/ 160	S	5	1992,05
FAZ II 24/ 30	S	5	2390,90
FAZ II 24/ 60	S	5	2676,60

Abmessungen	VE Stück	€/100/Obf.
Artikel	88561.940	
88561	A 4	FAZ II

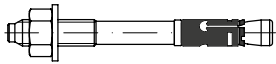

FISCHER Bolzenanker FAZ II mit Mutter und Scheibe

Produktinformation → TI-170



Dübel-/Bohr Ø x Klemmlänge

FAZ II 8 / 10	S	50	481,35
FAZ II 8 / 30	S	50	573,45
FAZ II 8 / 50	S	50	697,25
FAZ II 10/ 10	S	50	535,55
FAZ II 10/ 20	S	50	552,90
FAZ II 10/ 30	S	50	606,70
FAZ II 10/ 50	S	20	748,65
FAZ II 10/ 70	S	20	906,90
FAZ II 10/100	S	20	1074,15
FAZ II 10/160	S	20	1398,65
FAZ II 12/ 10	S	20	805,65
FAZ II 12/ 20	S	20	828,95
FAZ II 12/ 30	S	20	899,95
FAZ II 12/ 50	S	20	1136,20
FAZ II 12/ 60	S	20	1326,45
FAZ II 12/100	S	20	1598,00
FAZ II 12/160	S	20	1757,15
FAZ II 16/ 5	S	20	1527,90
FAZ II 16/ 25	S	20	1819,40
FAZ II 16/ 50	S	20	2183,90
FAZ II 16/ 60	S	20	2335,90
FAZ II 16/100	S	10	2563,70
FAZ II 20/ 30	S	4	3995,25
FAZ II 20/ 60	S	4	4488,10
FAZ II 24/ 30	S	4	6242,70
FAZ II 24/ 60	S	4	7009,60

Artikel	88561.015
88561	Stahl galvanisch verzinkt FAZ II K

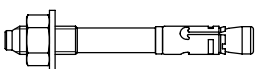

FISCHER Bolzenanker FAZ II K mit Mutter und Scheibe, K = kurze Ausführung

Produktinformation → TI-170



Dübel-/Bohr Ø x Klemmlänge

FAZ II 10/ 10K	S	50	122,10
FAZ II 10/ 20K	S	25	134,45
FAZ II 12/ 10K	S	20	184,30
FAZ II 12/ 20K	S	20	199,35

Abmessungen	VE Stück	€/100/Obf.
Artikel	88561.945	
88561	A 4	FAZ II K

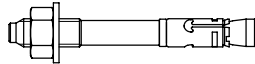

FISCHER Bolzenanker FAZ II K mit Mutter und Scheibe, K = kurze Ausführung

Produktinformation → TI-170



Dübel-/Bohr Ø x Klemmlänge

FAZ II 10/ 10K	S	50	482,05
FAZ II 10/ 20K	S	50	497,50
FAZ II 12/ 10K	S	20	725,05
FAZ II 12/ 20K	S	20	746,15

Artikel	88561.014
88561	Stahl galvanisch verzinkt FAZ II GS

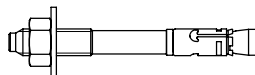

FISCHER Bolzenanker FAZ II GS mit Mutter und großer Scheibe (GS)

Produktinformation → TI-170



Dübel-/Bohr Ø x Klemmlänge

FAZ II 8 / 10 GS	S	50	119,55
FAZ II 8 / 30 GS	S	50	145,05
FAZ II 10/ 10 GS	S	50	161,80
FAZ II 10/ 30 GS	S	25	195,50
FAZ II 12/ 10 GS	S	20	235,95
FAZ II 12/ 20 GS	S	20	252,65
FAZ II 12/ 30 GS	S	20	271,60
FAZ II 12/ 50 GS	S	20	319,70
FAZ II 12/100 GS	S	20	476,35
FAZ II 12/120 GS	S	20	519,75
FAZ II 16/160 GS	S	10	1086,65
FAZ II 16/200 GS	S	10	1224,65

Abmessungen	VE Stück	€/100/Obf.
Artikel	88561.944	
88561	A 4	FAZ II GS

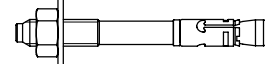

FISCHER Bolzenanker FAZ II GS mit Mutter und großer Scheibe (GS)

Produktinformation → TI-170



Dübel-/Bohr Ø x Klemmlänge

FAZ II 8 / 10 GS	S	50	540,05
FAZ II 8 / 30 GS	S	50	630,20
FAZ II 10/ 10 GS	S	50	591,60
FAZ II 10/ 30 GS	S	50	662,60
FAZ II 12/ 10 GS	S	20	861,60
FAZ II 12/ 30 GS	S	20	955,95
FAZ II 12/ 160 GS	S	20	1813,15
FAZ II 16/ 160 GS	S	4	3848,45

Artikel	88561.016
88561	Stahl galvanisch verzinkt FAZ II K GS

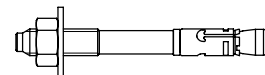

FISCHER Bolzenanker FAZ II K GS mit Mutter und großer Scheibe (GS), K = kurze Ausführung

Produktinformation → TI-170



Dübel-/Bohr Ø x Klemmlänge

FAZ II 10/ 10K GS	S	50	145,55
FAZ II 12/ 10K GS	S	20	212,35

Artikel	88561.017
88561	Stahl galvanisch verzinkt FAZ II HBS

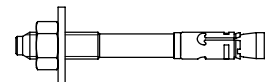

FISCHER Bolzenanker FAZ II HBS mit Mutter und extra großer Scheibe (HBS) nach Holzbaunorm DIN 1052

Produktinformation → TI-170



Dübel-/Bohr Ø x Klemmlänge

FAZ II 12/100HBS	S	20	476,35
FAZ II 12/120HBS	S	20	519,75
FAZ II 16/160HBS	S	10	1086,65
FAZ II 16/200HBS	S	10	1224,65

Abmessungen VE Stück €/100/Obf.

Artikel	88694.010
88694	Stahl galvanisch verzinkt FBZ

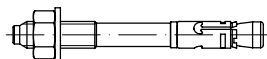

FISCHER Bolzenanker FBZ mit Mutter und Scheibe

Produktinformation → TI-171

ETA CE	R120 Feuerwiderstandsklasse	Z Zugzonentauglich	REACH SVHC free
--------	-----------------------------	--------------------	-----------------

Dübel-/Bohr Ø x Klemmlänge

FBZ 8/10	S	50	91,60
FBZ 10/10	S	50	115,60
FBZ 10/20	S	25	126,60
FBZ 10/30	S	25	137,45
FBZ 12/10	S	20	176,05
FBZ 12/20	S	20	189,05
FBZ 12/30	S	20	204,70
FBZ 16/25	S	10	409,15

Artikel	88694.940
88694	A 4 FBZ

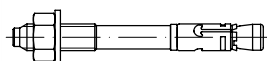

FISCHER Bolzenanker FBZ mit Mutter und Scheibe

Produktinformation → TI-171

ETA CE	R120 Feuerwiderstandsklasse	Z Zugzonentauglich	REACH SVHC free
--------	-----------------------------	--------------------	-----------------

Dübel-/Bohr Ø x Klemmlänge

FBZ 8/10	S	50	417,30
FBZ 10/10	S	50	452,70
FBZ 10/20	S	50	466,80
FBZ 10/30	S	50	513,20
FBZ 12/10	S	20	687,45
FBZ 12/20	S	20	699,50
FBZ 12/30	S	20	759,35
FBZ 16/25	S	20	1535,65



- ✓ Große Artikelvielfalt
- ✓ Verlässliche Qualität
- ✓ Hohe Lieferbereitschaft

Abmessungen VE Stück €/100/Obf.

Artikel	88694.014
88694	Stahl galvanisch verzinkt FBZ GS

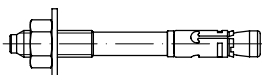

FISCHER Bolzenanker FBZ GS mit Mutter und großer Scheibe (GS)

Produktinformation → TI-171

ETA CE	R120 Feuerwiderstandsklasse	Z Zugzonentauglich	REACH SVHC free
--------	-----------------------------	--------------------	-----------------

Dübel-/Bohr Ø x Klemmlänge

FBZ 8/10 GS	S	50	106,30
FBZ 10/10 GS	S	50	139,60
FBZ 12/10 GS	S	20	205,80

Artikel	88694.944
88694	A 4 FBZ GS

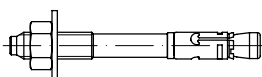

FISCHER Bolzenanker FBZ GS mit Mutter und großer Scheibe (GS)

Produktinformation → TI-171

ETA CE	R120 Feuerwiderstandsklasse	Z Zugzonentauglich	REACH SVHC free
--------	-----------------------------	--------------------	-----------------

Dübel-/Bohr Ø x Klemmlänge

FBZ 8/10 GS	S	50	473,00
FBZ 10/10 GS	S	50	519,05
FBZ 10/20 GS	S	50	547,45

Artikel	88693.000
88693	Stahl FA-ST



FISCHER Bolzenanker-Setzgerät FA-ST

passend für die Dübelvarianten:
FAZ II, FBZ und FBN II

REACH SVHC free

FA-ST M 10	S	1	23000,00
FA-ST M 12	S	1	23000,00

Abmessungen VE Stück €/100/Obf.

Artikel	88593.012
88593	Stahl galvanisch verzinkt FH II-S

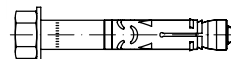

FISCHER Hochleistungsanker FH II-S mit Sechskantkopf

Produktinformation → TI-171

ETA CE	R120 Feuerwiderstandsklasse	Z Zugzonentauglich	FM Zulassung	Vds approval	REACH SVHC free
--------	-----------------------------	--------------------	--------------	--------------	-----------------

Dübel-/Bohr Ø x Einbautiefe / Klemmlänge

FH II 10/ 10 S	S	50	241,50
FH II 10/ 25 S	S	50	262,15
FH II 10/ 50 S	S	50	294,85
FH II 12/ 10 S	S	50	366,45
FH II 12/ 25 S	S	50	403,30
FH II 12/ 50 S	S	25	461,85
FH II 15/ 10 S	S	25	488,70
FH II 15/ 25 S	S	25	552,55
FH II 15/ 50 S	S	25	631,20
FH II 18/ 25 S	S	20	813,90
FH II 18/ 50 S	S	20	960,75
FH II 24/ 25 S	S	10	1808,60
FH II 24/ 50 S	S	10	2014,85
FH II 28/ 30 S	S	4	3070,65
FH II 28/ 60 S	S	4	3585,25
FH II 32/ 30 S	S	4	4629,55
FH II 32/ 60 S	S	4	5535,25

Artikel	88593.942
88593	A 4 FH II-S

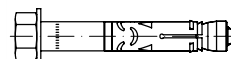

FISCHER Hochleistungsanker FH II-S mit Sechskantkopf

Produktinformation → TI-171

ETA CE	R120 Feuerwiderstandsklasse	Z Zugzonentauglich	FM Zulassung	Vds approval	REACH SVHC free
--------	-----------------------------	--------------------	--------------	--------------	-----------------

Dübel-/Bohr Ø x Einbautiefe / Klemmlänge

FH II 10/ 10 S	S	50	770,05
FH II 10/ 25 S	S	50	938,45
FH II 12/ 10 S	S	50	1128,55
FH II 12/ 25 S	S	20	1260,80
FH II 15/ 10 S	S	50	1473,90
FH II 15/ 25 S	S	20	1730,65
FH II 18/ 25 S	S	10	2536,85
FH II 24/ 25 S	S	8	6885,30

Abmessungen	VE Stück	€/100/Obf.
Artikel	88594.012	
88594	Stahl	FH II-SK
	galvanisch verzinkt	

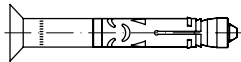

FISCHER Hochleistungsanker FH II-SK mit Senkkopf

Produktinformation → TI-172



Dübel-/Bohr Ø x Einbautiefe / Klemmlänge

FH II 10/ 15 SK	S	50	262,25
FH II 10/ 25 SK	S	50	289,60
FH II 10/ 50 SK	S	50	322,80
FH II 12/ 15 SK	S	25	397,95
FH II 12/ 25 SK	S	25	453,80
FH II 12/ 50 SK	S	25	466,50
FH II 15/ 15 SK	S	25	597,20
FH II 15/ 25 SK	S	25	656,90
FH II 15/ 50 SK	S	25	679,25
FH II 18/ 15 SK	S	20	1153,80
FH II 18/ 25 SK	S	20	1206,40
FH II 18/ 50 SK	S	20	1404,65

Artikel	88594.942
88594	A 4
	FH II-SK

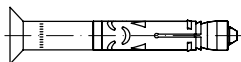

FISCHER Hochleistungsanker FH II-SK mit Senkkopf

Produktinformation → TI-172



Dübel-/Bohr Ø x Einbautiefe / Klemmlänge

FH II 12/ 15 SK	S	25	1375,50
FH II 12/ 30 SK	S	25	1662,60
FH II 12/ 50 SK	S	25	1849,10
FH II 15/ 15 SK	S	25	1881,15
FH II 18/ 30 SK	S	20	3686,35

Abmessungen	VE Stück	€/100/Obf.
Artikel	88590.012	
88590	Stahl	FH II-H
	galvanisch verzinkt	

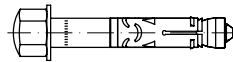

FISCHER Hochleistungsanker FH II-H mit Sechskant-Hutmutter

Produktinformation → TI-172



Dübel-/Bohr Ø x Einbautiefe / Klemmlänge

FH II 10/ 10 H	S	50	272,25
FH II 10/ 25 H	S	50	301,55
FH II 10/ 50 H	S	50	336,10
FH II 12/ 10 H	S	50	431,10
FH II 12/ 25 H	S	50	467,90
FH II 12/ 50 H	S	25	527,35
FH II 15/ 10 H	S	25	597,60
FH II 15/ 25 H	S	25	641,45
FH II 15/ 50 H	S	25	728,20
FH II 18/ 25 H	S	20	951,80
FH II 18/ 50 H	S	20	1101,60

Artikel	88592.012
88592	Stahl
	FH II-B
	galvanisch verzinkt

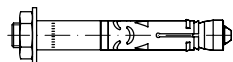

FISCHER Hochleistungsanker FH II-B mit Mutter und Gewindebolzen

Produktinformation → TI-178



Dübel- / Bohr Ø x Klemmlänge

FH II 10/ 10 B	S	50	252,05
FH II 10/ 25 B	S	50	273,35
FH II 10/ 50 B	S	50	307,45
FH II 12/ 10 B	S	50	379,15
FH II 12/ 25 B	S	50	420,10
FH II 12/ 50 B	S	25	480,85
FH II 12/ 100 B	S	25	586,40
FH II 15/ 10 B	S	25	542,05
FH II 15/ 25 B	S	25	566,40
FH II 15/ 50 B	S	25	650,40
FH II 15/ 100 B	S	20	786,45
FH II 18/ 25 B	S	20	834,90
FH II 18/ 50 B	S	20	1012,35
FH II 18/ 100 B	S	10	1209,35
FH II 24/ 25 B	S	10	1935,65
FH II 24/ 50 B	S	10	2114,80
FH II 24/ 100 B	S	5	2630,10
FH II 28/ 30 B	S	4	3140,05
FH II 28/ 60 B	S	4	3640,50
FH II 32/ 30 B	S	4	4645,55
FH II 32/ 60 B	S	4	5530,50

Abmessungen	VE Stück	€/100/Obf.
Artikel	88689.012	
88689	Stahl	FH II-I
	galvanisch verzinkt	

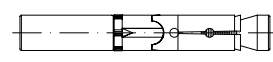

FISCHER Hochleistungsanker FH II-I mit Anschluss-Innengewinde M

Produktinformation → TI-173



Dübel- / Bohr Ø / Anschluss-Gew. M

FH II 12/M 6 I	S	25	449,30
FH II 12/M 8 I	S	25	449,30
FH II 15/M 10 I	S	25	580,05
FH II 15/M 12 I	S	20	580,05

Artikel	88689.942
88689	A 4
	FH II-I

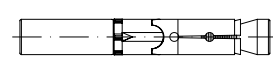

FISCHER Hochleistungsanker FH II-I mit Anschluss-Innengewinde M

Produktinformation → TI-173



Dübel- / Bohr Ø / Anschluss-Gew. M

FH II 12/M 6 I	S	25	757,50
FH II 12/M 8 I	S	25	757,50
FH II 15/M 10 I	S	25	1073,25
FH II 15/M 12 I	S	20	1073,25

Artikel	88583.010
88583	Stahl
	galvanisch verzinkt
	FZA

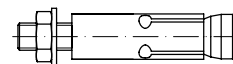

FISCHER ZYKON-Bolzenanker FZA mit Mutter und Scheibe, für Vorsteckmontagen

Produktinformation → TI-174



Dübel-/Bohr Ø x Einbautiefe / M / Klemmlänge

10	x	40 M	6/10	S	25	210,85
12	x	40 M	8/15	S	25	356,85
12	x	50 M	8/15	S	20	469,65
14	x	40 M	10/25	S	25	415,00
14	x	60 M	10/25	S	10	612,25

Abmessungen	VE	Stück	€/100/Obf.
18 x 80 M 12/25	S	10	896,00
22 x 100 M 16/60	S	10	2141,50
22 x 125 M 16/60	S	6	2615,45

Artikel 88583.940
88583 A 4 FZA

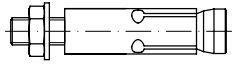

FISCHER ZYKON-Bolzenanker FZA mit Mutter und Scheibe, für Vorsteckmontagen

Produktinformation → TI-174

ETA CE R120 Feuerwiderstandsklasse Z Zugzonentauglich VdS approval REACH SVHC free

Dübel-/Bohr Ø x Einbautiefe / M / Klemmlänge

10 x 40 M 6/10	S	25	728,80
12 x 40 M 8/15	S	25	1117,25
12 x 50 M 8/15	S	20	1191,25
12 x 50 M 8/50	S	20	1302,70
14 x 40 M 10/25	S	20	1257,50
14 x 60 M 10/25	S	10	2147,30
14 x 60 M 10/50	S	10	2357,20
18 x 80 M 12/25	S	10	3255,70
18 x 80 M 12/55	S	10	3492,05
22 x 100 M 16/60	S	10	5201,30
22 x 125 M 16/60	S	6	6217,05

Artikel 88584.010
88584 Stahl galvanisch verzinkt FZA-D

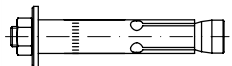

FISCHER ZYKON-Durchsteckanker FZA-D mit Mutter und Scheibe, für Durchsteckmontagen

Produktinformation → TI-174

ETA CE R120 Feuerwiderstandsklasse Z Zugzonentauglich VdS approval REACH SVHC free

Dübel-/Bohr Ø x Einbautiefe / M Ø / Klemmlänge

12 x 50 M 8D/10	S	25	479,90
12 x 60 M 8D/10	S	25	502,45
12 x 80 M 8D/30	S	25	552,85
14 x 80 M 10D/20	S	10	743,55
14 x 100 M 10D/40	S	10	816,90
18 x 100 M 12D/20	S	10	1053,15
18 x 130 M 12D/50	S	10	1223,00
22 x 125 M 16D/25	S	10	2598,60

Abmessungen	VE	Stück	€/100/Obf.
Artikel 88584.940			

88584 A 4 FZA-D

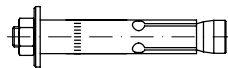

FISCHER ZYKON-Durchsteckanker FZA-D mit Mutter und Scheibe, für Durchsteckmontagen

Produktinformation → TI-174

ETA CE R120 Feuerwiderstandsklasse Z Zugzonentauglich VdS approval REACH SVHC free

Dübel-/Bohr Ø x Einbautiefe / M Ø / Klemmlänge

12 x 50 M 8D/10	S	25	1194,00
12 x 60 M 8D/10	S	25	1232,05
12 x 80 M 8D/30	S	25	1390,80
14 x 80 M 10D/20	S	10	2211,90
14 x 100 M 10D/40	S	10	2880,80
18 x 100 M 12D/20	S	10	3388,20
18 x 130 M 12D/50	S	10	4477,25
22 x 125 M 16D/25	S	10	6092,70

Artikel 88589.940
88589 A 4 FZA ST

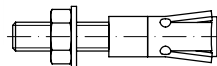

FISCHER ZYKON-Steigeisen-Befestigung FZA ST

Produktinformation → TI-174

REACH SVHC free

Dübel-/Bohr Ø / Einbautiefe

FZA 14 / 40 ST	S	20	1487,55
FZA 14 / 60 ST	S	20	2244,20

Artikel 88585.010
88585 Stahl galvanisch verzinkt FZA-I

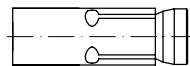

FISCHER ZYKON-Innengewindeanker FZA-I für Vorsteckmontagen

Produktinformation → TI-175

ETA CE R120 Feuerwiderstandsklasse Z Zugzonentauglich VdS approval REACH SVHC free

Dübel-/Bohr Ø x Einbautiefe / Gew. M

12 x 40 M 6 I	S	25	362,05
14 x 60 M 8 I	S	20	614,40
18 x 80 M 10 I	S	10	907,90

Abmessungen	VE	Stück	€/100/Obf.
22 x 100 M 12 I	S	10	2156,60
22 x 125 M 12 I	S	10	2616,75

Artikel 88585.940
88585 A 4 FZA-I

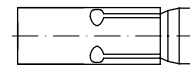

FISCHER ZYKON-Innengewindeanker FZA-I für Vorsteckmontagen

Produktinformation → TI-175

ETA CE R120 Feuerwiderstandsklasse Z Zugzonentauglich VdS approval REACH SVHC free

Dübel- / Bohr Ø x Einbautiefe / Anschluss-Gew. M

12 x 40 M 6 I	S	25	1128,45
12 x 50 M 6 I	S	25	1185,05
14 x 60 M 8 I	S	20	2140,20
18 x 80 M 10 I	S	10	2812,10
22 x 100 M 12 I	S	10	5100,80
22 x 125 M 12 I	S	10	6122,25

Artikel 88597.012
88597 Stahl galvanisch verzinkt FZEA II

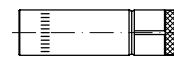

FISCHER ZYKON-Einschlaganker FZEA II mit Anschluss-Innengewinde, für Vorsteckmontagen

Produktinformation → TI-175

ETA CE R120 Feuerwiderstandsklasse Z Zugzonentauglich FM Zulassung VdS approval REACH SVHC free

Dübel-/Bohr Ø x Einbautiefe / Anschluss-Gew. M

10 x 40 M 8	S	100	91,10
12 x 40 M 10	S	100	102,65
14 x 40 M 12	S	50	154,05

Abmessungen	VE Stück	€/100/Obf.
Artikel 88597.942		
88597 A 4		FZEA II

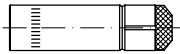

FISCHER ZYKON-Einschlaganker FZEA II mit Anschluss-Innengewinde, für Vorsteckmontagen

Produktinformation → TI-175



Dübel-/Bohr Ø x Einbautiefe / Anschluss-Gew. M

10	x 40 M 8	S	100	703,15
12	x 40 M 10	S	100	884,35
14	x 40 M 12	S	50	1273,15

Artikel	88587.000	Stahl	FZUB
88587			

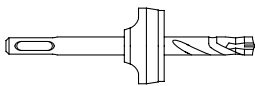

FISCHER Bohrer FZUB für FISCHER ZYKON-Anker



Für Dübel Ø x Einbautiefe

FZUB 10	x 40	S	1	5595,00
FZUB 12	x 40	S	1	5755,00
FZUB 12	x 50	S	1	6385,00
FZUB 12	x 60	S	1	6960,00
FZUB 12	x 80	S	1	7965,00
FZUB 14	x 40	S	1	6090,00
FZUB 14	x 60	S	1	7090,00
FZUB 14	x 80	S	1	8315,00
FZUB 14	x 100	S	1	9145,00
FZUB 18	x 80	S	1	13300,00
FZUB 18	x 100	S	1	14865,00
FZUB 18	x 130	S	1	17170,00
FZUB 22	x 100	S	1	15625,00
FZUB 22	x 125	S	1	17620,00

Abmessungen	VE Stück	€/100/Obf.
Artikel 88588.002		
88588 Stahl		FZE plus

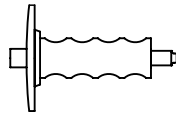

FISCHER Einschlaggerät FZE plus mit Zentrierstift

für Handhammermontage von FISCHER ZYKON-Anker FZA



Für Dübel Ø

FZE 10 plus	S	1	1945,00
FZE 12 plus	S	1	1950,00
FZE 14 plus	S	1	1955,00
FZE 18 plus	S	1	2185,00
FZE 22 plus	S	1	2540,00

Artikel	88595.000	Stahl	FZED plus
88595			

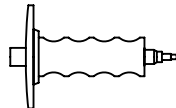

FISCHER Einschlaggerät FZED plus mit Zentrierstift

für Handhammermontage von FISCHER-ZYKON-Einschlaganker FZEA II



Für Dübel Ø

FZED 10 plus	S	1	2480,00
FZED 12 plus	S	1	2510,00
FZED 14 plus	S	1	2540,00

Artikel	88567.010	Stahl	EA II
88567		galvanisch verzinkt	



FISCHER Einschlaganker EA II mit Spreizkonus, für Vorsteckmontagen

Produktinformation → TI-176



Konus-Innengewinde M

EA II M 6	x 30	S	100	36,50
EA II M 8	x 30	S	100	48,50
EA II M 8	x 40	S	50	66,45
EA II M10	x 40	S	50	75,30

Abmessungen	VE Stück	€/100/Obf.
EA II M12 x 50	S 25	113,20
EA II M16 x 65	S 20	194,60
EA II M20 x 80	S 10	353,90

Artikel	88567.940	A 4	EA II
88567			



FISCHER Einschlaganker EA II mit Spreizkonus, für Vorsteckmontagen

Produktinformation → TI-176



Konus-Innengewinde M

EA II M 6	x 30	S	100	320,95
EA II M 8	x 30	S	100	370,95
EA II M10	x 40	S	50	477,95
EA II M12	x 50	S	25	832,45
EA II M16	x 65	S	20	2258,70

Artikel	88568.002	Stahl	EAW H plus
88568			

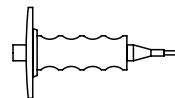

FISCHER Setzwerkzeug EAW H plus mit Handschutz

für Einschlaganker EA II



Für Nennmaß EA II

EAW H 6 plus	S	1	2720,00
EAW H 8 x 30 plus	S	1	2730,00
EAW H 8 x 40 plus	S	1	2740,00
EAW H 10 plus	S	1	2760,00
EAW H 12 plus	S	1	2780,00
EAW H 16 plus	S	1	2880,00
EAW H 20 plus	S	1	3665,00

Abmessungen	VE Stück	€/100/Obf.
Artikel	88546.010	
88546 Stahl FNA II galvanisch verzinkt		



FISCHER Nagelanker FNA II mit Nagelkopf

Produktinformation → TI-176

ETA CE	R120 Feuerwiderstandsklasse	Z Zugzonentauglich	REACH SVHC free
---------------	------------------------------------	---------------------------	------------------------

Dübel-/Bohr Ø x Einbautiefe / Klemmlänge

FNAII 6 x 25/ 5	S	100	54,30
FNAII 6 x 30/ 5	S	100	55,90
FNAII 6 x 30/ 30	S	50	71,40
FNAII 6 x 30/ 50	S	50	82,55
FNAII 6 x 30/ 75	S	50	95,55
FNAII 6 x 30/100	S	50	161,20
FNA I 6 x 30/120	S	50	187,55

Artikel	88547.010
88547 Stahl FNA II M galvanisch verzinkt	

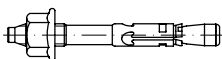

FISCHER Nagelanker FNA II M mit Gewinde und Flanschmutter

Produktinformation → TI-177

ETA CE	R120 Feuerwiderstandsklasse	Z Zugzonentauglich	REACH SVHC free
---------------	------------------------------------	---------------------------	------------------------

Dübel-/Bohr x Einbautiefe - Gewinde/Klemmlänge

FNAII 6 x 30M6/5	S	100	71,15
------------------	---	-----	-------

Artikel	88548.010
88548 Stahl FNA II-OE galvanisch verzinkt	

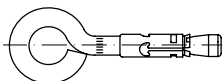

FISCHER Nagelanker FNA II-OE, OE = mit Öse

Produktinformation → TI-177

ETA CE	R120 Feuerwiderstandsklasse	Z Zugzonentauglich	REACH SVHC free
---------------	------------------------------------	---------------------------	------------------------

Dübel-/Bohr Ø x Einbautiefe

FNA II 6 x 25 OE	S	50	79,80
------------------	---	----	-------

Abmessungen	VE Stück	€/100/Obf.
Artikel	88549.010	
88549 Stahl FNA II-H galvanisch verzinkt		

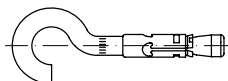

FISCHER Nagelanker FNA II-H, H = mit Haken

Produktinformation → TI-178

R120 Feuerwiderstandsklasse	Z Zugzonentauglich	REACH SVHC free
------------------------------------	---------------------------	------------------------

Dübel- / Bohr Ø x Einbautiefe

FNA II 6 x 25 H	S	50	79,80
-----------------	---	----	-------

Artikel	88582.012
88582 Stahl FBN II galvanisch verzinkt	

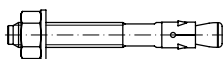

FISCHER Bolzenanker FBN II mit Spreizclip, Mutter und Scheibe

Produktinformation → TI-178

ETA CE	R120 Feuerwiderstandsklasse	REACH SVHC free
---------------	------------------------------------	------------------------

Dübel-/Bohr Ø / Klemmlänge

FBN II 6/ 5	S	100	75,80
FBN II 6/ 10	S	100	79,50
FBN II 6/ 30	S	100	90,75
FBN II 8/ 5	S	50	82,70
FBN II 8/ 10	S	50	83,40
FBN II 8/ 20	S	50	94,95
FBN II 8/ 30	S	50	102,95
FBN II 8/ 50	S	50	118,90
FBN II 8/ 70	S	20	135,35
FBN II 8/100	S	20	162,75
FBN II10/ 10	S	50	106,15
FBN II10/ 20	S	50	116,80
FBN II10/ 30	S	50	125,95
FBN II10/ 50	S	20	145,20
FBN II10/ 70	S	20	178,35
FBN II10/100	S	20	196,05
FBN II10/140	S	20	253,85
FBN II10/160	S	20	279,60
FBN II12/ 10	S	20	161,30
FBN II12/ 20	S	20	175,30
FBN II12/ 30	S	20	189,25
FBN II12/ 50	S	20	236,65
FBN II12/ 80	S	20	306,70
FBN II12/100	S	20	335,90
FBN II12/120	S	20	362,15
FBN II12/140	S	20	380,05
FBN II12/160	S	20	410,80
FBN II16/ 25	S	10	359,15
FBN II16/ 50	S	10	493,85
FBN II16/ 80	S	10	599,45
FBN II16/100	S	10	620,70
FBN II16/140	S	10	754,00
FBN II16/160	S	10	805,55
FBN II16/200	S	10	964,15
FBN II20/ 30	S	10	835,10

Abmessungen	VE Stück	€/100/Obf.	
FBN II 20/ 60	S	10	1084,90
FBN II 20/ 80	S	10	1296,50
FBN II 20/120	S	10	1579,80

Artikel	88582.022
88582 Stahl FBN II feuerverzinkt	

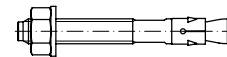

FISCHER Bolzenanker FBN II mit Spreizclip, Mutter und Scheibe

Produktinformation → TI-178

ETA CE	R120 Feuerwiderstandsklasse	REACH SVHC free
---------------	------------------------------------	------------------------

Dübel-/Bohr Ø / Klemmlänge

FBN II 8/ 10	S	50	198,60
FBN II 8/ 30	S	50	230,80
FBN II 8/ 50	S	50	259,95
FBN II 8/ 70	S	20	296,70
FBN II10/ 10	S	50	303,00
FBN II10/ 30	S	50	319,35
FBN II10/ 50	S	20	348,35
FBN II10/100	S	20	404,05
FBN II12/ 10	S	20	382,90
FBN 12/ 30	S	20	424,60

Artikel	88582.942
88582 A 4 FBN II	

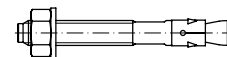

FISCHER Bolzenanker FBN II mit Spreizclip, Mutter und Scheibe

Produktinformation → TI-178

ETA CE	R120 Feuerwiderstandsklasse	REACH SVHC free
---------------	------------------------------------	------------------------

Dübel-/Bohr Ø / Klemmlänge

FBN II 6/ 10	S	100	265,90 A4
FBN II 6/ 30	S	100	286,80 A4
FBN II 8/ 10	S	50	332,85 A4
FBN II 8/ 30	S	50	370,45 A4
FBN II 8/ 50	S	50	447,80 A4
FBN II 10/ 10	S	50	385,45 A4
FBN II 10/ 20	S	50	398,60 A4
FBN II 10/ 30	S	50	438,60 A4
FBN II 10/ 50	S	20	547,25 A4
FBN II 10/100	S	20	787,05 A4
FBN II 12/ 10	S	20	582,55 A4
FBN II 12/ 20	S	20	599,50 A4
FBN II 12/ 30	S	20	651,80 A4
FBN II 12/ 50	S	20	802,25 A4
FBN II 12/100	S	20	1166,25 A4
FBN II 16/ 10	S	10	1262,25 A4
FBN II 16/ 25	S	10	1232,80 A4
FBN II 16/ 50	S	10	1592,75 A4
FBN II 20/ 30	S	10	2956,05 A4

Abmessungen	VE Stück	€/100/Obf.
Artikel	88582.014	
88582	Stahl	FBN II K
galvanisch verzinkt		

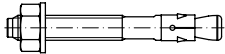

FISCHER Bolzenanker FBN II K mit Spreizclip, Mutter und Scheibe, K = kurze Ausführung

Produktinformation → TI-178



Dübel-/Bohr Ø / Klemmlänge

FBN II 8/ 5K	S	50	81,20
FBN II 8/ 10K	S	50	83,25
FBN II 10/ 5K	S	50	99,90
FBN II 10/ 10K	S	50	103,45
FBN II 12/ 5K	S	20	153,40
FBN II 12/ 10K	S	20	157,90
FBN II 12/ 30K	S	20	185,15
FBN II 16/ 15K	S	10	320,50
FBN II 16/ 25K	S	10	350,30
FBN II 20/ 10K	S	10	802,75

Artikel	88582.944
88582	A 4
	FBN II K

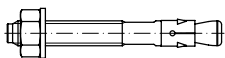

FISCHER Bolzenanker FBN II K mit Spreizclip, Mutter und Scheibe, K = kurze Ausführung

Produktinformation → TI-178



Dübel-/Bohr Ø / Klemmlänge

FBN II 8/ 5K	S	50	296,55 A4
FBN II 10/ 5K	S	50	382,55 A4
FBN II 12/ 5K	S	20	577,35 A4
FBN II 16/15K	S	10	1225,60 A4

Abmessungen	VE Stück	€/100/Obf.
Artikel	88582.016	
88582	Stahl	FBN II GS
galvanisch verzinkt		

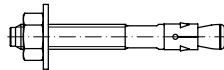

FISCHER Bolzenanker FBN II mit Spreizclip, Mutter und großer Scheibe

Produktinformation → TI-178



Dübel-/Bohr Ø / Klemmlänge

FBN II 12/ 80 GS	S	20	351,25
FBN II 12/100 GS	S	20	372,40
FBN II 12/120 GS	S	20	398,70
FBN II 12/140 GS	S	10	416,55
FBN II 12/160 GS	S	10	447,30
FBN II 12/180 GS	S	10	511,15
FBN II 12/200 GS	S	10	543,70
FBN II 12/250 GS	S	10	712,40
FBN II 16/100 GS	S	10	676,15
FBN II 16/140 GS	S	10	821,25
FBN II 16/160 GS	S	10	872,80
FBN II 16/200 GS	S	10	1031,45
FBN II 16/250 GS	S	10	1279,25
FBN II 16/300 GS	S	10	1399,55

Artikel	88715.310
88715	Stahl, galZn
	Spreizclip A 2
	EXA

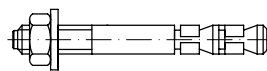

FISCHER Bolzenanker EXA mit 2 Spreizclips, Mutter und Scheibe

*keine ETA Zulassung

Produktinformation → TI-181



Dübel-/Bohr Ø Klemmlänge

EXA 6/ 05 *	S	100	121,00
EXA 6/ 10 *	S	100	129,00
EXA 6/ 40 *	S	100	155,00
EXA 8/ 05	S	50	145,00
EXA 8/ 15	S	50	146,00
EXA 8/ 28	S	50	171,00
EXA 8/ 55	S	50	189,00
EXA 10/ 05	S	50	206,00
EXA 10/ 15	S	50	210,00
EXA 10/ 45	S	50	248,00
EXA 10/ 90	S	50	320,00
EXA 10/140	S	25	425,00
EXA 10/160	S	25	460,00
EXA 12/ 05	S	25	315,00
EXA 12/ 15	S	25	325,00
EXA 12/ 35	S	25	375,00
EXA 12/ 55	S	25	400,00
EXA 12/ 85	S	25	550,00
EXA 12/105	S	25	580,00
EXA 16/ 10	S	20	550,00

Abmessungen	VE Stück	€/100/Obf.	
EXA 16/ 30	S	10	610,00
EXA 16/ 75	S	20	990,00
EXA 20/ 10	S	10	1260,00
EXA 20/ 25	S	10	1340,00
EXA 20/ 80	S	10	1870,00
EXA 20/220	S	10	3300,00
EXA 24/ 40 *	S	10	3400,00

Artikel	88715.314
88715	Stahl, galZn
	Spreizclip A 2
	EXA-K

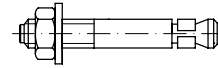

FISCHER Bolzenanker EXA-K mit 1 Spreizclip, Mutter und Scheibe, für geringe Verankerungstiefen, K = kurze Ausführung

Produktinformation → TI-181



Dübel-/Bohr Ø (Klemmlänge 5)

EXA M 8 K	S	100	110,00
EXA M 10 K	S	50	162,00

Artikel	88683.010
88683	Stahl
	galvanisch verzinkt
	TA M



FISCHER Schwerlastanker TA M für Schrauben mit M-Gewinde

Produktinformation → TI-179



Für Schrauben M

TA M 6	S	50	199,30
TA M 8	S	50	258,35
TA M 10	S	25	376,65
TA M 12	S	25	695,10



Wir versorgen Sie mit
Verbindungselementen
und Befestigungstechnik!

Abmessungen VE Stück €/100/Obf.

Artikel	88530.010	
88530	Stahl	SL M
	galvanisch verzinkt	

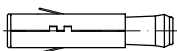

FISCHER Schwerlastanker SL M für Schrauben mit Gewinde

Produktinformation → [TI-179](#)

• M6-M12 → TA M → Artikel 88683



Für Schrauben M

SL M 16 *	S	10	1493,45
SL M 20 *	S	5	2308,25
SL M 24 *	S	5	3701,90

Artikel	88530.940	
88530	A 4	SL M-N

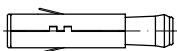

FISCHER Schwerlastanker SL M-N für Schrauben mit Gewinde

Produktinformation → [TI-179](#)



Für Schrauben M

SL M 8 N	S	25	1019,20
SL M 10 N	S	20	1606,45

Artikel	88531.010	
88531	Stahl	MR
	galvanisch verzinkt	

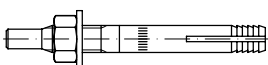

FISCHER Mauerschrauben MR mit Mutter und Scheibe

Produktinformation → [TI-180](#)



Dübel-/Bohr Ø x Dübellänge

MR 8	x	70	S	25	604,00
MR 10	x	85	S	20	894,60
MR 12	x	100	S	10	1192,15

Abmessungen VE Stück €/100/Obf.

Artikel	88513.010	
88513	Stahl	FHY
	galvanisch verzinkt	

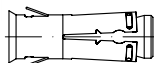

FISCHER Hohldeckenanker FHY mit Innengewinde für Schrauben

Produktinformation → [TI-180](#)



Innengewinde M

FHY M 6	S	50	200,50
FHY M 8	S	25	301,70
FHY M 10	S	20	410,15

Artikel	88513.940	
88513	A 4	FHY

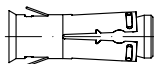

FISCHER Hohldeckenanker FHY mit Innengewinde für Schrauben

Produktinformation → [TI-180](#)



Innengewinde M

FHY M 6	S	50	638,90
FHY M 8	S	50	828,15
FHY M 10	S	20	1046,15

Artikel	88688.010	
88688	Stahl	FPX-I
	galvanisch verzinkt	



FISCHER Porenbetonanker FPX-I mit Anschluss-Innengewinde M, mit Vierkant-Spreizhülse

Produktinformation → [TI-181](#)



Innengewinde M

FPX M 6 -I	S	25	307,45
FPX M 8 -I	S	25	313,20
FPX M 10 -I	S	25	319,00
FPX M 12 -I	S	25	324,80

Abmessungen VE Stück €/100/Obf.

Artikel	88542.014	
88542	Dübel-Nylon	SXR-T
	Schr. St. galv. verz.	

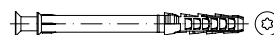

FISCHER Langschaftdübel SXR-T mit Senkkopfschraube, mit Innensechsrund

Produktinformation → [TI-182](#)



Dübel-/Bohr Ø x Dübellänge

SXR 10	x	80 T	S	50	94,15
SXR 10	x	100 T	S	50	103,35
SXR 10	x	120 T	S	50	115,90
SXR 10	x	140 T	S	50	132,00
SXR 10	x	160 T	S	50	178,75
SXR 10	x	180 T	S	50	245,90
SXR 10	x	200 T	S	50	342,75
SXR 10	x	230 T	S	50	417,90
SXR 10	x	260 T	S	50	529,05

Artikel	88542.2944	
88542	Dübel-Nylon	SXR-T
	Schrauben A 4	

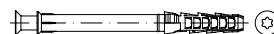

FISCHER Langschaftdübel SXR-T mit Senkkopfschraube, mit Innensechsrund

Produktinformation → [TI-182](#)



Dübel-/Bohr Ø x Dübellänge

SXR 10	x	80 T	S	50	281,05
SXR 10	x	100 T	S	50	334,10
SXR 10	x	120 T	S	50	390,85
SXR 10	x	140 T	S	50	454,50
SXR 10	x	160 T	S	50	600,95
SXR 10	x	180 T	S	50	730,55
SXR 10	x	200 T	S	50	890,10
SXR 10	x	230 T	S	50	1073,25
SXR 10	x	260 T	S	50	1472,60

Abmessungen	VE Stück	€/100/Obf.
Artikel	88542.012	
88542	Dübel-Nylon	SXR-FUS
	Schrb. St. galv. verz.	



FISCHER Langschaftdübel SXR-FUS mit Sechskantkopf (SW13) und Innensechsrund T40

Produktinformation → [TI-182](#)



Dübel-/Bohr Ø x Dübellänge

SXR 10	x	60 FUS	S	50	88,70
SXR 10	x	80 FUS	S	50	99,00
SXR 10	x	100 FUS	S	50	108,75
SXR 10	x	120 FUS	S	50	122,55
SXR 10	x	140 FUS	S	50	138,40
SXR 10	x	160 FUS	S	50	188,95
SXR 10	x	180 FUS	S	50	260,15
SXR 10	x	200 FUS	S	50	362,15
SXR 10	x	230 FUS	S	50	435,45
SXR 10	x	260 FUS	S	50	558,45

Artikel	88542.942
88542	Dübel-Nylon
	SXR-FUS
	Schrauben A 4

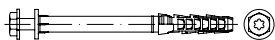

FISCHER Langschaftdübel SXR-FUS mit Sechskantkopf (SW13) und Innensechsrund T40

Produktinformation → [TI-182](#)



Dübel-/Bohr Ø x Dübellänge

SXR 10	x	60 FUS	S	50	264,00
SXR 10	x	80 FUS	S	50	292,25
SXR 10	x	100 FUS	S	50	348,90
SXR 10	x	120 FUS	S	50	410,00
SXR 10	x	140 FUS	S	50	473,65
SXR 10	x	160 FUS	S	50	630,55
SXR 10	x	180 FUS	S	50	767,65
SXR 10	x	200 FUS	S	50	929,85
SXR 10	x	230 FUS	S	50	1119,85
SXR 10	x	260 FUS	S	50	1534,20

Abmessungen	VE Stück	€/100/Obf.
Artikel	88551.014	
88551	Dübel-Nylon	SXRL-T
	Schrb. St. galv. verz.	

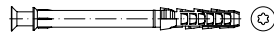

FISCHER Langschaftdübel SXRL-T mit Senkkopfschraube, mit Innensechsrund, mit langem Spreizteil

Produktinformation → [TI-182](#)



Dübel-/Bohr Ø x Dübellänge

SXRL 8	x	80 T	S	50	63,35
SXRL 8	x	100 T	S	50	80,55
SXRL 8	x	120 T	S	50	98,65
SXRL 10	x	80 T	S	50	94,15
SXRL 10	x	100 T	S	50	103,35
SXRL 10	x	120 T	S	50	115,90
SXRL 10	x	140 T	S	50	132,00
SXRL 10	x	160 T	S	50	178,75
SXRL 10	x	180 T	S	50	245,90
SXRL 10	x	200 T	S	50	342,75
SXRL 10	x	230 T	S	50	417,90
SXRL 10	x	260 T	S	50	529,05
SXRL 10	x	290 T	S	50	651,20

Artikel	88551.944
88551	Dübel-Nylon
	SXRL-T
	Schrauben A 4

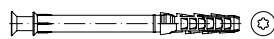

FISCHER Langschaftdübel SXRL-T mit Senkkopfschraube, mit Innensechsrund, mit langem Spreizteil

Produktinformation → [TI-182](#)



Dübel-/Bohr Ø x Dübellänge

SXRL 8	x	80 T	S	50	216,20
SXRL 8	x	100 T	S	50	264,75
SXRL 8	x	120 T	S	50	313,95
SXRL 10	x	80 T	S	50	281,05
SXRL 10	x	100 T	S	50	334,10
SXRL 10	x	120 T	S	50	390,85
SXRL 10	x	140 T	S	50	454,50
SXRL 10	x	160 T	S	50	600,95
SXRL 10	x	180 T	S	50	730,55
SXRL 10	x	200 T	S	50	890,10
SXRL 10	x	230 T	S	50	1073,25
SXRL 10	x	260 T	S	50	1472,60
SXRL 10	x	290 T	S	50	1756,65

Abmessungen	VE Stück	€/100/Obf.
Artikel	88551.015	
88551	Dübel-Nylon	SXRL-FUS
	Schrb. Stahl galv. verz.	

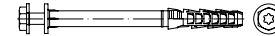

FISCHER Langschaftdübel SXRL-FUS mit Sechskantkopf (SW13) und Innensechsrund T40, mit langem Spreizteil

Produktinformation → [TI-182](#)



Dübel-/Bohr Ø x Dübellänge

SXRL 8	x	80 FUS	S	50	66,85
SXRL 8	x	100 FUS	S	50	85,40
SXRL 8	x	120 FUS	S	50	101,85
SXRL 10	x	80 FUS	S	50	99,00
SXRL 10	x	100 FUS	S	50	108,75
SXRL 10	x	120 FUS	S	50	122,55
SXRL 10	x	140 FUS	S	50	138,40
SXRL 10	x	160 FUS	S	50	188,95
SXRL 10	x	180 FUS	S	50	260,15
SXRL 10	x	200 FUS	S	50	362,15
SXRL 10	x	230 FUS	S	50	435,45
SXRL 10	x	260 FUS	S	50	558,45
SXRL 10	x	290 FUS	S	50	688,85

Artikel	88551.945
88551	Dübel-Nylon
	SXRL-FUS
	Schrauben A 4

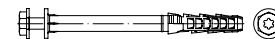

FISCHER Langschaftdübel SXRL-FUS mit Sechskantkopf (SW13) und Innensechsrund T40, mit langem Spreizteil

Produktinformation → [TI-182](#)



Dübel-/Bohr Ø x Dübellänge

SXRL 8	x	80 FUS	S	50	237,40
SXRL 8	x	100 FUS	S	50	282,55
SXRL 10	x	80 FUS	S	50	292,25
SXRL 10	x	100 FUS	S	50	348,90
SXRL 10	x	120 FUS	S	50	410,00
SXRL 10	x	140 FUS	S	50	473,65
SXRL 10	x	160 FUS	S	50	630,55
SXRL 10	x	180 FUS	S	50	767,65
SXRL 10	x	200 FUS	S	50	929,85
SXRL 10	x	230 FUS	S	50	1119,85
SXRL 10	x	260 FUS	S	50	1534,20
SXRL 10	x	290 FUS	S	50	1830,50

Abmessungen	VE Stück	€/100/Obf.
Artikel	88563.010	
88563	Dübel-Nylon	FUR-T
	Schr. St. galv. verz.	



FISCHER Langschaftdübel FUR-T mit Senkkopfschraube, mit Innensechsrund T40

Produktinformation → [TI-184](#)

Kappen → ADT → Artikel 88528

ETA CE	R90 Feuerwiderstandsklasse	HF Halogenn-frei	REACH SVHC free
---------------	--------------------------------------	----------------------------	------------------------

Dübel-/Bohr Ø x Dübellänge

FUR 10	x	80 T	S	50	108,85
FUR 10	x	100 T	S	50	115,90
FUR 10	x	115 T	S	50	127,55
FUR 10	x	135 T	S	50	145,70
FUR 10	x	160 T	S	50	214,90
FUR 10	x	185 T	S	50	341,70
FUR 10	x	200 T	S	50	393,40
FUR 10	x	230 T	S	50	458,95

Artikel	88563.940
88563	Dübel-Nylon
	Schrauben A 4
	FUR-T



FISCHER Langschaftdübel FUR-T mit Senkkopfschraube, mit Innensechsrund T40

Produktinformation → [TI-184](#)

Kappen → ADT → Artikel 88528

ETA CE	R90 Feuerwiderstandsklasse	HF Halogenn-frei	REACH SVHC free
---------------	--------------------------------------	----------------------------	------------------------

Dübel-/Bohr Ø x Dübellänge

FUR 10	x	80 T	S	50	306,70
FUR 10	x	100 T	S	50	366,35
FUR 10	x	115 T	S	50	428,25
FUR 10	x	135 T	S	50	530,00
FUR 10	x	160 T	S	50	728,45
FUR 10	x	185 T	S	50	853,60
FUR 10	x	200 T	S	50	959,90
FUR 10	x	230 T	S	50	1079,25

Abmessungen	VE Stück	€/100/Obf.
Artikel	88564.010	
88564	Dübel-Nylon	FUR-SS
	Schr. St. galv. verz.	



FISCHER Rahmendübel FUR-SS mit Sechskantkopf (SW13)

Produktinformation → [TI-184](#)

ETA CE	R90 Feuerwiderstandsklasse	HF Halogenn-frei	REACH SVHC free
---------------	--------------------------------------	----------------------------	------------------------

Dübel-/Bohr Ø x Dübellänge

FUR 10	x	80 SS	S	50	113,80
FUR 10	x	100 SS	S	50	122,50
FUR 10	x	115 SS	S	50	134,90
FUR 10	x	135 SS	S	50	154,90
FUR 10	x	160 SS	S	50	228,85
FUR 10	x	185 SS	S	50	363,20
FUR 10	x	200 SS	S	50	418,45
FUR 10	x	230 SS	S	50	483,50

Artikel	88564.940
88564	Dübel-Nylon
	Schrauben A 4
	FUR-SS

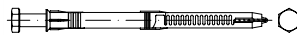

FISCHER Rahmendübel FUR-SS mit Sechskantkopf (SW13)

Produktinformation → [TI-184](#)

ETA CE	R90 Feuerwiderstandsklasse	HF Halogenn-frei	REACH SVHC free
---------------	--------------------------------------	----------------------------	------------------------

Dübel-/Bohr Ø x Dübellänge

FUR 10	x	80 SS	S	50	318,85
FUR 10	x	100 SS	S	50	381,95
FUR 10	x	115 SS	S	50	445,85
FUR 10	x	135 SS	S	50	548,65
FUR 10	x	160 SS	S	50	760,70
FUR 10	x	185 SS	S	50	888,20
FUR 10	x	200 SS	S	50	999,90
FUR 10	x	230 SS	S	50	1125,85

Abmessungen	VE Stück	€/100/Obf.
Artikel	88528.630	
88528	Kunststoff	ADT
	weiß	

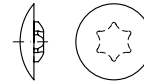

FISCHER Abdeckkappen ADT für Senkkopfschrauben, mit Innensechsrund

Kappen Ø → für Schrauben Ø:

15 → 7
18 → 10

REACH SVHC free

ADT 15	S	100	7,85
ADT 18	S	100	7,85

Artikel	88503.010
88503	Dübel-Nylon
	Schr. St. galv. verz.
	N-S

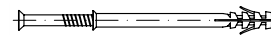

FISCHER Nageldübel N-S mit Nagelschrauben, mit Pozidriv-Kreuzschlitz Z einbaufertig montiert (für < Ø 10)

Produktinformation → [TI-185](#)

HF Halogenn-frei	REACH SVHC free
----------------------------	------------------------

Dübel- / Bohr Ø x Dübellänge / Nutzlänge

N-S 5	x	30/ 5	S	100	15,30
N-S 5	x	40/ 15	S	100	16,25
N-S 5	x	50/ 25	S	100	16,70
N-S 6	x	40/ 10	S	50	20,20
N-S 6	x	60/ 30	S	50	24,25
N-S 6	x	80/ 50	S	50	29,70
N-S 8	x	60/ 20	S	50	28,90
N-S 8	x	80/ 40	S	50	32,45
N-S 8	x	100/ 60	S	50	40,70
N-S 8	x	120/ 80	S	50	54,05
N-S 10	x	100/ 50	S	50	85,20
N-S 10	x	135/ 85	S	50	104,95
N-S 10	x	160/110	S	50	156,75
N-S 10	x	230/180	S	50	360,20

Abmessungen	VE Stück	€/100/Obf.
Artikel	88503.920	
88503	Dübel-Nylon	N-S
	Schrauben A 2	

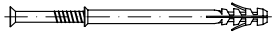

FISCHER Nageldübel N-S mit Nagelschrauben, mit Pozidriv-Kreuzschlitz Z
einbaufertig montiert (für $\varnothing 10$)

Produktinformation → [TI-185](#)



Dübel-/Bohr \varnothing x Dübellänge / Nutzlänge

N-S 5	x 30/ 5	S 100	36,25
N-S 6	x 40/10	S 50	43,30
N-S 6	x 60/30	S 50	46,90
N-S 8	x 60/20	S 50	67,75
N-S 8	x 80/40	S 50	85,50
N-S 8	x 100/60	S 50	111,55

Artikel	88516.010
88516	Dübel-Nylon
	Schr. St. galv. verz.
	F-S

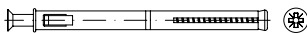

FISCHER Fensterrahmendübel F-S mit Pozidriv-Kreuzschlitz Z 3, mit Senkkopfschraube

Produktinformation → [TI-185](#)

Kappen → ADF → Artikel 88556



Dübel- / Bohr \varnothing x Dübellänge

F 8 S 100	S 50	127,55
F 8 S 120	S 50	137,25
F 8 S 140	S 50	152,50
F 10 S 75	S 50	125,95
F 10 S 100	S 50	131,55
F 10 S 120	S 50	144,50
F 10 S 140	S 50	158,75
F 10 S 165	S 50	211,20

Abmessungen	VE Stück	€/100/Obf.
Artikel	88556.630	
88556	Kunststoff	ADF
	weiß	

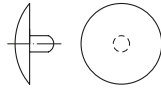

FISCHER Abdeckkappen ADF für Fensterrahmendübel F-S



Kappen \varnothing (passend für F-S 8 und 10 \varnothing)

ADF 12	S 100	7,60
--------	-------	------

Artikel	88680.010
88680	Dübel Stahl*
	Schr. St. galv. verz.
	F-M

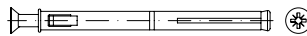

FISCHER Metallrahmendübel F-M mit Senkkopfschraube, mit Spreizkonus, mit Pozidriv-Kreuzschlitz Z 3

*Aluminium beschichtet

Produktinformation → [TI-186](#)



Dübel-/Bohr \varnothing / Dübellänge

F 10 M 72	S 100	73,30
F 10 M 92	S 100	82,65
F 10 M 112	S 100	92,25
F 10 M 132	S 100	101,95
F 10 M 152	S 100	112,50
F 10 M 182	S 50	129,50
F 10 M 202	S 50	149,05

Artikel	88681.(*)
88681	Kunststoff
	ADM

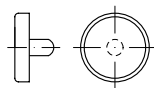

FISCHER Abdeckkappen ADM für Metallrahmendübel F-M

weiß (*630)/braun (*640)



10	S 100	8,40
----	-------	------

Abmessungen	VE Stück	€/100/Obf.
Artikel	88682.(*)	
88682	Kunststoff	ASM
	weiß	

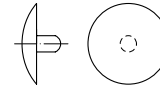

FISCHER Abdeckkappen ASM für Metallrahmendübel F-M
weiß (*630)/braun (*640)



10	S 100	7,65
----	-------	------

Artikel	88515.010
88515	Stahl
	galvanisch verzinkt
	JUSS

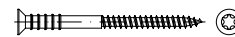

FISCHER Justierschrauben JUSS selbstbohrend, für Holzlattenbefestigungen auf Holz/Wand, mit Innsechsrund T 25

Produktinformation → [TI-186](#)



\varnothing x Länge (Einbautiefe 30 mm)

JUSS 6	x 60/T25	S 100	28,50
JUSS 6	x 70/T25	S 100	31,50
JUSS 6	x 80/T25	S 100	34,90
JUSS 6	x 90/T25	S 100	38,55
JUSS 6	x 100/T25	S 100	42,60
JUSS 6	x 110/T25	S 100	47,85
JUSS 6	x 120/T25	S 100	53,35
JUSS 6	x 145/T25	S 100	64,20

Artikel	88520.600
88520	Nylon
	UX



FISCHER Universaldübel UX für alle Wände, für Holz- und Spanplattenschrauben

Produktinformation → [TI-188](#)



Dübel-/ Bohr \varnothing x Länge

UX 5	x 30	S 100	5,80
UX 6	x 35	S 100	9,35
UX 8	x 50	S 100	12,65

Abmessungen	VE	Stück	€/100/Obf.
UX 10 x 60	S	50	22,55
UX 12 x 70	S	25	35,45
UX 14 x 75	S	20	56,20

Artikel	88520.608
88520	Nylon UX R



FISCHER Universaldübel UX R
für alle Wände, für Holz- und Spanplattenschrauben,
R = mit Bund

Produktinformation → [TI-188](#)

HF Hakenfrei	REACH SVHC free
-----------------	-----------------------

Dübel-/Bohr Ø x Länge

UX 5 x 30 R	S	100	5,80
UX 6 x 35 R	S	100	9,35
UX 8 x 50 R	S	100	12,65
UX 10 x 60 R	S	50	22,55

Artikel	88554.600
88554	Nylon SX

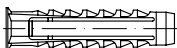

FISCHER Spreizdübel SX,
Spezialdübel für Holz- und Spanplattenschrauben

Produktinformation → [TI-188](#)

HF Hakenfrei	REACH SVHC free
-----------------	-----------------------

Dübel-/Bohr Ø x Dübellänge / für Schrauben Ø max.

SX 4 x 20 / 3	S	200	3,90
SX 5 x 25 / 4	S	100	4,05
SX 6 x 30 / 5	S	100	5,65
SX 6 x 30 S/10	S	50	18,45
SX 6 x 50	S	100	9,60
SX 8 x 40 / 6	S	100	8,20
SX 8 x 40 S/20	S	50	27,05
SX 8 x 65 / 6	S	50	14,65
SX 10 x 50 / 8	S	50	15,65
SX 10 x 80	S	50	26,80
SX 12 x 60 / 10	S	25	23,60
SX 14 x 70 / 12	S	20	43,70
SX 16 x 80 / 12	S	10	64,70

Abmessungen	VE	Stück	€/100/Obf.
Artikel	88500.604		
88500	Nylon		S



FISCHER Spreizdübel S
für Holz- und Spanplattenschrauben

Produktinformation → [TI-189](#)

HF Hakenfrei	REACH SVHC free
-----------------	-----------------------

Dübel- / Bohr Ø x Länge / f. Schrauben Ø max.

S 4 x 20 / 3	S	200	3,85
S 5 x 25 / 4	S	200	3,90
S 5 x 25 / 4	K	100	4,00
S 6 x 30 / 5	S	200	5,45
S 6 x 30 / 5	K	100	5,60
S 8 x 40 / 6	S	200	7,85
S 8 x 40 / 6	K	100	8,15
S 10 x 50 / 8	S	100	14,80
S 10 x 50 / 8	K	50	15,45
S 12 x 60 / 10	S	25	23,40
S 14 x 75 / 12	S	20	43,30
S 16 x 80 / 12	S	10	64,05
S 20 x 90 / 16	S	5	149,90

Artikel	88690.600
88690	Nylon DUOPOWER

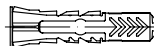

FISCHER Universaldübel DUOPOWER
aus 2 Komponenten für alle Wände,
für Holz-, Span-, und Stockschrauben

Produktinformation → [TI-187](#)

HF Hakenfrei	REACH SVHC free
-----------------	-----------------------

Dübel-/Bohr Ø x Dübellänge

DUOPOWER 5 x 25	S	100	4,50
DUOPOWER 6 x 30	S	100	6,25
DUOPOWER 6 x 50	S	100	10,95
DUOPOWER 8 x 40	S	100	9,10
DUOPOWER 8 x 65	S	50	16,20
DUOPOWER 10 x 50	S	50	17,30
DUOPOWER 10 x 80	S	25	30,65
DUOPOWER 12 x 60	S	25	26,25
DUOPOWER 14 x 70	S	20	48,65

Abmessungen	VE	Stück	€/100/Obf.
Artikel	88690.015		
88690	Dübel-Nylon		DUOPOWER
	Schr. St. galv. verz.		

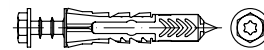

FISCHER Universaldübel DUOPOWER
mit Sicherheitsschraube,
Flanschkopf mit Sechskant SW13,
mit Innensechsrund T40

Produktinformation → [TI-187](#)

HF Hakenfrei	REACH SVHC free
-----------------	-----------------------

Dübel-/Bohr Ø x Dübellänge

DUOPOWER 10 x 50 S	S	25	61,45
--------------------	---	----	-------

Artikel	88690.014
88690	Dübel-Nylon DUOPOWER
	Schr. St. galv. verz.

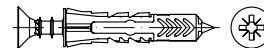

FISCHER Universaldübel DUOPOWER
mit Sicherheitsschraube,
mit Senkkopf,
mit Pozidriv-Kreuzschlitz Z2

Produktinformation → [TI-187](#)

HF Hakenfrei	REACH SVHC free
-----------------	-----------------------

Dübel-/Bohr Ø x Dübellänge

DUOPOWER 5 x 25 S	S	50	18,50
DUOPOWER 6 x 30 S	S	50	20,30
DUOPOWER 8 x 40 S	S	50	29,95

Artikel	88545.010
88545	Stahlblech galvanisch verzinkt
	FMD



FISCHER Metallspreizdübel FMD
für Holzschrauben

Produktinformation → [TI-189](#)

REACH SVHC free

Für Schrauben Ø max. x Dübellänge

FMD 6 x 32	S	100	53,75
FMD 8 x 38	S	100	64,65
FMD 8 x 60	S	50	74,30
FMD 10 x 60	S	50	83,35

Abmessungen	VE Stück	€/100/Obf.
Artikel 88506.600		
88506 Nylon M-S		



FISCHER Spreizdübel M-S für Schrauben mit M-Gewinde

Produktinformation → TI-190



Dübel-/Schrauben Ø x Dübellänge

M 6 S / 40	S 100	18,15
M 8 S / 50	S 50	34,85
M10 S / 70	S 20	94,50
M12 S / 80	S 10	125,55

Artikel	88510.700
88510 Nylon armiert Konus Messing M	



FISCHER Dübel M mit Innengewinde-Konus für Schrauben mit M-Gewinde

Produktinformation → TI-190 REACH → TI-262



Innengewinde Ø x Dübellänge / Bohr Ø

M 5	x 35 / 10	S 50	107,35
M 6	x 40 / 12	S 50	122,05
M 8	x 50 / 16	S 20	211,35
M 10	x 60 / 20	S 10	379,80
M 12	x 65 / 24	S 5	649,50

Artikel	88507.600
88507 Nylon GB	



FISCHER Gasbetondübel GB für FISCHER-Sicherheitsschrauben

Produktinformation → TI-191



Bohr Ø x Dübellänge / für Schrauben Ø

GB 8	x 50 / 5	S 25	71,40
GB 10	x 55 / 7	S 20	85,20
GB 14	x 75 / 10	S 10	133,20

Abmessungen	VE Stück	€/100/Obf.
Artikel 88521.700		
88521 Messing PA 4		

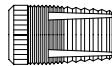

FISCHER Messingdübel PA 4 für Schrauben mit Gewinde

Produktinformation → TI-191 REACH → TI-262

Innengewinde x Dübellänge

PA 4 M 6/ 7,5	S 200	68,55
PA 4 M 6/10,5	S 100	85,10
PA 4 M 6/13,5	S 100	102,15
PA 4 M 8/25	S 50	133,20
PA 4 M10/25	S 25	161,80

Artikel	88512.010
88512 Stahl galvanisch verzinkt HM-S	



FISCHER Hohlraum-Metalldübel HM-S für Hohlraummontagen, S = einbaufertig mit Schraube

Produktinformation → TI-192



Schrauben Ø x Dübellänge

HM 4	x 32 S	S 50	60,90
HM 4	x 46 S	S 50	63,40
HM 5	x 37 S	S 50	69,35
HM 5	x 52 S	S 50	74,15
HM 5	x 65 S	S 50	90,05
HM 6	x 37 S	S 50	75,80
HM 6	x 52 S	S 50	80,20
HM 6	x 65 S	S 50	95,90
HM 6	x 80 S	S 50	108,80

Artikel	88511.000
88511 Stahl HM-Z 1	

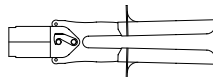

FISCHER Profizange HM-Z 1 für Hohlraumdübel HM-S

Dübel HM-S → Artikel 88512



HMZ 1	S 1	6285,00
-------	-----	---------

Abmessungen	VE Stück	€/100/Obf.
Artikel 88509.600		
88509 Nylon K		

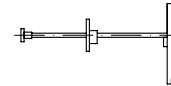

FISCHER Kippdübel K für Hohlraummontagen, für Holzschrauben 4 Ø

Produktinformation → TI-192



Loch Ø

K 54	S 25	74,50
------	------	-------

Artikel	88518.010
88518 Stahl galvanisch verzinkt KD	

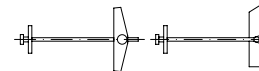

FISCHER Federklappdübel KD mit Schraube für Hohlraummontagen

Produktinformation → TI-193

KD 3 - 4 = Federklapp-Funktion
KD 5 - 8 = Kipp-Funktion



Schrauben Ø x Länge

KD 3	x 95	S 50	95,95
KD 4	x 105	S 25	128,50
KD 5	x 100	S 25	172,05
KD 6	x 100	S 25	225,35
KD 8	x 100	S 20	325,30



- ✓ Große Artikelvielfalt
- ✓ Verlässliche Qualität
- ✓ Hohe Lieferbereitschaft

Abmessungen VE Stück €/100/Obf.

Artikel	88519.010		
88519	Stahl	KDH	galvanisch verzinkt

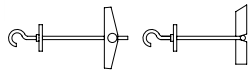

FISCHER Federklappdübel KDH mit Hakenschraube für Hohlraummontagen

Produktinformation → [TI-193](#)

KDH 3 - 4 = Federklapp-Funktion
KDH 5 - 8 = Kipp-Funktion



Schrauben Ø x Länge

KDH 3	x	105	S	25	120,45
KDH 4	x	95	S	25	150,35
KDH 5	x	130	S	20	230,35
KDH 6	x	130	S	20	271,50
KDH 8	x	130	S	20	349,30

Artikel	88598.010		
---------	-----------	--	--

88598	Metall	GKM	galvanisch verzinkt
--------------	---------------	------------	----------------------------

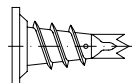

FISCHER Gipskartondübel GKM für Gipskartonplatten, selbstbohrend, mit Pozidriv-Kreuzschlitz Z2

Produktinformation → [TI-194](#)



Für Schrauben Ø max. x Länge / Klemmdicke

5,0	x	31 / -	S	100	32,15
-----	---	--------	---	-----	-------

Artikel	88598.600		
---------	-----------	--	--

88598	Kunststoff	GK	
--------------	-------------------	-----------	--

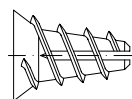

FISCHER Gipskartondübel GK für Gipskartonplatten, mit beigelegtem Eindreh-Werkzeug

Produktinformation → [TI-194](#)



Für Schrauben Ø max. x Länge

5,0	x	22	S	100	20,40
-----	---	----	---	-----	-------

Abmessungen VE Stück €/100/Obf.

Artikel	88558.630		
88558	Nylon grau	FC	



FISCHER Clipschellen FC für Kabel- und Rohrleitungen

Produktinformation → [TI-195](#)

Weitere FISCHER-Elektrobefestigungen auf Anfrage



Für Leitungs Ø von bis

FC 6 - 9	S	100	20,75
FC 9 - 12	S	100	26,25
FC 12 - 16	S	50	31,10
FC 16 - 20	S	25	39,85

Artikel	88559.630		
---------	-----------	--	--

88559	Nylon transparent	SCH	
--------------	--------------------------	------------	--



FISCHER Schellen SCH, Einzel-/Reihenschellen für Kabel- und Rohrleitungen

Produktinformation → [TI-195](#)



Für Leitungs Ø von bis (z.B. 812 = 8-12)

SCH 812	S	100	30,80
SCH 1216	S	50	39,10
SCH 1619	S	50	70,45
SCH 1623	S	50	71,85
SCH 2332	S	25	115,85
SCH 3242	S	25	156,45

Abmessungen VE Stück €/100/Obf.

Artikel	88536.600		
88536	Nylon	S 14 ROE	

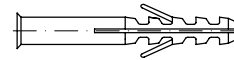

FISCHER Dübel S 14 ROE für Gerüstverankerung mit GS 12, für Einsatz in Vollbaustoffen

Produktinformation → [TI-196](#)

Für Einsatz in Lochsteinen/Gasbeton
→ Typ S 16 auf Anfrage



Dübel-/Bohr Ø x Dübellänge

S 14 ROE 70	S	25	64,25
S 14 ROE 100	S	25	76,60
S 14 ROE 135	S	25	98,85
S 14 ROE 185	S	25	147,80

Artikel	88536.010		
---------	-----------	--	--

88536	Stahl	GS 12	galvanisch verzinkt
--------------	--------------	--------------	----------------------------

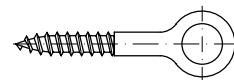

FISCHER Gerüstösen GS 12, Augen geschweißt, Innen Ø 23 für FISCHER Dübel S 14 ROE/S 16 H R

Produktinformation → [TI-196](#)



Schrauben Ø x Länge

GS 12	x	90	S	25	332,70
GS 12	x	120	S	25	363,45
GS 12	x	160	S	25	398,10
GS 12	x	190	S	25	467,30
GS 12	x	230	S	25	541,35
GS 12	x	300	S	25	623,65
GS 12	x	350	S	25	782,60



Wir versorgen Sie mit Verbindungselementen und Befestigungstechnik!

Abmessungen	VE Stück	€/100/Obf.
Artikel 88514.600		
88514	Kunststoff	DHK

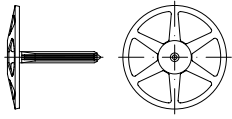

FISCHER Dämmstoffhalter DHK, Teller Ø 90

Produktinformation → [TI-197](#)



Für Plattendicke

DHK 40	S	250	32,45
DHK 60	S	250	34,80
DHK 80	S	250	38,00
DHK 100	S	250	42,80
DHK 120	S	200	48,55
DHK 140	S	200	63,00
DHK 160	S	100	70,35
DHK 180	S	100	77,70
DHK 200	S	100	85,05
DHK 220	S	100	97,70

Artikel	88580.600
88580	Kunststoff DT



FISCHER Dämmstoffteller DT

zur Verwendung mit Nageldübel N-S oder Verblendanker VB

Produktinformation → [TI-197](#)



Teller Ø / Durchgangsloch Ø

DT 90 / 4	S	250	30,65
DT 90 / 8	S	250	32,05

Artikel	88696.600
88696	Nylon FID



FISCHER Dämmstoffdübel FID

Produktinformation → [TI-197](#)



Dübellänge

FID 50	S	50	81,35
FID 90	S	25	108,55

Abmessungen	VE Stück	€/100/Obf.
Artikel 88695.010		
88695	Thermax	



8 / 10 12 / 16

FISCHER Abstandmontagesystem Thermax



Produktinformation → [TI-198](#)

8/ 80 M 6	S	20	417,35
8/100 M 6	S	20	424,70
8/120 M 6	S	20	432,00
8/140 M 6	S	20	439,25
8/160 M 6	S	20	453,85
10/120 M 8	S	20	490,60
10/140 M 10	S	20	497,85
10/160 M 8	S	20	512,50
10/160 M 10	S	20	512,50
10/180 M 6	S	20	519,75
10/200 M 8	S	20	534,65
10/200 M 10	S	20	534,65
10/240 M 8	S	20	653,65
12/110 M 12	S	20	5605,00
16/170 M 12	S	20	2165,00

Artikel	88565.000
88565	Polyurethan 1 K-PU 1-Komp.-Schaum



FISCHER-Montageschaum PU zum Füllen, Isolieren, Dichten, Kartusche mit verschließbarem Dosierventil

Inhalt pro Kartusche/max. Schaumertrag 500 ml ~ 30 l

Inhalt / ml

PU 1 500	S	12	1445,00
----------	---	----	---------

Abmessungen	VE Stück	€/100/Obf.
Artikel 88741.010		
88741	Stahl galvanisch verzinkt	MAX

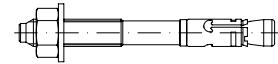

UPAT Expressanker MAX mit Spreizclip, Mutter und Scheibe

Produktinformation → [TI-198](#)



Dübel- / Bohr Ø / Klemmlänge / Dübellänge

MAX 8/ 10/ 75	S	100	91,00
MAX 8/ 30/ 95	S	100	116,00
MAX 8/ 50/115	S	100	140,00
MAX 10/ 10/ 95	S	50	130,00
MAX 10/ 20/105	S	50	147,00
MAX 10/ 30/115	S	50	154,00
MAX 10/ 50/135	S	50	169,00
MAX 10/ 80/165	S	40	209,00
MAX 10/100/185	S	50	216,00
MAX 12/ 10/110	S	20	188,00
MAX 12/ 20/120	S	20	197,00
MAX 12/ 30/130	S	20	209,00
MAX 12/ 50/150	S	20	270,00
MAX 12/ 80/180	S	20	350,00
MAX 12/100/200	S	20	375,00
MAX 12/120/220	S	20	430,00
MAX 12/160/260	S	10	460,00
MAX 12/200/300	S	10	570,00
MAX 16/ 25/148	S	20	410,00
MAX 16/ 50/173	S	20	520,00
MAX 16/100/223	S	10	710,00
MAX 16/160/283	S	10	920,00
MAX 16/200/323	S	10	1020,00
MAX 16/250/373	S	10	1100,00
MAX 16/300/423	S	10	1250,00
MAX 20/ 30/172	S	10	850,00
MAX 20/ 60/202	S	10	860,00

Artikel	88741.940
88741	A 4 MAX

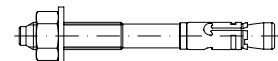

UPAT Expressanker MAX mit Spreizclip, Mutter und Scheibe

Produktinformation → [TI-198](#)



Dübel- / Bohr Ø / Klemmlänge / Dübellänge

MAX 8/ 10/ 75	S	50	395,00
MAX 8/ 30/ 95	S	50	485,00
MAX 8/ 50/115	S	50	520,00
MAX 10/ 10/ 95	S	50	560,00
MAX 10/ 20/105	S	50	580,00
MAX 10/ 30/115	S	50	650,00
MAX 10/ 50/135	S	50	720,00

Abmessungen	VE	Stück	€/100/Obf.
MAX 10/100/185	S	50	890,00
MAX 12/ 10/110	S	20	770,00
MAX 12/ 20/120	S	20	770,00
MAX 12/ 30/130	S	20	870,00
MAX 12/ 50/150	S	20	990,00
MAX 12/100/200	S	20	1340,00
MAX 16/ 25/148	S	20	1610,00
MAX 16/ 50/173	S	20	1870,00
MAX 16/100/223	S	10	2140,00
MAX 20/ 30/172	S	10	3300,00
MAX 20/ 60/202	S	10	3650,00

Artikel	88764.010
88764	Stahl galvanisch verzinkt IMC

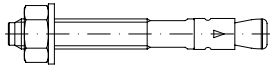

UPAT Expressanker IMC mit Spreizclip, Mutter und Scheibe

Produktinformation → TI-198

ETA CE	F120 Feuerwiderstandsklasse	REACH SVHC free
---------------	---------------------------------------	------------------------

Dübel- / Bohr Ø / Klemmlänge / Dübellänge

6/ 05/ 40	S	100	45,00
8/ 05/ 56 K	S	100	64,00
8/ 05/ 66	S	100	65,00
8/ 10/ 71	S	100	65,00
8/ 20/ 81	S	100	73,00
8/ 30/ 91	S	100	81,00
8/ 50/111	S	100	93,00
8/100/161	S	50	128,00
10/ 05/ 71 K	S	50	96,00
10/ 10/ 86	S	50	95,00
10/ 20/ 96	S	50	102,00
10/ 30/106	S	50	106,00
10/ 50/126	S	50	114,00
10/100/176	S	50	153,00
12/ 05/ 86 K	S	20	143,00
12/ 10/106	S	20	144,00
12/ 20/116	S	20	155,00
12/ 30/126	S	20	167,00
12/ 50/146	S	20	187,00
12/100/196	S	20	265,00
12/120/216	S	20	285,00
12/140/236	S	20	300,00
12/160/256	S	20	325,00
12/180/276	S	10	315,00
12/200/296	S	10	360,00
12/250/346	S	10	530,00
16/ 15/120 K	S	20	255,00
16/ 25/145	S	20	280,00
16/ 50/170	S	20	390,00
16/100/220	S	10	475,00
16/140/260	S	10	590,00
16/160/280	S	10	640,00
16/200/321	S	10	750,00
16/250/371	S	10	1020,00
16/300/421	S	10	1010,00
20/ 30/184	S	10	650,00
20/ 60/214	S	10	850,00

Abmessungen	VE	Stück	€/100/Obf.
Artikel	88764.014		
88764	Stahl galvanisch verzinkt	IMC-GS	USA

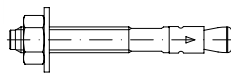

UPAT Expressanker IMC mit Spreizclip, Mutter und großer Scheibe

Produktinformation → TI-198

ETA CE	F120 Feuerwiderstandsklasse	REACH SVHC free
---------------	---------------------------------------	------------------------

Dübel- / Bohr Ø / Klemmlänge / Dübellänge

12/ 80/ 176 GS	S	20	275,00
12/100/196 GS	S	20	290,00
12/120/216 GS	S	20	310,00
12/140/236 GS	S	10	330,00
12/160/256 GS	S	10	350,00
12/180/276 GS	S	10	405,00
12/200/296 GS	S	10	425,00
12/250/346 GS	S	10	550,00
16/100/220 GS	S	10	520,00
16/140/260 GS	S	10	650,00
16/160/280 GS	S	10	690,00
16/200/320 GS	S	10	810,00
16/250/370 GS	S	10	1150,00
16/300/420 GS	S	10	1050,00

Artikel	88764.940		
88764	A 4	IMC	USA

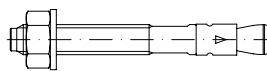

UPAT Expressanker IMC mit Spreizclip, Mutter und Scheibe

Produktinformation → TI-198

ETA CE	F120 Feuerwiderstandsklasse	REACH SVHC free
---------------	---------------------------------------	------------------------

Dübel- / Bohr Ø / Klemmlänge / Dübellänge

6/ 10/ 55	S	100	209,00
8/ 05/ 56	S	100	229,00
8/ 10/ 71	S	100	260,00
8/ 30/ 91	S	100	290,00
8/ 50/111	S	100	350,00
10/ 05/ 71 K	S	50	335,00
10/ 10/ 86	S	50	350,00
10/ 20/ 96	S	50	365,00
10/ 30/106	S	50	390,00
10/ 50/126	S	50	430,00
10/100/176	S	50	610,00
12/ 05/ 86 K	S	20	500,00
12/ 10/106	S	20	530,00
12/ 20/116	S	20	540,00
12/ 50/146	S	20	630,00
12/100/196	S	20	900,00
16/ 50/170	S	10	1250,00

Abmessungen	VE	Stück	€/100/Obf.
Artikel	88716.010		
88716	Stahl galvanisch verzinkt	USA	

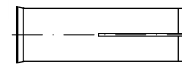

UPAT Einschlaganker USA mit Anschluss-Innengewinde M

Produktinformation → TI-199

ETA CE	R120 Feuerwiderstandsklasse	VdS approval	REACH SVHC free
---------------	---------------------------------------	---------------------	------------------------

Innengewinde M

USA M 6	S	100	22,20
USA M 8	S	100	28,50
USA M 8 x 40	S	100	60,00
USA M 10	S	50	43,00
USA M 12	S	50	60,00
USA M 16	S	20	121,00
USA M 20	S	20	214,00

Artikel	88716.940		
88716	A 4	USA	



UPAT Einschlaganker USA mit Anschluss-Innengewinde M

Produktinformation → TI-199

ETA CE	R120 Feuerwiderstandsklasse	VdS approval	REACH SVHC free
---------------	---------------------------------------	---------------------	------------------------

Innengewinde M

USA M 6	S	100	186,00
USA M 8	S	100	270,00
USA M 10	S	50	385,00
USA M 12	S	50	590,00

Artikel	88717.000		
88717	Stahl	USA-SWZ	

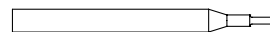

UPAT Setzwerkzeuge USA-SWZ

zur Verwendung für USA-Einschlaganker

REACH SVHC free

USA-SWZ M 6	S	1	980,00
USA-SWZ M 8	S	1	1020,00
USA-SWZ M 8 x 40	S	1	2250,00
USA-SWZ M 10	S	1	1220,00

Abmessungen	VE	Stück	€/100/Obf.
USA-SWZ M 12	S	1	1360,00
USA-SWZ M 16	S	1	2000,00
USA-SWZ M 20	S	1	2100,00

Artikel	88722.010		
88722	Stahl	UKA 3-ASTA	galvanisch verzinkt

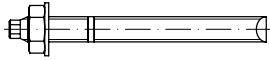

UPAT Gewindestangen UKA 3-ASTA mit Mutter und Scheibe

zur Verwendung mit UKA 3 PLUS-Patronen und Injektionsmörtel UPM 55, UPM 44, UPM 33

Produktinformation → [TI-199](#)



Ø M x Länge

ASTA M 8 x 110	S	10	112,00
ASTA M 8 x 150	S	10	205,00
ASTA M 8 x 190	S	10	240,00
ASTA M 10 x 130	S	10	156,00
ASTA M 10 x 165	S	10	193,00
ASTA M 10 x 190	S	10	215,00
ASTA M 12 x 160	S	10	220,00
ASTA M 12 x 180	S	10	240,00
ASTA M 12 x 220	S	10	280,00
ASTA M 12 x 250	S	10	315,00
ASTA M 12 x 300	S	10	385,00
ASTA M 14 x 170	S	10	360,00
ASTA M 16 x 190	S	10	445,00
ASTA M 16 x 165	S	10	345,00
ASTA M 16 x 250	S	10	485,00
ASTA M 16 x 300	S	10	530,00
ASTA M 20 x 260	S	10	860,00
ASTA M 20 x 220	S	10	760,00
ASTA M 20 x 300	S	10	1030,00
ASTA M 20 x 350	S	10	1220,00
ASTA M 22 x 280	S	5	840,00
ASTA M 24 x 300	S	5	1310,00
ASTA M 27 x 340	S	5	2130,00
ASTA M 30 x 380	S	5	2850,00

Artikel	88722.020		
88722	Stahl	UKA 3-ASTA	feuerverzinkt



UPAT Gewindestangen UKA 3-ASTA mit Mutter und Scheibe

zur Verwendung mit UKA 3 PLUS-Patronen und Injektionsmörtel UPM 55, UPM 44, UPM 33

Produktinformation → [TI-199](#)



Ø M x Länge

ASTA M 8 x 110	S	10	168,00
ASTA M 10 x 130	S	10	227,00
ASTA M 12 x 160	S	10	255,00

Abmessungen	VE	Stück	€/100/Obf.
ASTA M 16 x 190	S	10	495,00
ASTA M 20 x 260	S	5	1290,00

Artikel	88722.940		
88722	A 4	UKA 3-ASTA	



UPAT Gewindestangen UKA 3-ASTA mit Mutter und Scheibe

zur Verwendung mit UKA 3 PLUS-Patronen und Injektionsmörtel UPM 55, UPM 44, UPM 33

Produktinformation → [TI-199](#)



Ø M x Länge

ASTA M 8 x 110	S	10	335,00
ASTA M 8 x 170	S	10	610,00
ASTA M 8 x 190	S	10	580,00
ASTA M 10 x 130	S	10	570,00
ASTA M 10 x 150	S	10	550,00
ASTA M 10 x 165	S	10	730,00
ASTA M 10 x 190	S	10	840,00
ASTA M 10 x 250	S	10	1070,00
ASTA M 10 x 300	S	10	1170,00
ASTA M 12 x 160	S	10	740,00
ASTA M 12 x 180	S	10	710,00
ASTA M 12 x 190	S	10	820,00
ASTA M 12 x 220	S	10	1020,00
ASTA M 12 x 250	S	10	1330,00
ASTA M 12 x 300	S	10	1520,00
ASTA M 14 x 170	S	10	990,00
ASTA M 16 x 190	S	10	1390,00
ASTA M 16 x 165	S	10	1240,00
ASTA M 16 x 215	S	10	1360,00
ASTA M 16 x 250	S	10	1860,00
ASTA M 16 x 300	S	10	2230,00
ASTA M 20 x 260	S	10	3450,00
ASTA M 20 x 350	S	10	4900,00
ASTA M 22 x 280	S	5	3750,00
ASTA M 24 x 300	S	5	5800,00
ASTA M 27 x 340	S	5	6600,00
ASTA M 30 x 380	S	5	11600,00

Artikel	88714.010		
88714	Stahl	UKA 3-IST	galvanisch verzinkt

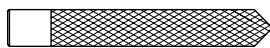

UPAT Innengewindehülsen UKA 3-IST

Produktinformation → [TI-200](#)



Innengewinde M

IST M 5 x 75	S	10	152,00
IST M 6 x 75	S	10	182,00
IST M 8 x 90	S	10	245,00
IST M 10 x 90	S	10	310,00

Abmessungen	VE	Stück	€/100/Obf.
IST M 12 x 100	S	10	375,00
IST M 16 x 120	S	10	580,00
IST M 16 x 120	S	5	1310,00

Artikel	88714.940		
88714	A 4	UKA 3-IST	

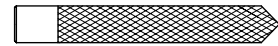

UPAT Innengewindehülsen UKA 3-IST

Produktinformation → [TI-200](#)



Innengewinde M

IST M 8	S	10	1030,00
IST M 10	S	10	1120,00
IST M 12	S	10	1070,00
IST M 16	S	5	4200,00

Artikel	88734.010		
88734	Stahl	UPM-A	galvanisch verzinkt



UPAT Gewindestangen UPM-A mit Mutter und Scheibe

zur Verwendung mit UKA 3 PLUS-Patronen und Injektionsmörtel UPM 55, UPM 44, UPM 33, UPM 11



Ø M x Länge

UPM-A M 6/ 75	S	20	86,00
UPM-A M 8/110	S	20	108,00
UPM-A M 8/130	S	20	145,00
UPM-A M 10/110	S	20	128,00
UPM-A M 10/130	S	20	144,00
UPM-A M 10/170	S	20	198,00
UPM-A M 12/120	S	20	182,00
UPM-A M 12/140	S	20	193,00
UPM-A M 16/130	S	10	350,00
UPM-A M 16/175	S	10	375,00
UPM-A M 16/200	S	10	415,00

Abmessungen	VE Stück	€/100/Obf.
Artikel 88734.940		
88734	A 4	UPM-A



UPAT Gewindestangen UPM-A mit Mutter und Scheibe

zur Verwendung mit UKA 3 PLUS-Patronen und Injektionsmörtel UPM 55, UPM 44, UPM 33, UPM 11



Ø M x Länge

UPM-A M 8/110	S	20	340,00
UPM-A M 8/130	S	10	415,00
UPM-A M 10/110	S	20	395,00
UPM-A M 10/170	S	20	730,00
UPM-A M 12/140	S	20	680,00
UPM-A M 16/130	S	10	1140,00
UPM-A M 16/175	S	10	1300,00

Artikel	88770.010
88770	Stahl galvanisch verzinkt UPM-I

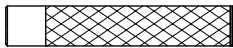

UPAT Innengewindeanker UPM-I

Produktinformation → TI-200



Innengewinde Ø

UPM-I 6	S	10	215,00
UPM-I 8	S	10	235,00
UPM-I 10	S	10	280,00
UPM-I 12	S	10	300,00

Artikel	88735.600
88735	Kunststoff UPM-SH-K



UPAT Siebhülse UPM-SH-K

Produktinformation → TI-201



Bohrungs Ø x Verankerungstiefe

UPM-SH 12/ 50	S	50	49,50
UPM-SH 12/ 85	S	50	60,00
UPM-SH 16/ 85	S	50	73,00
UPM-SH 16/ 130	S	20	136,00

Abmessungen	VE Stück	€/100/Obf.	
UPM-SH 20/ 85	S	20	86,00
UPM-SH 20/ 130	S	20	216,00
UPM-SH 20/ 200	S	20	247,00

Artikel	88720.002
88720	Mörtel UKA 3 PLUS

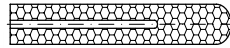

UPAT Mörtelpatronen UKA 3 PLUS

zur Verwendung mit Gewindestangen UKA 3-ASTA und Innengewindehülsen UKA 3-IST

Produktinformation → TI-201



für ASTA Anker

UKA 3 PLUS M 8	S	10	227,00
UKA 3 PLUS M 10	S	10	240,00
UKA 3 PLUS M 12	S	10	265,00
UKA 3 PLUS M 14	S	10	330,00
UKA 3 PLUS M 16	S	10	390,00
UKA 3 PLUS M 20/22	S	10	530,00
UKA 3 PLUS M 24	S	5	660,00

Artikel	88772.000
88772	Mörtel UPM 55

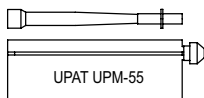

UPAT Injektionsmörtel UPM 55

inkl. 2 Statikmischer/Kartusche
Verkauf nur als ganze Verpackungseinheit



Inhalt je Kartusche (ml)

UPM 55-390	S	6	4550,00
------------	---	---	---------

Artikel	88733.000
88733	Mörtel UPM 44-360

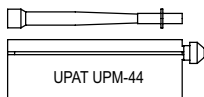

UPAT Injektionsmörtel UPM 44

inkl. 2 Statikmischer/Kartusche
Verkauf nur als ganze Verpackungseinheit



Inhalt je Kartusche (ml)

UPM 44 - 360	S	6	4850,00
--------------	---	---	---------

Abmessungen	VE Stück	€/100/Obf.
Artikel 88733.004		
88733	Mörtel UPM 44 CX 150	

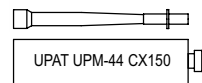

UPAT Injektionsmörtel UPM 44 CX 150

inkl. 2 Statikmischer und 1 Auspresstößel / Kartusche
Verkauf nur als ganze Verpackungseinheit



Inhalt je Kartusche (ml)

UPM 44 CX150	S	1	2140,00
--------------	---	---	---------

Artikel	88733.006
88733	Mörtel UPM 44 Profi-Box

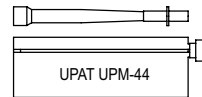

UPAT Injektionsmörtel UPM 44 in einer Profi-Box

im 5er Pack / Box, kpl. mit 10 Statikmischern, 1 Ausbläser, 1 Bürstensenk Ø14/20, 1 Ausdrückpistole



Inhalt je Kartusche (ml)

UPM 44 Profi-Box	S	1	37400,00
------------------	---	---	----------

Artikel	88733.007
88733	Mörtel UPM 44 HWK

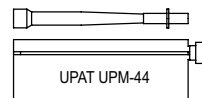

UPAT Injektionsmörtel UPM 44 im Handwerkskasten

20 Stück und 40 Statikmischer pro Kasten



Inhalt je Kartusche (ml)

UPM 44 im Hwk	S	1	85400,00
---------------	---	---	----------

Abmessungen	VE Stück	€/100/Obf.
Artikel 88774.000		
88774 Mörtel		UPM 33

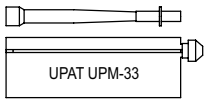

UPAT Injektionsmörtel UPM 33

inkl. 2 Statikmischer/Kartusche
Verkauf nur als ganze Verpackungseinheit



Inhalt je Kartusche (ml)

UPM 33-300	S	12	2250,00
UPM 33-360	S	6	2600,00

Abmessungen	VE Stück	€/100/Obf.
Artikel 88774.004		
88774 Mörtel		UPM 33 HWK

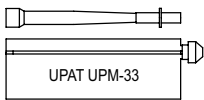

UPAT Injektionsmörtel UPM 33 im Handwerkskasten

20 Stück und 40 Statikmischer pro Kasten



Inhalt je Kartusche (ml)

UPM 33-360	S	1	51500,00
------------	---	---	----------

Abmessungen	VE Stück	€/100/Obf.
Artikel 88775.000		
88775 Mörtel		UPM 11

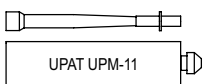

UPAT Injektionsmörtel UPM 11

inkl. 2 Statikmischer/Kartusche
Verkauf nur als ganze Verpackungseinheit

Inhalt je Kartusche (ml)

UPM 11-300	S	12	1540,00
UPM 11-360	S	6	1890,00

Abmessungen	VE Stück	€/100/Obf.
Artikel 88738.600		
88738 Kunststoff		

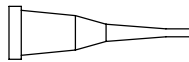

UPAT Statikmischer

Verpackungseinheit = 10 Stück



UPM 44 - SM	S	10	192,00
-------------	---	----	--------

Abmessungen	VE Stück	€/100/Obf.
Artikel 88769.000		
88769 Stahl		BS



UPAT Reinigungsbürsten BS für Beton



Durchmesser

BS 8 - F. M 6	S	1	1510,00
BS 10 - F. M 8	S	1	1560,00
BS 12 - F. M10	S	1	1040,00
BS 14 - F. M12	S	1	1180,00
BS 18 - F. M16	S	1	1400,00
BS 24 - F. M20	S	1	1800,00
BS 28 - F. M24	S	1	2080,00
BS 35 - F. M30	S	1	2800,00

Abmessungen	VE Stück	€/100/Obf.
Artikel 88769.001		
88769 Stahl		



UPAT Reinigungsbürstenset für Mauerwerk



Durchmesser

14/20	S	1	1520,00
20/30	S	1	1870,00

Abmessungen	VE Stück	€/100/Obf.
Artikel 88718.600		
88718 Kunststoff		

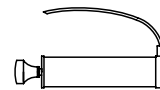

UPAT Ausbläser zur Bohrlochsäuberung



AUSBLÄSER	S	1	1640,00
-----------	---	---	---------

Abmessungen	VE Stück	€/100/Obf.
Artikel 88771.000		
88771 Stahl		Metall

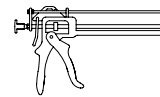

UPAT Ausdrückpistolen Metall



.	S	1	6700,00
---	---	---	---------

Abmessungen	VE Stück	€/100/Obf.
Artikel 88771.600		
88771 Kunststoff		

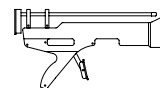

UPAT Ausdrückpistolen



.	S	1	15400,00
---	---	---	----------

Abmessungen	VE	Stück	€/100/Obf.
Artikel	88760.000		
88760	Stahl		MW-SDS

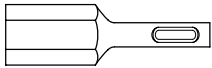

UPAT Setzwerkzeuge MW-SDS für UKA 3- und UMW-Anker mit Sechskant, Schaft mit SDS-Aufnahme



Für UKA 3- / UMW-Nenn Ø

MW-SDS M 8-M16	S	1	3000,00
----------------	---	---	---------

Artikel	88765.000		
88765	Stahl		SDS plus

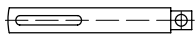

UPAT Adapter mit SDS plus-Aufnahme

zur Verwendung mit Schraubnüssen 1/2", für Montage von Ankerstangen mit 6kt.



SDS-PLUS 1/2VK	S	1	2250,00
----------------	---	---	---------

Artikel	88766.000		
88766	Stahl		SDS max

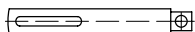

UPAT Adapter mit SDS max-Aufnahme

für Montage von Ankerstangen mit 6kt.



SDS-MAX 3/4VK	S	1	4050,00
---------------	---	---	---------

Abmessungen	VE	Stück	€/100/Obf.
Artikel	88776.000		
88776	Stahl		SK SW

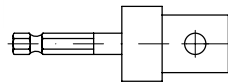

UPAT Adapter SK SW



SW 8 1/2	S	1	2000,00
----------	---	---	---------

Artikel	88381.600		
88381	Kunststoff		4 AS-K

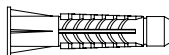

TOX-Dübel 4 AS-K mit abtrenbarer Kappe

Bohrloch Ø x Dübellänge / für Schrauben Ø max.

6	x 28 / 5,0	S	100	7,90
8	x 49 / 7,0	S	100	11,50

Artikel	88382.600		
88382	Kunststoff		TRI

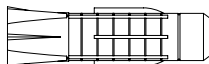

TOX-Allzweck-Dübel TRI

Bohrloch Ø x Dübellänge / für Schrauben Ø max.

5	x 31 / 4,0	S	100	4,30
6	x 36 / 5,0	S	100	6,70
6	x 51 / 5,0	S	100	7,20
7	x 36 / 6,0	S	100	7,60
7	x 51 / 6,0	S	100	8,20
8	x 51 / 7,0	S	100	9,70
10	x 61 / 8,0	S	50	17,70
12	x 71 / 10,0	S	25	26,50
14	x 75 / 12,0	S	20	47,00

Abmessungen	VE	Stück	€/100/Obf.
Artikel	88383.600		
88383	Kunststoff		TRIKA

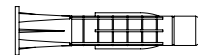

TOX-Allzweck-Dübel TRIKA mit abtrenbarer Kappe

Bohrloch Ø x Dübellänge / für Schrauben Ø max.

5	x 32 / 4,0	S	100	4,70
6	x 37 / 5,0	S	100	7,30
7	x 37 / 6,0	S	100	8,10
7	x 52 / 6,0	S	100	8,70
8	x 52 / 7,0	S	100	10,70
10	x 62 / 8,0	S	50	19,60
12	x 72 / 10,0	S	25	28,50
14	x 76 / 12,0	S	20	50,00

Artikel	88910.700		
88910	Messing		



Messing-Spreizdübel mit Innengewinde, Außenfläche gerändelt

REACH → TI-262



Innengewinde M / Bohr Ø x ca. Länge

M 4 / 5	x 16	S	100	12,90
M 5 / 6,5	x 21	S	100	15,40
M 6 / 8	x 23	S	100	18,80
M 8 / 10	x 28	S	100	31,00
M 10 / 12	x 34	S	100	46,00
M 12 / 15	x 38	S	50	86,00
M 14 / 18	x 43	S	25	166,00
M 16 / 20	x 46	S	25	188,00

Abmessungen	VE Stück	€/100/Obf.
Artikel	88902.012	
88902	Stahl gehärtet	SS
	galvanisch verzinkt	

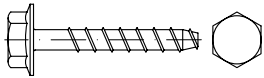

MULTI-MONTI
Schraubanker MMSplus-SS,
SS = Sechskantkopf
mit angepresster Scheibe

Produktinformation → **TI-202**

ETA-15/0754



Anker Ø x Länge

6	x	40	S	100	33,50
6	x	50	S	100	35,50
6	x	60	S	100	38,00
6	x	80	S	50	63,00
7,5	x	35	S	100	37,50
7,5	x	40	S	100	39,50
7,5	x	50	S	50	44,50
7,5	x	60	S	50	46,50
7,5	x	80	S	50	77,00
7,5	x	100	S	50	83,00
7,5	x	120	S	50	89,00
7,5	x	140	S	50	111,00
10	x	60	S	25	99,00
10	x	70	S	25	110,00
10	x	80	S	25	116,00
10	x	100	S	25	120,00
10	x	120	S	25	130,00
10	x	140	S	25	141,00
10	x	160	S	25	155,00
12	x	80	S	25	135,00
12	x	90	S	25	145,00
12	x	100	S	25	150,00
12	x	120	S	25	163,00
12	x	140	S	25	178,00
12	x	160	S	25	195,00
16	x	120	S	10	680,00
16	x	130	S	10	750,00

Abmessungen	VE Stück	€/100/Obf.
Artikel	88903.012	
88903	Stahl gehärtet	St
	galvanisch verzinkt	

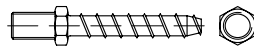

MULTI-MONTI
Schraubanker MMSplus-St,
St = Stockanker mit
Anschlussgewinde

Produktinformation → **TI-203**

ETA-15/0754



Anker Ø x Länge

6	x	55	S	100	30,50
6	x	65	S	50	32,50
7,5	x	60	S	50	38,50
7,5	x	70	S	100	41,50
7,5	x	80	S	100	44,00
7,5	x	100	S	50	67,00
7,5	x	120	S	50	72,00
10	x	75	S	25	81,00
10	x	85	S	25	86,00

Artikel	88905.012
88905	Stahl gehärtet
	galvanisch verzinkt
	F

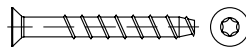

MULTI-MONTI
Schraubanker MMSplus-F
mit Innensechsrund,
F = Flach-/Senkkopf

Produktinformation → **TI-204**

ETA-15/0754



Anker Ø x Länge

6	x	40	S	200	16,40
6	x	50	S	200	17,30
6	x	60	S	200	28,00
6	x	70	S	100	36,50
6	x	80	S	50	44,50
6	x	100	S	100	49,00
6	x	120	S	50	68,00
6	x	140	S	50	85,00
7,5	x	45	S	200	26,00
7,5	x	50	S	200	27,00
7,5	x	60	S	50	34,00
7,5	x	70	S	50	43,50
7,5	x	80	S	50	53,00
7,5	x	100	S	100	59,00
7,5	x	120	S	50	74,00
7,5	x	140	S	50	92,00
7,5	x	160	S	50	99,00
10	x	60	S	25	80,00
10	x	70	S	25	92,00

Abmessungen	VE Stück	€/100/Obf.
10	x	80
12	x	90
12	x	100
12	x	120
S	25	97,00
S	25	124,00
S	25	130,00
S	25	145,00

Artikel	88908.012
88908	Stahl gehärtet
	galvanisch verzinkt
	P

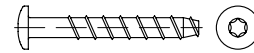

MULTI-MONTI
Schraubanker MMSplus-P
mit Innensechsrund,
P = Pan head

Produktinformation → **TI-203**

ETA-15/0754



Anker Ø x Länge

6	x	35	S	100	16,90
6	x	40	S	100	18,20
6	x	50	S	100	19,10
6	x	60	S	100	33,50
7,5	x	35	S	100	32,50
7,5	x	40	S	100	36,00
7,5	x	50	S	100	37,50
7,5	x	60	S	50	43,00
10	x	60	S	25	76,00
10	x	70	S	25	79,00

Artikel	88060.000
88060	GTW**

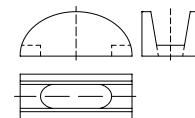

Kurvenstücke für Zuganker*,
für Schrägzug-Verspannungen

**schweißbar

Maße → **TI-136**

*Einsatz nur mit Passscheiben → Artikel 88061

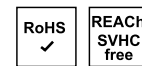

Für Schrauben M / Zuganker Ø

M 12/M 16	S	1	880,00
M 20	S	1	910,00
M 24/M 27/M 30	S	1	1110,00

- ✓ Große Artikelvielfalt
- ✓ Verlässliche Qualität
- ✓ Hohe Lieferbereitschaft

Abmessungen VE Stück €/100/Obf.

Artikel	88061.020		
88061	GTW	feuerverzinkt	

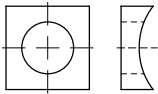

**Passscheiben für Kurvenstücke*,
Schraubenkopf-/Mutter-Auflage
für Schrägzug-Verspannungen**

Maße → TI-136

*Einsatz nur mit Kurvenstücken → Artikel 88060

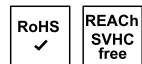

Für Schrauben M/Zuganker Ø

M 12	S	1	335,00 tZn
M 16	S	1	335,00 tZn
M 20	S	1	430,00 tZn
M 24	S	1	1090,00 tZn
M 27	S	1	1090,00 tZn
M 30	S	1	1090,00 tZn

Artikel	88663.000		
88663	Stahl gehärtet	T	

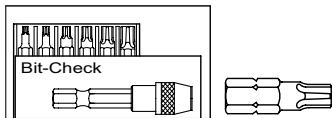

SPAX BITcheck Sortiment

Inhalt: 1 Rapidaptor BIT Halter 50 mm
Je 1 Bit T10; T15; T20; T30; T40

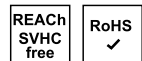

+6 T-Star plus	S	1	95500,00
----------------	---	---	----------

Abmessungen VE Stück €/100/Obf.

Artikel	88654.000		
88654	Stahl gehärtet	T/25	

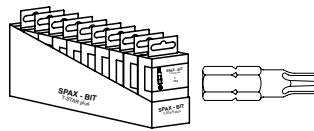

SPAX CUT-CASE, Sechsrund Bits T-STAR plus

Bitlänge = 25 mm

VE-Menge = Anzahl Bits in einem CUT-CASE,
1 CUT-CASE = 10 Dosen



SW 1/4 x 25 T 10	K	50	166,00
SW 1/4 x 25 T 15	K	50	166,00
SW 1/4 x 25 T 20	K	50	166,00
SW 1/4 x 25 T 25	K	50	166,00
SW 1/4 x 25 T 30	K	50	166,00
SW 1/4 x 25 T 40	K	50	166,00

Artikel	88654.002		
88654	Stahl gehärtet	T/50	

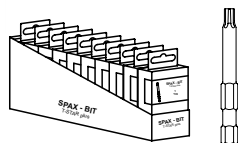

SPAX CUT-CASE, Sechsrund Bits T-STAR plus

Bitlänge 50 mm

VE-Menge = Anzahl Bits in einem CUT-CASE,
1 CUT-CASE = 10 Dosen



SW 1/4 x 50 T 15	S	50	255,00
SW 1/4 x 50 T 20	S	50	255,00
SW 1/4 x 50 T 25	S	50	255,00
SW 1/4 x 50 T 30	S	50	255,00

Abmessungen VE Stück €/100/Obf.

Artikel	89017.000		
89017	Stahl		



SPAX Einschraubhülsen für SPAX Gewindestangen ohne Kopf

(Artikel 89016)
Schlüsselweite SW11

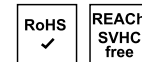

S	1	30600,00
---	---	----------

Artikel	88665.000		
88665	Stahl gehärtet	Zweiloch	



Spezial-Bits für diebstahlhemmende Schrauben mit "Snake Eye" Antrieb (Artikel 88111, 88112)

Antrieb: 1/4" Sechskant C



für Gewinde Ø

M 3	S	1	3350,00
M 4	S	1	3350,00
M 5	S	1	3350,00
M 6	S	1	3350,00

Artikel	88666.000		
88666	Stahl gehärtet	Pin-Insechs	

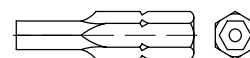

Spezial-Bits für diebstahlhemmende Schrauben für Innensechskant mit Zapfen (Artikel 88113)

Antrieb: 1/4" Sechskant C



Schlüsselweite / für Gewinde Ø

SW2 / M 3+M3,5	S	1	2010,00
SW2,5 / M 4	S	1	2010,00
SW3 / M 5	S	1	2010,00
SW4 / M 6	S	1	2010,00
SW5 / M 8	S	1	2010,00
SW6 / M10	S	1	2850,00

Abmessungen	VE Stück	€/100/Obf.
Artikel 88667.000		
88667 Stahl gehärtet	PIN-ISR	

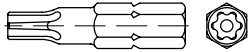

Spezial-Bits für diebstahlhemmende Schrauben für Innensechsrund mit Zapfen (Artikel 88114 bis 88117)

Antrieb: 1/4" Sechskant C



T 10	S	1	1740,00
T 15	S	1	1740,00
T 20	S	1	1740,00
T 25	S	1	1740,00
T 27	S	1	2130,00
T 30	S	1	3250,00
T 40	S	1	3250,00
T 45	S	1	3250,00

Artikel	88401.000
88401 Niet Stahl, verz. A	Dorn Stahl, verz.

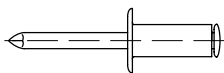

Offene Blindniete mit Sollbruchdorn, ~DIN 7337/ISO 15979, A = Flachkopf

Produktinformation → TI-206

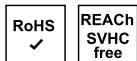

Niet Ø x Nietlänge	VE Stück	€/100/Obf.
3 x 5	S 500	4,95
3 x 6	S 500	5,30
3 x 8	S 500	6,10
3 x 10	S 500	7,50
3 x 12	S 500	8,70
3 x 16	S 500	12,70
3 x 18	S 500	14,70
3 x 20	S 500	18,40
3,2 x 6	S 500	5,40
3,2 x 8	S 500	6,20
3,2 x 10	S 500	7,80
3,2 x 12	S 500	8,90
3,2 x 16	S 500	13,00
3,2 x 18	S 500	15,00
3,2 x 20	S 500	16,00
4 x 6	S 500	6,50
4 x 8	S 500	7,20
4 x 10	S 500	8,70
4 x 12	S 500	9,90
4 x 16	S 500	12,80
4 x 18	S 500	15,40
4 x 20	S 500	16,20
4 x 25	S 500	20,50
4,8 x 8	S 500	9,00
4,8 x 10	S 500	10,70
4,8 x 12	S 500	11,70

Abmessungen	VE Stück	€/100/Obf.
4,8 x 16	S 500	14,20
4,8 x 20	S 250	16,80
4,8 x 25	S 250	20,70
5 x 8	S 500	9,40
5 x 10	S 500	10,90
5 x 12	S 500	12,30
5 x 14	S 500	13,20
5 x 16	S 500	14,70
5 x 18	S 500	16,00
5 x 20	S 250	17,40
5 x 25	S 250	21,00
5 x 30	S 100	25,50
5 x 35	S 100	31,00
5 x 40	S 100	39,50
5 x 45	S 100	47,50
5 x 50	S 100	54,00
6 x 10	S 250	16,00
6 x 12	S 250	16,70
6 x 14	S 250	17,40
6 x 16	S 250	18,80
6 x 20	S 250	21,50
6 x 25	S 250	25,50
6,4 x 12	S 250	17,20
6,4 x 16	S 250	19,30
6,4 x 18	S 250	20,20
6,4 x 20	S 250	21,90
6,4 x 25	S 250	26,00

Artikel	88402.000
88402 Niet Al-Leg. A	Dorn Stahl, verz.

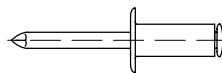

Offene Blindniete mit Sollbruchdorn, ~DIN 7337/ISO 15977, A = Flachkopf

Produktinformation → TI-206 REACH → TI-262



Niet Ø x Nietlänge	VE Stück	€/100/Obf.
2,4 x 4	S 1000	3,75
2,4 x 6	S 1000	4,15
2,4 x 8	S 1000	4,60
3 x 4	S 500	3,75
3 x 5	S 500	3,85
3 x 6	S 500	3,85
3 x 7	S 500	3,90
3 x 8	S 500	4,25
3 x 10	S 500	4,60
3 x 12	S 500	5,00
3 x 14	S 500	5,90
3 x 16	S 500	6,80
3 x 18	S 250	7,80
3 x 20	S 250	8,70
3 x 25	S 250	10,50
3 x 30	S 250	12,40
3,2 x 4	S 500	3,85
3,2 x 6	S 500	3,90
3,2 x 8	S 500	4,40
3,2 x 10	S 500	4,65
3,2 x 12	S 500	5,50
3,2 x 14	S 500	6,20
3,2 x 16	S 500	7,30
3,2 x 18	S 500	8,00
3,2 x 20	S 500	9,00
3,2 x 25	S 500	11,00
4 x 5	S 500	4,40

Abmessungen	VE Stück	€/100/Obf.
4 x 6	S 500	4,40
4 x 7	S 500	4,50
4 x 8	S 500	4,65
4 x 10	S 500	5,40
4 x 12	S 500	5,90
4 x 14	S 500	6,80
4 x 16	S 500	7,50
4 x 18	S 500	8,20
4 x 20	S 500	8,90
4 x 25	S 500	10,80
4 x 30	S 250	13,80
4 x 35	S 250	18,00
4 x 40	S 250	22,40
4,8 x 6	S 500	6,30
4,8 x 8	S 500	6,40
4,8 x 10	S 500	6,80
4,8 x 12	S 500	7,70
4,8 x 14	S 500	8,40
4,8 x 16	S 500	9,40
4,8 x 18	S 500	11,30
4,8 x 20	S 250	12,70
4,8 x 25	S 250	14,00
4,8 x 30	S 100	16,00
5 x 6	S 500	6,40
5 x 8	S 500	6,80
5 x 10	S 500	7,30
5 x 12	S 500	7,80
5 x 14	S 500	8,70
5 x 16	S 500	9,50
5 x 18	S 500	11,50
5 x 20	S 250	12,90
5 x 25	S 250	14,50
5 x 30	S 100	16,50
5 x 35	S 100	19,40
5 x 40	S 100	22,20
5 x 45	S 100	26,50
5 x 50	S 100	29,00
5 x 60	S 100	42,50
5 x 70	S 100	47,00
6 x 8	S 250	9,90
6 x 10	S 250	10,70
6 x 12	S 250	11,20
6 x 16	S 250	12,80
6 x 18	S 250	13,40
6 x 20	S 250	14,30
6 x 25	S 200	17,70
6 x 30	S 200	21,00
6 x 35	S 100	24,50
6 x 40	S 100	29,50
6,4 x 12	S 250	13,00
6,4 x 16	S 250	14,80
6,4 x 18	S 250	15,80
6,4 x 20	S 250	17,70
6,4 x 25	S 250	20,00
6,4 x 30	S 100	21,90



Wir versorgen Sie mit Verbindungselementen und Befestigungstechnik!

Abmessungen	VE	Stück	€/100/Obf.
Artikel	88403.000		
88403	Niet Al-Leg.		A
	Dorn A 2		

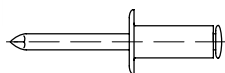

Offene Blindniete mit Sollbruchdorn,
~DIN 7337,
A = Flachkopf

Produktinformation → [TI-206](#) REACH → [TI-262](#)



Niet Ø x Nietlänge

3	x	4	S	500	6,40
3	x	6	S	500	6,70
3	x	8	S	500	7,20
3	x	10	S	500	7,40
3	x	12	S	500	7,90
3	x	16	S	500	9,20
4	x	6	S	500	7,90
4	x	8	S	500	8,30
4	x	10	S	500	8,90
4	x	12	S	500	9,70
4	x	14	S	500	10,50
4	x	16	S	500	11,20
4	x	18	S	500	12,20
4	x	20	S	500	13,00
4	x	25	S	500	16,20
5	x	6	S	500	12,40
5	x	8	S	500	12,80
5	x	10	S	500	13,20
5	x	12	S	500	14,30
5	x	14	S	500	14,70
5	x	16	S	500	15,20
5	x	18	S	500	17,40
5	x	20	S	250	20,20
5	x	25	S	250	23,30
5	x	30	S	100	25,50
5	x	35	S	100	29,00
5	x	40	S	100	31,00

Artikel	88410.000		
88410	Niet Al-Leg.		A
	Dorn Al-Leg.		

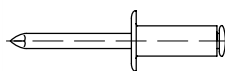

Offene Blindniete mit Sollbruchdorn,
~DIN 7337/ISO 15981,
A = Flachkopf

Produktinformation → [TI-206](#) REACH → [TI-262](#)



Niet Ø x Nietlänge

3,2	x	6,1	S	500	5,40
3,2	x	7,6	S	500	6,00
3,2	x	9,2	S	500	14,80
3,2	x	12,3	S	500	9,20
3,2	x	15,5	S	500	10,00
4	x	6,6	S	500	10,20
4	x	9,8	S	500	10,50

Abmessungen	VE	Stück	€/100/Obf.		
4	x	12,9	S	500	15,20
4	x	16,1	S	500	14,70
4,8	x	7,2	S	500	16,50
4,8	x	10,3	S	500	12,90
4,8	x	13,5	S	500	24,90
4,8	x	16,7	S	500	17,20

Artikel	88404.000		
88404	Niet A 2		A
	Dorn A 2		

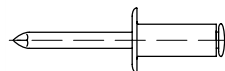

Offene Blindniete mit Sollbruchdorn,
~DIN 7337/ISO 15983,
A = Flachkopf

Produktinformation → [TI-206](#)



Niet Ø x Nietlänge

3	x	6	S	500	13,30
3	x	8	S	500	14,70
3	x	10	S	500	16,80
3	x	12	S	500	21,40
3	x	14	S	500	22,90
3	x	16	S	500	24,40
3,2	x	6	S	500	13,50
3,2	x	8	S	500	14,90
3,2	x	10	S	500	17,30
3,2	x	12	S	500	21,70
3,2	x	14	S	500	23,30
3,2	x	16	S	500	24,80
4	x	6	S	500	17,70
4	x	8	S	500	19,70
4	x	10	S	500	21,40
4	x	12	S	500	23,90
4	x	14	S	500	27,00
4	x	16	S	500	30,00
4	x	20	S	500	38,50
4	x	25	S	500	47,00
4,8	x	8	S	500	29,50
4,8	x	10	S	500	31,50
4,8	x	12	S	500	35,00
4,8	x	14	S	500	37,00
4,8	x	16	S	500	39,50
4,8	x	20	S	250	46,00
5	x	8	S	500	30,50
5	x	10	S	500	32,50
5	x	12	S	500	36,00
5	x	14	S	500	37,50
5	x	16	S	500	39,50
5	x	20	S	250	46,50
5	x	25	S	250	54,00
5	x	30	S	100	62,00
5	x	35	S	100	68,00
5	x	40	S	100	77,00

Abmessungen	VE	Stück	€/100/Obf.
Artikel	88415.000		
88415	Niet A 4		A
	Dorn A 4		

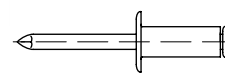

Offene Blindniete mit Sollbruchdorn,
~DIN 7337,
A = Flachkopf

Produktinformation → [TI-206](#)

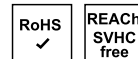

Niet Ø x Nietlänge

3	x	6	S	500	15,80
3	x	8	S	500	17,50
3	x	10	S	500	20,20
3	x	12	S	500	26,00
4	x	6	S	500	21,70
4	x	8	S	500	23,40
4	x	10	S	500	26,00
4	x	12	S	500	28,50
4	x	16	S	500	36,50
5	x	8	S	500	36,00
5	x	10	S	500	37,50
5	x	12	S	500	41,00
5	x	16	S	500	46,00
5	x	20	S	250	54,00

Artikel	88493.000		
88493	Niet Monel*		A
	Dorn A 4		

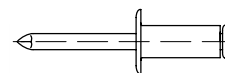

Offene Blindniete mit Sollbruchdorn,
ISO 16584,
A = Flachkopf

*Nickel-Kupfer-Legierung

Produktinformation → [TI-206](#)

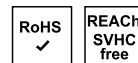

Niet Ø x Nietlänge

3,2	x	6	S	500	25,00
3,2	x	8	S	500	26,50
3,2	x	10	S	500	27,00
4	x	6	S	500	32,50
4	x	8	S	500	34,00
4	x	10	S	500	37,00
4	x	12	S	500	39,00
4,8	x	8	S	500	53,00
4,8	x	10	S	500	56,00
4,8	x	12	S	500	59,00
4,8	x	16	S	500	67,00
4,8	x	20	S	500	76,00
6,4	x	12	S	250	93,00
6,4	x	16	S	250	112,00
6,4	x	18	S	250	118,00

Abmessungen	VE Stück	€/100/Obf.
Artikel 88405.000		
88405 Niet A 2 Dorn Stahl, verz.		A

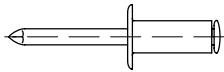

**Offene Blindniete mit Sollbruchdorn,
~DIN 7337,
A = Flachkopf**

Produktinformation → **TI-206**



Niet Ø x Nietlänge

3	x	6	S	500	11,20
3	x	8	S	500	12,50
3	x	10	S	500	13,80
3,2	x	6	S	500	11,50
3,2	x	8	S	500	12,90
4	x	6	S	500	13,40
4	x	8	S	500	15,20
4	x	10	S	500	16,70
4	x	12	S	500	18,20
4	x	16	S	500	22,40
5	x	8	S	500	22,40
5	x	10	S	500	24,40
5	x	12	S	500	26,50

Artikel	88406.000
88406 Niet Kupfer Dorn Stahl, verz.	A

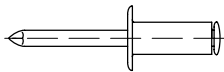

**Offene Blindniete mit Sollbruchdorn,
~DIN 7337/ISO 16582,
A = Flachkopf**

Produktinformation → **TI-206**



Niet Ø x Nietlänge

3	x	4	S	500	5,00
3	x	6	S	500	5,10
3	x	8	S	500	6,10
3	x	10	S	500	6,50
3	x	12	S	500	6,70
4	x	6	S	500	8,20
4	x	8	S	500	9,00
4	x	10	S	500	9,80
4	x	12	S	500	10,70

Abmessungen	VE Stück	€/100/Obf.
Artikel 88407.000		
88407 Niet Kupfer Dorn Bronze		A

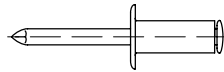

**Offene Blindniete mit Sollbruchdorn,
~DIN 7337/ISO 16582,
A = Flachkopf**

Produktinformation → **TI-206** REACH → **TI-262**



Niet Ø x Nietlänge

3	x	4	S	500	9,70
3	x	6	S	500	9,90
3	x	8	S	500	10,90
3	x	10	S	500	11,30
3	x	12	S	500	18,70
4	x	6	S	500	14,90
4	x	8	S	500	15,80
4	x	10	S	500	16,70
4	x	12	S	500	17,50

Artikel	88408.000
88408 Niet Kunststoff* Dorn Kunststoff*	A

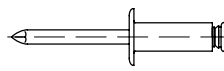

**Offene Blindniete mit Sollbruchdorn,
A = Flachkopf**

*Kunststoff PA 6.6

Produktinformation → **TI-207**

Niet Ø x Nietlänge

4	x	8	S	500	16,30
4	x	12	S	500	16,30
5	x	8	S	500	20,70
5	x	12	S	500	20,70
6	x	12	S	250	24,80

Abmessungen	VE Stück	€/100/Obf.
Artikel 88417.004		
88417 Niet Al-Leg. Dorn Stahl, verz.		A-Lw

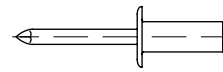

**Offene Blindniete mit Sollbruchdorn,
~DIN 7337/ISO 15977,
A = Flachkopf
Lw = weiß lackiert**

Produktinformation → **TI-206** REACH → **TI-262**



Niet Ø x Nietlänge

3	x	8	S	500	6,70
4	x	8	S	500	8,00
4	x	10	S	500	8,30
4	x	12	S	500	9,30
5	x	12	S	500	11,40

Artikel	88417.006
88417 Niet Al-Leg. Dorn Stahl, verz.	A-Ls

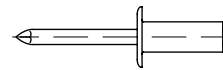

**Offene Blindniete mit Sollbruchdorn,
~DIN 7337/ISO 15977,
A = Flachkopf
Ls = schwarz lackiert**

Produktinformation → **TI-206** REACH → **TI-262**



Niet Ø x Nietlänge

3	x	6	S	500	6,20
3	x	8	S	500	6,70
4	x	6	S	500	7,70
4	x	8	S	500	8,00
4	x	10	S	500	8,30
4	x	12	S	500	9,30
5	x	10	S	500	10,80
5	x	12	S	500	11,40

Abmessungen	VE Stück	€/100/Obf.
Artikel 88411.000		
88411 Niet Stahl, verz.		B
Dorn Stahl, verz.		

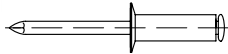

Offene Blindniete mit Sollbruchdorn,
~DIN 7337/ISO 15980,
B = Senkkopf 120°

Produktinformation → TI-208

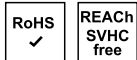

Niet Ø x Nietlänge

3	x	6	S	500	5,30
3	x	8	S	500	6,20
3	x	10	S	500	7,70
3	x	12	S	500	8,90
4	x	6	S	500	6,70
4	x	8	S	500	7,30
4	x	10	S	500	8,90
4	x	12	S	500	10,00
4	x	16	S	500	12,90
5	x	8	S	500	9,50
5	x	10	S	500	11,20
5	x	12	S	500	12,40
5	x	14	S	500	13,40
5	x	16	S	500	14,90
5	x	20	S	250	17,70
5	x	25	S	250	21,50

Artikel	88412.000
88412 Niet Al-Leg.	B
Dorn Stahl, verz.	

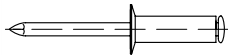

Offene Blindniete mit Sollbruchdorn,
~DIN 7337/ISO 15978,
B = Senkkopf 120°

Produktinformation → TI-208 REACH → TI-262



Niet Ø x Nietlänge

3	x	6	S	500	3,95
3	x	8	S	500	4,45
3	x	10	S	500	4,75
3	x	12	S	500	5,40
3	x	16	S	500	7,00
4	x	6	S	500	4,50
4	x	8	S	500	4,85
4	x	10	S	500	5,50
4	x	12	S	500	6,10
4	x	16	S	500	7,80
4	x	18	S	500	8,40
4	x	20	S	500	9,20
5	x	8	S	500	7,00
5	x	10	S	500	7,40
5	x	12	S	500	7,90
5	x	16	S	500	9,80
5	x	18	S	500	11,50
5	x	20	S	250	13,00

Abmessungen	VE Stück	€/100/Obf.
5 x 25	S 250	14,70
5 x 30	S 100	16,70
5 x 35	S 100	19,50

Artikel	88411.920
88411 Niet A 2	B
Dorn A 2	

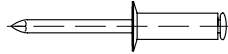

Offene Blindniete mit Sollbruchdorn,
~DIN 7337/ISO 15984,
B = Senkkopf 120°

Produktinformation → TI-208



Niet Ø x Nietlänge

B 4	x	8	S	500	44,00
B 4	x	10	S	500	47,50
B 4	x	12	S	500	54,00
B 5	x	8	S	500	54,00
B 5	x	10	S	500	57,00
B 5	x	12	S	500	63,00
B 5	x	16	S	500	68,00

Artikel	88409.004
88409 Niet Al-Leg.	C-K 9,5
Dorn Stahl, verz.	

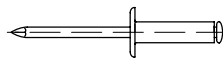

Offene Blindniete mit Sollbruchdorn,
~DIN 7337,
C = großer Flachkopf (Ø = 9,5)

Produktinformation → TI-207 REACH → TI-262



Niet Ø x Nietlänge

3,2	x	6	S	500	5,40
3,2	x	8	S	500	5,70
3,2	x	10	S	500	6,70
3,2	x	12	S	500	7,20
3,2	x	16	S	500	7,90

Abmessungen	VE Stück	€/100/Obf.
Artikel 88409.005		
88409 Niet Al-Leg.		C-K 11
Dorn Stahl, verz.		

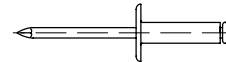

Offene Blindniete mit Sollbruchdorn,
~DIN 7337,
C = großer Flachkopf (Ø = 11)

Produktinformation → TI-207 REACH → TI-262



Niet Ø x Nietlänge

5	x	8	S	500	7,00
5	x	10	S	500	7,40
5	x	12	S	500	7,90
5	x	14	S	500	8,90
5	x	16	S	500	9,90
5	x	18	S	500	11,80
5	x	20	S	250	13,30
5	x	25	S	250	14,90
5	x	30	S	100	16,90

Artikel	88409.006
88409 Niet Al-Leg.	C-K 12
Dorn Stahl, verz.	

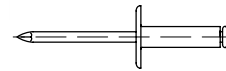

Offene Blindniete mit Sollbruchdorn,
~DIN 7337,
C = großer Flachkopf (Ø = 12)

Produktinformation → TI-207 REACH → TI-262



Niet Ø x Nietlänge

4	x	6	S	500	6,50
4	x	8	S	500	7,30
4	x	10	S	500	8,00
4	x	12	S	500	8,40
4	x	16	S	500	9,90
4	x	20	S	500	11,40

Abmessungen	VE	Stück	€/100/Obf.
Artikel	88409.007		
88409	Niet Al-Leg.		C-K 14
Dorn Stahl, verz.			

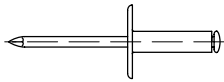

Offene Blindniete mit Sollbruchdorn, ~DIN 7337, C = großer Flachkopf (Ø = 14)

Produktinformation → [TI-207](#) REACH → [TI-262](#)



Niet Ø x Nietlänge

5	x	8	S	250	8,30
5	x	10	S	250	9,20
5	x	12	S	250	10,00
5	x	14	S	250	10,70
5	x	16	S	250	11,40
5	x	18	S	250	12,50
5	x	20	S	250	13,90
5	x	25	S	250	16,70
5	x	30	S	100	18,30

Artikel	88409.008		
88409	Niet Al-Leg.		C-K 16
Dorn Stahl, verz.			

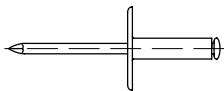

Offene Blindniete mit Sollbruchdorn, ~DIN 7337, C = großer Flachkopf (Ø = 16)

Produktinformation → [TI-207](#) REACH → [TI-262](#)



Niet Ø x Nietlänge

4,8	x	8	S	250	9,50
4,8	x	10	S	250	10,20
4,8	x	12	S	250	11,20
4,8	x	16	S	250	12,70
4,8	x	20	S	250	14,80
4,8	x	25	S	250	17,20

Abmessungen	VE	Stück	€/100/Obf.
Artikel	88413.005		
88413	Niet Stahl, verz.		C-K 16
Dorn Stahl, verz.			

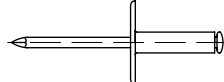

Offene Blindniete mit Sollbruchdorn, ~DIN 7337, C = großer Flachkopf (Ø = 16)

Produktinformation → [TI-207](#)



Niet Ø x Nietlänge

4,8	x	10,3	S	250	18,30
4,8	x	13,5	S	250	19,80
4,8	x	16,7	S	250	22,50
4,8	x	19,9	S	250	27,50

Artikel	88414.004		
88414	Niet Al-Leg.		C-K 9,5
Dorn Al-Leg.			

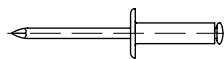

Offene Blindniete mit Sollbruchdorn, ~DIN 7337, C = großer Flachkopf (Ø = 9,5)

Produktinformation → [TI-207](#) REACH → [TI-262](#)



Niet Ø x Nietlänge

3,2	x	6,1	S	500	9,30
3,2	x	9,2	S	500	9,40
3,2	x	12,3	S	500	11,50

Artikel	88414.005		
88414	Niet Al-Leg.		C-K 16
Dorn Al-Leg.			

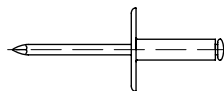

Offene Blindniete mit Sollbruchdorn, ~DIN 7337, C = großer Flachkopf (Ø = 16)

Produktinformation → [TI-207](#) REACH → [TI-262](#)



Niet Ø x Nietlänge

4,8	x	10,3	S	250	19,00
4,8	x	13,5	S	250	20,70
4,8	x	19,9	S	250	38,00
4,8	x	23	S	250	44,00

Abmessungen	VE	Stück	€/100/Obf.
Artikel	88416.004		
88416	Niet Al-Leg.		C-K 11
Dorn A 2			

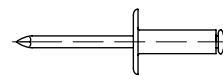

Offene Blindniete mit Sollbruchdorn, ~DIN 7337, C = großer Flachkopf (Ø = 11)

Produktinformation → [TI-207](#) REACH → [TI-262](#)



Niet Ø x Nietlänge

5	x	10	S	500	13,50
5	x	12	S	500	14,50
5	x	16	S	500	15,80
5	x	20	S	250	20,80

Artikel	88416.005		
88416	Niet Al-Leg.		C-K 14
Dorn A 2			

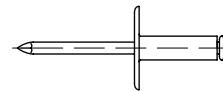

Offene Blindniete mit Sollbruchdorn, ~DIN 7337, C = großer Flachkopf (Ø = 14)

Produktinformation → [TI-207](#) REACH → [TI-262](#)



Niet Ø x Nietlänge

5	x	10	S	250	15,70
5	x	12	S	250	16,70
5	x	16	S	250	18,50
5	x	20	S	250	21,90

Artikel	88419.000		
88419	Niet Al-Leg.		G-F
Dorn Stahl, verz.			

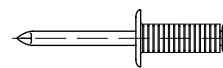

Offene Blindniete mit Sollbruchdorn, F = Flachrundkopf G = gerillt für Sacklochnietung

Produktinformation → [TI-208](#) REACH → [TI-262](#)



Niet Ø x Nietlänge

3,2	x	10	S	500	5,70
3,2	x	16	S	500	7,90
4	x	8	S	500	5,70
4	x	12	S	500	7,00
4	x	16	S	500	8,40

Abmessungen	VE Stück	€/100/obf.
Artikel 88420.004		
88420 Niet Al-Leg. CAP- F Dorn Stahl*		

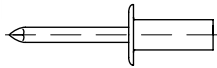

Geschlossene Blindniete mit Sollbruchdorn, ~ISO 15973, F = Flachrundkopf

CAP = geschlossen für luft- und wasserdichte Nietungen
*phosphatiert

Produktinformation → TI-208 REACH → TI-262



Niet Ø x Nietlänge

3,2 x 6,5	S 500	6,70
3,2 x 8	S 500	6,80
3,2 x 9,5	S 500	6,80
3,2 x 10,5	S 500	7,40
3,2 x 12,5	S 500	7,80
4 x 8	S 500	8,20
4 x 9,5	S 500	8,30
4 x 11	S 500	9,00
4 x 12,5	S 500	9,40
4,8 x 8	S 500	9,40
4,8 x 9,5	S 500	9,50
4,8 x 11	S 500	9,80
4,8 x 12,5	S 500	9,80
4,8 x 14	S 500	10,70
4,8 x 16	S 500	10,90
4,8 x 18	S 500	11,40
4,8 x 21	S 250	14,50

Artikel	88420.005
88420 Niet Al-Leg. CAP- F Dorn A 2	

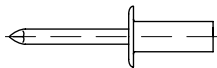

Geschlossene Blindniete mit Sollbruchdorn, F = Flachrundkopf

CAP = geschlossen für luft- und wasserdichte Nietungen

Produktinformation → TI-208 REACH → TI-262



Niet Ø x Nietlänge

3,2 x 6,5	S 500	11,00
3,2 x 8	S 500	11,30
3,2 x 9,5	S 500	11,80
3,2 x 10,5	S 500	12,00
3,2 x 12,5	S 500	12,50
4 x 8	S 500	15,40
4 x 9,5	S 500	15,80
4 x 11	S 500	16,00
4 x 12,5	S 500	17,50
4,8 x 8	S 500	16,30
4,8 x 9,5	S 500	17,70
4,8 x 11	S 500	18,80

Abmessungen	VE Stück	€/100/obf.
4,8 x 12,5	S 500	19,30
4,8 x 14	S 500	20,50
4,8 x 16	S 500	21,70
4,8 x 18	S 500	22,30
4,8 x 21	S 250	24,00

Artikel	88420.007
88420 Niet Cu-Leg. CAP- F Dorn A 2	

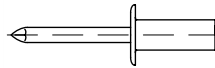

Geschlossene Blindniete mit Sollbruchdorn, F = Flachrundkopf

CAP = geschlossen für luft- und wasserdichte Nietungen

Produktinformation → TI-208 REACH → TI-262



Niet Ø x Nietlänge

3,2 x 6	S 500	14,90
3,2 x 9	S 500	16,30

Artikel	88421.000
88421 Niet Stahl, verz. M Dorn Stahl, verz.	



Offene Blindniete mit Sollbruchdorn, M = mit Anschluss-Gewinde

Festigkeitsklasse Schraube = 8.8

Produktinformation → TI-209

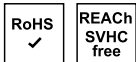

Gewinde M x Länge / Nietschaft Ø x -Länge

M 4 x 10 / 6 x 11	S 200	58,00
M 5 x 11,5 / 7 x 11,5	S 150	63,00
M 6 x 13 / 9 x 15,5	S 150	73,00
M 8 x 15,5 / 11 x 17	S 100	92,00

Abmessungen	VE Stück	€/100/obf.
Artikel 88422.000		
88422 Niet Al-Leg. SS-F Dorn Stahl, verz.		

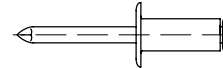

Offene Blindniete mit Sollbruchdorn, F = Flachkopf SS = mit Spreizschaft

Produktinformation → TI-209 REACH → TI-262



Niet Ø x Nietlänge

3,2 x 10	S 500	5,90
3,2 x 12	S 500	7,70
3,2 x 16	S 500	9,40
4 x 8	S 500	5,90
4 x 10	S 500	6,20
4 x 12	S 500	7,50
4 x 14	S 500	7,80
4 x 16	S 500	8,30
4 x 18	S 500	9,50
4 x 20	S 500	12,80
4,8 x 10	S 500	9,30
4,8 x 12	S 500	9,70
4,8 x 14	S 250	10,00
4,8 x 16	S 250	10,70
4,8 x 18	S 250	11,40
4,8 x 20	S 250	14,00
4,8 x 25	S 250	16,90

Artikel	88488.700
88488 Niet Al-Leg. TRI-FOLD Dorn Al-Leg.	

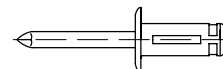

Offene Blindniete mit Sollbruchdorn, F = Flachrundkopf TRI-FOLD = eingelassene Krone

Pressflaschen-Niet für weiche Werkstoffe

Produktinformation → TI-211 REACH → TI-262



Niet Ø x Nietlänge

4,8 x 22,2	S 250	33,50
4,8 x 25,4	S 250	35,50

Abmessungen	VE Stück	€/100/Obf.
Artikel	88474.010	
88474	Niet Stahl, verz.	MB-A
	Dorn Stahl, verz.	

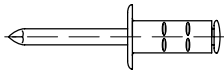

Offene Blindniete mit Sollbruchdorn,
A = Flachkopf
MB = Mehrbereichsschaft

Produktinformation → [TI-209](#)

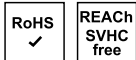

Niet Ø x Nietlänge

3,2	x	8	S	1000	6,50
3,2	x	9,5	S	1000	7,70
3,2	x	11	S	1000	8,70
4	x	10	S	500	8,80
4	x	13	S	500	10,90
4	x	17	S	500	14,40
4,8	x	10	S	500	10,90
4,8	x	15	S	500	13,80
4,8	x	17	S	500	15,00

Artikel	88474.004
88474	Niet Al-Leg.
	Dorn Stahl, verz.
	MB-A

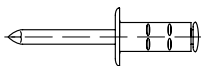

Offene Blindniete mit Sollbruchdorn,
A = Flachkopf
MB = Mehrbereichsschaft

Produktinformation → [TI-209](#) REACH → [TI-262](#)



Niet Ø x Nietlänge

3,2	x	8	S	1000	4,65
3,2	x	9,5	S	1000	4,90
3,2	x	11	S	1000	5,40
4	x	10	S	500	5,90
4	x	13	S	500	6,80
4	x	17	S	500	8,30
4,8	x	10	S	500	7,30
4,8	x	15	S	500	9,40
4,8	x	17	S	500	10,80

Abmessungen	VE Stück	€/100/Obf.
Artikel	88474.704	
88474	Niet Al-Leg.	MB-A
	Dorn A 2	

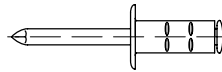

Offene Blindniete mit Sollbruchdorn,
A = Flachkopf
MB = Mehrbereichsschaft

Produktinformation → [TI-209](#) REACH → [TI-262](#)



Niet Ø x Nietlänge

3,2	x	8	S	1000	7,70
3,2	x	9,5	S	1000	7,90
3,2	x	11	S	1000	8,40
4	x	10	S	500	9,50
4	x	13	S	500	10,90
4	x	17	S	500	12,40
4,8	x	10	S	500	14,20
4,8	x	15	S	500	16,00
4,8	x	17	S	500	17,70
4,8	x	25	S	250	24,50
4,8	x	30	S	250	27,00

Artikel	88474.920
88474	Niet A 2
	Dorn A 2
	MB-A

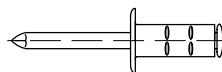

Offene Blindniete mit Sollbruchdorn,
A = Flachkopf
MB = Mehrbereichsschaft

Produktinformation → [TI-209](#)

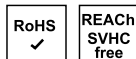

Niet Ø x Nietlänge

3,2	x	8	S	1000	21,30
3,2	x	9,5	S	1000	24,40
3,2	x	11	S	1000	30,50
4	x	10	S	500	31,00
4	x	13	S	500	39,00
4	x	17	S	500	44,00
4,8	x	10	S	500	45,00
4,8	x	15	S	500	52,00
4,8	x	17	S	500	56,00
6,4	x	13	S	250	64,00
6,4	x	15	S	250	67,00
6,4	x	20	S	200	74,00

Abmessungen	VE Stück	€/100/Obf.
Artikel	88474.940	
88474	Niet A 4	MB-A
	Dorn A 4	

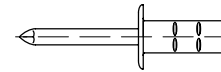

Offene Blindniete mit Sollbruchdorn,
A = Flachkopf
MB = Mehrbereichsschaft

Produktinformation → [TI-209](#)

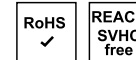

Niet Ø x Nietlänge

3,2	x	11	S	1000	37,00
4	x	10	S	500	37,00
4,8	x	10	S	500	50,00
4,8	x	15	S	500	59,00

Artikel	88475.010
88475	Niet Stahl, verz.
	Dorn Stahl, verz.
	MB-CK

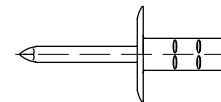

Offene Blindniete mit Sollbruchdorn,
CK = großer Flachkopf
MB = Mehrbereichsschaft

Produktinformation → [TI-210](#)

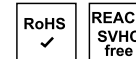

Niet Ø x Nietlänge - Kopf Ø

3,2	x	8	K 9,5	S	1000	7,50
3,2	x	9,5	K 9,5	S	1000	9,20
3,2	x	11	K 9,5	S	1000	10,20
4	x	10	K 12	S	500	10,50
4	x	13	K 12	S	500	13,00
4	x	17	K 12	S	500	17,20
4,8	x	10	K 16	S	250	13,00
4,8	x	15	K 16	S	250	16,50
4,8	x	17	K 16	S	250	18,50

Abmessungen	VE Stück	€/100/Obf.
Artikel 88475.004		
88475	Niet Al-Leg. MB-CK	Dorn Stahl, verz.

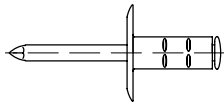

Offene Blindniete mit Sollbruchdorn, CK = großer Flachkopf MB = Mehrbereichsschaft

Produktinformation → [TI-210](#) REACH → [TI-262](#)



Niet Ø x Nietlänge - Kopf Ø

3,2	x 8	K 9,5	S 1000	6,20
3,2	x 9,5	K 9,5	S 1000	6,80
3,2	x 11	K 9,5	S 1000	7,40
4	x 10	K12	S 500	8,70
4	x 13	K12	S 500	9,40
4	x 17	K12	S 500	11,00
4,8	x 10	K16	S 250	10,70
4,8	x 15	K16	S 250	13,00
4,8	x 17	K16	S 250	13,80

Artikel	88475.704
88475	Niet Al-Leg. MB-CK
	Dorn A 2

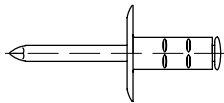

Offene Blindniete mit Sollbruchdorn, CK = großer Flachkopf MB = Mehrbereichsschaft

Produktinformation → [TI-210](#) REACH → [TI-262](#)



Niet Ø x Nietlänge - Kopf Ø

3,2	x 8	K 9,5	S 1000	9,30
3,2	x 9,5	K 9,5	S 1000	10,00
3,2	x 11	K 9,5	S 1000	10,80
4	x 13	K12	S 500	14,20
4	x 17	K12	S 500	15,70
4,8	x 10	K16	S 250	16,50
4,8	x 15	K16	S 250	19,20
4,8	x 17	K16	S 250	20,90
4,8	x 25	K16	S 100	26,00
4,8	x 30	K16	S 100	29,50

Abmessungen	VE Stück	€/100/Obf.
Artikel 88476.010		
88476	Niet Stahl, verz. MEGA-F	Dorn Stahl, verz. gelb

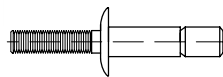

Offene Blindniete mit Sollbruchdorn, F = Flachrundkopf MEGA GRIP = für hochfeste Nietmontage

Produktinformation → [TI-210](#)

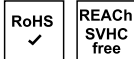

Niet Ø x Nietlänge

4,8	x 10,5	S 500	35,00
4,8	x 14	S 250	37,00
6,4	x 14,1	S 200	48,00
6,4	x 20,5	S 100	63,00

Artikel	88477.010
88477	Niet Stahl, verz. MEGA-S
	Dorn Stahl, verz. gelb

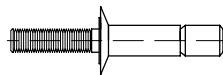

Offene Blindniete mit Sollbruchdorn, S = Senkkopf 97° MEGA GRIP = für hochfeste Nietmontage

Produktinformation → [TI-210](#)

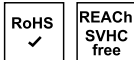

Niet Ø x Nietlänge

4,8	x 10,5	S 5000	46,00
4,8	x 14,5	S 2500	47,50
6,4	x 14,1	S 2000	63,00

Artikel	88418.010
88418	Stahl S klein
	galvanisch verzinkt

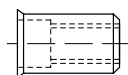

Blindniet-Muttern, rund, offen, S klein = kleiner Senkkopf 90°

Produktinformation → [TI-212](#)

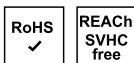

Innengewinde M / min.-max. Klemmbereich

M 4 / 0,25-3,0	S 500	33,50
M 5 / 0,25-3,0	S 500	34,00
M 6 / 0,25-3,5	S 250	45,00
M 8 / 0,25-3,5	S 100	63,00

Abmessungen	VE Stück	€/100/Obf.
Artikel 88418.700		
88418	Al-Leg. S klein	

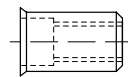

Blindniet-Muttern, rund, offen, S klein = kleiner Senkkopf 90°

Produktinformation → [TI-212](#) REACH → [TI-262](#)



Innengewinde M / min.-max. Klemmbereich

M 4 / 0,5-3,0	S 500	24,80
M 5 / 0,5-3,0	S 500	27,50
M 6 / 0,5-3,5	S 250	40,00
M 8 / 0,5-3,5	S 100	57,00

Artikel	88418.920
88418	A 2 (1.4567) S klein

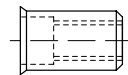

Blindniet-Muttern, rund, offen, S klein = kleiner Senkkopf 90°

Produktinformation → [TI-212](#)

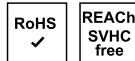

Innengewinde M / min.-max. Klemmbereich

M 4 / 0,25-3,0	S 500	128,00
M 5 / 0,25-3,0	S 500	138,00
M 6 / 0,25-3,5	S 250	211,00
M 8 / 0,25-3,5	S 100	280,00

Artikel	88418.940
88418	A 4 S klein

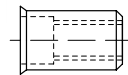

Blindniet-Muttern, rund, offen, S klein = kleiner Senkkopf 90°

Produktinformation → [TI-212](#)

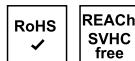

Innengewinde M / min.-max. Klemmbereich

M 4 / 0,25-3,0	S 500	39,50
M 5 / 0,25-3,0	S 500	42,00
M 6 / 0,25-3,5	S 250	53,00
M 8 / 0,25-3,5	S 100	76,00

Abmessungen	VE Stück	€/100/Obf.
Artikel	88423.010	
88423	Stahl	F
	galvanisch verzinkt	

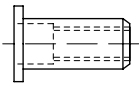

**Blindniet-Muttern, rund, offen,
F = Flachkopf**

Produktinformation → [TI-213](#)

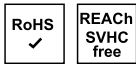

Innengewinde M / min.-max. Klemmbereich

M 4 / 0,25-3,0	S 500	30,00
M 4 / 2,5 -4,5	S 500	32,00
M 5 / 0,25-3,0	S 500	34,00
M 5 / 2,5 -5,0	S 500	37,00
M 6 / 0,25-3,5	S 250	47,50
M 6 / 3,0 -5,5	S 250	51,00
M 8 / 0,25-3,5	S 100	64,00
M 8 / 3,0 -6,0	S 100	67,00
M10 / 0,25-3,5	S 100	77,00
M10 / 3,0 -6,0	S 100	78,00

Artikel	88423.700
88423	Al-Leg.
	F

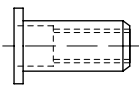

**Blindniet-Muttern, rund, offen,
F = Flachkopf**

Produktinformation → [TI-213](#) REACH → [TI-262](#)



Innengewinde M / min.-max. Klemmbereich

M 4 / 0,25-3,0	S 500	16,80
M 4 / 2,5 -4,5	S 500	17,80
M 5 / 0,25-3,0	S 500	18,90
M 5 / 2,5 -5,0	S 500	19,80
M 6 / 0,25-3,5	S 250	30,50
M 6 / 3,0 -5,5	S 250	32,50
M 8 / 0,25-3,5	S 100	40,00
M 8 / 3,0 -6,0	S 100	41,00
M 10 / 0,25-3,5	S 100	57,00
M 10 / 3,0 -6,0	S 100	58,00

Abmessungen	VE Stück	€/100/Obf.
Artikel	88423.920	
88423	A 2 (1.4567)	F

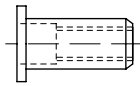

**Blindniet-Muttern, rund, offen,
F = Flachkopf**

Produktinformation → [TI-213](#)

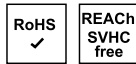

Innengewinde M / min.-max. Klemmbereich

M 4 / 0,25-3,0	S 500	128,00
M 4 / 2,5 -4,0	S 500	131,00
M 5 / 0,25-3,0	S 500	138,00
M 5 / 2,5 -4,5	S 500	142,00
M 6 / 0,25-3,5	S 250	211,00
M 6 / 3,0 -5,5	S 250	217,00
M 8 / 0,25-3,5	S 100	280,00
M 8 / 3,0 -6,0	S 100	290,00

Artikel	88423.940
88423	A 4
	F

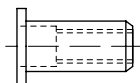

**Blindniet-Muttern, rund, offen,
F = Flachkopf**

Produktinformation → [TI-213](#)

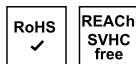

Innengewinde M / min.-max. Klemmbereich

M 4 / 0,25-3,0	S 500	41,00
M 4 / 2,5 -4,0	S 500	41,50
M 5 / 0,25-3,0	S 500	43,50
M 5 / 2,5 -4,5	S 500	46,00
M 6 / 0,25-3,5	S 250	58,00
M 6 / 3,0 -5,5	S 250	59,00
M 8 / 0,25-3,5	S 100	82,00
M 8 / 3,0 -6,0	S 100	87,00

Abmessungen	VE Stück	€/100/Obf.
Artikel	88424.010	
88424	Stahl	S
	galvanisch verzinkt	

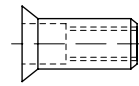

**Blindniet-Muttern, rund, offen,
S = Senkkopf 90°**

Produktinformation → [TI-213](#)

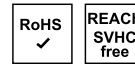

Innengewinde M / min.-max. Klemmbereich

M 4 / 1,5-3,5	S 500	33,50
M 5 / 1,5-3,5	S 500	39,00
M 5 / 3,5-6,0	S 500	41,00
M 6 / 1,5-4,5	S 250	54,00
M 6 / 4,0-6,5	S 250	57,00
M 8 / 1,5-4,5	S 100	68,00
M 8 / 4,0-6,5	S 100	76,00
M10 / 1,5-4,5	S 100	87,00
M10 / 4,0-6,5	S 100	88,00

Artikel	88424.700
88424	Al-Leg.
	S

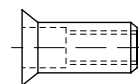

**Blindniet-Muttern, rund, offen,
S = Senkkopf 90°**

Produktinformation → [TI-213](#) REACH → [TI-262](#)



Innengewinde M / min.-max. Klemmbereich

M 4 / 1,5-3,5	S 500	19,20
M 5 / 1,5-4,0	S 500	21,70
M 5 / 3,5-6,0	S 500	23,00
M 6 / 1,5-4,5	S 250	35,00
M 6 / 4,0-6,5	S 250	37,00
M 8 / 1,5-4,5	S 100	45,00
M 8 / 4,0-6,5	S 100	46,00
M10 / 1,5-4,5	S 100	64,00
M10 / 4,0-6,5	S 100	66,00



- ✓ Große Artikelvielfalt
- ✓ Verlässliche Qualität
- ✓ Hohe Lieferbereitschaft

Abmessungen	VE Stück	€/100/Obf.
Artikel 88424.920		
88424	A 2 (1.4567)	S

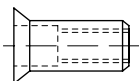

**Blindniet-Muttern, rund, offen,
S = Senkkopf 90°**

Produktinformation → [TI-213](#)

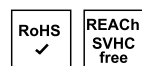

Innengewinde M / min.-max. Klemmbereich

M 4 / 1,5 - 3,0	S 500	128,00
M 4 / 2,5 - 4,0	S 500	131,00
M 5 / 1,5 - 4,0	S 500	138,00
M 5 / 3,5 - 6,0	S 500	142,00
M 6 / 1,5 - 4,5	S 250	211,00
M 6 / 4,0 - 6,0	S 250	217,00
M 8 / 1,5 - 4,5	S 100	280,00
M 8 / 4,0 - 6,0	S 100	290,00

Artikel	88424.940
88424	A 4 S

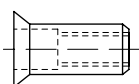

**Blindniet-Muttern, rund, offen,
S = Senkkopf 90°**

Produktinformation → [TI-213](#)



Innengewinde M / min.-max. Klemmbereich

M 4 / 1,5 - 3,0	S 500	41,00
M 4 / 2,5 - 4,0	S 500	41,50
M 5 / 1,5 - 4,0	S 500	44,50
M 5 / 3,5 - 6,0	S 500	46,50
M 6 / 1,5 - 4,5	S 250	56,00
M 6 / 4,0 - 6,0	S 250	57,00
M 8 / 1,5 - 4,5	S 100	81,00
M 8 / 4,0 - 6,0	S 100	82,00

Abmessungen	VE Stück	€/100/Obf.
Artikel 88480.010		
88480	Stahl galvanisch verzinkt	F

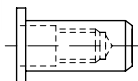

**Blindniet-Muttern, rund,
geschl. für luft- und wasserdichte
Nietungen,
F = Flachkopf**

Produktinformation → [TI-213](#)



Innengewinde M / min.-max. Klemmbereich

M 5 / 0,5 - 3,0	S 500	42,00
M 5 / 3,0 - 5,5	S 500	46,50
M 6 / 0,5 - 3,0	S 500	56,00
M 6 / 2,5 - 5,5	S 500	59,00
M 8 / 0,5 - 3,5	S 200	78,00
M 8 / 3,0 - 6,0	S 200	84,00

Artikel	88480.700
88480	Al-Leg. F

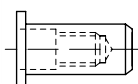

**Blindniet-Muttern, rund,
geschl. für luft- und wasserdichte
Nietungen,
F = Flachkopf**

Produktinformation → [TI-213](#) REACH → [TI-262](#)



Innengewinde M / min.-max. Klemmbereich

M 5 / 3,0 - 4,0	S 500	23,70
M 6 / 0,5 - 3,0	S 500	36,00
M 6 / 3,0 - 4,5	S 500	37,50
M 8 / 0,3 - 3,0	S 250	49,00
M 8 / 3,0 - 5,5	S 250	58,00

Abmessungen	VE Stück	€/100/Obf.
Artikel 88481.010		
88481	Stahl galvanisch verzinkt	S

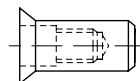

**Blindniet-Muttern, rund,
geschl. für luft- und wasserdichte
Nietungen,
S = Senkkopf 90°**

Produktinformation → [TI-213](#)



Innengewinde M / min.-max. Klemmbereich

M 4 / 1,5 - 3,5	S 500	39,50
M 5 / 1,5 - 4,0	S 500	45,00
M 6 / 1,5 - 4,5	S 500	59,00
M 8 / 1,5 - 4,5	S 250	82,00
M 8 / 4,5 - 6,0	S 250	84,00

Artikel	88481.700
88481	Al-Leg. S

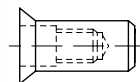

**Blindniet-Muttern, rund,
geschl. für luft- und wasserdichte
Nietungen,
S = Senkkopf 90°**

Produktinformation → [TI-213](#) REACH → [TI-262](#)



Innengewinde M / min.-max. Klemmbereich

M 5 / 1,5 - 4,0	S 500	25,00
M 6 / 1,5 - 4,5	S 500	36,00
M 8 / 1,5 - 4,5	S 500	51,00



Wir versorgen Sie mit
Verbindungselementen
und Befestigungstechnik!

Abmessungen	VE Stück	€/100/Obf.
Artikel	88490.010	
88490	Stahl	MB-F
	galvanisch verzinkt	

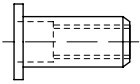

Blindniet-Muttern, rund, offen,
MB = mit Mehrbereichsschaft
F = Flachkopf

Produktinformation → [TI-213](#)

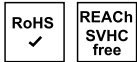

Innengewinde M / min.-max. Klemmbereich

M 4 / 0,5 - 6,0	S 500	26,50
M 5 / 0,5 - 6,0	S 500	32,00
M 6 / 0,5 - 6,0	S 500	43,50
M 8 / 0,5 - 7,5	S 500	57,00

Artikel	88490.700	
88490	Al-Leg.	MB-F

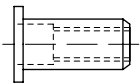

Blindniet-Muttern, rund, offen,
MB = mit Mehrbereichsschaft
F = Flachkopf

Produktinformation → [TI-213](#) REACH → [TI-262](#)



Innengewinde M / min.-max. Klemmbereich

M 4 / 0,5 - 6,0	S 500	15,50
M 5 / 0,5 - 6,0	S 500	17,90
M 6 / 0,5 - 6,0	S 500	28,00
M 8 / 0,5 - 7,5	S 500	36,00

Artikel	88490.920	
88490	A 2	MB-F

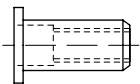

Blindniet-Muttern, rund, offen,
MB = mit Mehrbereichsschaft
F = Flachkopf

Produktinformation → [TI-213](#)



Innengewinde M / min.-max. Klemmbereich

M 5 / 0,5 - 5,0	S 500	49,00
M 6 / 0,5 - 6,0	S 250	64,00
M 8 / 0,5 - 6,5	S 100	79,00

Abmessungen	VE Stück	€/100/Obf.
Artikel	88491.010	
88491	Stahl	MB-S
	galvanisch verzinkt	

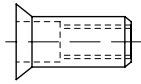

Blindniet-Muttern, rund, offen,
MB = mit Mehrbereichsschaft
S = Senkkopf 90°

Produktinformation → [TI-213](#)

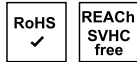

Innengewinde M / min.-max. Klemmbereich

M 4 / 1,5 - 6,0	S 500	27,00
M 5 / 1,5 - 6,0	S 500	32,00
M 6 / 1,5 - 6,0	S 500	44,00
M 8 / 1,5 - 7,5	S 500	57,00

Artikel	88491.700	
88491	Al-Leg.	MB-S

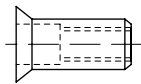

Blindniet-Muttern, rund, offen,
MB = mit Mehrbereichsschaft
S = Senkkopf 90°

Produktinformation → [TI-213](#) REACH → [TI-262](#)



Innengewinde M / min.-max. Klemmbereich

M 4 / 1,5 - 6,0	S 500	16,20
M 5 / 1,5 - 6,0	S 500	18,30
M 6 / 1,5 - 6,0	S 500	28,00
M 8 / 1,5 - 7,5	S 500	36,50

Artikel	88483.010	
88483	Stahl	6kt-F
	galvanisch verzinkt	

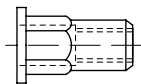

Blindniet-Muttern, Sechskant, offen,
F = Flachkopf
 mit Teilsechskant

Produktinformation → [TI-214](#)

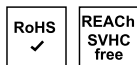

Innengewinde M / min.-max. Klemmbereich

M 4 / 0,5 - 2,0	S 500	26,50
M 5 / 0,5 - 3,5	S 500	30,50
M 6 / 0,5 - 3,5	S 250	44,00
M 8 / 0,5 - 3,5	S 100	56,00

Abmessungen	VE Stück	€/100/Obf.
Artikel	88483.920	
88483	A 2	6kt-F

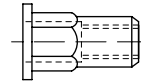

Blindniet-Muttern, Sechskant, offen,
F = Flachkopf
 mit Teilsechskant

Produktinformation → [TI-214](#)



Innengewinde M / min.-max. Klemmbereich

M 4 / 0,5 - 2,0	S 500	59,00
M 5 / 0,5 - 3,0	S 500	64,00
M 6 / 0,5 - 3,0	S 500	77,00
M 8 / 0,5 - 3,0	S 250	113,00
M10 / 1,0 - 3,5	S 200	212,00

Artikel	88484.010	
88484	Stahl	6kt-S-klein
	galvanisch verzinkt	

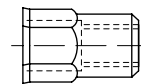

Blindniet-Muttern, Sechskant, offen,
S klein = kleiner Senkkopf
 mit Teilsechskant

Produktinformation → [TI-214](#)

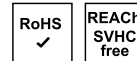

Innengewinde M / min.-max. Klemmbereich

M 4 / 0,5 - 2,0	S 500	27,50
M 5 / 0,5 - 3,0	S 500	31,50
M 6 / 0,5 - 3,0	S 250	44,00
M 8 / 0,5 - 3,0	S 100	56,00

Artikel	88484.920	
88484	A 2	6kt-S-klein

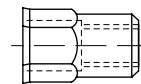

Blindniet-Muttern, Sechskant, offen,
S klein = kleiner Senkkopf
 mit Teilsechskant

Produktinformation → [TI-214](#)

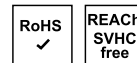

Innengewinde M / min.-max. Klemmbereich

M 4 / 0,5 - 2,0	S 500	57,00
M 5 / 0,5 - 3,0	S 500	62,00

Abmessungen	VE	Stück	€/100/Obf.
M 6 / 0,5 -3,0	S	500	74,00
M 8 / 0,5 -3,0	S	250	101,00
M 10 / 1,0 -3,5	S	200	198,00

Artikel	88441.000
88441 Sortiment	BZ 2
m. Handnietzange	

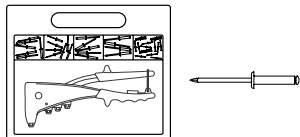

WG-Blindniete Sortiment BZ 2

- ALFO Alu/Stahl*
- ALFO Alu/Niro**
- OPTO Alu/Stahl***

Inhalt: 1 Handzange inkl. Montageschlüssel, Ersatzspannbacken, je 1 Bohrer 3,1 mm und 4,1 mm sowie Blindniete mit Flachkopf

- * 350 Stück
- ** 350 Stück
- *** 300 Stück

Kunststoff-Kasten mit Zubehör und Anleitung



aus Herstellervorrat lieferbar

BZ 2 ALFO Alu/Stahl	S	1	7100,00
BZ 2 ALFO Alu/Niro	S	1	7800,00
BZ 2 OPTO Alu/Stahl	S	1	7500,00

Artikel	88441.001
88441 Sortiment	BZ 44
m. Handnietzange	

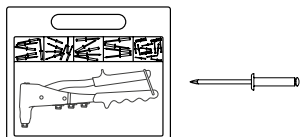

WG-Blindniete Sortiment BZ 44

- ALFO Alu/Stahl*
- Leichtbau**
- CERTO Alu/Stahl***

Inhalt: 1 Handzange inkl. Montageschlüssel, Ersatzspannbacken, je 1 Bohrer 3,1 mm und 4,1 mm sowie 350 Blindniete mit Flachkopf

- * 350 Stück
- ** 260 Stück
- *** 300 Stück

Kunststoff-Kasten mit Zubehör und Anleitung



aus Herstellervorrat lieferbar

BZ 44 ALFO Alu/Stahl	S	1	7900,00
BZ 44 ALFO Leichtbau	S	1	9000,00
BZ 44 CERTO Alu/Stahl	S	1	8400,00

Abmessungen	VE	Stück	€/100/Obf.
Artikel	88441.002		
88441 Sortiment		BZ 6	
m. Handnietzange			

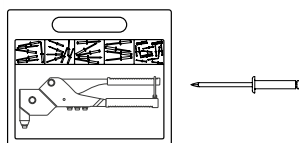

WG-Blindniete Sortiment BZ 6

- OPTO Alu/Stahl*
- OPTO Alu/Edelstahl FASSADE**
- Edelstahl***

Inhalt: 1 Handzange inkl. Montageschlüssel sowie Blindniete mit Flachkopf

- * 350 Stück
- ** 170 Stück
- *** 350 Stück

Kunststoff-Kasten mit Zubehör und Anleitung



aus Herstellervorrat lieferbar

BZ 6 OPTO Alu/Stahl	S	1	9700,00
BZ 6 OPTO Alu/Niro	S	1	9200,00
BZ 6 Edelstahl	S	1	12900,00

Artikel	88441.003
88441 Sortiment	VNG 255
m. Handnietzange	

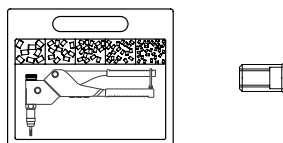

Blindnietmuttern Sortiment VNG 255

- CLASSIC*
- BASIC**
- OPTO***

Inhalt: 1 Handzange inkl. 1 Umrüstsatz, 1 Gewindehülse, 1 Maulschlüssel und 1 Sechskantstiftschlüssel sowie Blindnietmuttern mit Senk- und Flachkopf

- * 125/25 Stück Blindnietmuttern/Gewindebolzen
- ** 450 Stück Blindnietmuttern
- *** 250 Stück Blindnietmuttern

Kunststoff-Kasten mit Zubehör und Anleitung



aus Herstellervorrat lieferbar

VNG 255 Classic	S	1	8900,00
VNG 255 Basic	S	1	13600,00
VNG 255 OPTO	S	1	10300,00

Abmessungen	VE	Stück	€/100/Obf.
Artikel	88440.001		
88440 Stahl		BZ 2	

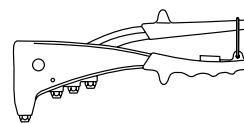

WG-Handnietzangen BZ 2 für Blindniete

aus Herstellervorrat lieferbar

BZ 2	S	1	4050,00
------	---	---	---------

Artikel	88440.002
88440 Stahl	BZ 44

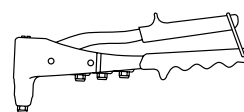

WG-Handnietzangen BZ 44 für Blindniete

aus Herstellervorrat lieferbar

BZ 44	S	1	4450,00
-------	---	---	---------

Artikel	88440.003
88440 Stahl	BZ 58

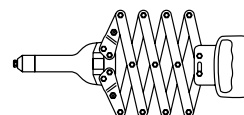

WG-Scherenwerkzeuge BZ 58 für Blindniete

aus Herstellervorrat lieferbar

BZ 58	S	1	13300,00
-------	---	---	----------

Artikel	88440.004
88440 Stahl	BZ 70

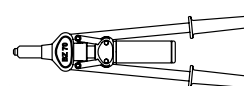

WG-Hebelnetzwerkzeuge BZ 70 für Blindniete

aus Herstellervorrat lieferbar

BZ 70	S	1	12900,00
-------	---	---	----------

Abmessungen	VE	Stück	€/100/Obf.
Artikel	88440.005		
88440	Stahl		BZ 72

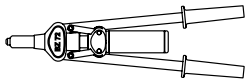

WG-Hebelnietwerkzeuge BZ 72 für Blindniete

aus Herstellervorrat lieferbar

BZ 72	S	1	15900,00
-------	---	---	----------

Artikel	88440.006		
88440	Stahl		MULTI 1

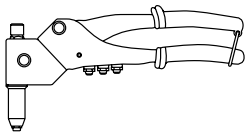

WG-Handnietzangen MULTI 1 für Blindniete, Blindnietmuttern und Gewindebolzen

aus Herstellervorrat lieferbar

MULTI 1	S	1	8800,00
---------	---	---	---------

Artikel	88440.007		
88440	Stahl		MULTI 5

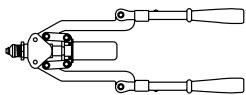

WG-Handnietzangen MULTI 5 für Blindniete, Blindnietmuttern und Gewindebolzen

aus Herstellervorrat lieferbar

MULTI 5	S	1	18600,00
---------	---	---	----------

Artikel	88440.008		
88440	Stahl		VNG 371

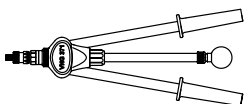

WG-Hebelnietzangen VNG 371 für Blindnietmuttern und Gewindebolzen

aus Herstellervorrat lieferbar

VNG 371	S	1	30300,00
---------	---	---	----------

Abmessungen	VE	Stück	€/100/Obf.
Artikel	88440.009		
88440	Stahl		VNG 612

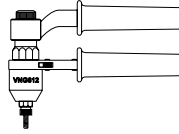

WG-Handnietzangen VNG 612 für Blindnietmuttern und Gewindebolzen

aus Herstellervorrat lieferbar

VNG 612	S	1	31000,00
---------	---	---	----------

Artikel	88443.001		
88443	Akku		RivSmart



WG-Akku-Nieter RivSmart für Blindniete

aus Herstellervorrat lieferbar

.	S	1	105400,00
---	---	---	-----------

Artikel	88443.002		
88443	Akku		Rivdom ONE 16V

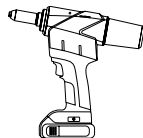

WG-Akku-Nieter Rivdom ONE 16V für Blindniete

aus Herstellervorrat lieferbar

.	S	1	84300,00
---	---	---	----------

Abmessungen	VE	Stück	€/100/Obf.
Artikel	88443.003		
88443	Akku		Rivdom TWO 20V

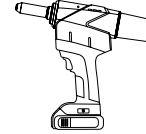

WG-Akku-Nieter Rivdom TWO 20V für Blindniete

aus Herstellervorrat lieferbar

.	S	1	127500,00
---	---	---	-----------

Artikel	88443.004		
88443	Akku		Rivdom ZERO

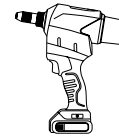

WG-Akku-Nieter Rivdom ZERO für Blindniete

aus Herstellervorrat lieferbar

.	S	1	97300,00
---	---	---	----------

TECHNISCHE INFORMATIONEN (TI)



REM[®]
REYHER ENGINEERING MANAGEMENT

Auf den folgenden mehr als 260 Seiten finden Sie alle relevanten Informationen rund um Verbindungselemente und Befestigungstechnik. Dazu gehören zum Beispiel Maßdatenblätter, Tabellen mit Anziehdrehmomenten und Vorspannkräften für die Montage. Außerdem sind Informationen über aktuelle Korrosionsschutzsysteme und u. a. zur neuen Normung im Bereich der nichtrostenden Stähle enthalten. Des Weiteren dient eine Übersicht über Richtlinien und Gesetze sowie Normumstellungen als wichtige Orientierung bei der Produktauswahl.

Der Inhalt dieser Technischen Informationen ist urheberrechtlich geschützt und alle Rechte stehen ausschließlich REYHER zu. Ohne die schriftliche Zustimmung von REYHER ist die gewerbliche Vervielfältigung oder sonstige gewerbliche Verwendung der bereitgestellten Inhalte und Informationen, insbesondere von Grafiken oder Bildern, nicht gestattet.

Dies gilt insbesondere für Vervielfältigung, Bearbeitung, Übersetzung, Einspeicherung, Verarbeitung bzw. Wiedergabe von Inhalten in Datenbanken oder anderen elektronischen Medien und Systemen. Die unerlaubte Vervielfältigung oder Weitergabe einzelner Inhalte oder kompletter Seiten ist nicht gestattet.

Quelle:
F. REYHER Nchfg. GmbH & Co. KG, Hamburg
Stand: 10/2019

REYHER 

Inhaltsverzeichnis TI

DIN
EN
ISO

NORMENUMSTELLUNG

4-11

Normenumstellung DIN-EN-ISO/ISO-EN-DIN	4
Normenarten, Zusammenhänge	5
Normative Veränderungen bei Schrauben	6
Normative Veränderungen bei Muttern	7
Normative Veränderungen bei Bolzen und Stiften	10
Normative Veränderungen bei Gewinde- und Blechschrauben	11



MAßE FÜR VERBINDUNGSELEMENTE

12-135

Maße für Schrauben	12
– Innensechskant- und Innensechsrundschrauben	12
– Außensechskantschrauben	15
– Stiftschrauben	18
– Gewindestifte	19
– Verschlusschrauben	22
– Schmiernippel	25
– Diebstahlhemmende Schrauben	26
– Sicherungsschrauben	28
– Sonstige Schrauben mit Maschinengewinde	29
– Schlitz- und Kreuzschlitzschrauben mit Maschinengewinde	37
– Blechschrauben, gewindeformende Schrauben und Bohrschrauben	41
– Holzschrauben/Spanplattenschrauben	50
– Sonderformen mit Holzschraubengewinde	54
Maße für Stahlbau-Schrauben, Stahlbau-Muttern und Zubehör	57
– HV-Schrauben, HV-Muttern, HV-Zubehör	57
– Klemmlängen für HV-Schrauben	60
Maße für Muttern	60
– Sechskantmuttern	60
– Sicherungsmuttern	67
– Schweißmuttern	71
– Sonderformen	72
– Gewindeplatten	79
– Spannschlösser	81
– Vierkantmuttern	83
Maße für Scheiben und Ringe	84
– Flache Scheiben (rund)	84
– Vierkantscheiben/Keilscheiben	86
– Dichtungsscheiben (flach)	87
– Sicherungsscheiben und Sicherungsringe	88
– Stellringe	111
– Sonderformen	112

Maße für Stifte	116
– Zylinderstifte/Kegelstifte/Kerbstifte	116
– Einspannbuchsen/Spannhülsen/Spannstifte	120
– Klappstecker/Federstecker/Splinte	122
Maße für Bedienelemente	125
– Griffe	125
– Knebelschrauben/Knebelmuttern	127
Maße für Bügel, Schellen, Seilbefestigungen und Schäkel	130
– Rundstahlbügel	130
– Schlauchschellen/Rohrschellen	130
– Seilklemmen/Seilkauschen/Schäkel	133
Maße für Niete	134
Maße für sonstige Produkte	136
– Schrägzug-Spannelemente	136
– Haken	137
– Achshalter	137
– Passfedern	137



PRODUKTINFORMATIONEN

140-155

Kopf- und Antriebsformen/Formen von Schraubenenden	140
Tellerfedern	141
Ringschrauben und Ringmuttern	142
Kabelbinder und Zubehör	144
Gewindeeinsätze aus Draht	150
Gewindeeinsätze – selbstschneidend	152
Muttern für T-Nuten	154

lindapter®

TRÄGER-VERBINDUNGS- UND KLEMM-SYSTEME

156-159

Produktübersicht Trägerklemmverbindungen, Abhängungen, Hohlprofilbefestigungen und Bodenplattenbefestigungen	156
Trägerkreuzverbindungen	157



DÜBEL UND ANKER

160-163

Auswahl- und Montagehilfen	160
----------------------------	-----

fischer **FISCHER – Dübel und Anker** **164-197**

- Schwerlast-Befestigungen – Chemie 164
- Schwerlast-Befestigungen – Stahllanker 170
- Langschaftdübel/Fassadendübel/Abstands-Befestigungen 182
- Allgemeine Befestigungen 188
- Hohlraum-Befestigungen 192
- Elektro-Befestigungen 195
- Gerüst-Befestigungen 196
- Dämmstoff-Befestigungen 197

Einfach. Sicher. **UPAT** **UPAT – Dübel und Anker** **198-201**

- Schwerlast-Befestigungen – Stahllanker 198
- Schwerlast-Befestigungen – Chemie 200

MULTI-MONTI **MULTI-MONTI Mauerschrauben** **202-204**

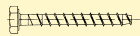

BLINDNIET-TECHNIK **205-214**

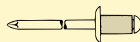

- Blindnieten und Zubehör 205
- Blindniet-Muttern und Zubehör 212

+/- **TOLERANZEN** **216-219**

- Toleranzen für Schrauben, Muttern und Scheiben 216
- Toleranzen, ISO-Abmaße 219

GEWINDE **220-224**



- Profil, Arten, Schraubbarkeit 220
- Gewindeabmaße 222
- Übersicht Gewindesteigungen 224

KORROSIONSSCHUTZ **225-231**



- Allgemeine Hinweise, Korrosionsarten, Kontaktkorrosion 225
- Galvanische Überzüge 228
- Zinklamellenüberzüge 230
- Feuerverzinkungen 231

MECHANISCHE EIGENSCHAFTEN **232-240**



- Verbindungselemente aus Stahl 232
- Verbindungselemente mit Zollgewinde 234
- Verbindungselemente aus nichtrostenden Stählen 236
- Verbindungselemente aus Nichteisenwerkstoffen 239
- Übersicht Sonderwerkstoffe 240



MONTAGE VON SCHRAUBENVERBINDUNGEN **242-251**

- Allgemeine Hinweise, Anziehverfahren, Reibungszahlen 242
- Vorspannkkräfte und Anziehungsmomente für Verbindungselemente aus Stahl 244
- Vorspannkkräfte und Anziehungsmomente für Schraubverbindungen mit Sicherungselementen 247
- Montagehinweise für Schraubenverbindungen im Stahlbau 248
- Vorspannkkräfte und Anziehungsmomente für Verbindungselemente aus nichtrostenden Stählen 249
- Vorspannkkräfte und Anziehungsmomente für Verbindungselemente aus BUMAX, Messing und Polyamid 250
- Montagehinweise für Blechschrauben 251



PRÜFUNG UND ANNAHME **252-255**

- Qualitätskontrolle 252
- Prüfbescheinigungen 252
- Annahmeprüfung nach ISO 3269 253
- Prüfverfahren: Härtemessung, Kerbschlagprüfung 254



SICHERN VON SCHRAUBVERBINDUNGEN **256-259**

- Mechanismus, Maßnahmen 256
- Produktübersicht klebende und klemmende Sicherungen 258
- Produktübersicht Losdrehsicherungen 259



RICHTLINIEN UND GESETZE **260-263**

- EU-Richtlinie 2000/53/EG über Altfahrzeuge 260
- EU-Richtlinie 2002/95/EG über Elektro- und Elektronikgeräte (RoHS) 260
- ZEK 01-08 PAK 260
- California Proposition 65 261
- SJ/T 11364-2014 (China RoHS 2) 261
- Konfliktmineralien 261
- EU-Richtlinie 2006/122/EG (PFOS) 261
- EG-Verordnung 1907/2006 –Chemikalienverordnung (REACH) 262
- EU-BauPVO (Bauproduktenverordnung) 262
- EG-Richtlinie 2006/42/EG (Maschinenrichtlinie) 263
- Produktsicherheitsgesetz 263
- EG-Richtlinie 97/23/EG (Druckgeräterichtlinie) 263

Normenumstellung DIN → ISO/EN

Die Umstellung einiger nationaler DIN-Normen auf ISO- oder EN-Normen erfolgt(e) mit dem Ziel, Handelshemmnisse im internationalen Warenaustausch abzubauen bzw. die technischen Regeln im gemeinsamen europäischen Binnenmarkt zu harmonisieren.

Tabelle 1 zeigt nach DIN-Nummern aufsteigend die entsprechenden ISO/EN-Normen für Produktnormen und die wichtigsten Gewinde- und Grundnormen (Stand: 10/2019).

Tabelle 2 (nächste Seite) zeigt nach ISO-Nummern aufsteigend die entsprechenden EN- und DIN-Normen.

In den Tabellen sind auch Normenentwürfe und zurückgezogene Normen enthalten.

Tabelle 1

Produkt-Normen		Produkt-Normen		Produkt-Normen		Produkt-Normen		Produkt-Normen		Grund-/Funktions-Normen	
DIN	ISO DIN ISO DIN EN ISO	DIN	ISO DIN ISO DIN EN ISO	DIN	ISO DIN ISO DIN EN ISO	DIN	ISO DIN ISO DIN EN ISO	DIN	ISO DIN ISO DIN EN ISO	DIN	ISO DIN ISO DIN EN ISO
1	2339	911	2936	2509*	-	7337	15973-16585	46288	-	78	4753
7	2338	912 (RG)	4762	2510-1...8	-	7338-7340	-	58450	-	101	1051
39	-	912 (FG)	12474	3015-3016	-	7341	-	70613-70618	-	267-1	8992
84	1207	913	4026	3017	-	7343	8750	70851*	-	267-2	4759-1
85	1580	914	4027	3220	-	7344	8748	70852	-	267-3	898-1
93*	-	915	4028	3319	-	7346	13337	70951*	-	267-4	898-2
94	1234	916	4029	3404, 3405	-	7349	-	70952	-	267-5	3269 (16426)
95, 96, 97	-	917	-	3567	-	7500-1	-	71412	-	267-6	4759-1
98, 99	-	920-927	-	3568*	-	7504	15480-15483	71752	-	267-7	898-1
123, 124	1051	928, 929	-	3570	-	7513	-	71802-71805	-	267-8	898-2
125-1,2	7089, 7090	931-1	4014	3575	-	7516	-	74361	-	267-9	4042
126	7091	931-2	-	3670	-	7603	-	80403	-	267-10	10684
127*, 128*	-	933	4017	3870, 3872	-	7604	-	80701	-	267-11	3506-1-4
134*, 137*	-	934 RG	4032, 4033	4109	-	7642, 7643	-	80704	-	267-12	2702
186, 188	-	934 FG	8673, 8674	5299	-	7964	-	80705	-	267-13	-
258	ISO 8737	935-1	-	5406	-	7965	-	81698	-	267-15	2320
261	-	935-3	-	5417	-	7967*	-	82006-82010	-	267-18	8839
302	1051	936 RG/FG	(4035/8675)	5525, 5526	-	7968	-	82013	-	267-19	6157-1, 3
314-318	-	937	-	5586	-	7969	-	82101	-	267-20	6157-2
319	-	938-940	-	5903, 5906	-	7971	1481	-	-	267-21	10484
338, 340	-	949-1,2	-	5914	-	7972	1482	-	-	267-23	898-6
388, 390	-	950-959	-	6303	-	7973	1483	Gewinde-Normen		267-24	-
404	-	960	8765	6304-6307	-	7976	1479	13-1...11	724	267-25	898-7
417	7435	961	8676	6311	-	7977	8737	13-12	261	267-26-30	-
427	2342	963	2009	6319	-	7978	8736	13-13	262, 965-2	475**	272 (EN 1660)
431	-	964	2010	6324	-	7979	8733, 8735	13-14, 15	965-1, -2	522	4759-3
432*	-	965	7046-1, 2	6325	8734	7980*	-	13-16...18	1502	918	1891
433-1,2	7092	966	7047	6330, 6331	-	7981	-	13-19	68-1	946	16047
434-436	-	967, 968	-	6332	-	7982	7049	13-20...26	-	962 (34803)	7378, 8991
438	7436	(970)	4032	6334*	-	7983	7051	13-27	965-3	969	-
439-1	4036	(971-1,2)	8673,8674	6335-6337	-	7984	-	13-28	-	974	-
439-2 RG/FG	4035, 8675	(972)	4034	6340	-	7985	7045	13-50...52	-	2510-2, 8	-
440	7094	975	DIN 976	6378	-	7987*, 7988*	-	14	-	7150-7152	286
442, 443	-	976-1,2	-	6379	-	7989-1,2	-	103-1	2901	7154-7157	-
444	-	977	-	6791, 6792	1051	7990	-	103-2	2902	7160, 7161	286
462, 463*	-	979	-	6796	-	7991	10642	103-3	2903	7168	2768, 8015
464, 465*	-	980 RG	7042 (7719)	6797*	-	7992	-	103-4	2904	7172, 7182	286
466, 467	-	980 FG	10513	6798*	-	7993	DIN 9925/9926	103-5...9	-	7184	1101
468, 469	-	981	-	6799	-	7995-7997	-	202	-	7337	14588-589
470	-	982 RG	7040	6880	-	7999	EN 14399-8	2244	5408	7500-2/7504	-1/10666
471, 472	-	982 FG	10512	6881	-	8140	-	2510-2	-	7962	4757
478-480	-	983	-	6883, 6884	2492	9021	-	7952	-	7970	1478
508	-	985	10511	6885-1, 2	-	9045*	-	7970	1478	7998	-
525, 529	-	986	-	6885-3	-	9841	-	7998	-	8140-1-3	-
546-548	-	987*	-	6886, 6887	-	11014	7379	7998	-	9830	-
551	4766	988	-	6888	3912	11023, 11024	-	8140, 8141	-	66	18800
553	7434	1052	-	6899	-	15058	-	69	15065	273	-
555	4034	1433-1436	-	6900	10644	15237	-	74	273	34803, 34804	-
557	-	1440	-	6901	10510	16903	-	76-1	-	40080	2859-1-3
558	4018	1441	-	6902-6908	10669, 10673	18182	-	76-2	3508, 4755	50049	EN 10204/ ISO 16228
561	-	1443	2340	6911	-	21346	-	-	-	-	-
562	-	1444	2341	6912	-	21547	-	-	-	-	-
564	-	1445	-	6913*	-	22424, 22425	-	-	-	-	-
571	-	1469	-	6914-6915	EN 14399-4	25192	-	-	-	-	-
580, 582	-	1470	8739	6916	EN 14399-6	25193	-	-	-	-	-
601	4016	1471	8744	6917-6918	-	25195	-	-	-	-	-
603	-	1472	8745	6921	EN 1665	25197*	-	-	-	-	-
604-608	-	1473	8740	6922	EN 1665	25200-25203	-	-	-	-	-
609, 610*	-	1474	8741	6923	EN 1661	26020	-	-	-	-	-
653	-	1475	8742/8743	6924 (RG)	7040	28030	-	-	-	-	-
660-662	1051	1476	8746	6924 (FG)	10512	28129	-	-	-	-	-
674, 675	1051	1477	8747	6925 (RG)	7042	28152	-	-	-	-	-
703*, 705	-	1478-1480	-	6925 (FG)	10513	32500, 32501	13918	-	-	-	-
741	-	1481	-	6926 (RG)	EN 1663	34800-34802	-	-	-	-	-
787	299	1587	-	6926 (FG)	EN 1666	34803, 34804	-	-	-	-	-
792	-	1592-1597	-	6927 (RG)	EN 1664	34805	-	-	-	-	-
797, 798*	-	1804	-	6927 (FG)	EN 1667	34810-34816	-	-	-	-	-
830*	-	1816	-	6928 (RG)	7053	34817-34819	-	-	-	-	-
835	-	2093	EN 16983	6928 (FG)	10509	34820	-	-	-	-	-
906-910	-	2507	(EN 1515)	7331	-	46258, 46320	-	-	-	-	-

- ISO/EN-Norm noch nicht bekannt (Stand 10/2019)

() Übergangs-Normen (Maße mit ISO identisch)

* ersatzlos zurückgezogene DIN-Norm, weil z. B. technisch überholt
(Bei Ausgabe von DIN EN-/DIN EN ISO-Normen erfolgt(e)
Zurückziehung entsprechender DIN-/DIN ISO-Normen)

Zeichenerklärung zu Tabelle 2:

Isk	Innensechskant	R/S/L	Regel-/Schwere-/Leichte Ausführung
K/Ks	Kegelkuppe/Kreuzschlitz	Rs/Sp/Za	Ringschneide/Spitze/Zapfen
ME	Mechanische Eigenschaften	TL	Technische Lieferbedingungen
MVE	Mechanische Verbindungselemente	TZ	Technische Zeichnungen
RG/FG	Regelgewinde/Feingewinde		



Tabelle 2

Produkt-Normen				Produkt-Normen				Grund-/Funktions-Normen			
ISO DIN ISO DIN EN ISO	EN DIN EN	DIN	Titel-Stichwort	ISO DIN ISO DIN EN ISO	EN DIN EN	DIN	Titel-Stichwort	ISO DIN ISO DIN EN ISO	EN DIN EN	DIN	Titel-Stichwort
-	1515	2507	Flansch-Verbindg.	7379	-	9841	Isk-Passschrauben	225	20225	-	MVE: Bemaßung
-	1661	6923	Flanschmuttern	7380	-	-	Isk-Flachrundschrauben	272	1660	475-1	Schlüsselweiten Sechsk.
-	(1662), 1665	6921, 6922	Flanschschrauben	7434	27434	553	Gewindestifte Sp	273	20273	69	Durchgangslöcher f. Schrb.
-	1663, 1664	6926, 6927	Flanschmuttern	7435	27435	417	Gewindestifte Za	286-1, 2	20286	7150-7182	ISO-Toleranzen/Passungen
-	1666, 1667FG	6926, 6927FG	mit Klemmteil	7436	27436	438	Gewindestifte Rs	885	-	-	Radien unter Schrb.-Kopf
-	14218, 14219	-	Flanschschrb./Mu FG	7719, 7720	-	980, 6925	Muttern m. Klemmteil	887	-	-	Flache Scheiben, Übers.
-	14399-4	6914-6915	HV-Schrauben/Muttern	8100, 8102	1665	6921	Sechsk.-Flansch-Schr.	888	-	-	Nennlängen Schrb./Gew.
-	14399-6	6916	HV-Scheiben	8104	1662	6922	Sechsk.-Flansch-Schr.	898-1	-	267-3, 7	TL: MVE Muttern RG
-	14399-8	7999	HV-Passschrauben	8673	-	934, 971-1	Sechskant-Mu. FG	898-2	-	4, 8	TL: MVE Muttern FG
-	16983	2093	Tellerfedern	8674	-	934, 972-2	Sechskant-Mu. FG	898-5	-	267-3	TL: MVE Gewindestifte
299	-	508/787	T-Nuten/Mu/Schrauben	8675	-	439-2, 936	Muttern, niedrig, FG	898-6	-	267-23	TL: MVE Muttern FG
773	-	6885-1, 2	Passfedern	8676	-	961	Sechskant-Schrauben FG	898-7	-	267-25	Torsionsversuch M 1-M 10
774	-	6886, 6887	Nasenkeile	8733	-	7979	Zyl.-Stifte, I-Gew.	1051	-	101	Niete: Schaftdurchmesser
1051	-	660	Niete, Nietstifte	8734	-	6325	Zyl.-Stifte, geh.	1101	-	7184	Form-Lage-Tolerierung
1207	-	84	Zylinderschrauben	8735	-	7979	Zyl.-Stifte, I-Gew.	1891	-	918	MVE: Benennungen
1234	-	94	Splinte	8736	28736	7978	Kegel-Stifte, I-Gew.	2320	-	267-15	TL: MVE Mu. m. Klemmteil
1479	-	7976	Sechsk.-Blechschraben	8737	28737	7977, 258	Zyl.-Stifte, GewZa	2702	-	267-12	TL: MVE Blechschraben
1481	-	7971	Zyl.-Blechschraben	8738	28738	1440	Scheiben f. Bolzen	2768-1...2	-	7168-1, 2	Allgemein-Toleranzen
1482	-	7972	Senk-Blechschraben	8739	-	1470	Zylinderkerbstifte	2859	-	40080	Stichproben-Prüfungen
1483	-	7973	Liko-Blechschraben	8740	-	1473	Zylinderkerbstifte	3269	-	267-5	TL: MVE Annahmeprüfung
1580	-	85	Flachkopfschrauben	8741	-	1474	Steckkerbstifte	3506-1...4	-	267-11	TL: MVE Nichtrostende
2009	-	963	Senkschrauben	8742	-	1475	Knebelkerbstifte	3508	-	76-1	Gew.-Ausläufer/Freistieche
2010	-	964	Linsensenkschrauben	8743	28743	1475	Knebelkerbstifte	4042	-	267-9	TL: galvanische Überzüge
2338	-	7	Zylinderstifte	8744	-	1471	Kegelkerbstifte	4753	-	78	Gew.-Enden/Überstände
2339	22339	1	Kegelstifte	8745	-	1472	Passkerbstifte	4755	-	76-1	Gew.-Ausläufer/Freistieche
2340	22340	1443	Bolzen o. Kopf	8746	-	1476	Halbrundkerbnägel	4757	-	7962	Kreuzschlitze f. Schrb.
2341	22341	1444	Bolzen m. Kopf	8747	-	1477	Senkkerbnägel	4759-1...3	-	267-2, 6, 522	Toleran. Schrb./Mu./Sch.
2342	-	427	Schafschrauben	8748	-	7344	Spiralspannstifte S	6157-1...3	-	267-19	Oberflächenfehler Schrb.
2491	-	6885-3	Passfedern	8750	-	7343	Spiralspannstifte R	6157-2	(493)	267-20, 21	Oberflächenfehler Mu.
2492	-	6883, 6884	Nasen-/Flachkeile	8751	-	7343	Spiralspannstifte L	7085/7500-1	-	-	Gew.-furch. Schrauben
2936	-	911	Stiftschlüssel	8752	-	1481	Spannstifte S	7378	-	962	Splint-/Sicherungslöcher
3912	-	6888	Scheibenfedern	8765	-	960	Sechskant-Schr. FG	7721	-	-	Senkköpfe: Gestaltung
4014	-	931-1	Sechskantschrauben	10509	-	6928	Sechsk.-Flansch-Bls.	8749	-	-	Stifte: Scherversuch
4016	-	601	Sechskantschrauben	10510	-	6901	Kombi-Blechschraben	8839	28839	267-18	TL: MVE Nichtisen-Wst.
4017	-	933	Sechskantschrauben	10511	-	985	Muttern m. Klemmteil	8991	-	962	Bezeichnungssystem MVE
4018	-	558	Sechskantschrauben	10512	-	982, 6924	Muttern m. Klemmteil	8992	-	267-1	TL: Allgem. Anforderungen
4026	-	913	Gew.-Stifte Isk-K	10513	-	980, 6925	Muttern m. Klemmteil	-	10204	50049	Prüfbescheinigungen
4027	-	914	Gew.-Stifte Isk-Sp	10642	-	7991	Isk-Senkschrauben	10484	(493)	267-21	Aufweitversuch Muttern
4028	-	915	Gew.-Stifte Isk-Za	10644	-	6900	Kombi-Schrauben	10644	-	6900-1	Kombi-Schr. Härten
4029	-	916	Gew.-Stifte Isk-Rs	10663	1661	6923	Sechsk.-Flansch-Mu. FG	10664	-	-	Innensechsrund-Antrieb
4032	-	934	Sechsk.-Mu.II, RG	10666	-	7504	Bohrschrauben	10666	-	7504	ME Bohrschrauben
4033	-	934	Sechsk.-Mu.II, RG	10669/10673	-	6903/6902	Scheiben f. Kombischr.	10683	-	10683	Zinklamellen-Überzüge
4034	-	555	Sechskantmuttern	12125	-	6926	Flansch-Mu. m. Klemmteil	10684	-	-	Feuerverzinkung
4035	-	439-2, 936	Sechsk.-Mu.niedrig	12126	-	6927	Flansch-Mu. m. Klemmteil	12683	-	267-10	Mech. Zinkplattierung
4036	-	439-1	Sechsk.-Mu.niedrig	12474	-	912 (FG)	Isk-Zylinderschrauben FG	-	13811	-	Sherardisieren
4161	1661	6923	Sechsk.-Flansch-Mu.	13337	-	7346	Spannstifte I	15065	-	66	Senkungen
4162	1662, 1665	6922	Sechsk.-Flansch-Schr.	13918	-	32500	Bolzen f. B-Schweißen	15330	-	-	Wasserstoffverspr.
4762	-	912	Isk-Zylinderschrauben	14579...587	-	-	Innensechsrund-Schr.	16047	-	946	Reibwertversuch
4766	24766	551	Gewindestifte K	14588, 14589	-	7337	Blindniete, Begriffe	16048	-	-	Passivierung f. Niro-St.
4775	780, 783	6915	HV-Muttern	15071...073	-	-	Flanschschrb. leichte R.	16426	-	-	MVE: QS-System
7040, 7041	-	982, 6924	Muttern m. Klemmteil	15480...483	-	7504	Bohrschrauben	-	-	-	-
7042	-	980, 6925	Muttern m. Klemmteil	15973...986	-	7337	Blindniete	-	-	-	-
7043	1663/1666	6926	Flansch-Mu. m. Klemmteil	16582-585	-	7337	Blindniete	-	-	-	-
7044	1664/1667	6927	Flansch-Mu. m. Klemmteil	21269	-	-	Zyl.schr.lsk FG	-	-	-	-
7045	-	7985	Linsenzyl.-Schr. KS	21670	-	977	Schweißmuttern m. Fl.	-	-	-	-
7046-1, 2	-	965	Senkschrauben KS	68	-	13 T 19	Gew.-Grundprofil	-	-	-	-
7047	-	966	Linsensenkschr. KS	228-1...3	-	259-1...3	Zyl.Ww-Rohrgewinde G	-	-	-	-
7048	-	-	Zylinderschr. KS	261	-	13-12	Auswahl Steigungen RG/FG	-	-	-	-
7049	-	7981	Liko-Blechschr. KS	262	-	13-13	Gew.-Auswahlreihen	-	-	-	-
7050	-	7982	Senk-Blechschr. KS	724	-	13	ISO-Gew.: Grundmaße	-	-	-	-
7051	-	7983	Linsensenk-Bls. KS	965-1...5	-	13-13...15,27	Grundlg./Grenzmaße	-	-	-	-
7053	-	6928	Sechsk.-Bund-Bls.	1478	-	7970	Blechschraben-Gewinde	-	-	-	-
7089	-	125-1,2	Scheiben, R, Form A	1502	-	13-16...18	Gew.-Lehren	-	-	-	-
7090	-	125-1, 2	Scheiben, R, Form B	2901-2904	-	103-1...4	Trapez-Gewinde	-	-	-	-
7091	-	126	Scheiben, Regelauf.	5408	-	2244	Gewinde: Begriffe	-	-	-	-
7092	-	433-1, 2	Scheiben, Reihe klein	6410-1...3	-	27	Gew.-Darstellung i. TZ	-	-	-	-
7093-1, 2	-	9021	Scheiben, Reihe groß	-	-	-	-	-	-	-	-
7094	-	440	Scheiben, extra groß	-	-	-	-	-	-	-	-

Normenarten, Zusammenhänge, Herausgeber:

DIN Nationale deutsche Norm (Deutsches Institut für Normung). DIN-Normen wird es weiterhin geben für die Produkte/Leistungen, für die es auf ISO-/EN-Normungsebene keine Norm gibt und kein Normungsbedarf vorliegt.

ISO Internationale Norm (International Standardization Organisation)

DIN ISO Nationale deutsche Ausgabe einer unverändert übernommenen ISO-Norm

EN Europäische Norm (CEN = Comité Européen de Normalisation) Grundsätzlich sollen vorhandene ISO-Normen unverändert als EN-Normen mit der ISO-Normnummer übernommen werden → EN ISO. Gelingt das auf europäischer Normungsebene nicht, werden eigenständige EN-Normen mit von ISO abweichenden EN-Normnummern erstellt.

DIN EN Nationale deutsche Ausgabe einer unverändert übernommenen EN-Norm.







Nach Beschluss des Europäischen Rates sind EN-Normen unverändert und unverzüglich von den EU-Mitgliedsländern zu übernehmen – und entsprechende nationale Normen zurückzuziehen.

EN ISO Europäische Normausgabe, die unverändert von ISO übernommen wurde (EN- und ISO-Normnummern sind identisch – die frühere Praxis „ISO-Nummer + 20 000“ wird ab 1. 95 nicht mehr angewendet; noch im Umlauf befindliche Normen nach diesem Modus werden entsprechend umgestellt). **Die Bezeichnung erfolgt nach ISO.**

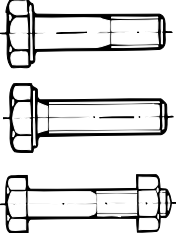
DIN EN ISO Nationale deutsche Ausgabe einer unverändert von ISO übernommenen EN-Norm. Die Artikelbezeichnung (DIN) erfolgt nach ISO!

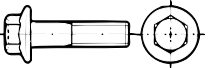
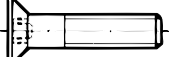
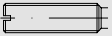
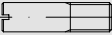
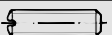
Herausgeber und Urheber der Normen für „Mechanische Verbindungselemente“ ist das DIN Deutsche Institut für Normung e.V., Berlin, www.fmv.din.de Bezug der Normblätter von Beuth Verlag GmbH, Burggrafenstraße 6, 10787 Berlin, www.beuth.de, Fax 030 2601-1260, kundenservice@beuth.de

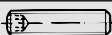
Tabelle 3: Übersicht Normenumstellung DIN → ISO/EN – Schrauben mit Antrieb, Gewindestifte, Schrauben ohne Werkzeugantrieb

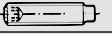
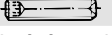
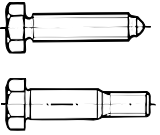
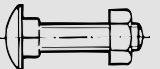
Artikelgruppe	DIN	→ ISO/EN	Abmessungsbereich	Änderungen	Etikettierung ①
1. Schrauben, für die ISO-/EN-Normen vorliegen 	558 931 933 960 961	ISO 4018 ISO 4014 ISO 4017 ISO 8765 ISO 8676	M 10, 12, 14, 22 alle übrigen Ø	neue ISO-Schlüsselweiten (SW) keine = DIN und ISO identisch	ISO-Normnummern 1. ISO-Normnummern 2. DIN-Normnummern
	601 Mu m. Mu DIN 555	ISO 4016 Mu m. Mu ISO 4034	M 10, 12, 14, 22	Schrauben: neue ISO-Schlüsselweiten Muttern: neue ISO-SW + ISO-Höhen	ISO-Normnummer
			übrige Ø bis M 39	Schrauben: keine = DIN und ISO ident. Muttern: neue ISO-Höhen	1. ISO-Normnummern 2. DIN-Normnummern
			übrige Ø über M 39	keine = DIN und ISO identisch	
	6914	EN 14399-4	alle Ø	geänderte Klemmlängenberechnung	EN-Normnummer
	7999	EN 14399-8	alle Ø	Schmierung	
	912	ISO 4762 (RG) ISO 12474 (FG)	alle Ø	keine	1. ISO-Normnummer 2. DIN-Normnummer
	6921	EN 1665 (EN 1662 – leichte Reihe)	alle Ø	geringfügig erhöhte Kopfhöhen und Schlüsselangriffsflächen, Festigkeitsklasse 12.9 gestrichen	ISO-Normnummer
			ab M 10	neue Schlüsselweiten	
	7991	ISO 10642	M 22, M 24	Abmessungen gestrichen	ISO-Normnummer
			alle übrigen Ø	geänderte Kopfhöhen + Kopf Ø- geänderte Schaftlängen	
2. Gewindestifte, für die ISO-/EN-Normen vorliegen					
	417	ISO 7435	alle Ø	keine	1. ISO-Normnummer 2. DIN-Normnummer
	427	ISO 2342	alle Ø	geringfügige Unterschiede in Schlitzgeometrie -> keine Funktionsbeeinträchtigung	
	551	ISO 4766			
	553	ISO 7434	alle Ø	keine	
	913	ISO 4026			
	914	ISO 4027			
	915	ISO 4028			
	916	ISO 4029			
3. Sechskant-Schrauben, für die keine ISO-/EN-Normen vorliegen 	561 564	- -	Ø M 12, 16 alle übrigen Ø	neue ISO-Schlüsselweiten keine	DIN-Normnummern + SW-Angabe DIN-Normnummern
	609 ~ 610	- -	Ø M 10, 12, 14, 22 alle übrigen Ø	neue ISO-Schlüsselweiten keine	DIN-Normnummern + SW-Angabe DIN-Normnummern
	7968 Mu 7990 Mu m. Mu DIN 555	Schraube: - m. Mu ISO 4034	M 12, (22)	Schrauben: neue ISO-Schlüsselweiten Muttern: neue ISO-SW + ISO-Höhen	DIN-Normnummern + SW-Angabe
			alle übrigen Ø	Schrauben: keine Muttern: neue ISO-Höhen	DIN-Normnummern
4. Schrauben ohne Werkzeugantrieb, für die keine ISO-/EN-Normen vorliegen – mit Sechskantmuttern, für die ISO-/EN-Normen vorliegen 	186/261 Mu 525 Mu 529 Mu 603 Mu 604 Mu 605 Mu 607 Mu 608 Mu 7969 Mu 11014 Mu m. Mu DIN 555	Schraube: - m. Mu ISO 4034	Ø M 10, 12, 14, 22	Schrauben: keine Muttern: neue ISO-SW und ISO-Höhen	DIN-Normnummern + SW-Angabe
	alle übrigen Ø		Schrauben: keine Muttern: neue ISO-Höhen	DIN-Normnummern	

① Doppel-Angabe Normnummern ISO und DIN gelten für die Übergangszeit, später nur noch ISO-Angabe.

**Tabelle 4: Übersicht Normenumstellung DIN → ISO/EN – Sechskant-/Vierkant-Muttern
– Sechskant-Muttern mit Klemmteil**

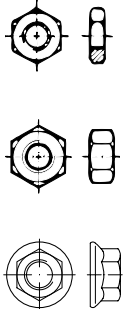
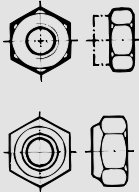
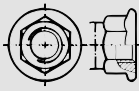
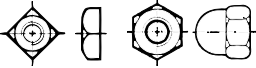
Artikelgruppe	DIN → ISO/EN	Abmessungsbereich ①	Änderungen ①	Etikettierung ②		
1. Sechskant-Muttern, für die ISO-/EN-Normen vorliegen ① 	439-1 (A = ohne Fase) 439-2 (B = mit Fase)	ISO 4036 ISO 4035 = Regel-Gew. ISO 8675 = Fein-Gew.	Ø M 10, 12, 14, 22 alle übrigen Ø	neue ISO-Schlüsselweiten (keine Höhenveränderung) keine = DIN und ISO identisch (keine Höhenveränderung)	ISO-Normnummer 1. ISO-Normnummer 2. DIN-Normnummer	
	555 934 Fkl. 6, 8, 10 Fkl. 12 Fkl. 6, 8, 10	ISO 4034 (ISO-Typ 1) ISO 4032 = Regel-Gew. (ISO-Typ 1) ISO 4033 = Regel-Gew. (ISO-Typ 2) ISO 8673 = Fein-Gew. (ISO-Typ 1)	Ø M 10, 12, 14, 22 übrige Ø M 5 – M 39 Ø unter M 5 Ø über M 39	neue ISO-SW + neue ISO-Höhen neue ISO-Höhen (keine SW-Veränderung) keine = DIN und ISO identisch	ISO-Normnummern 1. ISO-Normnummern 2. DIN-Normnummern	
	6915	EN 14399-4	alle Ø	Oberfläche blank = geschmiert	EN-Normnummern	
	6923	EN 1661	Ø M 10	neue ISO-Schlüsselweiten	EN-Normnummern	
			übrige Ø	keine = DIN und ISO identisch	1. EN-Normnummern 2. DIN-Normnummern	
	2. Sechskant-Muttern mit Klemmteil, für die ISO-/EN-Normen vorliegen ① 	980 6925	ISO 7042 = Regel-Gew. ISO 10513 = Fein-Gew.	Ø M 10, 12, 14, 22	neue ISO-Schlüsselweiten (DIN 6925 beinhaltet schon die neuen ISO-Schlüsselweiten) geänderte Mutterhöhen größere Schlüsselangriffsflächen	ISO-Normnummer
				übrige Ø	geänderte Mutterhöhen größere Schlüsselangriffsflächen	ISO-Normnummer
		982	DIN 6924	Ø M 10, 12, 14, 22	neue ISO-Schlüsselweiten geänderte Mutterhöhen	DIN-Normnummer
				übrige Ø	geänderte Mutterhöhen	DIN-Normnummer
		6924	ISO 7040 = Regel-Gew. ISO 10512 = Fein-Gew.	alle Ø	größerer Toleranzbereich für Mutterhöhen (DIN ↔ ISO austauschbar)	1. ISO-Normnummern 2. DIN-Normnummern
985		ISO 10511	Ø M 10, 12, 14	neue ISO-Schlüsselweiten	ISO-Normnummer	
			übrige Ø	verringerte Mutterhöhen	ISO-Normnummer	
		6926	EN 1663 = Regel-Gew. EN 1666 = Fein-Gew.	Ø M 10	neue ISO-Schlüsselweiten	EN-Normnummer
	übrige Ø			keine (DIN ↔ EN austauschbar)	1. EN-Normnummern 2. DIN-Normnummern	
	6927	EN 1664 = Regel-Gew. EN 1667 = Fein-Gew.	Ø M 10	neue ISO-Schlüsselweiten	EN-Normnummer	
			übrige Ø	keine (DIN ↔ EN austauschbar)	1. EN-Normnummern 2. DIN-Normnummern	
3. Muttern, für die keine ISO-/EN-Normen vorliegen 	557 917 935 986 1587	– – – – –	Ø M 10, 12, 14, 22 alle übrigen Ø	neue ISO-Schlüsselweiten keine	DIN-Normnummern + SW-Angabe DIN-Normnummern	

① Gegenüberstellung Schlüsselweiten und Mutterhöhen DIN : ISO und Zuordnung Normen, mechanische Eigenschaften für Muttern aus Stahl siehe Tabelle 5

② Doppel-Angabe Normnummern ISO und DIN gelten für die Übergangszeit, später nur noch ISO-Angabe.

Tabelle 5: Gegenüberstellung DIN : ISO – Schlüsselweiten für Schrauben und Muttern mit Standard-Schlüsselweiten – Mutternhöhen

Nennmaß d (möglichst zu vermeidende Größen)	Schlüsselweite s		Mutternhöhe m min. – max.				
	DIN	ISO	DIN 555	DIN 4034	DIN 934	ISO 4032 (RG) 8673 (FG) ISO-Typ 1	ISO 4033 (RG) ISO-Typ 2
				ISO-Typ 1			
M 1		2,5	–	–	0,55 – 0,8	–	–
M 1, 2		3	–	–	0,75 – 1	–	–
M 1, 4		3	–	–	0,95 – 1,2	–	–
M 1, 6		3,2	–	–	1,05 – 1,3	1,05 – 1,3	–
M 2		4	–	–	1,35 – 1,6	1,35 – 1,6	–
M 2,5		5	–	–	1,75 – 2	1,75 – 2	–
M 3		5,5	–	–	2,15 – 2,4	2,15 – 2,4	–
(M 3,5)		6	–	–	2,55 – 2,8	2,55 – 2,8	–
M 4		7	–	–	2,9 – 3,2	2,9 – 3,2	–
M 5		8	3,4 – 4,6	4,4 – 5,6	3,7 – 4	4,4 – 4,7	4,8 – 5,1
M 6		10	4,4 – 5,6	4,6 – 6,1	4,7 – 5	4,9 – 5,2	5,4 – 5,7
(M 7)		11	–	–	5,2 – 5,5	–	6,84 – 7,2 *
M 8		13	5,75 – 7,25	6,4 – 7,9	6,14 – 6,5	6,44 – 6,8	7,14 – 7,5
M 10	17	16	7,25 – 8,75	8 – 9,5	7,64 – 8	8,04 – 8,4	8,94 – 9,3
M 12	19	18	9,25 – 10,75	10,4 – 12,2	9,64 – 10	10,37 – 10,8	11,75 – 12
(M 14)	22	21	–	12,1 – 13,9	10,3 – 11	12,1 – 12,8	13,4 – 14,1
M 16		24	12,1 – 13,9	14,1 – 15,9	12,3 – 13	14,1 – 14,8	15,7 – 16,4
(M 18)		27	–	15,1 – 16,9	14,3 – 15	15,1 – 15,8	16,9 – 17,6 *
M 20		30	15,1 – 16,9	16,9 – 19	14,9 – 16	16,9 – 18	19 – 20,3
(M 22)	32	34	17,1 – 18,9	18,1 – 20,2	16,9 – 18	18,1 – 19,4	20,5 – 21,8 *
M 24		36	17,95 – 20,05	20,2 – 22,3	17,7 – 19	20,2 – 21,5	22,6 – 23,9
(M 27)		41	20,95 – 23,05	22,6 – 24,7	20,7 – 22	22,5 – 23,8	25,4 – 26,7 *
M 30		46	22,95 – 25,05	24,3 – 26,4	22,7 – 24	24,3 – 25,6	27,3 – 28,6
(M 33)		50	24,95 – 27,05	27,4 – 29,5	24,7 – 26	27,4 – 28,7	30,9 – 32,5 *
M 36		55	27,95 – 30,05	28 – 31,5	27,4 – 29	29,4 – 31	33,1 – 34,7
(M 39)		60	29,75 – 32,25	31,8 – 34,3	29,4 – 31	31,8 – 33,4	35,9 – 37,5 *
M 42		65	32,75 – 35,25	32,4 – 34,9	32,4 – 34	32,4 – 34	–
(M 45)		70	34,75 – 37,25	34,4 – 36,9	34,4 – 36	34,4 – 36	–
M 48		75	36,75 – 39,25	36,4 – 38,9	36,4 – 38	36,4 – 38	–
(M 52)		80	40,75 – 43,25	40,4 – 42,9	40,4 – 42	40,4 – 42	–
M 56		85	43,75 – 46,25	43,4 – 45,9	43,4 – 45	43,4 – 45	–
(M 60)		90	46,75 – 49,25	46,4 – 48,9	46,4 – 48	46,4 – 48	–
M 64		95	49,5 – 52,5	49,4 – 52,4	49,1 – 51	49,1 – 51	–
Mutternhöhenfaktor		≤ M 4	–	–		0,8	–
Mutternhöhe m Gewinde-Nenndurchmesser M		M 5 – M 39	0,8	0,83 – 1,12	0,8	0,84 – 0,93	0,93 – 1,03
		≥ M 42		~ 0,8		0,8	–
Produktklasse			C (grob)		≤ M 16 = A (mittel) > M 16 = B (mittelgrob)		
Gewinde-Toleranz			7 H		6 H		
Festigkeitsklasse Stahl		Kernbereich ~ M 5 – M 39	5 (M 16 < d ≤ M 39 = 4,5)		6, 8, 10 (ISO 8673 = Fkl. 10 ≤ M 16)		12 (9 – 12)
		≥ M 39	nach Vereinbarung		nach Vereinbarung		–
Mechanische Eigenschaften nach Norm			DIN 267-4	ISO 898-2	DIN 267-4	ISO 898-2 (RG) -6 (FG)	ISO 898-2

Anmerkungen: ISO 4032 = auch Ersatz für DIN 970 – RG = Regel-Gewinde ISO 4034 = auch Ersatz für DIN 972
ISO 8673 = auch Ersatz für DIN 971-1 – FG = Fein-Gewinde ISO 4033 = auch Ersatz für DIN 971-2 (Fein-Gewinde → ISO 8674)

*Werte gemäß Normentwurf ISO 4033:2016-05

Tabelle 6: Gegenüberstellung DIN : ISO – Muttern mit Klemmteil nach DIN 980, DIN 6925, ISO 7042, ISO 10513

Nennmaß d (möglichst zu vermeidende Größen)	Schlüsselweite s		Mutternhöhe h min. – max.		Mindest-Schlüsselangriffsfläche m ² /m _w	
	DIN 980	DIN 6925 ISO 7042 ISO 10513	DIN 980 DIN 6925	ISO 7042 ISO 10513	DIN 980 DIN 6925	ISO 7042 ISO 10513
M 3		5,5	3,4 – 3,7	–	1,65	–
M 4		7	3,9 – 4,2	–	2,2	–
M 5		8	4,8 – 5,1	4,8 – 5,1	2,75	3,52
M 6		10	5,7 – 6,0	5,4 – 6,0	3,3	3,92
(M 7)		11	6,5 – 7,0	–	3,85	–
M 8		13	7,5 – 8,0	7,14 – 8,00	4,4	5,15
M 10	17	16	9 – 10	8,94 – 10,0	5,5	6,43
M 12	19	18	11 – 12	11,57 – 12,00	6,6	8,30
(M 14)	22	21	12 – 14	13,4 – 14,1	7,7	9,68
M 16	24		14 – 16	15,7 – 16,4	8,8	11,28
(M 18)	27		16 – 18	–	9,9	–
M 20	30		18 – 20	19,0 – 20,3	11	13,52
(M 22)	32	–	20 – 22	–	12,2	–
M 24		36	22 – 24	22,6 – 23,9	13,2	16,16
(M 27)		41	25 – 27	–	14,8	–
M 30		46	28 – 30	27,3 – 30,0	16,5	19,44
(M 33)		50	31 – 33	–	18,2	–
M 36		55	34 – 36	33,1 – 36,1	19,8	23,52
(M 39)		60	37 – 39	–	21,5	–

Tabelle 7: Gegenüberstellung DIN : ISO – Muttern mit Klemmteil nach DIN 982, DIN 6924, ISO 7040, ISO 10512

Nennmaß d (möglichst zu vermeidende Größen)	Schlüsselweite s		Mutternhöhe h min. – max.			Mindest-Schlüsselangriffsfläche m ² /m _w	
	DIN 982	DIN 6924 ISO 7040 ISO 10512	DIN 982	DIN 6924	ISO 7040 ISO 10512	DIN 982 DIN 6924	ISO 7040 ISO 10512
M 3		5,5	–	4,2 – 4,5	4,02 – 4,50	1,72	1,72
M 4		7	–	5,7 – 6,0	5,52 – 6,00	2,32	2,32
M 5		8	6,00 – 6,30	6,44 – 6,80	6,22 – 6,80	3,52	3,52
M 6		10	7,70 – 8,00	7,64 – 8,00	7,42 – 8,00	3,92	3,92
(M 7)		11	8,20 – 8,50	8,64 – 9,00	–	4,91	–
M 8		13	9,14 – 9,50	9,14 – 9,50	8,92 – 9,50	5,15	5,15
M 10	17	16	11,14 – 11,50	11,14 – 11,90	11,2 – 11,9	6,43	6,43
M 12	19	18	13,64 – 14,00	14,47 – 14,90	14,2 – 14,9	8,30	8,30
(M 14)	22	21	15,3 – 16,0	16,3 – 17,0	15,9 – 17,0	9,68	9,68
M 16	24		17,3 – 18,0	18,26 – 19,10	17,8 – 19,1	11,28	11,28
(M 18)	27		19,16 – 20,00	19,76 – 20,60	–	12,08	–
M 20	30		20,7 – 22,0	21,5 – 22,8	20,7 – 22,8	13,52	13,52
(M 22)	32	34	23,7 – 25,0	23,2 – 24,5	–	14,48	–
M 24		36	26,7 – 28,0	25,8 – 27,1	25,0 – 27,1	16,16	16,16
(M 27)		41	–	29,4 – 31,0	–	18,00	–
M 30		46	–	31,0 – 32,6	30,1 – 32,6	19,44	19,44
(M 33)		50	–	33,9 – 35,5	–	21,92	–
M 36		55	–	37,3 – 38,9	36,4 – 38,9	23,52	23,52
(M 39)		60	–	40,4 – 42,0	–	25,44	–
M 42		65	–	43,4 – 45,0	–	27,20	–
(M 45)		70	–	46,4 – 48,0	–	28,80	–
M 48		75	–	48,4 – 50,0	–	30,40	–

Tabelle 8: Gegenüberstellung DIN : ISO – Muttern mit Klemmteil nach DIN 985, ISO 10511





Nennmaß d (möglichst zu vermeidende Größen)	Schlüsselweite s		Mutternhöhe h min. – max.		Mindest-Schlüsselangriffsfläche m ² /m _w	
	DIN 985	ISO 10511	DIN 985	ISO 10511	DIN 985	ISO 10511
M 3		5,5	3,7 – 4,0	3,42 – 3,90	1,65	1,24
M 4		7	4,7 – 5,0	4,52 – 5,00	2,2	1,56
M 5		8	4,7 – 5,0	4,52 – 5,00	2,75	1,96
M 6		10	5,7 – 6,0	5,52 – 6,00	3,3	2,32
(M 7)		11	7,14 – 7,50	–	3,85	–
M 8		13	7,64 – 8,00	6,18 – 6,76	4,4	2,96
M 10	17	16	9,64 – 10,0	7,98 – 8,56	5,5	3,76
M 12	19	18	11,57 – 12,00	9,53 – 10,23	6,6	4,56
(M 14)	22	21	13,3 – 14,0	10,22 – 11,32	7,7	5,14
M 16	24		15,3 – 16,0	11,32 – 12,42	8,8	5,94
(M 18)	27		17,66 – 18,50	–	9,9	–
M 20	30		18,7 – 20,0	13,1 – 14,9	11	7,28
(M 22)	32	34	20,7 – 22,0	–	12,2	–
M 24		36	22,7 – 24,0	16,0 – 17,8	13,2	8,72
(M 27)		41	25,7 – 27,0	–	14,8	–
M 30		46	28,7 – 30,0	20,1 – 22,2	16,5	11,12
(M 33)		50	31,4 – 33,0	–	18,2	–
M 36		55	34,4 – 36,0	23,4 – 25,5	19,8	13,52
(M 39)		60	37,4 – 39,0	–	21,5	–
M 42		65	40,4 – 42,0	–	23,1	–
(M 45)		70	43,4 – 45,0	–	24,8	–
M 48		75	46,4 – 48,0	–	26,5	–

Übersicht Normenumstellung DIN → ISO: Bolzen, Stifte, Scheiben für Bolzen

Die wichtigsten Veränderungen sind in der Tabelle 9 aufgeführt. Bei einigen Artikeln sind DIN- und ISO-Ausführungen identisch oder die geringfügigen Veränderungen funktionell kaum relevant, so dass eine Austauschbarkeit möglich ist.

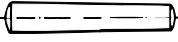
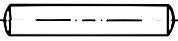
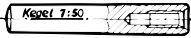
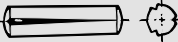
Die Umstellung erfolgt in angemessener Übergangszeit nach Lieferfähigkeit aus der Fertigung oder nach Kundenwunsch. Weitere Informationen auf Anfrage.

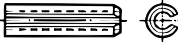
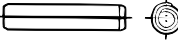
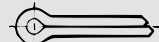
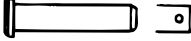
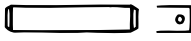
Tabelle 9

Artikelgruppe	DIN	ISO DIN ISO DIN EN ISO	Die wichtigsten Änderungen	
Kegelstifte, Zylinderstifte   	1	2339	Länge l neu nach ISO inkl. Kuppen (bisher nach DIN exkl. Kuppen)	
	7	2338	Länge l neu nach ISO inkl. Kuppen (bisher nach DIN exkl. Kuppen) Formen A, B, C (Form A/Tol. m 6 neu m. Kuppe/Fase)	
	6325	8734	Neu: Form A m. Fase/Kuppe, durchgehärtet (weitgehend identisch mit DIN 6325) Form B mit Fase, einsatzgehärtet	
	7977 7978	8737 8736	Keine gravierenden Änderungen	
	7979/D	8733 8735	DIN 7979/C ~ ISO 8733 [ungehärtet] DIN 7979/D ~ ISO 8735/A [durchgehärtet], Härte bei ISO niedriger	
Kerbstifte, Kerbnägel  	1470 1471 1472 1473 1474 1475	8739 8744 8745 8740 8741 8742	Länge l neu nach ISO inkl. Kuppen (bisher nach DIN exkl. Kuppen)	
	–	8743	Neu: Knebelkerbstifte, halbe Länge gekerbt	
	1476 1477	8746 8747	Form A = keine gravierenden Änderungen Zusätzlich Form B mit Einführende	
	Spannstifte, Spiral-Spannstifte  	1481	8752	Regelausführung bis $\varnothing \leq 8$ mm mit 2 Fasen (bisher bis $\varnothing \leq 6$ mm)
		7343 7344 7346	8750 8748 13337	Keine gravierenden Änderungen
– –		8749 8751	Neu: Stifte, Kerbstifte: Scherversuch Neu: Spiral-Spannstifte, leichte Ausführung	
Splinte 	94	1234	Keine gravierenden Änderungen	
Bolzen  	1443 1444	2340 2341	} Teilweise andere Nennlängen } Längentoleranzen geändert	
	1433 1434 1435 1436	– – – –		Diese DIN-Normen wurden zurückgezogen ISO-Normen sind nicht vorgesehen
	Scheiben für Bolzen 	1440	8738	Einige Außen- \varnothing und Dicken geändert (allgemein nicht austauschgefährdend)
		1441	–	Keine ISO-Norm vorgesehen

Übersicht Normenumstellung DIN → ISO: Gewinde- und Blechschrauben

ISO-Normen für Gewinde- und Blechschrauben enthalten gegenüber DIN-Normen folgende Änderungen:

- neuer Senkwinkel für Blechschrauben mit Senk-/Linsensenkkopf = 90° nach DIN 66/ISO 7721 (bisher 80°)
- Wegfall des Durchmessers ST 3,9 bei Blechschrauben
- teilweise Änderungen der Kopfmaße

Die Tabellen zeigen Normnummernänderung DIN : ISO (Tab. 10) und Kopfmaßänderungen DIN : ISO (Tab. 11–13)

Tabelle 10: Normnummernänderung DIN : ISO

Artikelgruppe	DIN	ISO	Die wichtigsten Änderungen
Gewindeschrauben 	84	1207	keine gravierenden Änderungen
	85	1580	keine gravierenden Änderungen
	963	2009	geringfügige Unterschiede in Kopfhöhe und Kopfdurchmesser (siehe Tabelle 11)
	964	2010	
	965	7046-1, -2	
	966	7047	
Blechschrauben 	7985	7045	keine gravierenden Änderungen
	7971	1481	keine gravierenden Änderungen
	7972	1482	geänderter Senkwinkel (DIN = 80° : ISO = 90°) geringfügige Unterschiede in Kopfhöhe und Kopfdurchmesser (siehe Tabelle 12)
	7973	1483	
	7976	1479	geringfügige Unterschiede in der Kopfhöhe – keine Austauschgefährdung (siehe Tabelle 13)
	7981	7049	keine gravierenden Änderungen
	7982	7050	geänderter Senkwinkel (DIN = 80° : ISO = 90°) geringfügige Unterschiede in Kopfhöhe und Kopfdurchmesser (siehe Tabelle 12)
	7983	7051	

Tabelle 11: Senkschrauben mit Schlitz und Kreuzschlitz mit metrischem Gewinde

		Metrische Schrauben ISO 2009, 2010, 7046, 7047 DIN 963, 964, 965, 966										
		Gewinde	M 1,6	M 2	M 2,5	M 3	M 3,5	M 4	M 5	M 6	M 8	M 10
max. Kopfdurchmesser	ISO (neu)	3	3,8	4,7	5,5	7,3	8,4	9,3	11,3	15,8	18,3	
	DIN (alt)	3	3,8	4,7	5,6	6,5	7,5	9,2	11	14,5	18	
max. Kopfhöhe	ISO (neu)	1	1,2	1,5	1,65	2,35	2,7	2,7	3,3	4,65	5	
	DIN (alt)	0,96	1,2	1,5	1,65	1,93	2,2	2,5	3	4	5	

Tabelle 12: Senkblechschrauben

		Blechschrauben ISO 1482, 1483, 7050, 7051 (↗ = 90°) DIN 7972, 7973, 7982, 7983 (↗ = 80°)									
		ST 2,2	ST 2,9	ST 3,5	ST 3,9	ST 4,2	ST 4,8	ST 5,5	ST 6,3	ST 8	ST 9,5
max. Kopfdurchmesser	ISO (neu)	3,8	5,5	7,3	–	8,4	9,3	10,3	11,3	15,8	18,3
	DIN (alt)	4,3	5,5	6,8	7,5	8,1	9,5	10,8	12,4	–	–
max. Kopfhöhe	ISO (neu)	1,1	1,7	2,35	–	2,6	2,8	3	3,15	4,65	5,25
	DIN (alt)	1,3	1,7	2,1	2,3	2,5	3	3,4	3,8	–	–

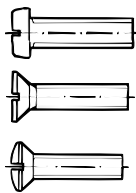
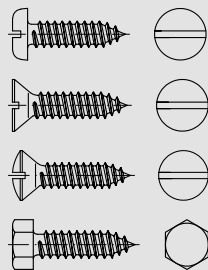
Hinweis für Senkkopfschrauben mit metrischem Gewinde

In Senkungen nach ISO 15065 (für ISO-Senkköpfe) können auch Schrauben nach DIN 963 – 966 eingesetzt werden.

Diese liegen dann lediglich etwas tiefer in der Senkung.

Wird die Senkung nach der zurückgezogenen DIN 74-1:1980 ausgeführt, so bleibt unter Umständen bei der Verwendung von ISO-Senkköpfen ein Überstand über dem Bauteil (insbesondere bei den Durchmessern M 3,5, M 4 und M 8).

Tabelle 13: Sechskant-Blechschrauben

		Blechschrauben ISO 1479 DIN 7976										
		Gewinde	ST 2,2	ST 2,9	ST 3,5	(ST 3,9)	ST 4,2	ST 4,8	(ST 5,5)	ST 6,3	ST 8	ST 9,5
max. Kopfhöhe	ISO (neu)	1,6	2,3	2,6	–	3	3,8	4,1	4,7	6	7,5	
	DIN (alt)	1,42	1,62	2,42	2,42	2,92	3,12	4,15	4,95	5,95	–	



Innensechskant- und Innensechsrundschraben

ISO 4762, 12474

entspricht DIN 912

Zylinderschrauben mit Innensechskant
ISO 12474 mit Feingewinde

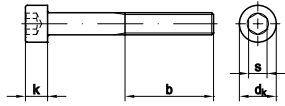

Maße	M 1,4	M 1,6	M 2	M 2,5	M 3	M 4	M 5	M 6	M 8
d _k	2,6	3	3,8	4,5	5,5	7	8,5	10	13
k	1,4	1,6	2	2,5	3	4	5	6	8
s	1,3	1,5	1,5	2	2,5	3	4	5	6
b	14	15	16	17	18	20	22	24	28

Maße	M 10	M 12	M 14	M 16	M 18	M 20	M 22	M 24	M 27
d _k	16	18	21	24	27	30	33	36	40
k	10	12	14	16	18	20	22	24	27
s	8	10	12	14	14	17	17	19	19
b	32	36	40	44	48	52	56	60	66

Maße	M 30	M 33	M 36	M 39*	M 42	M 48	M 56		
d _k	45	50	54	58	63	72	84		
k	30	33	36	39	42	48	56		
s	22	24	27	27	32	36	41		
b	72	78	84	90	96	108	124		

*Abmessung nicht genormt, Richtwerte

Verfügbare Abmessungen auf den folgenden Seiten:

Stahl/Stahl mit Oberfläche: [S. 286](#), [S. 395](#), [S. 115](#) | Edelstahl: [S. 547](#), [S. 477](#)

ISO 14579

Zylinderschrauben mit Innensechsrund

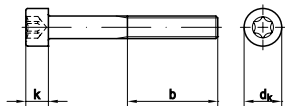

Maße	M 2	M 2,5	M 3	M 4	M 5	M 6	M 8
d _k	3,8	4,5	5,5	7	8,5	10	13
k	2	2,5	3	4	5	6	8
ISR	T6	T8	T10	T20	T25	T30	T45
b	16	17	18	20	22	24	28

Maße	M 10	M 12	M 14	M 16	M 18	M 20	
d _k	16	18	21	24	27	30	
k	10	12	14	16	18	20	
ISR	T50	T55	T60	T70	T80	T90	
b	32	36	40	44	48	52	

Verfügbare Abmessungen auf den folgenden Seiten:

Stahl/Stahl mit Oberfläche: [S. 402](#)

DIN 6912

Zylinderschrauben mit Innensechskant,
niedrigem Kopf und Schlüsselührung

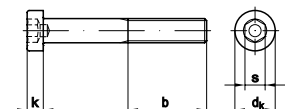

Maße	M 4	M 5	M 6	M 8	M 10	M 12
d _k	7	8,5	10	13	16	18
k	2,8	3,5	4	5	6,5	7,5
s	3	4	5	6	8	10
b ¹	14	16	18	22	26	30
b ²	-	-	-	-	32	36
b ³	-	-	-	-	-	-

Maße	M 14	M 16	M 20	M 24	M 30	M 36
d _k	21	24	30	36	45	54
k	8,5	10	12	14	17,5	21,5
s	12	14	17	19	22	27
b ¹	34	38	46	54	66	78
b ²	40	44	52	60	72	84
b ³	-	57	65	73	85	97

b¹ für l ≤ 125 mm

b² für l ≤ 200 mm

b³ für l > 200 mm

Verfügbare Abmessungen auf den folgenden Seiten:

Stahl/Stahl mit Oberfläche: [S. 317](#) | Edelstahl: [S. 555](#)

Innensechskant- und Innensechsrundschraben

DIN 7984

Zylinderschrauben mit niedrigem Kopf,
Innensechskant oder Innensechsrund

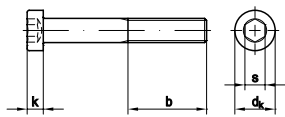

mit Innensechskant

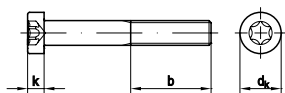

mit Innensechsrund
~ISO 14580

b¹ für l ≤ 125 mm

b² für l ≤ 200 mm

b³ für l > 200 mm

Maße	M 3	M 4	M 5	M 6	M 8
d _k	5,5	7	8,5	10	13
k	2	2,5	3,5	4	5
s	2	2,5	3	4	5
ISR-Größe	T10	T20	T25	T30	T40
b ¹	12	14	16	18	22
b ²	-	-	-	-	28
b ³	-	-	-	-	-

Maße	M 10	M 12	M 16	M 20	M 24
d _k	16	18	24	30	36
k	6	7	9	11	13
s	7	8	12	14	17
ISR-Größe	-	-	-	-	-
b ¹	26	30	38	46	54
b ²	32	36	44	52	60
b ³	-	-	57	65	73

Verfügbare Abmessungen auf den folgenden Seiten:

Stahl/Stahl mit Oberfläche: [S. 362](#) | [Edelstahl: S. 579](#)

ASME B 18.3

Hexagon socket head cap screws*

Zylinderschrauben mit Innensechskant
und zölligem Gewinde

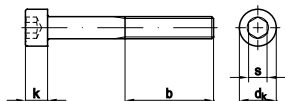

alle Maße in inch,

*nach ASME B 18.3: 2003 Tabelle 1A

Maße	#2	#4	#5	#6	#8	#10	1/4	5/16
d	0,086	0,112	0,125	0,138	0,164	0,190	0,250	0,3125
d _k	0,140	0,183	0,205	0,226	0,270	0,312	0,375	0,469
k	0,086	0,112	0,125	0,138	0,164	0,190	0,250	0,312
s	5/64	3/32	3/32	7/64	9/64	5/32	3/16	1/4
b	0,62	0,75	0,75	0,75	0,88	0,88	1,00	1,12

Maße	3/8	1/2	5/8	7/8	1	1 1/4	1 1/2
d	0,375	0,500	0,625	0,875	1,000	1,250	1,500
d _k	0,562	0,750	0,938	1,312	1,500	1,875	1,250
k	0,375	0,500	0,625	0,875	1,000	1,250	1,500
s	5/16	3/8	1/2	3/4	3/4	7/8	1
b	1,25	1,50	1,75	2,25	2,50	3,12	3,75

Verfügbare Abmessungen auf den folgenden Seiten:

Stahl/Stahl mit Oberfläche: [S. 415](#)

ISO 7379

Passschulter-schrauben

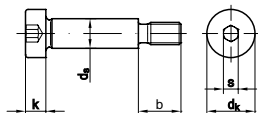

*Passschafftoleranz:

• Stahl h8 oder f9

• Edelstahl f9

**Lagervorrat Ø12, Normwert Ø13

***nicht genormte Abmessung

Maße	M 5	M 6	M 8
d _k	10	13	16
d _s *	6***	8	10
k	4,5	5,5	7
s	3	4	5
b	9,75	11,25	13,25

Maße	M 10	M 12	M 16
d _k	18	24	30
d _s *	12**/13	16	20
k	9	11	14
s	6	8	10
b	16,4	18,4	22,4

Verfügbare Abmessungen auf den folgenden Seiten:

Stahl/Stahl mit Oberfläche: [S. 342](#) | [Edelstahl: S. 572](#)



Innensechskant- und Innensechsrundschauben

ISO 7380 -1/-2

Linsenschrauben mit Innensechskant

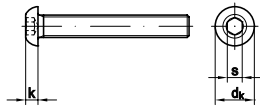

ISO 7380-1

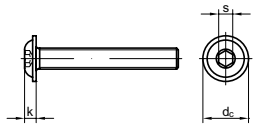

ISO 7380-2

Maße	M 3	M 4	M 5	M 6
$d_{k \text{ max.}}$	5,7	7,6	9,5	10,5
$d_{c \text{ max.}}$	6,9	9,4	11,8	13,6
$k_{\text{max.}}$	1,65	2,2	2,75	3,3
s	2	2,5	3	4

Maße	M 8	M 10	M 12	M 16
$d_{k \text{ max.}}$	14	17,5	21	28
$d_{c \text{ max.}}$	17,8	21,9	26	34
$k_{\text{max.}}$	4,4	5,5	6,6	8,8
s	5	6	8	10

DIN 34805 -1/-2

Linsenschrauben mit Innensechsrund

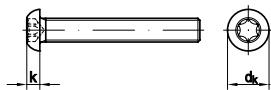

DIN 34805-1



DIN 34805-2

Maße	M 3	M 4	M 5	M 6
$d_{k \text{ max.}}$	5,7	7,6	9,5	10,5
$d_{c \text{ max.}}$	6,9	9,4	11,8	13,6
$k_{\text{max.}}$	1,8	2,45	3	3,3
ISR	10	20	25	30

Maße	M 8	M 10	M 12	M 16
$d_{k \text{ max.}}$	14	17,5	21	-
$d_{c \text{ max.}}$	17,8	21,9	26	-
$k_{\text{max.}}$	4,5	5,5	6,6	-
ISR	45	50	55	-

Verfügbare Abmessungen auf den folgenden Seiten:

Stahl/Stahl mit Oberfläche: [S. 342](#) | [Edelstahl: S. 572](#)

ISO 10642

ersetzt DIN 7991

Senkschrauben mit Innensechskant

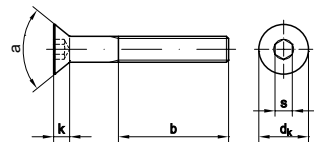

mit Innensechskant

Maße	M 3	M 4	M 5	M 6	M 8	M 10
d_k	6,72	8,96	11,2	13,44	17,92	22,4
$k_{\text{max.}}$	1,86	2,48	3,1	3,72	4,96	6,2
s	2	2,5	3	4	5	6
a	90°	90°	90°	90°	90°	90°
b	18	20	22	24	28	32

Maße	M 12	M 14	M 16	M 20	M 22*	M 24*
d_k	26,88	30,8	33,6	40,32	36	39
$k_{\text{max.}}$	7,44	8,4	8,8	10,16	13,1	14
s	8	10	10	12	14	14
a	90°	90°	90°	90°	60°	60°
b	36	40	44	52	56	60

Maße für Senkungen → DIN 74

*Maße entsprechen der DIN 7991

Verfügbare Abmessungen auf den folgenden Seiten:

Stahl/Stahl mit Oberfläche: [S. 389](#) | [Edelstahl: S. 587](#)



Innensechskant- und Innensechsrundschrauben

ISO 14581

Senkschrauben mit Innensechsrund

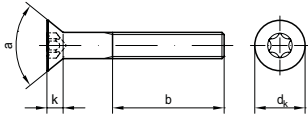

Maße	M 2	M 2,5	M 3	M 4	M 5	M 6	M 8
d_k	4,4	5,5	6,3	9,4	10,4	12,6	17,3
$k_{max.}$	1,2	1,5	1,65	2,7	2,7	3,3	4,65
ISR	6	8	10	20	25	30	45
a	90°	90°	90°	90°	90°	90°	90°
b	25	25	25	38	38	38	38

Maße für Senkungen → DIN 74

Verfügbare Abmessungen auf den folgenden Seiten:

Stahl/Stahl mit Oberfläche: [S. 403](#) | [Edelstahl: S. 589](#)

Außensechskantschrauben

ISO 4014, 8765

Artikel 89601

ersetzt DIN 931, 960, 601

Sechskantschrauben mit Schaft

ISO 8765/DIN 960 mit Feingewinde

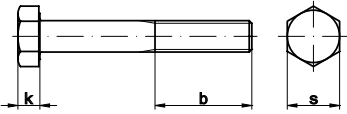

Maße	M 3	M 4	M 5	M 6	M 7	M 8	M 10	M 12	M 14
$S_{ISO/DIN}$	5,5	7	8	10	11	13	16/17	18/19	21/22
k	2	2,8	3,5	4	4,8	5,3	6,4	7,5	8,8
b^1	12	14	16	18	20	22	26	30	34
b^2	-	-	22	24	26	28	32	36	40
b^3	-	-	-	-	-	-	45	49	53

Maße	M 16	M 18	M 20	M 22	M 24	M 27	M 30	M 33	M 36
$S_{ISO/DIN}$	24	27	30	34/32	36	41	46	50	55
k	10	11,5	12,5	14	15	17	18,7	21	22,5
b^1	38	42	46	50	54	60	66	72	78
b^2	44	48	52	56	60	66	72	78	84
b^3	57	61	65	69	73	79	85	91	97

Maße	M 39	M 42	M 45	M 48	M 52	M 56	M 64		
$S_{ISO/DIN}$	60	65	70	75	80	85	95		
k	25	26	28	30	33	35	40		
b^1	84	90	96	102	-	-	-		
b^2	90	96	102	108	116	124	140		
b^3	103	109	115	121	129	137	153		

b^1 für $l \leq 125$ mm

b^2 für $l \leq 200$ mm

b^3 für $l > 200$ mm

Artikel 89601: CE nach EN 14592

(M 12, 16, 20, 24)

Verfügbare Abmessungen auf den folgenden Seiten:

Stahl/Stahl mit Oberfläche: [S. 236](#), [S. 384](#), [S. 143](#), [S. 182](#), [S. 100](#) | [Edelstahl: S. 529](#), [S. 486](#) | [Nichteisen-Werkstoffe: S. 636](#), [S. 625](#)

ISO 4017, 8676

ersetzt DIN 933, 961

Sechskantschrauben mit Gewinde bis Kopf

ISO 8676/DIN 961 mit Feingewinde

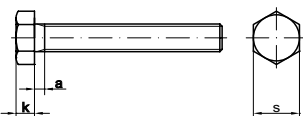

Maße	M 3	M 4	M 5	M 6	M 7	M 8	M 10	M 12
$S_{ISO/DIN}$	5,5	7	8	10	11	13	16/17	18/19
k	2	2,8	3,5	4	4,8	5,3	6,4	7,5
$a_{max.}$	1,5	2,1	2,4	3	3	3,75	4,5	5,25

Maße	M 14	M 16	M 18	M 20	M 22	M 24	M 27	M 30
$S_{ISO/DIN}$	21/22	24	27	30	34/32	36	41	46
k	8,8	10	11,5	12,5	14	15	17	18,7
$a_{max.}$	6	6	7,5	7,5	7,5	9	9	10,5

Maße	M 33	M 36	M 39	M 42	M 45	M 48		
$S_{ISO/DIN}$	50	55	60	65	70	75		
k	21	22,5	25	26	28	30		
$a_{max.}$	10,5	12	12	13,5	13,5	15		

Verfügbare Abmessungen auf den folgenden Seiten:

Stahl/Stahl mit Oberfläche: [S. 254](#), [S. 372](#), [S. 156](#), [S. 184](#) | [Edelstahl: S. 534](#), [S. 490](#) | [Nichteisen-Werkstoffe: S. 636](#), [S. 625](#)



Außensechskantschrauben

ASME B 18.2.1

Hex cap screws
Sechskantschrauben*

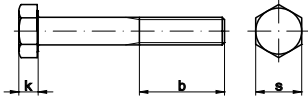

Kurze Abmessung mit Gewinde bis Kopf
Lange Abmessungen mit Schaft

alle Maße in inch,
*nach ASME B 18.2.1: 2010 Tabelle 6,
b¹ für Längen 2 für Längen > 6 inch

Maße	1/4	5/16	3/8	7/16	1/2	5/8
s	7/16	1/2	9/16	5/8	3/4	15/16
k	5/32	13/64	15/64	9/32	5/16	25/64
b ¹	0,750	0,875	1,000	1,125	1,250	1,500
b ²	1,000	1,125	1,250	1,375	1,500	1,750

Maße	3/4	7/8	1	1 1/4	1 1/2	
s	1 1/8	1 5/16	1 1/2	1 7/8	2 1/4	
k	15/32	35/64	39/64	25/32	15/16	
b ¹	1,750	2,000	2,250	2,750	3,250	
b ²	2,000	2,250	2,500	3,000	3,500	

Verfügbare Abmessungen auf den folgenden Seiten:

Stahl/Stahl mit Oberfläche: [S. 410](#), [S. 412](#)

DIN 561, 564

Sechskantschrauben mit kleinem
Sechskant und Zapfen oder Ansatzspitze

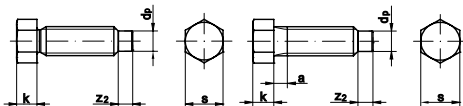

DIN 561 Form A = mit Gewindefreistich
DIN 561 Form B = mit Gewindegewinde

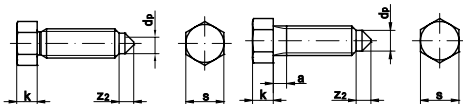

DIN 564 Form A = mit Gewindefreistich
DIN 564 Form B = mit Gewindegewinde

Maße	M 6	M 8	M 10	M 12
k	5	6	7	9
s	8	10	13	16
a (Form B)	2,5	3	4	4
z ₂	3	4	5	6
d _p	4	5,5	7	8,5

Maße	M 16	M 20	M 24	M 30
k	11	14	17	21
s	18	24	30	36
a (Form B)	4,5	6	7	7,5
z ₂	8	10	12	15
d _p	12	15	18	23

Verfügbare Abmessungen auf den folgenden Seiten:

Stahl/Stahl mit Oberfläche: [S. 95](#), [S. 97](#)

DIN 609

Sechskant-Passschrauben
mit langem Gewindezapfen

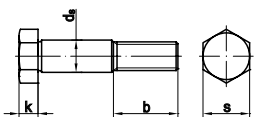

*Passschafftöl. k₆ für Bohrungstöl. H7
b¹ für l ≤ 50 mm
b² für l ≤ 150 mm
b³ für l > 150 mm

Maße	M 8	M 10	M 12	M 14	M 16
k	5,3	6,4	7,5	8,8	10
s	13	16	18	21	24
d _s *	9	11	13	15	17
b ¹	14,5	17,5	20,5	22	25
b ²	16,5	19,5	22,5	24	27
b ³	21,5	24,5	27,5	29	32

Maße	M 20	M 24	M 30	M 36	
k	12,5	15	19	22	
s	30	36	46	55	
d _s *	21	25	32	38	
b ¹	28,5	-	-	-	
b ²	30,5	36,5	43	49	
b ³	35,5	41,5	48	54	

Verfügbare Abmessungen auf den folgenden Seiten:

Stahl/Stahl mit Oberfläche: [S. 107](#)



Außensechskantschrauben

DIN 610

Sechskant-Passschrauben
mit kurzem Gewindezapfen

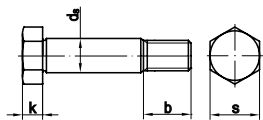

*Passschafftoll. k6 für Bohrungstol. H7

b¹ für l ≤ 50 mm

b² für l ≤ 150 mm

b³ für l > 150 mm

Maße	M 8	M 10	M 12	M 14	M 16
k	5,3	6,4	7,5	8,8	10
s	13	16	18	21	24
d _s *	9	11	13	15	17
b ¹	11,5	13,5	15,5	17	19
b ²	13,5	15,5	17,5	19	21
b ³	18,5	20,5	22,5	24	26

Maße	M 20	M 24	M 30	M 36	
k	12,5	15	19	22	
s	30	36	46	55	
d _s *	21	25	32	38	
b ¹	22,5	25,5	-	-	
b ²	24,5	28,5	34	40	
b ³	29,5	33,5	39	45	

Verfügbare Abmessungen auf den folgenden Seiten:

Stahl/Stahl mit Oberfläche: [S. 108](#)

EN 1665

ersetzt DIN 6921

Sechskantschrauben mit Flansch,
schwere Reihe

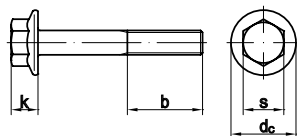

b¹ für l ≤ 125 mm

b² für l ≤ 200 mm

b³ für l > 200 mm

Maße	M 5	M 6	M 8	M 10	M 12	M 16
k _{EN/DIN}	5,8/5,4	6,6/6,6	8,1/8,1	10,4/9,2	11,8/11,5	15,4/14,4
s _{EN/DIN}	8/8	10/10	13/13	16/15	18/16	24/21
d _c	11,58	14,2	18	22,3	26,6	35
b ¹	16	18	22	26	30	38
b ²	-	-	28	32	36	44
b ³	-	-	-	-	-	57

Verfügbare Abmessungen auf den folgenden Seiten:

Stahl/Stahl mit Oberfläche: [S. 223](#), [S. 320](#) | [Edelstahl: S. 521](#), [S. 557](#)

Artikel 10105

Sechskantschrauben mit Flansch,
gemäß MBN 10105

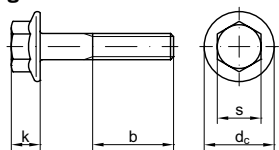

Bis Länge 80 Gewinde bis Kopf

Maße	M 10	M 12 x 1,5	M 14 x 1,5	M 16 x 1,5
k _{max.}	9,2	11,5	12,8	14,4
s	16	18	21	24
d _{c max.}	21,8	26	29,9	34,5
b	80	80	80	80

Verfügbare Abmessungen auf den folgenden Seiten:

Stahl/Stahl mit Oberfläche: [S. 388](#)

~DIN 7964

Schrauben mit dünnem Schaft

Form D1 = Sechskantkopf nach ISO 4014,

mit kurzem Gewinde

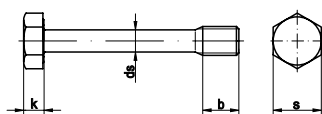

Maße	M 8	M 10
s	13	16
k	5,3	6,4
d _{s min.}	6	7,5
b	10	12,5

Verfügbare Abmessungen auf den folgenden Seiten:

Edelstahl: [S. 574](#)



Stiftschrauben

DIN 835

Stiftschrauben

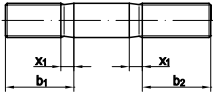

Einschraubende $\approx 2 d$
 b_1 = Einschraubende
 b_2 = Mutterende

b^1 für $l \leq 125$ mm
 b^2 für $l \leq 200$ mm
 b^3 für $l > 200$ mm

Maße	M 6	M 8	M 10	M 12	M 16
b^1	12	16	20	24	32
x_1	2,5	3,2	3,8	4,3	5,0
b_2^1	18	22	26	30	38
b_2^2	24	28	32	36	44
b_2^3	-	-	45	49	57

Verfügbare Abmessungen auf den folgenden Seiten:

Stahl/Stahl mit Oberfläche: [S. 112](#) | [Edelstahl: S. 476](#)

DIN 938, 939

Stiftschrauben

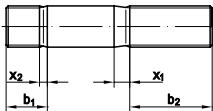

DIN 938 = mit Einschraubende $\approx 1 d$

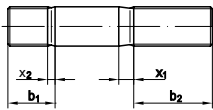

DIN 939 = mit Einschraubende $\approx 1,25 d$

b_1 = Einschraubende
 b_2 = Mutterende

b^1 für $l \leq 125$ mm
 b^2 für $l \leq 200$ mm
 b^3 für $l > 200$ mm

Maße	M 5	M 6	M 8	M 10	M 12	M 14
b_1 (DIN 938)	5	6	8	10	12	14
b_1 (DIN 939)	6,5	7,5	10	12	15	18
x_1	2	2,5	3,2	3,8	4,3	5
x_2	1	1,25	1,6	1,9	2,2	2,5
b_2^1	16	18	22	26	30	34
b_2^2	22	24	28	32	36	40
b_2^3	-	-	-	45	49	53

Maße	M 16	M 20	M 24	M 27	M 30
b_1 (DIN 938)	16	20	24	27	30
b_1 (DIN 939)	20	25	30	35	38
x_1	5	6,3	7,5	7,5	9
x_2	2,5	3,2	3,8	3,8	4,5
b_2^1	38	46	54	60	66
b_2^2	44	53	60	66	72
b_2^3	57	65	73	79	85

Verfügbare Abmessungen auf den folgenden Seiten:

Stahl/Stahl mit Oberfläche: [S. 177, S. 179](#) | [Edelstahl: S. 498, S. 499](#)

DIN 2510

Schraubenbolzen mit Dehnschaft

Form L = mit langem Gewinde

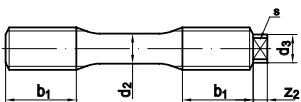

Maße	M 12	M 16	M 20	M 22	M 24
d_2	8,5	12	15	16,5	18
d_3	8	12	14	14	14
b^1	20	23	28	30	32
z_2	4	5	6	6	6
s	7	10	11	11	11

Maße	M 27	M 30	M 33	M 36	M 39
d_2	20,5	23	25,5	27,5	30,5
d_3	18	18	25	25	28
b^1	35	39	42	45	48
z_2	6	6	9	9	10
s	13	13	22	22	24

Verfügbare Abmessungen auf den folgenden Seiten:

Stahl/Stahl mit Oberfläche: [S. 232](#)



Gewindestifte

ISO 2342

entspricht DIN 427

Gewindestifte mit Schlitz und Schaft

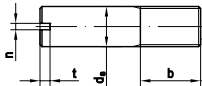

Maße	M 3	M 4	M 5	M 6
d_s	3	4	5	6
b^*	3,6	4,8	6	7,2
n	0,4	0,6	0,8	1
t	0,8	1,12	1,28	1,6

Maße	M 8	M 10	M 12
d_s	8	10	12
b^*	9,6	12	14
n	1,2	1,6	2
t	2	2,4	2,8

Verfügbare Abmessungen auf den folgenden Seiten:

Stahl/Stahl mit Oberfläche: [S. 232, S. 79](#) | [Edelstahl: S. 527, S. 465](#)

ISO 7435

entspricht DIN 417

Gewindestifte mit Schlitz und Zapfen

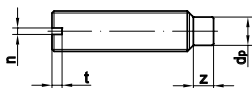

Maße	M 3	M 4	M 5	M 6
d_p	2	2,5	3,5	4
z	1,5	2	2,5	3
n	0,4	0,6	0,8	1
t	0,8	0,96	1,12	1,28

Maße	M 8	M 10	M 12
d_p	5,5	7	8,5
z	4	5	6
n	1,2	1,6	2
t	1,6	2	2,4

Verfügbare Abmessungen auf den folgenden Seiten:

Stahl/Stahl mit Oberfläche: [S. 345, S. 79](#)

ISO 4766

entspricht DIN 551

Gewindestifte mit Kegelkuppe und Schlitz

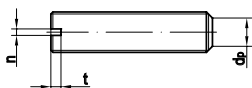

Maße	M 1,6	M 2	M 2,5	M 3	M 4
n	0,25	0,25	0,4	0,4	0,6
t	0,56	0,64	0,72	0,8	1,12
d_p	0,8	1	1,5	2	2,5

Maße	M 5	M 6	M 8	M 10	M 12*
n	0,8	1	1,2	1,6	2
t	1,28	1,6	2	2,4	2,8
d_p	3,5	4	5,5	7	8,5

*Abmaße nach DIN 551: 1956-04

Verfügbare Abmessungen auf den folgenden Seiten:

Stahl/Stahl mit Oberfläche: [S. 305, S. 93](#) | [Edelstahl: S. 552, S. 470](#) | [Nichteisen-Werkstoffe: S. 638, S. 620](#)

ISO 7434

entspricht DIN 553

Gewindestifte mit Schlitz und Spitze



Maße	M 1,6	M 2	M 2,5	M 3	M 4
n	0,25	0,25	0,4	0,4	0,6
t	0,56	0,64	0,72	0,8	1,12
$d_{t \max.}$	0,16	0,2	0,25	0,3	0,4

Maße	M 5	M 6	M 8	M 10
n	0,8	1	1,2	1,6
t	1,28	1,6	2	2,4
$d_{t \max.}$	0,5	1,5	2	2,5

Verfügbare Abmessungen auf den folgenden Seiten:

Stahl/Stahl mit Oberfläche: [S. 345, S. 94](#) | [Edelstahl: S. 573, S. 471](#) | [Nichteisen-Werkstoffe: S. 641, S. 621](#)



Gewindestifte

ISO 4026, 4027

entspricht DIN 913, 914

Gewindestifte mit Innensechskant, mit Kegelstumpf oder abgeflachter Spitze
nur für Druckbelastung geeignet, Härteklasse 45H

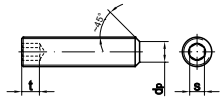

ISO 4026, DIN 913 = mit Kegelstumpf

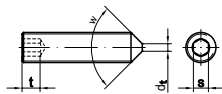

ISO 4027, DIN 914 = mit abgeflachter Spitze

t_1 für oberhalb der gestrichelten Stufenlinie mit Winkel $W_{DIN\ 914} = 120^\circ$
 t_2 für unterhalb der gestrichelten Stufenlinie mit Winkel $W_{DIN\ 914} = 90^\circ$

→ Stufenlinie siehe Produktnorm

Verfügbare Abmessungen auf den folgenden Seiten:

Stahl/Stahl mit Oberfläche: [S. 272](#), [S. 274](#), [S. 134](#), [S. 137](#) | **Edelstahl:** [S. 541](#), [S. 542](#), [S. 481](#), [S. 482](#)

Maße	M 1,6	M 2	M 2,5	M 3	M 4
s	0,7	0,9	1,3	1,5	2
$d_{p\ max.}/d_{t\ max.}$	0,8	1	1,5	2	2,5
t_1	0,7	0,8	1,2	1,2	1,5
t_2	0,5	0,7	2	2	2,5

Maße	M 5	M 6	M 8	M 10	M 12
s	2,5	3	4	5	6
$d_{p\ max.}/d_{t\ max.}$	3,5	4	5,5	7	8,5
t_1	2	2	3	4	4,8
t_2	3	3,5	5	6	8

Maße	M 14	M 16	M 20	M 24
s	6	8	10	12
$d_{p\ max.}/d_{t\ max.}$	10	12	15	18
t_1	5,6	6,4	8	10
t_2	9	10	12	15

ISO 4028

entspricht DIN 915

Gewindestifte mit Innensechskant und Zapfen

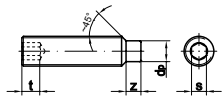

z_1 und t_1 für I oberhalb der gestrichelten Stufenlinie
 z_2 und t_2 für I unterhalb der gestrichelten Stufenlinie

→ Stufenlinie siehe Produktnorm

* Maße entsprechen der DIN 915

Maße	M 2*	M 3	M 4	M 5	M 6	M 8
s	0,9	1,5	2	2,5	3	4
$z_1\ max. (kurz)$	0,75	1	1,25	1,5	1,75	2,25
t_1	0,8	1,2	1,5	2	2	3
d_p	1	2	2,5	3,5	4	5,5
$z_2\ max. (lang)$	1,25	1,75	2,25	2,75	3,25	4,3
t_2	1,7	2	2,5	3	3,5	5

Maße	M 10	M 12	M 14	M 16	M 20	M 24
s	5	6	6	8	10	12
$z_1\ max. (kurz)$	2,75	3,25	3,8	4,3	5,3	6,3
t_1	4	4,8	5,6	6,4	8	10
d_p	7	8,5	10	12	15	18
$z_2\ max. (lang)$	5,3	6,3	7,36	8,36	10,36	12,43
t_2	6	8	9	10	12	15

Verfügbare Abmessungen auf den folgenden Seiten:

Stahl/Stahl mit Oberfläche: [S. 275](#), [S. 138](#) | **Edelstahl:** [S. 543](#), [S. 483](#)



Gewindestifte

ISO 4029

entspricht DIN 916

Gewindestifte mit Innensechskant
und Ringschneide

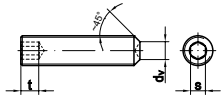

t_1 für I oberhalb der gestrichelten Stufenlinie
 t_2 für I unterhalb der gestrichelten Stufenlinie

→ Stufenlinie siehe Produktnorm

Verfügbare Abmessungen auf den folgenden Seiten:

Stahl/Stahl mit Oberfläche: [S. 277, S. 139](#) | **Edelstahl:** [S. 543, S. 484](#)

Maße	M 2	M 2,5	M 3	M 4	M 5	M 6	M 8
s	0,9	1,3	1,5	2	2,5	3	4
$d_{v \max.}$	1	1,2	1,4	2	2,5	3	5
t_1	0,8	1,2	1,2	1,5	2	2	3
t_2	1,7	2	2	2,5	3	3,5	5

Maße	M 10	M 12	M 14	M 16	M 20	M 24
s	5	6	6	8	10	12
$d_{v \max.}$	6	8	9	10	14	16
t_1	4	4,8	5,6	6,4	8	10
t_2	6	8	9	10	12	15



Verschlusschrauben

DIN 906

Verschlusschrauben mit Innensechskant und kegeligem Gewinde

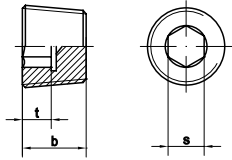

Maße	M 8	M 10	M 12	M 14	M 16	M 18	M 20	M 22	M 24
s	4	5	6	7	8	8	10	10	12
t _{min.}	4	4	5	5	5	5	5	5	6
b*	8	8	10	10	10	10	10	10	12
Maße	M 26	M 27	M 30	M 33	M 36	M 38	M 42	R 1/8	R 1/4
s	12	12	17	17	19	19	22	5	7
t _{min.}	6	6	6	6	7,5	7,5	11,5	4	5
b*	12	12	12	12	15	15	18	8	10
Maße	R 3/8	R 1/2	R 3/4	R 1	R 1 1/4	R 1 1/2	R 1 3/4	R 2	
s	8	10	12	17	22	24	32	32	
t _{min.}	5	5	6	6	11,5	11,5	13	13	
b*	10	10	12	12	18	20	22	22	

Verfügbare Abmessungen auf den folgenden Seiten:

Stahl/Stahl mit Oberfläche: [S. 112](#) | Edelstahl: [S. 476](#) | Nichteisen-Werkstoffe: [S. 624](#)

DIN 908

Verschlusschrauben mit Bund, Innensechskant und zylindrischem Gewinde

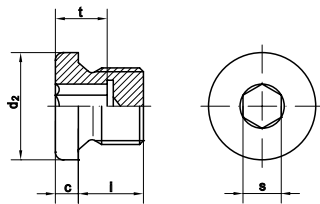

Maße	M 8x1*	M 10x1	M 12x1,5	M 14x1,5	M 16x1,5	M 18x1,5	M 20x1,5
s	5	5	6	6	8	8	10
t _{min.}	2,4	5	7	7	7,5	7,5	7,5
d ₂	12	14	17	19	21	23	25
c	3	3	3	4	3	4	4
i	8	8	12	12	12	12	14
Maße	M 22x1,5	M 24x1,5	M 26x1,5	M 27x2	M 30x1,5	M 30x2	M 33x2
s	10	12	12	12	17	17	17
t _{min.}	7,5	7,5	9	9	9	9	9
d ₂	27	29	31	32	36	36	39
c	4	4	4	4	4	4	5
i	14	14	16	16	16	16	16
Maße	M 36x1,5	M 36x2	M 38x1,5	M 42x1,5	M 45x1,5	M 48x1,5	M 52x1,5
s	19	19	19	22	22	24	24
t _{min.}	10,5	10,5	10,5	10,5	10,5	10,5	10,5
d ₂	42	42	42	49	52	55	60
c	5	5	5	5	5	5	5
i	16	16	16	16	16	16	16
Maße	M 52x2	M 56x2	M 64x2	G 1/8 A	G 1/4 A	G 3/8 A	G 1/2 A
s	32	32	32	5	6	8	10
t _{min.}	10,5	14	14	5	7	7,5	7,5
d ₂	64	72	72	14	18	22	26
c	5	5	5	3	3	3	4
i	16	20	20	8	12	12	14
Maße	G 3/4 A	G 1 A	G 1 1/8 A	G 1 1/4 A	G 1 1/2 A	G 1 3/4 A	G 2 A
s	12	17	19	22	24	32	32
t _{min.}	9	9	10,5	10,5	10,5	14	14
d ₂	32	39	44	49	55	62	68
c	4	5	5	5	5	5	5
i	16	16	16	16	16	20	20

*Abmessung nicht genormt, Richtwerte

Verfügbare Abmessungen auf den folgenden Seiten:

Stahl/Stahl mit Oberfläche: [S. 113](#) | Edelstahl: [S. 476](#) | Nichteisen-Werkstoffe: [S. 624](#)



Verschlusschrauben

DIN 909

Verschlusschrauben mit Außensechskant und kegeligem Gewinde

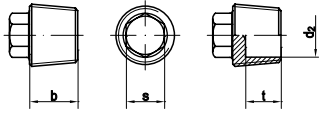

Maße	M 16x1,5	M 18x1,5	M 24x1,5	M 30x1,5	R 1/8
b*	10	10	12	12	8
d ₂	-	-	16	20	-
s	10	10	17	19	7
t	-	-	7	7	-
Maße	R 1/4	R 3/8	R 1/2	R 3/4	R 1
b*	10	10	10	12	12
d ₂	-	-	12	16	23
s	9	10	13	17	19
t	-	-	6	7	7

Verfügbare Abmessungen auf den folgenden Seiten:

Stahl/Stahl mit Oberfläche: [S. 113](#)

DIN 910

Verschlusschrauben mit Bund, schwere Ausführung, mit Außensechskant und zylindrischem Gewinde

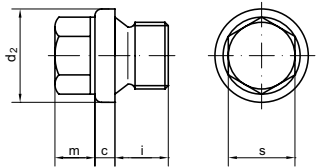

Maße	M 8x1*	M 10x1	M 12x1,5	M 14x1,5	M 16x1,5	M 18x1,5	M 20x1,5	M 22x1,5
c	3	3	3	3	3	4	4	4
d ₂	14	14	17	19	21	23	25	27
m	6	6	6	6	6	6	8	8
s	10	10	13	13	17	17	19	19
i	8	8	12	12	12	12	14	14
Maße	M 24x1,5	M 26x1,5	M 27x2	M 30x1,5	M 30x2	M 33x2	M 36x1,5	M 36x2
c	4	4	4	4	4	5	5	5
d ₂	29	31	32	36	36	39	42	42
m	9	10	10	10	10	11	11	11
s	22	24	24	24	24	27	27	27
i	14	16	16	16	16	16	16	16
Maße	M 38x1,5	M 42x1,5	M 42x2	M 45x1,5	M 45x2	M 48x1,5	M 48x2	M 52x1,5
c	4	5	5	5	5	5	5	5
d ₂	44	49	49	55	52	55	55	60
m	11	12	12	12	12	12	12	12
s	27	30	30	30	30	36	30	30
i	16	16	16	16	16	16	16	16
Maße	M 56x2	M 64x2	G 1/8 A	G 1/4 A	G 3/8 A	G 1/2 A	G 5/8 A*	G 3/4 A
c	5	5	3	3	3	4	4	4
d ₂	64	72	14	18	22	26	28	32
m	15	15	6	6	6	8	8	10
s	36	36	10	13	17	19	22	24
i	20	20	8	12	12	14	14	16
Maße	G 7/8 A*	G 1 A	G 1 1/8 A	G 1 1/4 A	G 1 1/2 A	G 1 3/4 A	G 2 A	
c	4	5	4	5	5	5	5	
d ₂	36	39	44	49	55	62	68	
m	10	11	11	12	12	15	15	
s	24	27	27	30	30	36	36	
i	14	16	16	16	16	20	20	

*Abmessung nicht genormt, Richtwerte

Verfügbare Abmessungen auf den folgenden Seiten:

Stahl/Stahl mit Oberfläche: [S. 114](#) | [Edelstahl: S. 476](#) | [Nichteisen-Werkstoffe: S. 624](#)



Verschlusschrauben

DIN 5586

Verschlusschrauben mit Bund und Entlüftung

Form B = mit aufgeschmolzener Dichtung

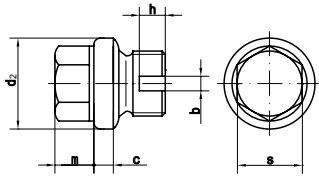

Maße	G 1/8 A	G 1/4 A	G 1/2 A	G 3/4 A	G 1 A	G 1 1/2 A	G 2 A
a	4	6	7	7	7	7	7
h	3	3	4	6	6	6	6
h	5	7	8	10	10	10	10
c	3	3	4	4	5	5	5
d ₂	14	18	26	32	39	55	68
m	8	6	8	10	11	12	15

Verfügbare Abmessungen auf den folgenden Seiten:

Stahl/Stahl mit Oberfläche: [S. 306](#)

DIN 7604

Verschlusschrauben mit Bund und Außensechskant, leichte Ausführung, mit zylindrischem Feingewinde

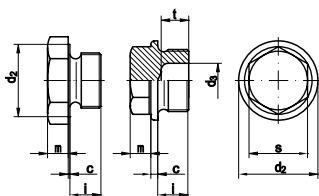

≤M 16 ≥M 18

Form A = kurzer Einschraubzapfen

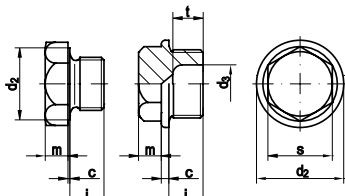

≤M 16 ≥M 18

Form C = langer Einschraubzapfen

Maße	M 8x1	M 10x1	M 12x1,5	M 14x1,5	M 16x1,5	M 18x1,5
c	0,5	0,5	0,5	0,5	0,5	2
d ₂	12	14	17	19	21	23
d ₃	-	-	-	-	-	10
i _{Form A/Form C}	-/8	6/8	9	9/-	9/-	9/-
l _{Form A/Form C}	- / 12,5	10,5 / 12,5	15,5	15,5 / -	15,5 / -	17 / -
m	4	4	6	6	6	6
s	12	14	17	19	22	17
t _{Form A/Form C}	-	-	-	-	-	8 / -

Maße	M 22x1,5	M 26x1,5	M 30x1,5	M 38x1,5	M 45x1,5	M 52x1,5
c	2	2,5	2,5	3	3	3
d ₂	27	31	36	44	52	60
d ₃	14	16	20	26	32	38
i _{Form A/Form C}	9/-	9/12	9/12	-/12	-/12	-/12
l _{Form A/Form C}	17 / -	19,5 / 22,5	19,5 / 22,5	- / 23	- / 23	- / 23
m	6	8	8	8	8	8
s	19	22	22	22	24	27
t _{Form A/Form C}	8 / -	8 / 10	8 / 10	- / 10	- / 10	- / 10

Verfügbare Abmessungen auf den folgenden Seiten:

Stahl/Stahl mit Oberfläche: [S. 351](#) | [Edelstahl: S. 574](#)



Schmiernippel

DIN 3404

Flachschmiernippel

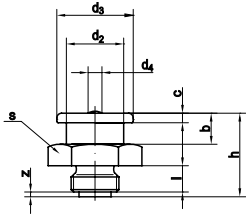

Maße	M 6x1	M 6x1	M 8x1	M 8x1	M 10x1
b	4,8	6,5	4,8	6,5	6,5
c	1,7	2,0	1,7	2,0	2,0
d ₂	7,2	12	7,2	12	12
d ₃	10	16	10	16	16
d ₄	1,5	1,5	2,5	2,5	2,9
h _{max.}	13	17	13,7	16,7	17,6
l	4,9	5,3	4,9	5,3	5,5
s	11	17	11	17	17
z _{max.}	0,6	0,8	0,6	0,8	1,0

Maße	M 16x1,5	G 1/4	G 1/4	G 3/8
b	8,5	6,5	8,5	8,5
c	3,0	2,0	3,0	3,0
d ₂	18	12	18	18
d ₃	22	16	22	22
d ₄	5,0	2,9	5,0	5,0
h _{max.}	23,1	16	22	22
l	7,5	5,5	7,5	7,5
s	22	17	22	22
z _{max.}	1,5	1	1,5	1,5

Verfügbare Abmessungen auf den folgenden Seiten:

Stahl/Stahl mit Oberfläche: [S. 234](#) | Nichteisen-Werkstoffe: [S. 636](#)

DIN 3405

Trichter-Schmiernippel

Form A = mit Gewinde nach DIN 13-5

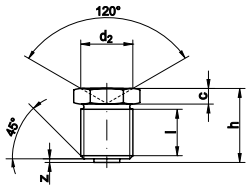

Maße	M 6x1	M 8x1
h _{max.}	9,5	9,5
l	5,5	5,5
d ₂	6	8
c	3	3
s	7	9
z _{max.}	0,7	0,7

Verfügbare Abmessungen auf den folgenden Seiten:

Stahl/Stahl mit Oberfläche: [S. 235](#)

DIN 71412

Kegelschmiernippel kurz, mit Sechskant

Form A = Kegelkopf gerade/axial

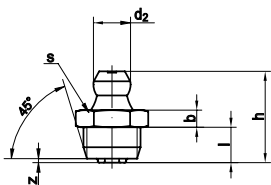

Maße	M 6x1	M 6x1	M 8x1	AR 1/8	M 10x1	AR 1/4
h _{max.}	16	16	16	16	16	16
l	5,5	5,5	5,5	5,5	5,5	5,5
d ₂	6,5	6,5	6,5	6,5	6,5	6,5
b*	3	3	3	3	3	3
s	7	9	9	11	11	14
z _{max.}	0,7	0,7	0,7	0,7	0,7	0,7

Verfügbare Abmessungen auf den folgenden Seiten:

Stahl/Stahl mit Oberfläche: [S. 409](#) | Edelstahl: [S. 592](#)



Schmiernippel

DIN 71412

**Kegelschmiernippel kurz,
mit Sechskant oder Vierkant**
Form B = Kegelpf 45° abgewinkelt

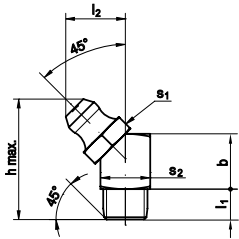

Maße	M 6x1	M 8x1	M 10x1
$h_{\max. \text{Vierkant}}$	21	21	21
l_1	5,5	5,5	5,5
l_2	10	10	11
b	10	10	10
s_1	7	9	11
$s_2 \text{ Vierkant}$	9	9	11

Verfügbare Abmessungen auf den folgenden Seiten:

Stahl/Stahl mit Oberfläche: [S. 409](#)

DIN 71412

**Kegelschmiernippel kurz,
mit Sechskant oder Vierkant**
Form C = Kegelpf 90° abgewinkelt

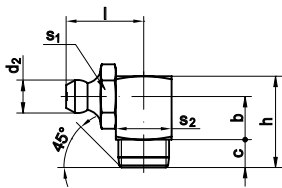

Maße	M 6x1	M 8x1	M 8x1,5*	M 10x1
$h_{\max. \text{Vierkant}}$	18	18	18	18
c	5,5	5,5	5,5	5,5
d_2	6,5	6,5	6,5	6,5
b	8,5	8,5	8,5	8,5
s_1	9	9	9	11
$s_2 \text{ Vierkant}$	9	9	9	11
l	14,3	14,3	14,3	15,3

*Zwischengrößen nicht in der Norm
enthalten

Verfügbare Abmessungen auf den folgenden Seiten:

Stahl/Stahl mit Oberfläche: [S. 409](#)

Diebstahlhemmende Schrauben

Artikel 88116

**Diebstahlhemmende Schrauben
mit Flachrundkopf, metrischem Gewinde**
ähnlich ISO 7380

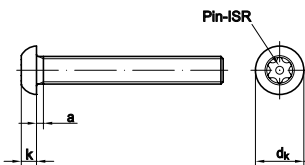

Maße	M 3	M 4	M 5	M 6	M 8	M 10
d_k	5,7	7,6	9,5	10,5	14	17,5
$a_{\min.}$	0,5	0,7	0,8	1	1,25	1,5
$k_{\min.}$	1,4	1,95	2,5	3	4,1	5,2
PIN-ISR-Größe	T10	T20	T25	T30	T40	T45

Verfügbare Abmessungen auf den folgenden Seiten:

Edelstahl: [S. 598](#)



Diebstahlhemmende Schrauben

Artikel 88111

Diebstahlhemmende Schrauben mit Linsenkopf, metrischem Gewinde und Zweiloch-Antrieb ("Snake Eyes") ähnlich DIN 85

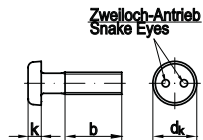

Maße	M 3	M 4	M 5	M 6
$b_{min.}$	25	38	38	38
d_k	6	8	10	12
k	1,8	2,4	3	3,6

Verfügbare Abmessungen auf den folgenden Seiten:

Edelstahl: [S. 596](#)

Artikel 88112

Diebstahlhemmende Schrauben mit Senkkopf, metrischem Gewinde und Zweiloch-Antrieb ("Snake Eyes") ähnlich DIN 963

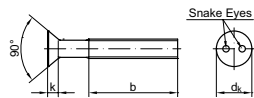

Maße	M 3	M 4	M 5	M 6
$b_{min.}$	19	22	25	28
d_k	5,6	7,5	9,2	11
k	1,65	2,2	2,5	3

Verfügbare Abmessungen auf den folgenden Seiten:

Edelstahl: [S. 596](#)

Artikel 88113

Diebstahlhemmende Schrauben mit Flachrundkopf, metrischem Gewinde und Innensechskant mit Zapfen ähnlich ISO 7380

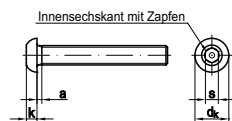

Maße	M 3	M 4	M 5	M 6	M 8	M 10	M 12
$a_{min.}$	0,5	0,7	0,8	1	1,25	1,5	1,75
$d_{k max.}$	5,7	7,6	9,5	10,5	14	17,5	21
$k_{min.}$	1,4	1,95	2,5	3	4,1	5,2	6,24
s	2	2,5	3	4	5	6	8

Verfügbare Abmessungen auf den folgenden Seiten:

Edelstahl: [S. 597](#)

Artikel 88117

Diebstahlhemmende Schrauben mit metrischem Gewinde und Pin-ISR-Antrieb ähnlich ISO 10642

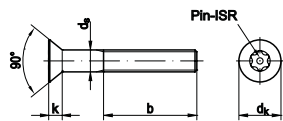

b_1 für $l \leq 125$ mm

b_2 für 125 mm, b_3 für > 200 mm

Maße	M 3	M 3,5	M 4	M 5	M 6	M 8	M 10
$d_{k max.}$	6	7	8	10	12	16	20
$a_{min.}$	0,5	0,6	0,7	0,8	1	1,25	1,5
$k_{max.}$	1,7	2	2,3	2,8	3,3	4,4	5,5
ISR-Größe	T10	T15	T20	T25	T30	T40	T45
b_1	12	12	14	16	18	22	26
b_2	-	-	-	-	24	28	32
b_3	-	-	-	-	-	-	45

Verfügbare Abmessungen auf den folgenden Seiten:

Edelstahl: [S. 598](#)



Sicherungsschrauben

Artikel 88912

RIPP-Schrauben mit Flansch und Innensechskant

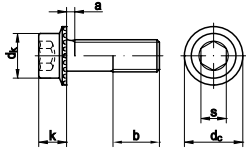

Maße	M 5	M 6	M 8	M 10	M 12
$a_{max.}$	2,4	3	3,7	4,5	5,2
b	22	24	28	32	36
d_c	11	13,5	17	19,5	22,5
d_k	9	11	14	17	19
k	5	6	8	10	12
s	4	5	6	8	10
Anz. Rippen	28	36	48	60	72

Verfügbare Abmessungen auf den folgenden Seiten:

Stahl/Stahl mit Oberfläche: [S. 438](#)

Artikel 88913

RIPP-Schrauben mit Flansch und Sechskant

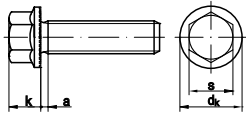

Maße	M 5	M 6	M 8	M 10	M 12	M 14	M 16
$a_{max.}$	1,6	2	2,5	3	3,5	4	4
d_k	11,2	14,2	18,2	21	24	27,5	31
k	4,3	5,5	7	8,5	10	12	14
s	8	10	13	15	17	19	22
Anz. Rippen	28	36	48	48	60	60	72

Verfügbare Abmessungen auf den folgenden Seiten:

Stahl/Stahl mit Oberfläche: [S. 438](#)

Artikel 88933

Sperrzahnschrauben mit Flansch und Sechskant

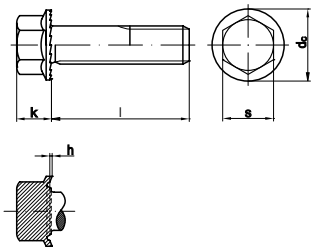

Maße	M 5	M 6	M 8	M 10	M 12	M 16
d_c	11,2	14,25	18,25	21	24	31
$h_{min.}$	0,15	0,17	0,2	0,25	0,25	0,28
k	4,3	5,5	7	7,9	8,7	11,2
s	8	10	13	15	17	22
Anz. Zähne	24	24	24	24	24	24

Verfügbare Abmessungen auf den folgenden Seiten:

Stahl/Stahl mit Oberfläche: [S. 441](#)



Sonstige Schrauben mit Maschinengewinde

DIN 186, 261

Hammerschrauben

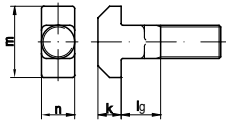

DIN 186
Form B = mit Vierkant und langem Gewinde

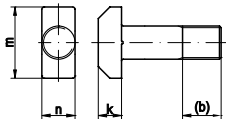

DIN 261
b¹ für l ≤ 125 mm
b² für l ≤ 200 mm

Maße	M 6	M 8	M 10	M 12
m	16	18	21	26
n	6	8	10	12
k	4,5	5,5	7	8
l _g (186 B)	10	13	16	19
b ₁	18	22	26	30
b ₂	-	-	-	-

Maße	M 16	M 20	M 24
m	30	36	43
n	16	20	24
k	10,5	13	15
l _g (186 B)	25	31	37
b ₁	38	46	54
b ₂	44	52	60

Verfügbare Abmessungen auf den folgenden Seiten:
Stahl/Stahl mit Oberfläche: [S. 77](#)

DIN 316

Flügelschrauben, runde Flügelform

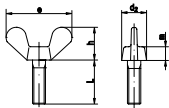

Maße	M 4	M 5	M 6	M 8	M 10	M 12	M 16
d ₂	7	9,5	11,5	14,5	18,5	21,5	27,5
e	20	25	31,5	37	49,5	63,5	71,5
g	1,5	1,9	1,9	2,4	4	4,5	6
h	9,5	12	16	19	24	32,3	36,3
m	3,9	5,3	6,5	8,3	10	12	15

Verfügbare Abmessungen auf den folgenden Seiten:
Stahl/Stahl mit Oberfläche: [S. 78](#) | [Edelstahl: S. 464](#) | [Nichteisen-Werkstoffe: S. 618](#)

DIN 404

Kreuzlochschrauben mit Schlitz

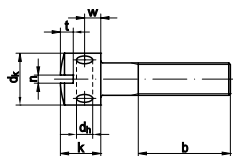

Maße	M 3	M 4	M 5	M 6
∅ d _k	5,5	7	8,5	10
k	4	5	6,5	8
n	0,8	1	1,2	1,6
t _{min.}	1	1,4	1,7	2,2
∅ d _h	1,5	2	2,5	3
w	1,5	2	2,5	3
b	19	22	25	28

Verfügbare Abmessungen auf den folgenden Seiten:
Stahl/Stahl mit Oberfläche: [S. 78](#) | [Edelstahl: S. 465](#)



Sonstige Schrauben mit Maschinengewinde

DIN 444

Augenschrauben

Form B = Produktklasse B

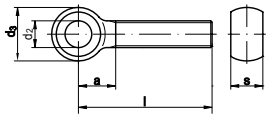
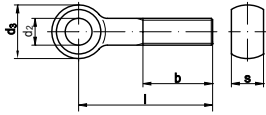

mit Gewinde annähernd bis Auge

b¹ für l ≤ 125 mm

b² für l ≤ 200 mm

b³ für l > 200 mm

Maße	M 5	M 6	M 8	M 10	M 12
d ₂	5	6	8	10	12
d ₃	12	14	18	20	25
s	6	7	9	12	14
a	11	14	16	18	23
b ₁	16	18	22	26	30
b ₂	-	-	28	32	36
b ₃	-	-	-	-	49

Maße	M 16	M 20	M 24	M 30
d ₂	16	18	22	27/28
d ₃	32	40	45	55
s	17	22	25	30
a	27	32	40	46
b ₁	38	46	54	66
b ₂	44	52	60	72
b ₃	57	65	73	85

Verfügbare Abmessungen auf den folgenden Seiten:

Stahl/Stahl mit Oberfläche: [S. 85](#) | [Edelstahl: S. 468](#) | [Nichteisen-Werkstoffe: S. 619](#)

DIN 464

Rändelschrauben, hohe Form

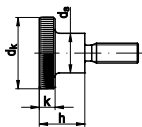

Maße	M 3	M 4	M 5	M 6	M 8	M 10
d _k	12	16	20	24	30	36
k	2,5	3,5	4,0	5,0	6,0	8,0
h	5,7	7,64	9,64	11,57	15,57	19,48
d _s	6	8	10	12	16	20

Verfügbare Abmessungen auf den folgenden Seiten:

Stahl/Stahl mit Oberfläche: [S. 87](#) | [Edelstahl: S. 469](#) | [Nichteisen-Werkstoffe: S. 619](#)

DIN 478

Vierkantschrauben mit Bund

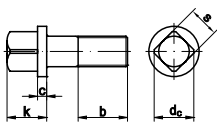

Maße	M 8	M 10	M 12	M 16
k	10	13	15	20
c	2	3	3	4
b	22	26	30	38
d _c	13,5	16,5	19,5	25
s	8	10	13	16 ¹ / 17

¹nach ISO 272

Verfügbare Abmessungen auf den folgenden Seiten:

Stahl/Stahl mit Oberfläche: [S. 91](#)

DIN 479

Vierkantschrauben mit Kernansatz

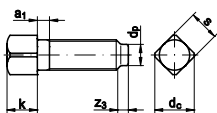

Maße	M 6	M 8	M 10	M 12	M 16	M 20
k	6	8	10	12	16	20
a ₁	3	4	4,5	5,3	6	7,5
s	6	8	10	13	16 ¹ /17	21 ¹ /22
d _p	4	5,5	7	8,5	12	15
z ₁	1,5	2	2,5	3	4	5

Verfügbare Abmessungen auf den folgenden Seiten:

Stahl/Stahl mit Oberfläche: [S. 91](#)

Sonstige Schrauben mit Maschinengewinde

DIN 480

Vierkantschrauben
mit Bund und Ansatzkuppe

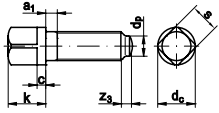

¹nach ISO 272

Maße	M 10	M 12	M 16	M 20
k	13	16	20	25
c _{max.}	3,12	4,15	4,15	5,15
a ₁	4,5	5,3	6	7,5
s	10	13	16 ¹ /17	21 ¹ /22
d _c	13	17	21 ¹ /22	27 ¹ /28
z ₃	2,5	3	4	5

Verfügbare Abmessungen auf den folgenden Seiten:

Stahl/Stahl mit Oberfläche: [S. 92](#)

DIN 525

Anschweißenden

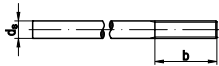

Maße	M 6	M 8	M 10	M 12	M 14*	M 16
b	35	40	45	55	60	65
d _s	6	8	10	12	14	16

Maße	M 20	M 22*	M 24	M 27*	M 30	M 36
b	75	80	85	95	105	125
d _s	20	22	24	27	30	36

*Abmessungen nicht genormt, Richtwerte

Verfügbare Abmessungen auf den folgenden Seiten:

Stahl/Stahl mit Oberfläche: [S. 92](#)

DIN 529

Steinschrauben
Form C = mit Spaltdolle

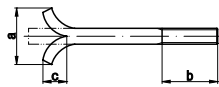

Maße	M 8	M 10	M 12	M 16	M 20	M 24	M 30
b	20	25	30	40	50	60	75
a	24	30	36	48	60	75	95
c	12	15	18	24	30	36	45

Verfügbare Abmessungen auf den folgenden Seiten:

Stahl/Stahl mit Oberfläche: [S. 92](#)



Sonstige Schrauben mit Maschinengewinde

DIN 580

Ringschrauben

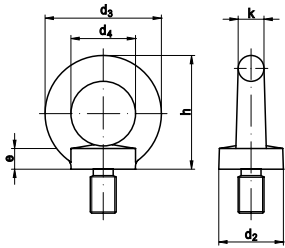

Maße	M 6	M 8	M 10	M 12	M 14	M 16	M 18
d ₂	20	20	25	30	35	35	40
d ₃	36	36	45	54	63	63	72
d ₄	20	20	25	30	35	35	40
h	36	36	45	53	62	62	71
e	6	6	8	10	12	12	14
k	8	8	10	12	14	14	16
Maße	M 20	M 22	M 24	M 27	M 30	M 33	M 36
d ₂	40	50	50	65	65	75	75
d ₃	72	90	90	108	108	126	126
d ₄	40	50	50	60	60	70	70
h	71	90	90	109	109	128	128
e	14	18	18	22	22	26	26
k	16	20	20	24	24	28	28
Maße	M 39	M 42	M 45	M 48	M 52	M 56	M 64
d ₂	85	85	100	100	110	110	120
d ₃	144	144	166	166	184	184	206
d ₄	80	80	90	90	100	100	110
h	147	147	168	168	187	187	208
e	30	30	35	35	38	38	42
k	32	32	38	38	42	42	48

weitere Produktinformationen → [TI-148](#)

Verfügbare Abmessungen auf den folgenden Seiten:

Stahl/Stahl mit Oberfläche: [S. 99](#) | [Edelstahl: S. 472](#)

DIN 603

Flachrundschrauben mit Vierkantansatz

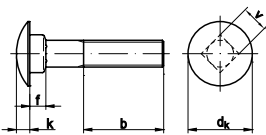

b¹ für l ≤ 125 mm

b² für l ≤ 200 mm

b³ für l > 200 mm

Maße	M 5	M 6	M 8	M 10	M 12	M 16	M 20
d _k	13,5	16,55	20,65	24,65	30,65	38,8	46,8
k	3,3	3,88	4,88	5,38	6,95	8,95	11,05
f	4,1	4,6	5,6	6,6	8,75	12,9	15,9
v	5,48	6,48	8,58	10,58	12,7	16,7	20,84
b ₁	16	18	22	26	30	38	46
b ₂	22	24	28	32	36	44	52
b ₃	-	-	41	45	49	57	65

Verfügbare Abmessungen auf den folgenden Seiten:

Stahl/Stahl mit Oberfläche: [S. 103](#) | [Edelstahl: S. 473](#) | [Nichteisen-Werkstoffe: S. 621](#)

DIN 604

Senkschrauben mit Nase

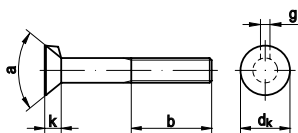

b¹ für l ≤ 125 mm

b² für l ≤ 200 mm

b³ für l > 200 mm

Maße	M 6	M 8	M 10	M 12	M 16	M 20	M 24
d _k	12,55	16,55	19,65	24,65	32,8	32,8	38,8
k	4	5	5,5	7	9	11,5	13
a	90°	90°	90°	90°	90°	60°	60°
g	2,5	3	3,2	3,6	4,2	5,4	6,6
b ₁	18	22	26	30	38	46	54
b ₂	24	28	32	36	44	52	60
b ₃	-	41	45	49	57	65	73

Verfügbare Abmessungen auf den folgenden Seiten:

Stahl/Stahl mit Oberfläche: [S. 106](#)



Sonstige Schrauben mit Maschinengewinde

DIN 605

Senkschrauben mit hohem Vierkantansatz

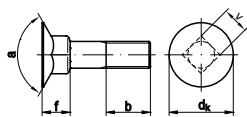

Maße	M 6	M 8	M 10
d_k	16,55	20,65	24,65
f	7,45	9,45	11,55
b	18	22	26
v	6,48	8,58	10,58
Senkwinkel	120°	120°	120°

Verfügbare Abmessungen auf den folgenden Seiten:

Stahl/Stahl mit Oberfläche: [S. 106](#)

DIN 607

Halbrundschrauben mit Nase

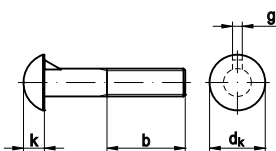

b^1 für $l \leq 125$ mm
 b^2 für $l \leq 200$ mm
 b^3 für $l > 200$ mm

Maße	M 8	M 10	M 12	M 16
d_k	16,55	19,65	24,65	30,65
k	6,38	7,45	9,65	11,75
g	3	3,2	3,6	4,2
b_1	22	26	30	38
b_2	28	32	36	44
b_3	-	-	-	57

Verfügbare Abmessungen auf den folgenden Seiten:

Stahl/Stahl mit Oberfläche: [S. 106](#)

DIN 608

Senkschrauben mit niedrigem Vierkantansatz

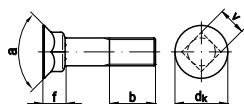

Maße	M 8	M 10	M 12	M 16
d_k	16	19,65	24,65	32
f	7	8,45	11,05	13,5
b	22	26	30	38
v	8	10,58	12,7	16
Senkwinkel	90°	90°	90°	90°

Verfügbare Abmessungen auf den folgenden Seiten:

Stahl/Stahl mit Oberfläche: [S. 106](#)

DIN 653

Rändelschrauben, niedrige Form

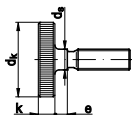

Maße	M 3	M 4	M 5	M 6	M 8	M 10
$\varnothing d_k$	12	16	20	24	30	36
$k_{max.}$	2,5	3,5	4	5	6	8
$\varnothing d_s$	3	4	5	6	8	10
e	2	3	3	4	5	6

Verfügbare Abmessungen auf den folgenden Seiten:

Stahl/Stahl mit Oberfläche: [S. 108](#) | [Edelstahl: S. 474](#)



Sonstige Schrauben mit Maschinengewinde

DIN 787

T-Nutenschrauben

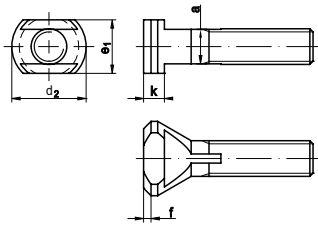

Kopfform bis M 12x12

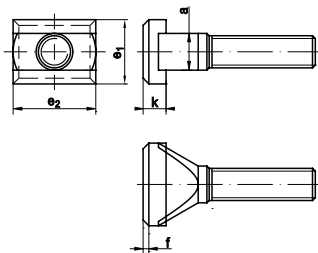

Kopfform ab M 12x14*

* $e_2 \geq e_1$

Maße	M 8	M 10	M 12	M 16
$a_{max.}$	7,7	9,7	11,7	15,7
e_1/d_2	13/16	15/20	18/25	25
f	1,6	1,6	2,5	2,5
k	6	6	7	9
für T-Nuten	8	10	12	16

Maße	M 16	M 20	M 24	M 24
$a_{max.}$	17,7	19,7	23,7	27,7
e_1/d_2	25	32	40	44
f	2,5	2,5	(4)	4
k	9	12	16	18
für T-Nuten	18	20	24	28

Verfügbare Abmessungen auf den folgenden Seiten:

Stahl/Stahl mit Oberfläche: [S. 111](#)

DIN 7643

**Hohlschrauben für Ringstutzen,
Gewindelänge kurz**

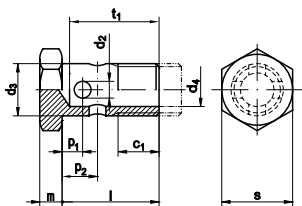

Maße	M 8x1	M 10x1	M 12x1,5	M 14x1,5
Rohr \varnothing	4 und 5	5	8	10
c_1	8,5	8,5	11	11
l_1	17	19	24	26
t_1	15	17	22	24
b_2	-	2,8	3,5	4,5
d_3	8	10	12	14
d_4	4	5,5	7	9
m	5	6	6	6
p_1	-	4,5	5	5,5
p_2	-	6,5	8	9,5
s	12	14	17	19

Maße	M 16x1,5	M 18x1,5	M 22x1,5	M 26x1,5
Rohr \varnothing	12	15	18	22
c_1	11	11	13	13
l_1	28	32	39	45
t_1	26	29	35,5	41
b_2	5,5	7	9	11
d_3	16	18	22	26
d_4	11	13	16	20
m	6	6	7	7
p_1	6,5	7,5	9	10,5
p_2	11,5	14	18	22,5
s	22	24	27	32

Verfügbare Abmessungen auf den folgenden Seiten:

Stahl/Stahl mit Oberfläche: [S. 352](#)

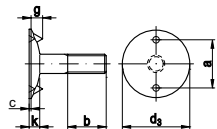
Sonstige Schrauben mit Maschinengewinde
DIN 15237
Tellerschrauben zur Befestigung von Bauteilen an Gurten

Maße	M 6	M 8	M 10	M 12
d_3	20	28	35	42
a	14	20	25	30
$c_{max.}$	1	1	1	1,2
g	3,5	5	6	7
k	2,5	3,5	4,5	5,2
l	20	25/30/35/40	30/35/40/50	35/40/50/60
b	12	15/18/18/20	18/20/20/20	20/25/28/28

Verfügbare Abmessungen auf den folgenden Seiten:

 Stahl/Stahl mit Oberfläche: [S. 407](#)
DIN 22424
Dreikantschrauben

Form A = mit Vollschaft

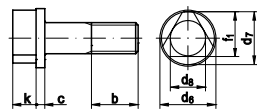

Maße	M 8	M 10
$c_{max.}$	1	1
k	3,5	4,5
$d_{6 max.}$	15,2	18,2
$d_{7 min.}$	13,9	16,9
$d_{8 min.}$	9,3	11,8
b	15/18/18/20	18/20/20/20
$f_{1 min.}$	11,55	14,3

Verfügbare Abmessungen auf den folgenden Seiten:

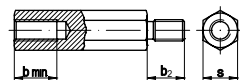
 Stahl/Stahl mit Oberfläche: [S. 408](#)
Artikel 88086
Abstand-/Distanzbolzen

Maße	M 3	M 4	M 5	M 6
$b_{min.}$	2,5/3/3,5/ 5/6/7	5/6/8/9	11	10/15/16
b_2	6	8	10	13
s	5,5	7	8	10

Verfügbare Abmessungen auf den folgenden Seiten:

 Stahl/Stahl mit Oberfläche: [S. 416](#)



Sonstige Schrauben mit Maschinengewinde

Artikel 88136

Gewindeösen
Typ 48

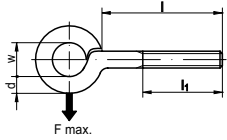

Maße	M 3	M 4	M 5	M 6
w	5	6	8	10
d	2,6	3,5	4,4	5,2
l	11/16	11/16/21/26/32/42	16/21/26/32/42/52/62	11/16/21/26/32/42/52/62/72/82
l ₁	10/15	10/15/20/25/30/40	15/20/25/30/40/50/60	10/15/20/25/30/40/50/60/70/80
F _{max.}	7,50 kg	12,50 kg	20 kg	35 kg

Maße	M 8	M 10	M 12	
w	12	14	18	
d	7	8,9	10,6	
l	21/26/32/42/52/62/82/102	32/42/52/62/72/82/102	102	
l ₁	20/25/30/40/50/60/80/100	30/40/50/60/80/70/100	100	
F _{max.}	50 kg	100 kg	175 kg	

Verfügbare Abmessungen auf den folgenden Seiten:
Stahl/Stahl mit Oberfläche: [S. 434](#) | [Edelstahl: S. 601](#)

Artikel 88138

Gerade Schraubhaken
Typ 4E

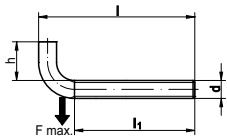

Maße	M 4	M 5	M 6	M 8
h	10	12	14	18
d	3,5	4,4	5,2	7
l	40	50	60	60
l ₁	25	35	45	45
F _{max.}	12,5 kg	20 kg	35 kg	50 kg

Verfügbare Abmessungen auf den folgenden Seiten:
Stahl/Stahl mit Oberfläche: [S. 435](#)

Artikel 88142

Gebogene Schraubhaken
Typ 11E

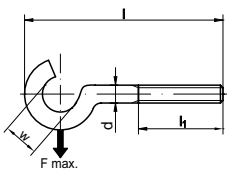

Maße	M 4	M 5	M 6	M 8
w	12/16	16	18	22
d	3,5	4,4	5,2	7
l	40/50	50/60	50/60	70/80
l ₁	20/25	23/30	20/30	32/42
F _{max.}	9 kg	12,50 kg	25 kg	40 kg

Verfügbare Abmessungen auf den folgenden Seiten:
Stahl/Stahl mit Oberfläche: [S. 435](#)



Sonstige Schrauben mit Maschinengewinde

Artikel 88145

Starke Deckenhaken
Typ 18E

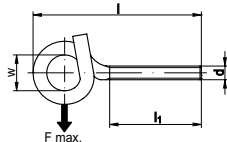

Maße	M 10	M 12	M 12
w	22	22	22
d	8,9	10,6	10,6
l	120/140	160	180
l ₁	73	93	115
F _{max.}	125 kg	175 kg	175 kg

Verfügbare Abmessungen auf den folgenden Seiten:

Stahl/Stahl mit Oberfläche: [S. 436](#)

Schlitzschrauben/Kreuzschlitzschrauben mit Maschinengewinde

ISO 1207

entspricht DIN 84

Zylinderschrauben mit Schlitz

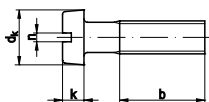

Maße	M 1	M 1,2	M 1,4	M 1,6	M 2	M 2,5	M 3
dk	2	2,3	2,6	3	3,8	4,5	5,5
k	0,7	0,8	0,9	1,1	1,3	1,6	2
n	0,25	0,3	0,3	0,4	0,5	0,6	0,8
b	25	25	25	25	25	25	25

Maße	M 3,5	M 4	M 5	M 6	M 8	M 10
dk	6	7	8,5	10	13	16
k	2,4	2,6	3,3	3,9	5	6
n	1	1,2	1,2	1,6	2	2,5
b	38	38	38	38	38	38

Verfügbare Abmessungen auf den folgenden Seiten:

Stahl/Stahl mit Oberfläche: [S. 205](#), [S. 65](#) | [Edelstahl: S. 513](#), [S. 455](#) | [Nichteisen-Werkstoffe: S. 630](#), [S. 611](#)

ISO 1580

entspricht DIN 85

Flachkopfschrauben mit Schlitz

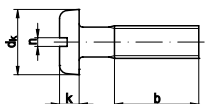

Maße	M 2	M 2,5	M 3	M 4	M 5	M 6	M 8
dk	4	5	6	8	10	12	16
k	1,3	1,5	1,8	2,4	3	3,6	4,8
n	0,5	0,6	0,8	1,2	1,1	1,6	2
b	25	25	25	38	38	38	38

Verfügbare Abmessungen auf den folgenden Seiten:

Stahl/Stahl mit Oberfläche: [S. 220](#), [S. 67](#) | [Edelstahl: S. 520](#), [S. 457](#) | [Nichteisen-Werkstoffe: S. 633](#), [S. 612](#)

DIN 920

Flachkopfschrauben mit Schlitz
und kleinem Kopf

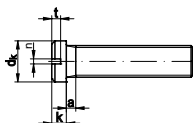

Maße	M 3	M 4	M 5
a _{max.}	1	1,4	1,6
dk	4	5,5	6,5
k	1,8	2,4	2,7
n	0,5	0,6	0,8
t _{max.}	1,15	1,5	1,6

Verfügbare Abmessungen auf den folgenden Seiten:

Stahl/Stahl mit Oberfläche: [S. 141](#)



Schlitzschrauben/Kreuzschlitzschrauben mit Maschinengewinde

DIN 921

Flachkopfschrauben mit Schlitz und großem Kopf

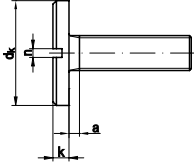

Maße	M 3	M 4	M 5	M 6	M 8	M 10
$a_{max.}$	1	1,4	1,6	2	2,5	3
d_k	8	12	16	20	25	30
k	1,8	2,4	2,7	3,1	3,8	4,6
n	0,8	1	1,2	1,6	2	2,5
$t_{max.}$	1,15	1,5	1,6	1,9	2,4	2,8

Verfügbare Abmessungen auf den folgenden Seiten:

Stahl/Stahl mit Oberfläche: [S. 142](#)

DIN 923

Flachkopfschrauben mit Schlitz und Ansatz

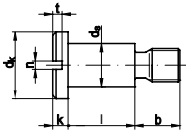

Maße	M 3	M 4	M 5	M 6	M 8	M 10
d_k	7	8,5	11	13	16	20
k	1,8	2,4	2,7	3,1	3,8	4,6
b	4,5	6	7	9	11	13,5
d_s	4	5,5	7	8	10	13

Verfügbare Abmessungen auf den folgenden Seiten:

Stahl/Stahl mit Oberfläche: [S. 142](#) | [Edelstahl: S. 485](#)

DIN 927

Zapfenstifte mit Gewinde und Schlitz

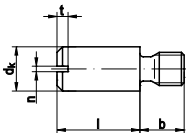

Maße	M 3	M 4	M 5	M 6	M 8
d_k	4	5,5	6,5	8	10
b	4,5	6	7	8	11
n	0,5	0,6	0,8	1	1,2
$t_{max.}$	1,05	1,42	1,63	2	1,9

Verfügbare Abmessungen auf den folgenden Seiten:

Stahl/Stahl mit Oberfläche: [S. 143](#)

ISO 2009

ersetzt DIN 963

Senkschrauben mit Schlitz

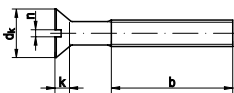

Maße	M 1	M 1,2	M 1,4	M 1,6	M 2	M 2,5
d_k ISO/DIN	1,9	2,3	2,6	3	3,8	4,7
k ISO/DIN	0,6	0,72	0,84	1/0,96	1,2	1,5
b*	1)	1)	1)	15	16	18
n	0,25	0,3	0,3	0,4	0,5	0,6

Maße	M 3	M 3,5	M 4	M 5	M 6	M 8
d_k ISO/DIN	5,5/5,6	7,3/6,5	8,4/7,5	9,3/9,2	11,3/11	15,8/14,5
k ISO/DIN	1,65	2,35/1,93	2,7/2,2	2,7/2,5	3,3/3	4,65/4
b*	19	38	22	25	28	34
n	0,8	1	1,2	1,2	1,6	2

Maße	M 10	M 12	M 16	M 20		
d_k ISO/DIN	18,3/18	22	29	36		
k ISO/DIN	5	6	8	10		
b*	40	46	58	70		
n	2,5	3	4	5		

*Mindestlängen

1) nur mit Gewinde bis annähernd Kopf

Verfügbare Abmessungen auf den folgenden Seiten:

Stahl/Stahl mit Oberfläche: [S. 225](#), [S. 187](#) | [Edelstahl: S. 522](#), [S. 500](#) | [Nichteisen-Werkstoffe: S. 634](#), [S. 627](#)



Schlitzschrauben/Kreuzschlitzschrauben mit Maschinengewinde

ISO 7046

ersetzt DIN 965

Senkschrauben

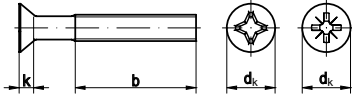

mit Phillips-Kreuzschlitz H
mit Pozidriv-Kreuzschlitz Z

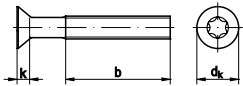

mit Innensechsrund

*Mindestlängen

Maße	M 1,6	M 2	M 2,5	M 3	M 4
$d_{k \text{ ISO/DIN}}$	3	3,8	4,7	5,5/5,6	8,4/7,5
$k_{\text{ISO/DIN}}$	1/0,96	1,2	1,5	1,65	2,7/2,2
b^*	15	16	18	19	22
n	0,4	0,5	0,6	0,8	1
KS-Größe	0	1	1	1	2
ISR	T5	T6	T8	T10	T20

Maße	M 5	M 6	M 8	M 10
$d_{k \text{ ISO/DIN}}$	9,3/9,2	11,3/11	15,8/14,5	18,3/18
$k_{\text{ISO/DIN}}$	2,7/2,5	3,3/3	4,65/4	5
b^*	25	28	34	40
n	1,2	1,6	2	2,5
KS-Größe	2	3	4	4
ISR	T25	T30	T40	T50

Verfügbare Abmessungen auf den folgenden Seiten:

Stahl/Stahl mit Oberfläche: S. 328, S. 190 | Edelstahl: S. 563, S. 503

ISO 2010

ersetzt DIN 964

Linsensenkschrauben
mit Schlitz

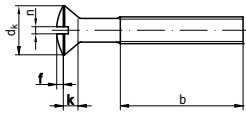

Maße	M 2	M 2,5	M 3	M 4
$d_{k \text{ ISO/DIN}}$	3,8	4,7	5,6	8,4/7,5
$k_{\text{ISO/DIN}}$	1,2	1,5	1,65	2,7/2,2
b	16	18	19	22
f	0,5	0,6	0,75	1
n	0,5	0,6	0,8	1

Maße	M 5	M 6	M 8	M 10
$d_{k \text{ ISO/DIN}}$	9,3/9,2	11,3/11	15,8/14,5	18,3/18
$k_{\text{ISO/DIN}}$	2,7/2,5	3,3/3	4,65/4	5
b	25	28	34	40
f	1,25	1,5	2	2,5
n	1,2	1,6	2	2,5

Verfügbare Abmessungen auf den folgenden Seiten:

Stahl/Stahl mit Oberfläche: S. 227, S. 189 | Edelstahl: S. 524, S. 502 | Nichteisen-Werkstoffe: S. 635, S. 628

ISO 7047

ersetzt DIN 966

Linsensenkschrauben
mit Phillips-Kreuzschlitz H

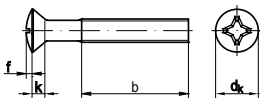

Maße	M 2,5	M 3	M 4	M 5	M 6	M 8
$d_{k \text{ ISO/DIN}}$	4,7	5,6	8,4/7,5	9,3/9,2	11,3/11	15,8/14,5
$k_{\text{ISO/DIN}}$	1,5	1,65	2,7/2,2	2,7/2,5	3,3/3	4,65/4
b	18	19	22	25	28	34
f	0,6	0,75	1	1,25	1,5	2
n	0,6	0,8	1	1,2	1,6	2
KS-Größe	1	1	2	2	3	4

Verfügbare Abmessungen auf den folgenden Seiten:

Stahl/Stahl mit Oberfläche: S. 329, S. 192 | Edelstahl: S. 565, S. 506



Schlitzschrauben/Kreuzschlitzschrauben mit Maschinengewinde

ISO 2010

ersetzt DIN 964

Linsensenkschrauben
mit Schlitz

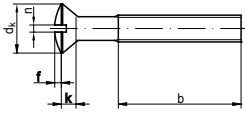

Maße	M 2	M 2,5	M 3	M 4
d_k ISO/DIN	3,8	4,7	5,6	8,4/7,5
k ISO/DIN	1,2	1,5	1,65	2,7/2,2
b	16	18	19	22
f	0,5	0,6	0,75	1
n	0,5	0,6	0,8	1

Maße	M 5	M 6	M 8	M 10
d_k ISO/DIN	9,3/9,2	11,3/11	15,8/14,5	18,3/18
k ISO/DIN	2,7/2,5	3,3/3	4,65/4	5
b	25	28	34	40
f	1,25	1,5	2	2,5
n	1,2	1,6	2	2,5

Verfügbare Abmessungen auf den folgenden Seiten:

Stahl/Stahl mit Oberfläche: [S. 227, S. 189](#) | Edelstahl: [S. 524, S. 502](#) | Nichteisen-Werkstoffe: [S. 635, S. 628](#)

ISO 7047

ersetzt DIN 966

Linsensenkschrauben
mit Phillips-Kreuzschlitz H

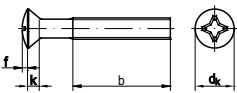

Maße	M 2,5	M 3	M 4	M 5	M 6	M 8
d_k ISO/DIN	4,7	5,6	8,4/7,5	9,3/9,2	11,3/11	15,8/14,5
k ISO/DIN	1,5	1,65	2,7/2,2	2,7/2,5	3,3/3	4,65/4
b	18	19	22	25	28	34
f	0,6	0,75	1	1,25	1,5	2
n	0,6	0,8	1	1,2	1,6	2
KS-Größe	1	1	2	2	3	4

Verfügbare Abmessungen auf den folgenden Seiten:

Stahl/Stahl mit Oberfläche: [S. 329, S. 192](#) | Edelstahl: [S. 565, S. 506](#)

ISO 7045

entspricht DIN 7985

Flachkopfschrauben mit Kreuzschlitz

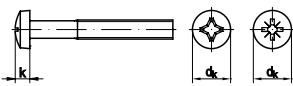

mit Phillips-Kreuzschlitz H
mit Pozidriv-Kreuzschlitz Z

Maße	M 1,6	M 2	M 2,5	M 3	M 3,5
d_k ISO/DIN	3,2	4	5	5,6/6	7
k ISO/DIN	1,3	1,6	2,1/2	2,4	2,6/2,7
KS-Größe	0	1	1	1	2

Maße	M 4	M 5	M 6	M 8	M 10
d_k ISO/DIN	8	9,5/10	12	16	20
k ISO/DIN	3,1	3,7/3,8	4,6	6	7,5
KS-Größe	2	2	3	4	4

Verfügbare Abmessungen auf den folgenden Seiten:

Stahl/Stahl mit Oberfläche: [S. 326](#) | Edelstahl: [S. 561](#)

ISO 14583

~DIN 7985

Flachkopfschrauben mit Innensechsrund

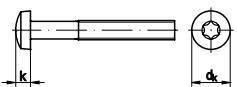

Maße	M 1,6	M 2	M 2,5	M 3	M 4
d_k	3,2	4	5	6	8
k	1,3	1,6	2	2,4	3,1
ISR	T5	T6	T8	T10	T20

Maße	M 5	M 6	M 8	M 10
d_k	10	12	16	20
k	3,8	4,6	6	7,5
ISR	T25	T30	T45	T50

Verfügbare Abmessungen auf den folgenden Seiten:

Stahl/Stahl mit Oberfläche: [S. 405, S. 366](#) | Edelstahl: [S. 590, S. 581](#)



Schlitzschrauben/Kreuzschlitzschrauben mit Maschinengewinde

Artikel 88107

Flachrundschrauben mit Schlitz,
mit Gewinde bis Kopf
"Bordwandschrauben"

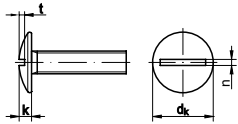

Maße	M 5	M 6	M 8
d_k	12	15	19
k	2,8	3,3	4,3
$n_{min.}$	1,3	1,6	1,8
t	1,5	2	2,7

Verfügbare Abmessungen auf den folgenden Seiten:
Stahl/Stahl mit Oberfläche: S. 428 | Edelstahl: S. 596

Blechschraben, gewindeformende Schrauben und Bohrschrauben

DIN 7500 C

Gewindefurchende Schrauben
mit metrischem Gewinde
und Pozidriv-Kreuzschlitz Z
Form C = Linsenkopf nach DIN 7985

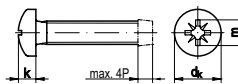

Maße	M 2	M 2,5	M 3	M 3,5	M 4	M 5	M 6	M 8
max. Furchbereich	1,6	1,8	2	2,4	2,8	3,2	4	5
KS-Größe	1	1	1	2	2	2	3	4
$d_{k max.}$	4	5	6	7	8	10	12	16
$k_{max.}$	1,6	2	2,4	2,7	3,1	3,8	4,6	6

Verfügbare Abmessungen auf den folgenden Seiten:
Stahl/Stahl mit Oberfläche: S. 346

DIN 7500 ~D

Gewindefurchende Schrauben
mit metrischem Gewinde
~ Form D = Sechskant-Flanschkopf

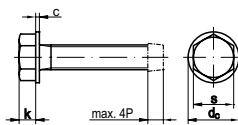

Maße	M 4	M 5	M 6	M 8
max. Furchbereich	2,8	3,2	4	5
s	7	8	10	13
d_c	8,1	10,1	12,6	16,4
c	0,55	0,75	0,9	1,2
k	3,1	3,8	4,6	6

Verfügbare Abmessungen auf den folgenden Seiten:
Stahl/Stahl mit Oberfläche: S. 346

DIN 7500 M

Gewindefurchende Schrauben
mit metrischem Gewinde
und Pozidriv-Kreuzschlitz Z
Form M = Senkkopf nach DIN 965

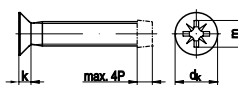

Maße	M 2,5	M 3	M 4	M 5	M 6	M 8
max. Furchbereich	1,8	2	2,8	3,2	4	5
KS-Größe	1	1	2	2	3	4
$d_{k max.}$	4,7	5,6	7,5	9,2	11	14,5
$k_{max.}$	1,5	1,65	2,2	2,5	3	4

Verfügbare Abmessungen auf den folgenden Seiten:
Stahl/Stahl mit Oberfläche: S. 347



Blechschauben, gewindeformende Schrauben und Bohrschrauben

DIN 7500 E

Gewindefurchende Schrauben mit metrischem Gewinde
Form E = Zylinderkopf nach DIN 912

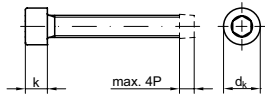

Maße	M 4	M 5	M 6	M 8
$d_{K \max.}$	7	8,5	10	13
$k_{\max.}$	4	5	6	8
s	2,5	3	4	5

Verfügbare Abmessungen auf den folgenden Seiten:

Stahl/Stahl mit Oberfläche: [S. 347](#)

DIN 7500 CE/PE

Gewindefurchende Schrauben mit metrischem Gewinde
Form CE/PE = Linsenkopf nach ISO 14583 mit Innensechsrund

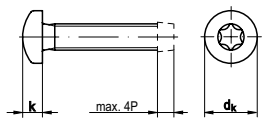

Maße	M 3	M 4	M 5	M 6	M 8
$d_{K \max.}$	5,6	8	9,50	12	16
$k_{\max.}$	2,4	3,1	3,7	4,6	6
ISR-Größe	T10	T20	T25	T30	T40

Verfügbare Abmessungen auf den folgenden Seiten:

Stahl/Stahl mit Oberfläche: [S. 346](#)

DIN 7504 K

Bohrschrauben mit Blechschauben-Gewinde
Form K = Sechskant-Flanschkopf nach DIN 6928

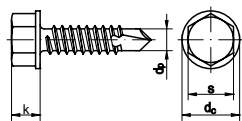

Maße	ST 3,5	ST 3,9	ST 4,2
für Blechdicken	0,7 bis 2,25	0,7 bis 2,4	1,75 bis 3,0
$d_{p \max.}$	2,8	3,1	3,6
$d_{c \max.}$	8,3	8,3	8,8
$k_{\max.}$	3,4	3,4	4,1
s	5,5	5,5	7
Maße	ST 4,8	ST 5,5	ST 6,3
für Blechdicken	1,75 bis 4,4	1,75 bis 5,25	2,0 bis 6,0
$d_{p \max.}$	4,1	4,8	5,8
$d_{c \max.}$	10,5	11	13,5
$k_{\max.}$	4,3	5,4	5,9
s	8	8	10

Verfügbare Abmessungen auf den folgenden Seiten:

Stahl/Stahl mit Oberfläche: [S. 347](#)



Blechschauben, gewindeformende Schrauben und Bohrschrauben

DIN 7504 N

Bohrschrauben mit Blechschauben-Gewinde und Phillips-Kreuzschlitz H
Form N = Linsenkopf nach DIN 7981

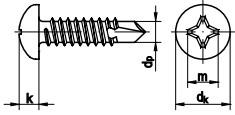

Maße	ST 2,9	ST 3,5	ST 3,9	ST 4,2
für Blechdicken	0,7 bis 1,9	0,7 bis 2,25	0,7 bis 2,4	1,75 bis 3,0
d_p max.	2,3	2,8	3,1	3,6
d_k max.	5,6	6,9	7,5	8,2
k_{max}	2,2	2,6	2,8	3,05
KS-Größe	1	2	2	2

Maße	ST 4,8	ST 5,5	ST 6,3	
für Blechdicken	1,75 bis 4,4	1,75 bis 5,25	2,0 bis 6,0	
d_p max.	4,1	4,8	5,8	
d_k max.	9,5	10,8	12,5	
k_{max}	3,7	4	4,6	
KS-Größe	2	3	3	

Verfügbare Abmessungen auf den folgenden Seiten:

Stahl/Stahl mit Oberfläche: [S. 348](#)

DIN 7504 N

Bohrschrauben mit Blechschauben-Gewinde und Innensechsrund
Form N = Linsenkopf nach ISO 14583

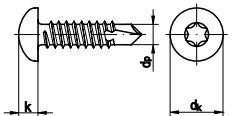

Maße	ST 2,9	ST 3,5	ST 3,9*	ST 4,2
f. Blechdicken	0,7 bis 1,9	0,7 bis 2,25	0,7 bis 2,4	1,75 bis 3,0
d_p max.	2,3	2,8	3,2	3,6
d_k max.	5,6	7	7,5	8
k_{max}	2,4	2,6	2,8	3,1
ISR-Größe	T10	T15	T20	T20

Maße	ST 4,8	ST 5,5	ST 6,3	
f. Blechdicken	1,75 bis 4,4	1,75 bis 5,25	2,0 bis 6,0	
d_p max.	4,1	4,8	5,8	
d_k max.	9,5	11	12	
k_{max}	3,7	4	4,6	
ISR-Größe	T25	T25	T30	

* Abmessung nicht genormt, Richtwerte

Verfügbare Abmessungen auf den folgenden Seiten:

Stahl/Stahl mit Oberfläche: [S. 348](#)

DIN 7504 P

Bohrschrauben mit Blechschauben-Gewinde und Phillips-Kreuzschlitz H
Form P = Senkkopf nach DIN 7982

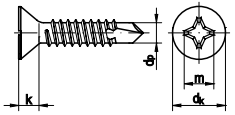

Maße	ST 2,9	ST 3,5	ST 3,9	ST 4,2
f. Blechdicken	0,7 bis 1,9	0,7 bis 2,25	0,7 bis 2,4	1,75 bis 3,0
d_p max.	2,3	2,8	3,2	3,6
d_k max.	5,5	6,8	7,5	8,1
k_{max}	1,7	2,1	2,3	2,5
KS-Größe	1	2	2	2

Maße	ST 4,8	ST 5,5	ST 6,3	
f. Blechdicken	1,75 bis 4,4	1,75 bis 5,25	2,0 bis 6,0	
d_p max.	4,1	4,8	5,8	
d_k max.	9,5	10,8	12,4	
k_{max}	3,0	3,4	3,8	
KS-Größe	2	3	3	

Senkkopf = 80°

Verfügbare Abmessungen auf den folgenden Seiten:

Stahl/Stahl mit Oberfläche: [S. 349](#)



Blechschauben, gewindeformende Schrauben und Bohrschrauben

DIN 7504 P

Bohrschrauben mit Blechschauben-Gewinde und Innensechsrund

Form P = Senkkopf nach DIN 7982

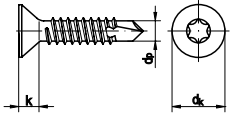

Senkkopf = 80°

Maße	ST 2,9	ST 3,5	ST 3,9	ST 4,2
f. Blechdicken	0,7 bis 1,9	0,7 bis 2,25	0,7 bis 2,4	1,75 bis 3,0
d_p max.	2,3	2,8	3,2	3,6
d_k max.	5,5	6,8	7,5	8,1
$k_{max.}$	1,7	2,1	2,3	2,5
ISR-Größe	T10	T15	T20	T20
Maße	ST 4,8	ST 5,5	ST 6,3	
f. Blechdicken	1,75 bis 4,4	1,75 bis 5,25	2,0 bis 6,0	
d_p max.	4,1	4,8	5,8	
d_k max.	9,5	10,8	12,4	
$k_{max.}$	3	3,4	3,8	
ISR-Größe	T25	T25	T30	

Verfügbare Abmessungen auf den folgenden Seiten:

Stahl/Stahl mit Oberfläche: [S. 349](#)

DIN 7513 A

Gewindeschneidschrauben

Form A = Sechskantkopf nach DIN 933

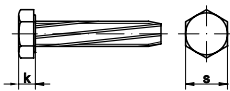

*für Werkstoffe mit mittlerer Festigkeiten

Maße	M 4	M 5	M 6	M 8
s	7	8	10	13
k	2,8	3,5	4	5,3
für Kernloch \varnothing *	3,6	4,5	5,5	7,4

Verfügbare Abmessungen auf den folgenden Seiten:

Stahl/Stahl mit Oberfläche: [S. 349](#)

DIN 7513 B

Gewindeschneidschrauben

Form B = Zyl.-Kopf mit Schlitz nach DIN 84

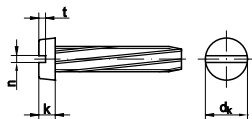

*für Werkstoffe mit mittlerer Festigkeit

Maße	M 3	M 4	M 5	M 6
d_k max.	5,5	7	8,5	10
k	2	2,6	3,3	3,9
n	0,8	1,2	1,2	1,6
$t_{min.}$	0,85	1,1	1,3	1,6
für Kernloch \varnothing *	2,7	3,6	4,5	5,5

Verfügbare Abmessungen auf den folgenden Seiten:

Stahl/Stahl mit Oberfläche: [S. 349](#)

Blechschauben, gewindeformende Schrauben und Bohrschrauben

DIN 7516 A

Gewindeschneidschrauben

Form A = Linsenkopf nach DIN 7985



mit Phillips-Kreuzschlitz H

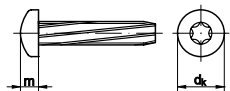

mit Innensechsrund

Maße	M 3	M 4	M 5	M 6	M 8
$d_{k \max.}$	6	8	10	12	16
$k_{\max.}$	2,4	3,1	3,8	4,6	6
KS-Größe	1	2	2	3	4
ISR	T10	T20	T25	T30	T40
für Kernloch \varnothing^*	2,7	3,6	4,5	5,5	7,4

*für Werkstoffe mit mittleren Festigkeiten

Verfügbare Abmessungen auf den folgenden Seiten:

Stahl/Stahl mit Oberfläche: [S. 350](#)

DIN 7516 D

Gewindeschneidschrauben

Form D = Senkkopf nach DIN 965

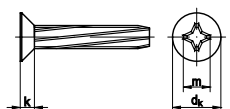

mit Phillips-Kreuzschlitz H

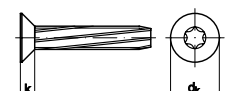

mit Innensechsrund

Maße	M 3	M 4	M 5	M 6	M 8
$d_{k \max.}$	5,6	7,5	9,2	11	14,5
$k_{\max.}$	1,65	2,2	2,5	3	4
KS-Größe	1	2	2	3	4
ISR	T10	T20	T25	T30	T40

*für Werkstoffe mit mittleren Festigkeiten

Verfügbare Abmessungen auf den folgenden Seiten:

Stahl/Stahl mit Oberfläche: [S. 350](#)

DIN 7516 E

Gewinde-Schneidschrauben

mit Phillips-Kreuzschlitz H

Form E = Linsensenkkopf nach DIN 966

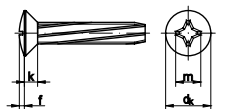

*für Werkstoffe mit mittleren Festigkeiten

Maße	M 3	M 4	M 5	M 6	M 8
$d_{k \max.}$	5,6	7,5	9,2	11	14,5
f	0,75	1	1,25	1,5	2
$k_{\max.}$	1,65	2,2	2,5	3	4
KS-Größe	1	2	2	3	4
für Kernloch \varnothing^*	2,7	3,6	4,5	5,5	7,4

Verfügbare Abmessungen auf den folgenden Seiten:

Stahl/Stahl mit Oberfläche: [S. 350](#)



Blechschauben, gewindeformende Schrauben und Bohrschrauben

ISO 1479

ersetzt DIN 7976

Sechskant-Blechschauben

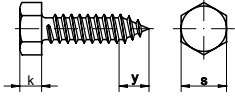

Form C = mit Spitze

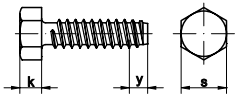

Form F = mit Zapfen

*Abmessung nicht in ISO genormt,

Werte aus DIN 7976

Montagehinweise → [TI-184](#)

Maße	ST 2,9	ST 3,5	ST 3,9*	ST 4,2
$k_{ISO/DIN}$	2,3/1,5	2,6/2,3	2,3	3/2,8
s	5	5,5	7	7
$y_{Form C}$	2,6	3,2	3,5	3,7
$y_{Form F}$	-	-	-	2,8

Maße	ST 4,8	ST 5,5	ST 6,3	ST 8
$k_{ISO/DIN}$	3,8/3	4,1/4	4,7/4,8	6/5,8
s	7	8	10	13
$y_{Form C}$	4,2	5	6	7,5
$y_{Form F}$	3,2	-	3,6	-

Verfügbare Abmessungen auf den folgenden Seiten:

Stahl/Stahl mit Oberfläche: [S. 214](#), [S. 354](#) | Edelstahl: [S. 518](#), [S. 575](#)

ISO 7049, 14585

ersetzt DIN 7981

Linsenkopf-Blechschauben mit Kreuzschlitz oder Innensechsrund

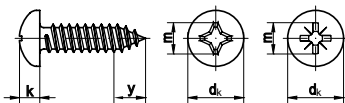

Form C-H = mit Spitze und Phillips-Kreuzschlitz H

Form C-Z = mit Spitze und Pozidriv-Kreuzschlitz Z

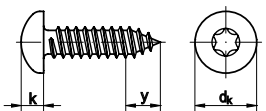

Form C-ISR = mit Spitze und Innensechsrund

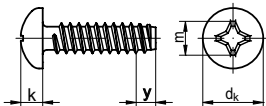

Form F-H = mit Zapfen und Phillips-Kreuzschlitz H

*Abmessungen nicht in ISO genormt,

Werte aus DIN 7981

Montagehinweise → [TI-184](#)

Maße	ST 2,2	ST 2,9	ST 3,5	ST 3,9*
$d_k_{ISO/DIN}$	4/4,2	5,6	7/6,9	7,5
$k_{max. ISO/DIN}$	1,6/1,8	2,4/2,2	2,6	2,8
KS-Größe	1	1	2	2
ISR	T6	T10	T15	T20
$y_{Form C}$	2	2,6	3,2	3,5
$y_{Form F}$	1,6	2,1	2,5	2,7

Maße	ST 4,2	ST 4,8	ST 5,5	ST 6,3
$d_k_{ISO/DIN}$	8/8,2	9,5	11/10,8	12/12,5
$k_{max. ISO/DIN}$	3,1/3,05	3,7/3,5	4/3,95	4,6/4,55
KS-Größe	2	2	3	3
ISR	T20	T25	T25	T30
$y_{Form C}$	3,7	4,2	5	6
$y_{Form F}$	2,8	3,2	3,6	3,6

Verfügbare Abmessungen auf den folgenden Seiten:

Stahl/Stahl mit Oberfläche: [S. 330](#), [S. 405](#), [S. 357](#) | Edelstahl: [S. 566](#), [S. 590](#), [S. 575](#)



Blechschauben, gewindeformende Schrauben und Bohrschrauben

ISO 7050, 14586

ersetzt DIN 7982

Senk-Blechschauben mit Kreuzschlitz nach ISO 7050 oder Innensechsrund nach ISO 14586

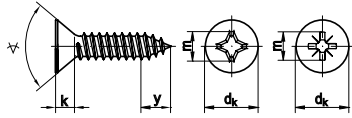

Form C-H = mit Spitze und Phillips-Kreuzschlitz H
Form C-Z = mit Spitze und Pozidriv-Kreuzschlitz Z

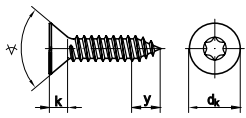

Form C-ISR = mit Spitze und Innensechsrund**

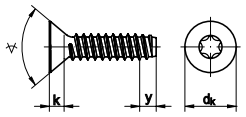

Form F-ISR = mit Zapfen und Innensechsrund

*Abmessung nicht in ISO genormt
**auch als ~DIN 7982 verfügbar
Montagehinweise → [TI-184](#)

Maße	ST 2,2	ST 2,9	ST 3,5	ST 3,9*
d_k ISO/DIN	3,8/4,3	5,5	7,3/6,8	-/7,5
$k_{max.}$ ISO/DIN	1,1/1,3	1,7	2,35/2,1	-/2,3
KS-Größe	0	1	2	2
ISR	-	10	15	15
$y_{Form C}$	2	2,6	3,2	3,2
$y_{Form F}$	1,6	2,1	2,5	2,7
∠ ISO/DIN	90°/80°	90°/80°	90°/80°	90°/80°

Maße	ST 4,2	ST 4,8	ST 5,5	ST 6,3
d_k ISO/DIN	8,4/8,1	9,3/9,5	10,3/10,8	11,3/12,4
$k_{max.}$ ISO/DIN	2,6/2,5	2,8/3	3/3,4	3,15/3,8
KS-Größe	2	2	3	3
ISR	20	25	25	30
$y_{Form C}$	3,7	4,3	5	6
$y_{Form F}$	2,8	3,2	3,6	3,6
∠ ISO/DIN	90°/80°	90°/80°	90°/80°	90°/80°

Verfügbare Abmessungen auf den folgenden Seiten:

Stahl/Stahl mit Oberfläche: [S. 332](#), [S. 404](#), [S. 360](#) | Edelstahl: [S. 567](#), [S. 591](#), [S. 577](#)

ISO 7051

ersetzt DIN 7983

Linsensenk-Blechschauben mit Phillips-Kreuzschlitz H
Form C = mit Spitze

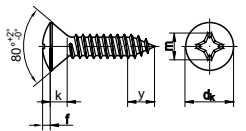

*Abmessung nicht in ISO genormt,
Werte aus DIN 7983
Montagehinweise → [TI-184](#)

Maße	ST 2,9	ST 3,5	ST 3,9*	ST 4,2
d_k ISO/DIN	5,5	7,3/6,8	-/7,5	8,4/8,1
$k_{max.}$ ISO/DIN	1,7/1,7	2,35/2,1	-/2,3	2,6/2,5
KS-Größe	1	2	2	2
$y_{Form C}$	2,6	3,2	3,5	3,7

Maße	ST 4,8	ST 5,5	ST 6,3
d_k ISO/DIN	9,3/9,5	10,3/10,8	11,3/12,4
$k_{max.}$ ISO/DIN	2,8/3	3/3,4	3,15/3,8
KS-Größe	2	3	3
$y_{Form C}$	4,3	5	6

Verfügbare Abmessungen auf den folgenden Seiten:

Stahl/Stahl mit Oberfläche: [S. 333](#), [S. 362](#) | Edelstahl: [S. 567](#), [S. 578](#)



Blechschauben, gewindeformende Schrauben und Bohrschrauben

Artikel 88114

Diebstahlhemmende Blechschauben mit Linsenkopf und Pin-ISR-Antrieb
Form C = mit Spitze

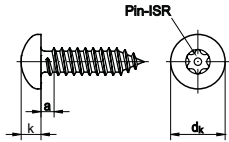

Montagehinweise → [TI-184](#)

Maße	ST 3,5	ST 4,2	ST 4,8	ST 5,5	ST 6,3
d_k	6,9	8,2	9,5	10,8	12,5
k	2,6	3,05	3,55	3,95	4,55
$a_{max.}$	1,3	1,4	1,6	1,8	1,8
Pin-ISR-Größe	T10	T15	T25	T27	T27

Verfügbare Abmessungen auf den folgenden Seiten:

Edelstahl: [S. 597](#)

Artikel 88115

Diebstahlhemmende Blechschauben mit Senkkopf und Pin-ISR-Antrieb
Form C = mit Spitze

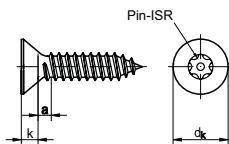

Montagehinweise → [TI-184](#)

Maße	ST 2,9	ST 3,5	ST 4,2	ST 4,8	ST 5,5	ST 6,3
d_k	5,5	6,8	8,1	9,5	10,8	12,4
k	1,7	2,1	2,5	3	3,4	3,8
$a_{max.}$	1,1	1,3	1,4	1,6	1,8	1,8
Pin-ISR-Größe	T10	T15	T20	T25	T27	T30

Verfügbare Abmessungen auf den folgenden Seiten:

Edelstahl: [S. 597](#)

Artikel 88200

Gewindefurchende Schrauben mit Linsenkopf für Kunststoffe (Thermoplaste)

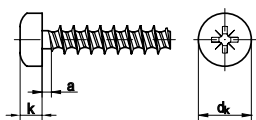

mit Pozidriv-Kreuzschlitz Z

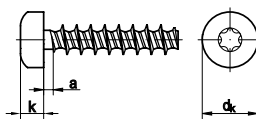

mit Innensechsrund

a_1 für ($L > 3xd$)

a_2 für ($L > 3xd$)

ISR = Innensechsrund

KS = Kreuzschlitz

Maße	2,2	2,5	3	3,5
$dk_{KS/ISR}$	3,9/4	4,4/4,2	5,3/5,6	6,1/6,9
$k_{KS/ISR}$	1,5/1,5	1,7/1,6	2/2,1	2,5/2,3
a_1	2,2	2,5	3	3,5
a_2	1,1	1,3	1,5	1,8
KS-Größe	1	1	1	1
ISR-Größe	T6	T8	T10	T10

Maße	4	5	6	
$dk_{KS/ISR}$	7/7,5	8,8/8,2	10,5/10,8	
$k_{KS/ISR}$	2,7/2,6	3,4/2,9	4/3,8	
a_1	4	6	7	
a_2	2	3	3,5	
KS-Größe	2	2	2	
ISR-Größe	T20	T20	T25	

Verfügbare Abmessungen auf den folgenden Seiten:

Stahl/Stahl mit Oberfläche: [S. 436](#), [S. 436](#)



Blechschauben, gewindeformende Schrauben und Bohrschrauben

Artikel 88202

Gewindefurchende Schrauben mit Linsenkopf und angepresster Scheibe für Kunststoff (Thermoplaste)

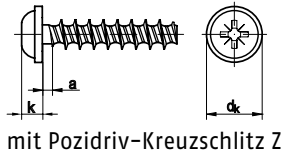

mit Pozidriv-Kreuzschlitz Z

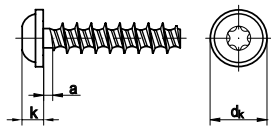

mit Innensechsrund

a₁ für (L > 3xd)
a₂ für (L > 3xd)

ISR = Innensechsrund
KS = Kreuzschlitz

Maße	2,2	2,5	3	3,5
d _k KS /ISR	4,4/4,5	5	6	7
k KS /ISR	1,6/1,4	1,8/1,5	2,1	2,4
a ₁	2,2	2,5	3	3,5
a ₂	1,1	1,3	1,5	1,8
KS-Größe	1	1	1	1
ISR-Größe	T6	T6	T10	T10

Maße	4	5	6	
d _k KS /ISR	8	10	12	
k KS /ISR	2,5/2,6	3,2/3,3	4/3,6	
a ₁	4	6	7	
a ₂	2	3	3,5	
KS-Größe	2	2	2	
ISR-Größe	T20	T20	T25	

Verfügbare Abmessungen auf den folgenden Seiten:
Stahl/Stahl mit Oberfläche: [S. 437](#), [S. 437](#)

Artikel 88203

Gewindefurchende Schrauben mit Linsenkopf für Kunststoffe (Thermoplaste), mit Innensechsrund
RSTplus = höhere Vorspannkkräfte

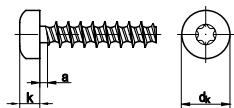

Maße	2,2	2,5	3	3,5
d _k	3,9	4,4	5,3	6,1
k	1,6	1,9	2,3	2,7
a _{max.}	1,1	1,3	1,5	1,8
ISR-Größe	T6	T8	T10	T15

Maße	4	5	6	
d _k	7	8,8	10,5	
k	3,1	3,5	4,2	
a _{max.}	2	2,5	3	
ISR-Größe	T20	T25	T30	

Verfügbare Abmessungen auf den folgenden Seiten:
Stahl/Stahl mit Oberfläche: [S. 437](#)

Artikel 88204

Gewindefurchende Schrauben mit Linsenkopf und angepresster Scheibe für Kunststoff (Thermoplaste), mit Innensechsrund
RSTplus = höhere Vorspannkkräfte



Maße	2,2	2,5	3	3,5
d _k	5	5,5	6,5	7,5
k	1,6	1,9	2,3	2,7
a _{max.}	1,1	1,3	1,5	1,8
ISR-Größe	T6	T8	T10	T15

Maße	4	5	6	
d _k	9	11	13,5	
k	3,1	3,5	4,2	
a _{max.}	2	2,5	3	
ISR-Größe	T20	T25	T30	

Verfügbare Abmessungen auf den folgenden Seiten:
Stahl/Stahl mit Oberfläche: [S. 437](#)



Blechschauben, gewindeformende Schrauben und Bohrschrauben

Artikel 88312

Zylinder-Blechschauben
mit Innensechskant
Form C = mit Spitze

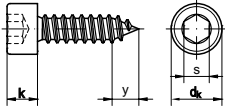

Maße	ST 4,8	ST 5,5	ST 6,3
d_k	8,5	10	10
k	5	6	6
s	4	5	5
y~	4,3	5	6

Montagehinweise → TI-184

Verfügbare Abmessungen auf den folgenden Seiten:

Edelstahl: S. 574

Artikel 88176, 88276

Fassadenschrauben
mit montierter Dichtscheibe

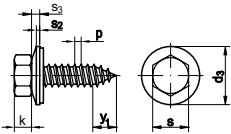

88176 Form A = mit Spitze

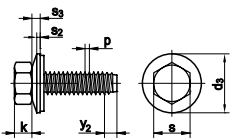

88276 Form BZ = mit Zapfen

Maße	88176 6,5
s	3/8"
k	4
p	2,54
y_1	6
y_2	-
d_3 (Scheibe)	16 / 18*
s_2 (Scheibe)	1
s_3 (Scheibe)	2
für Blechstärken	0,60 – 1,50
für Bohrung \varnothing	4,5

Verfügbare Abmessungen auf den folgenden Seiten:

Edelstahl: S. 602

Holzschrauben

DIN 95

Linsensenk-Holzschrauben
mit Schlitz

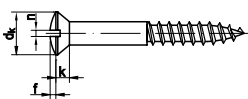

Maße	1,6	2	2,5	3	3,5
d_k	3	3,8	4,7	5,6	6,5
k	0,96	1,2	1,5	1,65	1,93
f	0,4	0,5	0,6	0,75	0,9
n	0,4	0,5	0,6	0,8	0,8
Maße	4	4,5	5	6	8
d_k	7,5	8,3	9,2	11	14,5
k	2,2	2,35	2,5	3	4
f	1	1,1	1,25	1,5	2
n	1	1	1,2	1,6	2

Verfügbare Abmessungen auf den folgenden Seiten:

Stahl/Stahl mit Oberfläche: S. 70 | Edelstahl: S. 459 | Nichteisen-Werkstoffe: S. 613



Holzschrauben

DIN 96

Halbrund-Holzschrauben
mit Schlitz

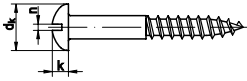

Maße	1,6	2	2,5	3	3,5
d _k	3,2	4	5	6	7
k	1,1	1,4	1,7	2,1	2,4
n	0,4	0,5	0,6	0,8	0,8
Maße	4	4,5	5	6	
d _k	8	9	10	12	
k	2,8	3,1	3,5	4,2	
n	1	1	1,2	1,6	

Verfügbare Abmessungen auf den folgenden Seiten:

Stahl/Stahl mit Oberfläche: [S. 70](#) | Edelstahl: [S. 460](#) | Nichteisen-Werkstoffe: [S. 615](#)

DIN 97

Senk-Holzschrauben
mit Schlitz

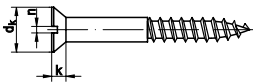

Maße	1,6	2	2,5	3	3,5	4
d _k	3	3,8	4,7	5,6	6,5	7,5
k	0,96	1,2	1,5	1,65	1,93	2,2
n	0,4	0,5	0,6	0,8	0,8	1
Maße	4,5	5	5,5	6	8	
d _k	8,3	9,2	10,2	11	14,5	
k	2,35	2,5	2,75	3	4	
n	1	1,2	1,2	1,6	2	

Verfügbare Abmessungen auf den folgenden Seiten:

Stahl/Stahl mit Oberfläche: [S. 70](#) | Edelstahl: [S. 460](#) | Nichteisen-Werkstoffe: [S. 615](#)

DIN 571

Sechskant-Holzschrauben

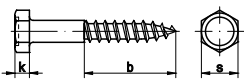

Maße	5	6	7	8
b	> 0,6 l	> 0,6 l	> 0,6 l	> 0,6 l
k	3,5	4	5	5,5
s	8	10	12	13
Maße	10	12	16	20
b	> 0,6 l	> 0,6 l	> 0,6 l	> 0,6 l
k	7	8	10	13
s	17	19	24	30

Verfügbare Abmessungen auf den folgenden Seiten:

Stahl/Stahl mit Oberfläche: [S. 98](#) | Edelstahl: [S. 471](#)

Artikel 89571

Sechskant-Holzschrauben

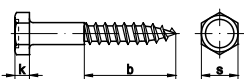

Maße	8	12
b	> 0,6 l	> 0,6 l
k	5,5	8
s	13	19

Verfügbare Abmessungen auf den folgenden Seiten:

Stahl/Stahl mit Oberfläche: [S. 450](#)



Spanlattenschrauben

Artikel 88095

Spanlattenschrauben mit
insensenkopf
und Pozidriv-Kreuzschlitz Z

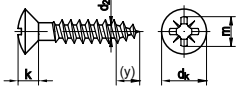

Maße	ST 3,5	ST 4
d_k	7	8
$k_{min.}$	2,1	2,4
d_2	2,5	2,67
KS-Größe	2	2

Verfügbare Abmessungen auf den folgenden Seiten:

Nichteisen-Werkstoffe: [S. 645](#)

Artikel 89096

Spanlattenschrauben mit Halbrundkopf
und Pozidriv-Kreuzschlitz Z

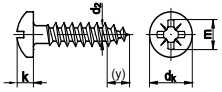

Maße	ST 3	ST 3,5	ST 4	ST 4,5	ST 5	ST 6
d_2	1,9	2,5	2,67	2,7	3	3,7
d_k	6	7	8	9	10	12
$k_{1 max.}$	2,25	2,6	2,8	3	3,5	4,1
y	3	3,4	4	4,3	4,8	5,7
KS-Größe	1	2	2	2	2	3

Verfügbare Abmessungen auf den folgenden Seiten:

Stahl/Stahl mit Oberfläche: [S. 447](#) | Edelstahl: [S. 607](#)

Artikel 89097

Spanlattenschrauben mit Senkkopf
und Pozidriv-Kreuzschlitz Z

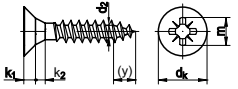

Maße	ST 3	ST 3,5	ST 4	ST 4,5	ST 5	ST 6
d_2	1,9	2,5	2,67	2,7	3	3,7
d_k	6	7	8	9	10	12
$k_{1 max.}$	1,9	2,1	2,5	2,7	3	3,6
$k_{2 max.}$	1,6	1,8	2	2,2	2,5	3
y	3	3,4	4	4,3	4,8	5,7
KS-Größe	1	2	2	2	2	3

Verfügbare Abmessungen auf den folgenden Seiten:

Stahl/Stahl mit Oberfläche: [S. 448](#) | Edelstahl: [S. 607](#)

Artikel 89098

Spanlattenschrauben mit Senkkopf
und Innensechsrund

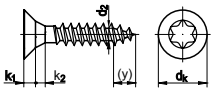

Maße	ST 3	ST 3,5	ST 4	ST 4,5	ST 5	ST 6	ST 8
d_2	1,9	2,5	2,67	2,7	3	3,7	5
d_k	6	7	8	9	10	12	15,1
$k_{1 max.}$	1,9	2,1	2,5	2,7	3	3,6	4,4
$k_{2 max.}$	1,6	1,8	2	2,2	2,5	3	3,8
y	3	3,4	4	4,3	4,8	5,7	6,5
KS-Größe	T10	T15	T20	T20	T25	T30	T40

Verfügbare Abmessungen auf den folgenden Seiten:

Stahl/Stahl mit Oberfläche: [S. 449](#) | Edelstahl: [S. 608](#)

Artikel 89091

Holzbauschrauben mit Senkkopf

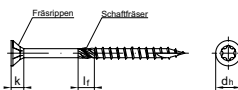

Maße	3,5	4	4,5	5	6	8	10
d_h	6,8	7,8	8,8	9,8	11,8	14,5	18
k	3,4	4,2	4,5	5,1	5,6	7	8,7
l_f	6	6	6	6	12	12	12
ISR	15	20	25	25	30	40	40
Charakteristisches Fließmoment $M_{y,Rk}$ [Nm]	2,3	3,3	4,5	5,9	9,5	20	36
Charakteristische Zugtragfähigkeit $f_{tens,k}$ [kN]	4	5	6	8	9,5	19	25
Charakteristisches Bruchdrehmoment $f_{tor,k}$ [Nm]	2,2	3,3	4,5	6,1	9	24	40

zur Verwendung mit Senkscheibe R 89184

Verfügbare Abmessungen auf den folgenden Seiten:

Stahl/Stahl mit Oberfläche: [S. 446](#)



Spanplattenschrauben

Artikel 89092

Holzbauschrauben mit Tellerkopf

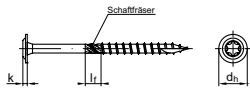

Maße	6	8	10
d_h	15,3	22	25
k	3,1	3,4	4
l_f	12	12	12
ISR	30	40	40
Charakteristisches Fliemoment $M_{y,Rk}$ [Nm]	9,5	20	36
Charakteristische Zugtragfhigkeit $f_{tens,k}$ [kN]	9,5	19	25
Charakteristisches Bruchdrehmoment $f_{tor,k}$ [Nm]	9	24	40

Verfgbare Abmessungen auf den folgenden Seiten:

Stahl/Stahl mit Oberflche: [S. 447](#)

Artikel 89150

Schnellbauschrauben mit Trompetenkopf und Grobgewinde

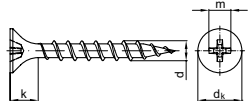

Maße	3,9
$d_{max.}$	4,3
$k_{max.}$	5
$d_{k max.}$	8,5
m	PH2

Verfgbare Abmessungen auf den folgenden Seiten:

Stahl/Stahl mit Oberflche: [S. 450](#)

Artikel 89151

Schnellbauschrauben mit Trompetenkopf und Feingewinde

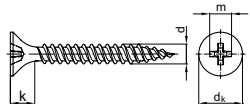

Maße	3,9
$d_{max.}$	4
$k_{max.}$	5
$d_{k max.}$	8,5
m	PH2

Verfgbare Abmessungen auf den folgenden Seiten:

Stahl/Stahl mit Oberflche: [S. 451](#)

Artikel 89152

Schnellbauschrauben mit Trompetenkopf und Bohrspitze

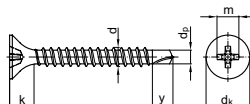

Maße	3,5
$d_{max.}$	3,53
$k_{max.}$	6
$y\sim$	3,9
$d_p\sim$	2,8
$d_{k max.}$	8,4
m	PH2

Verfgbare Abmessungen auf den folgenden Seiten:

Stahl/Stahl mit Oberflche: [S. 451](#)



Sonderformen mit Holzschraubengewinde

Artikel 88133

Ringschraubösen
mit Holzschrauben-Gewinde
Typ 1

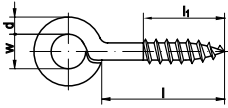

Maße	6x3	8x3	8x4	10x3	10x4	10x6	12x3	12x4
w	3	3	4	3	4	6	3	4
d	2	2	2,3	2	2,3	2,9	2	2,3
l	6	8	8	10	10	10	12	12
l ₁	4	5	5	7	7	7	8	8

Maße	12x6	12x8	12x10	16x4	16x6	16x8	16x10	16x12
w	6	8	10	4	6	8	10	12
d	2,9	3,3	3,7	2,3	2,9	3,3	3,7	3,9
l	12	12	12	16	16	16	16	16
l ₁	8	8	8	10	10	10	10	10

Maße	20x6	20x8	20x10	20x12	25x8	25x10	25x12	25x14
w	6	8	10	12	8	10	12	14
d	2,9	3,3	3,7	3,9	3,3	3,7	3,7	4
l	20	20	20	20	25	25	25	25
l ₁	12	12	12	12	15	15	15	15

Maße	25x16	30x8	30x10	30x12	30x14	30x16	30x18	40x12
w	16	8	10	12	14	16	18	12
d	4,6	3,3	3,7	3,9	4	4,6	5	3,9
l	25	30	30	30	30	30	30	40
l ₁	15	18	18	18	20	18	18	22

Maße	40x14	40x16	40x18	40x20	50x14	50x16	50x18	50x20
w	14	16	18	20	14	16	18	20
d	4	4,6	5	5,2	4	4,6	5	5,2
l	40	40	40	40	50	50	50	50
l ₁	25	22	22	22	25	25	25	25

Verfügbare Abmessungen auf den folgenden Seiten:

Stahl/Stahl mit Oberfläche: [S. 434](#)

Artikel 88137

Gerade Schraubhaken
mit Holzschrauben-Gewinde
Typ 4

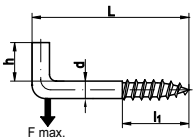

Maße	2,8	2,8	3,3	4,1
h	8	10	11	11
d	2,3	2,3	2,6	3,2
l	20	25	30	40
l ₁	8	10	12	15
F _{max.}	7,5 kg	7,5 kg	10 kg	12,5 kg
für Dübel	4	4	5	6

Maße	4,8	4,8	5,5	6
h	13	13	18	18
d	3,8	3,8	4,2	4,7
l	50	60	80	100
l ₁	22	25	32	38
F _{max.}	15 kg	15 kg	20 kg	25 kg
für Dübel	6	6	8	8

Verfügbare Abmessungen auf den folgenden Seiten:

Stahl/Stahl mit Oberfläche: [S. 435](#)



Sonderformen mit Holzschraubengewinde

Artikel 88139

Schlitzschraubhaken
mit Holzschrauben-Gewinde
Typ 7

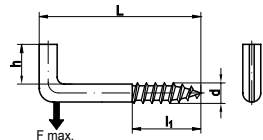

Maße	4,4	5,2	5,8
h	9	10	12
d	4,4	5,2	5,8
l	40/50	30/40/50/60	80/100
l ₁	18/22	13/18/22/25	30/38
F _{max.}	25 kg	40 kg	50 kg
für Dübel	6	8	8

Verfügbare Abmessungen auf den folgenden Seiten:

Stahl/Stahl mit Oberfläche: S. 435

Artikel 88140/88141

Gebogene Schraubhaken
mit Holzschrauben-Gewinde
Typ 11/Typ 11 k

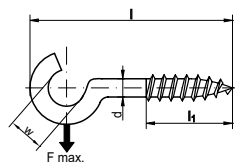

Maße	2,8	3,3	3,6	4,1
w	6/8	10 - 11	12 - 14	16 - 20
d	2,3	2,6	2,8	3,2
l	20/25	30	40	50/60
l ₁	6/8	10	12	15/22
F _{max.}	4 kg	4 kg	7,5 kg	9 kg
für Dübel	4	5	5	6

Maße	4,8	5,5	6
w	22 - 23	25 - 26	25 - 30
d	3,8	4,2	4,7
l	70	80	100
l ₁	22	26	30
F _{max.}	10 kg	12,5 kg	15 kg
für Dübel	6	8	8

Typ 11 k = weiß beschichtet

Verfügbare Abmessungen auf den folgenden Seiten:

Stahl/Stahl mit Oberfläche: S. 435

Artikel 88143

Winkelschraubhaken mit Innensechsrund
und Holzschrauben-Gewinde
Typ 10

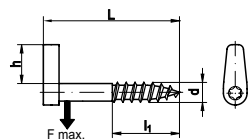

Maße	5,2	5,8
h	9	10
d	5,2	5,8
l	50	
l ₁	25	30
ISR	T15	T20
F _{max.}	40 kg	50 kg
für Dübel	8	8

Verfügbare Abmessungen auf den folgenden Seiten:

Stahl/Stahl mit Oberfläche: S. 436



Sonderformen mit Holzschraubengewinde

Artikel 88144

**Starke Deckenhaken
mit Holzschrauben-Gewinde**
Typ 18

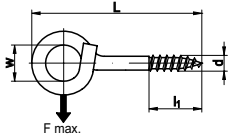

Maße	8,2	9	10
w	22	22	22
d	8,2	8,9	9,9
l	100	120/140	140
l ₁	40	45/48	48
F _{max.}	100 kg	125 kg	150 kg
für Dübel	12	12	14

Achtung: nicht geeignet für Schaukeln

Verfügbare Abmessungen auf den folgenden Seiten:

Stahl/Stahl mit Oberfläche: [S. 436](#)

Stahlbau-Schrauben, -Muttern, -Scheiben

DIN 7968

Sechskant-Passschrauben
für Stahlkonstruktion

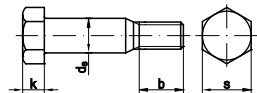

Maße	M 12	M 16	M 20	M 24	M 27	M 30
b	20,5	24,5	28,5	33	35,5	38,5
k	8	10	13	15	17	19
$d_{s \text{ min.}}$	12,74	16,74	20,71	24,71	27,71	30,67
s	18	24	30	36	41	46

mit Mutter nach ISO 4032 oder ISO 4034

Verfügbare Abmessungen auf den folgenden Seiten:

Stahl/Stahl mit Oberfläche: [S. 352](#)

DIN 7969

Senkschrauben mit Schlitz
für Stahlkonstruktionen

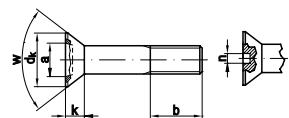

Maße	M 12	M 16	M 20	M 24
W	75°	75°	60°	60°
b ₁	22	28	32	38
b ₂	28	35	40	50
$d_{k \text{ max.}}$	21	28	32	38
k	7	9	11,5	13
n	2,5	2,5	3	3
t	3	3	3,5	3,5
a _{max.}	14,7	19,6	22,4	26,6

mit Mutter nach ISO 4032 oder ISO 4034,

b₁ für l ≤ 60 bei M 12 und l ≤ 80 bei M 16 - M 24

b₂ für l > 60 bei M 12 und l > 80 bei M 16 - M 24

Verfügbare Abmessungen auf den folgenden Seiten:

Stahl/Stahl mit Oberfläche: [S. 354](#)

DIN 7990

Sechskantschrauben für
Stahlkonstruktionen

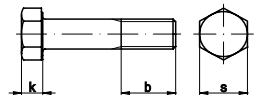

Maße	M 12	M 16	M 20	M 24	M 27	M 30
k	8	10	13	15	17	19
s	18	24	30	36	41	46
b	20,5	24,5	28,5	33	35,5	38,5

mit Mutter nach ISO 4032 oder ISO 4034

Verfügbare Abmessungen auf den folgenden Seiten:

Stahl/Stahl mit Oberfläche: [S. 367](#)



Stahlbau-Schrauben, -Muttern, -Scheiben

EN 14399-4

ersetzt DIN 6914

Sechskantschrauben mit großer SW
für HV-Verbindungen im Stahlbau

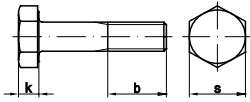

Maße	M 12	M 16	M 20	M 22	M 24	M 27	M 30	M 36	M 42*
k	8	10	13	14	15	17	19	23	26
s	22	27	32	36	41	46	50	60	70
b	23	28	33	34	39	41	44	52	74

*gemäß DAST-Richtlinie 021

Verfügbare Abmessungen auf den folgenden Seiten:

Stahl/Stahl mit Oberfläche: [S. 397](#)

EN 14399-8

ersetzt DIN 7999

Sechskant-Passschrauben mit großer SW
für HV-Verbindungen im Stahlbau

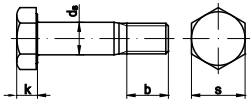

Maße	M 16	M 20	M 22	M 24	M 27	M 30
k	10	13	14	15	17	19
d _s	17	21	23	25	28	31
b	28	33	34	39	41	44
s	27	32	36	41	46	50

Verfügbare Abmessungen auf den folgenden Seiten:

Stahl/Stahl mit Oberfläche: [S. 402](#)

EN 14399-4

ersetzt DIN 6915

Sechskantmuttern mit großer SW
für HV-Verbindungen im Stahlbau

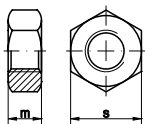

Maße	M 12	M 16	M 20	M 22	M 24
m	10	13	16	18	20
s	22	27	32	36	41

Maße	M 27	M 30	M 36	M 42*
m	22	24	29	34
s	46	50	60	70

*gemäß DAST-Richtlinie 021

Verfügbare Abmessungen auf den folgenden Seiten:

Stahl/Stahl mit Oberfläche: [S. 402](#)

DIN 6917 Scheiben, vierkant, für HV-Verbindungen	Maßangaben siehe TI-86 (Scheiben/Ringe - Vierkantscheiben)
DIN 6918 Scheiben, vierkant, für HV-Verbindungen	



Stahlbau-Schrauben, -Muttern, -Scheiben

EN 14399-6

ersetzt DIN 6916

Scheiben, rund,
für HV-Verbindungen im Stahlbau

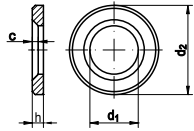

Maße	M 12	M 16	M 20	M 22	M 24	M 27	M 30	M 36	M 42*
$d_{1 \text{ min.}}$	13	17	21	23	25	28	31	37	43,4
$d_{2 \text{ max.}}$	24	30	37	39	44	50	56	66	78
h	3	4	4	4	4	5	5	6	8
$c_{\text{min.}}$	1,6	1,6	2	2	2	2,5	2,5	2,5	3

*gemäß DAST-Richtlinie 021

Verfügbare Abmessungen auf den folgenden Seiten:

Stahl/Stahl mit Oberfläche: [S. 402](#)

Artikel 88916

Sicherungsmuffen für HV

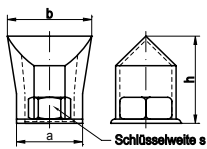

Maße	M 12	M 16	M 20	M 24	M 27	M 30	M 36
a	32	40	45	56	61	69	76
b	45	54	61	80	85	89	110
h	39	52	54	64	68	73	86
s	22	27	32	41	46	50	60

Verfügbare Abmessungen auf den folgenden Seiten:

Stahl/Stahl mit Oberfläche: [S. 402](#)



Klemmlängen für Stahlbauschrauben

HV-Schrauben Systeme nach EN 14399 - 4

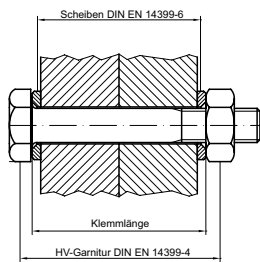

Passschrauben nach EN 14399 - 8

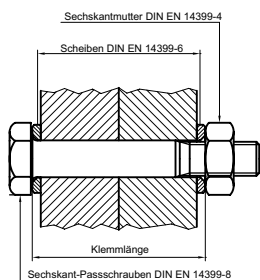

Gewinde Nennlänge	M 12		M 16		M 20		M 22		M 24		M 27		M 30		M 36		
	min.	max.	min.	max.	min.	max.	min.	max.	min.	max.	min.	max.	min.	max.	min.	max.	
30	11	16															
35	16	21															
40	21	26			13	18											
45	26	31			18	23											
50	31	36			23	28	22	27	19	24							
55	36	41			28	33	27	32	24	29							
60	41	46			33	38	32	37	29	34	26	31					
65	46	51			38	43	37	42	34	39	31	36					
70	51	56			43	48	42	47	39	44	36	41	34	39			
75	56	61			48	53	47	52	44	49	41	46	39	44			
80	61	66			53	58	52	57	49	54	46	51	44	49			
85	66	71			58	63	57	62	54	59	51	56	49	54	43	48	
90	71	76			63	68	62	67	59	64	56	61	54	59	48	53	
95	76	81			68	73	67	72	64	69	61	66	59	64	53	58	
100	81	86			73	78	72	77	69	74	66	71	64	69	58	63	
105	86	91			78	83	77	82	74	79	71	76	69	74	63	68	
110	91	96			83	88	82	87	79	84	76	81	74	79	68	73	
115	96	101			88	93	87	92	84	89	81	86	79	84	73	78	
120		101	106		97	102	97	102	89	94	86	91	84	89	78	83	
125				102	107	98	103	97	102	94	99	91	96	89	94	83	88
130				107	112	103	108	102	107	99	104	96	101	94	99	88	93
135				112	117	108	113	107	112	104	109	101	106	99	104	93	98
140				117	122	113	118	112	117	109	114	106	111	104	109	98	103
145				122	127	118	123	117	122	114	119	111	116	109	114	103	108
150				127	132	123	128	122	127	119	124	116	121	114	119	108	113
155				132	137	128	133	127	132	124	129	121	126	119	124	113	118
160				137	142	133	138	132	137	129	134	126	131	124	129	118	123
165				142	147	138	143	137	142	134	139	131	136	129	134	123	128
170				147	152	143	148	142	147	139	144	136	141	134	139	128	133
175				152	157	148	153	147	152	144	149	141	146	139	144	133	138
180				157	162	153	158	152	157	149	154	146	151	144	149	138	143
185				162	166	158	162	157	161	154	159	151	156	149	154	143	148
190				167	171	163	167	162	166	159	164	156	161	154	159	148	153
195				172	176	168	172	167	171	164	169	161	166	159	164	153	158
200				177	181	173	177	172	176	169	174	166	171	164	169	158	163
210				187	191	183	187	182	186	179	184	176	181	174	179	168	173
220				197	201	193	197	192	196	189	194	186	191	184	189	178	183
230						203	207	202	206	199	204	196	201	194	199	188	193
240						213	217	212	216	209	214	206	211	204	209	198	203
250						223	227	222	226	219	224	216	221	214	219	208	213
260						233	237	232	236	229	233	226	230	224	228	218	222

Die max. Klemmlängenwerte sind so festgelegt, dass im vorgespannten Zustand das Schraubengewinde min. 1 P über die Mutter hinausragt. Angaben zur Scheibendicke EN 14399-6

→ TI-58, -85, -86

Bemessungsregeln und Montagevorschriften → EN 1090-1/EN 1993-1, -8

Sechskantmuttern

DIN 431

Rohrmuttern mit Rohrgewinde nach ISO 228-1

Form B = mit einseitiger Gewindeansenkung

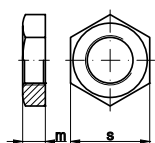

Maße	G 1/8	G 1/4	G 3/8	G 1/2	G 3/4
$m_{max.}$	6,48	6,48	7,58	5,58	9,58
$s_{max.}$	19	22	27	32	36

Maße	G 1	G 1 1/4	G 1 1/2	G 1 3/4	G 2
$m_{max.}$	10,58	11,7	12,7	13,7	13,7
$s_{max.}$	46	55	60	70	75

Verfügbare Abmessungen auf den folgenden Seiten:

Stahl/Stahl mit Oberfläche: S. 80 | Edelstahl: S. 465 | Nichteisen-Werkstoffe: S. 618



Sechskantmuttern

ISO 4035

ersetzt DIN 439

Niedrige Sechskantmuttern

Form B = mit Fase

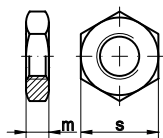

Maße	M 2	M 2,5	M 3	M 3,5	M 4	M 5	M 6	M 8
$m_{max.}$	1,2	1,6	1,8	2	2,2	2,7	3,2	4
$S_{ISO/DIN}$	4	5	5,5	6	7	8	10	13

Maße	M 10	M 12	M 14	M 16	M 18	M 20	M 22	M 24
$m_{max.}$	5	6	7	8	9	10	11	12
$S_{ISO/DIN}$	16/17	18/19	21/22	24	27	30	34/32	36

Maße	M 27	M 30	M 33	M 35	M 36	M 39	M 42	M 48
$m_{max.}$	13,5	15	16,5	17,5	18	19,5	21	24
$S_{ISO/DIN}$	41	46	50	55	55	60	65	75

Verfügbare Abmessungen auf den folgenden Seiten:

Stahl/Stahl mit Oberfläche: [S. 284](#), [S. 82](#) | Edelstahl: [S. 547](#), [S. 467](#) | Nichteisen-Werkstoffe: [S. 638](#), [S. 619](#)

DIN 2510

Sechskantmutter für Schraubenbolzen mit Dehnschaft

Form NF = Regelform

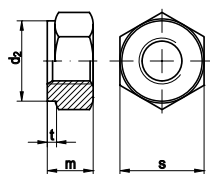

Maße	M 12	M 14*	M 16	M 20	M 24	M 27	M 30
s	22	24	27	32	36	41	46
m	12	14	16	20	24	27	30
d_2	21	23	26	31	35	40	45
t	2	2	2	2	3	3	3

Maße	M 33	M 36	M 39	M 42	M 45	M 48
s	50	55	60	65	70	75
m	33	36	39	42	45	48
d_2	49	53,5	58,5	63,5	68,5	73,5
t	3	3	3	3	3	4

*Abmessung nicht genormt, Richtwerte

Verfügbare Abmessungen auf den folgenden Seiten:

Stahl/Stahl mit Oberfläche: [S. 233](#)

ASME B 18.2.2

Nuts Muttern mit zölligem Gewinde

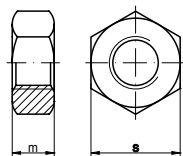

Hex nuts*, Sechskantmuttern

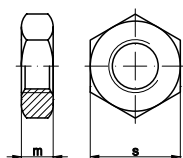

Hex jam nuts*, Sechskantmuttern

alle Maße in inch

*nach ASME B 18.2.2: 2010 Tabelle 4

Maße	1/4	5/16	3/8	7/16	1/2	9/16	5/8
s	7/16	1/2	9/16	11/16	3/4	7/8	15/16
m (hex nuts)	0,226	0,273	0,337	0,385	0,448	0,496	0,559
m (jam nuts)	0,163	0,195	0,227	0,26	0,323	0,324	0,387

Maße	3/4	7/8	1	1 1/8	1 1/4	1 1/2	1 3/4
s	1 1/8	1 5/16	1 1/2	1 11/16	1 7/8	2 1/4	2 5/8
m (hex nuts)	0,665	0,776	0,887	0,999	1,094	1,317	1,540
m (jam nuts)	0,446	0,51	0,575	0,639	0,751	0,88	1,009

Verfügbare Abmessungen auf den folgenden Seiten:

Stahl/Stahl mit Oberfläche: [S. 414](#) | Edelstahl: [S. 592](#)



Sechskantmuttern

DIN 917

Sechskant-Hutmuttern,
niedrige Form

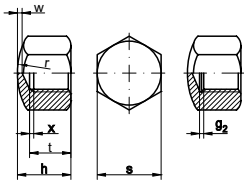

ab M 10 Freistich nach DIN 76-1
(Form D kurz) mit dem Maß $g_{2 \max}$.

Maße	M 4	M 5	M 6	M 8	M 10	M 12
$x_{\max}/g_{2 \max}$	1,05	1,2	1,5	1,87	2,25	6,4
h	5,5	7	9	12	14	16
r	8	10	12	15	20	25
$S_{ISO/DIN}$	7	8	10	13	16/17	18/19
t_{\min}	4,16	4,96	6,71	9,21	10,65	13,15
w_{\min}	1	1	1,5	2	2	2

Maße	M 14	M 16	M 20	M 24	M 30	M 36
$x_{\max}/g_{2 \max}$	7,3	7,3	9,3	10,7	12,7	14
h	18	20	25	30	34	44
r	28	30	35	40	60	70
$S_{ISO/DIN}$	21/22	24	30	36	46	55
t_{\min}	14,65	16,65	20,58	23,58	27,58	35,5
w_{\min}	2	2	2,5	3	3	4

Verfügbare Abmessungen auf den folgenden Seiten:

Stahl/Stahl mit Oberfläche: [S. 141](#) | Edelstahl: [S. 485](#) | Nichteisen-Werkstoffe: [S. 624](#)

ISO 4032, 8673

ersetzt DIN 934

Sechskantmuttern Typ 1
ISO 8673 mit Feingwinde

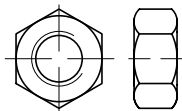

Maße	M 1*	M 1,2*	M 1,4*	M 1,6	M 1,7**	M 2	M 2,3**	M 2,5
$m_{ISO/DIN}$	0,8	1	1,2	1,3	1,4	1,6	1,8	2
$S_{ISO/DIN}$	2,5	3	3	3,2	3,5	4	4,5	5

Maße	M 2,6**	M 3	M 3,5	M 4	M 5	M 6	M 7*	M 8
$m_{ISO/DIN}$	2	2,4	2,8	3,2	4,7/4	5,2/5	5,5	6,8/6,5
$S_{ISO/DIN}$	5	5,5	6	7	8	10	11	13

Maße	M 10	M 12	M 14	M 16	M 18	M 20	M 22	M 24
$m_{ISO/DIN}$	8,4/8	10,8/10	12,8/11	14,8/13	15,8/15	18/16	19,4/18	21,5/19
$S_{ISO/DIN}$	16/17	18/19	21/22	24	27	30	34/32	36

Maße	M 26**	M 27	M 28**	M 30	M 32**	M 33	M 35**	M 36
$m_{ISO/DIN}$	22	23,8/22	22	25,6/24	26	28,7/26	29	31/29
$S_{ISO/DIN}$	41	41	41	46	50	50	55	55

Maße	M 38**	M 39	M 40**	M 42	M 45	M 48	M 50**	M 52
$m_{ISO/DIN}$	31	33,4/31	31	34	36	38	38	42
$S_{ISO/DIN}$	60	60	60	65	70	75	75	80

Maße	M 56	M 58**	M 60	M 64	M 68*	M 72*	M 76*	M 80*
$m_{ISO/DIN}$	45	48	48	51	54	58	61	64
$S_{ISO/DIN}$	85	90	90	95	100	105	110	115

Maße	M 85*	M 90*	M 95**	M 100*	M 105**	M 110*	M 120**
$m_{ISO/DIN}$	68	72	76	80	84	88	96
$S_{ISO/DIN}$	120	130	135	145	150	155	170

*Maße entsprechen der DIN 934

**Maße entsprechen der DIN 934:1968

Verfügbare Abmessungen auf den folgenden Seiten:

Stahl/Stahl mit Oberfläche: [S. 278](#), [S. 369](#), [S. 168](#) | Edelstahl: [S. 544](#), [S. 582](#), [S. 495](#)

Nichteisen-Werkstoffe: [S. 637](#), [S. 642](#), [S. 626](#)



Sechskantmuttern

ISO 4033

Sechskantmuttern Typ 2

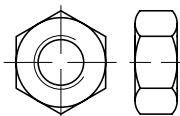

Maße	M 6	M 8	M 10	M 12	M 16
m	5,7	7,5	9,3	12	16,4
s	10	13	16	18	24

Maße	M 20	M 24	M 27*	M 30	M 36
m	20,3	23,9	26,7	28,6	34,7
s	30	36	41	46	55

*nicht in ISO genormt, Richtwerte

Verfügbare Abmessungen auf den folgenden Seiten:

Stahl/Stahl mit Oberfläche: [S. 284](#)

ISO 4035, 8675

ersetzt DIN 439-2, 936

Niedrige Sechskantmuttern mit Fasen

ISO 8675 mit Feingewinde

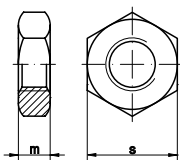

Maße	M 2	M 2,5	M 3	M 3,5	M 4	M 5	M 6	M 8
m _{ISO/DIN}	1,2	1,6	1,8	2	2,2	2,7	3,2	4/5
S _{ISO/DIN}	4	5	5,5	6	7	8	10	13

Maße	M 10	M 12	M 14	M 16	M 18	M 20	M 22	M 24
m _{ISO/DIN}	5/6	6/7	7/8	8	9	10/9	11/10	12/10
S _{ISO/DIN}	16/17	18/19	21/22	24	27	30	34/32	36

Maße	M 26	M 27	M 28*	M 30	M 32*	M 33	M 35*	M 36
m _{ISO/DIN}	13/12	13,5/12	14/12	15/12	16/14	16,5/14	17,5/14	18/14
S _{ISO/DIN}	41	41	41	46	50	50	55	55

Maße	M 38*	M 39	M 40*	M 42	M 45	M 48	M 50*	M 52
m _{ISO/DIN}	19/16	19,5/16	20/16	21/16	22,5/18	24/18	25/20	26/20
S _{ISO/DIN}	60	60	60	65	70	75	75	80

*nicht in ISO genormt,
Maße gemäß DIN 936:1963

Verfügbare Abmessungen auf den folgenden Seiten:

Stahl/Stahl mit Oberfläche: [S. 284](#), [S. 371](#), [S. 174](#) | Edelstahl: [S. 547](#), [S. 582](#), [S. 497](#) | Nichteisen-Werkstoffe: [S. 638](#), [S. 643](#), [S. 627](#)

DIN 1587

Sechskant-Hutmuttern,
hohe Form

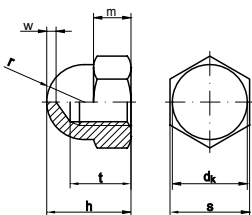

Maße	M 3*	M 4	M 5	M 6	M 8	M 10	M 12	M 14
d _{k max.}	5,8	6,5	7,5	9,5	12,5	15	17	20
m _{max.}	2,4	3,2	4	5	6,5	8	10	11
r	2,9	3,25	3,75	4,75	6,25	7,5	8,5	10
S _{ISO/DIN}	5,5	7	8	10	13	16/17	18/19	21/22
t _{min.}	4,5	5,26	7,21	7,71	10,65	12,65	15,65	17,65
W _{min.}	2	2	2	2	2	2	3	4
h	6	8	10	12	15	18	22	25

Maße	M 16	M 18	M 20	M 22	M 24	M 27*	M 30*
d _{k max.}	23	26	28	33	34	39	44
m _{max.}	13	15	16	18	19	22	24
r	11,5	13	14	16,5	17	19,5	22
S _{ISO/DIN}	24	27	30	34/32	36	41	46
t _{min.}	20,58	24,58	25,58	28,58	30,5	35	39
W _{min.}	4	5	5	5	6	7	7
h	28	32	34	39	42	45	50

*nicht genormt, Richtwerte

Verfügbare Abmessungen auf den folgenden Seiten:

Stahl/Stahl mit Oberfläche: [S. 221](#) | Edelstahl: [S. 521](#) | Nichteisen-Werkstoffe: [S. 633](#)



Sechskantmuttern

DIN 6330

Sechskantmuttern 1,5 d hoch

Form B = einseitig kugelige Auflagefläche

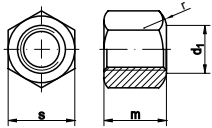

Maße	M 6	M 8	M 10	M 12	M 14	M 16
d ₁	7	9	11,5	14	16	18
m	9	12	15	18	21	24
r	9	11	15	17	20	22
s	10	13	16/17*	18/19*	22	24

Maße	M 18	M 20	M 22	M 24	M 27	M 30
d ₁	20	22	25	26	29	32
m	27	30	33	36	40	45
r	25	27	29	32	37	41
s	27	30	32	36	41	46

*Schlüsselweite nach DIN 6330: 1965-03

Verfügbare Abmessungen auf den folgenden Seiten:

Stahl/Stahl mit Oberfläche: [S. 309](#) | Edelstahl: [S. 553](#)

DIN 6331

Sechskantmuttern 1,5 d hoch,
mit Bund

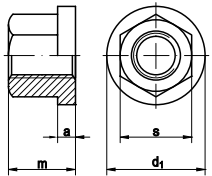

Maße	M 6	M 8	M 10	M 12	M 14	M 16	M 18
a	3	3,5	4	4	4	5	5
d ₁	14	18	22	25	28	31	34
m	9	12	15	18	21	24	27
s	10	13	16	18	22	24	27

Maße	M 20	M 22	M 24	M 27	M 30	M 36	M 42
a	6	6	6	7	8	10	12
d ₁	37	40	45	50	58	68	80
m	30	33	36	40	45	54	63
s	30	32	36	41	46	55	65

Verfügbare Abmessungen auf den folgenden Seiten:

Stahl/Stahl mit Oberfläche: [S. 309](#) | Edelstahl: [S. 553](#)

~DIN 6334

Sechskantmuttern, 3 d hoch

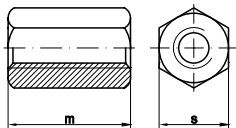

Maße	M 6	M 8	M 10	M 12	M 16	M 20	M 24	M 30	M 36
m	18	24	30	36	48	60	72	90	108
s	10	13	17	19	24	30	36	46	55

Verfügbare Abmessungen auf den folgenden Seiten:

Stahl/Stahl mit Oberfläche: [S. 310](#) | Edelstahl: [S. 553](#)

EN 1661

ersetzt DIN 6923

Sechskantmuttern mit Flansch

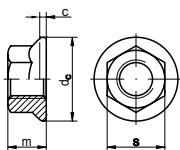

Maße	M 4	M 5	M 6	M 8	M 10	M 12	M 16	M 20
d _{c max.}	10	11,8	14,2	17,9	21,8	26	34,5	42,8
m _{max.}	4,65	5	6	8	10	12	16	20
s _{EN/DIN}	7	8	10	13	16/15	18	24	30

Verfügbare Abmessungen auf den folgenden Seiten:

Stahl/Stahl mit Oberfläche: [S. 222](#), [S. 322](#) | Edelstahl: [S. 521](#), [S. 558](#)



Sechskantmuttern

EN 13024

Leichtbaumuttern mit Flansch

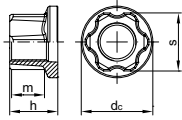

Maße	M 16x1,5
$d_{c \max.}$	30,5
$h_{\max.}$	20,5
$m_{\min.}$	9,5
s	24

Verfügbare Abmessungen auf den folgenden Seiten:

Stahl/Stahl mit Oberfläche: [S. 396](#)

DIN 74361

Kugelbundmuttern
(Kegelbundmuttern)
Form A

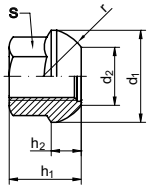

Maße	M 14x1,5	M 18x1,5	M 20x1,5
d_1	26	28	33
d_2	17	21	24,5
h_1	20	25	27
h_2	7,5	7,5	9
r	14	16	18
s	19	24	27

Verfügbare Abmessungen auf den folgenden Seiten:

Stahl/Stahl mit Oberfläche: [S. 410](#)

DIN 74361

Flachbundmuttern
Form B

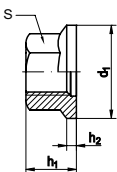

Maße	M 14x1,5	M 18x1,5	M 20x1,5	M 22x1,5
d_1	27	29	34	36
h_1	15	18	20	22
h_2	3	4	5	6
s	19	24	27	30

Verfügbare Abmessungen auf den folgenden Seiten:

Stahl/Stahl mit Oberfläche: [S. 410](#)

DIN 80705

Flache Muttern
mit kleiner Schlüsselweite

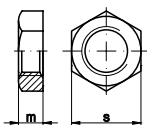

Maße	M 14x1,5	M 16x1,5	M 18x1,5	M 20x1,5	M 22x1,5	M 26x1,5	M 30x2
m	6	6	6	6	7	8	8
s	19	22	24	27	30	36	41



Sechskantmuttern

Artikel 88087

Verbindungs-muffen, Sechskant,
durchgehendes metrisches Innengewinde

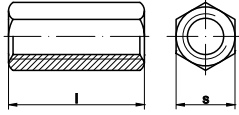

Maße	M 6	M 8	M 10	M 12	M 16	M 20	M 24	M 30
s	10	13	17	19	24	30	36	46
l	20/25/ 30/40	30	30	40/50	50	50	50	90

Verfügbare Abmessungen auf den folgenden Seiten:

Stahl/Stahl mit Oberfläche: [S. 417](#) | Edelstahl: [S. 592](#)

Artikel 88090

Sechskantmuttern mit Trapezgewinde,
1,5 d hoch

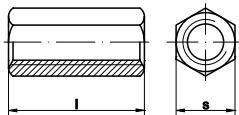

Maße	TR 16x4	TR 20x4	TR 24x5	TR 30x6
s	27	30	36	46
m	24	30	36	45

Verfügbare Abmessungen auf den folgenden Seiten:

Stahl/Stahl mit Oberfläche: [S. 417](#)



Sicherungsmuttern

DIN 935-1

Sechskant-Kronenmuttern

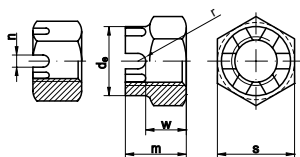

≤ M 10 ≥ M 12

Maße	M 4	M 5	M 6	M 8	M 10	M 12	M 14	M 16
d _{e max.}	-	-	-	-	-	16	18	22
m	5	6	7,5	9,5	12	15	16	19
n _{min.}	1,2	1,4	2	2,5	2,8	3,5	3,5	4,5
S _{ISO/DIN}	7	8	10	13	16/17	18/19	21/22	24
W _{max.}	3,2	4	5	6,5	8	10	11	13
Splint	1x10	1,2x12	1,6x14	2x16	2,5x20	3,2x22	3,2x25	4x28
Maße	M 18	M 20	M 22	M 24	M 27	M 28*	M 30	M 32*
d _{e max.}	25	28	32	34	38	38	42	46
m	21	22	26	27	30	30	33	35
n _{min.}	4,5	4,5	5,5	5,5	5,5	5,5	7	7
S _{ISO/DIN}	27	30	34/32	36	41	41	46	50
W _{max.}	15	16	18	19	22	22	24	26
Splint	4x32	4x36	5x36	5x40	5x45	5x50	6,3x50	6,3x56
Maße	M 33	M 36	M 38*	M 39	M 40*	M 42	M 45	M 48
d _{e max.}	46	50	55	55	55	58	62	65
m	35	38	40	40	48	46	48	50
n _{min.}	7	7	7	7	7	9	9	9
S _{ISO/DIN}	50	55	60	60	60	65	70	75
W _{max.}	26	29	31	31	31	34	36	38
Splint	6,3x56	6,3x63	6,3x70	6,3x71	6,3x70	8x71	8x80	8x80
Maße	M 52	M 56	M 60	M 64	M 68	M 72	M 76	M 80
d _{e max.}	70	75	80	85	90	95	100	105
m	54	57	63	66	69	73	76	79
n _{min.}	9	9	11	11	11	11	11	11
S _{ISO/DIN}	80	85	90	95	100	105	110	115
W _{max.}	42	45	48	51	54	58	61	64
Splint	8x90	8x100	10x100	10x100	10x112	10x112	10x125	10x140

*gemäß DIN 935:1963

Verfügbare Abmessungen auf den folgenden Seiten:

Stahl/Stahl mit Oberfläche: S. 173 | Edelstahl: S. 497

DIN 937

Niedrige Sechskant-Kronenmuttern

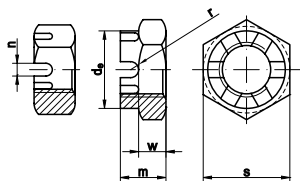

≤ M 10 ≥ M 12

Maße	M 6	M 8	M 10	M 12	M 14	M 16	M 18	M 20
d _{e max.}	-	-	-	17	19	22	25	28
m	6	8	9	10	11	12	13	13
n _{min.}	2	2,5	2,8	3,5	3,5	4,5	4,5	4,5
s	10	13	17	19	22	24	27	30
W _{max.}	3,5	4,5	5	6	7	7	8	8
Splint	1,6x14	2x16	2,5x20	3,2x22	3,2x25	4x28	4x32	4x36
Maße	M 22	M 24	M 26*	M 27	M 28*	M 30	M 32*	M 33
d _{e max.}	30	34	38	38	38	42	46	46
m	15	15	30	17	30	18	20	20
n _{min.}	5,5	5,5	5,5	5,5	5,5	7	7	7
s	32	36	41	41	41	46	50	50
W _{max.}	9	9	22	11	22	11	13	13
Splint	5x36	5x40	5x50	5x45	5x50	6,3x50	6x60	6,3x56
Maße	M 35*	M 36	M 39	M 40*	M 42	M 48	M 52	
d _{e max.}	50	50	55	55	58	65	70	
m	20	20	22	22	23	25	27	
n _{min.}	7	7	7	7	9	9	9	
s	55	55	60	60	65	75	80	
W _{max.}	13	13	13	13	14	16	18	
Splint	6x65	6,3x63	6,3x71	6x70	8x71	8x80	8x90	

*gemäß DIN 937:1963

Verfügbare Abmessungen auf den folgenden Seiten:

Stahl/Stahl mit Oberfläche: S. 176



Sicherungsmuttern

DIN 979

Niedrige Sechskant-Kronenmuttern

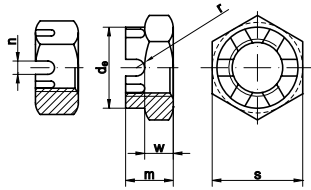

≤ M 10 ≥ M 12

Maße	M 16	M 18	M 20	M 24	M 30	M 36	M 42	M 48	M 52
$d_{e \max.}$	22	25	28	34	42	50	58	65	70
m	13	15	16	19	24	29	33	36	38
$n_{\min.}$	4,5	4,5	4,5	5,5	7	7	9	9	9
s	24	27	30	36	46	55	65	75	80
$w_{\max.}$	7	9	10	11	15	20	22	24	26
Splint	4x28	4x32	4x36	5x40	6,3x50	6,3x63	8x71	8x80	8x90

Verfügbare Abmessungen auf den folgenden Seiten:

Stahl/Stahl mit Oberfläche: [S. 198](#)

ISO 7042, 10513 ersetzt DIN 980, 6925	Normumstellung und Maßübersicht → TI-9
ISO 7040, 10512 ersetzt DIN 982, 6924	
ISO 10511 ersetzt DIN 985	

DIN 986

Sechskant-Hutmuttern mit Klemmteil mit nichtmetallischem Einsatz

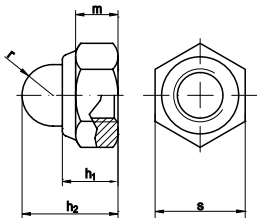

Temperaturbeständigkeit der Klemmringe
siehe Preisseiten

Maße	M 4	M 5	M 6	M 8	M 10	M 12	M 16
h_1	5,6	6	7,5	8,9	10,5	13,5	16,5
h_2	9,6	10,5	12	14	18,1	22,5	27,5
$m_{\min.}$	2,9	4,4	4,9	6,44	8,04	10,37	14,1
r	2,5	3	3,5	4,6	5,8	6,8	8,8
s	7	8	10	13	17	19	24

Verfügbare Abmessungen auf den folgenden Seiten:

Stahl/Stahl mit Oberfläche: [S. 203](#) | Edelstahl: [S. 512](#)

DIN 7967

Sicherungsmuttern (Palmuttern)

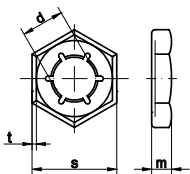

Maße	M 6	M 8	M 10	M 12	M 14	M 16	M 20	M 22
d	5,3	6,9	8,6	10,4	12	14,1	17,6	19,6
m	3	3,5	4	4,5	5	5	6	6
s	10	13	17	19	22	24	30	32
t	0,4	0,5	0,5	0,6	0,6	0,7	0,8	0,8

Maße	M 24	M 27	M 30	M 33	M 36	M 42	M 48
d	21	24,2	26,6	29,8	32,2	37,6	43,9
m	7	7	8	8	9	11	14
s	36	41	46	50	55	65	75
t	0,9	1	1,1	1,2	1,3	1,4	1,6

Verfügbare Abmessungen auf den folgenden Seiten:

Stahl/Stahl mit Oberfläche: [S. 352](#) | Edelstahl: [S. 574](#)

Sicherungsmuttern

EN 1663, 1664

Sechskantmutter mit Klemmteil
und Flansch

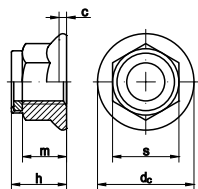

EN 1663 = mit nichtmetallischem Einsatz

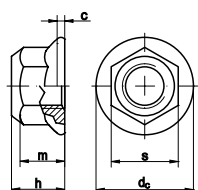

EN 1664 = Ganzmetallmutter

Maße	M 5	M 6	M 8	M 10	M 12	M 16
$c_{min.}$	1	1,1	1,2	1,5	1,8	2,4
d_c	11,8	14,2	17,9	21,8	26	34,5
$h_{max. (1663)}$	7,1	9,1	11,1	13,5	16,1	20,3
$h_{max. (1664)}$	6,2	7,3	9,4	11,4	13,8	18,3
$m_{min.}$	4,7	5,7	7,6	9,6	11,6	15,3
s	8	10	13	16	18	24

Verfügbare Abmessungen auf den folgenden Seiten:

Stahl/Stahl mit Oberfläche: [S. 223](#), [S. 223](#)

Artikel 13023

Sechskantmutter mit Flansch,
gemäß MBN 13023 Form A

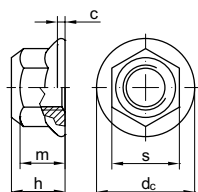

Maße	M 12x1,5	M 14x1,5	M 16x1,5
$c_{min.}$	1,8	2,1	2,4
$d_{c max.}$	26	29,9	34,5
$h_{max.}$	13,8	15,9	18,3
$m_{min.}$	11,6	13,3	15,3
s	18	21	24

Verfügbare Abmessungen auf den folgenden Seiten:

Stahl/Stahl mit Oberfläche: [S. 396](#)

Artikel 88034

HEICO-LOCK-Keilsicherungsmuttern

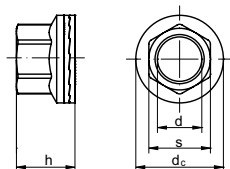

Maße	M 6	M 8	M 10	M 12	M 16
Typ	HLM	HLM	HLM	HLM	HLM
h	9,2	12,2	15,2	17,2	21,2
d_c	14,2	17,9	21,8	26	34,5
s	10	13	16	18	24

Verfügbare Abmessungen auf den folgenden Seiten:

Stahl/Stahl mit Oberfläche: [S. 434](#)



Sicherungsmuttern

Artikel 88105

Sechskantmuttern mit Klemmteil,
THERMAG-Muttern
Ganzmetallmutter

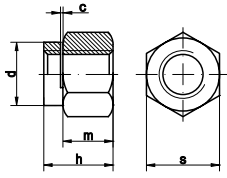

Maße	M 8 SW12	M 8 SW13	M 10 SW14	M 10 SW17	M 12 SW17	M 12 SW19
d	11,5	12,5	13,5	16,5	16,5	18,5
s	12	13	14	17	17	19
m	5,5	5,5	6,5	6,5	7,5	7,5
c	0,5	0,5	0,5	0,5	0,5	0,5

Verfügbare Abmessungen auf den folgenden Seiten:

Stahl/Stahl mit Oberfläche: [S. 199](#)

Artikel 88914

Sechskant-Flanschmuttern
mit Sperr-Rippen (RIPP-Muttern)

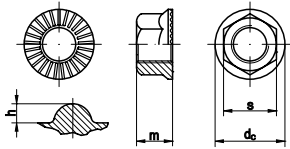

Maße	M 5	M 6	M 8	M 10	M 12	M 14	M 16
d _c	11,2	14,2	18,2	21	24	27,5	31
m	4,3	5,5	7	8,5	10	12	14
h	0,1	0,1	0,1	0,1	0,1	0,1	0,1
s	8	10	13	15	17	19	22
Anz. Rippen	28	36	48	48	60	60	72

Verfügbare Abmessungen auf den folgenden Seiten:

Stahl/Stahl mit Oberfläche: [S. 440](#)

Artikel 88934

Sechskant-Flanschmuttern
mit Sperrzähnen

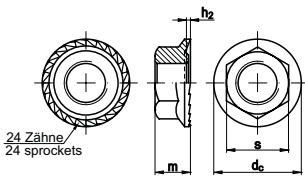

Maße	M 5	M 6	M 8	M 10	M 12	M 16
d _c	11,2	14,25	18,25	21	24	31
m	4,3	5,5	7	7,9	8,7	11,2
h _{2 min.}	0,15	0,17	0,2	0,25	0,25	0,28
Anz. Zähne	24	24	24	24	24	24

Verfügbare Abmessungen auf den folgenden Seiten:

Stahl/Stahl mit Oberfläche: [S. 442](#)

DIN 508

T-Nutensteine

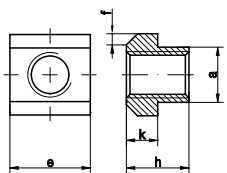

Maße	M 4	M 5	M 6	M 8	M 10	M 12	M 14	M 16	M 20	M 24
a	5	6	8	10	12	14	16	18	22	28
e	9	10	13	15	18	22	25	28	35	44
f	1	1,6	1,6	1,6	2,5	2,5	2,5	2,5	2,5	4
h	6,5	8	10	12	14	16	18	20	28	36
k	3	4	6	6	7	8	9	10	14	18

Verfügbare Abmessungen auf den folgenden Seiten:

Stahl/Stahl mit Oberfläche: [S. 92](#)



Schweißmuttern

DIN 928

Vierkant-Schweißmuttern

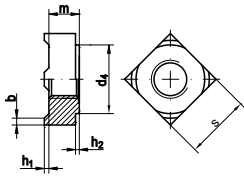

Maße	M 4	M 5	M 6	M 8	M 10	M 12
b	0,8	1	1,2	1,5	1,8	2
$d_{4 \text{ min.}}$	6,4	8,2	9,1	12,8	15,6	17,4
h_1	0,6	0,8	0,8	1	1,2	1,4
$h_{2 \text{ min.}}$	0,4	0,6	0,7	1,1	1,25	1,75
m	3,5	4,2	5	6,5	8	9,5
s	7	9	10	14	17	19

Verfügbare Abmessungen auf den folgenden Seiten:

Stahl/Stahl mit Oberfläche: [S. 143](#)

DIN 929

Sechskant-Schweißmuttern

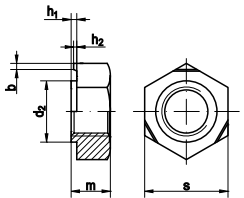

Maße	M 3	M 4	M 5	M 6	M 8	M 10	M 12	M 14	M 16
b	0,8	0,8	0,8	0,9	1	1,25	1,25	1,5	1,5
d_2	4,5	6	7	8	10,5	12,5	14,8	16,8	18,8
h_1	0,55	0,65	0,7	0,75	0,9	1,15	1,4	1,8	1,8
h_2	0,25	0,35	0,4	0,4	0,5	0,65	0,8	1	1
m	3	3,5	4	5	6,5	8	10	11	13
s	7,5	9	10	11	14	17	19	22	24

Verfügbare Abmessungen auf den folgenden Seiten:

Stahl/Stahl mit Oberfläche: [S. 143](#) | Edelstahl: [S. 486](#)



Sonderformen

DIN 315

Flügelmuttern
runde Flügelform

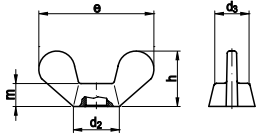

*gemäß DIN 315:1956

**Abmessung nicht genormt, Richtwerte

Maße	M 3*	M 4	M 5	M 6	M 8	M 10
$e_{\max.}$	19	20	26	33	39	51
$h_{\max.}$	9,5	10,5	13	17	20	25
$m_{\max.}$	3,9	4,6	6,5	8	10	12
$d_{2 \max.}$	7	8	11	13	16	20
$d_{3 \max.}$	6	7	9	11	12,5	16,5

Maße	M 12	M 14**	M 16	M 20	M 24
$e_{\max.}$	65	63,5	73	90	110
$h_{\max.}$	33,5	32,3	37,5	46,5	56,5
$m_{\max.}$	14	12	17	21	25
$d_{2 \max.}$	23	21,5	29	35	44
$d_{3 \max.}$	19,5	-	23	29	37,5

Verfügbare Abmessungen auf den folgenden Seiten:

Stahl/Stahl mit Oberfläche: [S. 77](#) | Edelstahl: [S. 464](#) | Nichteisen-Werkstoffe: [S. 617](#)

DIN 466, 467

Rändelmuttern

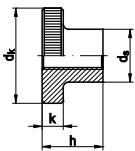

DIN 466 = hohe Form

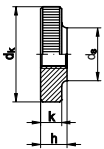

DIN 467 = niedrige Form

Maße	M 3	M 4	M 5	M 6	M 8	M 10	M 12*
d_k	12	16	20	24	30	36	35
d_s	6	8	10	12	16	20	20
k	2,5	3,5	4	5	6	8	8
$h_{DIN 466}$	7,5	9,5	11,5	15	18	23	23
$h_{DIN 467}$	3	4	5	6	8	10	10

*Abmessung nicht genormt, Richtwerte

Verfügbare Abmessungen auf den folgenden Seiten:

Stahl/Stahl mit Oberfläche: [S. 88](#) | Edelstahl: [S. 469](#) | Nichteisen-Werkstoffe: [S. 620](#)

DIN 546

Schlitzmuttern

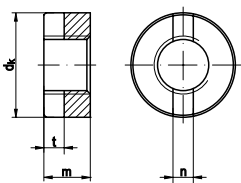

Maße	M 3	M 4	M 5	M 6	M 8	M 10	M 12	M 16
$d_{k \max.}$	6	8	9	11	14	18	21	26
$m_{\max.}$	2,5	3,5	4,2	5	6,5	8	10	12
n	1,2	1,4	2	2,5	3	3,5	4	4
t	1	1,2	1,5	2	2,5	3,2	3,8	3,8

Verfügbare Abmessungen auf den folgenden Seiten:

Stahl/Stahl mit Oberfläche: [S. 92](#) | Edelstahl: [S. 470](#) | Nichteisen-Werkstoffe: [S. 620](#)



Sonderformen

DIN 981

Nutmuttern für Wälzlager

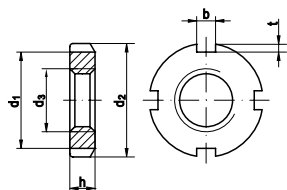

Maße	KM 0	KM 1	KM 2	KM 3	KM 4	KM 5	KM 6
d ₁	M 10x0,75	M 12x1	M 15x1	M 17x1	M 20x1	M 25x1,5	M 30x1,5
d ₂	18	22	25	28	32	38	45
d ₃	13,5	17	21	24	26	32	38
h	4	4	5	5	6	7	7
b	3	3	4	4	4	5	5
t	2	2	2	2	2	2	2
Sicherung*	MB 0	MB 1	MB 2	MB 3	MB 4	MB 5	MB 7

Maße	KM 7	KM 8	KM 9	KM 10	KM 11	KM 12	KM 13
d ₁	M 35x1,5	M 40x1,5	M 45x1,5	M 50x1,5	M 55x2	M 60x2	M 65x2
d ₂	52	58	65	70	75	80	85
d ₃	44	50	56	61	67	73	79
h	8	9	10	11	11	11	12
b	5	6	6	6	7	7	7
t	2	2,5	2,5	2,5	3	3	3
Sicherung*	MB 7	MB 8	MB 9	MB 10	MB 11	MB 12	MB 13

Maße	KM 14	KM 15	KM 16	KM 17	KM 18	KM 19	KM 20
d ₁	M 70x2	M 75x2	M 80x2	M 85x2	M 90x2	M 95x2	M 100x2
d ₂	92	98	105	110	120	125	130
d ₃	85	90	95	102	108	113	120
h	12	13	15	15	16	17	18
b	8	8	8	8	10	10	10
t	3,5	3,5	3,5	3,5	4	4	4
Sicherung*	MB 14	MB 15	MB 16	MB 17	MB 18	MB 19	MB 20

Maße	KM 22	KM 23	KM 24	KM 25	KM 26	KM 27
d ₁	M 110x2	M 115x2	M 120x2	M 125x2	M 130x2	M 135x2
d ₂	145	150	155	160	165	175
d ₃	133	137	138	148	149	160
h	19	19	20	21	21	22
b	12	12	12	12	12	14
t	5	5	5	5	5	6
Sicherung*	MB 22	MB 23	MB 24	MB 25	MB 26	MB 27

Maße	KM 28	KM 29	KM 30	KM 31	KM 32	KM 34
d ₁	M 140x2	M 145x2	M 150x2	M 155x3	M 160x3	M 165x3
d ₂	180	190	195	200	210	210
d ₃	160	171	171	182	182	193
h	22	24	24	25	25	26
b	14	14	14	16	16	16
t	6	6	6	7	7	7
Sicherung*	MB 28	MB 29	MB 30	MB 31	MB 32	MB 33

*Sicherungen DIN 5406

Verfügbare Abmessungen auf den folgenden Seiten:

Stahl/Stahl mit Oberfläche: [S. 200](#)



Sonderformen

DIN 1804

Nutmuttern

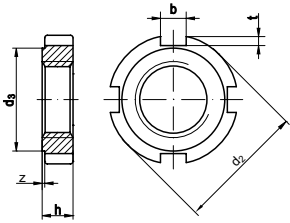

Maße	M 8x1	M 10x1	M 12x1,5	M 14x1,5	M 16x1,5	M 18x1,5	M 20x1,5	M 22x1,5
d ₂	20	25	28	30	32	34	36	40
d ₃	16	20	23	25	27	28	30	34
b	4	5	5	5	5	6	6	6
h	5	6	6	7	7	8	8	9
t	1,5	2	2	2	2	2,5	2,5	2,5
z	0,5	0,5	0,5	0,5	0,5	0,5	0,5	0,5
Anz. Nuten	4	4	4	4	4	4	4	4

Maße	M 24x1,5	M 26x1,5	M 28x1,5	M 30x1,5	M 32x1,5	M 35x1,5	M 38x1,5	M 40x1,5
d ₂	42	45	50	50	52	55	58	62
d ₃	36	38	43	43	45	48	50	54
b	6	7	7	7	7	7	8	8
h	9	10	10	10	11	11	11	12
t	2,5	3	3	3	3	3	3,5	3,5
z	0,5	0,5	0,5	0,5	0,5	0,5	0,5	0,5
Anz. Nuten	4	4	4	4	4	4	4	4

Maße	M 42x1,5	M 45x1,5	M 48x1,5	M 50x1,5	M 52x1,5	M 55x1,5	M 58x1,5	M 60x1,5
d ₂	62	68	75	75	80	80	90	90
d ₃	54	60	67	67	70	70	80	80
b	8	8	8	8	10	10	10	10
h	12	12	13	13	13	13	13	13
t	3,5	3,5	3,5	3,5	4	4	4	4
z	0,5	0,5	0,5	0,5	0,5	0,5	0,5	0,5
Anz. Nuten	4	6	6	6	6	6	6	6

Maße	M 62x1,5	M 65x1,5	M 68x1,5	M 70x1,5	M 72x1,5	M 75x1,5	M 80x2	M 85x2
d ₂	95	95	100	100	110	110	115	120
d ₃	85	85	90	90	100	100	105	110
b	10	10	10	10	10	10	10	10
h	14	14	14	14	14	14	16	16
t	4	4	4	4	4	4	4	4
z	0,5	0,5	0,5	0,5	0,5	0,5	1	1
Anz. Nuten	6	6	6	6	6	6	6	6

Maße	M 90x2	M 95x2	M 100x2	M 110x2	M 120x2			
d ₂	130	135	145	155	165			
d ₃	120	120	130	140	150			
b	10	12	12	12	12			
h	16	16	16	16	18			
t	4	5	5	5	5			
z	1	1	1	1	1			
Anz. Nuten	6	6	6	6	6			

Verfügbare Abmessungen auf den folgenden Seiten:

Stahl/Stahl mit Oberfläche: [S. 224](#) | Edelstahl: [S. 522](#)



Sonderformen

DIN 1816

Kreuzlochmuttern

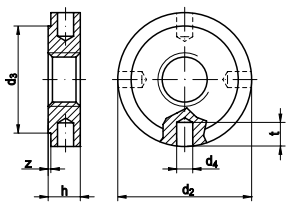

Maße	M 12x1,5	M 16x1,5	M 18x1,5	M 20x1,5	M 22x1,5	M 24x1,5	M 26x1,5
d ₂	28	32	34	36	40	42	45
d ₃	23	27	28	30	34	36	38
d ₄	3	4	4	4	4	4	5
h	6	7	8	8	9	9	10
t	5	6	6	6	6	6	6
z	0,5	0,5	0,5	0,5	0,5	0,5	0,5
Anz. Nuten	4	4	4	4	4	4	4

Maße	M 28x1,5	M 30x1,5	M 35x1,5	M 40x1,5	M 42x1,5	M 45x1,5	M 48x1,5
d ₂	50	50	55	62	62	68	75
d ₃	43	43	48	54	54	60	67
d ₄	5	5	5	6	6	6	6
h	10	10	11	12	12	12	13
t	7	7	7	8	8	8	10
z	0,5	0,5	0,5	0,5	0,5	0,5	0,5
Anz. Nuten	4	4	4	4	4	6	6

Maße	M 50x1,5	M 55x1,5	M 60x1,5	M 70x1,5	M 75x2	M 80x2
d ₂	75	80	90	100	110	115
d ₃	67	70	80	90	100	105
d ₄	6	6	6	8	8	8
h	13	13	13	14	14	16
t	10	10	10	12	12	12
z	0,5	0,5	0,5	0,5	0,5	1
Anz. Nuten	6	6	6	6	6	6

Verfügbare Abmessungen auf den folgenden Seiten:

Stahl/Stahl mit Oberfläche: [S. 225](#)



Sonderformen

DIN 70852

Nutmuttern

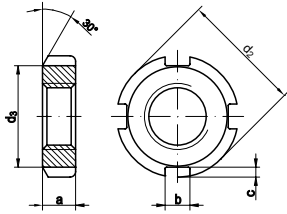

Maße	M 10x1	M 12x1,5	M 14x1,5	M 16x1,5	M 18x1,5	M 20x1,5	M 22x1,5	M 24x1,5
a	5	6	6	6	6	6	7	7
b	4,5	4,5	4,5	5,5	5,5	5,5	6,5	6,5
c	1,8	1,8	1,8	2,3	2,3	2,3	2,8	2,8
d ₂	20	22	24	28	30	32	36	38
d ₃	18	18	20	23	25	27	30	32
Anz. Nuten	4	4	4	4	4	4	4	4
Sicherung*	10	12	14	16	18	20	22	24

Maße	M 26x1,5	M 28x1,5	M 30x1,5	M 32x1,5	M 35x1,5	M 38x1,5	M 40x1,5	M 42x1,5
a	7	7	7	8	8	8	8	8
b	6,5	6,5	6,5	7	7	7	7	8
c	2,8	2,8	2,8	3,3	3,3	3,3	3,3	3,3
d ₂	40	42	44	48	50	54	56	60
d ₃	34	36	38	41	43	47	49	52
Anz. Nuten	4	4	4	4	4	4	4	4
Sicherung*	26	28	30	32	35	38	40	42

Maße	M 45x1,5	M 48x1,5	M 50x1,5	M 52x1,5	M 55x1,5	M 60x1,5	M 65x1,5	M 70x1,5
a	8	8	8	8	8	9	9	9
b	8	8	8	8	8	11	11	11
c	3,3	3,3	3,3	3,3	3,3	4,3	4,3	4,3
d ₂	62	65	68	70	75	80	85	90
d ₃	54	57	60	62	67	71	76	81
Anz. Nuten	6	6	6	6	6	6	6	6
Sicherung*	45	48	50	52	55	60	65	70

Maße	M 75x1,5	M 80x1,5	M 85x1,5	M 90x1,5	M 95x1,5			
a	10	10	10	10	10			
b	11	11	11	11	11			
c	4,3	4,3	4,3	4,3	4,3			
d ₂	95	100	108	112	118			
d ₃	86	91	99	103	109			
Anz. Nuten	6	6	6	6	6			
Sicherung*	75	80	85	90	95			

*Sicherung DIN 70952

Verfügbare Abmessungen auf den folgenden Seiten:

Stahl/Stahl mit Oberfläche: [S. 408](#)

Artikel 88081

Nutmuttern GUK mit nichtmetallischem Klemmteil

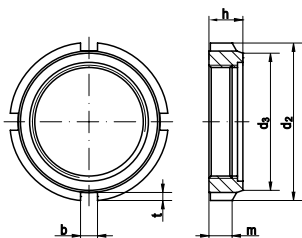

Maße	M 12x1	M 15x1	M 17x1	M 20x1	M 25x1,5	M 30x1,5
d ₂	21	24	28	32	38	44
d ₃	18	21	24	27	33	38
h	7,6	8,6	8,7	9,6	10,5	10,7
m	4,5	5,5	5,5	6	6,5	6,6
b	3	4	4	4	5	5
t	1,5	1,5	2	2,5	2,5	3
Anz. Nuten	4	4	4	4	4	4

Maße	M 35x1,5	M 40x1,5	M 45x1,5	M 50x1,5	M 55x2	M 60x2
d ₂	50	56	62	68	75	80
d ₃	44	50	55	61	68	73
h	11,3	12,3	12,3	12,9	13,4	13,4
m	7	7,7	7,8	8,1	8,2	8,2
b	5	6	6	6	7	7
t	3	3	3,5	3,5	3,5	3,5
Anz. Nuten	4	4	4	4	6	6

Verfügbare Abmessungen auf den folgenden Seiten:

Stahl/Stahl mit Oberfläche: [S. 416](#)



Sonderformen

DIN 582

Ringmuttern

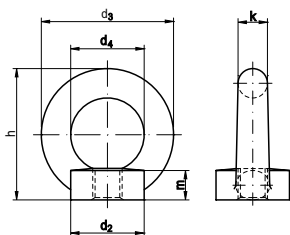

Maße	M 6	M 8	M 10	M 12	M 14	M 16	M 18	M 20	M 22
d ₂	20	20	25	30	35	35	40	40	50
d ₃	36	36	45	54	63	63	72	72	90
d ₄	20	20	25	30	35	35	40	40	50
m	8,5	8,5	10	11	13	13	16	16	20
h	36	36	45	53	62	62	71	71	90
k	8	8	10	12	14	14	16	16	20

Maße	M 24	M 27	M 30	M 33	M 36	M 42	M 48	M 56
d ₂	50	65	65	75	75	85	100	110
d ₃	90	108	108	126	126	144	166	184
d ₄	50	60	60	70	70	80	90	100
m	20	25	25	30	30	35	40	45
h	90	109	109	128	128	147	168	187
k	20	24	24	28	28	32	38	42

weitere Produktinformationen → TI-148

*Abmessung nicht genormt,
Maße der nächst größeren Abmessung

Verfügbare Abmessungen auf den folgenden Seiten:

Stahl/Stahl mit Oberfläche: S. 99 | Edelstahl: S. 473

Artikel 88088

Runde Verbindungsmuffen mit durchgehendem metrischen Gewinde

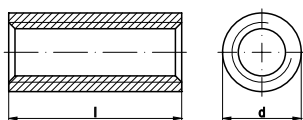

Maße	M 6	M 8	M 10
d	10	11	13
l	20/25/30/40	20/25/30/40/45	25/30/40/50

Maße	M 12	M 16	M 20
d	15	20	25
l	30/40/50	40	50

Verfügbare Abmessungen auf den folgenden Seiten:

Stahl/Stahl mit Oberfläche: S. 417 | Edelstahl: S. 593

Artikel 88089

Rundmuttern mit Trapezgewinde

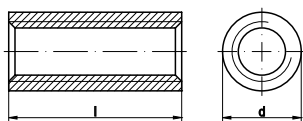

Maße	TR 12x3	TR 14x4	TR 16x4	TR 18x4	TR 20x4	TR 22x5	TR 24x5
d	22	36	36	36	36	50	50
l	18	21	24	27	30	33	36

Maße	TR 26x5	TR 28x5	TR 30x6	TR 32x6	TR 36x6	TR 40x7	TR 44x7
d	50	60	60	60	75	75	75
l	39	42	45	48	54	60	66

Verfügbare Abmessungen auf den folgenden Seiten:

Stahl/Stahl mit Oberfläche: S. 417 | Edelstahl: S. 593



Sonderformen

Artikel 88106

Setzmuttern

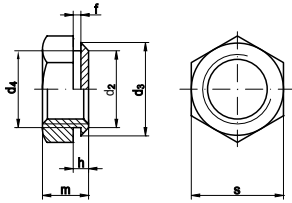

Maße	M 3	M 4	M 5	M 6
d ₂ *	4,5	5,5	6,5	8
d ₃	4,7	5,7	6,75	8,3
d ₄	4,5	5,5	6,5	8
m	3	3,2	4	5
f	0,4	0,4	0,4	0,4
h	0,9	0,9	0,9	0,9
s	5,5	7	8	10
Maße	M 8	M 10	M 12	M 16
d ₂ *	10	12,5	14,5	18,5
d ₃	10,3	12,85	14,85	18,85
d ₄	10	12,5	14,5	18,5
m	6,5	8	10	13
f	0,9	0,9	1,3	1,5
h	1,9	1,9	2,9	2,4
s	13	15	17	22

*entspricht Bohrloch \varnothing mit Tol. H11

Verfügbare Abmessungen auf den folgenden Seiten:

Stahl/Stahl mit Oberfläche: [S. 428](#) | Edelstahl: [S. 596](#)

Artikel 88108

Einschlagmuttern

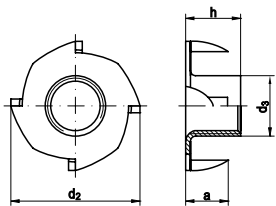

Maße	M 4	M 5	M 6	M 8	M 10
d ₂	15	17	19	22	25
d ₃	5	6,5	7,5	10	11,5
h	6	8	9/12	11/15	13
a	5	7	7	9	11

Verfügbare Abmessungen auf den folgenden Seiten:

Stahl/Stahl mit Oberfläche: [S. 428](#)

Artikel 88109

Käfigmuttern

Typ SMG

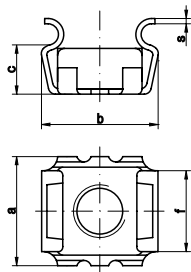

Maße	M 4 - 8/9,5	M 5 - 8/9,5	M 6 - 6/9,5
s	0,5	0,5	0,5
c	4,6	6,3	6,4
b	13,5	13,7	13,9
a	13,1	13,1	13,4
f	8,7	8,8	8,8
f. Blechdicken	1,8 - 2,6	1,8 - 2,6	0,7 - 1,7
Maße	M 6 - 8/9,5	M 8 - 8/12,5	M 10 - 8/12,5
s	0,5	0,6	0,6
c	6,3	7,4	7,4
b	13,7	17,8	17,8
a	13,1	16,6	16,6
f	8,8	11,4	11,4
f. Blechdicken	1,8 - 2,6	1,8 - 2,6	1,8 - 2,6

Verfügbare Abmessungen auf den folgenden Seiten:

Stahl/Stahl mit Oberfläche: [S. 428](#)

Sonderformen

Artikel 88215

Flügelmuttern,
kleine Ausführung, kantige Flügelform

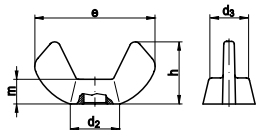

Maße	M 3	M 4	M 5	M 6	M 8	M 10	M 12
e	18,5	18,5	22	26,8	30,3	35,3	47,5
h	8,8	8,8	10,5	12,9	14,8	17,3	22,5
m	3	3	4	4,9	5,4	6,3	7,9
D	7,8	7,8	9,5	11,9	13,5	15,3	20,5

Verfügbare Abmessungen auf den folgenden Seiten:

Stahl/Stahl mit Oberfläche: [S. 78](#) | Edelstahl: [S. 464](#)

Artikel 88964

Hülsmuttern mit Linsensenkopf

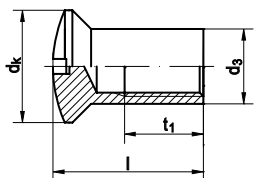

Maße	M 4	M 5	M 6	M 8
l	7/12/14/20	15	15/20	15/20
t ₁	3/7/8/13	9	9 /13	7/12
d ₃	5	6	7,5	10
d _k	7	9	10	15

Verfügbare Abmessungen auf den folgenden Seiten:

Edelstahl: [S. 607](#) | Nichteisen-Werkstoffe: [S. 647](#)

DIN 7965

Einschraubmuttern "RAMPA-Muffen"
(Schraubdübel)

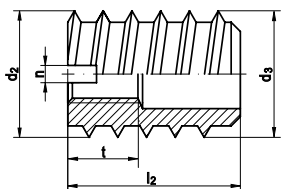

Maße	M 3	M 4	M 5	M 6	M 8	M 10	M 12
d ₂	6	8	10	12	16	18,5	22
d ₃	4,5	5,5	7,5	9,5	12,5	15	18
l ₂	5	6	7	9	11	13	16
n	1	1,2	1,6	2	2,5	3	3
t	2	2	3	3	4	5	5
für Bohrung Ø	5,0	6,5	8,5	10,5	14,5	17	20

Verfügbare Abmessungen auf den folgenden Seiten:

Stahl/Stahl mit Oberfläche: [S. 352](#) | Nichteisen-Werkstoffe: [S. 642](#)

Gewindeplatten

Artikel 88951

Hammerkopf-Gewindeplatten
(Gleitmuttern) Typ 28/15
für Profile 28/15, 28/12, 28/28, 26/26, 26/18

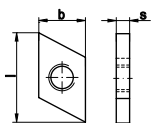

Maße	M 6	M 8	M 10
l	27,7	27,7	29,3
b	12,6	12,6	17,4
h	4	4	5

Verfügbare Abmessungen auf den folgenden Seiten:

Stahl/Stahl mit Oberfläche: [S. 444](#)



Gewindeplatten

Artikel 88952

Hammerkopf-Gewindeplatten
(Gleitmuttern) Typ 38/17

für Profile 35/45, 38/17, 36/36, 36/20

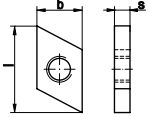

Maße	M 6	M 8	M 10	M 12
l	34	34	34	34
b	17,6	17,6	17,6	17,6
h	6,5	6,5	6,5	6,5

Verfügbare Abmessungen auf den folgenden Seiten:

Stahl/Stahl mit Oberfläche: [S. 444](#)

Artikel 88953

Hammerkopf-Gewindeplatten
(Gleitmuttern) Typ 50/40

für Profile 50/40, 486

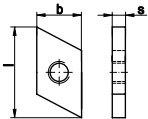

Maße	M 6	M 8	M 10	M 12	M 16
l	41,5	41,5	41,5	41,5	41,5
b	20,5	20,5	20,5	20,5	20,5
h	2,2	4	4	4	4

Verfügbare Abmessungen auf den folgenden Seiten:

Stahl/Stahl mit Oberfläche: [S. 445](#)

Artikel 88954

Hammerkopf-Gewindeplatten
(Gleitmuttern) Typ 40/22

für Profile 40/22, 40/25, K422

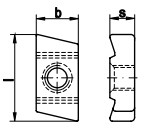

Maße	M 5	M 6	M 8	M 10	M 12
l	35	35	35	35	35
b	17	17	17	17	17
h	10	10	10	10	11,5

Verfügbare Abmessungen auf den folgenden Seiten:

Stahl/Stahl mit Oberfläche: [S. 445](#)

Artikel 88955

Hammerkopf-Gewindeplatten
(Gleitmuttern) Typ 50/30

für Profile 54/33, 52/34, 50/40, 49/30, 486

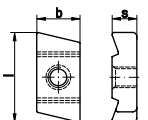

Maße	M 8	M 10	M 12	M 16
l	42	42	42	42
b	21	21	21	21
h	12	12	12	13

Verfügbare Abmessungen auf den folgenden Seiten:

Stahl/Stahl mit Oberfläche: [S. 445](#)



Spannschlösser

DIN 1478

Spannschlossmuttern
aus Stahlrohr oder Rundstahl

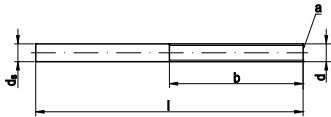
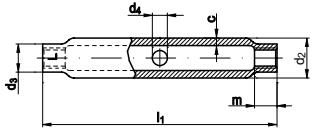

Tragfähigkeiten gelten nur für Spannschlösser mit ÜZ

Maße	M 6	M 8	M 10	M 12	M 16	M 20	M 24	M 30	M 36
d ₂	17,2	17,2	21,3	25	30	33,7	42,4	51	63,5
d ₃	9	12	15	18	22,5	27	32	38	47,5
D	6	8	8	10	10	12	12	16	16
c	2,9	3,6	4	4	4,5	5	5,6	6,3	8
l ₁	110	110	125	125	170	200	255	255	295
m	7,5	10	12	15	20	24	29	36	43
Nachstellbarkeit	90	85	95	90	120	140	180	160	180
Tragfähigkeit [kN]	3,9	7,2	11	16	30	48	69	110	160

Verfügbare Abmessungen auf den folgenden Seiten:

Stahl/Stahl mit Oberfläche: [S. 202](#)

DIN 1479

Sechskant-Spannschlossmuttern

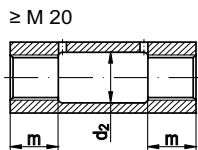
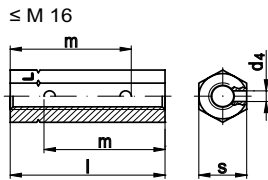

Tragfähigkeiten gelten nur für Spannschlossmuttern mit ÜZ

Maße	M 6	M 8	M 10	M 12	M 16	M 20	M 24	M 30	M 36
d ₂	-	-	-	-	-	21	26	32	38
d ₄	4	4	4	4	4	4	4	4	4
l	30	35	45	55	75	95	115	125	145
m	22,5	25	33	40	55	24	29	36	45
s	10	13	17	19	24	30	36	46	55
Nachstellbarkeit	15	15	21	25	35	47	57	53	70
Tragfähigkeit [kN]	3,9	7,2	11	16	30	48	69	110	160

Verfügbare Abmessungen auf den folgenden Seiten:

Stahl/Stahl mit Oberfläche: [S. 214](#) | Edelstahl: [S. 518](#)



Spannschlösser

DIN 1480

Spannschlossmutter geschmiedet mit und ohne Anschweißenden

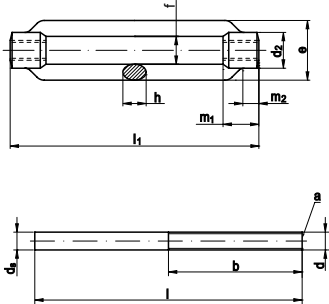

Anschweißende (AE) nach DIN 34828 ($d_5 \sim$ Flankendurchmesser)



Tragfähigkeiten gelten nur für Spannschlösser mit ÜZ

*Abmessungen nicht genormt, Richtwerte

**Werte gelten nur für Produkte mit ÜZ

Maße	M 6	M 8	M 10	M 12	M 14*	M 16	M 20
d_2	12	15	18	21	25	27	34
e	19	23	30	34	38	42	52
$h_{min.}$	6	8	9	11	10	14	17
l_1	110	110	125	125	140	170	200
m_1	12	15	18	21	24	27	34
m_2	6	8	9	11	9	14	17
l	120	120	150	150	165	200	220
b	65	65	75	75	85	100	120
Nachstellbarkeit mit AE**	80	75	85	80	92	110	130
Tragfähigkeit mit AE [kN]**	5,7	10	16	24	32	44	69

Maße	M 22*	M 24	M 27*	M 30	M 36	M 42	M 48
d_2	36	39	43	45	55	63	80
e	57	60	68	74	86	104	135
$h_{min.}$	16	20	23	23	28	32	40
l_1	220	255	255	255	295	330	355
m_1	37	39	45	45	55	63	78
m_2	15	20	23	23	28	32	39
l	220	260	260	260	300	350	380
b	130	150	150	160	180	200	220
Nachstellbarkeit mit AE**	146	170	171	160	180	200	195
Tragfähigkeit mit AE [kN]**	85	100	129	158	160	-	-

Verfügbare Abmessungen auf den folgenden Seiten:

Stahl/Stahl mit Oberfläche: [S. 215](#) Edelstahl: [S. 518](#)

DIN 1480 BS-S

Spannschlossmutter geschmiedet mit schwereren Blattschrauben

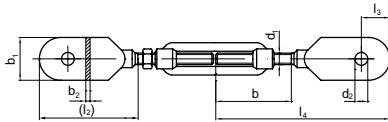

Maße für Spannschloss → siehe DIN 1480

Tragfähigkeiten gelten nur für Spannschlösser mit CE

*Abmessung nicht genormt, Richtwerte

Maße	M 6	M 8	M 10	M 12	M 14*	M 16	M 20
d_2	12	15	18	21	25	27	34
e	19	23	30	34	38	42	52
$h_{min.}$	6	8	9	11	10	14	17
l_1	110	110	125	125	140	170	200
m_1	12	15	18	21	24	27	34
m_2	6	8	9	11	9	14	17
l	120	120	150	150	165	200	220
b	65	65	75	75	85	100	120
Nachstellbarkeit	80	75	85	80	92	110	130
Tragfähigkeit [kN]	5,7	10	16	24	32	44	69

Verfügbare Abmessungen auf den folgenden Seiten:

Stahl/Stahl mit Oberfläche: [S. 217](#)



Vierkantmuttern

DIN 557

Vierkantmuttern

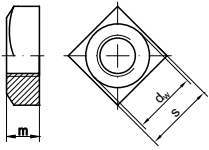

Maße	M 5	M 6	M 8	M 10	M 12	M 16
$d_{w \text{ min.}}$	6,7	8,7	11,5	14,5/15,5	16,5/17,2	22
m	4	5	6,5	8	10	13
s	8	10	13	16/17	18/19	24

Verfügbare Abmessungen auf den folgenden Seiten:

Stahl/Stahl mit Oberfläche: [S. 95](#) | Edelstahl: [S. 471](#)

Vierkantmuttern

DIN 562

Niedrige Vierkantmuttern

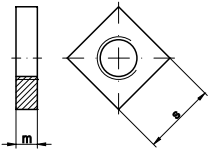

Maße	M 2	M 2,5	M 3	M 4	M 5	M 6	M 8	M 10
m	1,2	1,6	1,8	2,2	2,7	3,2	4	5
s	4	5	5,5	7	8	10	13	16/17*

*alte DIN-Schlüsselweite

Verfügbare Abmessungen auf den folgenden Seiten:

Stahl/Stahl mit Oberfläche: [S. 97](#) | Edelstahl: [S. 471](#)



Flache Scheiben (rund)

Pk = Produkt-(Toleranz-)Klasse

A = mittel

C = grob

Toleranzen für Scheiben nach ISO 4759-3 (DIN 522)

Allgemeine Übersicht über „Flache Scheiben für allgemeine Verwendungen“ → ISO 887

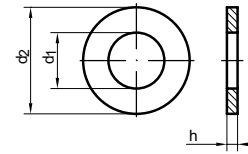

Nenngröße = für Schrauben		ISO 7089, 7090 (DIN 125-1 Pk A)			ISO 7091 (DIN 126 Pk C)			Art. 1/88100 (C) -			ISO 7092 (DIN 433 Pk A)			ISO 7094 (DIN 440 R Pk C)			DIN 6340 (Pk A) -					
M	Ww	d ₁	d ₂	h	d ₁	d ₂	h	d ₁	d ₂	h	d ₁	d ₂	h	d ₁	d ₂	h	d ₁	d ₂	h			
1		1,1	3	0,3	In den ISO-Normen wurden die Nenngrößen auf Schraubendurchmesser und für einige Scheiben die Abmessungen (d ₁ /d ₂ /s) geringfügig verändert. Funktionserfüllung bzw. Austauschbarkeit DIN:ISO-Scheiben sind gegeben. In diesem Katalog sind in Maß- und Preistabellen weitgehend die neuen Abmessungen angegeben – die Umstellung auf neue Maße erfolgt entsprechend der Fertigungsumstellung und dem Abverkauf der Lagerbestände.						1,1	2,5	0,3									
1,2		1,3	3,5	0,3										1,3	3	0,3						
1,4		1,5	4	0,3										1,5	3	0,3						
1,6		1,7	4	0,3										1,7	3,5	0,3						
*1,7		1,8	4,5	0,3																		
1,8		2,0	4,5	0,3										2,0	4	0,3						
2		2,2	5	0,3										2,2	4,5	0,3						
2,2		2,4	6	0,5										2,4	4,5	0,3						
2,5		2,7	6	0,5										2,7	5	0,5						
*2,6		2,8	7	0,5																		
3		3,2	7	0,5				3,2	8	0,5	3,2	6	0,5									
3,5		3,7	8	0,5							3,7	7	0,5									
4	*1/8"	4,3	9	0,8				4,3	10	0,8	4,3	8	0,5									
5	*3/16"	5,3	10	1	5,5	10	1	5,3	12	1	5,3	9	1	5,5	18	2						
6		6,4	12	1,6	6,6	12	1,6	6,5	13	1,25	6,4	11	1,6	6,6	22	2	6,4	17	3			
7	*1/4"	7,4	14	1,6	7,6	14	1,6	8	16	1,25	7,4	12	1,6	7,6	24	2						
8	*5/16"	8,4	16	1,6	9	16	1,6	10	20	1,5	8,4	15	1,6	9	28	3	8,4	23	4			
10	*3/8"	10,5	20	2	11	20	2	11,5	23	1,5	10,5	18	1,6	11	34	3	10,5	28	4			
12	*7/16"	13	24	2,5	13,5	24	2,5	13	26	1,75	13	20	2	13,5	44	4	13	35	5			
	*1/2"	13,5	24	2,5	13,5	24	2,5	14,5	29	1,75				13,5	44	4						
14		15	28	2,5	15,5	28	2,5	14,5	29	1,75	15	24	2,5	15,5	50	4						
	*9/16"							16	32	2												
16	*5/8"	17	30	3	17,5	30	3	17,5	35	2	17	28	2,5	17,5	56	5	17	45	6			
18		19	34	3	20	34	3	19,5	39	2,5	19	30	3	20	60	5						
20	*3/4"	21	37	3	22	37	3	21	42	2,5	21	34	3	22	72	6	21	50	6			
	*13/16"							23	46	3												
22	*7/8"	23	39	3	24	39	3	24,5	49	3	23	37	3	24	80	6						
24		25	44	4	26	44	4	27,5	55	3,5	25	39	4	26	85	6	25	60	8			
	*1"	27	50	4	26	44	4	27,5	55	3,5				26	85	6						
27		28	50	4	30	50	4	29	58	3,5	28	44	4	30	98	6						
30	*1 1/8"	31	56	4	33	56	4	31	62	3,5	31	50	4	33	105	6	31	68	10			
33	*1 1/4"	34	60	5	36	60	5	34	68	4	34	56	5	36	115	8						
	*1 3/8"							36	72	5												
36	*1 3/8"	37	66	5	39	66	5	40	80	5	37	60	5	39	125	8						
39	*1 1/2"	42 (40)	72	6	42	72	6	40	80	5				42	140	10						
42		45 (43)	78	8	45	78	8	43	85	5				*45	150	8						
45	*1 3/4"	48 (46)	85	8	48	85	8	46	90	5				*48	160	8						
48		52 (50)	92	8	52	92	8	50	97	6				*52	170	10						
52	*2"	56 (54)	98	8	56	98	8	54	105	7				*56	180	10						
56		62 (58)	105	10	62	105	10	58	110	8												
	*2 1/4"	60	110	9	62	105	10	Geeignete Kombinationen von flachen Scheiben für Schrauben/Muttern nach Festigkeits- und Produktklassen (Auszug aus ISO 887 informativer Anhang). Genauere Informationen siehe „Anwendungsbereich“ der jeweiligen Scheiben-Produktnorm.														
60		66 (62)	110	10,0	66	110	10	Scheiben		Härteklasse/Produktklasse		100 HV/C	200 HV/A	300 HV/A								
64	*2 1/2"	70 (66)	115	10	70	115	10	Schrauben/Muttern		Festigkeitsklasse	Produktklasse	Kombination geeignet?										
68		74 (70)	120	10	74	120	10	Stahl		≤ 6.8/ 6	A, B	ja	ja	ja								
72	*2 3/4"	78 (74)	125	10	78	125	10			≤ 6.8/ 6	C	ja	nein	ja								
76	*3"	82 (78)	135	10	82	135	10			8.8/ 8	A, B	nein	ja	ja								
80		86 (82)	140	12	86	140	12			10.9/10	A, B	nein	nein	ja								
										12.9/12	A, B	nein	nein	nein								
90	*3 1/2"	96 (93)	160	12	96	160	12	A 1 - A 5		-50, -70, -80	A, B	-	ja	-								

*Nicht in ISO-Produktnormen enthalten → Maßreihen ISO 887



Flache Scheiben (rund)

Pk = Produkt-(Toleranz-)Klasse

A = mittel

C = grob

Toleranzen für Scheiben nach ISO 4759-3 (DIN 522)

Allgemeine Übersicht über „Flache Scheiben für allgemeine Verwendungen“ → ISO 887

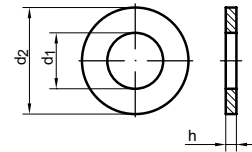

Nenngröße = für Schrauben		EN 14399-6 (Pk A) DIN 34820 (Pk A)*			DIN 7349 (Pk A) -			DIN 7989-1 (Pk C) DIN 7989-2 (Pk A)			ISO 7093-1,2 (DIN 9021 Pk A/Pk C)			ANSI B 18.22.1 Typ A							
M	Ww	d ₁	d ₂	h	d ₁	d ₂	h	d ₁	d ₂	h	d ₁	d ₂	h	N = narrow			W = wide				
		d ₁ ^①	d ₂ ^①	h ^①	d ₁ ^①	d ₂ ^①	h ^①	d ₁ ^①	d ₂ ^①	h ^①	d ₁ ^①	d ₂ ^①	h ^①	d ₁ ^①	d ₂ ^①	h ^①	d ₁ ^①	d ₂ ^①	h ^①		
3					3,2	9	1				3,2	9	0,8								
3,5		* d ₁ und d ₂ stimmen bei EN 14399-6 und DIN 34820 überein: h-Maße DIN 34820 in ()									3,7	11	0,8								
4	*1/8"						4,3	12	1,6				4,3	12	1						
5	*3/16"						5,3	15	2				5,3	15	1,2						
6							6,4	17	3				6,4	18	1,6						
7	*1/4"												7,4	22	2	0,281	0,625	0,065	0,312	0,734	0,065
8	*5/16"				8,4	21	4			8,4	24	2	0,344	0,688	0,065	0,375	0,875	0,083			
10	*3/8"				10,5	25	4	11	20	8	10,5	30	2,5	0,406	0,812	0,065	0,438	1,000	0,083		
12	*7/16"	13	24	3 (2,5)	13	30	6	13,5	24	8	13	37	3	0,469	0,922	0,065	0,500	1,250	0,083		
	*1/2"													0,531	1,062	0,095	0,562	1,375	0,109		
14					15	36	6				15	44	3								
	*9/16"													0,594	1,156	0,095	0,625	1,469	0,109		
16	*5/8"	17	30	4 (3)	17	40	6	17,5	30	8	17	50	3	0,656	1,312	0,095	0,688	1,750	0,134		
18					19	44	8				20	56	4								
20	*3/4"	21	37	4 (3)	21	44	8	22	37	8	22	60	4	0,812	1,469	0,134	0,812	2,000	0,148		
22	*7/8"	23	39	4 (3)	23	50	8	24	39	8	23/24	66	5								
24		25	44	4 (4)	25	50	10	26	44	8	26	72	5								
27	*1"	28	50	5 (4)	28	60	10	30	50	8	30	85	6								
30	*1 1/8"	31	56	5 (4)	31	68	10	33	56	8	33	92	6								
33	*1 1/4"							36	60	8	36	105	6								
36	*1 3/8"	37	66	6 (5)				39	66	8	39	110	8								

① Maße in Inch

Nenngröße = Schrauben/ Bolzen		DIN 1052 (Pk C) -			ISO 8738 (Pk A) (DIN 1440 (Pk A)) DIN 1441 (Pk C)			DIN 988 -S (Pk C) -			Art. 88104 (Pk C) -		
M	Ww	d ₁	d ₂	h	d ₁	d ₂	h	d ₁	d ₂	h	d ₁	d ₂	h
3								3	6	1	3,2	20	1,25
3,5					d ₁ -Maße DIN 1441 in () d ₂ -Maße DIN 1440/1441 in ()								
4	*1/8"							4	8	1	4,3	15/20/25	1,25
5	*3/16"				5 (5,5)	10 (10)	0,8				5,3	20/25/30	1,5
6					6 (7)	12 (12)	1,6	6	12	1,2	6,4	20/25/30/35	1,5
7	*1/4"				7 (8)	- (14)	1,6						
8	*5/16"				8 (9)	15 (16)	2	8	14	1,2	8,4	20/25/30/35/40	1,5
10	*3/8"				10 (11)	18 (20)	2,5	10	13	1,2	10,5	25/30/35/40	1,5
12	*7/16"	14	58	6	12 (13)	20 (25)	3	12	18	1,2	12,5	30/35/40	1,5
14					14 (15)	22 (28)	3	14	20	1,5			
15								15	21	1,5			
16	*5/8"	18	68	6	16 (17)	24 (28)	3	16	22	1,5			
17								17	24	1,5			
18					18 (19)	- (30)	4	18	25	1,5			
20	*3/4"	23	80	8	20 (21)	30 (32)	4	20	28	2			
22	*7/8"	25	92	8	22 (23)	34 (34)	4	22	30/32	2			
24		27	105	8	24 (25)	37 (38)	4						
25								25	35/36	2			
26								26	37	2			
27	*1"												
28					27 (28)	39 (40)	5						
30	*1 1/8"							28	40	2			
33	*1 1/4"				30 (31)	44 (45)	5	30	42	2,5			
					33 (34)	47 (50)	5						

Fortsetzung → TI-86



Flache Scheiben (rund)

Nenngröße = Schrauben/ Bolzen		DIN 1052 (Pk C) -			DIN 1440 (Pk C) DIN 1441 (Pk C)*			DIN 988 -S (Pk C) -			Anmerkung
M	Ww	d ₁	d ₂	h	d ₁	d ₂	h	d ₁	d ₂	h	
35					35	52	6	35	45	2,5	Scheiben in Sonderausführung - gestanzt - gedreht - gebrannt - in allen Größen und Werkstoffen kurzfristig auf Anfrage
36	*1 3/8"				36 (37)	52	6				
37								37	47	2,5	
40					40 (41)	58	6	40	50	2,5	
45	*1 3/4"				45 (46)	62	7	45	55	3	
50					50 (51)	68	8	50	62/63	3	
55					55 (56)	75	9	55	68	3	
60					60 (62)	80	9	60	75	3	
63								63	80	3	
65					65 (68)	90	9	65	85	3,5	
70					70 (72)	95	10	70	90	3,5	
75					75 (78)	100	10	75	95	3,5	
80					80 (82)	110	12	80	100	3,5	
85					85 (86)	110	12	85	105	3,5	
90					90 (92)	115	12	90	110	3,5	
100					100 (102)	125	14	100	120/125	3,5	

Vierkantscheiben/Keilscheiben

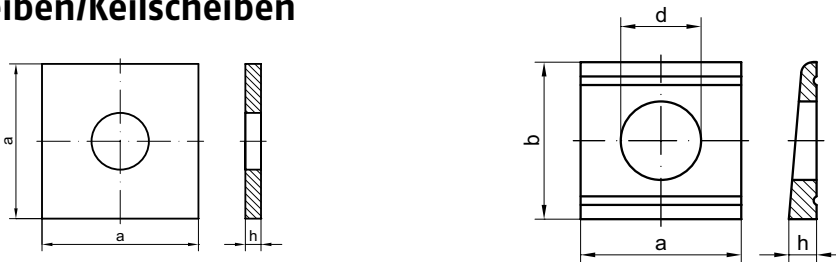

Nenngröße = für Schrauben		DIN 436 (Pk C) 0%			DIN 434 (Pk C) 8%			DIN 435 (Pk C) 14%			DIN 6917 (Pk C) 14%			DIN 6918 (Pk C) 8%		
M	Ww	d	a	h	d	a/b	h	d	a/b	h	d	a/b	h	d	a/b	h
8	5/16"				9	22/22	3,8/2	9	22/22	4,6/1,5						
10	3/8"	11	30	3	11	22/22	3,8/2	11	22/22	4,6/1,5	13	26/30	6,2/2	13	26/30	4,9/2,5
12	7/16"	13,5	40	4	13,5	26/30	4,9/2,5	13,5	26/30	6,2/2						
	1/2"	13,5	40	4	13,5	26/30	4,9/2,5	13,5	26/30	6,2/2						
14																
16	5/8"	17,5	50	5	17,5	32/36	5,9/3	17,5	32/36	7,5/2,5	17	32/36	7,5/2,5	17	32/36	5,9/3
18																
20	3/4"	22	60	5	22	40/44	7/3,5	22	40/44	9,2/3	21	40/44	9,2/3	21	40/44	7/3,5
22	7/8"	24	70	6	24	44/50	8/4	24	44/50	10/3	23	44/50	10/3	23	44/50	8/4
24		26	80	6	26	56/56	8,5/4	26	56/56	10,8/3	25	56/56	10,8/3	25*	56/56	8,5/4
	1"	26	80	6	26	56/56	8,5/4	26	56/56	10,8/3						
27		30	90	6	30	56/56	8,5/4	30	56/56	10,8/3	28	56/56	10,8/3	28*	56/56	8,5/4
30	1 1/8"	33	95	6	33	62/62	9/4	33	62/62	11,7/3	31	62/62	11,7/3	31*	62/62	9/4
33	1 1/4"	36	100	6												
36	1 3/8"	39	110	8							37	68/68	12,5/3	37*	68/68	9,4/4
39	1 1/2"	42	125	8												
42		45	135	8												
45	1 3/4"	48	140	8												
48		52	150	10												
52	2"	56	160	10												

Kennzeichnung:
 DIN Neigung Anzahl Rillen
 434 8% 2
 435 14% 1
 6917 14% 1
 6918 8%/5% 2/0 - „Form A“



Dichtungsscheiben (flach)

DIN 7603

Flachdichtringe

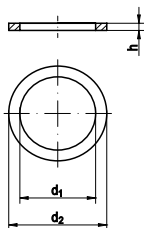

Maße	4x8	5x7,5	5x9*	6x10*	6,5x9,5	6,5x11*
d ₁	4,2	5,2	5,2	6,2	6,7	6,7
d ₂	7,9	7,4	8,9	9,9	9,4	10,9
h	1	1	1	1	1	1
Maße	8x11,5	8x12*	8x14	10x13,5	10x14*	10x15*
d ₁	8,2	8,2	8,2	10,2	10,2	10,2
d ₂	11,4	11,9	13,9	13,4	13,9	14,9
h	1	1/1,5	1	1	1/1,5	1
Maße	10x16	10x18	12x15,5	12x16	12x17*	12x18*
d ₁	10,2	10,2	12,2	12,2	12,2	12,2
d ₂	15,9	17,9	15,4	15,9	16,9	17,9
h	1	1,5	1,5	1,5	1,5	1,5
Maße	13x18*	14x18	14x20	15x19	16x20	16x22*
d ₁	13,2	14,2	14,2	15,2	16,2	16,2
d ₂	17,9	17,9	19,9	18,9	19,9	21,9
h	1,5	1,5	1,5	1,5	1,5	1,5
Maße	17x21	17x23*	18x22	18x24	20x24	20x26
d ₁	17,2	17,2	18,2	18	20,2	20
d ₂	20,9	22,9	21,9	24	23,9	26
h	1,5	1,5	1,5	1,5	1,5	1,5
Maße	21x26	22x27	22x29*	23x28	24x29	24x32
d ₁	21,2	22,2	22,2	23,3	24,3	24,3
d ₂	25,9	26,9	28,9	27,9	28,9	31,9
h	1,5	1,5	1,5	2	2	2
Maße	26x31	26x34*	27x32	28x33	30x36	32x38
d ₁	26,3	26,3	27,3	28,3	30,3	32,3
d ₂	30,9	33,9	31,9	32,9	35,9	37,9
h	2	2	2	2	2	2
Maße	33x38	33x41*	36x42	38x44	42x49	45x52
d ₁	33,3	33,3	36,3	38,3	42,3	45,3
d ₂	37,9	40,9	41,9	43,9	48,9	51,9
h	2	2	2	2	2	2
Maße	48x55*	60x68*				
d ₁	48,3	60,5				
d ₂	54,9	67,8				
h	2	2,5				

Material: Al Betriebstemperatur: max. 200 °C
 Material: Cu Betriebstemperatur: max. 300 °C
 *Abmessung nicht genormt, Richtwerte

Verfügbare Abmessungen auf den folgenden Seiten:

Nichteisen-Werkstoffe: [S. 642](#)



Sicherungsscheiben und Sicherungsringe

DIN 93

Scheiben mit Lappen

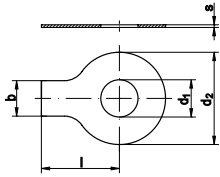

Maße	3,2	4,3	4,3	5,3	6,4	8,4	10,5	13
d ₂	12	14	14	17	19	22	26	30
b	4	5	5	6	7	8	10	12
l	13	14	14	16	18	20	22	28
s	0,38	0,38	0,38	0,5	0,5	0,75	0,75	1
für Gewinde Ø	3	4	4	5	6	8	10	12

Maße	15	17	19	21	23	25	28	31
d ₂	33	36	40	42	50	50	58	63
b	12	15	18	18	20	20	23	26
l	28	32	36	36	42	42	48	52
s	1	1	1	1	1	1	1,6	1,6
für Gewinde Ø	14	16	18	20	22	24	27	30

Maße	34	37	40	43	46	50	54	
d ₂	68	75	82	88	95	100	105	
b	28	30	32	35	38	40	44	
l	56	60	64	70	75	80	85	
s	1,6	1,6	1,6	1,6	1,6	1,6	1,6	
für Gewinde Ø	33	36	39	42	45	48	52	

d₁ = Nennmaß

Verfügbare Abmessungen auf den folgenden Seiten:

Stahl/Stahl mit Oberfläche: S. 68 | Edelstahl: S. 458

DIN 127

Federringe, aufgebogen oder glatt

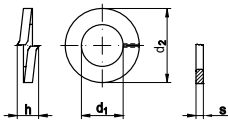

Form A = aufgebogen

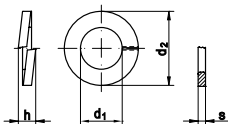

Form B = glatt

Maße	2	2,3	2,5	2,6 *	3	3,5	4	5	6
d ₁	2,1	2,3	2,6	3	3,1	3,6	4,1	5,1	6,1
d ₂	4,4	4,8	5,1	5,2	6,2	6,7	7,6	9,2	11,8
s	0,5	0,6	0,6	0,6	0,8	0,8	0,9	1,2	1,6
h _{Form A}	-	-	-	-	1,9	1,9	2,1	2,7	3,6
h _{Form B}	1,2	1,4	1,4	1,4	1,6	1,6	1,8	2,4	3,2

Maße	7	8	10	12	14	16	18	20	22
d ₁	7,1	8,1	10,2	12,2	14,2	16,2	18,2	20,2	22,5
d ₂	12,8	14,8	18,1	21,1	24,1	27,4	29,4	33,6	35,9
s	1,6	2	2,2	2,5	3	3,5	3,5	4	4
h _{Form A}	3,6	4,6	5	5,8	6,8	7,8	7,8	8,8	8,8
h _{Form B}	3,2	4	4,4	5	6	7	7	8	8

Maße	24	27	30	33	36	39	42	45	48
d ₁	24,5	27,5	30,5	33,5	36,5	39,5	42,5	45,5	49
d ₂	40	43	48,2	53,2	58,2	61,2	68,2	71,2	75
s	5	5	6	6	6	6	7	7	7
h _{Form A}	11	11	13,6	13,6	13,6	13,6	15,6	15,6	15,6
h _{Form B}	10	10	12	12	12	12	14	14	14

Maße	52	56	64	80	90	100			
d ₁	53	57	65	81	91	101			
d ₂	82	87	95	111	121	131			
s	8	8	8	8	8	8			
h _{Form A}	18	18	18	18	18	18			
h _{Form B}	16	16	16	16	16	16			

*Abmessung nicht genormt, Richtwerte

Verfügbare Abmessungen auf den folgenden Seiten:

Stahl/Stahl mit Oberfläche: S. 73 | Edelstahl: S. 462 | Nichteisen-Werkstoffe: S. 617



Sicherungsscheiben und Sicherungsringe

DIN 128

Federringe, gewölbt oder gewellt

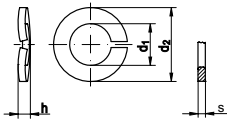

Form A = gewölbt

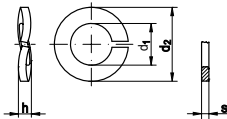

Form B = gewellt

*Abmessung nicht genormt, Richtwerte

Maße	2,2*	2,5	3	4	5	6
d ₁	2,4	2,6	3,1	4,1	5,1	6,1
d ₂	4,8	5,1	6,2	7,6	9,2	11,8
s	0,6	0,6	0,7	0,8	1	1,3
h	1	1,1	1,3	1,4	1,7	2,2

Maße	8	10	12	14	16	18
d ₁	8,1	10,2	12,2	14,2	16,2	18,2
d ₂	14,8	18,1	21,1	24,1	27,4	29,4
s	1,6	1,8	2,1	2,4	2,8	2,8
h	2,75	3,15	3,65	4,3	5,1	5,1

Maße	20	22	24	27	30	36
d ₁	20,2	22,5	24,5	27,5	30,5	35,5
d ₂	33,6	35,9	40	43	30,5	58,2
s	3,2	3,2	4	4	6	3
h	5,9	5,9	7,5	7,5	10,5	11,3

Verfügbare Abmessungen auf den folgenden Seiten:

Stahl/Stahl mit Oberfläche: [S. 75](#) | Edelstahl: [S. 463](#)

DIN 137

Federscheiben

Form A = gewölbt

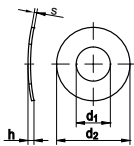

Maße	2	2,3	2,6	3	3,5	4
d ₁	2,2	2,5	2,8	3,2	3,7	4,3
d ₂	4,5	5	5,5	6	7	8
s	0,3	0,3	0,3	0,4	0,4	0,5
h	1	1	1,1	1,3	1,4	1,6

Maße	5	6	7	8	10	
d ₁	5,3	6,4	7,4	8,4	10,5	
d ₂	10	11	12	15	18	
s	0,5	0,5	0,5	0,5	0,8	
h	1,8	2,2	2,4	3,4	4	

Verfügbare Abmessungen auf den folgenden Seiten:

Stahl/Stahl mit Oberfläche: [S. 76](#) | Edelstahl: [S. 463](#)

DIN 137

Federscheiben

Form B = gewellt

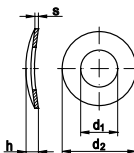

Maße	3	3,5	4	5	6	7	8
d ₁	3,2	3,7	4,3	5,3	6,4	7,4	8,4
d ₂	8	8	9	11	12	14	15
s	0,5	0,5	0,5	0,5	0,5	0,8	0,8
h	1,6	1,8	2	2,2	2,6	3	3

Maße	10	12	14	16	18	20	22
d ₁	10,5	13	15	17	19	21	23
d ₂	21	24	28	30	34	36	40
s	1	1,2	1,6	1,6	1,6	1,6	1,8
h	4,2	5	6	6,4	6,6	7,4	7,8

Maße	24	27	30	33	36		
d ₁	25	28	31	34	37		
d ₂	44	50	56	60	68		
s	1,8	2	2,2	2,2	2,5		
h	8,2	9,4	10	10,6	11,6		

Verfügbare Abmessungen auf den folgenden Seiten:

Stahl/Stahl mit Oberfläche: [S. 76](#) | Edelstahl: [S. 463](#)



Sicherungsscheiben und Sicherungsringe

DIN 432

Scheiben mit Außennase

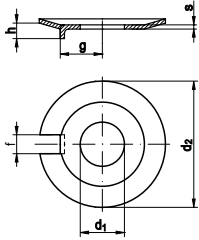

Maße	4,3	5,3	6,4	8,4	10,5	13	15	17
d ₂	14	17	19	22	26	30	33	36
f	2,5	3,5	3,5	3,5	4,5	4,5	4,5	5,5
g	5,5	7	7,5	8,5	10	12	13	15
h ≈	2	2,5	3	4	4	4,5	4,5	4,5
s	0,4	0,75	0,75	1	1	1,2	1,2	1,2

Maße	19	21	23	25	28	31	34	37
d ₂	40	42	50	50	58	63	68	75
f	6,5	6,5	7,5	7,5	8,5	8,5	9,5	11
g	18	18	20	21	23	25	28	31
h ≈	4,5	4,5	6,5	6,5	9,5	9,5	9,5	9,5
s	1,2	1,6	1,6	1,6	1,6	1,6	1,6	2

Maße	40	43	46	50	54	58	66	
d ₂	82	88	95	100	105	112	125	
f	11	11	13	13	13	16	18	
g	33	36	38	40	42	45	52	
h ≈	11	11	12	13	13	14	13,5	
s	2	2	2	2	2	2,5	2,5	

d₁ = Nennmaß

Verfügbare Abmessungen auf den folgenden Seiten:

Stahl/Stahl mit Oberfläche: [S. 80](#) | Edelstahl: [S. 465](#)

DIN 462

Scheiben mit Innennase

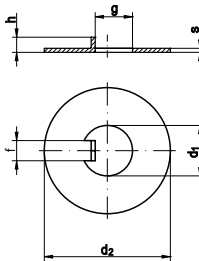

Maße	8	10	14	16	18	20	22	24
d ₂	20	25	30	32	34	36	40	42
s	0,8	0,8	0,8	11	1	1	1	1
f	3	4	5	5	6	6	6	6
g	5,9	7,4	11,4	13,5	15,4	17,5	19,5	21,6
h	2,5	3	3	3	4	4	4	4

Maße	28	30	32	35	38	40	42	45
d ₂	50	50	52	55	58	62	62	68
s	1	1,2	1,2	1,2	1,2	1,2	1,2	1,2
f	7	7	7	7	8	8	8	8
g	25,5	27,5	29,6	32,6	35,3	37,3	39,3	42,4
h	5	5	5	5	5	5	5	5

Maße	48	50	52	55	58	60	62	65
d ₂	75	75	80	80	90	90	95	95
s	1,2	1,2	1,2	1,2	1,5	1,5	1,5	1,5
f	8	8	10	10	10	10	10	10
g	45,4	47,4	49,3	52,3	55,3	57,3	59,3	62,4
h	5	5	6	6	6	6	6	6

Maße	70	72	75	80	85	95	100	
d ₂	100	110	110	115	120	135	145	
s	1,5	1,5	1,5	1,5	1,5	1,5	1,5	
f	10	10	10	10	10	12	12	
g	67,4	68,9	71,9	76,9	81,9	91,8	96,9	
h	6	7	7	7	7	8	8	

d₁ = Nennmaß

Verfügbare Abmessungen auf den folgenden Seiten:

Stahl/Stahl mit Oberfläche: [S. 87](#)



Sicherungsscheiben und Sicherungsringe

DIN 463

Scheiben mit 2 Lappen

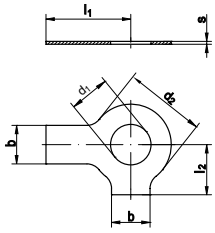

Maße	3,2	4,3	5,3	6,4	8,4	10,5	13
d ₂	7	9	10	12,5	17	21	24
b	4	5	6	7	8	10	12
l ₁	13	14	16	18	20	22	28
l ₂	5	6,5	8	9	11	13	15
s	0,38	0,38	0,5	0,5	0,75	0,75	1
für Gewinde Ø	3	4	5	6	8	10	12

Maße	15	17	19	21	23	25	28
d ₂	28	30	34	37	39	44	50
b	12	15	18	18	20	20	23
l ₁	28	32	36	36	42	42	48
l ₂	16	18	20	21	23	25	29
s	1	1	1	1	1	1	1,6
für Gewinde Ø	14	16	18	20	22	24	27

Maße	31	34	37	40	43	50	54
d ₂	56	60	66	72	78	92	98
b	26	28	30	32	35	40	44
l ₁	52	56	60	64	70	80	85
l ₂	32	34	38	41	44	50	53
s	1,6	1,6	1,6	1,6	1,6	1,6	1,6
für Gewinde Ø	30	33	36	39	42	48	52

d₁ = Nennmaß

Verfügbare Abmessungen auf den folgenden Seiten:

Stahl/Stahl mit Oberfläche: S. 87 | Edelstahl: S. 469 | Nichteisen-Werkstoffe: S. 619

DIN 471

Sicherungsringe (Haltringe)
für Wellen

Regelausführung

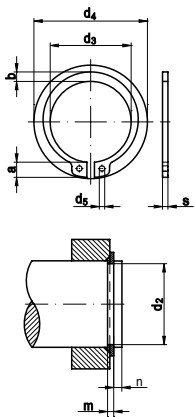

Nennmaß = für Wellen Ø

Maße	3	4	5	6	7	8	9	10	11	12
s	0,4	0,4	0,6	0,7	0,8	0,8	1	1	1	1
d ₃	2,7	3,7	4,7	5,6	6,5	7,4	8,4	9,3	10,2	11
a	1,9	2,2	2,5	2,7	3,1	3,2	3,3	3,3	3,3	3,3
b	0,8	0,9	1,1	1,3	1,4	1,5	1,7	1,8	1,8	1,8
d ₅	1	1	1	1,2	1,2	1,2	1,2	1,5	1,5	1,7
d ₂	2,8	3,8	4,8	5,7	6,7	7,6	8,6	9,6	10,5	11,5
m	0,5	0,5	0,7	0,8	0,9	0,9	1,1	1,1	1,1	1,1
n	0,3	0,3	0,3	0,5	0,5	0,6	0,6	0,6	0,8	0,8
d ₄	7	8,6	10,3	11,7	13,5	14,7	16	17	18	19

Maße	13	14	15	16	17	18	19	20	21	22
s	1	1	1	1	1	1,2	1,2	1,2	1,2	1,2
d ₃	11,9	12,9	13,8	14,7	15,7	16,5	17,5	18,5	19,5	20,5
a	3,4	3,5	3,6	3,7	3,8	3,9	3,9	4	4,1	4,2
b	2	2,1	2,2	2,2	2,3	2,4	2,5	2,6	2,7	2,8
d ₅	1,7	1,7	1,7	1,7	1,7	2	2	2	2	2
d ₂	12,4	13,4	14,3	15,2	16,2	17	18	19	20	21
m	1,1	1,1	1,1	1,1	1,1	1,3	1,3	1,3	1,3	1,3
n	0,9	0,9	1,1	1,2	1,2	1,5	1,5	1,5	1,5	1,5
d ₄	20,2	21,4	22,6	23,8	25	26,2	27,2	28,4	29,6	30,8

*Zwischengrößen nicht in der Norm enthalten

Verfügbare Abmessungen auf den folgenden Seiten:

Stahl/Stahl mit Oberfläche: S. 89 | Edelstahl: S. 469



Sicherungsscheiben und Sicherungsringe

DIN 471

**Sicherungsringe (Haltringe)
für Wellen
Regelausführung**

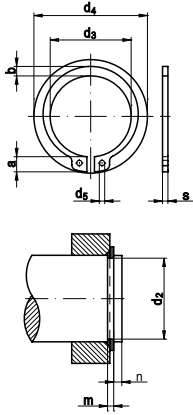

Maße	23*	24	25	26	27*	28	29	30	31*	32
s	1,2	1,2	1,2	1,2	1,2	1,5	1,5	1,5	1,5	1,5
d ₃	21,5	22,2	23,2	24,2	24,9	25,9	26,9	27,9	28,6	29,6
a	4,3	4,4	4,4	4,5	4,6	4,7	4,8	5	5,1	5,2
b	2,9	3	3	3,1	3,1	3,2	3,4	3,5	3,5	3,6
d ₅	2	2	2	2	2	2	2	2	2,5	2,5
d ₂	22	22,9	23,9	24,9	25,6	26,6	27,6	28,6	29,3	30,3
m	1,3	1,3	1,3	1,3	1,3	1,6	1,6	1,6	1,6	1,6
n	1,5	1,7	1,7	1,7	2,1	2,1	2,1	2,1	2,6	2,6
d ₄	-	33,2	34,2	35,5	-	37,9	39,1	40,5	-	43

Maße	33*	34	35	36	37*	38	39*	40	41*	42
s	1,5	1,5	1,5	1,75	1,75	1,75	1,75	1,75	1,75	1,75
d ₃	30,5	31,5	32,2	33,2	34,2	35,2	36	36,5	37,5	38,5
a	5,2	5,4	5,6	5,6	5,7	5,8	5,9	6	6,2	6,5
b	3,7	3,8	3,9	4	4,1	4,2	4,3	4,4	4,5	4,5
d ₅	2,5	2,5	2,5	2,5	2,5	2,5	2,5	2,5	2,5	2,5
d ₂	31,3	32,3	33	34	35	36	37	37,5	38,5	39,5
m	1,6	1,6	1,6	1,85	1,85	1,85	1,85	1,85	1,85	1,85
n	2,6	2,6	3	3	3	3	3	3,8	3,8	3,8
d ₄	-	45,4	46,8	47,8	-	50,2	-	52,6	-	55,7

Maße	44*	45	46*	47*	48	50	52	54*	55	56
s	1,75	1,75	1,75	1,75	1,75	2	2	2	2	2
d ₃	40,5	41,5	42,5	43,5	44,5	45,8	47,8	49,8	50,8	51,8
a	6,6	6,7	6,7	6,8	6,9	6,9	7	7,1	7,2	7,3
b	4,6	4,7	4,8	4,9	5	5,1	5,2	5,3	5,4	5,5
d ₅	2,5	2,5	2,5	2,5	2,5	2,5	2,5	2,5	2,5	2,5
d ₂	41,5	42,5	43,5	44,5	45,5	47	49	51	52	53
m	1,85	1,85	1,85	1,85	1,85	2,15	2,15	2,15	2,15	2,15
n	3,8	3,8	3,8	3,8	3,8	4,5	4,5	4,5	4,5	4,5
d ₄	-	59,1	-	-	62,5	64,5	66,7	-	70,2	71,6

Maße	57*	58	60	62	63	65	67*	68	70	72
s	2	2	2	2	2	2,5	2,5	2,5	2,5	2,5
d ₃	52,8	53,8	55,8	57,8	58,8	60,8	62,5	63,5	65,5	67,5
a	7,3	7,3	7,4	7,5	7,6	7,8	7,9	8	8,1	8,2
b	5,5	5,6	5,8	6	6,2	6,3	6,4	6,5	6,6	6,8
d ₅	2,5	2,5	2,5	2,5	2,5	3	3	3	3	3
d ₂	54	55	57	59	60	62	64	65	67	69
m	2,15	2,15	2,15	2,15	2,15	2,65	2,65	2,65	2,65	2,65
n	4,5	4,5	4,5	4,5	4,5	4,5	4,5	4,5	4,5	4,5
d ₄	-	73,6	75,6	77,8	79	81,4	-	84,8	87	89,2

Maße	75	77*	78	80	82	85	87*	88	90	92*
s	2,5	2,5	2,5	2,5	2,5	3	3	3	3	3
d ₃	70,5	72,5	73,5	74,5	76,5	79,5	81,5	82,5	84,5	86,5
a	8,4	8,5	8,6	8,6	8,7	8,7	8,8	8,8	8,8	9
b	7	7,2	7,3	7,4	7,6	7,8	7,9	8	8,2	8,4
d ₅	3	3	3	3	3	3,5	3,5	3,5	3,5	3,5
d ₂	72	74	75	76,5	78,5	81,5	83,5	84,5	86,5	88,5
m	2,65	2,65	2,65	2,65	2,65	3,15	3,15	3,15	3,15	3,15
n	4,5	4,5	4,5	5,3	5,3	5,3	5,3	5,3	5,3	5,3
d ₄	92,7	-	96,1	98,1	100,3	103,3	-	106,5	108,5	-

Nennmaß = für Wellen Ø

*Zwischengrößen nicht in der Norm enthalten

Verfügbare Abmessungen auf den folgenden Seiten:

Stahl/Stahl mit Oberfläche: [S. 89](#) | Edelstahl: [S. 469](#)



Sicherungsscheiben und Sicherungsringe

DIN 471

Sicherungsringe (Haltringe)
für Wellen
Regelausführung

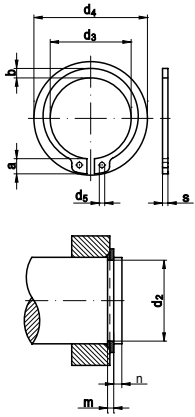

Maße	95	97*	98*	100	102*	105	107*	108*	110	112*	115
s	3	3	3	3	4	4	4	4	4	4	4
d ₃	89,5	91,5	91,5	94,5	95	98	100	100	103	105	108
a	9,4	9,4	9,4	9,6	9,7	9,9	10	10	10,1	103	10,6
b	8,6	8,8	8,8	9	9,2	9,3	9,5	9,5	9,6	9,7	9,8
d ₅	3,5	3,5	3,5	3,5	3,5	3,5	3,5	3,5	3,5	3,5	3,5
d ₂	91,5	93,5	94,5	96,5	98	101	103	104	106	108	111
m	3,15	3,15	3,15	3,15	4,15	4,15	4,15	4,15	4,15	4,15	4,15
n	5,3	5,3	5,3	5,3	6	6	6	6	6	6	6
d ₄	114,8	-	-	120,2	-	125,8	-	-	131,2	-	137,3

Maße	117*	118*	120	122*	125	127*	128*	130	132*	135	137*
s	4	4	4	4	4	4	4	4	4	4	4
d ₃	110	110	113	115	118	120	120	123	125	128	130
a	10,8	10,8	11	11,2	11,4	11,4	11,4	11,6	11,7	11,8	11,9
b	10	10	10,2	10,3	10,4	10,5	10,5	10,7	10,8	11	11
d ₅	3,5	3,5	3,5	4	4	4	4	4	4	4	4
d ₂	113	114	116	118	121	123	124	126	128	131	133
m	4,15	4,15	4,15	4,15	4,15	4,15	4,15	4,15	4,15	4,15	4,15
n	6	6	6	6	6	6	6	6	6	6	6
d ₄	-	-	143,1	-	149	-	-	154,4	-	159,8	-

Maße	138*	140	145	147*	148*	150	155	160	165	168*	170
s	4	4	4	4	4	4	4	4	4	4	4
d ₃	130	133	138	140	140	142	146	151	155,5	157,5	160,5
a	11,9	12	12,2	12,3	12,3	13	13	13,3	13,5	13,5	13,5
b	11	11,2	11,5	11,6	11,6	11,8	12	12,2	12,5	12,9	12,9
d ₅	4	4	4	4	4	4	4	4	4	4	4
d ₂	134	136	141	143	144	145	150	155	160	163	165
m	4,15	4,15	4,15	4,15	4,15	4,15	4,15	4,15	4,15	4,15	4,15
n	6	6	6	6	6	7,5	7,5	7,5	7,5	7,5	7,5
d ₄	-	165,2	170,6	-	-	177,3	182,3	188	193,4	-	198,4

Maße	175	180	185	190	195	200	210	215*	220	230	240
s	4	4	4	4	4	4	5	5	5	5	5
d ₃	165,5	170,5	175,5	180,5	185,5	190,5	198	203	208	218	228
a	13,5	14,2	14,2	14,2	14,2	14,2	14,2	14,2	14,2	14,2	14,2
b	12,9	13,5	13,5	14	14	14	14	14	14	14	14
d ₅	4	4	4	4	4	4	4	4	4	4	4
d ₂	170	175	180	185	190	195	204	209	214	224	234
m	4,15	4,15	4,15	4,15	4,15	4,15	5,15	5,15	5,15	5,15	5,15
n	7,5	7,5	7,5	7,5	7,5	7,5	9	9	9	9	9
d ₄	203,4	210	215	220	225	230	240	-	250	260	270

Maße	250	255*	260	270	280	290	300	400*			
s	5	5	5	5	5	5	5	6			
d ₃	238	240	245	255	265	275	285	283			
a	14,2	16,2	16,2	16,2	16,2	16,2	16,2	-			
b	14	16	16	16	16	16	16	20			
d ₅	4	5	5	5	5	5	5	6			
d ₂	244	247	252	262	272	282	292	390			
m	5,15	5,15	5,15	5,15	5,15	5,15	5,15	6,2			
n	9	12	12	12	12	12	12	15			
d ₄	280	-	294	304	314	324	334	-			

Nennmaß = für Wellen Ø

*Zwischengrößen nicht in der Norm enthalten

Verfügbare Abmessungen auf den folgenden Seiten:

Stahl/Stahl mit Oberfläche: S. 89 | Edelstahl: S. 469



Sicherungsscheiben und Sicherungsringe

DIN 471

Sicherungsringe (Halteringe) für Wellen Schwere Ausführung

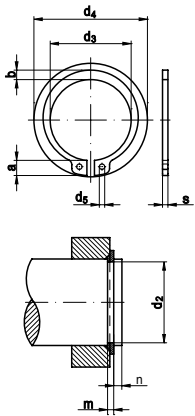

Nennmaß = für Wellen \varnothing

Maße	15	16	20	25	30	35
s	1,5	1,5	1,75	2	2	2,5
d ₃	13,8	14,7	18,5	23,2	27,9	32,2
a	4,8	5	5,5	6,4	6,5	6,7
b	2,4	2,5	3	3,4	4,1	4,2
d ₅	2	2	2	2	2	2,5
d ₂	14,3	15,2	19	23,9	28,6	33
m	1,6	1,6	1,85	2,15	2,15	2,65
n	1,1	1,2	1,5	1,7	2,1	3
d ₄	25,1	26,5	31,6	38,5	43,7	49,1
Maße	40	45	50	55	60	
s	2,5	2,5	3	3	3	
d ₃	36,5	41,5	45,8	50,8	55,8	
a	7	7,5	8	8,5	9	
b	4,4	4,7	5,1	5,4	5,8	
d ₅	2,5	2,5	2,5	2,5	2,5	
d ₂	37,5	42,5	47	52	57	
m	2,65	2,65	3,15	3,15	3,15	
n	3,8	3,8	4,5	4,5	4,5	
d ₄	54,7	60,8	66,8	72,9	78,9	

Verfügbare Abmessungen auf den folgenden Seiten:

Stahl/Stahl mit Oberfläche: [S. 89](#)



Sicherungsscheiben und Sicherungsringe

DIN 472

Sicherungsringe (Halteringe)
für Bohrungen
Regelausführung

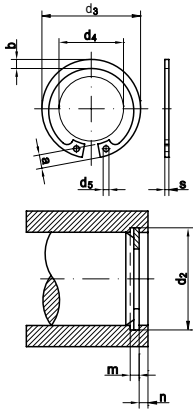

Maße	8	9	10	11	12	13	14	15
s	0,8	0,8	1	1	1	1	1	1
d ₃	8,7	9,8	10,8	11,8	13	14,1	15,1	16,2
a	2,4	2,5	3,2	3,3	3,4	3,6	3,7	3,7
b	1,1	1,3	1,4	1,5	1,7	1,8	1,9	2
d ₅	1	1	1,2	1,2	1,5	1,5	1,7	1,7
d ₂	8,4	9,4	10,4	11,4	12,5	13,6	14,6	15,7
m	0,9	0,9	1,1	1,1	1,1	1,1	1,1	1,1
n	0,6	0,6	0,6	0,6	0,8	0,9	0,9	1,1
d ₄	3	3,7	3,3	4,1	4,9	5,4	6,2	7,2

Maße	16	17	18	19	20	21	22	23*
s	1	1	1	1	1	1	1	1,2
d ₃	17,3	18,3	19,5	20,5	21,5	22,5	23,5	24,6
a	3,8	3,9	4,1	4,1	4,2	4,2	4,2	4,2
b	2	2,1	2,2	2,2	2,3	2,4	2,5	2,5
d ₅	1,7	1,7	2	2	2	2	2	2
d ₂	16,8	17,8	19	20	21	22	23	24,1
m	1,1	1,1	1,1	1,1	1,1	1,1	1,1	1,3
n	1,2	1,2	1,5	1,5	1,5	1,5	1,5	1,7
d ₄	8	8,8	9,4	10,4	11,2	12,2	13,2	-

Maße	24	25	26	27*	28	29*	30	31
s	1,2	1,2	1,2	1,2	1,2	1,2	1,2	1,2
d ₃	25,9	26,9	27,9	29,1	30,1	31,1	32,1	33,4
a	4,4	4,5	4,7	4,7	4,8	4,8	4,8	5,2
b	2,6	2,7	2,8	2,9	2,9	3	3	3,2
d ₅	2	2	2	2	2	2	2	2,5
d ₂	25,2	26,2	27,2	28,4	29,4	30,4	31,4	32,7
m	1,3	1,3	1,3	1,3	1,3	1,3	1,3	1,3
n	1,8	1,8	1,8	2,1	2,1	2,1	2,1	2,6
d ₄	14,8	15,5	16,1	-	17,9	-	19,9	20

Maße	32	33*	34	35	36	37	38	39*
s	1,2	1,2	1,5	1,5	1,5	1,5	1,5	1,5
d ₃	34,4	35,5	36,5	37,8	38,8	39,8	40,8	42
a	5,4	5,4	5,4	5,4	5,4	5,5	5,5	5,6
b	3,2	3,3	3,3	3,4	3,5	3,6	3,7	3,8
d ₅	2,5	2,5	2,5	2,5	2,5	2,5	2,5	2,5
d ₂	33,7	34,7	35,7	37	38	39	40	41
m	1,3	1,3	1,6	1,6	1,6	1,6	1,6	1,6
n	2,6	2,6	2,6	3	3	3	3	3
d ₄	20,6	-	22,6	23,6	24,6	25,4	26,4	-

Maße	40	41*	42	44*	45	46*	47	48
s	1,75	1,75	1,75	1,75	1,75	1,75	1,75	1,75
d ₃	43,5	44,5	45,5	47,5	48,5	49,5	50,5	51,5
a	5,8	5,9	5,9	6	6,2	6,3	6,4	6,4
b	3,9	4	4,1	4,2	4,3	4,4	4,4	4,5
d ₅	2,5	2,5	2,5	2,5	2,5	2,5	2,5	2,5
d ₂	42,5	43,5	44,5	46,5	47,5	48,5	49,5	50,5
m	1,85	1,85	1,85	1,85	1,85	1,85	1,85	1,85
n	3,8	3,8	3,8	3,8	3,8	3,8	3,8	3,8
d ₄	27,8	-	29,6	-	32	-	33,5	34,5

Nennmaß = für Wellen Ø

*Zwischengrößen nicht in der Norm enthalten

Verfügbare Abmessungen auf den folgenden Seiten:

Stahl/Stahl mit Oberfläche: S. 90 | Edelstahl: S. 470



Sicherungsscheiben und Sicherungsringe

DIN 472

**Sicherungsringe (Haltringe)
für Bohrungen
Regelausführung**

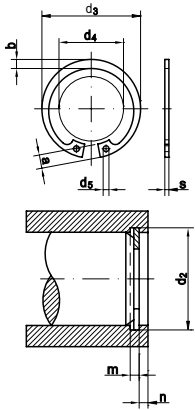

Maße	50	51*	52	53*	54*	55	56	57*
s	2	2	2	2	2	2	2	2
d ₃	54,2	55,2	56,2	57,2	58,2	59,2	60,2	61,2
a	6,5	6,5	6,7	6,7	6,7	6,8	6,8	6,8
b	4,6	4,7	4,7	4,9	5	5	5,1	5,1
d ₅	2,5	2,5	2,5	2,5	2,5	2,5	2,5	2,5
d ₂	53	54	55	56	57	58	59	60
m	2,15	2,15	2,15	2,15	2,15	2,15	2,15	2,15
n	4,5	4,5	4,5	4,5	4,5	4,5	4,5	4,5
d ₄	36,3	-	37,9	-	-	40,7	41,7	-

Maße	58	60	62	63	64*	65	67*	68
s	2	2	2	2	2	2,5	2,5	2,5
d ₃	62,2	64,2	66,2	67,2	68,2	69,2	71,5	72,5
a	6,9	7,3	7,3	7,3	7,4	7,6	7,7	7,8
b	5,2	5,4	5,5	5,6	5,7	5,8	6	6,1
d ₅	2,5	2,5	2,5	2,5	2,5	3	3	3
d ₂	61	63	65	66	67	68	70	71
m	2,15	2,15	2,15	2,15	2,15	2,65	2,65	2,65
n	4,5	4,5	4,5	4,5	4,5	4,5	4,5	4,5
d ₄	43,5	44,7	46,7	47,7	-	49	-	51,6

Maße	70	72	75	77*	78	80	82	85
s	2,5	2,5	2,5	2,5	2,5	2,5	2,5	3
d ₃	74,5	76,5	79,5	82,5	82,5	85,5	87,5	90,5
a	7,8	7,8	7,8	8,5	8,5	8,5	8,5	8,6
b	6,2	6,4	6,6	6,8	6,8	7	7	7,2
d ₅	3	3	3	3	3	3	3	3,5
d ₂	73	75	78	80	81	83,5	85,5	88,5
m	2,65	2,65	2,65	2,65	2,65	2,65	2,65	3,15
n	4,5	4,5	4,5	4,5	4,5	5,3	5,3	5,3
d ₄	53,6	55,6	58,6	-	60,1	62,1	64,1	66,9

Maße	88	90	92	95	97*	98	100	102
s	3	3	3	3	3	3	3	4
d ₃	93,5	95,5	97,5	100,5	103,5	103,5	105,5	108
a	8,6	8,6	8,7	8,8	9	9	9,2	9,5
b	7,4	7,6	7,8	8,1	8,3	8,3	8,4	8,5
d ₅	3,5	3,5	3,5	3,5	3,5	3,5	3,5	3,5
d ₂	91,5	93,5	95,5	98,5	100,5	101,5	103,5	106
m	3,15	3,15	3,15	3,15	3,15	3,15	3,15	4,15
n	5,3	5,3	5,3	5,3	5,3	5,3	5,3	6
d ₄	69,9	71,9	73,7	76,5	-	79	80,6	82

Maße	105	108	110	112	115	118*	120	122*
s	4	4	4	4	4	4	4	4
d ₃	112	115	117	119	122	125	127	129
a	9,5	9,5	10,4	10,5	10,5	10,7	11	11
b	8,7	8,9	9	9,1	9,3	9,6	9,7	9,8
d ₅	3,5	3,5	3,5	3,5	3,5	3,5	3,5	4
d ₂	109	112	114	116	119	122	124	126
m	4,15	4,15	4,15	4,15	4,15	4,15	4,15	4,15
n	6	6	6	6	6	6	6	6
d ₄	85	88	88,2	90	93	-	96,9	-

Nennmaß = für Wellen Ø

*Zwischengrößen nicht in der Norm enthalten

Verfügbare Abmessungen auf den folgenden Seiten:

Stahl/Stahl mit Oberfläche: [S. 90](#) | Edelstahl: [S. 470](#)



Sicherungsscheiben und Sicherungsringe

DIN 472

Sicherungsringe (Haltringe)
für Bohrungen
Regelausführung

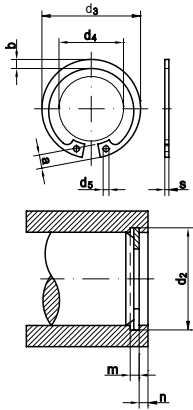

Maße	125	128*	130	132*	135	138*	140	142*	145	148*
s	4	4	4	4	4	4	4	4	4	4
d ₃	132	135	137	139	142	145	147	149	152	155
a	11	11	11	11	11,2	11,2	11,2	11,3	11,4	11,8
b	10	10,2	10,2	10,3	10,5	10,6	10,7	10,8	10,9	11,1
d ₅	4	4	4	4	4	4	4	4	4	4
d ₂	129	132	134	136	139	142	144	146	149	152
m	4,15	4,15	4,15	4,15	4,15	4,15	4,15	4,15	4,15	4,15
n	6	6	6	6	6	6	6	6	6	6
d ₄	101,9	-	106,9	-	111,5	-	116,5	-	121	-

Maße	150	152*	155	160	165	168*	170	175	180	185
s	4	4	4	4	4	4	4	4	4	4
d ₃	158	161	164	169	174,5	177,5	179,5	184,5	189,5	194,5
a	12	12	12	13	13	13,5	13,5	13,5	14,2	14,2
b	11,2	11,3	11,4	11,6	11,8	12,1	12,2	12,7	13,2	13,7
d ₅	4	4	4	4	4	4	4	4	4	4
d ₂	155	157	160	165	170	173	175	180	185	190
m	4,15	4,15	4,15	4,15	4,15	4,15	4,15	4,15	4,15	4,15
n	7,5	7,5	7,5	7,5	7,5	7,5	7,5	7,5	7,5	7,5
d ₄	124,8	-	129,8	132,7	137,7	-	141,6	146,6	150,2	155,2

Maße	190	195	200	205*	210	215*	220	225*	230	240
s	4	4	4	5	5	5	5	5	5	5
d ₃	199,5	204,5	209,5	217	222	227	232	237	242	252
a	14,2	14,2	14,2	14,2	14,2	14,2	14,2	14,2	14,2	14,2
b	13,8	13,8	14	14	14	14	14	14	14	14
d ₅	4	4	4	4	4	4	4	4	4	4
d ₂	195	200	205	211	216	221	226	231	236	246
m	4,15	4,15	4,15	5,15	5,15	5,15	5,15	5,15	5,15	5,15
n	7,5	7,5	7,5	9	9	9	9	9	9	9
d ₄	160,2	165,2	170,2	-	180,2	-	190,2	-	200,2	210,2

Maße	245*	250	255*	260	265*	270	275*	280	285*	290
s	5	5	5	5	5	5	5	5	5	5
d ₃	257	262	270	275	280	285	290	295	300	305
a	14,2	14,2	16,2	16,2	16,2	16,2	16,2	16,2	16,2	16,2
b	14	14	16	16	16	16	16	16	16	16
d ₅	4	4	5	5	5	5	5	5	5	5
d ₂	251	256	263	268	273	278	283	288	293	298
m	5,15	5,15	5,15	5,15	5,15	5,15	5,15	5,15	5,15	5,15
n	9	9	12	12	12	12	12	12	12	12
d ₄	-	220,2	-	226	-	236	-	246	-	256

Maße	295*	300	310*	320*	340*	360*				
s	5	5	6	6	6	6				
d ₃	310	315	327	337	357	377				
a	16,2	16,2	-	-	-	-				
b	16	16	20	20	20	20				
d ₅	5	5	6	6	6	6				
d ₂	303	308	320	330	350	370				
m	5,15	5,15	3,2	6,2	6,2	6,2				
n	12	12	15	15	15	15				
d ₄	-	266	-	-	-	-				

Nennmaß = für Wellen Ø

*Zwischengrößen nicht in der Norm enthalten

Verfügbare Abmessungen auf den folgenden Seiten:

Stahl/Stahl mit Oberfläche: S. 90 | Edelstahl: S. 470



Sicherungsscheiben und Sicherungsringe

DIN 983

Wellensicherungsringe mit Lappen
(Haltringe) für Wellen

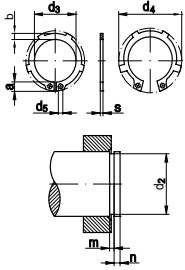

Nennmaß = für Wellen \varnothing

Maße	20	25	30	35	40	45	50
s	1,2	1,2	1,5	1,5	1,75	1,75	2
d ₃	18,5	23,2	27,9	32,2	36,5	41,5	45,8
a	3,8	4,3	4,7	5,2	7,2	7,2	8,2
b	2,6	3	3,5	3,9	4,4	4,7	5,1
d ₅	2	2	2	2,5	2,5	2,5	2,5
d ₂	19	23,9	28,6	33	37,5	42,5	47
m	1,3	1,3	1,6	1,6	1,85	1,85	2,15
n	1,5	1,7	2,1	3	3,8	3,8	4,5
d ₄	28	34	39,9	45,9	55,1	60,1	67,2

Verfügbare Abmessungen auf den folgenden Seiten:

Stahl/Stahl mit Oberfläche: [S. 201](#)

DIN 5406

Muttersicherungen/Sicherungsbleche
für Nutmutter DIN 981

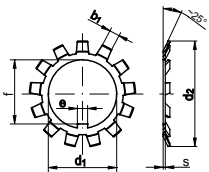

Maße	MB 0	MB 1	MB 2	MB 3	MB 4	MB 5	MB 6	MB 7
d ₁	10	12	15	17	20	25	30	35
d ₂	21	25	28	32	36	42	49	57
e	3	3	4	4	4	5	5	6
f	8,5	10,5	13,5	15,5	18,5	23	27,5	32,5
b ₁	3	3	4	4	4	5	5	5
s	1	1	1	1	1	1,25	1,25	1,25
f. Nutmutter DIN 981	KM 0	KM 1	KM 2	KM 3	KM 4	KM 5	KM 6	KM 7

Maße	MB 8	MB 9	MB 10	MB 11	MB 12	MB 13	MB 14	MB 15
d ₁	40	45	50	55	60	65	70	75
d ₂	62	69	74	81	86,4	92	98	104
e	6	6	6	8	8	8	8	8
f	37,5	42,5	47,5	52,5	57,5	62,5	66,5	71,5
b ₁	6	6	6	7	7	7	8	8
s	1,25	1,25	1,25	1,5	1,5	1,5	1,5	1,5
f. Nutmutter DIN 981	KM 8	KM 9	KM 10	KM 11	KM 12	KM 13	KM 14	KM 15

Maße	MB 16	MB 17	MB 18	MB 19	MB 20	MB 21	MB 22	MB 23
d ₁	80	85	90	95	100	105	110	115
d ₂	112	119	126	133	142	145	154	159
e	10	10	10	10	12	12	12	12
f	76,5	81,5	86,5	91,5	96,5	100,5	105,5	110,5
b ₁	8	8	10	10	10	12	12	12
s	1,75	1,75	1,75	1,75	1,75	1,75	1,75	2
f. Nutmutter DIN 981	KM 16	KM 17	KM 18	KM 19	KM 20	KM 21	KM 22	KM 23

Maße	MB 24	MB 25	MB 26	MB 27	MB 28	MB 29	MB 30
d ₁	120	125	130	135	140	145	150
d ₂	164	170	175	185	192	202	205
e	14	14	14	14	16	16	16
f	115	120	125	130	135	140	145
b ₁	12	12	12	14	14	14	14
s	2	2	2	2	2	2	2
f. Nutmutter DIN 981	KM 24	KM 25	KM 26	KM 27	KM 28	KM 29	KM 30

Verfügbare Abmessungen auf den folgenden Seiten:

Stahl/Stahl mit Oberfläche: [S. 306](#)



Sicherungsscheiben und Sicherungsringe

DIN 6797

Zahnscheiben

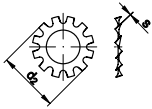

Form A = außergezahnt

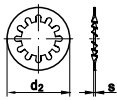

Form I = innengezahnt

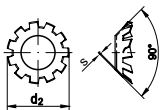

Form V = versenkt

*gemäß DIN 6797:1971

Maße	3,2	3,7	4,3	5,3	6,4	7,4
d _{2 Form A/I}	6	7	8	10	11	12,5
d _{2 Form V}	6	7	8	9,8	11,8	-
s _{Form A/I}	0,4	0,5	0,5	0,6	0,7	0,8
s _{Form V}	0,2	0,25	0,25	0,3	0,4	-
für Gewinde Ø	3	3,5	4	5	6	7

Maße	8,4	10,5	12,5*	13	15	17
d _{2 Form A/I}	15	18	20,5	20,5	24	26
d _{2 Form V}	15,3	19	23	23	-	-
s _{Form A/I}	0,8	0,9	1	1	1	1,2
s _{Form V}	0,4	0,5	0,5	0,5	-	-
für Gewinde Ø	8	10	12	12	14	16

Maße	19	21	23	25	28	31
d _{2 Form A/I}	30	33	36	38	44	48
d _{2 Form V}	-	-	-	-	-	-
s _{Form A/I}	1,4	1,4	1,5	1,5	1,6	1,6
s _{Form V}	-	-	-	-	-	-
für Gewinde Ø	18	20	22	24	27	30

Verfügbare Abmessungen auf den folgenden Seiten:

Stahl/Stahl mit Oberfläche: [S. 311](#) | Edelstahl: [S. 553](#)

DIN 6798

Fächerscheiben

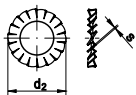

Form A = außergezahnt

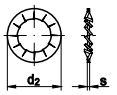

Form I = innengezahnt

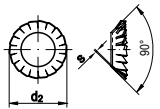

Form V = versenkt

*gemäß DIN 6798:1971

Maße	2,2	2,5*	2,7	3,2	3,7	4,3	5,3
d _{2 Form A/I}	4,5	5	5,5	6	7	8	10
d _{2 Form V}	-	-	-	6	7	8	9,8
s _{Form A/I}	0,3	0,4	0,4	0,4	0,5	0,5	0,6
s _{Form V}	-	-	-	0,2	0,25	0,25	0,3
für Gewinde Ø	2	2,3	2,5	3	3,5	4	5

Maße	6,4	7,4	8,4	10,5	13	15	17
d _{2 Form A/I}	11	12,5	15	18	20,5	24	26
d _{2 Form V}	11,8	-	15,3	19	23	-	-
s _{Form A/I}	0,7	0,8	0,8	0,9	1	1	1,2
s _{Form V}	0,4	-	0,4	0,5	0,5	-	-
für Gewinde Ø	6	7	8	10	12	14	16

Maße	19	21	23	25	28	31
d _{2 Form A/I}	30	33	36	38	44	48
d _{2 Form V}	-	-	-	-	-	-
s _{Form A/I}	1,4	1,4	1,5	1,5	1,6	1,6
s _{Form V}	-	-	-	-	-	-
für Gewinde Ø	18	20	22	24	27	30

Verfügbare Abmessungen auf den folgenden Seiten:

Stahl/Stahl mit Oberfläche: [S. 313](#) | Edelstahl: [S. 554](#) | Nichteisen-Werkstoffe: [S. 639](#)



Sicherungsscheiben und Sicherungsringe

DIN 6799

Sicherungsscheiben für Wellen

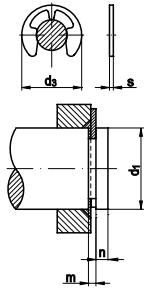

Maße	0,8	1,2	1,5	1,9	2,3	3,2
d_3	2,25	3,25	4,25	4,8	6,3	7,3
s	0,2	0,3	0,4	0,5	0,6	0,6
für Wellen $\varnothing d_1$	1 – 1,4	1,4 – 2	2 – 2,5	2,5 – 3	3 – 4	4 – 5
m	0,24	0,34	0,44	0,54	0,64	0,64
n	0,4	0,6	0,8	1	1	1

Maße	4	5	6	7	8	9
d_3	9,3	11,3	12,3	14,3	16,3	18,8
s	0,7	0,7	0,7	0,9	1	1,1
für Wellen $\varnothing d_1$	5 – 7	6 – 8	7 – 9	8 – 11	9 – 12	10 – 14
m	0,74	0,74	0,74	0,94	1,05	1,15
n	1,2	1,2	1,2	1,5	1,8	2

Maße	10	12	15	19	24	
d_3	20,4	23,4	29,4	37,6	44,6	
s	1,2	1,3	1,5	1,75	2	
für Wellen $\varnothing d_1$	11 – 15	13 – 18	16 – 24	20 – 31	25 – 38	
m	1,25	1,35	1,55	1,80	2,05	
n	2	2,5	3	3,5	4	

Verfügbare Abmessungen auf den folgenden Seiten:

Stahl/Stahl mit Oberfläche: [S. 314](#) | Edelstahl: [S. 554](#)

DIN 7980

Federringe für Zylinderschrauben

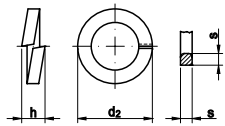

Maße	3	4	5	6	8	10	12
d_2	5,6	7	8,8	9,9	12,7	16	18
s	1	1,2	1,6	1,6	2	2,5	2,5
h	2	2,4	3,2	3,2	4	5	5
für Gewinde \varnothing	3	4	5	6	8	10	12

Maße	14	16	18	20	22	24	27
d_2	21,1	24,4	26,4	30,6	32,9	35,9	38,9
s	3	3,5	3,5	4,5	4,5	5	5
h	6	7	7	9	9	10	10
für Gewinde \varnothing	14	16	18	20	22	24	27

Maße	30	33	36	42	48		
d_2	44,1	47,1	52,2	60,2	67		
s	6	6	7	8	8		
h	12	12	14	16	16		
für Gewinde \varnothing	30	33	36	42	48		

Verfügbare Abmessungen auf den folgenden Seiten:

Stahl/Stahl mit Oberfläche: [S. 357](#) | Edelstahl: [S. 575](#)



Sicherungsscheiben und Sicherungsringe

DIN 7993, 9925

Runddraht-Sprengringe
Form A = für Wellen

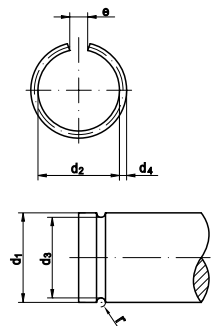

Maße	4	5	6	7	8	10	12
$d_{2 \text{ max. } 7993/9925}$	3,1/3,4	4,1/4,4	5,1/5,3	6,1/6,3	7,1	9,1	10,8
$d_{4 \text{ 7993/9925}}$	0,8/0,5	0,8/0,5	0,8/0,6	0,8/0,6	0,8	0,8	1
e	1	1	1	2	2	2	3
für Wellen $\varnothing d_1$	4	5	6	7	8	10	12
für Wellennut $\varnothing d_3 \text{ 7993/9925}$	3,2/3,5	4,2/4,5	5,2/5,4	6,2/6,4	7,2	9,2	11
Nutübergang r $7993/9925$	0,5/0,3	0,5/0,3	0,5/0,4	0,5/0,4	0,5	0,5	0,6

Maße	16	18	20	22	25	26	28
$d_{2 \text{ max. } 7993/9925}$	14,2	16,2	17,7	19,7	22,7	23,7	25,7
$d_{4 \text{ 7993/9925}}$	1,6	1,6	2	2	2	2	2
e	3	3	3	3	3	3	3
für Wellen $\varnothing d_1$	16	19	20	22	25	26	28
für Wellennut $\varnothing d_3 \text{ 7993/9925}$	14,4	16,4	18	20	23	24	26
Nutübergang r $7993/9925$	0,9	0,9	1,1	1,1	1,1	1,1	1,1

Maße	30	32	35	38	40	45	48
$d_{2 \text{ max. } 7993/9925}$	27,7	29,1	32,1	35,1	37,1	42	45
$d_{4 \text{ 7993/9925}}$	2	2,5	2,5	2,5	2,5	2,5	2,5
e	3	4	4	4	4	4	4
für Wellen $\varnothing d_1$	30	32	35	38	40	45	48
für Wellennut $\varnothing d_3 \text{ 7993/9925}$	28	29,5	32,5	35,5	37,5	42,5	45,5
Nutübergang r $7993/9925$	1,1	1,4	1,4	1,4	1,4	1,4	1,4

Maße	50	55	60	65	70		
$d_{2 \text{ max. } 7993/9925}$	47	51,1	56,1	61,1	66		
$d_{4 \text{ 7993/9925}}$	2,5	3,2	3,2	3,2	3,2		
e	4	4	4	4	5		
für Wellen $\varnothing d_1$	50	55	60	65	70		
für Wellennut $\varnothing d_3 \text{ 7993/9925}$	47,5	51,8	56,8	61,8	66,8		
Nutübergang r $7993/9925$	1,4	1,8	1,8	1,8	1,8		

Verfügbare Abmessungen auf den folgenden Seiten:

Stahl/Stahl mit Oberfläche: S. 369, S. 388

DIN 7993, 9926

Runddraht-Sprengringe
Form B = für Bohrungen

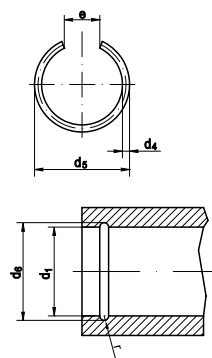

Maße	7	8	10	12	16	18
$d_{4 \text{ max. } 7993/9926}$	0,8/0,6	0,8/0,6	0,8	1	1,6	1,6
$d_{5 \text{ 7993/9926}}$	8,2/8	9,2/9	11,2	13,6	18,2	20,2
e	4	4	4	6	8	8
für Bohrung $\varnothing d_1$	7	8	10	12	16	18
für Wellennut $\varnothing d_6 \text{ 7993/9926}$	7,8/7,6	8,8/8,6	10,8	13	17,6	19,6
Nutübergang r $7993/9926$	0,5/0,4	0,5/0,4	0,5	0,6	0,9	0,9

Verfügbare Abmessungen auf den folgenden Seiten:

Stahl/Stahl mit Oberfläche: S. 369, S. 388



Sicherungsscheiben und Sicherungsringe

DIN 70952

Sicherungsbleche für Nutmuttern DIN 70852

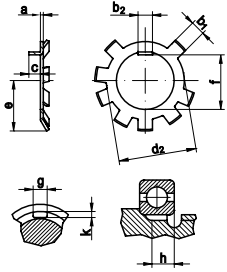

Maße	10	12	14	16	18	20	22	24	26
a	0,75	0,75	0,75	1	1	1	1	1	1
b ₁	4	4	4	5	5	5	6	6	6
b ₂	4	4	5	5	5	5	6	6	6
c	3	3	3	3	4	4	4	4	5
d ₂	16	18	20	23	25	27	30	32	34
e	11	12	13	14,5	16,5	17,5	19	20	22
f	8,9	10,9	12,9	14,9	16,9	18,9	20,9	22,9	24,9
g _{Welle} *	4	4	5	5	5	5	6	6	6
h _{Welle}	3	3	3	3	4	4	4	4	5
k _{Welle}	1,2	1,2	1,2	1,2	1,2	1,2	1,2	1,2	1,2

Maße	28	30	32	35	38	40	42	45	48
a	1	1,2	1,2	1,2	1,2	1,2	1,2	1,2	1,2
b ₁	6	6	6	6	6	6	7	7	7
b ₂	7	7	7	7	8	8	8	8	8
c	5	5	5	5	5	5	5	5	5
d ₂	36	38	41	43	47	49	52	54	57
e	23	24	25,5	26,5	28,5	29,5	31	32	33,5
f	26,9	28,9	30,9	33,9	36,6	38,6	40,6	43,6	46,7
g _{Welle} *	7	7	7	7	8	8	8	8	8
h _{Welle}	5	5	5	5	5	5	5	5	5
k _{Welle}	1,5	1,5	1,5	1,5	1,5	1,5	1,5	1,5	1,5

Maße	50	52	55	60	65	70	75	80	90
a	1,2	1,2	1,2	1,5	1,5	1,5	1,5	1,5	1,5
b ₁	7	7	7	10	10	10	10	10	10
b ₂	8	8	10	10	10	10	10	10	10
c	5	6	6	6	6	6	7	7	7
d ₂	60	62	67	71	76	81	86	91	103
e	35	37	39,5	41,5	44	46,5	50	52,5	58,5
f	48,7	50,7	53,7	58,7	63,7	68,7	73,2	78,2	88,2
g _{Welle} *	8	8	10	10	10	10	10	10	10
h _{Welle}	5	6	6	6	6	6	7	7	7
k _{Welle}	1,5	1,5	1,5	2	2	2	2	2	2

*Toleranzlage C11 an der Welle

Verfügbare Abmessungen auf den folgenden Seiten:

Stahl/Stahl mit Oberfläche: [S. 409](#)

DIN 74361

Federringe Form C

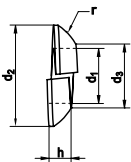

Maße	12,5	14,5	16,5	18,5	20,5	22,5
d ₂	23	26	26,5	29	34	34
d ₃	14,5	17	18	20	24	24
h	5	6	6,5	7	8	8
r	12	14	15	16	18	18

Verfügbare Abmessungen auf den folgenden Seiten:

Stahl/Stahl mit Oberfläche: [S. 410](#)



Sicherungsscheiben und Sicherungsringe

Artikel 88032

HEICO-LOCK-Keilsicherungs-scheiben

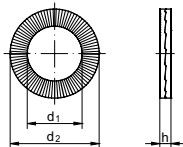

Maße	M 3	M 3,5	M 3,5	M 4	M 4	M 5	M 5
Typ	HLS	HLS	HLB	HLS	HLB	HLS	HLB
d ₁	3,4	3,9	3,9	4,4	4,4	5,4	5,4
d ₂	7	7,6	9	7,6	9	9	10,8
h Stahl/Edelstahl	1,7/1,6	1,7/1,6	1,7/1,6	1,7/1,6	1,7/1,6	1,7/1,6	1,7/1,6
Maße	M 6	M 6	M 8	M 8	M 10	M 10	M 12
Typ	HLS	HLB	HLS	HLB	HLS	HLB	HLS
d ₁	6,5	6,5	8,6	8,6	10,7	10,7	13
d ₂	10,8	13,5	13,5	16,6	16,6	21	19,5
h Stahl/Edelstahl	1,7/1,6	2,7/2,6	2,7/2,6	2,7/2,6	2,7/2,6	2,7/2,6	2,7/2,6
Maße	M 12	M 12	M 14	M 14	M 16	M 16	M 16
Typ	HLB	HLK	HLS	HLB	HLS	HLB	HLK
d ₁	13	13	15,2	15,2	17	17	17
d ₂	25,4	24	23	30,7	25,4	30,7	30
h Stahl/Edelstahl	3,7/3,6	3,7/-	3,7/3,6	3,7/3,6	3,7/3,6	3,7/3,6	3,7/-
Maße	M 18	M 18	M 20	M 20	M 20	M 22	M 22
Typ	HLS	HLB	HLS	HLB	HLK	HLS	HLB
d ₁	19,5	19,5	21,4	21,4	21	23,4	23,4
d ₂	29	34,5	30,7	39	37	34,5	42
h Stahl/Edelstahl	3,7/3,6	3,7/3,6	3,7/3,6	3,8	3,7/-	3,7/3,6	4,7/4,6
Maße	M 22	M 24	M 24	M 24	M 27	M 27	M 27
Typ	HLK	HLS	HLB	HLK	HLS	HLB	HLK
d ₁	23	25,3	25,3	25	28,4	28,4	28
d ₂	39	39	48,5	44	42	48,5	50
h Stahl/Edelstahl	4,7/-	3,7/3,6	4,7/4,6	4,7/-	5,4/5,3	6,7/6,6	6,7/-
Maße	M 30	M 30	M 33	M 36	M 36	M 39	M 42
Typ	HLS	HLK	HLS	HLS	HLK	HLS	HLS
d ₁	31,4	31	34,4	37,4	37	40,4	43,2
d ₂	47	56	48,5	55	66	58,5	63
h Stahl/Edelstahl	5,7/5,6	6,7/-	5,5/5,6	6,2/6,1	6,7/-	6,2/6	6,3/6,2

Typen: HLS = Standard
 HLB = vergrößerte Auflagefläche
 HLK = für HV-Schrauben

Verfügbare Abmessungen auf den folgenden Seiten:
 Stahl/Stahl mit Oberfläche: S. 433 | Edelstahl: S. 600

Artikel 88033

HEICO-LOCK-Ringsicherungs-scheiben

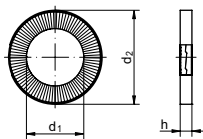

Maße	M 4	M 5	M 5	M 6	M 6	M 8	M 8
Typ	HLRB	HLRS	HLRB	HLRS	HLRB	HLRS	HLRB
d ₁	4,4	5,4	5,4	6,5	6,5	8,6	8,6
d ₂	9	9	10,8	10,8	13,5	13,5	16,6
h	1,5	1,5	1,5	1,5	2,5	2,5	2,5
Maße	M 10	M 10	M 12	M 12	M 14	M 16	M 16
Typ	HLRS	HLRB	HLRS	HLRB	HLRB	HLRS	HLRB
d ₁	10,7	10,7	13	13	15,2	17	17
d ₂	16,6	19,5	19,5	25,4	30,7	25,4	30,7
h	2,5	2,5	2,5	3,8	3,8	3,5	3,8

Typen: HLRS = Standard
 HLRB = vergrößerte Auflagefläche

Verfügbare Abmessungen auf den folgenden Seiten:
 Stahl/Stahl mit Oberfläche: S. 433



Sicherungsscheiben und Sicherungsringe

Artikel 88035

HEICO-LOCK-Kombischeiben

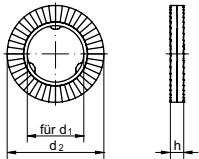

Typen: HKS = Standard
HKB = vergrößerte Auflagefläche

Maße	M 8	M 8	M 10	M 10
Typ	HKS	HKB	HKS	HKB
d ₂	13,5	16,6	16,6	21
h	2,4	2,7	2,4	2,7
Maße	M 12	M 12	M 16	M 16
Typ	HKS	HKB	HKS	HKB
d ₂	19,5	25,4	25,4	30,7
h	2,5	2,7	3,6	3,7

Verfügbare Abmessungen auf den folgenden Seiten:

Stahl/Stahl mit Oberfläche: [S. 434](#) | Edelstahl: [S. 601](#)

Artikel 88119

Locktix-Scheiben

zur Sicherung von Schraubverbindungen

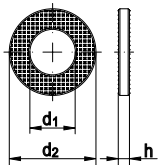

für Schrauben Fkl. 8.8/10.9/12.9

Maße	8	10	12	14
d _{1 min.}	8,4	10,5	13	14,2
d _{2 max.}	16	20	24	28
h	2,5	2,5	3	3
Maße	16	18	20	24
d _{1 min.}	16,5	18,2	20,2	24,2
d _{2 max.}	30	34	37	44
h	4	4	4	4

Verfügbare Abmessungen auf den folgenden Seiten:

Stahl/Stahl mit Oberfläche: [S. 432](#)

Artikel 88120

SCHNORR-Scheiben

Form S = Standard

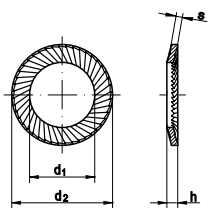

für Schrauben mit Fkl. ≤ 5.8

Maße	2	2,5	3	3,5	4	5	6
d ₁	2,2	2,7	3,2	3,7	4,3	5,3	6,4
d ₂	4	4,8	5,5	6	7	9	10
s	0,35	0,45	0,45	0,45	0,5	0,6	0,7
h	0,6	0,9	0,9	0,9	1	1,1	1,2
für Zoll Ø	-	-	1/8"	-	5/32"	3/16"	-
Maße	7	8	10	12	14	16	18
d ₁	7,4	8,4	10,5	13	15	17	19
d ₂	12	13	16	18	22	24	27
s	0,7	0,8	1	1,1	1,2	1,3	1,5
h	1,3	1,4	1,6	1,7	2	2,1	2,3
für Zoll Ø	-	5/16"	3/8"	-	9/16"	5/8"	-
Maße	20	22	24	27	30	36	
d ₁	21	23	25,6	28,6	31,6	38	
d ₂	30	33	36	39	45	54	
s	1,5	1,5	1,8	2	2	2,5	
h	2,5	2,7	2,9	3,1	3,6	4,2	
für Zoll Ø	-	7/8"	-	-	1 1/8"	1 3/8"	

Verfügbare Abmessungen auf den folgenden Seiten:

Stahl/Stahl mit Oberfläche: [S. 429](#) | Edelstahl: [S. 598](#)



Sicherungsscheiben und Sicherungsringe

Artikel 88121

SCHNORR-Scheiben
Form VS = verstärkt

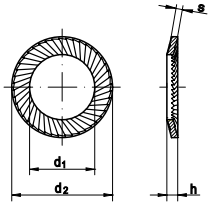

Maße	5	6	8	10	12	14	16
d ₁ ¹	5,3	6,4	8,4	10,5	13	15	17
d ₂ ²	9	10	13	16	18	22	24
s	1	1	1,2	1,5	1,5	1,5	2
h	1,3	1,4	1,7	2	2,1	2,2	2,6
für Zoll Ø	3/16"	-	5/16"	3/8"	-	9/16"	5/8"

Maße	18	20	22	24	27	30	
d ₁ ¹	19	21	23	25,6	28,6	31,6	
d ₂ ²	27	30	33	36	39	45	
s	2	2	2	2,5	2,5	2,5	
h	2,7	2,8	3	3,4	3,5	3,8	
für Zoll Ø	-	-	7/8"	-	-	1 1/8"	

für Schrauben mit Fkl. 8.8/10.9

Verfügbare Abmessungen auf den folgenden Seiten:

Stahl/Stahl mit Oberfläche: S. 429 | Edelstahl: S. 599

Artikel 88123

TECKENTRUP-Sperrkantscheiben SK-S/NSK-S
Form S = Standard

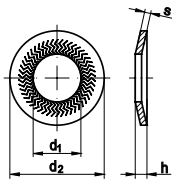

Maße	4	5	6	8	10	12
d ₁	4,1	5,1	6,1	8,2	10,2	12,4
d ₂	8,2	10,2	12,2	16,2	20,25	24,25
s	1	1	1,2	1,4	1,6	1,6
h _{SK-S/NSK-S}	1,35/1,3	1,5	1,8/1,75	2,4	2,4/2,75	2,6/3

für Schrauben mit Fkl. ≤ 5.8

Verfügbare Abmessungen auf den folgenden Seiten:

Stahl/Stahl mit Oberfläche: S. 430 | Edelstahl: S. 599

Artikel 88124

TECKENTRUP-Sperrkantscheiben SK-M/NSK-M
Form M = Mittel

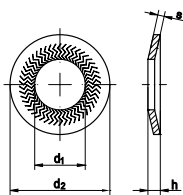

Maße	4	5	6	8	10	12
d ₁	4,1	5,1	6,1	8,2	10,2	12,4
d ₂	10,2	12,2	14,2	18,2	22,25	27,25
s	1	1,2	1,4	1,4	1,6	1,8
h _{SK-M/NSK-M}	1,5/1,45	1,8/1,75	2,2/2,15	2,4/2,7	2,75/3,1	3,05/3,65

Maße	14	16	18	20	24	
d ₁	14,4	16,4	18	21	25	
d ₂	30,25	32,5	35	40	50	
s	2,4	2,5	3	3	3,5	
h _{SK-M/NSK-M}	3,5/3,9	3,95/4,6	4,8	4,7/5	5,8	

für Schrauben mit Fkl. ≤ 10.9

Verfügbare Abmessungen auf den folgenden Seiten:

Stahl/Stahl mit Oberfläche: S. 430 | Edelstahl: S. 599



Sicherungsscheiben und Sicherungsringe

Artikel 88125

TECKENTRUP-Sperrkantscheiben SK-B/NSK-B
Form B = Breit

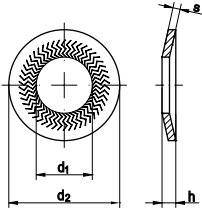

Maße	6	8	10	12
d_1	6,1	8,2	10,2	12,4
d_2	18,2	22,25	27,25	32,3
s	1,4	1,9	2,4	2,8
$h_{SK-B/NSK-B}$	2,55/2,6	2,9/3,1	3,65/3,6	4,5/4,8

für Schrauben mit Fkl. $\leq 10,9$

Verfügbare Abmessungen auf den folgenden Seiten:

Stahl/Stahl mit Oberfläche: [S. 430](#) | Edelstahl: [S. 599](#)

Artikel 88126

TECKENTRUP-Sperrkantscheiben SK-Z
Form Z = für Zylinderschrauben

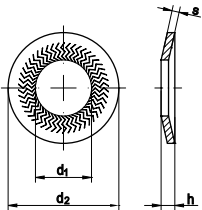

Maße	6	8	10	12	16
d_1	6,1	8,2	10,2	12,4	16,4
d_2	9,9	12,7	16,1	18,3	24,6
s	1,4	1,4	1,6	1,8	2,5
h	1,6	1,7	2	2,2	3,1

für Zylinderschrauben mit Fkl. $\leq 10,9$

Verfügbare Abmessungen auf den folgenden Seiten:

Stahl/Stahl mit Oberfläche: [S. 431](#)

Artikel 88129

TECKENTRUP-Sperrkantscheiben SK-K/NSK-K
Form K = für Kontaktzähnen

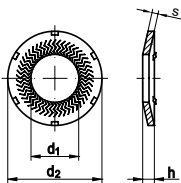

Maße	4	5	6	8	10	12
d_1	4,1	5,1	6,1	8,2	10,2	12,4
d_2	8,2	10,2	12,2	16,2	20,25	24,25
s	1	1	1,2	1,4	1,6	1,6
$h_{SK-K/NSK-K}$	1,35/1,3	1,5	1,8/1,9	2,4	2,6/2,75	2,6/3

für Schrauben mit Fkl. $\leq 5,8$

Verfügbare Abmessungen auf den folgenden Seiten:

Stahl/Stahl mit Oberfläche: [S. 431](#) | Edelstahl: [S. 600](#)



Sicherungsscheiben und Sicherungsringe

Artikel 88130

Sperrkantringe

Form VSK = Standardausführung

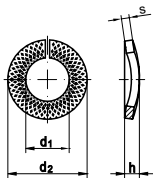

Maße	4	5	6	8	10	12	14
d ₁	4,1	5,1	6,1	8,1	10,2	12,2	14,2
d ₂	7,6	9,2	11,8	14,8	18,1	21,1	24,1
s	0,8	1	1,3	1,6	1,8	2,1	2,4
h _{max.}	1,4	1,7	2,2	2,75	3,15	3,15	4,3

Maße	16	18	20	22	24	27	30
d ₁	16,2	18,2	20,2	22,5	24,5	27,5	30,5
d ₂	27,4	29,4	33,6	35,9	40	43	48,2
s	2,8	2,8	3,2	3,2	4	4	6
h _{max.}	5,1	5,1	5,9	5,9	7,5	7,5	10,5

für Schrauben mit Fkl. ≤ 8.8

Verfügbare Abmessungen auf den folgenden Seiten:

Stahl/Stahl mit Oberfläche: S. 431 | Edelstahl: S. 600

Artikel 88131

Sperrkantringe

Form VSK-Z = für Zylinderschrauben

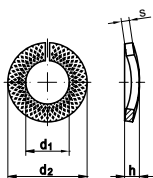

Maße	4	5	6	8
d ₁	4,1	5,1	6,1	8,1
d ₂	7	8,8	9,9	12,7
s	1,2	1,6	1,6	2
h	1,7	2,1	2,1	2,8

Maße	10	12	16	20
d ₁	10,2	12,2	16,2	20,2
d ₂	16,1	18,3	24,6	30,6
s	2,5	2,5	3,5	4,5
h	3,7	3,7	5,2	6,4

für Zylinderschrauben mit Fkl. ≤ 8.8

Verfügbare Abmessungen auf den folgenden Seiten:

Stahl/Stahl mit Oberfläche: S. 431

Artikel 88132

NORD-LOCK-Scheiben

Standardausführung

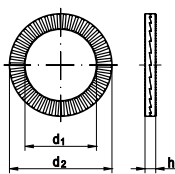

Maße	5	6	8	10	12	14	16	18
d ₁	5,4	6,5	8,7	10,7	13	15,2	17	19,5
d ₂	9	10,8	13,5	16,6	19,5	23	25,4	29
h	1,8	1,8	2,5	2,5	2,5	3,4	3,4	3,4
für Zoll Ø	No. 10	-	5/16"	-	-	9/16"	5/8"	-

Maße	20	22	24	27	30	33	36
d ₁	21,4	23,4	25,3	28,4	31,4	34,4	37,4
d ₂	30,7	34,5	39	42	47	48,5	55
h	3,4	3,4	3,4	6,6	6,6	6,6	6,6
für Zoll Ø	-	7/8"	-	-	1 1/8"	1 1/4"	1 3/8"

für Schrauben mit Fkl. ≤ 12.9

Verfügbare Abmessungen auf den folgenden Seiten:

Stahl/Stahl mit Oberfläche: S. 432 | Edelstahl: S. 600



Sicherungsscheiben und Sicherungsringe

Artikel 88132

NORD-LOCK-Scheiben

Form SP = mit vergrößerter Auflagefläche

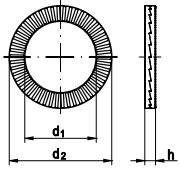

Maße	3	3,5	4	5	6	8
d ₁	3,4	3,9	4,4	5,4	6,5	8,7
d ₂	7	9	9	10,8	13,5	16,6
h	1,8	2,2	2,2	1,8	2,5	2,5
für Zoll Ø	5	6	8	No. 10	-	5/16"

Maße	10	12	14	16	18	20
d ₁	10,7	13	15,2	17	19,5	21,4
d ₂	21	25,4	30,7	30,7	34,5	39
h	2,5	3,4	3,4	3,4	3,4	3,4
für Zoll Ø	-	-	9/16"	5/8"	-	-

Maße	22	24	27	30	33	36
d ₁	23,4	25,3	28,4	32,4	34,4	37,4
d ₂	42	48,5	48,5	58,5	58,5	63
h	4,6	4,6	6,6	6,6	6,6	6,6
für Zoll Ø	7/8"	-	-	1 1/8"	1 1/4"	1 3/8"

für Schrauben mit Fkl. ≤ 12.9

Verfügbare Abmessungen auf den folgenden Seiten:

Stahl/Stahl mit Oberfläche: [S. 432](#)

Artikel 88132

NORD-LOCK-Scheiben X-series, Keilsicherungsfederscheiben®

Standardausführung

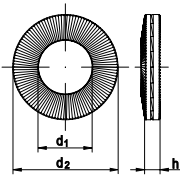

Maße	6	8	10	11	12	14	16
d ₁	6,3	8,4	10,5	11,5	12,5	14,6	16,6
d ₂	10,8	13,5	16,6	18,5	19,5	23	25,4
h	1,77	2,29	2,95	3,24	3,5	4,03	4,74
für Zoll Ø	-	5/16"	-	7/16"	-	9/16"	5/8"

Maße	18	20	22	24	27	30
d ₁	18,7	20,7	22,8	24,8	27,9	31
d ₂	29	30,7	34,5	39	42	47
h	5,36	6,01	6,8	7,19	8,28	9,06
für Zoll Ø	-	-	7/8"	-	-	1 1/8"

für Schrauben mit Fkl. ≤ 12.9

Verfügbare Abmessungen auf den folgenden Seiten:

Stahl/Stahl mit Oberfläche: [S. 432](#)

Artikel 88132

NORD-LOCK-Scheiben X-series, Keilsicherungsfederscheiben®

Form SP = mit vergrößerter Auflagefläche

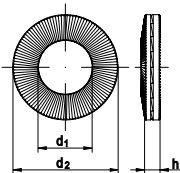

Maße	6	8	10	12	14	16
d ₁	6,3	8,4	10,5	12,5	14,6	16,6
d ₂	13,5	16,6	21	25,4	29	30,7
h	1,77	2,29	2,95	3,5	4,03	4,74
für Zoll Ø	-	5/16"	-	-	9/16"	5/8"

Maße	18	20	22	24	27	30
d ₁	18,7	20,7	22,8	24,8	27,9	31
d ₂	34,5	39	42	47	51	55
h	5,36	6,01	6,8	7,19	8,28	9,06
für Zoll Ø	-	-	7/8"	-	-	1 1/8"

für Schrauben mit Fkl. ≤ 12.9

Verfügbare Abmessungen auf den folgenden Seiten:

Stahl/Stahl mit Oberfläche: [S. 432](#)



Sicherungsscheiben und Sicherungsringe

Artikel 88132

NORD-LOCK-Scheiben

Form SC = für HV-Verbindungen nach EN 14399-4

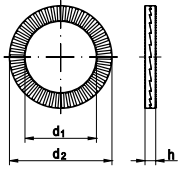

Maße	12	16	20	22
d ₁	13,1	17,1	21,4	23,4
d ₂	23,7	29,7	36,7	38,7
h	4,64	4,6	4,6	4,6

Maße	24	27	30	36
d ₁	25,3	28,4	31,4	37,4
d ₂	43,7	49,5	55,4	65,4
h	4,6	5,8	5,8	6

Verfügbare Abmessungen auf den folgenden Seiten:

Stahl/Stahl mit Oberfläche: [S. 432](#)

Artikel 88494

DUBO-Proflscheiben

für Sechskantschrauben

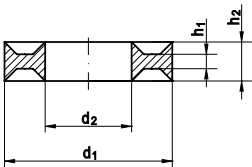

Anwendungsbeispiele:

ohne Tellerring (V₁)

vor dem Anzug nach dem Anzug

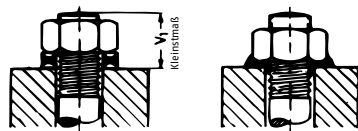

mit Tellerring (V₂)

vor dem Anzug nach dem Anzug

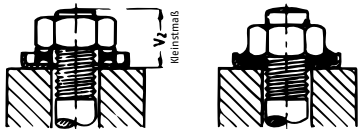

Maße	198	199	200	201	203	205
für Gewinde	M 3	M 4	M 5	M 6	M 8	M 10
d ₁	8	9,5	10,6	12,7	16,2	19,6
d ₂	3,2	4,15	5,15	6,2/6,5	8,1	10,2
h ₂	2,2	2,6	3	3,5	4	4,5
h ₁	0,8	1	1,2	1,4	1,6	1,8
V ₁	5	6	7	8,5	10,5	12,5
V ₂	-	-	-	9,25	11,5	13,5

Maße	207	209	211	213	215	217
für Gewinde	M 12	M 14	M 16	M 18	M 20	M 22
d ₁	23,6	25,4	29,4	35,1	35,7	41,6
d ₂	12,2	14,2	16,2	18,2	20,3	22,5
h ₂	5	5,5	6	6,5	7	7,5
h ₁	2	2,1	2,2	2,3	2,4	2,5
V ₁	14,5	16,5	19	21,5	23	24,5
V ₂	16	18	20,75	23,25	24,75	26,5

Maße	219	222	225	231	243
für Gewinde	M 24	M 27	M 30	M 36	M 48
d ₁	41,6	47,3	53,1	63,5	86,5
d ₂	24,3	27,3	30,2	36,2	48,2
h ₂	8	8,5	8,5	10	17
h ₁	2,6	2,7	2,8	3,2	4,5
V ₁	26	28,5	30,5	38	55
V ₂	28	30,5	-	-	-

Verfügbare Abmessungen auf den folgenden Seiten:

Nichteisen-Werkstoffe: [S. 646](#)



Sicherungsscheiben und Sicherungsringe

Artikel 88495

DUBO-Profilscheiben
für Zylinderschrauben

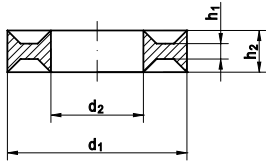

Anwendungsbeispiele:

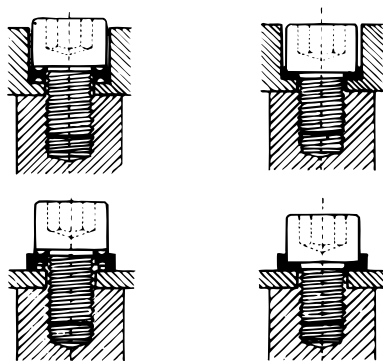

Maße	299	300	301	303
für Gewinde	M 4	M 5	M 6	M 8
d ₁	7,7	9,8	10,5	14
d ₂	4,1	5,15	6,1	8,1
h ₂	2	3	2,5	3,3
h ₁	0,8	2	1	1,5

Maße	305	307	311	315
für Gewinde	M 10	M 12	M 16	M 20
d ₁	17	19	25	31,5
d ₂	10,2	12,2	16,2	20,2
h ₂	3,8	4,4	5,6	6,5
h ₁	1,5	2	2	2,5

Verfügbare Abmessungen auf den folgenden Seiten:

Nichteisen-Werkstoffe: [S. 646](#)

Artikel 88496

DUBO-Zahn-Tellerringe,
für DUBO-Profilscheiben

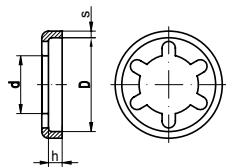

Maße	404	406	408	410	412
D	11,2	13,2	17,2	21,3	24,5
d	6,8	9	12	13,5	15,5
h	2,5	3,4	3,8	4,2	4,5
s	0,65	0,75	1	1,5	1,5
f. Sechskantschraube	M 4/5 3/16"	M 6 1/4"	M 8 5/16"	M 10 3/8"	M 12 7/16"
f. Zylinderschraube	M 6 1/4"	-	M 10 3/8"	M 12 1/2"	M 14

Maße	414	416	417	418	419
D	27	31,25	33	37,5	39,5
d	17,5	21	23	26	27
h	4,8	5	5	5,5	5,5
s	1,5	1,75	1,75	1,75	2
f. Sechskantschraube	1/2"	M 16	5/8"	M 18/20	3/4"
f. Zylinderschraube	M 16 5/8"	M 18	M 20	M 22 7/8"	M 24

Maße	422	427	430	433	436
D	44	50,5	56	61	67
d	30,5	35	40	45	50
h	6	7	7,5	8	8,3
s	2	2	2,5	2,5	2,75
f. Sechskantschraube	7/8"	M 27 1"	M 30 1 1/8"	M 33 1 1/4"	M 36 1 3/8"
f. Zylinderschraube	-	-	-	-	-

Verfügbare Abmessungen auf den folgenden Seiten:

Stahl/Stahl mit Oberfläche: [S. 646](#)



Stellringe

DIN 703

Stellringe

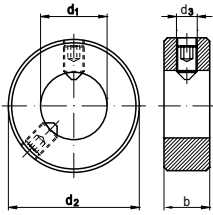

* $d_1 \leq 65$: ein Gewindestift mit Schlitz
 $d_1 \geq 68$: zwei Gewindestifte mit Innensechskant

Maße	20	25	30	35	40	45
d_2	40	56	63	70	80	80
d_3	M 10	M 10	M 10	M 10	M 12	M 12
b	20	22	22	22	28	28
Gewindestift*	M 10x15	M 10x15	M 10x15	M 10x15	M 12x20	M 12x20

Maße	50	60	70	80	90	100
d_2	90	100	110	125	125	140
d_3	M 12	M 12	M 16	M 16	M 16	M 16
b	28	28	32	32	32	32
Gewindestift*	M 12x20	M 12x20	M 16x20	M 16x20	M 16x20	M 16x25

Verfügbare Abmessungen auf den folgenden Seiten:

Stahl/Stahl mit Oberfläche: S. 110

DIN 705

Stellringe

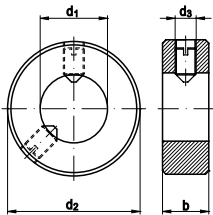

Form A = mit Gewindestiften

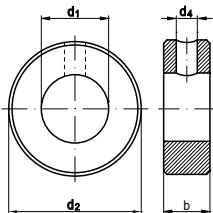

Form B = mit Bohrung für Korb- oder Kegelstift

Maße	4	5	6	8	9	10	12	13	14
b	5	6	8	8	10	10	12	12	12
d_2	8	10	12	16	18	20	22	22	25
d_3	M 2,5	M 3	M 4	M 4	M 4	M 5	M 6	M 6	M 6
d_4	1	1,5	1,5	2	2	3	4	4	4
A mit Stiften ¹	M 2,5x4	M 3x4	M 4x5	M 4x6	M 4x6	M 5x8	M 6x8	M 6x8	M 6x8
B für Stifte ²	1x8	1,5x10	1,5x12	2x16	2x16	3x20	4x22	4x22	4x24

Maße	15	16	17	18	20	22	24	25	26
b	12	12	12	14	14	14	16	16	16
d_2	25	28	28	32	32	36	40	40	40
d_3	M6	M6	M6	M6	M6	M6	M8	M8	M8
d_4	4	4	4	5	5	5	6	6	6
A mit Stiften ¹	M 6x8	M 6x8	M 6x8	M 6x8	M 6x8	M 6x10	M 8x12	M 8x10	M 8x10
B für Stifte ²	4x24	4x28	4x28	5x32	5x32	5x36	6x40	6x40	6x40

Maße	28	30	32	34	35	36	38	40	42
b	16	16	16	16	16	16	16	18	18
d_2	45	45	50	50	56	56	56	63	63
d_3	M 8	M 8	M 8	M 8	M 8	M 8	M 8	M 10	M 10
d_4	6	6	8	8	8	8	8	8	8
A mit Stiften ¹	M 8x12	M 8x10	M 8x12	M 8x12	M 8x12	M 8x12	M 8x12	M 10x16	M 10x16
B für Stifte ²	6x45	6x45	8x50	8x50	8x55	8x55	8x55	8x60	8x60

Maße	45	50	55	60	65	70	75	80	85
b	18	18	18	20	20	20	22	22	22
d_2	70	80	80	90	100	100	110	110	125
d_3	M 10	M 10	M 10	M 10	M 10	M 10	M 12	M 12	M 12
d_4	8	10	10	10	10	10	10	10	12
A mit Stiften ¹	M 10x16	M 10x16	M 10x16	M 10x16	M 10x20	M 10x20	M 12x20	M 12x20	M 12x25
B für Stifte ²	8x70	10x80	10x80	10x90	10x100	10x100	10x100	10x110	12x120

Maße	90	100	110	120	125	130	140		
b	22	25	25	25	28	28	28		
d_2	125	140	160	160	180	180	200		
d_3	M 12	M 12	M 12	M 12	M 16	M 16	M 16		
d_4	12	12	12	12	16	16	16		
A mit Stiften ¹	M 12x20	M 12x25	M 12x30	M 12x25	M 16x35	M 16x35	M 16x35		
B für Stifte ²	12x120	12x140	12x160	12x160	16x180	16x180	16x200		

¹ $d_1 \leq 70$ ein Gewindestift mit Schlitz

² $d_2 \geq 75$ ein Gewindestift mit Innensechskant

Verfügbare Abmessungen auf den folgenden Seiten:

Stahl/Stahl mit Oberfläche: S. 110 | Edelstahl: S. 475



Sonderformen

DIN 443

Verschlussdeckel zum Eindrücken

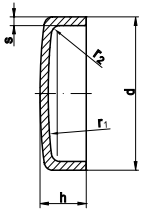

d = Nennmaß

Maße	8	10	12	14	16	18	20	22	25	28
h	3	3	4	5	5	6	6	7	8	9
r ₁	20	25	30	35	40	45	50	55	60	70
r ₂	1	1	1	1	1	1	1	1,6	1,6	1,6
s	0,75	0,75	1	1	1	1	1	1,6	1,6	1,6

Maße	30	32	36	38	40	42	45	50	56
h	9	10	11	12	12	13	14	15	17
r ₁	75	80	90	95	100	105	110	125	140
r ₂	1,6	1,6	1,6	1,6	1,6	1,6	1,6	1,6	2,5
s	1,6	1,6	1,6	1,6	1,6	1,6	1,6	1,6	2

Verfügbare Abmessungen auf den folgenden Seiten:

Stahl/Stahl mit Oberfläche: [S. 85](#)

DIN 470

Verschluss Scheiben

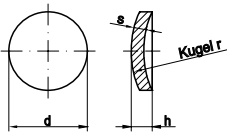

d = Nennmaß

Maße	6	8	10	12	14	16	18	20	22	25
h	1,67	1,94	2,67	2,77	2,94	3,11	3,28	3,45	4,09	4,38
r	7	9	12	16	19	22	25	28	30	34
s	1	1	1,6	1,6	1,6	1,6	1,6	1,6	2	2

Maße	28	30	32	34	36	38	40	42	45	48
h	4,53	4,77	4,95	5,11	5,36	5,6	5,7	5,8	6,15	6,38
r	40	42	45	48	50	52	56	60	63	68
s	2	2	2	2	2	2	2	2	2	2

Maße	50	52	56	60	63	80	100	125
h	6,62	6,66	7,06	7,47	7,7	10,41	12,23	14,2
r	70	75	80	85	90	112	140	180
s	2	2	2	2	2	3	3	3

Verfügbare Abmessungen auf den folgenden Seiten:

Stahl/Stahl mit Oberfläche: [S. 89](#)

DIN 6319

Kugelscheiben

Form C

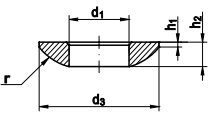

d₁ = Nennmaß

Maße	6,4	8,4	10,5	13	17	21
d ₃	12	17	21	24	30	36
h ₁	0,7	0,6	0,8	1,1	1,3	2
h ₂	2,3	3,2	4	4,6	5,3	6,3
r _{1b}	9	12	15	17	22	27

Maße	25	31	37	43	50
d ₃	44	56	68	78	92
h ₁	2,4	3,6	4,6	6,5	8
h ₂	8,2	11,2	14	17	21
r _{1b}	32	41	50	58	67

Verfügbare Abmessungen auf den folgenden Seiten:

Stahl/Stahl mit Oberfläche: [S. 307](#)



Sonderformen

DIN 6319

Kegelpfannen
Form D

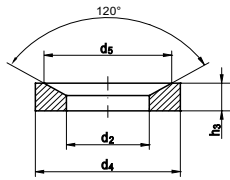

d_2 = Nennmaß

Maße	7,1	9,6	12	14,2	19	23,2
d_4	12	17	21	24	30	36
d_5	11	14,5	18,5	20	26	31
h_3	2,8	3,5	4,2	5	6,2	7,5

Maße	28	35	42	49	56	
d_4	44	56	68	78	92	
d_5	37	49	60	70	82	
h_3	9,5	12	15	18	22	

Verfügbare Abmessungen auf den folgenden Seiten:

Stahl/Stahl mit Oberfläche: [S. 307](#)

DIN 6319

Kegelpfannen
Form G

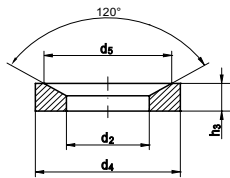

d_2 = Nennmaß

Maße	12	14,2	19	23,2	28	35
d_4	30	36	44	50	60	68
d_5	18,5	20	26	31	37	49
h_3	5	6	7	8	10	12

Verfügbare Abmessungen auf den folgenden Seiten:

Stahl/Stahl mit Oberfläche: [S. 308](#)

Artikel 88102

Fugenscheiben
zur Verwendung mit DIN 603

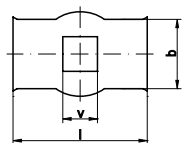

Maße	9	11
b	22	22
l	40	40
v	9	11
für Schrauben	M 8	M 10

Verfügbare Abmessungen auf den folgenden Seiten:

Stahl/Stahl mit Oberfläche: [S. 427](#)



Sonderformen

Artikel 88122

Achsklemmringe
Schnellbefestigungs-Elemente

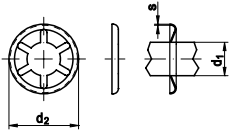

d_1 = Nennmaß

Maße	3	4	5	6	8	10	12
d_2	11	11	11	15	15	18	21
d_3	1,3	1,3	1,3	1,6	1,6	2,1	3
s	0,2	0,2	0,2	0,25	0,25	0,3	0,4
F_a	200 N	400 N	600 N	800 N	1000 N	1100 N	2500 N

Verfügbare Abmessungen auf den folgenden Seiten:

Stahl/Stahl mit Oberfläche: [S. 430](#)

Artikel 88498

KORREX-Isolierhülsen

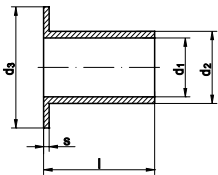

Maße	M 4/10	M 4/15	M 4/20	M 5/10	M 5/15	M 5/20	M 6/10	M 6/15
für Schrauben	M 4	M 4	M 4	M 5	M 5	M 5	M 6	M 6
l	10	15	20	10	15	20	10	15
d_1	4,3	4,3	4,3	5,3	5,3	5,3	6,5	6,5
d_2	5,8	5,8	5,8	6,8	6,8	6,8	8	8
d_3	9,5	9,5	9,5	12	12	12	13	13
s	1	1	1	1	1	1	1	1

Maße	M 6/20	M 8/10	M 8/15	M 8/22	M 10/10	M 10/20	M 10/25	M 12/15
für Schrauben	M 6	M 8	M 8	M 8	M 10	M 10	M 10	M 12
l	20	10	15	22	10	20	25	15
d_1	6,5	8,2	8,2	8,2	10,2	10,2	10,2	12,3
d_2	8	10,4	10,4	10,4	12,5	12,5	12,5	15
d_3	13	18	18	18	21	21	21	24
s	1	1	1	1	1	1	1	1

Maße	M 12/25	M 16/10	M 16/15	M 16/20	M 16/25	M 20/15	M 20/20	M 20/25
für Schrauben	M 12	M 16	M 16	M 16	M 16	M 20	M 20	M 20
l	25	10	15	20	25	15	20	25
d_1	12,3	16,3	16,3	16,3	16,3	20,3	20,3	20,3
d_2	15	19,3	19,3	19,3	19,3	23,3	23,3	23,3
d_3	24	30	30	30	30	36	36	36
s	1	2	2	2	2	2	2	2

Verfügbare Abmessungen auf den folgenden Seiten:

Nichteisen-Werkstoffe: [S. 646](#)

Artikel 88499

KORREX-Rosetten
für Senk- und Linsensenkköpfe

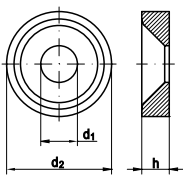

Maße	803	804	805	806	808
d_1	3,1	4,1	5,2	6,3	8,2
d_2	8,1	7,6	11,3	13,4	18
h	2,2	2	2,4	2,6	4
für Schrauben	M 3	M 4	M 5	M 6	M 8

Verfügbare Abmessungen auf den folgenden Seiten:

Nichteisen-Werkstoffe: [S. 647](#)



Sonderformen

Artikel 88965

**Rosettenscheiben,
Auflage offen**
für Senk- und Linsensenkköpfe

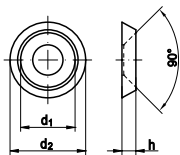

Loch \varnothing = Nennmaße

Maße	3	4,1	5	6	7	8,6
d ₁	7	6,5	9	10	12,5	13
d ₂	9,8	9	12,5	13	18	18
h	2,1	1,8	2,3	2,3	3,2	3
f. Schr. nach DIN 95	3	3,5	4	5	6,0/7,0	6,0/7,0
f. Schr. nach DIN 964	M 3	M 3,5	M 4	M 5	M 6	M 6/M 8
f. Schr. nach DIN 7973	ST 2,9	ST 3,5	ST 3,9/4,2	ST 4,8	ST 5,5	ST 6,3

Verfügbare Abmessungen auf den folgenden Seiten:

Nichteisen-Werkstoffe: [S. 647](#)

Artikel 88966

**Rosettenscheiben,
Auflage geschlossen**
für Senk- und Linsensenkköpfe

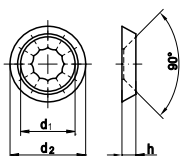

Maße	4,8	5	6	7
d ₁	8,8	8	10,5	12
d ₂	12,7	11	13	15
h	2,7	2,4	3	3,4
f. Schr. nach DIN 95	4	4,5	5	6
f. Schr. nach DIN 964	M 4	M 4	M 5	M 6
f. Schr. nach DIN 7973	ST 4,2	ST 4,2	ST 4,8	ST 5,5

Verfügbare Abmessungen auf den folgenden Seiten:

Nichteisen-Werkstoffe: [S. 647](#)

Artikel 89184

Senkscheiben, Typ B

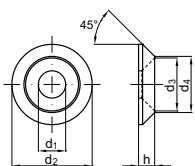

ETA-12/0276
zur Verwendung mit
Holzbauschraube R 89091

Maße	6	8	10
d ₁	8	8,5	11
d ₂	19,5	25	32
d ₃	8,5	16,5	21,5
d ₄	9,5	17,5	22,5
h	4,8	5	6

Verfügbare Abmessungen auf den folgenden Seiten:

Stahl/Stahl mit Oberfläche: [S. 447](#)



Zylinderstifte

ISO 2338

ersetzt DIN 7

Zylinderstifte

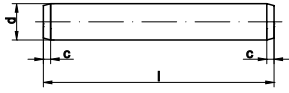

d = Nennmaß
Toleranzfeld m6

Maße	0,8	1	1,5	2	2,5	3	4	5	6
$c_{\max. ISO}$	0,16	0,2	0,3	0,35	0,4	0,5	0,63	0,8	1,2
$c_{\max. DIN}$	0,12	0,15	0,23	0,3	0,4	0,45	0,6	0,75	0,9
r	0,8	1	1,6	2	2,5	3	4	5	6

Maße	8	10	12	13	14	16	20	25	30
$c_{\max. ISO}$	1,6	2	2,5	-	-	3	3,5	4	5
$c_{\max. DIN}$	1,2	1,5	1,8	1,9	2	2,5	3	4	4,5
r	8	10	12	14	16	16	20	25	32

Verfügbare Abmessungen auf den folgenden Seiten:

Stahl/Stahl mit Oberfläche: [S. 229](#), [S. 453](#) | Edelstahl: [S. 525](#), [S. 453](#)

ISO 8734

ersetzt DIN 6325

Zylinderstifte

Form A = durchgehärtet



ISO 8734

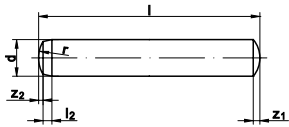

DIN 6325

d = Nennmaß

Maße	1	1,5	2	2,5	3	4	5
l_2	0,4	0,5	0,6	0,7	0,8	1	1,2
r	1	1,5	2	2,5	3	4	5
z_1	0,15	0,23	0,3	0,4	0,45	0,6	0,75
z_2	0,08	0,12	0,18	0,25	0,3	0,4	0,5
c	0,2	0,3	0,35	0,4	0,5	0,63	0,98

Maße	6	8	10	12	14	16	20
l_2	1,5	1,8	2	2,5	2,5	3	4
r	6	8	10	12	16	16	20
z_1	0,9	1,2	1,5	1,8	2	2,5	3
z_2	0,6	0,8	1	1,3	1,3	1,7	2
c	1,2	1,6	2	2,5	-	3	3,5

Verfügbare Abmessungen auf den folgenden Seiten:

Stahl/Stahl mit Oberfläche: [S. 374](#), [S. 308](#)

DIN 7979

Zylinderstifte mit Innengewinde

Form D = gehärtet

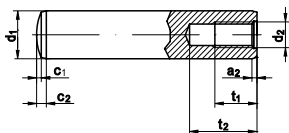

d = Nennmaß
Toleranzfeld m6

*Abmessungen nicht genormt, Richtwerte

Maße	4*	5*	6	8	10	12
a_2	0,5	0,6	0,8	1	1,2	1,6
c_1	0,4	0,5	0,6	0,8	1	1,2
c_2	1,3	1,7	2,1	2,6	3	3,8
d_2	(M 2)	(M 3)	M 4	M 5	M 6	M 6
t_1	6	6	6	8	10	10
$t_2 \min.$	7	7	10	12	16	16

Maße	14	16	20	25	30	40
a_2	1,8	2	2,5	3	4	5
c_1	1,4	1,6	2	2,5	3	4
c_2	4	4,7	6	6	7	8
d_2	M 8	M 8	M 10	M 16	M 20	M 20
t_1	12	12	16	24	30	30
$t_2 \min.$	20	20	25	34	42	42

Verfügbare Abmessungen auf den folgenden Seiten:

Stahl/Stahl mit Oberfläche: [S. 356](#)



Kegelstifte

ISO 2339

ersetzt DIN 1

Kegelstifte

Form B = gedreht

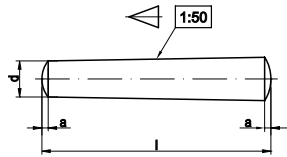

ISO 2339

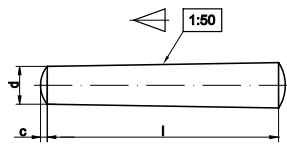

DIN 1

*Abmessung nicht genormt, Richtwerte

Maße	1	1,5	2	2,5	3	4
a_{ISO}	0,12	0,2	0,25	0,3	0,4	0,5
$c_{max. DIN}$	0,15	0,23	0,3	0,4	0,45	0,6

Maße	5	6	6,5*	7*	8	10
a_{ISO}	0,63	0,8	0,8	0,9	1	1,2
$c_{max. DIN}$	0,75	0,9	1	1,1	1,2	1,5

Maße	12	13*	14	16	20
a_{ISO}	1,6	1,7	1,8	2	2,5
$c_{max. DIN}$	1,8	1,9	2	2,5	3

Verfügbare Abmessungen auf den folgenden Seiten:

Stahl/Stahl mit Oberfläche: [S. 230](#), [S. 63](#) | Edelstahl: [S. 527](#), [S. 453](#)

ISO 8737

entspricht DIN 7977

Kegelstifte mit Gewindezapfen und konstanten Zapfenlängen

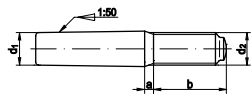

d_1 = Nennmaß

*Abmessung nicht genormt, Richtwerte

Maße	5	6	8	10	12
b	14	18	22	24	27
$a_{max.}$	2,4	3	4	4,5	5,3
d_2	M 5	M 6	M 8	M 10	M 12

Maße	13*	14	16	20
b	27	30	35	35
$a_{max.}$	5,3	6	6	6
d_2	M 13	M 12	M 16	M 16

Verfügbare Abmessungen auf den folgenden Seiten:

Stahl/Stahl mit Oberfläche: [S. 376](#), [S. 355*](#)

DIN 258

Kegelstifte mit Gewindezapfen und konstanten Kegellängen

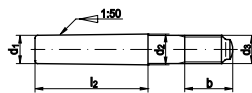

d_1 = Nennmaß

Maße	5	6	8	10
$b_{min.}$	14	18	22	24
d_2	5,5	6,6	8,8	10,9
d_3	M 5	M 6	M 8	M 10
l_2	25	30	40	45

Maße	12	16	20	25
$b_{min.}$	27	35	35	40
d_2	13,1	17,4	21,7	27
d_3	M 12	M 16	M 20	M 25
l_2	55	72	85	100

Verfügbare Abmessungen auf den folgenden Seiten:

Stahl/Stahl mit Oberfläche: [S. 77](#)



Kegelstifte

ISO 8736

entspricht DIN 7978

Kegelstifte mit Innengewinde

Typ A = geschliffen

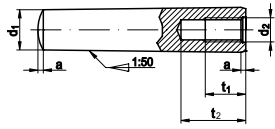

d = Nennmaß

Maße	6	8	10
a	0,8	1	1,2
d ₂	M 4	M 5	M 6
t ₁	6	8	10
t _{2 min.}	10	12	16

Maße	12	16	20
a	1,6	2	2,5
d ₂	M 8	M 10	M 12
t ₁	12	16	18
t _{2 min.}	20	25	27

Verfügbare Abmessungen auf den folgenden Seiten:

Stahl/Stahl mit Oberfläche: [S. 376](#), [S. 355](#)

Kerbstifte

ISO 8744

ersetzt DIN 1471

Kegelkerbstifte



¹∅ ist abhängig von der Länge

²zweischrittige Mindestkraft in kN

Maße	1,5	2	2,5	3	4
d ₂ ¹	1,60 – 1,63	2,10 – 2,15	2,60 – 2,70	3,20 – 3,30	4,15 – 4,30
c	0,2	0,25	0,3	0,4	0,5
Abscherkraft ISO	1,6	2,84	4,4	6,4	11,3
Abscherkraft ² DIN	1,6	2,85	4,25	6,15	10,6

Maße	5	6	8	10	12
d ₂ ¹	5,15 – 5,30	6,15 – 6,35	8,20 – 8,40	10,20 – 10,45	12,25 – 12,50
c	0,63	0,85	1	1,2	1,6
Abscherkraft ISO	17,6	25,4	45,2	70,4	101,8
Abscherkraft ² DIN	16,5	22,8	40,5	63,2	91

Verfügbare Abmessungen auf den folgenden Seiten:

Stahl/Stahl mit Oberfläche: [S. 378](#), [S. 210](#) | Edelstahl: [S. 583](#), [S. 517](#)

ISO 8742

ersetzt DIN 1475

Knebelkerbstifte mit kurzen Kerben

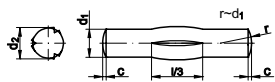

¹∅ ist abhängig von der Länge

²zweischrittige Mindestkraft in kN

Maße	1,5	2	2,5	3	4
d ₂ ¹	1,60 – 1,63	2,10 – 2,15	2,60 – 2,70	3,20 – 3,30	4,15 – 4,30
c	0,2	0,25	0,3	0,4	0,5
Abscherkraft ISO	1,6	2,84	4,4	6,4	11,3
Abscherkraft ² DIN	1,6	2,85	4,25	6,15	10,6

Maße	5	6	8	10	12
d ₂ ¹	5,15 – 5,30	6,15 – 6,35	8,20 – 8,40	10,20 – 10,45	12,25 – 12,50
c	0,63	0,85	1	1,2	1,6
Abscherkraft ISO	17,6	25,4	45,2	70,4	101,8
Abscherkraft ² DIN	16,5	22,8	40,5	63,2	91

Verfügbare Abmessungen auf den folgenden Seiten:

Stahl/Stahl mit Oberfläche: [S. 378](#), [S. 212](#) | Edelstahl: [S. 517](#)



Kerbstifte

ISO 8740

ersetzt DIN 1473

Zylinderkerbstifte mit Fäse

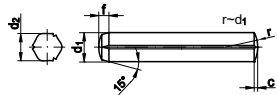

¹∅ ist abhängig von der Länge

²zweischrittige Mindestkraft in kN

Maße	1,5	2	2,5	3	4
d_2^1	1,60 – 1,63	2,10 – 2,15	2,60 – 2,70	3,20 – 3,30	4,15 – 4,30
c	0,2	0,25	0,3	0,4	0,5
Abscherkraft ISO	1,6	2,84	4,4	6,4	11,3
Abscherkraft ² DIN	1,6	2,85	4,25	6,15	10,6

Maße	5	6	8	10	12
d_2^1	5,15 – 5,30	6,15 – 6,35	8,20 – 8,40	10,20 – 10,45	12,25 – 12,50
c	0,63	0,85	1	1,2	1,6
Abscherkraft ISO	17,6	25,4	45,2	70,4	101,8
Abscherkraft ² DIN	16,5	22,8	40,5	63,2	91

Verfügbare Abmessungen auf den folgenden Seiten:

Stahl/Stahl mit Oberfläche: [S. 377, S. 211](#) | Edelstahl: [S. 583, S. 517](#)

ISO 8741

ersetzt DIN 1474

Steckerkerbstifte

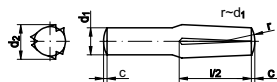

¹∅ ist abhängig von der Länge

²zweischrittige Mindestkraft in kN

Maße	1,5	2	2,5	3	4
d_2^1	1,60 – 1,63	2,10 – 2,15	2,60 – 2,70	3,20 – 3,30	4,15 – 4,30
c	0,2	0,25	0,3	0,4	0,5
Abscherkraft ISO	1,6	2,84	4,4	6,4	11,3
Abscherkraft ² DIN	1,6	2,85	4,25	6,15	10,6

Maße	5	6	8	10	12
d_2^1	5,15 – 5,30	6,15 – 6,35	8,20 – 8,40	10,20 – 10,45	12,25 – 12,50
c	0,63	0,85	1	1,2	1,6
Abscherkraft ISO	17,6	25,4	45,2	70,4	101,8
Abscherkraft ² DIN	16,5	22,8	40,5	63,2	91

Verfügbare Abmessungen auf den folgenden Seiten:

Stahl/Stahl mit Oberfläche: [S. 378, S. 212](#)

ISO 8745

ersetzt DIN 1472

Passkerbstifte



¹∅ ist abhängig von der Länge

²zweischrittige Mindestkraft in kN

Maße	1,5	2	2,5	3	4
d_2^1	1,60 – 1,63	2,10 – 2,15	2,60 – 2,70	3,20 – 3,30	4,15 – 4,30
c	0,2	0,25	0,3	0,4	0,5
Abscherkraft ISO	1,6	2,84	4,4	6,4	11,3
Abscherkraft ² DIN	1,6	2,85	4,25	6,15	10,6

Maße	5	6	8	10	12
d_2^1	5,15 – 5,30	6,15 – 6,35	8,20 – 8,40	10,20 – 10,45	12,25 – 12,50
c	0,63	0,85	1	1,2	1,6
Abscherkraft ISO	17,6	25,4	45,2	70,4	101,8
Abscherkraft ² DIN	16,5	22,8	40,5	63,2	91

Verfügbare Abmessungen auf den folgenden Seiten:

Stahl/Stahl mit Oberfläche: [S. 379, S. 211](#) | Edelstahl: [S. 584, S. 517](#)



Kerbstifte

ISO 8746

entspricht DIN 1476

Halbrundkerbnägel

Form A = mit Fase

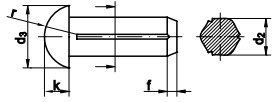

Maße	1,4	1,6	2	2,3	2,5
d ₂	1,5	1,7	2,15	2,5	2,7
d ₃	2,4	2,8	3,5	4,0	4,4
k	0,8	1	1,2	1,4	1,5
r	1,4	1,6	1,9	2,1	2,4
f	0,5	0,5	0,5	0,7	0,7

Maße	3	4	5	6	
d ₂	3,2	4,25	5,25	6,3	
d ₃	5,2	7	8,8	10,5	
k	1,8	2,4	3	3,6	
r	2,8	3,8	4,6	5,7	
f	4	1,5	1,5	2	

*Abmessung nicht genormt, Richtwerte

Verfügbare Abmessungen auf den folgenden Seiten:

Stahl/Stahl mit Oberfläche: [S. 380](#), [S. 213](#) | Edelstahl: [S. 584](#), [S. 518](#) | Nichteisen-Werkstoffe: [S. 643](#), [S. 632](#)

ISO 8747

entspricht DIN 1477

Senkkerbnägel

Form A = mit Fase

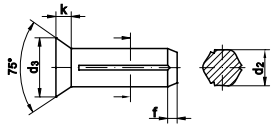

Maße	2	3	4	5	6
d ₂	2,15	3,20	4,25	5,25	6,30
d ₃	3,5	5,2	7	8,8	10,5
k	1	1,4	2	2,5	3
f	0,5	1	1,15	1,15	2

Verfügbare Abmessungen auf den folgenden Seiten:

Stahl/Stahl mit Oberfläche: [S. 380](#), [S. 213](#)

Einspannbuchsen

DIN 1498

Einspannbuchsen

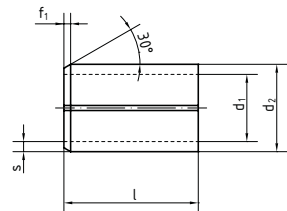

Maße	16	20	25	25	25	28
d ₂	20	26	32	32	32	35
l	20	20	20	28	30	25
s	2	3	3,5	3,5	3,5	3,5
f ₁	1,5	2	2	2	2	2

Maße	30	40	40	40	50	
d ₂	38	50	50	50	60	
l	25	25	30	40	50	
s	4	5	5	5	5	
f ₁	2	2,5	2,5	2,5	2,5	

Verfügbare Abmessungen auf den folgenden Seiten:

Stahl/Stahl mit Oberfläche: [S. 220](#)



Spannhülsen/Spannstifte

ISO 8752

ersetzt DIN 1481

Spannstifte (-hülsen)

geschlitzt, schwere Ausführung

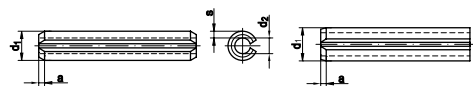

Maße	1	1,5	2	2,5	3	3,5	4	4,5	5
$a_{ISO \min.}$	0,15	0,25	0,35	0,4	0,5	0,6	0,65	0,8	0,9
$d_{1 \max.}^1$	1,3	1,8	2,4	2,9	3,5	4	4,6	5,1	5,6
d_2^1	0,8	1,1	1,5	1,8	2,1	2,3	2,8	2,9	3,4
s	0,2	0,3	0,4	0,5	0,6	0,75	0,8	1	1
Abscherkraft ²	0,7	1,58	2,82	4,38	6,32	9,06	11,24	15,36	17,54

Maße	6	7*	8	9*	10	12	13	14	16
$a_{ISO \min.}$	1,2	1,8	2	2	2	2	2	2	2
$d_{1 \max.}^1$	6,7	7,8	8,8	9,5	10,8	12,8	13,8	14,8	16,8
d_2^1	3,9	4	5,5	6	6,5	7,5	8,5	8,5	10,5
s	1,25	1,5	1,5	2	2	2,5	2,5	3	3
Abscherkraft ²	26,04	-	42,76	-	70,16	104,1	115,12	144,7	171

Maße	18	20	21	25	28	30	35	40
$a_{ISO \min.}$	2	3	3	3	3	3	3	4
$d_{1 \max.}^1$	18,9	20,9	21,9	25,9	28,9	30,9	35,9	40,9
d_2^1	11,5	12,5	13,5	15,5	17,5	18,5	21,5	25,5
s	3,5	4	4	5	5,5	6	7	7,5
Abscherkraft ²	222,5	280,6	298,2	438,5	542,6	631,4	859	1068

¹Maße vor dem Einbau

²zweischnittig in kN, nur für Federstahl

*Abmessung nicht genormt, Richtwerte

Verfügbare Abmessungen auf den folgenden Seiten:

Stahl/Stahl mit Oberfläche: [S. 381](#), [S. 217](#) | Edelstahl: [S. 585](#), [S. 519](#)

ISO 8750

entspricht DIN 7343

Spiralspannstifte

Regelausführung

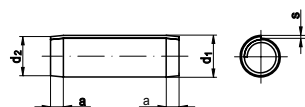

Maße	1	1,5	2	2,5	3	3,5	4
a	0,3	0,5	0,7	0,8	1	1,2	1,3
s	0,08	0,13	0,17	0,21	0,25	0,29	0,33
d_1^1	1,1	1,62	2,15	2,65	3,15	3,67	4,2
d_2^1	0,95	1,4	1,9	2,35	2,85	3,35	3,8
Abscherkraft ²	0,6	1,45	2,5	3,9	5,5	7,5	9,6

Maße	5	6	8	10	12	14	16
a	1,7	2	3	3	4	4,5	5
s	0,42	0,5	0,67	0,84	1	1,2	1,3
d_1^1	5,25	6,25	8,35	10,45	12,5	14,55	16,55
d_2^1	4,8	5,8	7,75	9,6	11,5	13,5	15,4
Abscherkraft ²	15	22	39	62	89	120	155

¹Maße vor dem Einbau

²zweischnittig kN, nur für Federstahl

Verfügbare Abmessungen auf den folgenden Seiten:

Stahl/Stahl mit Oberfläche: [S. 381](#), [S. 339](#) | Edelstahl: [S. 584](#), [S. 571](#)

ISO 8748

entspricht DIN 7344

Spiralspannstifte

schwere Ausführung

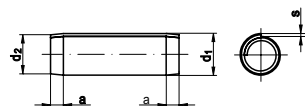

Maße	1,5	2	2,5	3
a	0,5	0,7	0,8	1
s	0,17	0,22	0,28	0,33
d_1^1	1,6	2,1	2,6	3,12
d_2^1	1,4	1,9	2,35	2,85
Abscherkraft ²	1,9	3,5	5,5	7,6

Maße	4	5	6	8*
a	1,3	1,7	2	2
s	0,45	0,56	0,67	0,9
d_1^1	4,15	5,15	6,25	8,25
d_2^1	3,8	4,8	5,8	7,8
Abscherkraft ²	13,5	20	30	53

¹Maße vor dem Einbau

²zweischnittig in kN, nur für Federstahl

*Abmessung nicht genormt, Richtwerte

Verfügbare Abmessungen auf den folgenden Seiten:

Stahl/Stahl mit Oberfläche: [S. 380](#), [S. 339](#)



Spannhülsen/Spannstifte

ISO 13337

entspricht DIN 7346

Spannstifte (-hülsen)

geschlitzt, leichte Ausführung

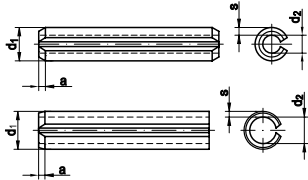

¹Maße vor dem Einbau

²zweischnittig kN, nur für Federstahl

Maße	2	2,5	3	4	5	6
a	0,2	0,25	0,25	0,5	0,5	0,7
d ₁ ¹	2,3	2,8	3,3	4,4	5,4	6,4
d ₂ ¹	1,9	2,3	2,7	3,4	4,4	4,9
s	0,2	0,25	0,3	0,5	0,5	0,75
Abscherkraft ²	1,5	2,4	3,5	8	10,4	18

Maße	8	10	12	13	16	21
a	1,5	2	2	2	2	2
d ₁ ¹	8,5	10,5	12,5	13,5	16,5	21,5
d ₂ ¹	7	8,5	10,5	11	13,5	17,5
s	0,75	1	1	1,25	1,5	2
Abscherkraft ²	24	40	48	66	98	168

Verfügbare Abmessungen auf den folgenden Seiten:

Stahl/Stahl mit Oberfläche: [S. 396](#), [S. 340](#)

Klappstecker/Federstecker/Splinte

ISO 1234

entspricht DIN 94

Splinte

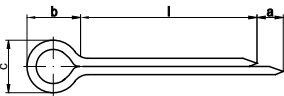

Maße	1	1,2	1,6	2	2,5	3,2	4
a _{min.}	0,8	1,25	1,25	1,25	1,25	1,6	2
b	3	3	3,2	4	5	6,4	8
c _{max.}	1,8	2	2,8	3,6	4,6	5,8	7,4
Splintloch Ø	1	1,2	1,6	2	2,5	3,2	4
für Schrauben Ø	3,5 - 4,5	4,5 - 5,5	5,5 - 7	7 - 9	9 - 11	11 - 14	14 - 20
für Bolzen Ø	3 - 4	4 - 5	5 - 6	6 - 8	8 - 9	9 - 12	12 - 17

Maße	5	5,5*	6,3	8	10	13	16
a _{min.}	2	2	2	2	3,2	3,2	3,2
b	10	12,6	12,6	16	20	26	32
c _{max.}	9,2	11	11,8	15	19	24,8	30,8
Splintloch Ø	5	5,5	6,3	8	10	13	16
für Schrauben Ø	20 - 27	21 - 27	27 - 39	39 - 56	56 - 80	80 - 120	120 - 170
für Bolzen Ø	17 - 23	18 - 23	23 - 29	29 - 44	44 - 69	69 - 110	110 - 160

*Abmessung nicht genormt, Richtwerte

Verfügbare Abmessungen auf den folgenden Seiten:

Stahl/Stahl mit Oberfläche: [S. 208](#), [S. 69](#) | Edelstahl: [S. 516](#), [S. 458](#) | Nichteisen-Werkstoffe: [S. 632](#), [S. 613](#)

ISO 2341

entspricht DIN 1444 B

Bolzen mit Kopf

Form B = mit Splintloch

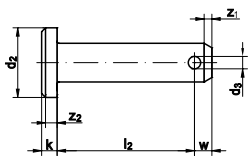

Bolzen Ø mit Toleranzfeld h11

Maße	8	10	12	16	18	20
d ₂	14	18	20	25	28	30
d ₃	2	3,2	3,2	4	5	5
k	3	4	4	4,5	5	5
w	3,5	4,5	5,5	6	7	8
z _{1 max.}	2	2	3	3	3	4
z ₂	1	1	1,6	1,6	1,6	2
für Splint Ø	2	3,2	3,2	4	5	5

Verfügbare Abmessungen auf den folgenden Seiten:

Stahl/Stahl mit Oberfläche: [S. 210](#)



Klappstecker/Federstecker/Splinte

DIN 11023

Klappstecker ("Klappsplinte")

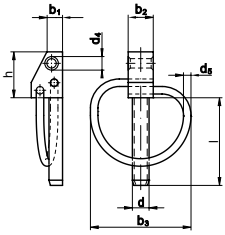

Maße	5	6	8	10
l	32	42	42	45
b _{1 max.}	11,5	14	15	15
b _{2 max.}	7	8	9	12
b _{3 max.}	36	52	52	52
h _{max.}	18	22	22	22
d ₄	3,5	4	4	4,5
d _{5 min.}	2,5	3,6	3,6	3,6
für Wellen Ø _{max.}	25	32	32	32
für Bohrung Ø	5	6	8	10
Bohrungslage*	8	10	12	14

Maße	12	12	17	
l	45	55	60	
b _{1 max.}	15	15	21	
b _{2 max.}	14	14	20	
b _{3 max.}	52	60	60	
h _{max.}	22	22	29	
d ₄	4,5	4,5	6	
d _{5 min.}	3,6	4	4	
für Wellen Ø _{max.}	32	45	45	
für Bohrung Ø	12	12	17	
Bohrungslage*	18	18	21	

*Angabe: Wellenende bis Bohrungsmittelpunkt
Auch als Ausführung ~ DIN 11023
ohne Kettenbohrung verfügbar

Verfügbare Abmessungen auf den folgenden Seiten:

Stahl/Stahl mit Oberfläche: [S. 394](#)

DIN 11024

Federstecker

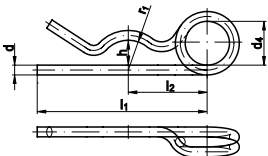

Maße	2,5	3,2	4	5	6,3	7	8
d ₃	2,25	2,8	3,6	4,5	5,6	6,3	7
d ₄	20	20	20	25	25	30	30
l ₁	42	48	64	80	97	125	150
l ₂	24	26	32	39	45	56	63
h	2,5	3	4,5	7	9	12,5	17,5
r ₁	5,6	7	10	13	17	22,5	28
für Wellen Ø	9 - 11,2	11,2 - 14	14 - 20	20 - 26	26 - 34	34 - 45	45 - 56

Nennmaß = Bohrungs Ø
Auch als Ausführung mit
einfacher Windung ~ DIN 11024 verfügbar

Verfügbare Abmessungen auf den folgenden Seiten:

Stahl/Stahl mit Oberfläche: [S. 395](#) | Edelstahl: [S. 589](#)

Artikel 88023

Rohrklappstecker

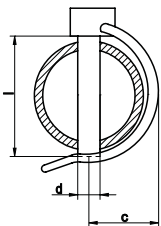

Maße	6	8	8
c	22	22	25
l	40	40	50

Maße	10	10	
c	25	32	
l	50	60	

d = Nennmaß

Verfügbare Abmessungen auf den folgenden Seiten:

Stahl/Stahl mit Oberfläche: [S. 394](#)



Clappstecker/Federstecker/Splinte

DIN 71752

Gabelgelenke

Form G = Gabelköpfe

passende Federklappbolzen → Artikel 88752

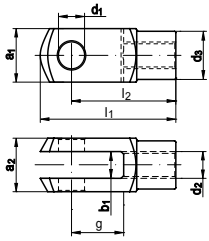

Nennmaß = Bohrung \varnothing

*Abmessung nicht genormt, Richtwerte

Maße	6	8	10	12	16	20*
g	12/24	16/32	20/40	24/48	32/64	40
a ₁	12	16	20	24	32	40
a ₂	12	16	20	24	32	40
b ₁	6	8	10	12	16	20
d ₂	M 6	M 8	M 10	M 12	M 16	M 20
d ₃	10	14	18	20	26	34
l ₁	31/43	42/58	52/72	62/86	72/101	105
l ₂	24/36	32/48	40/60	48/72	64/96	80

Verfügbare Abmessungen auf den folgenden Seiten:

Stahl/Stahl mit Oberfläche: [S. 409](#)

Artikel 88752

Federklapp-Bolzen ("ES-Bolzen")

für Gabelköpfe → DIN 71752

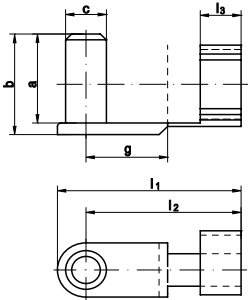

c x g = Nennmaß

Maße	6x12	6x24	8x16	8x32	10x20	10x40
c	6	6	8	8	10	10
a	14	14	19	19	23	23
b	16	16	21,5	21,5	26	26
l ₁	28	40	37	52	45	65
l ₂	23	35	30	46	38	58
l ₃	6,5	6,5	8	8	10	10

Maße	12x24	12x48	16x32	16x64	20x40	
c	12	12	16	16	20	
a	28	28	34	34	44	
b	31	31	38	38	47	
l ₁	53	78	73	103	98	
l ₂	45	69	62	92	81	
l ₃	12	12	16	16	19	

Verfügbare Abmessungen auf den folgenden Seiten:

Stahl/Stahl mit Oberfläche: [S. 410](#)



Griffe

DIN 98

Drehbare Ballengriffe

Form E = mit Gewindezapfen und Innensechskant

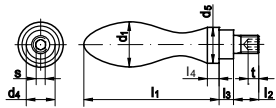

Maße	M 6	M 8	M 10	M 12	M 16
d ₁	16	20	25	32	36
d ₄	10	13	16	20	22
d ₅	14	18	21	26	29
l ₁	49	61	75	96	106
l ₂	11	13	14	21	26
l ₃	5,5	6	8	10,5	11
l ₄	5	6	6,5	8	9
s	3	4	5	6	8
t	3,5	5	6	8	10

Verfügbare Abmessungen auf den folgenden Seiten:

Stahl/Stahl mit Oberfläche: [S. 70](#)

DIN 99

Kegelgriffe mit Griffaufnahme durch Gewinde

Form N = geneigte Griffachse

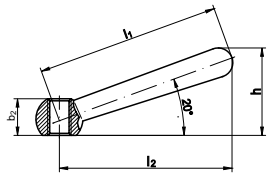

Maße	M 6	M 8	M 10	M 12	M 16	M 20	M 24
l ₁	50	63	80	100	125	160	200
b ₂	9,5	12,5	15	19	25	31	4
h	24	30,5	38	47	59,5	75,7	97
l ₂	38	60	76	95	119	152	190
l ₂	48	60	76	95	119	152	190

Verfügbare Abmessungen auf den folgenden Seiten:

Stahl/Stahl mit Oberfläche: [S. 70](#) | Edelstahl: [S. 460](#)

DIN 319

Kugelknöpfe

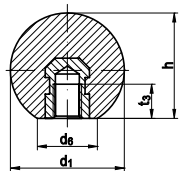
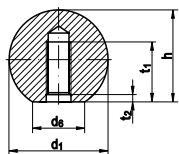

Form C = mit Gewinde

Form E = mit Gewindebuchse

Maße	M 4	M 5	M 6	M 8	M 10	M 12
d ₁	16	20	25	32	40	50
d ₆	8	12	15	18	22	28
t ₃	6	7,5	9	12	15	18
h	15	18	22,5	29	37	46
t ₁	6	7,5	9	12	15	18
t ₂	1,2	1,6	2,0	2,5	3	3

Verfügbare Abmessungen auf den folgenden Seiten:

Nichteisen-Werkstoffe: [S. 618](#)



Griffe

DIN 6335

Kreuzgriffe

Form D = mit durchgehender Gewindebohrung

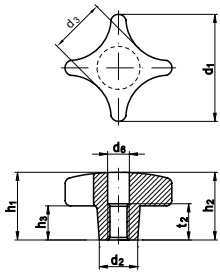

Maße	M 6	M 8	M 10	M 12	M 16	M 20
d ₁	32	40	50	63	80	100
d ₂	12	14	18	20	25	32
d ₃	18	21	25	32	40	48
d ₆	6,4	8,4	10,5	13	17	21
h ₁	21	26	34	42	52	65
h ₃	10	14	20	25	30	38
t ₂	10	13	16	20	20	25

Verfügbare Abmessungen auf den folgenden Seiten:

Stahl/Stahl mit Oberfläche: [S. 310](#)

DIN 6335

Kreuzgriffe

Form K = mit eingefügter Gewindebuchse

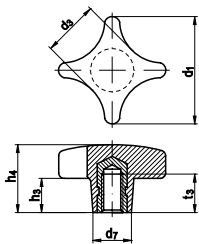

Maße	M 5	M 6	M 8	M 10	M 12	M 16	M 20*
d ₁	25	32	40	50	63	80	100
d ₃	15	18	21	25	32	40	50
d ₇	12	14	18	22	26	35	34
h ₃	8	10	13	20	25	30	38
h ₄	16	20	25	32	40	50	65
t _{3 min.}	9,5	12	14	18	22	30	30

*Abmessung nicht genormt, Richtwerte

Verfügbare Abmessungen auf den folgenden Seiten:

Nichteisen-Werkstoffe: [S. 639](#)

DIN 6336

Sterngriffe

Form D = mit durchgehender Gewindebohrung

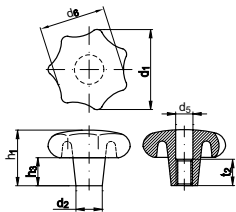

Maße	M 6	M 8	M 8*	M 10	M 10*	M 12	M 12*	M 16
d ₁	32	40	50	50	63	63	80	80
d ₂	12	14	18	18	20	20	25	25
d ₅	6,4	8,4	8,4	10,5	10,5	13	13	17
d ₆	26	34	42	42	52	52	64	64
h ₁	21	26	32	34	40	42	50	52
h ₃	10	13	18	17	20	21	25	25
t ₂	10	13	16	16	20	20	20	20

*Abmessung nicht genormt, Richtwerte

Verfügbare Abmessungen auf den folgenden Seiten:

Stahl/Stahl mit Oberfläche: [S. 310](#)



Griffe

DIN 6336

Sterngriffe

Form K = mit Gewindebuchse

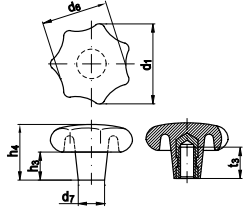

Maße	M 4	M 5	M 6	M 6*	M 8	M 8*
d ₁	20	25	32	40	40	50
d ₆	16	20	26	34	34	42
d ₇	10	12	14	18	18	21
h ₃	7	8	10	13	13	17
h ₄	13	16	20	25	25	32
t _{3 min.}	6,5	9,5	12	16	14	18

Maße	M 10	M 10*	M 12	M 12*	M 16	
d ₁	50	63	63	80	80	
d ₆	42	52	52	64	64	
d ₇	22	26	26	36	35	
h ₃	17	21	21	25	25	
h ₄	32	40	40	48	50	
t _{3 min.}	18	25	22	27	30	

*Abmessung nicht genormt, Richtwerte

Verfügbare Abmessungen auf den folgenden Seiten:

Nichteisen-Werkstoffe: [S. 639](#)

Knebelschrauben/Knebelmuttern

DIN 6304

Knebelschrauben mit festem Knebel

Form E = ohne Druckstück

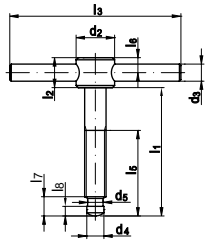

Maße	M 6	M 8	M 10	M 12	M 16	M 20
l ₁	40/50	50/60	60/70	70/80	75/90/100	75/90/100
d ₂	12	14	18	20	24	30
d ₃	5	6	8	10	12	16
d ₄	4,5	6	8	8	12	15,5
d ₅	4	5,4	7,2	7,2	11	14,4
l ₂	10	12	14	18	20	28
l ₃	50	60	80	100	120	140
l ₅	30/40	35/45	40/50	50/60	55/70/90	55/70/90
l ₆	5	5	7	9	10	14
l ₇	6	7,5	9	10	12	14
l ₈	2,5	3	4,5	4,5	5	5,5

Druckstücke → DIN 6311

Verfügbare Abmessungen auf den folgenden Seiten:

Stahl/Stahl mit Oberfläche: [S. 306](#)

DIN 6305

Knebelmuttern mit festem Knebel

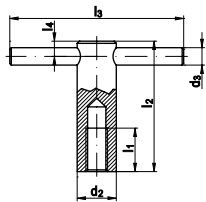

Maße	M 10	M 12	M 16	M 20
d ₂	18	20	24	30
d ₃	8	10	12	16
l ₁	25	25	35	40
l ₂	60	70	85	95
l ₃	80	100	120	140
l ₄	7	9	11	14

Verfügbare Abmessungen auf den folgenden Seiten:

Stahl/Stahl mit Oberfläche: [S. 307](#)



Knebelschrauben/Knebelmuttern

DIN 6307

Knebelmuttern mit losem Knebel

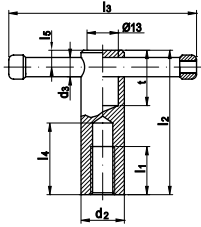

Maße	M 10	M 12	M 16	M 20
d ₂	18	20	24	30
d ₃	8	10	12	16
l ₁	25	25	35	40
l ₂	60	70	85	95
l ₃	80	100	120	140
l ₄	30	35	45	50
l ₅	7	9	11	14
t	23	26	28	34

Verfügbare Abmessungen auf den folgenden Seiten:

Stahl/Stahl mit Oberfläche: [S. 307](#)

DIN 6306

Knebelschrauben mit losem Knebel

Form D = ohne Druckstück

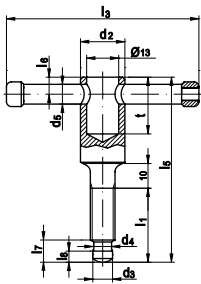

Maße	M 10	M 12	M 16	M 20
l ₁	40/50	50/60	55/70/90	55/70/90
d ₂	18	20	24	30
d ₃	8	8	12	15,5
d ₄	7,2	7,2	11	14,4
d ₅	8	10	13	16
l ₃	80	100	120	140
l ₅	72/82	85/95	95/110/130	100/115/135
l ₆	7	9	10	14
l ₇	9	10	12	14
l ₈	4,5	4,5	5	5,5
t	23	26	28	34

Druckstücke → DIN 6311

Verfügbare Abmessungen auf den folgenden Seiten:

Stahl/Stahl mit Oberfläche: [S. 307](#)

DIN 6311

Druckstücke

Form S = mit Sprengring

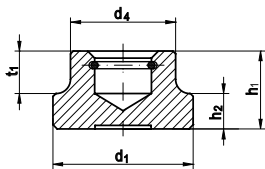

Maße	12	16	20
b	0,7	1	1
d ₄	10	12	15
h ₁	7	9	11
h ₂	2,5	4	5
t ₁	4	5	6
Drahtsprengring ¹	5,1 x 0,6 x 2,5	7,0 x 0,8 x 2,5	8 ¹
Gewindestift ²	M 6	M 8	M 10

Maße	25	32	40
b	1	1,2	1,8
d ₄	18	22	28
h ₁	13	15	16
h ₂	6	7	9
t ₁	7	7,5	8
Drahtsprengring ¹	8	12 ¹	16
Gewindestift ²	M 12	M 16	M 20

¹Runddraht-Sprengring nach DIN 7993

²für Gewindestifte nach DIN 6332

Verfügbare Abmessungen auf den folgenden Seiten:

Stahl/Stahl mit Oberfläche: [S. 307](#)



Knebelschrauben/Knebelmuttern

DIN 6332

Gewindestifte mit Druckzapfen
Form IS = mit Innensechskant

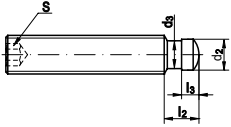

Druckstücke → DIN 6311

Maße	M 6	M 8	M 10	M 12	M 16	M 20
s	3	4	5	6	8	10
d ₂	4,5	6	8	8	12	15,5
d ₃	4	5,4	7,2	7,2	11	14,4
l ₂	6	7,5	9	10	12	14
l ₃	2,5	3	4,5	4,5	5	5,5

Verfügbare Abmessungen auf den folgenden Seiten:

Stahl/Stahl mit Oberfläche: [S. 310](#)

DIN 28129

Bügelmuttern

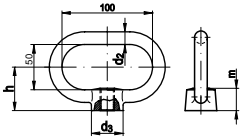

für Druckbehälterbau nach AD-Regelwerk,
TÜV-anerkannte Fabrikate

Maße	M 16	M 20	M 24	M 27
d ₂	14	16	18	20
d ₃	35	40	45	50
h	48	50	55	58
m	25	28	32	35

Verfügbare Abmessungen auf den folgenden Seiten:

Stahl/Stahl mit Oberfläche: [S. 408](#)

DIN 80701

Knebelmuttern

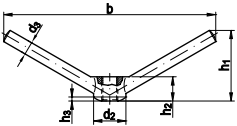

Maße	M 16	M 20	M 24
b	200	240	280
d ₂	30	40	50
d ₃	12	16	20
h ₁	65	75	90
h ₂	20	25	32
h ₃	4	5	5

Verfügbare Abmessungen auf den folgenden Seiten:

Nichteisen-Werkstoffe: [S. 644](#)

DIN 80704

Korbmuttern

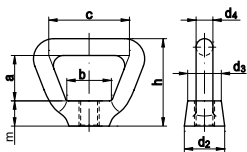

Maße	M 6*	M 8*	M 10*	M 12	M 16	M 20	M 22*	M 24
a	15	20	25	27	29	32	32	36
b	14	18	23	27	32	36	36	45
c	25	32	42	48	56	64	64	75
d ₂	14	18	23	24	30	36	36	45
d ₃	11,5	15	18	20	24	28	28	36
d ₄	5	6,5	8	10	12	13	13	14
h	28	36	50	52	59	66	66	75
m	8	10	12	15	18	21	21	25

*Abmessung nicht genormt, Richtwerte

Verfügbare Abmessungen auf den folgenden Seiten:

Edelstahl: [S. 592](#) | Nichteisen-Werkstoffe: [S. 644](#)



Rundstahlbügel

DIN 3570

Rundstahlbügel

Form A = zweiseitiges
Befestigungsgewinde

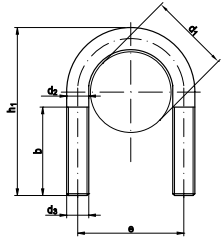

Maße	23*	30	38	46	52
Rohr-Nennweite	15	20	25	32	40
d ₁	20 bis 21	25 bis 26,9	30 bis 33,7	38 bis 42,4	44,5 bis 48,3
b ¹	30	40	40	50	50
d ₂	10	10	10	10	10
d ₃	M	M	M	M	M
e	33	40	48	56	62
h ₁ ¹	60	70	76	86	92

Maße	64	82	94	120	148
Rohr-Nennweite	50	65	80	100	125
d ₁	57 bis 60,3	76,1	88,9	108 bis 114,3	133 bis 139,7
b ¹	50	50	50	60	60
d ₂	12	12	12	16	16
d ₃	M	M	M	M	M
e	76	94	106	136	164
h ₁ ¹	109	125	138	171	191

Maße	176	228	282	332	530
Rohr-Nennweite	150	200	250	300	500
d ₁	159 bis 168,3	216 bis 219,1	267 bis 273	318 bis 323,9	508 bis 521
b ¹	60	70	70	70	70
d ₂	16	20	20	20	24
d ₃	M	M	M	M	M
e	192	248	302	352	554
h ₁ ¹	217	283	334	385	589

*Abmessung nicht genormt, Richtwerte
¹sind Mindestmaße und gelten für eine
Plattendicke von 10 mm

Verfügbare Abmessungen auf den folgenden Seiten:

Stahl/Stahl mit Oberfläche: [S. 235](#) | Edelstahl: [S. 528](#)

Schlauchschellen/Rohrschellen

DIN 3016

Halierungsschellen

Form D1 = mit Gummiprofil

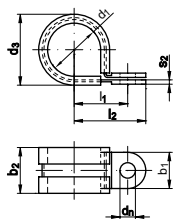

Maße (d ₁)	4 bis 20	4 bis 25	5 bis 14	15 bis 45	10 bis 25
b ₁	9	12	15	15	20
b ₂	13	15	19	19	25
d _n	4,3	5,3	6,4	6,4	8,4
d ₃	d1 + 5,2	d1 + 5,8	d1 + 7,4	d1 + 7,4	d1 + 9
l ₁	d1/2 + 4,7	d1/2 + 6,8	d1/2 + 9,7	d1/2 + 9,7	d1/2 + 12,5
l ₂	d1/2 + 9,2	d1/2 + 13	d1/2 + 17,2	d1/2 + 17,2	d1/2 + 22,5

Verfügbare Abmessungen auf den folgenden Seiten:

Stahl/Stahl mit Oberfläche: [S. 233](#)



Schlauchschellen/Rohrschellen

DIN 3017

Schlauchschellen mit Schneckenantrieb Form A

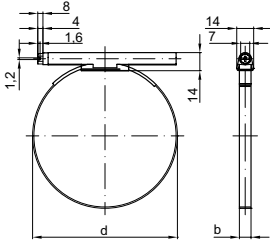

Maße	8-12	10-16	12-22	16-27	16- 27	20-32	20-32
b	9	9	9	9	12	9	12

Maße	25-40	25-40	30-45	30-45	35-50	35-50	40-60
b	9	12	9	12	9	12	9

Maße	40-60	50-70	50-70	60-80	60-80	70-90	70-90
b	12	9	12	9	12	9	12

Maße	80-100	80-100	90-110	90-110	100-120	110-130	120-140
b	9	12	9	12	12	12	12

Maße	130-150	140-160	150-170	160-180	170-190		
b	12	12	12	12	12		

Schlauchschellen mit Rundbolzen Form C1

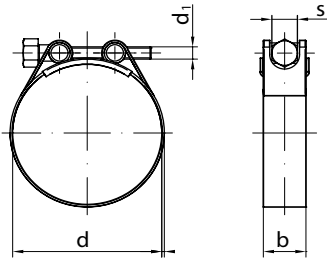

Maße	17-19	19-21	21-23	23-25	25-27	27-29	29-31
b	18	18	18	18	18	18	18
d ₁	M 6	M 6	M 6	M 6	M 6	M 6	M 6
s	8	8	8	8	8	8	8

Maße	31-34	34-37	37-40	40-43	43-47	47-51	51-55
b	18	18	18	18	20	20	20
d ₁	M 6	M 6	M 6	M 6	M 6	M 6	M 6
s	8	8	8	8	10	10	10

Maße	55-59	59-63	63-68	68- 73	73-79	79-85	85-91
b	20	20	20	25	25	25	25
d ₁	M 6	M 6	M 6	M 8	M 8	M 8	M 8
s	10	10	10	13	13	13	13

Maße	91-97	97-104	104-112	112-121	121-130	130-140	140-150
b	25	25	25	25	25	30	30
d ₁	M 8	M 8	M 8	M 8	M 8	M 8	M 10
s	13	13	13	13	13	13	16

Maße	150-162	162-174	174-187	187-200	200-213	213-226	226-239
b	30	30	30	30	30	30	30
d ₁	M 10	M 10	M 10	M 10	M 10	M 10	M 10
s	16	16	16	16	16	16	16

Maße	239-252						
b	30						
d ₁	M 10						
s	16						

Verfügbare Abmessungen auf den folgenden Seiten:

Stahl/Stahl mit Oberfläche: [S. 234](#), [S. 528](#)



Schlauchschellen/Rohrschellen

DIN 3567

Rohrschellen

Form A = gleichschenkelig

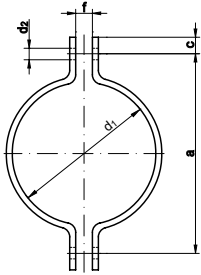

Maße	22	27	34	43	45	49
Nennweite	15	20 ^{3/4} "	25 ¹ "	32 ^{1/4} "	40	40 ^{1/2} "
a	59	66	72	82	84	88
c	15	15	15	15	15	15
d ₂	11,5	11,5	11,5	11,5	11,5	11,5
f	7	7	7	7	7	7
Flachstahl	30x5	30x5	30x5	30x5	30x5	30x5
Schraube	M 10x30	M 10x30	M 10x30	M 10x30	M 10x30	M 10x30

Maße	57	61	77	89	108	115
Nennweite	50	50 ² "	65 ^{2/2} "	80 ³ "	100	100 ⁴ "
a	104	108	122	136	172	178
c	18	18	18	18	24	24
d ₂	14	14	14	14	18	18
f	9	9	9	9	11	11
Flachstahl	40x6	40x6	40x6	40x6	50x8	50x8
Schraube	M 12x35	M 12x35	M 12x35	M 12x35	M 16x45	M 16x45

Maße	140	169	220	273	305	
Nennweite	125	150	200	250	300	
a	204	232	284	348	379	
c	24	24	24	30	30	
d ₂	18	18	18	23	23	
f	11	11	11	14	14	
Flachstahl	50x8	50x8	50x8	60x8	60x8	
Schraube	M 16x45	M 16x45	M 16x45	M 20x50	M 20x50	

d¹ = Nennmaß

Verfügbare Abmessungen auf den folgenden Seiten:

Stahl/Stahl mit Oberfläche: [S. 235](#) | Edelstahl: [S. 528](#)

DIN 3568

Klemmplatten für Rohrleitungs- Aufhängungen an Doppel-T-Trägern

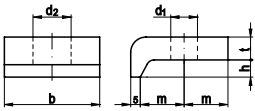

Maße	10	12	14	16	18	20
b	60	60	60	60	60	60
d ₁	18	18	18	18	18	18
d ₂	24	24	24	24	24	24
m	35	35	35	35	35	35
t	18	18	18	18	18	18
für Schrauben	M 16	M 16	M 16	M 16	M 16	M 16

h = Nennmaß

Verfügbare Abmessungen auf den folgenden Seiten:

Stahl/Stahl mit Oberfläche: [S. 235](#)

DIN 4109

Schraubrohrsellen mit Schallschutz-Einlage ~DIN 4109

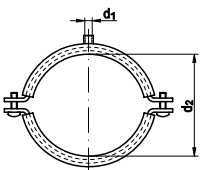

Maße	1/2"	3/4"	1"	1 1/4"
Spannbereich	20 – 23	25 – 28	32 – 35	40 – 43
d ₁ *	M 8/M 10	M 8/M 10	M 8/M 10	M 8/M 10
d ₂	1,25 x 20	1,25 x 20	1,25 x 20	1,25 x 20
Nutzlast	1,2 kN	1,2 kN	1,2 kN	1,2 kN
Maße	1 1/2"	1 1/2"	2"	
Spannbereich	48 – 53	57 – 61	60 – 64	
d ₁ *	M 8/M 10	M 8/M 10	M 8/M 10	
d ₂	1,25 x 20	1,25 x 20	1,25 x 20	
Nutzlast	1,2 kN	1,2 kN	1,5 kN	

Temperaturbeständigkeit: -50 °C bis +110 °C

*Anschluss mit Stufengewinde

Verfügbare Abmessungen auf den folgenden Seiten:

Stahl/Stahl mit Oberfläche: [S. 286](#)



Seilklemmen/Seilkauschen/Schäkel

~DIN 741

**Drahtseilklemmen
mit U-förmigen Klemmbügel
mit 2 Sechskantmuttern**

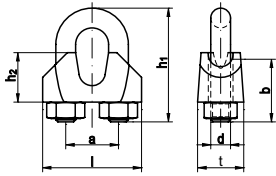

Maße	1/8"	3/16"	1/4"	5/16"	7/16"	1/2"	5/8"
für Seil \varnothing	3	5	6,5	8	11	13	16
d_1 Bügel *	M 4	M 5	M 5	M 6	M 8	M 10	M 12
h_1 Bügel	20	24	28	34	44	55	63
b Bügel	12	13	15	19	22	30	33
a	9	11	13	16	20	24	29
h_2 Klemmbacke	10	10	11	15	18	21	26
l Klemmbacke	21	23	26	30	36	42	50
t Klemmbacke	10	11	12	14	19	23	26

Verfügbare Abmessungen auf den folgenden Seiten:

Stahl/Stahl mit Oberfläche: [S. 111](#) | Edelstahl: [S. 475](#)

DIN 5299

**Karabinerhaken
Form C = birnenförmig**

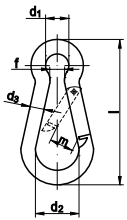

Maße	40x4	50x5	60x6	70x7	80x8	100x10
d_1	6	8	9	10	12	15
d_2 min.	14	15	17	19	23	29
d_3	4	5	6	7	8	10
f	4	4	6	8	8	10
m	8	7	8	8	10	11
Tragfähigkeit	100 kg	120 kg	120 kg	180 kg	230 kg	350 kg

Verfügbare Abmessungen auf den folgenden Seiten:

Stahl/Stahl mit Oberfläche: [S. 306](#)

DIN 6899

**Kauschen für Faserseile
Form BF = mittelschwer, mit tiefer Rille**

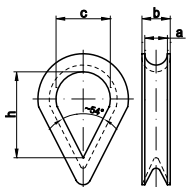

Maße	BF 3,5	BF 4	BF 5	BF 6
a	4	5	6	7
h	21	23	25	26
c	13	14	16	18

Maße	BF 7	BF 9	BF 11	
a	8	10	12	
h	32	38	45	
c	20	24	26	

Verfügbare Abmessungen auf den folgenden Seiten:

Stahl/Stahl mit Oberfläche: [S. 316](#)



Seilklemmen/Seilkauschen/Schäkel

DIN 82101

Schäkel

Form A = geschmiedet

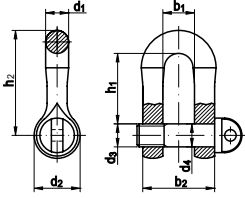

Maße	0,16	0,25	0,4	0,6	1
b_1	8	11	14	17	21
b_2	18	25	30	37	47
d_1	5	7	8	10	13
d_2	12	16	20	24	32
d_3	M 6	M 8	M 10	M 12	M 16
d_4	6	8	10	12	16
h_1	18	24	30	36	49
h_2	27	36	45	54	72
Schlüsselweite	-	-	-	-	24

Verfügbare Abmessungen auf den folgenden Seiten:

Stahl/Stahl mit Oberfläche: [S. 410](#)

Niete

DIN 660, 661

Niete

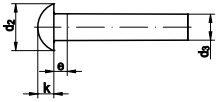

DIN 660 = Halbrundniete



DIN 661 = Senkniete

*Maßangaben entsprechen DIN 124

Maße	1	2	2,5	3	4
d_2	1,8	3,5	4,4	5,2	7
d_3 min.	0,93	1,87	2,37	2,87	3,87
$e_{max.}$	0,5	1	1,25	1,5	2
$k_{DIN 660}$	0,6	1,2	1,5	1,8	2,4
$k_{DIN 661}$	0,5	1	1,2	1,4	2

Maße	5	6	7	8	10*
d_2	8,8	10,5	12,2	14	16
d_3 min.	4,82	5,82	6,82	7,76	9,4
$e_{max.}$	2,5	3	3,5	4	5
$k_{DIN 660}$	3	3,6	4,2	4,8	6,5
$k_{DIN 661}$	2,5	3	3,5	4	-

Verfügbare Abmessungen auf den folgenden Seiten:

Stahl/Stahl mit Oberfläche: [S. 109](#) | Edelstahl: [S. 474](#), [S. 475](#) | Nichteisen-Werkstoffe: [S. 621](#), [S. 622](#)

DIN 662

Linsenniete

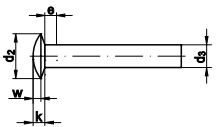

Maße	2	2,5	3	3,5	4	5	6
d_2	4	5	6	7	8	10	12
d_3	1,87	2,37	2,87	3,37	3,87	4,82	5,82
$e_{max.}$	1	1,25	1,5	1,75	2	2,5	3
k	1	1,2	1,5	1,8	2,1	2,5	3
w	0,7	0,8	1	1,2	1,4	1,7	2

Verfügbare Abmessungen auf den folgenden Seiten:

Stahl/Stahl mit Oberfläche: [S. 110](#) | Nichteisen-Werkstoffe: [S. 623](#)



Niete

DIN 674

Flachrundniete

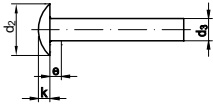

Maße	3	4	5
d_2	6,8	9	11,2
$d_3 \text{ min.}$	2,87	3,87	4,82
$e_{\text{max.}}$	1,5	2	2,5
k	1,5	2	2,5

Verfügbare Abmessungen auf den folgenden Seiten:

Stahl/Stahl mit Oberfläche: [S. 110](#)

DIN 7338

Niete für Brems- und Kupplungsbeläge

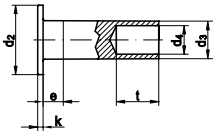

Form B = Halbhohnniete

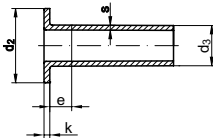

Form C = Hohnniete

Maße	3	4	5	6	8
d_2	5,5	7,5	9,5	11,5	15,5
$d_3 \text{ min.}$	2,85	3,8	4,8	5,8	7,75
d_4	1,7	2,7	3,5	4,2	6
$e_{\text{max.}}$	1,5	2	2,5	3	4
k	0,8	1	1	1,2	1,2
$r_{\text{max.}}$	0,2	0,3	0,3	0,4	0,4
s	0,5	0,5	0,6	0,75	1,2

Verfügbare Abmessungen auf den folgenden Seiten:

Stahl/Stahl mit Oberfläche: [S. 641](#)



Schrägzug-Spannelemente

Artikel 88060

Kurvenstücke

für Zuganker zur Schrägzugverspannung

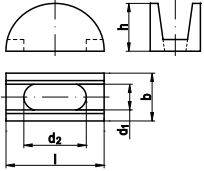

Einsatz nur mit Passscheiben Artikel 88061

Maße	M 12	M 20	M 24
l	59	64	77
b	30	41	53
d ₁	17	22	31
d ₂	30	45	47
h	30	32	31

Verfügbare Abmessungen auf den folgenden Seiten:

Befestigungstechnik: [S. 687](#)

Artikel 88061

Passscheiben für Kurvenstücke

für Zuganker zur Schrägzugverspannung

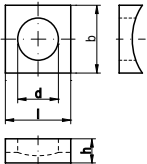

Einsatz nur mit Kurvenstücken Artikel 88060

Maße	M 12	M 16	M 20	M 24	M 27	M 30
l	30	30	41	51	51	51
b	30	30	41	51	51	51
d	13	17	22	25	28	31
h	10	10	11	18	18	18

Verfügbare Abmessungen auf den folgenden Seiten:

Befestigungstechnik: [S. 688](#)



Haken

Artikel 88135

Haken
S-Haken Typ 45



Maße	2,3	2,8	3,8	4,7	5,8	6,8	7,6
w	8	9	11	16	18	20	22
L	25	30	40	50	60	70	80
F max.	5 kg	7,5 kg	10 kg	15 kg	30 kg	50 kg	70 kg

Verfügbare Abmessungen auf den folgenden Seiten:

Stahl/Stahl mit Oberfläche: [S. 434](#)

Achshalter

DIN 15058

Achshalter (für Hebezeuge)

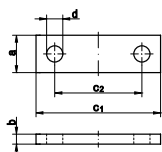

axb = Nennmaß

Maße	20x5	25x6	30x8	40x10	50x12
c ₁	60	80	100	140	190
c ₂	36	50	70	100	140
d	9	11	13	17	21
für Achs Ø	16 - 25	25 - 40	40 - 63	63 - 100	100 - 160

Verfügbare Abmessungen auf den folgenden Seiten:

Stahl/Stahl mit Oberfläche: [S. 407](#)

Passfedern

DIN 6880

Keilstahl
Länge 1000 mm

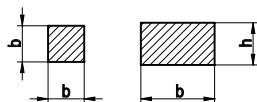

Maße	3x3	4x4	5x5	6x6	8 x7	10x8	12x8	14x9
für DIN 6884								
für DIN 6885/6886	3x3	4x4	5x5	6x6	8x7	10x8	12x8	14x4
für DIN 6887							8x7	
für DIN 6889						10x4	12x4	14x4,5

Maße	16x10	18x11	20x12	22x14	25x14	28x16	32x18	36x20
für DIN 6884		18x7	20x8	22x9	25x9	28x10	32x11	36x12
für DIN 6885/6886	16x10	18x11	20x12	22x14	25x14	28x16	32x18	36x20
für DIN 6887								
für DIN 6889		18x5						

Verfügbare Abmessungen auf den folgenden Seiten:

Stahl/Stahl mit Oberfläche: [S. 314](#)



Passfedern

DIN 6885

Passfedern, hohe Form

Typ A = rundstirnig ohne Bohrung(en)

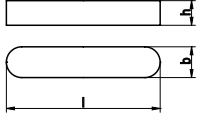

b = Nennmaß

Maße	2	3	4	5	6	8	10
h	2	3	4	5	6	8	10
für Wellen $\varnothing d/d_1$	6 - 8	8 - 10	10 - 12	12 - 17	17 - 22	22 - 30	30 - 38
Maße	12	14	16	18	20	22	25
h	12	14	16	18	20	22	25
für Wellen $\varnothing d/d_1$	38 - 44	44 - 50	50 - 58	58 - 65	65 - 75	75 - 85	85 - 95
Maße	28	32	36	40	45		
h	28	32	36	40	45		
für Wellen $\varnothing d/d_1$	95 - 110	110 - 130	130 - 150	150 - 170	170 - 200		

Verfügbare Abmessungen auf den folgenden Seiten:

Stahl/Stahl mit Oberfläche: [S. 315](#) | Edelstahl: [S. 555](#)

DIN 6887

Nasenkeile

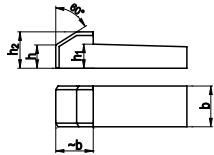

b = Nennmaß

Maße	6	8	10	12	14	16
h	6	7	8	8	9	10
h ₁	6,1	7,2	8,2	8,2	9,2	10,2
h ₂	10	11	12	12	14	16
für Wellen $\varnothing d/d_1$	17 - 22	22 - 30	30 - 38	38 - 44	44 - 50	50 - 58

Verfügbare Abmessungen auf den folgenden Seiten:

Stahl/Stahl mit Oberfläche: [S. 316](#)

DIN 6888

Scheibenfedern

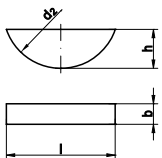

b = Nennmaß

¹⁾Bei Anwendung wie eine Passfeder DIN 6887

²⁾Bei Anwendung zur Feststellung der Lage

Maße	2	2	2,5	3	3	3	4
h	2,6	3,7	3,7	3,7	5	6,5	5
d ₂	7	10	10	10	13	16	13
l	6,76	9,66	9,66	9,66	12,65	15,72	12,65
für Wellen $\varnothing d/d_1$ ¹⁾	6 - 8	6 - 8	8 - 10	8 - 10	8 - 10	-	10 - 12
für Wellen $\varnothing d/d_1$ ²⁾	10 - 12	10 - 12	12 - 17	12 - 17	12 - 17	12 - 17	17 - 22
Maße	4	4	5	5	5	6	6
h	6,5	7,5	6,5	7,5	9	7,5	9
d ₂	16	19	16	19	22	19	22
l							
für Wellen $\varnothing d/d_1$ ¹⁾	10 - 12	-	12 - 17	12 - 17	-	17 - 22	17 - 22
für Wellen $\varnothing d/d_1$ ²⁾	17 - 12	17 - 22	22 - 30	22 - 30	22 - 30	30 - 38	30 - 38
Maße	6	8	8	8	10	10	10
h	11	9	11	13	11	13	16
d ₂	28	22	28	32	28	32	45
l	27,35	21,63	27,35	31,43	27,35	31,43	43,08
für Wellen $\varnothing d/d_1$ ¹⁾	-	22 - 30	22 - 30	-	30 - 38	30 - 38	-
für Wellen $\varnothing d/d_1$ ²⁾	30 - 38	>38	>38	>38	>38	>38	>38

Verfügbare Abmessungen auf den folgenden Seiten:

Stahl/Stahl mit Oberfläche: [S. 316](#)

Tabelle 1: Antriebsformen

Schlitz		Innensechsrund		Außendreikant	
Phillips Kreuzschlitz H		Innenvielzahn		Außensechsrund	
Pozidriv Kreuzschlitz Z		Innenzweifkant		Außenvielzahn	
Supradriv Kreuzschlitz		Torque - Set		Außensechskant mit Schlitz	
Kreuzschlitz-Kombi H+		Tri - Wing		Diebstahl- und vandalismushemmende Antriebe	
Kreuzschlitz-Kombi Z+		Hi - Torque			
Innenvierkant		Außensechskant			
Innensechskant		Außenvierkant			

Tabelle 2: Formen und Ausführungen von Schrauben

Form-beschreibung	Neue Bezeichnung	Alte Bezeichnung	Bild (Beispiel)	Bezeichnungs-beispiel	Form-beschreibung	Neue Bezeichnung	Alte Bezeichnung	Bild (Beispiel)	Bezeichnungs-beispiel
Ansatzkuppe (DIN 962)	Ak	Ak		ISO* - M 12 x 50 - Ak - 8.8	Einführzapfen flach (ISO 4753)	PF	PF		ISO* - M 12 x 50 - PF - 8.8
Kegelkuppe (ISO 4753)	CH	K		ISO* - M 12 x 50 - CH - 8.8	Gewindefreistich (DIN 76-1)	Ri	Ri		ISO* - M 12 x 50 - Ri - 8.8
Spitze (ISO 4753)	CN	-		ISO* - M 12 x 50 - CN - 8.8	Ohne Kuppe (ISO 4753)	RL	Ko		ISO* - M 12 x 50 - RL - 8.8
Ringschneide (ISO 4753)	CP	Rs		ISO* - M 12 x 50 - CP - 8.8	Linsenkuppe (ISO 4753)	RN	L		ISO* - M 12 x 50 - RN - 8.8
Kegelstumpf (ISO 4753)	FL	Ks		ISO* - M 12 x 50 - FL - 8.8	Splintloch (DIN 962/34803)	S	S		ISO* - M 12 x 50 - S - 8.8
Langer Zapfen (ISO 4753)	LD	Za		ISO* - M 12 x 50 - LD - 8.8	Schabanut (ISO 4753)	SC	Sb		ISO* - M 12 x 50 - SC - 8.8
Einführungszapfen mit Ansatzspitze (ISO 4753)	PC	PC		ISO* - M 12 x 50 - PC - 8.8	Kurzer Zapfen (ISO 4753)	SD	Ka		ISO* - M 12 x 50 - SD - 8.8
Ansatzspitze (DIN 962)	Asp	Asp		ISO* - M 12 x 50 - Asp - 8.8	Drahtloch (DIN 962/34803)	SK	SK		ISO* - M 12 x 50 - SK - 8.8
					Spitze abgeflacht (ISO 4753)	TC	Sp		ISO* - M 12 x 50 - TC - 8.8

*Produktnorm

Tabelle 3: Maße für Splintlöcher (S) und Drahtlöcher (SK)

Gewinde Ø M		3	4	5	6	7	8	10	12	14	16	18	20	22	24	27	30	33	36
Splintlöcher S* (DIN 962/34803)	d ₁	0,8	1	1,2	1,6	1,6	2	2,5	3,2	3,2	4	4	4	5	5	5	6,3	6,3	6,3
	l _e	2	2,2	2,6	3,3	3,3	4	5	6	6,5	7	7,7	7,7	8,7	10	10	11,3	11,3	12,5
Drahtlöcher SK* (DIN 962/34803)	d ₁	-	1,2	1,2	1,6	1,6	2	2	2	2	3	3	3	3	3	3	3	4	4
	*Positionstoleranz t = 2 IT13 (PK A), 2 IT14 (PK B), 2 IT15 (PK C)																		
Maße für Schlitzes**	~	0,8	1	1,2	1,6	1,6	2	2,5	3	3	4	**Die Lage des Schlitzes zu Ecken des Sechs- bzw. Vierkant es ist freigestellt							

Tellerfedern sind nach DIN 2092 und DIN 2093 / EN 16983 in Achsrichtung belastbare kegelförmige Ringscheiben. Diese vollkommen konzentrischen Biegefedern mit rotationsymmetrischem Querschnitt verfügen im Vergleich zu anderen Federarten über einen kleinen Federweg bei großer Federkraft. Die Kennlinie der Tellerfeder hängt maßgeblich von dem Verhältnis der freien Federhöhe [h₀] bis zur Planlage und der Tellerdicke [t] ab. Deshalb unterteilt man die Kennlinie in drei Reihen.

Jede Reihe wird in Abhängigkeit ihrer Materialstärke in drei Gruppen aufgeteilt. Diese Gruppen unterscheiden sich durch verschiedene Fertigungsverfahren.

Tabelle 1: Bezeichnungen

D_e	Außendurchmesser
D_i	Innendurchmesser
t	Dicke des Einzeltellers
l_0	Bauhöhe des unbelasteten Einzeltellers
s	Federweg des Einzeltellers
h_0	Rechengröße (Federweg bis zur Planlage bei Tellerfedern ohne Auflagefläche); $h_0 = l_0 - t$



Tabelle 2: Unterscheidung nach Reihen

Reihe	Faktor aus	
	$\frac{D_e}{t}$	$\frac{h_0}{t}$
A	~ 18	~ 0,4
B	~ 28	~ 0,75
C	~ 40	~ 1,3

Tabelle 3: Unterscheidung nach Gruppen

Gruppe	Dicke t	Fertigung/Bearbeitung
1	< 1,25 mm	kaltgeformt (gestanzt), Kanten gerundet, ohne Auflagefläche,
2	1,25 – 6 mm	kaltgeformt–feingeschnitten, D_e und D_i gedreht, ohne Auflagefläche
3	> 6 mm	kalt- oder warmgeformt, allseits gedreht, mit Auflagefläche

Durch gleichsinniges Schichten, wechselsinniges Schichten oder Kombination aus beidem lassen sich Tellerfedern zu Säulen mit fast beliebig gestaltbaren Kennlinien anordnen. Bei einem Federpaket aus 4 gleichsinnig geschichteten Federn vervierfachen sich die Federkräfte gegenüber einer Einzelfeder.

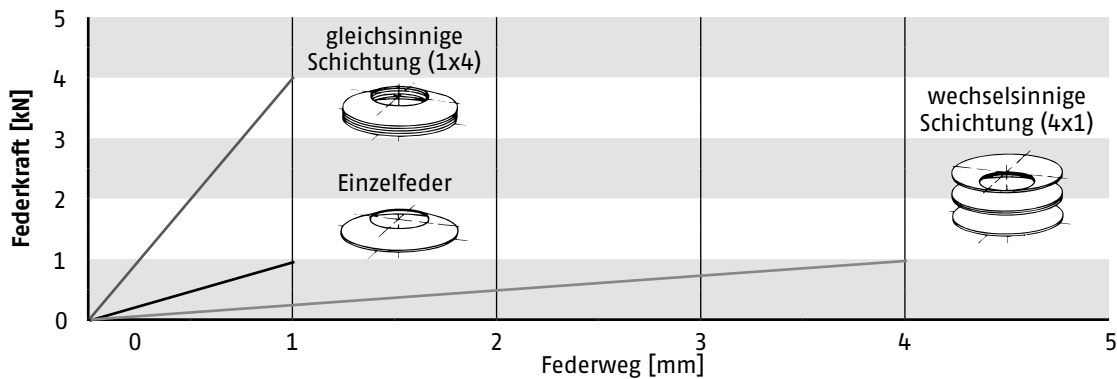

Die in EN 10083, EN 10089 und EN 10132-4 genannten Werkstoffe sind zulässig für Tellerfedern (Standard ist der Werkstoff 1.8159 – 51 CrV 4), C-Stähle jedoch nur für Tellerfedern der Gruppe 1. Die Tellerfedern werden vergütet mit einer Härte von 42–52 HRC (Tellerfedern der Gruppe 1: 425 HV10 bis 510 HV10) ausgeliefert. Die Standardoberfläche ist phosphatiert und geölt. Viele weitere Oberflächen zur Steigerung der Korrosionsbeständigkeit, wie zum Beispiel mechanische Verzinkung oder Zinklamellenbeschichtungen sind möglich.

Auch nichtrostende Stähle werden als Tellerfedernwerkstoff verwendet. Diese Sonderfedern können gegenüber dem Standard unterschiedliche, immer aber niedrigere Federkräfte aufweisen.

Tellerfedern DIN 2093 / EN 16983

- aus Cr-/CrV-legierten Edelstählen (Katalog → grüne Seiten S. 227)
- aus nichtrostenden Stählen 1.4310/ 1.4568 (Katalog → blaue Seiten S. 525)

Tellerfedern

- Tellerfedern in Sondermaßen
- Tellerfedern in Sonderwerkstoffen
- Tellerfedern mit Sonderüberzügen

Normativer Hinweis: DIN 2093:2013-12 wurde unverändert in EN 16983:2017-02 überführt.

Unter Berücksichtigung eines hohen Sicherheitsfaktors, bezogen auf die Mindestbruchkraft, haben Ringschrauben nach DIN 580 und Ringmuttern nach DIN 582 die in Tabelle 1 angegebenen Tragfähigkeiten. Die Tragfähigkeitswerte gelten für Stahl C15 E und Edelstahl A 2/A 4 ohne Einschränkung in einem Temperaturbereich von -20 °C bis $+200\text{ °C}$.

Ringschrauben und Ringmuttern gelten gemäß Maschinenrichtlinie 2006/42/EG als Lastaufnahmemittel und sind CE-kennzeichnungspflichtig. Darüber hinaus müssen sie eine Angabe der Mindesttragkraft (WLL) und, sofern dies für die sichere Verwendung erforderlich ist, die Angabe des Werkstoffes tragen. Darüber hinaus ist eine Kennzeichnung mit einem Pfeil vorgeschrieben (Bild 1), damit für den Anwender ersichtlich ist, dass die auf dem Produkt angegebene WLL nur in Axialrichtung gilt.

Eine nachträgliche farbliche Kennzeichnung von Ringschrauben und -muttern (insbesondere Rot) ist zu unterlassen, um Verwechslungen mit hochfesten Anschlagpunkten zu vermeiden.

Tabelle 1

Gewinde (d_1)		M 6	M 8	M 10	M 12	M 14	M 16	M 18	M 20	M 22	M 24	M 27	M 30
Tragfähigkeit Axial (WLL) je Ringschraube kg		75	140	230	340	490	700	850	1200	1400	1800	2100	3200
Tragfähigkeit bis max 45° je Ringschraube kg		55	100	170	240	350	500	600	860	1000	1290	1500	2300
Tragfähigkeit unter max 90° je Ringschraube kg		38	70	115	170	245	350	425	600	700	900	1050	1600

Gewinde (d_1)		M 33	M 36	M 39	M 42	M 45	M 48	M 52	M 56	M 64	M 72x6	M 80x6	M 100x6
Tragfähigkeit Axial (WLL) je Ringschraube kg		3200	4600	4600	6300	6300	8600	8600	11500	16000	20000	28000	40000
Tragfähigkeit bis max 45° je Ringschraube kg		2300	3300	3300	4500	4500	6100	6100	8200	11000	14000	20000	29000
Tragfähigkeit unter max 90° je Ringschraube kg		1600	2300	2300	3150	3150	4300	4300	5750	8000	10000	14000	20000

Benutzerinformationen für Ringschrauben DIN 580

Ringschrauben nach DIN 580 dienen vornehmlich zur dauerhaften Befestigung an Bauteilen wie Motoren, Schaltschränken, Getrieben etc. zu deren Transport. Für die wechselnde Benutzung an verschiedenen zu transportierenden Gegenständen, wie z. B. Großwerkzeugen, sollten Ringschrauben mit dem nächstgrößeren Gewindedurchmesser verwendet werden.

Die Tragfähigkeitsangaben in Tabelle 1 setzen voraus, dass

- die Ringschraube vollständig eingedreht ist,
- die Ringschraube eben und vollflächig auf der Auflagefläche aufliegt,
- die eingeleiteten Kräfte vom Grundwerkstoff ohne die Sicherheit beeinträchtigende Verformungen aufgenommen werden können,
- die Sacklöcher mit Einschraubgewinde so tief gebohrt sind, dass die Auflagefläche aufliegen kann.

Die in der zweiten Zeile der Tabelle 1 angegebene Tragfähigkeit gilt bis 45° Neigungswinkel, die in der dritten Zeile angegebene Tragfähigkeit bei seitlich eingeschraubten Ringschrauben (Ringmuttern) bis 45° Neigungswinkel in alle Richtungen bezüglich der Ringebene. Seitenzug darf nicht angewendet werden (siehe Bild 2).

Ringschrauben sollten vor dem Gebrauch auf festen Sitz und augenfällige Beschädigungen (Korrosion, Verformung) überprüft werden. Ringschrauben mit Verformungen sollten nicht weiterbenutzt und nicht wieder eingeschraubt werden.

Bei Durchgangslöchern sollte von der Gegenseite eine Mutter (keine flache Mutter) vollständig und fest aufgeschraubt werden.

Bei ausreichender Gewindelänge der Schraube wird zusätzlich die Verwendung einer Scheibe empfohlen.

Benutzerinformationen für Ringmuttern DIN 582

Ringmuttern nach DIN 582 dienen vornehmlich zur dauerhaften Befestigung an Bauteilen wie z. B. Schaltschränken etc. zu deren Transport. Für die wechselnde Benutzung an verschiedenen zu transportierenden Gegenständen sollten Ringmuttern mit dem nächstgrößeren Gewindedurchmesser verwendet werden.

Die Tragfähigkeitsangaben in Tabelle 1, setzen voraus, dass

- die Ringmutter vollständig aufgeschraubt ist,
- die Ringmutter eben und vollflächig auf der Auflagefläche aufliegt,
- die Länge des Gegengewindes ausreicht und die eingeleiteten Kräfte vom Grundwerkstoff ohne die Sicherheit beeinträchtigende Verformungen aufgenommen werden können,
- die Festigkeit des Elementes mit dem Gegengewinde (Schraube) ausreicht.

Unter dem Schraubenkopf als Gegenelement sollte eine Scheibe vorgesehen werden.

Die in der zweiten Zeile der Tabelle 1 angegebene Tragfähigkeit gilt bis 45° Neigungswinkel, die in der dritten Zeile angegebene Tragfähigkeit bei seitlich eingeschraubten Ringmuttern(Ringschrauben) bis 45° Neigungswinkel in alle Richtungen bezüglich der Ringebene. Seitenzug darf nicht angewendet werden (siehe Bild 3).

Ringmuttern sollten vor dem Gebrauch auf festen Sitz und augenfällige Beschädigungen (Korrosion, Verformung) überprüft werden. Ringmuttern mit Verformungen sollten nicht weiterbenutzt und nicht wieder eingeschraubt werden.

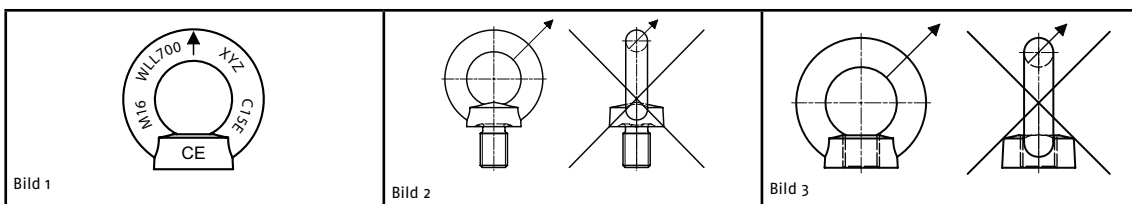

Kabelbinder

Artikel R 82500 - 82515

Kabelbinder, innenverzahnt
T-Serie

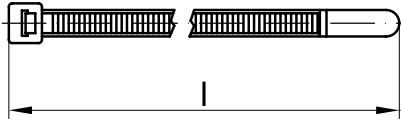

Brandschutz
UL94 V2

Kabelbinderbreite = Nennmaß

T = R 82500
T- HS = R 82505
T- W = R 82510
T- HR = R 82515

Maße	2,3		2,5		2,8		3,3
l	83	100	145	205	240	330	260
Bündel Ø _{max.}	16	22	35	55	65	95	65
Haltekraft (N)	80	80	80	80	110	110	180
Bezeichnung	T18S	T18R T18R-HS T18R-W T18R-HR	T18I T18I-HS T18I-W	T18L T18L-HS T18L-W	T25L	T25LL-W	T30LR T30LR-HS T30LR-W

Maße	3,5			4		
l	150	198	290	300	175	
Bündel Ø _{max.}	35	50	80	75	40	
Haltekraft (N)	135	135	135	135	180	
Bezeichnung	T30R T30R-HS T30R-W T30R-HR	T30L T30L-HS T30L-W	T30LL T30LL-W	T30LL-HS	T40R T40R-HS T40R-W	

Maße	4,6			4,7			
l	150	200	300	390	210	300	390
Bündel Ø _{max.}	35	50	81	110	55	85	110
Haltekraft (N)	225	225	225	225	355	355	355
Bezeichnung	T50S T50S-HS T50S-W	T50R T50R-HS T50R-W T50R-HR	T50I T50I-HS	T50L T50L-HS T50L-W T50L-HR	T80R T80R-HS T80R-W	T80I T80I-W	T80L-HS T80L-W

Maße	7,6				8,8	
l	225	365	387	460	760	820
Bündel Ø _{max.}	55	100	100	125	225	245
Haltekraft (N)	535	670	535	535	535	780
Bezeichnung	T120S T120S-W	T150R T150R-HS T150R-W	T120R T120R-HS T120R-W T120R-HR	T120M	T120L T120L-HS T120L-W	T150L-W

Maße	8,9					
l	530	530	820	1095		
Bündel Ø _{max.}	150	150	245	330		
Haltekraft (N)	780	780	780	780		
Bezeichnung	T150M-W	T150M	T150L	T150XL		

Ausführung	T
Material	Polyamid 6.6 (PA66), HF = halogenfrei
Farbe	NA = natur
Eigenschaften	Betriebstemperatur: -40 °C bis 85 °C, kurzfristig bis 105 °C (500 h)

Ausführung	T- HS
Material	Polyamid 6.6 hitzestabilisiert (PA66HS), HF = halogenfrei
Farbe	NA = natur/BK = schwarz
Eigenschaften	Betriebstemperatur: -40 °C bis 105 °C

Ausführung	T- W
Material	Polyamid 6.6 UV-witterungsstabil (PA66W), HF = halogenfrei
Farbe	BK = schwarz
Eigenschaften	Betriebstemperatur: -40 °C bis 85 °C, kurzfristig bis 105 °C (500 h)

Ausführung	T- HR
Material	Polyamid 4.6 Hochtemperaturbeständigkeit (PA46), HF = halogenfrei
Farbe	NA = natur
Eigenschaften	Betriebstemperatur: -40 °C bis 150 °C, kurzfristig bis 195 °C (500 h)

Kabelbinder

Artikel 82520

Kabelbinder, innenverzahnt
LK-Serie

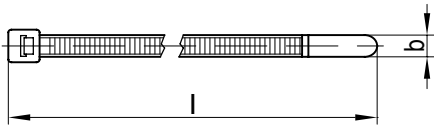

Brandschutz
UL94 V2

Kabelbinderbreite = Nennmaß

Maße	4,8	13,2
l	120	535
Bündel $\varnothing_{\text{max.}}$	28	150
Haltekraft (N)	135	1.115
Bezeichnung	LK2	LK5

Ausführung	PA66
Material	Polyamid 6.6, HF = halogenfrei
Farbe	NA = natur
Eigenschaften	Betriebstemperatur: -40 °C bis 85 °C, kurzfristig bis 105 °C (500 h)

Artikel 82516

Kabelbinder, außenverzahnt,
mit flacher Kopfgeometrie,
Robusto-Serie

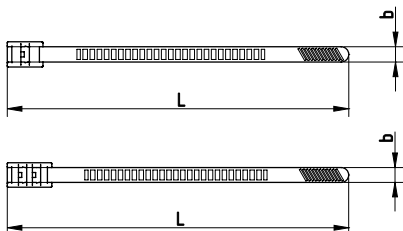

Brandschutz
UL94 HB

Kabelbinderbreite = Nennmaß

Maße	9,0		
l	180	260	355
Bündel $\varnothing_{\text{max.}}$	42	62	92
Haltekraft (N)	360	530	530
Bezeichnung	LPH942	LPH962	LPH992

Ausführung	PA11
Material	Polyamid 11, HF = halogenfrei
Farbe	BK = schwarz
Eigenschaften	Betriebstemperatur: -40 °C bis 85 °C, kurzfristig bis 105 °C (500 h)

Artikel 82517

Kabelbinder Q-ties,
innenverzahnt, mit offenem
Bindekopf und Vorverriegelung
für schnelles und einfaches Einschlaufen

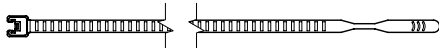

Brandschutz
UL94 V2

Kabelbinderbreite = Nennmaß

Maße	3,6	4,7	7,7
l	160	210	420
Bündel $\varnothing_{\text{max.}}$	38	50	110
Haltekraft (N)	130	220	530
Bezeichnung	Q30R	Q50R	Q120R

Ausführung	PA11
Material	Polyamid 6.6, UV-witterungsstabil, HF = halogenfrei
Farbe	BK = schwarz
Eigenschaften	Betriebstemperatur: -40 °C bis 85 °C, kurzfristig bis 105 °C (500 h)

Kabelbinder

Artikel 82518

Kabelbinder Coupler mit Befestigungselement
2-teilig zur Parallelführung zweier Kabelbündel



Kabelbinderbreite = Nennmaß

Maße	4,6	7,6
l	202	390
Bündel $\varnothing_{\max.}$	47	105
Haltekraft (N)	225	535
Bezeichnung	T50RCOUPLER	T120RCOUPLER

Ausführung	Kabelbinder PA66HIR(S)	Fußteil PA66HIRHS
Material	Polyamid 6.6, schlagzäh modifiziert	Polyamid 6.6, schlagzäh modifiziert
Farbe	BK = schwarz	BK = schwarz
Eigenschaften	Betriebstemperatur: -40 °C bis 80 °C, kurzfristig bis 105 °C (500 h)	Betriebstemperatur: -40 °C bis 105 °C (500 h)

Kabelbinder mit Befestigungselementen

Artikel 82521

Kantenbefestigungsbinder EdgeClip 2-teilig, für Kantenbreite 1- 3 mm
Aufnahme oben, Binderführung axial

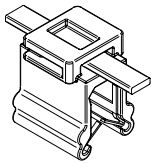

Kabelbinderbreite	4,6
l	200
Bündel $\varnothing_{\max.}$	45
Haltekraft (N)	225
Bezeichnung	T50ROSEC4A-W

Ausführung	PA66W
Material	Polyamid 6.6, UV-witterungsstabil, HF = halogenfrei
Farbe	BK = schwarz
Eigenschaften	Betriebstemperatur: -40 °C bis 85 °C, kurzfristig bis 105 °C (500 h)

Artikel 82522

Kantenbefestigungsbinder EdgeClip 2-teilig, für Kantenbreite 1- 3 mm

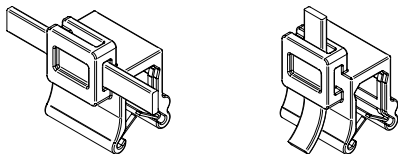

S-A = Aufnahme seitlich, Binderführung axial

S-Q = Aufnahme seitlich, Binderführung quer

Kabelbinderbreite	3,6 S-Q	4,6 S-Q	4,6 S-A	
l	148	200	150	200
Bündel $\varnothing_{\max.}$	33	45	31	45
Haltekraft (N)	135	225	225	225
Bezeichnung	T30REC5A	T50ROSEC5A	T50S0SEC5B	T50ROSEC5B

Ausführung	Kabelbinder PA66HS	Fußteil PA66HIRHS
Material	Polyamid 6.6, hitzestabilisiert	Polyamid 6.6, schlagzäh modifiziert, hitzestabilisiert
Farbe	BK = schwarz	BK = schwarz
Eigenschaften	Betriebstemperatur: -40 °C bis 105 °C	Betriebstemperatur: -40 °C bis 105 °C (500 h)



Kabelbinder mit Befestigungselementen

Artikel 82523

Kantenbefestigungsbinder EdgeClip
2-teilig, für Kantenbreite 3- 6 mm

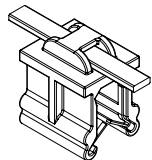

O-A =
Aufnahme oben,
Binderführung axial

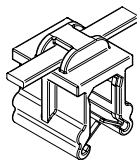

O-Q =
Aufnahme oben,
Binderführung quer

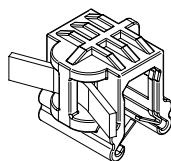

S-A =
Aufnahme seitlich,
Binderführung axial

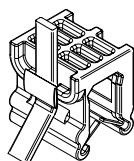

S-Q =
Aufnahme seitlich,
Binderführung quer

Kabelbinderbreite	4,6 O-A	4,6 O-Q		4,6 S-A	4,6 S-Q
l	200	150	200	200	200
Bündel $\varnothing_{\text{max.}}$	45	35	45	45	45
Haltekraft (N)	225	225	225	225	225
Bezeichnung	T5OR0SEC19	T5OS0SEC20	T5OR0SEC20	T5OR0SEC23	T5OR0SEC24

Ausführung	Kabelbinder PA66HS	Fußteil PA66HIRHS
Material	Polyamid 6.6, hitze stabilisiert	Polyamid 6.6, schlagzäh modifiziert, hitze stabilisiert
Farbe	BK = schwarz	BK = schwarz
Eigenschaften	Betriebstemperatur: -40 °C bis 105 °C <div style="border: 1px solid black; padding: 2px; width: fit-content; margin: auto;">Brandschutz UL94 V2</div>	Betriebstemperatur: -40 °C bis 105 °C (500 h) <div style="border: 1px solid black; padding: 2px; width: fit-content; margin: auto;">Brandschutz UL94 HB</div>

Verarbeitungswerkzeuge für Kabelbinder

Artikel 82535

Man. Verarbeitungswerkzeug EOV7

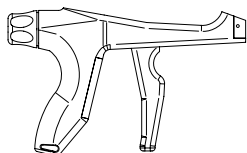

Binderbreite max.	Dicke max.	Gewicht	Bemerkung
4,8	1,5	280 g	<ul style="list-style-type: none"> - manuelles Verarbeitungswerkzeug - Abbinden mit geringem Kraftaufwand - komfortable Einstellung der Zugkraft - mit Schneidevorrichtung - rutschfester Griff - Griffweite 90 mm - leichtes, glasfaserverstärktes Kunststoffgehäuse

Befestigungselemente für Kabelbinder

Artikel 82540

Befestigungssockel für Kabelbinder,
Typ TY-G1, selbstklebend

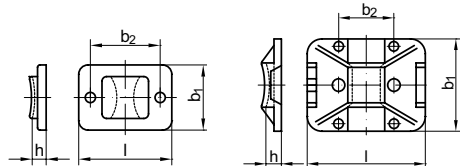

Brandschutz
UL94 V2

Kabelbinderbreite	4,0	8,0
l	20	32
b ₁	14	25
h	3,7	5,2
b ₂	15	15
Befestigungsloch-Ø	2,2	3,2
Bezeichnung	TY3G1S	TY8G1S

Ausführung	TY-G1	
Material	Polyamid 6.6 (PA66), HF = halogenfrei	
Farbe	NA = natur	
Eigenschaften	Betriebstemperatur: -40 °C bis 85 °C, kurzfristig bis 105 °C (500 h)	
Befestigung	selbstklebend, schraubbar	

Artikel 82543/82546

Befestigungssockel für Kabelbinder,
Typ NY/LKC, schraubbar

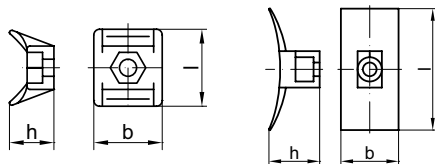

Brandschutz
UL94 V2

Kabelbinderbreite	8,0	8,0
l	13,5	25
b	12	17
h	7,8	13,5
Befestigungsloch-Ø	3,1	5,5
Bezeichnung	NY3256	LKC

Ausführung	NY und LKC	
Material	Polyamid 6.6 (PA66), HF = halogenfrei	
Farbe	NA = natur	
Eigenschaften	Betriebstemperatur: -40 °C bis 85 °C, kurzfristig bis 105 °C (500 h)	
Befestigung	schraubbar	

Artikel 82550

Befestigungssockel für Kabelbinder,
Typ MB-CA, selbstklebend

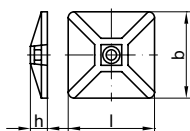

Brandschutz
UL94 V2

Kabelbinderbreite	5,4
l	29
b	29
h	5,7
Befestigungsloch-Ø	4,2
Bezeichnung	MB4CAS ²⁾

Ausführung	PA66
Material	Polyamid 6.6 (PA66), HF = halogenfrei
Farbe	NA = natur
Eigenschaften	Betriebstemperatur: -40 °C bis 85 °C, kurzfristig bis 105 °C (500 h)
Befestigung	selbstklebend

Artikel 82553

Befestigungssockel für Kabelbinder,
Typ MB-A, selbstklebend und schraubbar

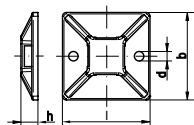

Brandschutz
UL94 V2

Kabelbinderbreite	5,4
l	28
b	28
h	4,7
Befestigungsloch-Ø	4,0
Bezeichnung	MB4A

Ausführung	PA66
Material	Polyamid 6.6 (PA66), HF = halogenfrei
Farbe	NA = natur
Eigenschaften	Betriebstemperatur: -40 °C bis 85 °C, kurzfristig bis 105 °C (500 h)
Befestigung	selbstklebend und schraubbar

Befestigungselemente für Kabelbinder

Artikel 82554

Befestigungssockel für Kabelbinder, mit Spezialkleber, SolidTack-Serie

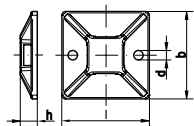

Brandschutz
UL94 V2

Kabelbinderbreite	4,1	5,4
l	19	28
b	19	28
h	3,8	4,7
Befestigungsloch-Ø	3,1	4
Bezeichnung	MB3APT	MB4APT

Ausführung	NY und LKC
Material	Polyamid 6.6 (PA66), HF = halogenfrei
Farbe	NA = natur/BK = schwarz
Eigenschaften	Betriebstemperatur: -40 °C bis 85 °C, kurzfristig bis 105 °C (500 h)
Befestigung	selbstklebend mit Spezialkleber (mod. Acrylat) und schraubbar

Artikel 82560

Befestigungssockel für Kabelbinder, Typ CL8, schraubbar

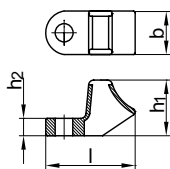

Brandschutz
UL94 V2

Kabelbinderbreite	8,0
l	27,3
b	12,5
h ₁	16,0
h ₂	5,0
Befestigungsloch-Ø	6,5
Bezeichnung	CL8

Ausführung	CL8
Material	Polyamid 6.6 (PA66), HF = halogenfrei
Farbe	NA = natur
Eigenschaften	Betriebstemperatur: -40 °C bis 85 °C, kurzfristig bis 105 °C (500 h)
Befestigung	schraubbar

1. Normen

Für „Gewindeeinsätze aus Draht für Metrisches ISO-Gewinde“ gelten die Normen

- DIN 8140-1 Maße, Technische Lieferbedingungen
- DIN 8140-2 Aufnahmegewinde für Gewindeeinsätze, Gewindetoleranzen
- DIN 8140-3 Lehren und Lehrenmaße

Diese Normen gelten für ISO-metrisches Regel- und Feingewinde.

Daten für weitere lieferbare Gewindeausführungen (BSW/BSF, UNC/UNJC/UNF/UNJF, GAZ, BSP) stehen auf Anforderung zur Verfügung.

2. Anwendungsbereiche/Werkstoffe/Eigenschaften

- Anwendung im Ersteinsatz: für hochbelastbare und dauerhafte Innengewinde in Teilen aus metallischen und nichtmetallischen Werkstoffen
- Anwendung bei Reparaturen/Nacharbeiten: als Ersatz für unbrauchbar gewordene (= beschädigte/abgenutzte) Gewinde.

Die besonderen Eigenschaften von Gewindeeinsätzen aus Draht sind

- Verminderung der Neigung zur Kaltverschweißung bei Schraubenverbindungen,
- weitgehend gleichbleibender Reibwert,
- gute Temperatur- und Korrosionsbeständigkeit,
- bei Form B „klemmend“ (→ 4.) zusätzliches Entgegenwirken gegen selbstständiges Lösen der Schraubenverbindung durch erhöhten Reibungschluss im Gewinde.

Über die lagerhaltige Standard-Materialausführung „Edelstahl 18.8 (A 2)“ hinaus sind Gewindeeinsätze aus Draht aus Sonderwerkstoffen für spezielle Einsatzanforderungen lieferbar → Tabelle 1.

Tabelle 1: Werkstoffe für die verschiedenen Anwendungsbereiche

Material	Höchsttemperatur	Optionen für die Oberflächenbeschichtung	Anwendungen
Standardmaterial Edelstahl 18.8 (A 2)	425 °C (kurzfristig)	Trockenschmierung Kadmierung Versilberung Verzinkung Verzinnung	Alle üblichen Anwendungen für alle Materialien
AISI 304 (1.4301) AISI 302 (1.4310)	315 °C (längere Zeit)		Sonderanwendung – beständig gegen Säuren, Rost, hohe Temperaturen, unmagnetisch
Spezieller Edelstahl AISI 304L, 316, 316L, 316Ti, 321	Bis zu 400 °C über längere Zeit		
Phosphorbronze	300 °C (kurzfristig) 250 °C (längere Zeit)	Kadmierung	Kupferteile – Beständigkeit gegen bestimmte elektrolytische Vorgänge
Inconel x 750 Nc 15 Fe Nba	750 °C (kurzfristig)	Versilberung	Wärmeleistungwerke Raumfahrt Luftfahrt Turboverdichter
Nimonic 90 Nc 20 C 18 Ti	538 °C (längere Zeit)		

3. Herstellung

Die Gewindeeinsätze werden aus einem Draht mit rhombenförmigem Querschnitt hergestellt. Sie haben nach dem Wicklungsprozess zwei Gewindeprofile – außen für das Einbringen in das nach DIN 8140-2 vorbereitete Aufnahmegewinde im Werkstück – innen (nach dem Einsetzen) für die Aufnahme eines Schraubengewindes.

4. Formen

Nach DIN 8140-1 wird grundsätzlich unterschieden nach

- Form A = zylindrische Form* für Regel- und Feingewinde.
- Form B = „klemmend“ (wie Form A, jedoch mit mittig angeordneten, polygonen elastischen Windungen (→ 2.)
(Gewindeeinsätze Form B sind durch Rotfärbung erkennbar).

*Die neue Generation der AMECOIL-Gewindeeinsätze „Typ SR“ ist so geformt, dass das Einsetzen leichter und sicherer ist und somit eine höhere Produktivität erzielt wird.

5. Antriebssysteme für das Einsetzen

DIN 8140-1 zeigt als Antriebssystem einen Mitnehmerzapfen, der nach dem Einsetzen mit einem Zapfenbrecherwerkzeug an der Kerbe zu entfernen ist. Dieses Antriebssystem haben z.B. AMECOIL-Gewindeeinsätze.

6. Bestimmung der Nennlänge

Die jeweils zu wählenden Nennlängen der Gewindeeinsätze sind zum einen abhängig vom Werkstoff des Werkstückes und zum anderen von der Festigkeitsklasse der Schraube
(empfohlene Nennlängen → DIN 8140-1, Tabelle 1).

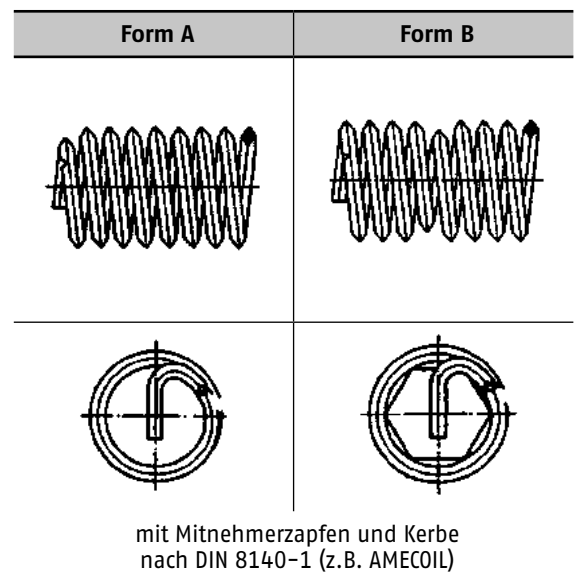

7. Maße/Messmöglichkeiten bei der Annahmeprüfung

Im Bestelltext sind als Maßangaben vorzugeben (Beispiel M 10x15):

- das nach dem Einsetzen gewünschte Nutz-/Innengewinde – z.B. M 10,
- die nach DIN 8140-1, Tabelle 1, gewählte Nennlänge l_1 – z.B. 15 (= 1,5 d).

Im Anlieferungszustand sind bei der Annahmeprüfung nur der Außendurchmesser und die Anzahl der Windungen messbar (→ Tabelle 2) – die Nennlänge l_1 ergibt sich erst im eingesetzten Zustand.

Tabelle 2: Maße – Außen-Ø und Windungszahlen im Anlieferungszustand

Merkmale		für Regelgewinde mit Nennmaß Nutz-/Innengewinde															
		M 2	M 2,5	M 3	M 4	M 5	M 6	M 7	M 8	M 10	M 12	M 14	M 16	M 18	M 20	M 22	M 24
Außen-Ø	min.	2,6	3,3	3,8	5,15	6,35	7,6	8,65	9,85	12,1	14,4	16,8	19,0	21,5	23,7	26,3	28,6
	max.	2,8	3,5	4,0	5,35	6,6	7,85	8,9	10,1	12,5	14,8	17,2	19,4	22,0	24,2	26,8	29,1
Bohr-Ø	mm	2,1	2,6	3,2	4,2	5,2	6,3	7,3	8,4	10,5	12,5	14,5	16,5	18,75	20,75	22,75	24,75
Windungsanzahl AW*	1d = mm	2	2,5	3	4	5	6	7	8	10	12	14	16	18	20	22	24
	AW	2,9	3,5	3,9	3,7	4,3	4,2	5,3	4,7	5,0	5,2	5,6	6,5	5,6	6,3	6,9	6,2
Nennlänge d/mm	1,5d = mm	3	3,75	4,5	6	7,5	9	10,5	12	15	18	21	24	27	30	33	36
	AW	4,9	5,9	6,3	6,1	6,9	6,9	8,2	7,4	8,1	8,4	8,8	10,1	9,0	10,0	10,9	10,0
(*Tol. -0,25)	2d = mm	4	5	6	8	10	12	14	16	20	24	28	32	36	40	44	48
	AW	6,9	8,1	8,7	8,4	9,7	9,6	11,1	10,6	11,2	11,7	12,0	13,8	12,3	13,7	15,1	14,0
(*Tol. -0,25)	2,5d = mm	5	6,25	7,5	10	12,5	15	17,5	20	25	30	35	40	45	-	-	-
	AW	8,9	10,5	11,1	10,9	12,3	12,3	14,3	13,5	14,2	14,7	15,2	17,5	15,5	-	-	-

Merkmale		für Feingewinde mit Nennmaß Nutz-/Innengewinde											
		M 8x1	M 10x1	M 10x1,25	M 12x1	M 12x1,25	M 14x1,5	M 14x1,25	M 16x1,5	M 20x1,5	M 20x2	M 24x1,5	M 24x2
Außen-Ø	min.	9,85	12,1	12,1	14,4	14,4	16,8	16,8	19,0	23,7	23,7	28,6	28,6
	max.	10,1	12,5	12,5	14,8	14,8	17,2	17,2	19,4	24,2	24,2	29,1	29,1
Bohr-Ø	mm	8,3	10,25	10,4	12,3	12,4	14,5	14,4	16,5	20,5	20,5	24,5	24,5
Windungsanzahl AW*	1d = mm	8	10	10	12	12	14	8,4 ①	16	20	20	24	24
	AW	6,1	7,6	6,0	9,3	7,4	7,4	(15,2)	8,7	10,7	8,0	12,9	9,6
Nennlänge d/mm	1,5d = mm	12	15	15	18	18	21	12,4 ①	24	30	30	36	36
	AW	9,5	12,1	9,7	14,5	11,6	11,6	(18,2)	13,4	16,7	12,5	19,8	15,0
(*Tol. -0,25)	2d = mm	16	20	20	24	24	28	14,4 ①	32	40	40	48	48
	AW	12,9	16,3	13,1	19,5	15,9	15,7	(19,4)	18,1	22,4	16,8	26,6	20,2
(*Tol. -0,25)	2,5d = mm	20	25	-	-	-	35	16,4 ①	40	① Zündkerzen-Gewinde mit speziellen d-Maßen			
	AW	16,5	20,7	-	-	-	19,9	(10,6)	22,9				

Tabelle 3: Übersicht Werkzeuge, Zubehör und zugehörige Artikelnummern

Werkzeug/Zubehör	Artikelnummer	
	Regelgewinde SR	Feingewinde
Gewindeeinsatz	R 88330	R 88331
Bohrer für Kernloch-Ø	R 88988, R 88989	
Gewindevorschneider	R 88339 ab M 18	-
Gewinfertigschneider	R 88338	R 88338
Montagewerkzeuge		
• Grundwerkzeug	-	R 88333 Fein
• Spindel+Vorspannpatrone	-	R 88334 Fein
• Kurbel für Gewindespindel	R 88333 SR	-
• Gewindespindel	R 88334 SR	-
• Einbauwerkzeug komplett	R 88335 SR ab M 18	R 88335 Fein ab M 20
Zapfenbrecher	R 88336	
Ausdrehwerkzeug	R 88337	
Sortimentskoffer mit Einbauwerkzeugen	R 88342, R 88344	

Montagefolge



Bohren



Gewindeschneiden



Einbau
mit konventionellem
Werkzeug



mit Werkzeug der
SR-Serie



Abbrechen des
Montagezapfens

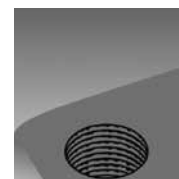

Gewindeeinsatz
montiert

Verfügbare Abmessungen/Werkzeuge auf den folgenden Seiten: [S. 561-563](#)

Maße für selbstschneidende Gewindeeinsätze Ensat®

Artikel 88302

Ensat® 302

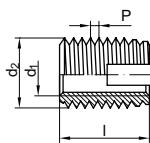

Maße	M 2,5	M 3	M 4	M 5	M 6	M 8
d ₂	4,5	5	6,5	8	10	12
P	0,5	0,5	0,75	1	1,5	1,5
l	6	6	8	10	14	15
Sacklochtiefe _{min.}	8	8	10	13	17	18
Maße	M 10	M 12	M 14	M 16	M 18	M 20
d ₂	14	16	18	20	22	26
P	1,5	1,5	1,5	1,5	1,5	1,5
l	18	22	24	22	24	27
Sacklochtiefe _{min.}	22	26	28	27	29	32
Maße	M 22	M 24	M 27	M 30		
d ₂	26	30	34	36		
P	1,5	1,5	1,5	1,5		
l	30	30	30	40		
Sacklochtiefe _{min.}	36	36	36	46		

d₁ = Nennmaß

Artikel 88307

Ensat® 307

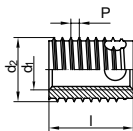

Maße	M 4	M 5	M 6	M 8	M 10	M 12
d ₂	6,5	8	10	12	14	16
P	0,8	1	1,25	1,5	1,5	1,75
l	6	7	8	9	10	12
Sacklochtiefe _{min.}	8	9	10	11	13	15

d₁ = Nennmaß

Artikel 88308

Ensat® 308

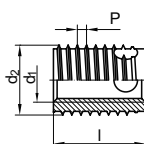

Maße	M 4	M 5	M 6	M 8	M 10	M 12
d ₂	6,5	8	10	12	14	16
P	0,8	1	1,25	1,5	1,5	1,75
l	8	10	12	14	18	22
Sacklochtiefe _{min.}	10	13	15	17	22	26

d₁ = Nennmaß

Tabelle 4: Richtwerte für Bohrlochdurchmesser

Bohrloch-Ø [mm]		R 88302 (Ensat® 302)				R 88307/R 88308 (Ensat® 307/308)			
Werkstoff des Werkstücks	Leichtmetall-Legierungen R _m = Zugfestigkeit [N/mm ²]	R _m < 250				R _m < 300			
		R _m < 300				R _m < 350			
		R _m < 350		R _m > 350		R _m < 350		R _m > 350	
	Ms, Bronze, Ne-Metall			R _m > 350				R _m > 350	
		< 150 HB				< 150 HB			
		< 200 HB		> 200 HB		< 200 HB		> 200 HB	
Gußeisen HB = Brinellhärte									
Flankenüberdeckung ca.		60 %	50 %	40 %	30 %	80 %	70 %	60 %	50 %
Ensats® Innengewinde	M 2/M 2,5	-	4,1	4,2	4,3	-	-	-	-
	M 3	-	4,6	4,7	4,8	4,6	4,7	4,7	4,8
	M 3,5	5,4	5,5	5,6	5,7	5,5	5,6	5,7	-
	M 4	5,9	6,0	6,1	6,2	6,0	6,1	6,2	-
	M 5	7,2	7,3	7,5	7,6	7,4	7,5	7,6	7,7
	M 6	8,8	9,0	9,2	9,4	9,3	9,4	9,5	9,6
	M 8	10,8	11,0	11,2	11,4	11,1	11,2	11,3	11,5
	M 10	12,8	13,0	13,2	13,4	13,1	13,2	13,3	13,5
	M 12	14,8	15,0	15,2	15,4	15,0	15,1	15,2	15,4
	M 14	16,8	17,0	17,2	17,4	17,0	17,1	17,2	17,4
	M 16	18,8	19,0	19,2	19,4	19,0	19,1	19,2	19,4
	M 18	21,0	21,0	21,2	21,4	-	-	-	-
	M 20/M 22	25,0	25,0	25,2	25,4	-	-	-	-
M 24	29,0	29,2	29,2	29,4	-	-	-	-	
M 27	33,0	33,2	33,2	33,4	-	-	-	-	
M 30	35,0	35,0	35,2	35,4	-	-	-	-	

Verfügbare Abmessungen/Werkzeuge auf den folgenden Seiten:

Edelstahl: [S.603](#)

8 POINT LED



Montage-Symbolerklärung



Bei stirnseitig geschlossenen Profilen lassen sie sich nachträglich nicht mehr einführen. Die Mutter für T-Nuten muss vom Ende der Nut her eingeschoben werden.



Einschwenkbare Muttern können an beliebiger Stelle in die Nut eingesetzt werden. Sie sind somit optimal für Montagen an bereits bestehenden Konstruktionen einsetzbar. T-Nut und Mutter für T-Nut müssen allerdings aufeinander abgestimmt sein. Die Mutter kann an beliebiger Stelle in die Nut eingeschwenkt werden.



Eindrehbare Muttern können an beliebiger Stelle in die Nut eingesetzt werden. Sie sind ebenfalls optimal für Montagen an bereits bestehenden Konstruktionen verwendbar. Rhombus- und Hammermuttern besitzen diese Eigenschaft. Dies gilt auch für Hammerkopfschrauben.
Hilfreich bei dieser Art von Muttern sind Eindrehhilfen, wie z.B. Schlitz im Nutenstein, Gewinde mit Steigungsfehler, Vermarkung- oder Kunststoffmitnehmer im Gewinde.

Fixiersysteme



Fixiersysteme sollen ein Verschieben der Muttern vor und während der Montage und bei Demontage verhindern, insbesondere bei senkrechtstehender Montageschiene. Die Fixiersysteme können mit den einzelnen Montagearten kombiniert sein. Die Muttern haben die Eigenschaften sich in dem T-Nutenkanal zu fixieren, um die Montage zu erleichtern.

Ausführungsformen



Mutter ohne Führungssteg für T-Nuten haben für den zu verschraubenden Gewindebolzen in der Regel ein größeres Spiel in seitliche Richtung. Der Einsatz ist dann vorteilhaft, wenn die Anschlusssteile nicht präzise vorbereitet werden können.



Mutter mit Führungssteg für T-Nuten werden durch den Steg in der Schiene zentriert. Dadurch kann diese Mutter auch in Schienen eingesetzt werden, in denen die untere Nutbreite deutlich größer ist als die Breite der Mutter. Durch den zusätzlichen Steg wird außerdem die Montage erleichtert und es stehen mehr nutzbare Gewindegänge zur Verfügung, was die Tragfähigkeit der Mutter erhöht.

Befestigungskomponente			
Artikelnummer	Bezeichnung		
87010.011	Mutter für T-Nuten, (M 4/M 5) Profil 5 mit Führungssteg und Kugel gefedert, Stahl galvanisch verzinkt	 	
87010.012	Mutter für T-Nuten, (M 4/M 5) Profil 5 ohne Führungssteg und mit Kugel gefedert, Stahl galvanisch verzinkt	 	
87011.013	Mutter für T-Nuten, (M 5/M 6) Profil 6 mit außenliegendem Führungssteg 6mm und Kugel gefedert, Stahl galvanisch verzinkt	 	
87012.011	Mutter für T-Nuten, (M 6/M 8) Profil 8 mit Führungssteg, Stahl galvanisch verzinkt	 	

Befestigungskomponente

Artikelnummer	Bezeichnung		
87012.015	Muttern für T-Nuten, (M 6/M 8) Profil 8 mit Führungssteg und Feder, Stahl galvanisch verzinkt		
87012.012	Muttern für T-Nuten, (M 6/M 8) Profil 8 ohne Führungssteg und mit Kugel gefedert, Stahl galvanisch verzinkt		
87012.016	Muttern für T-Nuten, (M 6/M 8) Profil 8 mit Führungssteg und mit Kugel gefedert, Stahl galvanisch verzinkt		
87012.017	Muttern für T-Nuten, (M 6/M 8) Profil 8 mit Führungssteg und Kugel gefedert, Stahl galvanisch verzinkt		
87013.011	Muttern für T-Nuten, (M 6/M 8) Profil 10 mit Führungssteg, Stahl galvanisch verzinkt		
87013.015	Muttern für T-Nuten, (M 6/M 8) Profil 10 mit Feder, Stahl galvanisch verzinkt		
87014.011	Hammermuttern für T-Nuten, (M 5/M 6) Profil 8, niedrige Form, Stahl galvanisch verzinkt		
87014.012	Hammermuttern für T-Nuten, (M 5/M 6) Profil 8, hohe Form, Stahl galvanisch verzinkt		
87015.011	Hammermuttern für T-Nuten, (M 6/M 8) Profil 10, niedrige Form, Stahl galvanisch verzinkt		

Anwendungsbereiche

Bodenbefestigungen

Lindapter ist bei der Entwicklung dieser Produktgruppe wiederum dem Motto gefolgt, Verbindungselemente zu schaffen, die ohne Schweißen oder Bohren montiert werden können. Das Besondere bei diesen Produkten ist aber der weitere Vorteil, dass die Montage ausschließlich von oben erfolgen kann. Damit ergibt sich eine zusätzliche Kostenersparnis.

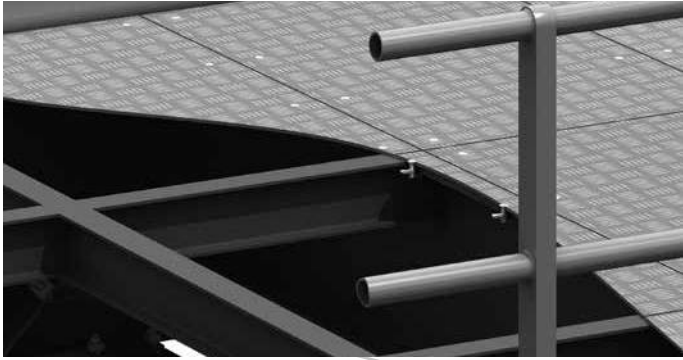

Hohlprofilbefestigungen

Dübelartiges Verbindungselement für Hohlprofile, Rohre und andere rückseitig schwer zugängliche Konstruktionen.

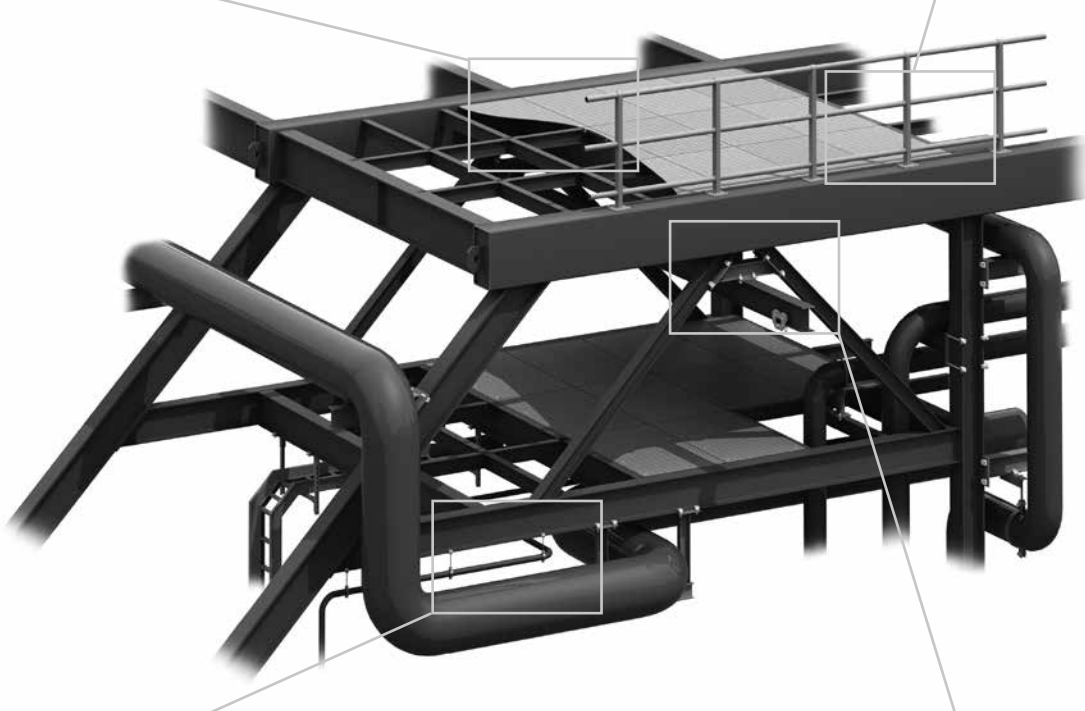
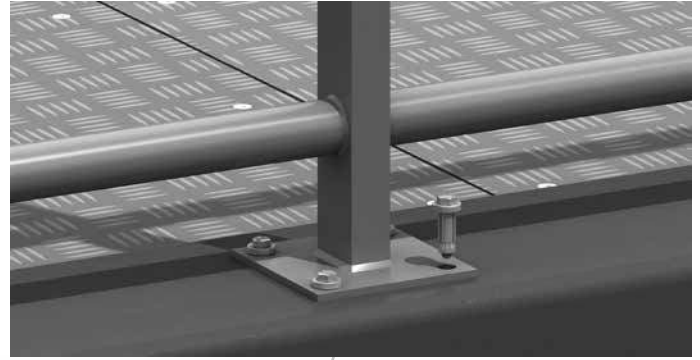

Abhängungen

Für Abhängungen von Kabelkanälen, Rohren, Heizungs-, Lüftungs- und Klimaanlage hält Lindapter eine Palette unterschiedlicher Klemmen bereit. Lindapter hat für diese Anwendungen Produkte entwickelt, die mit ihren außergewöhnlichen Eigenschaften die Montage besonders vereinfachen und damit die Montagekosten deutlich senken.



Trägerklemmverbindungen

Lindapter Trägerklemmverbindungen sind ein System aus Klemmen und genormten Schrauben, die Trägerprofile flexibel, ohne Schweißen oder Bohren schnell und dauerhaft verbinden. Weltweit hat sich das System in Neukonstruktionen und Bauen im Bestand bewährt.

Bestandteile einer Kreuzverbindung

- 1. Muttern**
Nach DIN 934 (ISO 4032), Festigkeitsklasse 8
- 2. Unterlegscheiben**
Nach DIN 125 (ISO 7089)
- 3. Lindapter-Klemmen**
Je nach Anwendung können unterschiedliche Typen zum Einsatz kommen, wie z.B.: A, B, BR, AF, LR, LS, D2 oder D3.
- 4. Unterlegteile**
In Kombination mit o.g. Klemmen dienen diese Teile zur Erweiterung der Nockenhöhe (Klemmlänge) auf die gegebenen Flanschdicken der Träger.
- 5. Zwischenplatte**
Sie ist ein wesentlicher Bestandteil der Kreuzverbindung und gewährleistet, dass die Einzelteile in der korrekten Position gehalten werden. Die Abmessungen sind abhängig von den Lindapter-Typen, Trägern und Belastungen.
- 6. Lindapter-Klemmen**
Wie Nr. 3.
- 7. Sechskantschrauben**
Nach DIN 931 (ISO 4014) oder DIN 933 (ISO 4017), Festigkeitsklasse 8.8

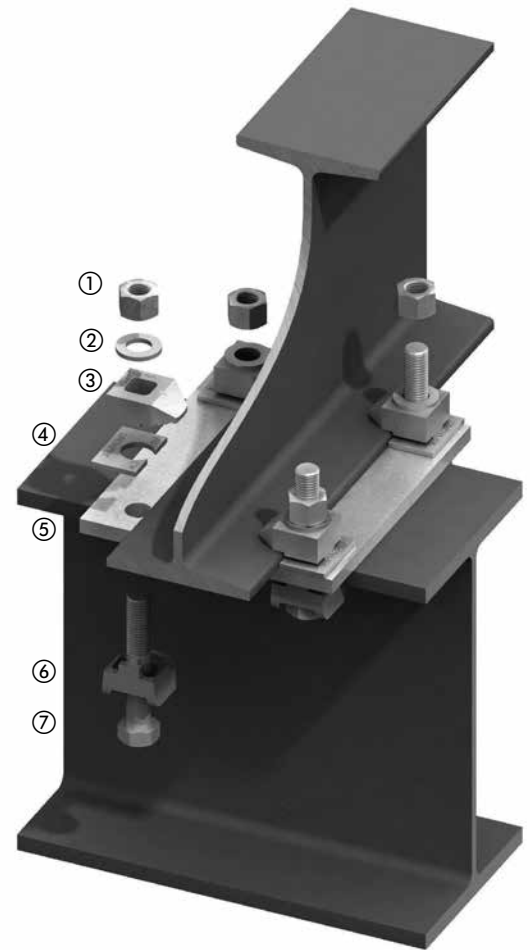

Belastungswerte

Die untenstehende Tabelle zeigt die zulässigen Belastungen für Zug und Schub einer Standard-Kreuzverbindung mit 4 Schrauben und den 8 Lindapter Klemmen. Lindapter erstellt für jede Kreuzverbindung eine Stückliste auf der Basis folgender kundenseitiger Angaben:

- Belastung pro Verbindung
- Trägerbezeichnungen
- Flanschbreiten
- Flanschdicken
- Kreuzungswinkel
- Neigungswinkel

Klemmen Typ A, B und LR			
Schraube (Festigkeitsklasse 8.8)	Zulässige Belastung (5:1 Sicherheitsfaktor)		Anziehmoment* Nm
	Zug / 1 Schraube kN	Zug / 2 Schrauben kN	
M 8	1,0	–	6
M 10	1,5	–	20
M 12	4,5	0,9	69
M 16	8,5	1,7	147
M 20	13,2	2,6	285
M 24	19,0	3,8	491

*Schrauben und Mutter ungeschmiedet

Klemmen Typ AF und AAF						
Schraube		Zug / 1 Schraube (5:1 Sicherheitsfaktor) kN	Schub / 2 Schrauben (2:1 Sicherheitsfaktor)		Anziehmoment	
Ø	Festigkeitsklasse		Träger gestrichen kN	Träger verzinkt kN	unge- schmiedet Nm	HV Garnitur* Nm
M 12	8.8	8,5	3,4	3,9	90	–
M 16	8.8	16,0	8,0	10,0	240	–
M 20	8.8	26,3	13,0	16,0	470	–
M 24	8.8	40,0	24,0	30,0	800	–
M 12	10.9	10,0	4,0	5,2	130	100
M 16	10.9	19,5	11,0	12,0	300	250
M 20	10.9	30,0	20,0	25,0	647	450

*K-Klasse K1

Hinweis:

In den zulässigen Belastungen sind Sicherheitsfaktoren für Schub gegen Verrutschen und für Zug gegen Bruch berücksichtigt. Eine Herabsetzung des angegebenen Sicherheitsfaktors wird von Lindapter nicht empfohlen.

Zulassungen











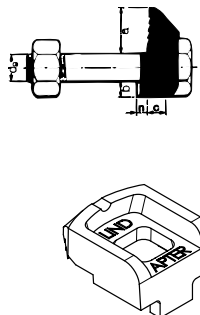

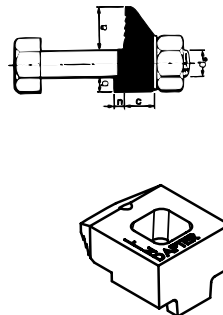

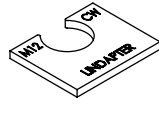
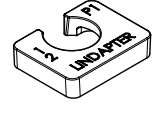

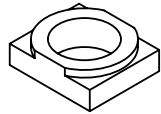
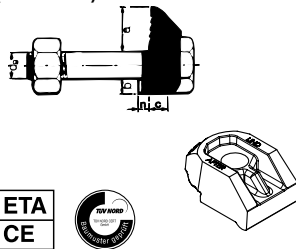
Die Lindapter Kreuzverbindung bestehend aus den Typen A und B in den Größen M 12 bis M 24 und sind als Bauprodukt über ETA-13/0300 zugelassen.

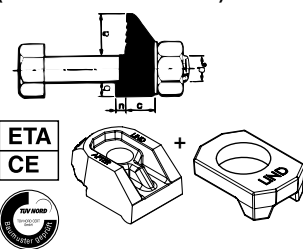
Für die Anwendung der Kreuzverbindung bei dynamischen Belastungen (z.B. Kranbahnen) sind die entsprechenden Berechnungsvorschriften dem Zulassungsbescheid zu entnehmen.

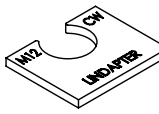
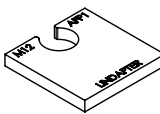

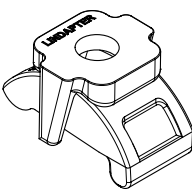
Weitere Detailinformationen können Sie dem Lindapter-Katalog entnehmen. Diesen können Sie unter www.lindapter.de downloaden.

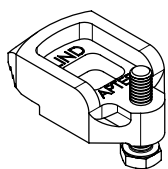

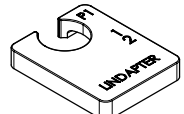
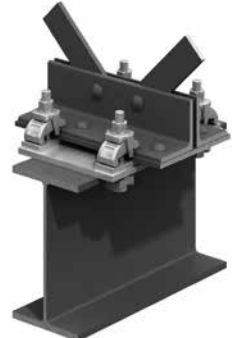
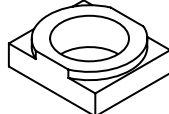





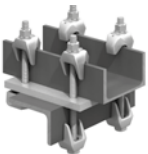
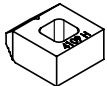
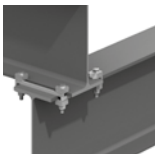
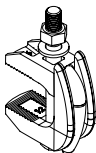

Trägerklemmverbindungen

Typ A und B		Zubehörteile für Typ A und B		Anwendungsbeispiele
<p>Typ A (R 82001)</p>  	<p>Typ B (R 82002)</p>  	<p>Typ CW (R 82011)</p> 	<p>Typ P1k/P2k (R 82012/82013)</p> 	  <p>Klemme für statische und dynamische Lasten mit Verdrehsicherung und Ausgleich von Flanschneigungen bis 8°</p>
		<p>Unterlegscheiben zum Ausgleich unterschiedlicher Flanschdicken</p>		
		<p>Typ W (R 82021)</p> 		
		<p>Einlegeteil zum Ausfüllen der Vertiefung bei Typ A</p>		
Trägerklemme Typ AF	Zubehörteile für Typ AF			Anwendungsbeispiele
<p>Typ AF (R 82040)</p>  	<p>Typ AF + AFW (R 82040 + R 82041)</p>  	<p>Typ AFCW (R 82042)</p> 	<p>Typ AFP1/AFP2 (R 82043/82044)</p> 	 <p>Klemme für hohe Schublasten mit Verdrehsicherung und Ausgleich von Flanschneigungen bis 10°. Typ AF wird bevorzugt kombiniert mit Typ CF.</p>
		<p>Unterlegscheiben zum Ausgleich unterschiedlicher Flanschdicken</p>		
Trägerklemme Typ LR und D2	Zubehörteile für Typ LR und D2			Anwendungsbeispiele
<p>Typ LR (R 82010)</p>  	<p>Typ D2 (R 82007)</p>  	<p>Typ P1L/P2L (R 82015/82016)</p> 		 <p>Typ LR Flexible zweiteilige Klemme mit stufenlosem Klemmbereich mit Verdrehsicherung. Ausgleich von Flanschneigungen bis 15°.</p> <p>Typ D2 Klemme mit Stellschraube für stufenlosen Klemmbereich mit Verdrehsicherung. Ausgleich von Flanschneigungen bis 5°.</p>
		<p>Unterlegscheibe zum Ausgleich unterschiedlicher Flanschdicken</p>		
		<p>Typ W (R 82021)</p> 		
		<p>Einlegeteil zum Ausfüllen der Vertiefung bei Typ D 2</p>		







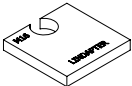



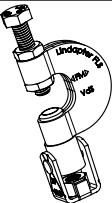

(R = Artikelnummer)

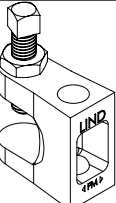
Informationen zur Auslegung und Belastung finden Sie im Lindapter-Katalog. Diesen können Sie unter www.lindapter.de downloaden.



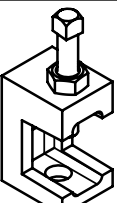
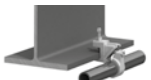
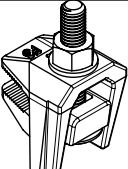

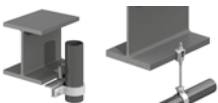
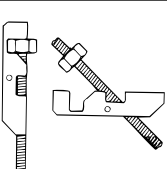

Trägerklemmverbindungen - Spezialklemmen

<p>Typ CF (R 82045)</p>    <p>Bevorzugt mit Typ AF kombinierbar. Dieser Typ hackt sich um die Flanschseite der Profile.</p>	<p>Typ BSNT (R 82003)</p>   <p>Spezialklemme für die Montage von Trägern – Flansch auf Flansch. Die Zwischenplatte wird durch einen Flachstahlrahmen ersetzt, der an die Klemme angeschweißt wird.</p>	<p>Typ F9 (R 82009)</p>    <p>Flanschklemme für parallel verlaufende Träger mit gleicher Breite. Nicht für Schrägflanschträger geeignet.</p>	<p>Typ BR (R 82048)</p>  <p>Zubehörteile Typ CW/P1K/P2K</p>  <p>Vielseitig einsetzbare Klemme für Schienenprofile und Stahlträger. Hohe Sicherheit durch Verdreh-sicherung am Trägerflansch. Geeignet auch bei Langlöchern. Flanschneigungen bis zu 8° möglich.</p>	<p>Typ LS (R 82046)</p>    <p>Zubehörteile Typ LSP2 (R 82047)</p>  <p>Flexible einteilige Klemme mit stufenlosem Klemmbereich. Hohe Sicherheit gegen Verdrehen am Trägerflansch durch gezahnte Nocken. Breiter Nocken ermöglicht die Anwendung auch bei Langlöchern. Flanschneigungen bis zu 10° möglich.</p>
--	---	--	--	---

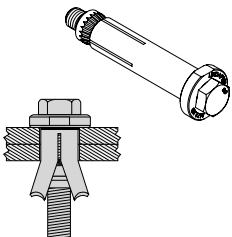

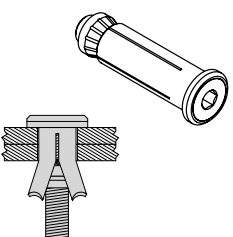
Abhängungen

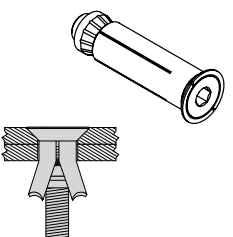
<p>Typ FLS (R 82068)</p>     <p>Trägerklammer mit Gelenk zum Einsatz an parallelen und geneigten Flanschen</p>	<p>Typ FL (R 82008/ 82058)</p>     <p>Trägerklammer für parallele und geneigte Flansche mit Durchgangslöcher oder Anschlussgewinde</p>	<p>Typ LC (R 82025)</p>   <p>Trägerklammer für parallele und geneigte Flansche mit Anschlussgewinde parallel und senkrecht zur Stellschraube</p>	<p>Typ F3 (R 82022)</p>    <p>Zweiteilige Flanschklemme mit großem Klemmbereich zum Einsatz an parallelen Flanschen.</p>	<p>Typ TC (R 82024)</p>   <p>Kippschrauben für Montage an Hohlraumdecken oder Stahlprofilen</p>
--	--	--	--	--

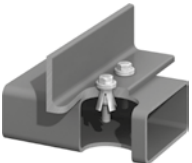
Hohlprofilbefestigung

<p>Typ HB mit Sechskantschraube (R 82031)</p>  	<p>Typ HBCSK mit Senkschraube (R 82031)</p>  	<p>Typ HBFF – Flush Fit (R 82031)</p>  	<p>Anwendungsbeispiele</p>  <p>Dübelartiges Verbindungselement für Hohlprofile, Rohre und andere, rückseitig schwer zugängliche Konstruktionen.</p>
---	--	---	---

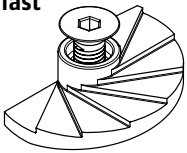
Bodenplattenbefestigung

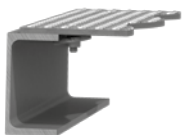
<p>Typ FF – Floorfast (R 82019)</p>   	<p>Exzentrisch abgestufte Klemme zur Befestigung von Bodenplatten. Nach der Vormontage des Floorfast an der Platte ist die Plattenmontage nur von oben erforderlich. Beim Festziehen dreht sich die Klemme automatisch in die richtige Position. Lloyds hat die Klemme auf Klemmkraft und Vibration getestet.</p>	<p>Anwendungsbeispiele</p> 
---	---	---

(R = Artikelnummern)

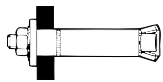

Bei der Auswahl des richtigen Dübels oder Ankers für die unterschiedlichen Einsatzzwecke sind einige wichtige Faktoren zu beachten – hierzu nachfolgend einige Auswahlhilfen:

1. Der Baustoff (Verankerungsgrund):

Dübel und Anker können immer nur soviel Last aufnehmen, wie der Verankerungsgrund halten kann.

Befestigungstechnik bietet aus den Sortimenten der bewährten Markenfabrikate FISCHER und UPAT für jeden Einsatzzweck die technisch richtige und kaufmännisch wirtschaftliche Lösung an.

Der Baustoff muss bei Reibschluss-Wirkung (→ Abs. 2) die Spreizkraft des Dübels oder Ankers ohne Zerstörungen aufnehmen können. (Zugelassene Dübel/Anker für den jeweiligen Baustoff → Tabelle 6)

Tabelle 1: Verankerungsgrund nach Baustoffgruppen

Beton		Mauerwerk				Platten/Tafeln
Normal-Beton B 15 – B 55 C 15/20 – C 50/55	Leicht-Beton LB 10 – LB 55 z.B. Bims-/ Bläh-/Poren- (Gas)-Beton	Vollstein dichtes Gefüge z.B. Vollziegel (MZ)/ Kalksand- Vollsteine (KS)	Lochstein dichtes Gefüge z.B. Hochlochziegel Kalksand- Lochsteine (KSL)	Vollstein poriges Gefüge z.B. Porenbeton (G) Leichtbeton (V)	Lochstein poriges Gefüge z.B. Hochlochziegel Leichtbeton-Hbl	Gipskarton-/ Span-/ Holzfaser-/ Faserzement- Platten
BN	BL	VD	LD	VP	LP	HP

2. Die Wirkungsweise (Lastverankerung im Baustoff)

Dübel und Anker werden nach ihrer Krafteinleitung in den Verankerungsgrund in drei Gruppen unterschieden.

Die Art dieser Tragmechanismen ist mitentscheidend für Verankerungsgrund, Belastbarkeit, Rand- und Achsabstände.

Tabelle 2: Arten der Krafteinleitung von Dübeln und Ankern im Baugrund

Krafteinleitung:	Reibschluss (Kraftschluss durch Spreizung)	Stoffschluss (spreizdruckfrei)	Formschluss (spreizdruckfrei)
Tragmechanismus:	Anpressdruck der Spreizteile an der Bohrlochwandung = Reibung > Zuglasten	Klebe-/Verbundmörtel verbindet sich mit Anker und Verankerungsgrund	Dübelform oder Anker-Teil-Form passt sich Bohrlochgestaltung an
Dübel-/Anker-Arten:	Sprezdübel aus Kunststoff Spreizanker aus Metall	Verbund-/Reaktion-Anker Injections-Anker	Hohlraumdübel Zykon-Anker

3. Der Einsatzbereich (Druckzone oder Zugzone?)

Beim Einsatz von Schwerlast-Dübeln/-Ankern in Beton ist entscheidend, ob die Verankerung im Bereich einer nachgewiesenen Druckzone (dauernd ungerissener Beton) oder in einer Zugzone (rissneigender/gerissener Beton) erfolgt.

Zugzonen mit V-förmigen Biegerissen bilden sich im Beton z.B. durch Eigengewicht und Verkehrslasten unterhalb von Decken. Für diesen Einsatzbereich sind nur Riss-/Zugzonen-taugliche Dübel und Anker zugelassen. Andere Dübel und Anker sind nur für nachgewiesene Druckzonen zugelassen.

(Zugzonentaugliche Dübel und Anker → Tabelle 5)

4. Die Verankerungs-Position

Dübel und Anker mit großem Spreizdruck und hohen Lasten können bei jedem Verankerungsgrund zum Spalten- oder Betonkantenbruch des Bauteils führen – besonders bei schmalen/flachen Bauteilen.

Zur Verhinderung dieser ungewollten Schäden sind den Dübeln und Ankern nach ihrer Wirkungsweise, ihren Dimensionen und nach Belastungsgrößen

- Mindest-Bauteildicken
- Randabstände
- Achsabstände (bei Dübeln/-gruppen)
- Mindest-Verankerungstiefen/Einbau-Längen (→ Abs. 7) in den jeweiligen Zulassungen (→ Abs. 9) zugeordnet.

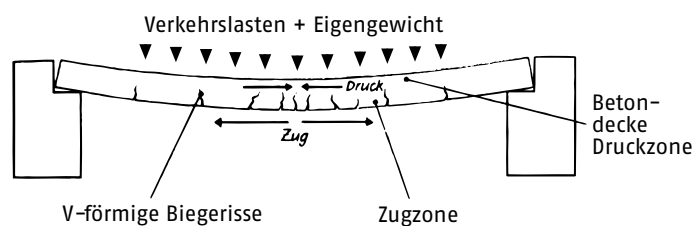

Im Zweifelsfall ist es empfehlenswert, Zugzonen-zugelassene Dübel und Anker einzusetzen.

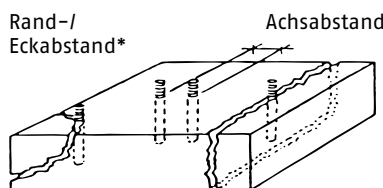

Unverbindliche Richtwerte:
 Randabstand $\geq 2 \times$ Mindest-Verankerungstiefe
 Achsabstand $\leq 4 \times$ Mindest-Verankerungstiefe
 (Im Einzelfall sind die Angaben der Zulassung zu beachten)

Randabstand*
 (* hier ist zugleich der Brucheffekt aufgrund zu kleiner Abstände gezeigt)



5. Die Belastbarkeit

Die zulässige Last (F) pro Dübel oder Anker wird – neben den in 1 – 4 behandelten Kriterien – beeinflusst durch:

- a) Dübel-/Anker-Dimensionierung, Einbautiefe, Abstände
 - b) Werkstoff-/Festigkeitsklasse des Dübels/Ankers und des Bauteiles, in das die Lasten eingeleitet wurden
 - c) Bauteildicke, Last-Angriffspunkt, Lastart (Zug, Schrägzug, Druck, Querkraft, Biegung)
 - d) Sicherheitsbeiwerte, Angaben in den Zulassungen
- zu a) Basis für die Berechnung ist die Größe des tatsächlich tragenden Gewindeteiles (Nennmaße beziehen sich z.T. auf Außen-/Hülsen- oder Bohrer-Ø)
- zu b) Basis für die Werte in Zulassungen/vom Hersteller gelten für die jeweilige Lieferform – z.B. Stahl, 8.8 oder nichtrostender Stahl A2/A4



6. Der Korrosionsschutz

Für die Bestimmung des richtigen Schutzes von Befestigungselementen gegen die verschiedenen Korrosionsarten gilt der Grundsatz: Das „Korrosionssystem Dübel-/Anker-Befestigung“ muss mindestens so fest, dauerhaft und unter Einsatzbedingungen langfristig korrosionsbeständig sein wie die zu befestigenden Teile.

Es ist die Aufgabe der konstruktiven Planung, die erforderlichen Korrosionsschutzmaßnahmen zu bestimmen:

Hierbei ist der Abnutzungsvorrat des Korrosionsschutzes unter bekannten Betriebsbedingungen bis zum Wartungszeitpunkt bzw. bis zur Schadensgrenze zu berücksichtigen. Oberflächen- oder werkstofftechnische Vorgaben sind im Artikel-Bestelltext entsprechend festzulegen.

Tabelle 3: Überblick über oberflächen- und werkstofftechnische Korrosionsschutzmöglichkeiten

Lieferzustand/ Korrosionsschutz	Beanspruchungsgrad/ Schutzwirkung	Einsatzbereich	Anmerkungen
Stahl galvanisch verzinkt Schichtdicke ~ 5–8 mm	I – II = mild – mäßig	geschlossene, trockene Innenräume	
Stahl feuerverzinkt (tZn) Schichtdicke ≥ 40 mm	≥ IV = sehr stark	Außenbereich z.B. Masten-/ Leitplanken-Befestigung	wegen nötigem Gewindenspiel nur bei dickeren Dimensionen nicht Bestandteil d. Zulassung
Kunststoff (Nylon)	> IV = sehr beständig	alle atmosphärischen Beanspruchungen	nur spezielle Ausführungen im Angebot
Nichtrostender Stahl A 4 (Werkst. 1.4401/ 1.4571) 	> IV = sehr beständig	allg. atmosphärische Beanspruchungen hinterlüftete Fassaden/Dächer Seewasser/Meeresluft	nicht für chlorhaltige Atmosphäre (Gefahr von Lochfraß/Spannungsrissskorrosion)
Nichtrostender Stahl Werkst. 1.4529 	> IV = sehr beständig	spez. Hallenbäder, Tunnel, Parkgaragen, Meerwasserbereich	spez. f. Bereiche mit hoher Chlor-/Chloridbelastung

7. Die Klemmlänge – die Einbaulänge

Einbaufertige Komplett-Dübel-/Anker für Durchsteckmontagen sind in der Gesamtlänge unterteilt in:

- **Klemmlänge** („Nutzlänge“, „Klemmstärke“, „Klemmdicke“) $d_a/t_{fix}/d_p + t_{fix}$
Diese muss mindestens so groß gewählt sein wie die Gesamtdicke der zu befestigenden Montageteile + nichttragender Baustoffschichten (Putz)
– bei Abstandsmontagen + Abstand
- **Einbaulänge/Verankerungslänge h_{ef}**
Diese muss als Mindest-Verankerungstiefe im voll tragenden Baustoffbereich eingebaut sein.
Belastungswerte gelten nur bei richtiger Einbautiefe! Siehe auch Montageanleitung

8. Die Montage

Dübel und Anker können nur dann ihre geplante Aufgabe erfüllen, wenn sie fachgerecht montiert werden.

Vom Planer werden für die Montage vorgegeben:

- Typ, Ausführung und Abmessung des Dübels/Ankers
- Rand- und Achsabstände am Bauteil
- Spezielle Vorgaben der bauaufsichtlichen Zulassung

Die Klemm-/Nutz-Längen und die Einbau-Längen/-Tiefen sind zu den entsprechenden Dübeln und Anker im Katalog angegeben.

Zur richtigen Montage sind zu beachten:

- Die Vorgaben des Planers entsprechend Absätzen 1 – 7
- Bohrverfahren und Bohrer (→ 8.1 Tabelle 4)
- Bohrloch-Ø/-Tiefe (→ Montageanleitung des Herstellers)
- Bohrlochreinigung (→ 8.2)
- Montageart (→ 8.3)
- Mindest-Verankerungstiefe/Klemmlänge (→ 7)

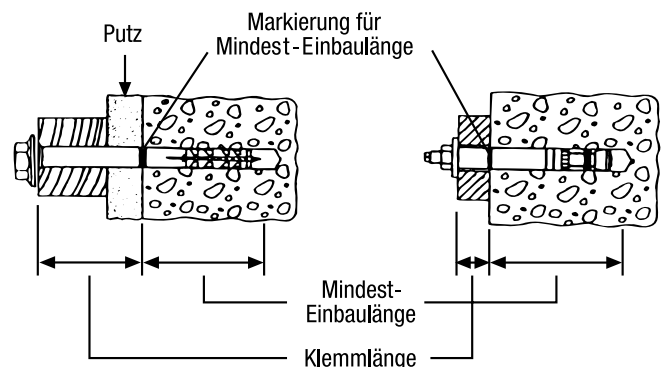

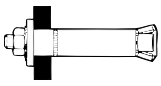

8.1 Übersicht Bohrer und Bohrverfahren

Tabelle 4:

Verankerungsgrund	Bohrer	Bohrverfahren	Maschine	Anmerkungen
Beton \geq B 25/C20/25	Hammerbohrer	Dreh-/Hämmer-Bohren kleine Hämmerzahl u. hohe Hämmerenergie	Bohrhammer	für sehr große Bohrloch- \varnothing oder bei starker Be- wehrung ggf. Diamant-/ Kernbohrverf.
	B 15/C12/15	Steinbohrer	Schlagbohren	–
Vollbaustoffe mit dichtem/festem Gefüge	Steinbohrer Hammerbohrer	Schlagbohren Dreh-/Hämmer-Bohren	Schlagbohrmaschine Bohrhammer	je nach Bauteil-Dicke und Bauteil-Stabilität
Leichtbaustoffe mit geringer Festigkeit (Poren-/Leicht-Beton)	Steinbohrer	Drehbohren ohne Schlag	Bohrmaschine	
		Schlagbohren	Schlagbohrmaschine	darauf achten, dass das Bohrloch nicht zu groß wird und bei Loch-/ Hohlblocksteinen die Stege nicht ausbrechen
Lochsteine	Steinbohrer	Drehbohren ohne Schlag	Bohrmaschine	
Platten: Gipskarton/ Faserzement	Steinbohrer			
	Span-/Holz-/ Holzfaserplatten			

8.2 Bohrlochreinigung

Da Bohrmehl keinen Halt bieten kann oder den Raum eines Hinterschnittes blockiert, müssen alle losen Elemente aus dem Bohrloch entfernt werden, bevor Dübel oder Anker gesetzt werden – z.B. durch Ausblasen, Aussaugen.

8.3 Montagearten (→ Bild 1)

- 8.3.1 Die **Durchsteckmontage** ist für Serienmontagen und Dübelpaare meistens am einfachsten, da häufig die Durchgangslöcher des Bauteiles als Bohrlehre verwendet werden können.
- 8.3.2 Bei der **Vorsteckmontage** ist das Bohrloch passgenau anzureißen. Innengewinde-Anker schließen bündig mit der Baustoffoberfläche ab.
- 8.3.3 Bei der **Abstandsmontage** werden Vorsteck-Innengewinde- oder Verbund-Anker verwendet, die einen ausreichend langen Bolzenüberstand haben, oder es wird mit passend langer Schraube befestigt.

8.4 Anziehungsmomente/Montagevorspannkkräfte

Die zu den verschiedenen Fabrikaten und Typen geltenden Werte werden vom Konstrukteur aus der Zulassung vorgegeben. Richtwerte siehe auf der Verpackung oder in der Packungsbeilage.

8.5 Schlüsselweiten

Für einbaufertige Dübel und Anker sind die SW-Maße auf der Verpackung/in der Packungsbeilage angegeben. Für Normschrauben, die zur Befestigung bei z.B. Innengewinde-Ankern eingesetzt werden, gelten die für DIN- oder ISO-Schrauben genormten SW-Maße.

9. Die Zulassungen

Für Befestigungen und Verankerungen, bei deren Versagen Gefahr für die öffentliche Sicherheit sowie für Leib und Leben anderer besteht, dürfen grundsätzlich nur Dübel und Anker verwendet werden, die über eine der vorgesehenen Verwendung zugeordnete Zulassung verfügen. Allgemeine bauaufsichtliche Zulassungen erteilt nach Typenprüfung das Deutsche Institut für Bautechnik, Berlin (DIBT). Spezielle Zulassungen für besondere Einsatzbereiche erteilen die dafür benannten Institute oder die Prüfstellen der einschlägigen Fachverbände. Für Dübel und Anker mit CE-Zeichen ist die Erteilung einer „Europäischen Technischen Zulassung“ (ETA) erforderliche Voraussetzung.

Bild 1



Tabelle 5: Übersicht der z. Zt. gültigen Zulassungsarten

Europäische Zulassungen	
	<p>Bauprodukte mit CE-Zeichen dürfen im EU-Wirtschaftsraum frei gehandelt werden. Eine der Voraussetzungen für das CE-Zeichen bei Dübeln ist die vorangegangene Erteilung einer europäischen technischen Zulassung = ETA.</p> <p>ETA-Zulassungen sind nach Einsatz der Dübel gegliedert in die Optionen 1–6 für gerissenen Beton und 7–12 für ungerissenen Beton.</p> <p>Die Zulassung erfolgt auf der Grundlage der</p> <ul style="list-style-type: none"> • ETAG 001-1, -2, -3, -4 (künftig EAD 33-0232), • ETAG 001-5 (künftig EAD 33-0499) oder • ETAG 001-06 (künftig EAD 33-0747)

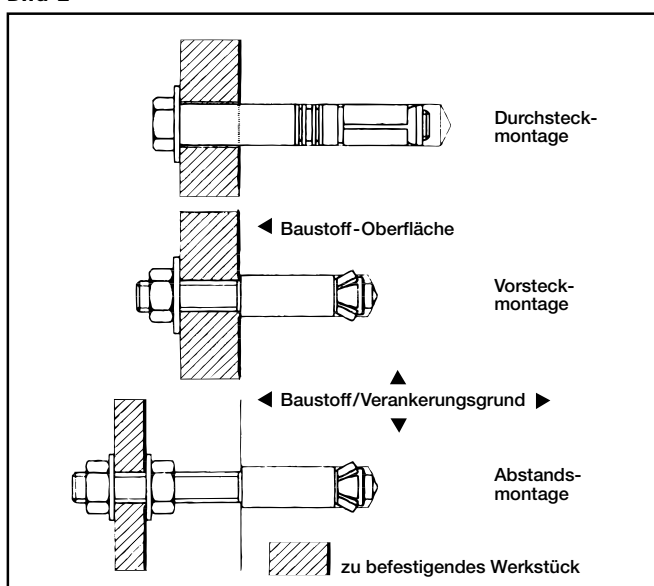

Übersicht alternative Dübel-/Anker-Typen verschiedener Fabrikate

Allgemeine Befestigungen

Artikel	fischer	Upat	Sormat	TOX	Hilti	Würth	MKT	Mungo	Mea
88554	SX			AS-K/TRI/TRIKA	HUD-1			MQ	FX
88500	S	U		AS-K/TRI/TRIKA		master		MN	F
88520, 88381-383	UX	UVD II	L4 KA/L4 A	AS-K/TRI/TRIKA	HUD-1	W-ZX	UD	MU	MZ/MZK
88507	GB			YTOX	HGN	W-GB			GB
88545	FMD	UMA	4 M	MKD		W-MG		MEF	MSD
88510	M								
88506	M-S								
88521	PA 4								

Schwerlast-Befestigungen-Stahlanker

88583-589	FZA		BLS, SLS, SLKS, ILS		HSC				
88597	FZEA II								
88561/88741	FAZ II	MAX	BoA-X	S-FIX	HST 3			m3	BAZ/BZ
88590-594	FH II		B/S/SK/AB/AS	SZ	HSL-3	W-HAZ-S	SZ	HL	SWA
88582/88764	FBN II	IMC	BoA	S-FN	HSA	W-FA	B	m2	BA/BAN
88715	EXA		BoA	S-KA				m2	BA/BAN
88513	FHY				HKH	W-HD	Easy	MHDA	
88683	TA-M				HAM	W-TM	SL		
88567	EA II			E	HKD	W-ED	E	ESA	SA/SA-N
88546-549	FNA II		T-DN	TDN	HK	W-NA	N	MAN	MDA L
-	FDN				DBZ	W-DN	TDN		
88531	MR								
88688	FPX-I				HPD	W-PA			
-	FBS								

Schwerlast-Befestigungen-Chemie

88579	FHB II				HVU-TZ				
88686	FIS SB				HIT-HY 200A				
88579	FHB II PF				HVU-TZ				
88687/88534/88720-722	RSB/RGM	UKA 3, ASTA	KLS/KLP	TVA	HVU2/HAS	W-VD	V-P/VMU-A	MVA	VA
88522/88733	FIS V360S	UPM 44		TVM-STV/STP		WIT-VM 250	VMU plus	MIT-SE	MIS-V-V
88522, 88774, 88775	FIS V/VL	UPM 33, UPM 11				WIT-PM 200	VMU		
88522/88772	FIS EM	UPM 55				WIT-PE 500	VME		
88579	FHB dynamik				HAS-TZ	W-VIZ-A	VMZ-A dyn.		

Hohlraum-Befestigungen

88512	HM	UH		MHD	HHD	W-MH		MHD-S	HR/HRM
88509, 88518/519	K/KD/KDH/KM			Kippdübel	EFD/KD	W-FK /W-KD		MF/MK	FKS/FK-KS
88598	GK		LGK	GDK		W-GS Typ K		MFJ	GKD
88598	GKM			GD 37	HSP	W-GS Typ ZD	GKD	MJP	GKDZ

Langschafdübel/Fassandendübel/Abstands-Befestigungen

88542, 88782	SXR	UDR			HRD	W-UR		MBR-X	R
88551	SXRL	UDRL			HRD	W-UR			
88504	SXS			SDF	HRD	W-UR		MBR	R
88563-564	FUR			SDF	HRD-U	W-UR			
88503	N	UN	LNS/LNZ	LSN /MSB-LSN	HPS-1	W-ZND	ND	MNA	NP
88515	JUSS			JS-S				MJB	JS
88516	F-S								FR

Gerüstbefestigungen

88536	S14ROE + GS 12							MGD + MGv	GR + ÖS
-------	----------------	--	--	--	--	--	--	-----------	---------

Dämmstoff-Befestigungen

88514	DHK			DH	HIF	W-IN		MDS,MDP,MIS MIP	DSH
-------	-----	--	--	----	-----	------	--	-----------------	-----

Hinweis: Diese Übersicht ist unverbindlich. Eine finale Prüfung der Anwendbarkeit und Zulassungen obliegt dem Anwender.

Schwerlast-Befestigungen – Chemie

Artikel 88579 FHB II-P/PF

FISCHER Mörtelpatronen FHB II-P/PF

Baustoffe: BN

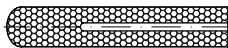

ETA-05/0164

Zur Verwendung mit Bolzen FHB-A.
Aushärtezeiten nach Packungsangabe
beachten!

PF = schnell aushärtend

Maße	8x60	10x60	10x75	10x95	12x75	12x100	12x120	16x95
d_0	10	10	10	12	12	14	14	16
$h_0 = t$	75	75	90	110	90	115	135	110
h_{ef}	60	60	75	95	75	100	120	95
passend zu	FHB II-A L	FHB II-A S	FHB II-A S	FHB II-A L	FHB II-A S	FHB II-A L	FHB II-A L	FHB II-A S

Maße	16x125	16x145	16x160	20x170	20x210	24x170	24x210
d_0	18	18	18	25	25	25	25
$h_0 = t$	145	165	175	190	235	190	235
h_{ef}	125	145	160	170	210	170	210
passend zu	FHB II-A L	FHB II-A L	FHB II-A L	FHB II-A S	FHB II-A L	FHB II-A S	FHB-A L

Verfügbare Abmessungen auf den folgenden Seiten:

Befestigungstechnik: [S. 662](#)

Artikel 88579 FHB II-A L

FISCHER Highbond-Anker FHB II-A L

Baustoffe BN

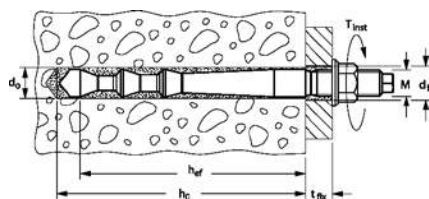
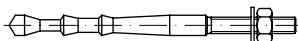

ETA-05/0164

Maße	M 8x60/10	M 8x60/30	M 8x60/50	M 10x95/10	M 10x95/20
d_0	10	10	10	12	12
$h_0 = t$	75	75	75	110	110
h_{ef}	60	60	60	95	95
t_{fix}	10	30	50	10	20
Gewinde	M 8	M 8	M 8	M 10	M 10
SW	13	13	13	17	17

Maße	M 10x95/40	M 10x95/60	M 10x95/100	M 12x100/10	M 12x100/25
d_0	12	12	12	14	14
$h_0 = t$	110	110	110	115	115
h_{ef}	95	95	95	100	100
t_{fix}	40	60	100	10	25
Gewinde	M 10	M 10	M 10	M 12	M 12
SW	17	17	17	19	19

Maße	M 12x100/40	M 12x100/60	M 12x100/100	M 12x120/10	M 12x120/25
d_0	14	14	14	14	14
$h_0 = t$	115	115	115	135	135
h_{ef}	100	100	100	120	120
t_{fix}	40	60	100	10	25
Gewinde	M 12	M 12	M 12	M 12	M 12
SW	19	19	19	19	19

Maße	M 12x120/40	M 12x120/60	M 12x120/100	M 16x125/30	M 16x125/60
d_0	14	14	14	18	18
$h_0 = t$	135	135	135	140	140
h_{ef}	120	120	120	125	125
t_{fix}	40	60	100	30	60
Gewinde	M 12	M 12	M 12	M 16	M 16
SW	19	19	19	24	24

Maße	M 16x125/100	M 16x145/30	M 16x145/60	M 16x145/100	M 16x160/30
d_0	18	18	18	18	18
$h_0 = t$	140	160	160	160	175
h_{ef}	125	145	145	145	160
t_{fix}	100	30	60	100	30
Gewinde	M 16	M 16	M 16	M 16	M 16
SW	24	24	24	24	24

Maße	M 16x160/60	M 16x160/100	M 20x210/50	M 20x210/150	M 24x210/50
d_0	18	18	25	25	25
$h_0 = t$	175	175	235	235	235
h_{ef}	160	160	210	210	210
t_{fix}	60	100	50	150	50
Gewinde	M 16	M 16	M 20	M 20	M 24
SW	24	24	30	30	36

Zur Verwendung mit Patronen FHB II-P

Verfügbare Abmessungen auf den folgenden Seiten:

Befestigungstechnik: [S. 664](#)

Schwerlast-Befestigungen - Chemie

Artikel 88579 FHB II-A S

FISCHER Highbond-Anker FHB II-A S
Baustoffe: BN

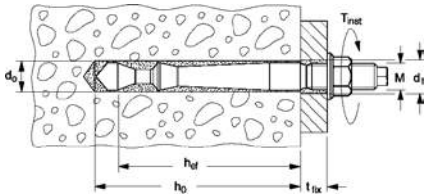
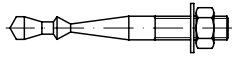

ETA-05/0164

Zur Verwendung mit Mörtelpatronen
FHB II-P und FHB II-PF

Maße	M 10x60/10	M 10x60/20	M 10x60/40	M 10x60/60	M 10x60/100	M 10x75/10
d ₀	10	10	10	10	10	10
h ₀ = t	75	75	75	75	75	90
h _{ef}	60	60	60	60	60	75
t _{fix}	10	20	40	60	100	10
M	M 10	M 10	M 10	M 10	M 10	M 10
SW	17	17	17	17	17	17
Maße	M 10x75/20	M 10x75/40	M 10x75/60	M 10x75/100	M 12x75/10	M 12x75/25
d ₀	10	10	10	10	12	12
h ₀ = t	90	90	90	90	90	90
h _{ef}	75	75	75	75	75	75
t _{fix}	20	40	60	100	10	25
M	M 10	M 10	M 10	M 10	M 12	M 12
SW	17	17	17	17	19	19
Maße	M 12x75/40	M 12x75/60	M 12x75/100	M 12x75/165	M 16x95/30	M 16x95/60
d ₀	12	12	12	12	16	16
h ₀ = t	90	90	90	90	110	110
h _{ef}	75	75	75	75	95	95
t _{fix}	40	60	100	165	30	60
M	M 12	M 12	M 12	M 12	M 16	M 16
SW	19	19	19	19	24	24
Maße	M 16x95/100	M 16x95/165	M 20x170/50	M 24x170/50		
d ₀	16	16	25	25		
h ₀ = t	110	110	190	190		
h _{ef}	95	95	170	170		
t _{fix}	100	165	50	50		
M	M 16	M 16	M 20	M 24		
SW	24	24	30	36		

Verfügbare Abmessungen auf den folgenden Seiten:
Befestigungstechnik: S. 664

Artikel 88579 FHB-A dyn

FISCHER Highbond-Anker FHB-A dyn
Baustoffe: BN

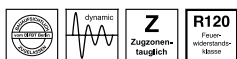
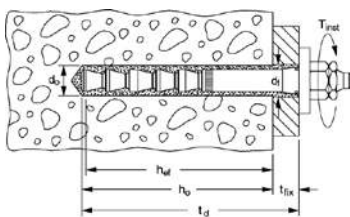
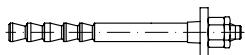

Zur Verwendung mit Injektionsmörtel FIS HB
(Artikel 88578)

Maße	12x100/25	12x100/50	16x125/25
d ₀	14	14	18
t _d	130	155	155
t = h _{ef}	100	100	125
t _{fix}	8 - 25	8 - 50	10 - 25
d ₁	15	15	19
SW	19	19	24
Maße	16x125/50	20x170/50	24x220/50
d ₀	18	24	28
t _d	180	225	275
t = h _{ef}	125	170	220
t _{fix}	10 - 50	12 - 50	14 - 50
d ₁	19	25	29
SW	24	30	36

Verfügbare Abmessungen auf den folgenden Seiten:
Befestigungstechnik: S. 665

Schwerlast-Befestigungen – Chemie

Artikel 88687 RSB

FISCHER Mörtelpatronen RSB

Baustoffe: BN, VD

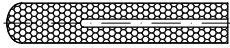

ETA 12/0258

Zur Verwendung mit Ankerstangen RGM.
Aushärtezeiten nach Packungsangaben beachten!

Maße	8	10 mini	10	12 mini	12	
d_0	10	12	12/14	14	14/18	
$h_0 = h_{ef}$	80	75/150	90	75/150	110	
passend zu RGM	M 8	M 10	M 10	M 12	M 12	
passend zu RGM I	-	-	M 8	-	M 10	

Maße	16 mini	16	16 E	20	20 E / 24	30
d_0	18	18/20	24	25	25/28/32	35
$h_0 = h_{ef}$	95/190	125	160	170	210	280
passend zu RGM	M 16	M 16	-	M 20	M 20/24	M 30
passend zu RGM I	-	M 12	M 16	-	M 20	-

Verfügbare Abmessungen auf den folgenden Seiten:

Befestigungstechnik: [S. 662](#)

Artikel 88534 RG M

FISCHER Ankerstangen RG M

Baustoffe: BN, VD

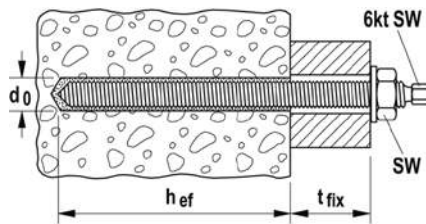
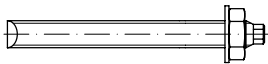

ETA-12/0258

Maße	M 8x110	M 8x150	M 10x110	M 12x120	M 12x180	M 20x220	M 10x130
d_0	10	10	12	14	14	25	12
t_{fix}	14	54	15	21/-/-	81/46/6	-/14/-	35/20
h_{ef}	80	80	75	75/-/-	75/110/150	-/170/-	75/90
SW 6-kant	5	5	7	8	8	12	7

Maße	M 10x165	M 10x190	M 10x220	M 10x250	M 10x350	M 12x160	M 12x220
d_0	12	12	12	12	12	14	14
t_{fix}	70/55	95/80/20	125/110/50	155/140/80	255/240/180	61/26	121/86/46
h_{ef}	75/90	75/90/150	75/90/150	75/90/150	75/90/150	75/110	75/110/150
SW 6-kant	7	7	7	7	7	8	8

Maße	M 12x250	M 12x300	M 12x380	M 16x165	M 16x190	M 16x250	M 16x270
d_0	14	14	14	18	18	18	18
t_{fix}	151/116/76	201/166/126	281/246/206	38/8	63/33	123/93/28	143/113/48
h_{ef}	75/110/150	75/110/150	75/110/150	95/125	95/125	95/125/190	95/125/190
SW 6-kant	8	8	8	12	12	12	12

Maße	M 16x300	M 16x380	M 16x500	M 20x260	M 20x290	M 20x350	M 20x500
d_0	18	18	18	25	25	25	25
t_{fix}	173/143/78	253/223/158	373/343/278	54/14	84/44	144/104	294/254
h_{ef}	95/125/190	95/125/190	95/125/190	170/210	170/210	170/210	170/210
SW 6-kant	12	-	-	12	12	12	-

Maße	M 24x295	M 24x300	M 24x400	M 24x600	M 30x380	M 30x500
d_0	28	28	28	28	35	35
t_{fix}	56	61	161	361	65	185
h_{ef}	210	210	210	210	280	280
SW 6-kant	-	-	-	-	-	-

Zur Verwendung mit Mörtelpatronen RSB (Artikel 88687)

Verfügbare Abmessungen auf den folgenden Seiten:

Befestigungstechnik: [S. 665](#)

Schwerlast-Befestigungen – Chemie

Artikel 88523 FIS A

FISCHER Ankerstangen FIS A

Baustoffe mit Ankerhülse: LD, VD, BN

Baustoffe ohne Ankerhülse: BL, VD, VP

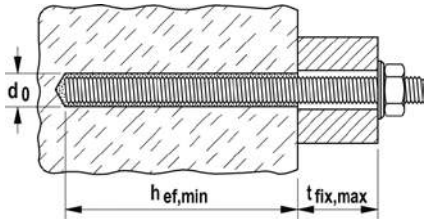

ETA-02/0024

ETA-10/0352

Maße	6x75	6x85	6x110	8x90	8x110	8x130	10x110
d_0 für BN, VD	8	8	8	10	10	10	12
d_0 für LD	12	12	12	12	12/12/16	12/16	16
h_{ef} für BN	-	-	-	60 - 78	60 - 98	60 - 118	60 - 96
h_{ef} für LD	50	50	50/85	50	50/85/85	50/85/85	85
h_{ef} für VD	50	50	50	50	50	50	50
t_{fix} für BN	-	-	-	1 - 19	1 - 39	1 - 59	1 - 37
t_{fix} für LD	16	26	52/17	29	49/14/14	69/34/34	12
t_{fix} für VD	17	27	52	29	49	69	47

Maße	10x130	10x150	10x200	12x120	12x140	12x160	12x180
d_0 für BN, VD	12	12	12	14	14	14	14
d_0 für LD	16	16	16	20	20	20	20
h_{ef} für BN	60 - 116	60 - 136	60 - 186	70 - 103	70 - 123	70 - 143	70 - 163
h_{ef} für LD	85	85/130	85/130	85	85	85/130	85/103
h_{ef} für VD	50	50	50	50	50	50	50
t_{fix} für BN	1 - 57	1 - 77	1 - 127	1 - 34	1 - 54	1 - 74	1 - 94
t_{fix} für LD	32	52/7	102/57	19	39	59/14	79/34
t_{fix} für VD	67	87	137	54	74	94	114

Maße	12x210	12x260	16x130	16x175	16x200	16x250	16x300
d_0 für BN, VD	14	14	18	18	18	18	18
d_0 für LD	20	20	20	20	20	20	20
h_{ef} für BN	70 - 193	70 - 240	80 - 109	80 - 154	80 - 179	80 - 229	80 - 279
h_{ef} für LD	85/130	85/130/200	85	85/130	85/130	85/130/200	85/130/200
h_{ef} für VD	50	50	50	50	50	50	50
t_{fix} für BN	1 - 124	4 - 174	1 - 30	1 - 75	1 - 100	1 - 150	1 - 200
t_{fix} für LD	109/64	169/114/44	25	70/25	95/50	145/100/30	-
t_{fix} für VD	144	194	60	105	130	180	230

Maße	20x245	20x290	24x290	24x380	30x430		
d_0 für BN, VD	24	24	28	28	35		
d_0 für LD	-	-	-	-	-		
h_{ef} für BN	90 - 220	90 - 265	96 - 260	96 - 350	120 - 394		
h_{ef} für LD	-	-	-	-	-		
h_{ef} für VD	-	-	-	-	-		
t_{fix} für BN	1 - 131	1 - 176	1 - 165	1 - 255	1 - 275		
t_{fix} für LD	-	-	-	-	-		
t_{fix} für VD	-	-	-	-	-		

Zur Verwendung mit Injektionsmörtel
FIS SB (Artikel 88686)

Verfügbare Abmessungen auf den folgenden Seiten:

Befestigungstechnik: [S. 665](#)

Schwerlast-Befestigungen - Chemie

Artikel 88529 FIS-E

FISCHER Innengewindeanker FIS-E
Baustoffe: VD

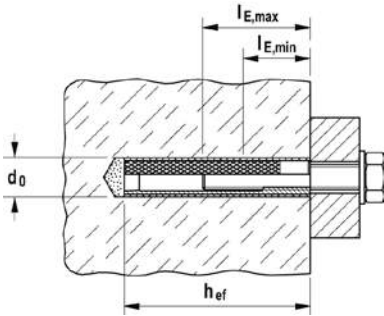

ETA-10/0383
Zur Verwendung mit Injektionsmörtel
FIS-V, FIS-VS und FIS-VW
 l_E = Einschraubtiefe

Maße	11x85	11x85	15x85	15x85
d_0	14	14	18	18
$t = h_{ef}$	85	85	85	85
$l_{E, min.}$	6	8	10	12
$l_{E, max.}$	60	60	60	60
d_s	M 6	M 8	M 10	M 12

Verfügbare Abmessungen auf den folgenden Seiten:

Befestigungstechnik: [S. 666](#)

Artikel 88562 FIS H K

FISCHER Injektions-Ankerhülsen FIS H K
Baustoffe: LP, (VD)

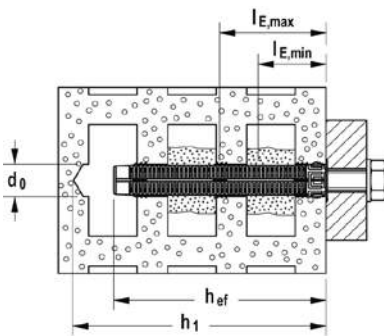

ETA-10/0383
Zur Verwendung mit Injektionsmörtel
FIS-V, FIS-VS und FIS-VW
*max. Anzahl bei Verarbeitung mit
1 Statikmischer

Maße	12x50	12x85	16x85
d_0	12	12	16
h_1	60	95	95
h_{ef}	50	85	85
passend zu	FIS-A (M 6/M 8)	FIS-A (M 6/M 8)	FIS-A (M 8/M 10) FIS-E (M 6/M 8)
Anker pro 360 ml Kartusche*	34	17	14
Maße	16x130	20x85	20x130
d_0	16	20	20
h_1	140	95	140
h_{ef}	110	85	110
passend zu	FIS-A (M 8/M 10)	FIS-A (M 12/M 16) FIS-E (M 10 - M 12)	FIS A (M 12 - M 16)
Anker pro 360 ml Kartusche*	11	11	
Maße	20x200		
d_0	20		
h_1	210		
h_{ef}	180		
passend zu	FIS A (M 12 - M 16)		
Anker pro 360 ml Kartusche*			

Verfügbare Abmessungen auf den folgenden Seiten:

Befestigungstechnik: [S. 666](#)

Schwerlast-Befestigungen – Chemie

Artikel 88526 FIS H N

FISCHER Injektions-Ankerhülsen FIS H N

Baustoffe: LP, VD

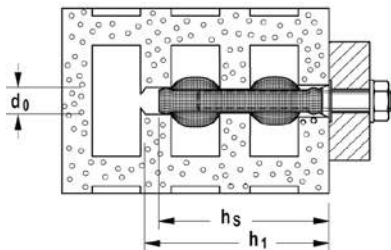

Zur Verwendung mit Injektionsmörtel

FIS-V, FIS-VS und FIS-VW

h_s = Verankerungstiefe Hülse min.

h_1 = Verankerungstiefe Ankerteil min.

Maße	16x85	18x85
d_0	16	18
h_1	95	95
h_s	90	90
passend zu FIS-A	M 8	M 10

Maße	20x85	
d_0	20	
h_1	95	
h_s	90	
passend zu FIS-A	M 12	

Verfügbare Abmessungen auf den folgenden Seiten:

Befestigungstechnik: [S. 666](#)

Artikel 88526 FIS H L



Maße	12x1000	16x1000	22x1000
d_0	12	16	22
l	1000	1000	1000
passend zu FIS-A	M 6 – M 8	M 10 – M 12	M 12 – M 16

Verfügbare Abmessungen auf den folgenden Seiten:

Befestigungstechnik: [S. 666](#)

Schwerlast-Befestigungen – Stahlanker

Artikel 88561 FAZ II

FISCHER Ankerbolzen FAZ II
 FISCHER Ankerbolzen FAZ II GZ II K
 Baustoffe: BN, VD

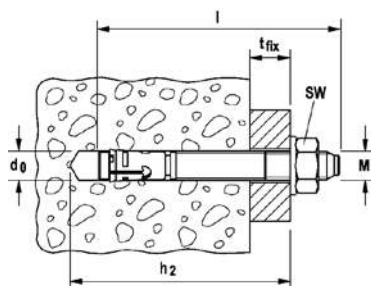
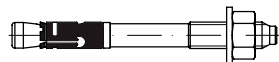

ETA-05/0069

Maße	6/10	6/20	8/10	8/30	8/50	8/100	8/160	10/10
d ₀	6	6	8	8	8	8	8	10
h ₂	60	70	65	85	105	155	215	85
l	65	75	75	95	115	165	225	95
t _{fix}	10/-	20/-	10/20	30/40	50/60	100/110	160/170	10/30
SW	10	10	13	13	13	13	13	17
Scheibe Ø bei GS	-	-	22x2,5	22x2,5	-	-	-	25x3

Maße	10/10 K	10/20	10/20 K	10/30	10/50	10/70	10/80	10/100
d ₀	10	10	10	10	10	10	10	10
h ₂	65	95	75	105	125	145	155	175
l	75	105	85	115	135	155	165	185
t _{fix}	10	20/40	20	30/50	50/70	70/90	80/100	100/120
SW	-	17	-	17	17	17	17	17
Scheibe Ø bei GS	20x2	-	20x2	25x3	-	-	-	-

Maße	10/160	12/10	12/10 K	12/20	12/20 K	12/30	12/50	12/60
d ₀	10	12	12	12	12	12	12	12
h ₂	235	100	80	110	90	120	140	150
l	245	110	90	120	100	130	150	160
t _{fix}	160/180	10/30	10	20/40	20	30/50	50/70	60/80
SW	17	19	-	19	-	19	19	19
Scheibe Ø bei GS	-	30x3	24x2,5	30x3	24x2,5	30x3	30x3	-

Maße	12/80	12/100	12/160	12/200	16/5	16/25	16/50	16/100
d ₀	12	12	12	12	16	16	16	16
h ₂	170	190	250	290	115	135	160	210
l	180	200	260	300	128	148	173	223
t _{fix}	80/100	100/120	160/180	200/220	5/25	25/45	50/70	100/120
SW	19	19	19	19	24	24	24	24
Scheibe Ø bei GS	44x4	30x3	44x4	44x4	-	-	-	-

Maße	16/160	16/200	16/250	16/300	20/30	20/60	20/160	24/30	24/60
d ₀	16	16	16	16	20	20	20	24	24
h ₂	270	310	360	410	155	185	285	185	215
l	283	323	373	423	172	202	302	205	235
t _{fix}	160/180	200/220	250/270	300/320	30	60	160	30	60
SW	24	24	24	24	30	30	30	36	36
Scheibe Ø bei GS	56x5	68x6	-	-	-	-	-	-	-

VdS-Zulassung M 8 – M 20
 FM-Zulassung ab M 10

Verfügbare Abmessungen auf den folgenden Seiten:

Befestigungstechnik: [S. 666](#)

Schwerlast-Befestigungen – Stahlanker

Artikel 88694 FBZ

FISCHER Bolzenanker FBZ

Baustoffe: BN

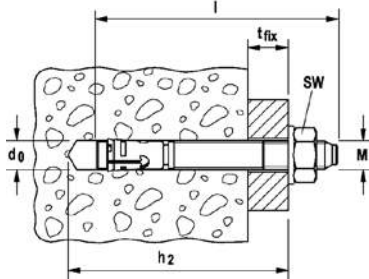
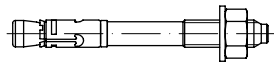

ETA-17/0624

Maße	8/10	8/10 GS*	10/10	10/10 GS*	10/20	10/30
d ₀	8	8	10	10	10	10
h ₂	70	70	87	87	97	107
l	75	75	95	95	105	115
h _{ef1} red.	35	35	40	40	40	40
h _{ef1} stand.	45	45	60	60	60	60
t _{fix}	10/20	10/20	10/30	10/30	20/40	30/50
U-Scheibe	16 x 1,6	22 x 2,5	20 x 2	25 x 3	20 x 2	20 x 2
Gewinde	M 8 x 38	M 10 x 53	M 10 x 53	M 10 x 53	M 10 x 63	M 10 x 73

Maße	12/10	12/10 GS*	12/20	12/30	16/25	
d ₀	12	12	12	12	16	
h ₂	99	99	109	119	133	
l	110	110	120	130	148	
h _{ef1} red.	50	50	50	50	65	
h _{ef1} stand.	70	70	70	70	85	
t _{fix}	10/30	10/30	20/40	30/50	25/45	
U-Scheibe	24 x 23,5	30 x 3	24 x 2,5	24 x 2,5	30 x 3	
Gewinde	M 12 x 61	M 12 x 61	M 12 x 71	M 12 x 84	M 16 x 84	

*mit großer Scheibe

Verfügbare Abmessungen auf den folgenden Seiten:

Befestigungstechnik: S. 668

Artikel 88593 FH II-S

FISCHER Hochleistungsanker FH II-S

Baustoffe: BN, VD

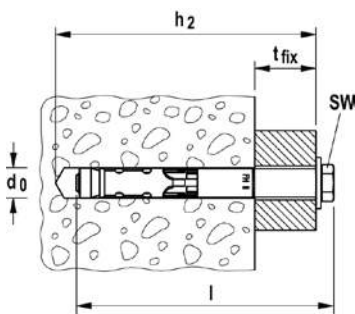
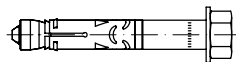

ETA-07/0025

Maße	10/10	10/25	10/50	12/10	12/25	12/50	15/10	15/25	18/10
d ₀	10	10	10	12	12	12	15	15	18
h ₂	65	80	105	90	105	130	100	115	119
h _{ef}	40	40	40	60	60	60	70	70	80
l _{Stahl/A 4}	70/69	85/84	110	90	105	130	106/107	121/122	118
t _{fix}	10	25	50	10	25	50	10	25	10
Gewinde	M 6	M 6	M 6	M 8	M 8	M 8	M 10	M 10	M 12
SW	10	10	10	13	13	13	17	17	19

Maße	15/50	18/25	18/50	24/25	24/50	28/30	28/60	32/30	32/60
d ₀	15	18	18	24	24	28	28	32	32
h ₂	140	130	155	150	175	185	215	210	240
h _{ef}	70	80	80	100	100	125	125	150	150
l _{Stahl/A 4}	146	132/133	157	160	185	192	222	215	245
t _{fix}	50	25	50	25	50	30	60	30	60
Gewinde	M 10	M 12	M 12	M 16	M 16	M 20	M 20	M 24	M 24
SW	17	19	19	24	24	30	30	36	36

l = Gesamtlänge Dübel

VdS-Zulassung M 8 – M 20

FM-Zulassung ab M 10

Verfügbare Abmessungen auf den folgenden Seiten:

Befestigungstechnik: S. 668

Schwerlast-Befestigungen – Stahlanker

Artikel 88594 FH II-SK

FISCHER Hochleistungsanker FH II-SK

Baustoffe: BN, VD

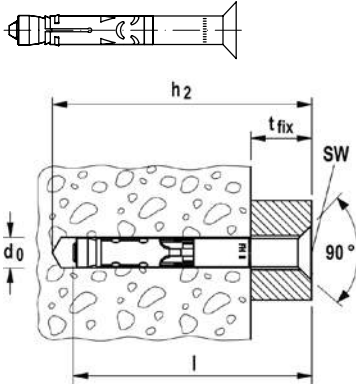

ETA-07/0025

VdS-Zulassung M 8 – M 20

FM-Zulassung ab M 10

Maße	10/15	10/25	10/50	12/15	12/25	12/30	12/50
d_0	10	10	10	12	12	12	12
h_2	70	80	105	95	105	110	130
h_{ef}	40	40	40	60	60	60	60
l	65	75	100	90	100	105	125
t_{fix}	10	25	50	15	25	30	50
Gewinde	M 6	M 6	M 6	M 8	M 8	M 8	M 8
SW	4	4	4	5	5	5	5
x	5	5	5	5,8	5,8	5,8	5,8
D	19,5	19,5	19,5	22	22	22	22
Maße	15/15	15/25	15/50	18/15	18/25	18/30	18/50
d_0	15	15	15	18	18	18	18
h_2	105	115	140	120	130	135	155
h_{ef}	70	70	70	80	80	80	80
l	100	110	135	115	125	130	150
t_{fix}	15	25	50	15	25	30	50
Gewinde	M 10	M 10	M 10	M 12	M 12	M 12	M 12
SW	6	6	6	8	8	8	8
x	5,8	5,8	5,8	8	8	8	8
D	25	25	25	32	32	32	32

Verfügbare Abmessungen auf den folgenden Seiten:

Befestigungstechnik: [S. 669](#)

Artikel 88590 FH II-H

FISCHER Hochleistungsanker FH II-H

Baustoffe: BN, VD

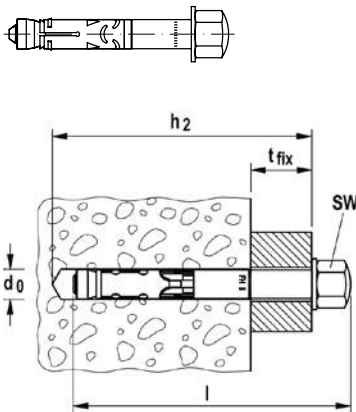

ETA-07/0025

l = Gesamtlänge Dübel

VdS-Zulassung M 8 – M 20

FM-Zulassung ab M 10

Maße	10/10	10/25	10/50	12/10	12/25	12/50
d_0	10	10	10	12	12	12
h_2	65	80	105	90	105	130
h_{ef}	40	40	40	60	60	60
l	75	90	115	100	115	140
t_{fix}	10	25	50	10	25	50
Gewinde	M 6	M 6	M 6	M 8	M 8	M 8
SW	13	13	13	17	17	17
Maße	15/10	15/25	15/50	18/25	18/50	
d_0	15	15	15	18	18	
h_2	100	115	140	130	155	
h_{ef}	70	70	70	80	80	
l	115	130	155	145	170	
t_{fix}	10	25	50	25	50	
Gewinde	M 10	M 10	M 10	M 12	M 12	
SW	17	17	17	19	19	

Verfügbare Abmessungen auf den folgenden Seiten:

Befestigungstechnik: [S. 669](#)

Schwerlast-Befestigungen – Stahlanker

Artikel 88592 FH II-B

FISCHER Hochleistungsanker FH II-B

Baustoffe: BN, VD

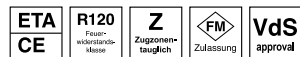
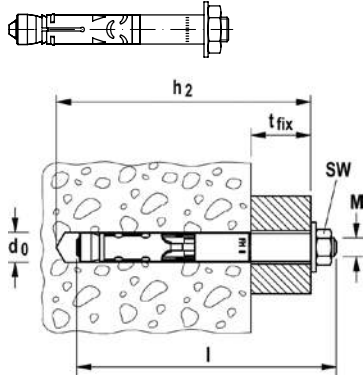

ETA-07/0025

l = Gesamtlänge Dübel
VdS-Zulassung M 8 – M 20
FM-Zulassung ab M 10

Maße	10/10	10/25	10/50	12/10	12/25	12/50	12/100	15/10	15/25	15/50	15/100
d ₀	10	10	10	12	12	12	12	15	15	15	15
h ₂	65	80	105	90	105	130	180	100	115	140	190
h _{ef}	40	40	40	60	60	60	60	70	70	70	70
l	70	85	110	95	110	135	185	110	125	150	200
t _{fix}	10	25	50	10	25	50	100	10	25	50	100
Gewinde	M 6	M 6	M 6	M 8	M 8	M 8	M 8	M 10	M 10	M 10	M 10
SW	10	10	10	13	13	13	13	17	17	17	17

Maße	18/25	18/50	18/100	24/25	24/50	24/100	28/30	28/60	32/30	32/60
d ₀	18	18	18	24	24	24	28	28	32	32
h ₂	130	155	205	150	175	225	185	215	210	240
h _{ef}	80	80	80	100	100	100	125	125	150	150
l	140	165	215	167	192	242	199	229	231	261
t _{fix}	25	50	100	25	50	100	30	60	30	60
Gewinde	M 12	M 12	M 12	M 16	M 16	M 16	M 20	M 20	M 24	M 24
SW	19	19	19	24	24	24	30	30	36	36

Verfügbare Abmessungen auf den folgenden Seiten:

Befestigungstechnik: [S. 669](#)

Artikel 88689 FH II-I

FISCHER Hochleistungsanker FH II-I

Baustoffe: BN, VD

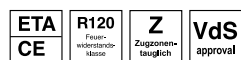
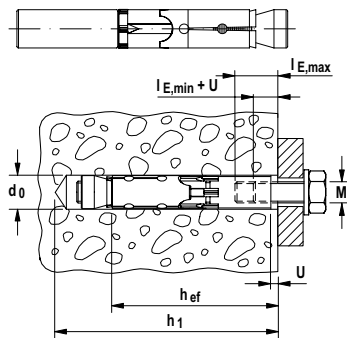

ETA-07/0025

Verfügbare Abmessungen auf den folgenden Seiten:

Befestigungstechnik: [S. 668](#)

Maße	M 6	M 8	M 10	M 12
d ₀	12	12	15	15
h ₁	85	85	95	95
h _{ef}	60	60	70	70
l	77,5	77,5	90	90
l _{E,min}	11 + U	13 + U	10 + U	12 + U
l _{E,max}	25	25	25	25
U	3 – 5	3 – 5	3 – 5	3 – 5

Schwerlast-Befestigungen – Stahlanker

Artikel 88583 FZA

FISCHER ZYKON-Bolzenanker FZA

Baustoffe: BN, VD

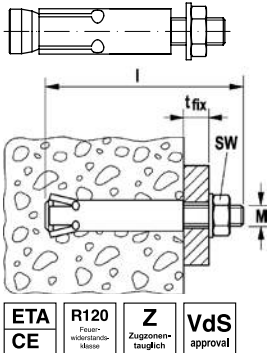

ETA-98/004

VdS-Zulassung ab M 8

Verfügbare Abmessungen auf den folgenden Seiten:

Befestigungstechnik: [S. 668](#)

Maße	10x40 M 6/10	12x40 M 8/15	12x50 M 8/15	12x50 M 8/50	14x40 M 10/25	14x60 M 10/25
l	60	69	79	114	79	102
t _{fix}	10	15	15	50	25	25
Gewinde	M 6	M 8	M 8	M 8	M 10	M 10
SW	10	13	13	13	17	17
Bohrer FZUR	10 x 40	12 x 40	12 x 50	12 x 50	14 x 40	14 x 60
Maße	14x60 M 10/50	18x80 M 12/25	18x80 M 12/55	22x100 M 16/60	22x125 M 16/60	
l	126	126	156	186	209	
t _{fix}	50	25	55	60	60	
Gewinde	M 10	M 12	M 12	M 16	M 16	
SW	17	19	19	24	24	
Bohrer FZUR	14 x 60	18/80	18/80	22 x 100	22 x 125	

Artikel 88584 FZA-D

FISCHER ZYKON-Durchsteckanker FZA-D

Baustoffe: BN, VD

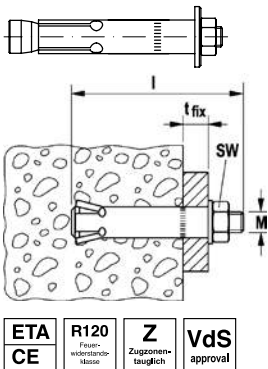

ETA-98/004

VdS Zulassung ab M 8

Verfügbare Abmessungen auf den folgenden Seiten:

Befestigungstechnik: [S. 670](#)

Maße	12x50 M 8/10	12x60 M 8/10	12x80 M 8/30
l	69	79	99
t _{fix}	10	10	30
Gewinde	M 8	M 8	M 8
SW	13	13	13
Bohrer FZUB	12 x 50	12 x 60	12 x 80
Maße	14x80 M 10/20	14x100 M 10/40	18x100 M 12/20
l	102	126	126
t _{fix}	20	40	20
Gewinde	M 10	M 10	M 12
SW	17	17	19
Bohrer FZUB	14 x 80	14 x 100	18 x 100
Maße	18x130 M 12/50	22x125 M 16/25	
l	156	156	
t _{fix}	50	25	
Gewinde	M 12	M 16	
SW	19	24	
Bohrer FZUB	18 x 130	22 x 125	

Artikel 88589 FZA ST

FISCHER ZYKON-Steigeisen-Befestigung FZA ST

Baustoffe: BN, VD

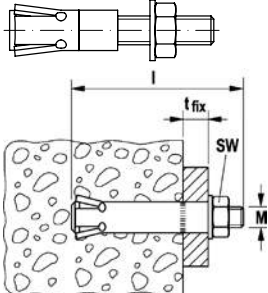

Verfügbare Abmessungen auf den folgenden Seiten:

Befestigungstechnik: [S. 670](#)

Maße	14/40	14/60
t _{fix}	30	30
Gewinde	M 10	M 10
SW	16	16
Bohrer FZUB	14 x 40	14 x 60

Schwerlast-Befestigungen – Stahlanker

Artikel 88585 FZA-I

FISCHER ZYKON-Innengewindeanker FZA-I
Baustoffe: BN, VD

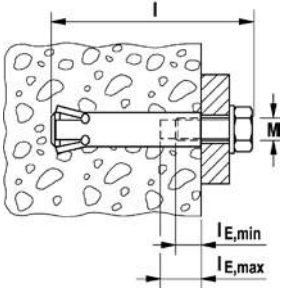
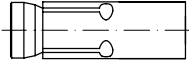

Maße	12x40 M 6	12x50 M 6	14x60 M 8	18 x 80 M 10	22 x 100 M 12	22 x 125 M 12
A1	M 6	M 6	M 8	M 10	M 12	M 12
$l_{E, \min}$	10	10	11	13	15	15
$l_{E, \max}$	15	15	17	21	25	25



ETA-98/004

VdS-Zulassung ab M 8

Verfügbare Abmessungen auf den folgenden Seiten:

Befestigungstechnik: [S. 670](#)

Artikel 88597 FZEA II

FISCHER ZYKON-Einschlaganker FZEA II
Baustoffe: BN, VD

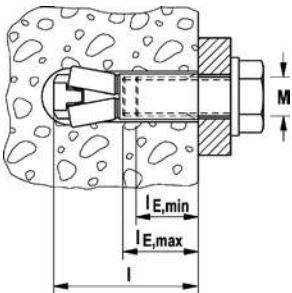
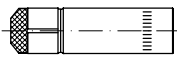

Maße	10x40 M 8	12x40 M 10	14x40 M 12
l	43	43	43
A1	M 8	M 10	M 12
$l_{E, \min}$	11	13	15
$l_{E, \max}$	17	19	21



ETA-06/0271

*Innengewinde

FM-Zulassung ab M 10

VdS-Zulassung M 8 – M 20

Verfügbare Abmessungen auf den folgenden Seiten:

Befestigungstechnik: [S. 670](#)

Schwerlast-Befestigungen – Stahlanker

Artikel 88567 EA II

FISCHER Einschlaganker EA II

Baustoffe: BN, VD

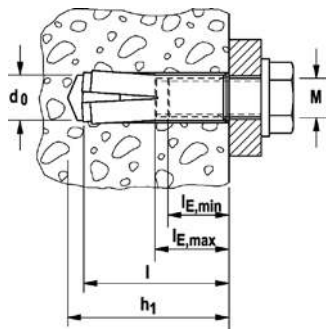
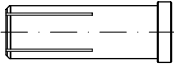

ETA-07/0135

ETA-07/0142

FM-Zulassung ab M 10

VdS-Zulassung ab M 8

Verfügbare Abmessungen auf den folgenden Seiten:

Befestigungstechnik: [S. 671](#)

Maße	M 6x30	M 8x30	M 8x40	M 10x40
d_0	8	10	10	12
l	30	30	40	40
$l_{E, \min}$	6	8	8	10
$l_{E, \max}$	14	14	14	17
h_1	32	33	43	43
Maße	M 12x50	M 16x65	M 20x80	
d_0	15	20	25	
l	50	65	80	
$l_{E, \min}$	12	16	20	
$l_{E, \max}$	22	28	34	
h_1	54	70	85	

Artikel 88546 FNA II

FISCHER Nagelanker FNA II

Baustoffe: BN, VD

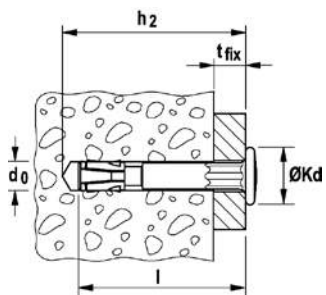
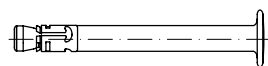

ETA-06/0175

Maße	6x25/5	6x30/5	6x30/30	6x30/50
d_0	6	6	6	6
h_2	40	45	70	90
h_{ef}	30	30	30	30
l	35	40	65	85
t_{fix}	5	5	30	50
d_K	13	13	13	13
Maße	6x30/75	6x30/100	6x30/120	
d_0	6	6	6	
h_2	115	140	160	
h_{ef}	30	30	30	
l	110	135	155	
t_{fix}	75	100	120	
d_K	13	13	13	

Verfügbare Abmessungen auf den folgenden Seiten:

Befestigungstechnik: [S. 672](#)

Schwerlast-Befestigungen – Stahlanker

Artikel 88547 FNA II M

FISCHER Nagelanker FNA II M
Baustoffe: BN, VD

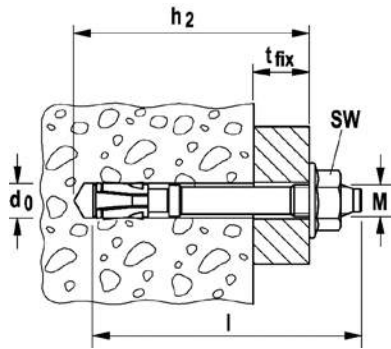
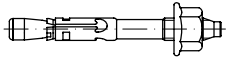

ETA-06/0175

Maße	6x30 M 6/5
d_0	6
h_2	45
h_{ef}	30
l	50
t_{fix}	5
Gewinde	M 6
SW	10

Verfügbare Abmessungen auf den folgenden Seiten:
Befestigungstechnik: [S. 672](#)

Artikel 88548 FNA II-OE

FISCHER Nagelanker FNA II-OE
Baustoffe: BN, VD

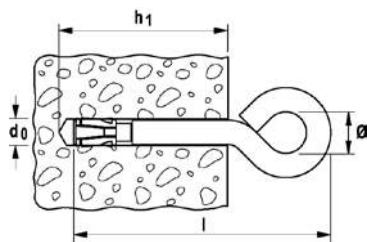
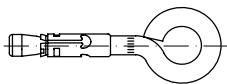

ETA-06/0175

Maße	6x25 OE
d_0	6
h_1	35
h_{ef}	25
l	54
Innen Ø Öse	10

Verfügbare Abmessungen auf den folgenden Seiten:
Befestigungstechnik: [S. 672](#)

Schwerlast-Befestigungen – Stahlanker

Artikel 88549 FNA II-H

FISCHER Nagelanker FNA II-H
Baustoffe: BN, VD

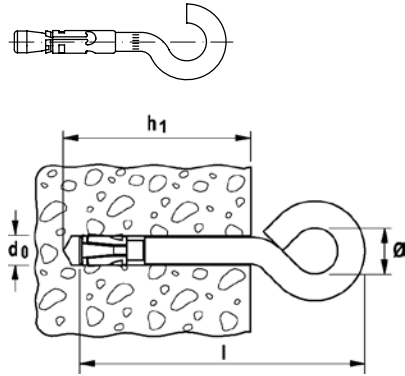

Maße	6x25 H
d_0	6
h_1	35
h_{ef}	25
l	54
Innen Ø Haken	10

Verfügbare Abmessungen auf den folgenden Seiten:
Befestigungstechnik: [S. 672](#)

Artikel 88582 FBN II/FBN II K

FISCHER Bolzenanker FBN II/FBN II K
Baustoffe: BN, VD

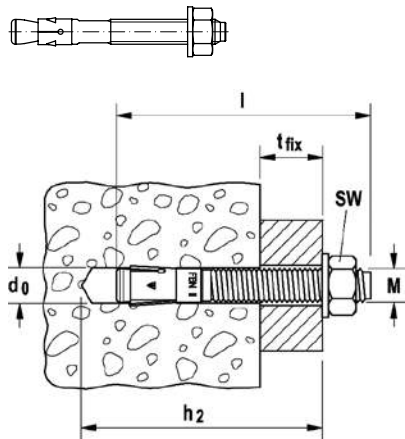

ETA-07/0211

Maße	6/5	6/10	6/30	8/5	8/5 K	8/10	8/10 K	8/20	8/30	8/50
d_0	6	6	6	8	8	8	8	8	8	8
h_2	45	50	70	61	51	66	56	76	86	106
l	50	55	75	66	56	71	61	81	91	111
t_{fix}	5/-	10/-	30/-	5/15	-/5	10/20	-/10	20/30	30/40	50/60
SW	10	10	10	13	13	13	13	13	13	13

Maße	8/70	8/100	10/5 K	10/10	10/10 K	10/20	10/30	10/50	10/70	10/100
d_0	8	8	10	10	10	10	10	10	10	10
h_2	126	156	63	78	68	88	98	118	138	168
l	131	161	71	86	76	96	106	126	146	176
t_{fix}	70/80	100/110	-/5	10/20	-/10	20/30	30/40	50/60	70/80	100/110
SW	13	13	17	17	17	17	17	17	17	17

Maße	10/140	10/160	12/5 K	12/10	12/10 K	12/20	12/30	12/30 K	12/50	12/80
d_0	10	10	12	12	12	12	12	12	12	12
h_2	208	228	75	95	80	105	115	100	135	165
l	216	236	86	106	91	116	126	111	146	176
t_{fix}	140/150	160/170	-/5	10/25	-/10	20/35	30/45	-/30	50/65	80/95
SW	17	17	19	19	19	19	19	19	19	19

Maße	12/100	12/120	12/140	12/160	16/10	16/15 K	16/25	16/25 K	16/50	16/80
d_0	12	12	12	12	16	16	16	16	16	16
h_2	185	205	225	245	114	104	129	114	154	184
l	196	216	236	256	130	120	145	130	170	200
t_{fix}	100/115	120/135	140/155	160/175	10/25	-/15	25/40	-/25	50/65	80/95
SW	19	19	19	19	24	24	24	24	24	24

Maße	16/100	16/140	16/160	16/200	20/10 K	20/30	20/60	20/80	20/120
d_0	16	16	16	16	20	20	20	20	20
h_2	204	244	264	304	120	165	195	215	255
l	220	260	280	320	142	187	217	237	277
t_{fix}	100/115	140/155	160/175	200/215	-/10	30/55	60/85	80/105	120/145
SW	24	24	24	24	30	30	30	30	30

K = Kurze Ausführung
mit reduzierter Verankerungstiefe

Verfügbare Abmessungen auf den folgenden Seiten:
Befestigungstechnik: [S. 672](#)

Schwerlast-Befestigungen – Stahlanker

Artikel 88683 TA M

FISCHER Schwerlastanker TA M
Baustoffe: BN, VD

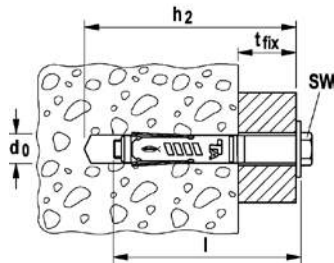

ETA-04/0003

Maße	M 6	M 8	M 10	M 12
d_0	10	12	15	18
h_1	65	70	90	105
h_{ef}	40	45	55	70
l	49	56	69	86

Verfügbare Abmessungen auf den folgenden Seiten:

Befestigungstechnik: [S. 673](#)

Artikel 88530 SL M/SL M-N

FISCHER Schwerlastanker SL M/SL M-N
Baustoffe: VD

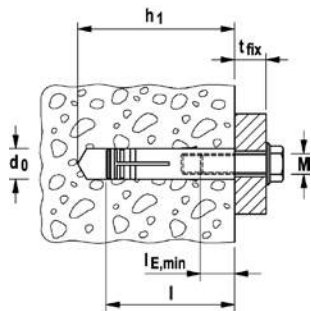
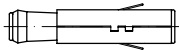

$l_s = h_{ef} + d_s + t_{fix}$
*= Innengewinde

Maße	8	10	16
d_0	12	16	24
h_1	60	70	110
h_{ef}	45	50	62
l	54	62	90
d_s^*	M 8	M 10	M 16
Maße	20	24	
d_0	30	35	
h_1	130	150	
h_{ef}	77	90	
l	110	125	
d_s^*	M 20	M 24	

Verfügbare Abmessungen auf den folgenden Seiten:

Befestigungstechnik: [S. 674](#)

Schwerlast-Befestigungen – Stahlanker

Artikel 88531 MR

FISCHER Mauerschrauben MR

Baustoffe: BN, VD

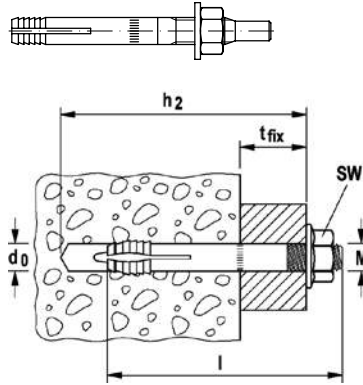

Maße	8	10	12
d_0	8	10	12
h_2	70	85	100
l	70	85	100
t_{fix}	22	24	27
SW	13	15	18
Gewinde	M 8	M 10	M 12

Verfügbare Abmessungen auf den folgenden Seiten:

Befestigungstechnik: [S. 674](#)

Artikel 88513 FHV

FISCHER Hohldeckenanker FHV

Baustoffe: BN

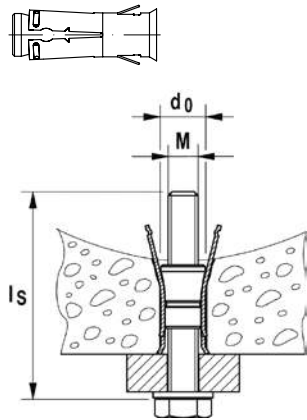

Maße	M 6	M 8	M 10
d_0	10	12	16
h_1	50	60	65
$l = l_{E, min}$	37	43	52



Zulassung gilt nur für galv. verzinkt,

VdS-Zulassung ab M 8

Verfügbare Abmessungen auf den folgenden Seiten:

Befestigungstechnik: [S. 674](#)

Schwerlast-Befestigungen – Stahlanker

Artikel 88688 FPX-I

FISCHER-Porenbetonanker FPX-I

Baustoffe: VP

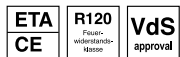
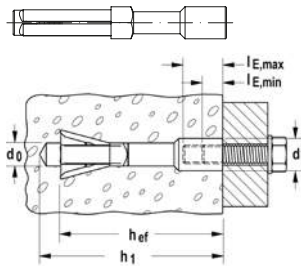

ETA-12/0456

VdS-Zulassung M 8 bis M 12

Verfügbare Abmessungen auf den folgenden Seiten:

Befestigungstechnik: [S. 674](#)

Maße	M 6	M 8	M 10	M 12
d_0	10	10	10	10
h_1	95	95	95	95
h_{ef}	70	70	70	70
l	75	75	75	75
$l_{E, min}$	10	8	10	12
$l_{E, max}$	15	15	15	15

Artikel 88715 EXA

FISCHER Bolzenanker EXA

Baustoffe: BN, VD

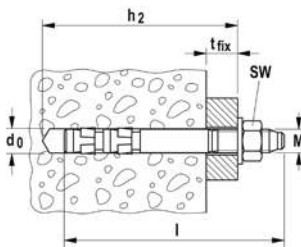

ETA-05/0185

K = kurze Ausführung

Verfügbare Abmessungen auf den folgenden Seiten:

Befestigungstechnik: [S. 673](#)

Maße	6/5	6/10	6/40	8/5	8/15	8/28
d_0	6	6	6	8	8	8
h_2	50	70	100	60	80	95
l	50	70	100	60	85	98
t_{fix}	5	10	40	5	15	28
Gewinde	M 6 x 17	M 6 x 17	M 6 x 17	M 8 x 22	M 8 x 22	M 8 x 22
SW	10	10	10	13	13	13

Maße	8/55	10/5	10/15	10/45	10/90	10/140
d_0	8	10	10	10	10	10
h_2	120	65	85	115	160	210
l	125	70	92	122	167	217
t_{fix}	55	5	15	45	90	140
Gewinde	M 8 x 22	M 10 x 28	M 10 x 28	M 10 x 28	M 10 x 28	M 10 x 28
SW	13	17	17	17	17	17

Maße	10/160	12/5	12/15	12/35	12/55	12/85
d_0	10	12	12	12	12	12
h_2	230	75	105	125	145	175
l	237	76	112	132	152	182
t_{fix}	160	5	15	35	55	85
Gewinde	M 10 x 28	M 12 x 30	M 12 x 33	M 12 x 33	M 12 x 33	M 12 x 33
SW	17	19	19	19	19	19

Maße	12/105	16/10	16/30	16/75	20/10	20/25
d_0	12	16	16	16	20	20
h_2	195	100	140	185	110	155
l	202	110	153	198	127	172
t_{fix}	105	10	30	75	10	25
Gewinde	M 12 x 33	M 16 x 44	M 16 x 44	M 16 x 44	M 20 x 60	M 20 x 60
SW	19	24	24	24	30	30

Maße	20/80	20/220	24/40	M 8 K	M 10 K
d_0	20	20	24	8	10
h_2	210	350	230	50	55
l	227	367	253	52	58
t_{fix}	80	220	40	5	5
Gewinde	M 20 x 60	M 20 x 60	M 24 x 70	M 8 x 22	M 10 x 28
SW	30	30	36	11	17

Langschaftdübel/Fassadendübel/Abstands-Befestigungen

Artikel 88542 SXR-T

FISCHER Langschaftdübel SXR-T
Baustoffe: BN, VD, LD, LP, BL, VP

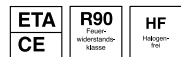
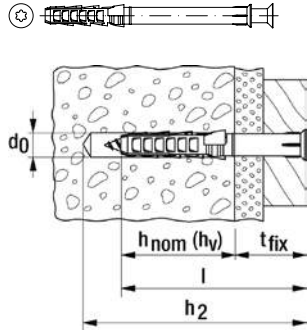

ETA-07/0121

Maße	10x80	10x100	10x120	10x140	10x160
d_0	10	10	10	10	10
h_2	90	110	130	150	170
$h_{nom} (h_v)$	50	50	50	50	50
l	80	100	120	140	160
t_{fix}	30	50	70	90	110
Antrieb	T40	T40	T40	T40	T40

Maße	10x180	10x200	10x230	10x260	
d_0	10	10	10	10	
h_2	190	210	240	270	
$h_{nom} (h_v)$	50	50	50	50	
l	180	200	230	260	
t_{fix}	130	150	180	210	
Antrieb	T40	T40	T40	T40	

Verfügbare Abmessungen auf den folgenden Seiten:
Befestigungstechnik: [S. 674](#)

Artikel 88542 SXR-FUS

FISCHER Langschaftdübel SXR-FUS
Baustoffe: BN, VD, LD, LP, BL, VP

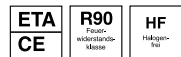
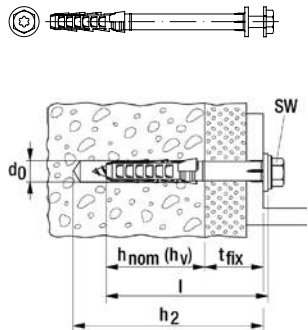

ETA-07/0121

Maße	10x52	10x60	10x80	10x100	10x120	10x140
d_0	10	10	10	10	10	10
h_2	62	70	90	110	130	150
$h_{nom} (h_v)$	50	50	50	50	50	50
l	52	60	80	100	120	140
t_{fix}	2	10	30	50	70	90
Antrieb	T40/SW13	T40/SW13	T40/SW13	T40/SW13	T40/SW13	T40/SW13

Maße	10x160	10x180	10x200	10x230	10x260	
d_0	10	10	10	10	10	
h_2	170	190	210	240	270	
$h_{nom} (h_v)$	50	50	50	50	50	
l	160	180	200	230	260	
t_{fix}	110	130	150	180	210	
Antrieb	T40/SW13	T40/SW13	T40/SW13	T40/SW13	T40/SW13	

Verfügbare Abmessungen auf den folgenden Seiten:
Befestigungstechnik: [S. 675](#)

Langschaftdübel/Fassadendübel/Abstands-Befestigungen

Artikel 88551 SXRL-T

FISCHER-Langschaftdübel SXRL-T
Baustoffe: BN, VD, LD, LP, BL, VP

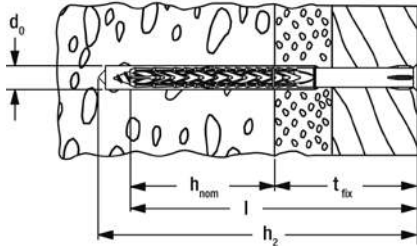
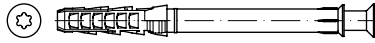

ETA-07/0121
ETA-14/0297

*tfix = Nutzlänge bei Verankerungstiefe
50 mm / 70 mm / 90 mm

Verfügbare Abmessungen auf den folgenden Seiten:
Befestigungstechnik: [S. 675](#)

Maße	8x80	8x100	8x120	10x80	10x100
d ₀	8	8	8	10	10
h ₂	90	110	130	90	110
t _{fix} *	30/10/-	50/30/10	70/50/30	30/10/-	50/30/10
l	80	100	120	80	100
Antrieb	T30	T30	T30	T40	T40
Maße	10x120	10x140	10x160	10x180	10x200
d ₀	10	10	10	10	10
h ₂	130	150	170	190	210
t _{fix} *	70/50/30	90/70/50	110/90/70	130/110/90	150/130/110
l	120	140	160	180	200
Antrieb	T40	T40	T40	T40	T40
Maße	10x230	10x260	10x290		
d ₀	10	10	10		
h ₂	240	270	300		
t _{fix} *	180/160/140	210/190/170	240/220/200		
l	230	260	290		
Antrieb	T40	T40	T40		

Artikel 88551 SXRL-FUS

FISCHER-Langschaftdübel SXRL-FUS
Baustoffe: BN, VD, LD, LP, BL, VP

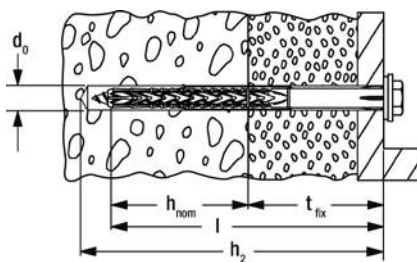
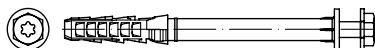

ETA-07/0121
ETA-14/0297

*tfix = Nutzlänge bei Verankerungstiefe
50 mm / 70 mm / 90 mm

Verfügbare Abmessungen auf den folgenden Seiten:
Befestigungstechnik: [S. 675](#)

Maße	8x80	8x100	8x120	10x80	10x100
d ₀	8	8	8	10	10
h ₂	90	110	130	90	110
t _{fix} *	30/10/-	50/30/10	70/50/30	30/10/-	50/30/10
l	80	100	120	80	100
Antrieb	T30/SW10	T30/SW10	T30/SW10	T40/SW13	T40/SW13
Maße	10x120	10x140	10x160	10x180	10x200
d ₀	10	10	10	10	10
h ₂	130	150	170	190	210
t _{fix} *	70/50/30	90/70/50	110/90/70	130/110/90	150/130/110
l	120	140	160	180	200
Antrieb	T40/SW13	T40/SW13	T40/SW13	T40/SW13	T40/SW13
Maße	10x230	10x260	10x290		
d ₀	10	10	10		
h ₂	240	270	300		
t _{fix} *	180/160/140	210/190/170	240/220/200		
l	230	260	290		
Antrieb	T40/SW13	T40/SW13	T40/SW13		

Langschaftdübel/Fassadendübel/Abstands-Befestigungen

Artikel 88563 FUR-T

FISCHER Langschaftdübel FUR-T
Baustoffe: BN, VD, LD

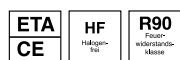
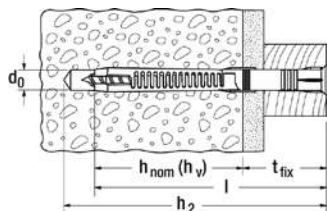

ETA-13/0235

Maße	10x80	10x100	10x115	10x135
d_0	10	10	10	10
h_2	90	110	125	145
$h_{nom} (h_v)$	70	70	70	70
l	80	100	115	135
t_{fix}	10	30	45	65
Antrieb	T40	T40	T40	T40
Maße	10x160	10x185	10x200	10x230
d_0	10	10	10	10
h_2	170	195	210	240
$h_{nom} (h_v)$	70	70	70	70
l	160	185	200	230
t_{fix}	90	115	130	160
Antrieb	T40	T40	T40	T40

Verfügbare Abmessungen auf den folgenden Seiten:
Befestigungstechnik: [S. 676](#)

Artikel 88564 FUR-SS

FISCHER Rahmendübel FUR-SS
Baustoffe: BN, VD, LD

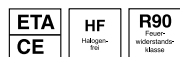
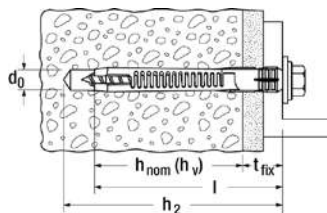

ETA-13/0235

Maße	10x80	10x100	10x115	10x135
d_0	10	10	10	10
h_2	90	110	125	145
$h_{nom} (h_v)$	70	70	70	70
l	80	100	115	135
t_{fix}	10	30	45	65
SW	13	13	13	13
Maße	10x160	10x185	10x200	10x230
d_0	10	10	10	10
h_2	170	195	210	240
$h_{nom} (h_v)$	70	70	70	70
l	160	185	200	230
t_{fix}	90	115	130	160
SW	13	13	13	13

Verfügbare Abmessungen auf den folgenden Seiten:
Befestigungstechnik: [S. 676](#)

Langschaftdübel/Fassadendübel/Abstands-Befestigungen

Artikel 88503 N-S

FISCHER Nageldübel N-S

Baustoffe: BN, VD, VP, HP, LD, LP

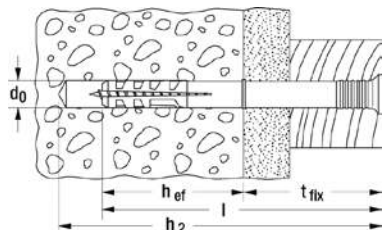
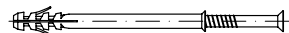

Maße	5x30	5x40	5x50	6x40	6x60	6x80	8x60
d ₀	5	5	5	6	6	6	8
h ₂	45	55	65	55	75	95	75
h _{ef}	25	25	25	30	30	30	40
l	30	40	50	40	60	80	60
t _{fix}	5	15	25	10	30	50	20

Maße	8x80	8x100	8x120	10x100	10x135	10x160	10x230
d ₀	8	8	8	10	10	10	10
h ₂	95	115	135	115	150	175	245
h _{ef}	40	40	40	50	50	50	50
l	80	100	120	100	135	160	230
t _{fix}	40	60	80	50	85	110	180

Lieferung Ø 5, 6, 8 einbaufertig montiert

Verfügbare Abmessungen auf den folgenden Seiten:

Befestigungstechnik: [S. 676](#)

Artikel 88516 F-S

FISCHER Fensterrahmendübel F-S

Baustoffe: BN, VD, VP, BL, HP, LP

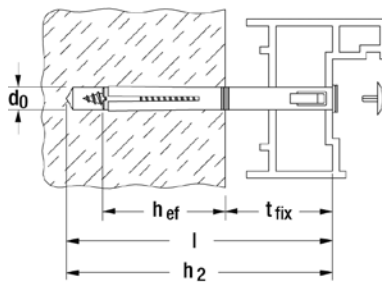
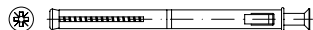

Maße	F 8 S 100	F 8 S 120	F 8 S 140	F 10 S 75
d ₀	8	8	8	10
h ₂	115	135	155	90
h _{ef}	40	40	40	50
l	100	120	140	75
t _{fix}	50	70	90	15

Maße	F 10 S 100	F 10 S 120	F 10 S 140	F 10 S 165
d ₀	10	10	10	10
h ₂	115	135	155	180
h _{ef}	50	50	50	50
l	100	120	140	165
t _{fix}	40	60	80	105

Schraubenkopf Ø 10 mm bzw. Ø 12 mm

Verfügbare Abmessungen auf den folgenden Seiten:

Befestigungstechnik: [S. 677](#)

Langschaftdübel/Fassadendübel/Abstands-Befestigungen

Artikel 88680 F-M

FISCHER Metallrahmendübel F-M

Baustoffe: BN, VD, VP, BL, HP

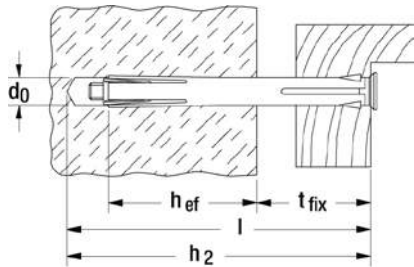
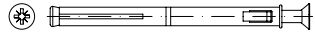

F120
Baugrupp
widerstand
klasse

Schraubenkopf \varnothing 9 mm bzw. \varnothing 13 mm

Verfügbare Abmessungen auf den folgenden Seiten:

Befestigungstechnik: [S. 677](#)

Maße	F 8 M 72	F 8 M 92	F 8 M 112	F 8 M 132
d_0	8	8	8	8
h_2	90	110	130	150
h_{ef}	30	30	30	30
l	72	92	112	132
t_{fix}	42	62	82	102
Maße	F 10 M 72	F 10 M 92	F 10 M 112	F 10 M 132
d_0	10	10	10	10
h_2	90	110	130	150
h_{ef}	30	30	30	30
l	72	92	112	132
t_{fix}	42	62	82	102
Maße	F 10 M 152	F 10 M 182	F 10 M 202	
d_0	10	10	10	
h_2	170	200	220	
h_{ef}	30	30	30	
l	152	182	202	
t_{fix}	122	152	172	

Artikel 88515 JUSS

FISCHER Justierschrauben JUSS

Baustoffe: Holz und Holzwerkstoffe

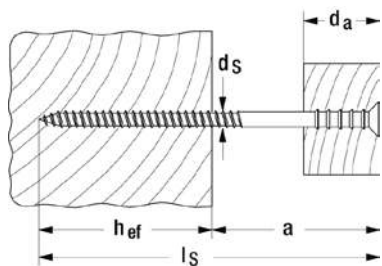
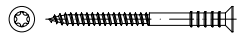

Maße	6x60	6x70	6x80	6x90
h_{ef}	30	30	30	30
a	30	40	50	60
$d_s \times l_s$	6x60	6x70	6x80	6x90
d_a	20	25	25	25
Antrieb	T25	T25	T25	T25
Maße	6x100	6x110	6x120	6x145
h_{ef}	30	30	30	30
a	70	80	90	115
$d_s \times l_s$	6x100	6x110	6x120	6x145
d_a	25	25	25	25
Antrieb	T25	T25	T25	T25

Verfügbare Abmessungen auf den folgenden Seiten:

Befestigungstechnik: [S. 677](#)

Langschaftdübel/Fassadendübel/Abstands-Befestigungen

Artikel 88695 Thermax

FISCHER Abstandsmontagesystem Thermax
Baustoffe: BN, BL, VD, LD, VP, LP

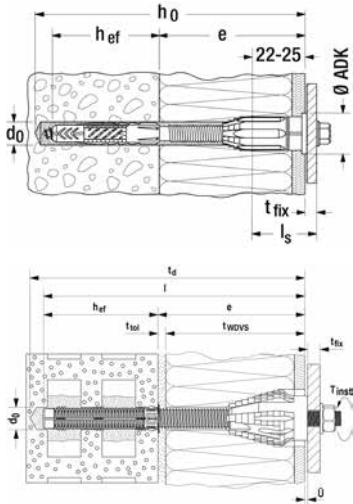
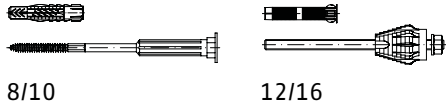

Maße	8/80 M 6	8/100 M 6	8/120 M 6	8/140 M 6	8/160 M 6	10/120 M 8	10/140 M 10
d ₀	10	10	10	10	10	12	12
h ₀	140	160	180	200	220	180	200
e	60 - 80	80 - 100	100 - 120	120 - 140	140 - 160	100 - 120	120 - 140
h _{ef}	60	60	60	60	60	70	70
ADK	18	18	18	18	18	22	22
SW	10	10	10	10	10	13	13

Maße	10/160 M 8	10/160 M 10	10/180 M 6	10/200 M 8	10/200 M 10	10/240 M 8
d ₀	12	12	12	12	12	12
h ₀	220	220	240	260	260	300
e	140 - 160	140 - 160	160 - 180	180 - 200	180 - 200	220 - 240
h _{ef}	70	70	70	70	70	70
ADK	22	22	22	22	22	22
SW	13	13	13	13	13	13

Maße	12/110 M 12				16/170 M 12			
	BN	VD	LD	BL	BN	VD	LD	BL
d ₀	14	14	20	14	18	18	20	18
h _{ef}	70	80	130	100	80	80	200	100
t _d	h _{ef} + e	h _{ef} + e	h _{ef} +e+10mm	h _{ef} + e	h _{ef} + e	h _{ef} + e	h _{ef} +e+10mm	h _{ef} + e
e	62 - 170	62 - 160	62 - 110	62 - 140	62 - 290	62 - 290	62 - 170	62 - 270
t _{fix}	16	16	16	16	16	16	16	16
l	240	240	240	240	370	370	370	370

Verfügbare Abmessungen auf den folgenden Seiten:
Befestigungstechnik: S. 681

Artikel 88690 DUOPOWER

FISCHER Dübel DUOPOWER
Baustoffe: BN, BL, VD, LD, VP, LP, HP

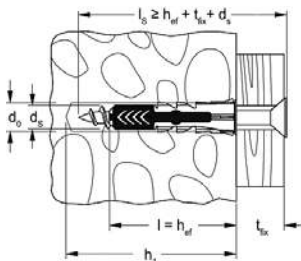
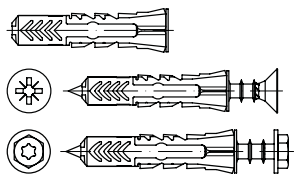

*mit Senkschraube
**mit Sechskantschraube

Maße	5x25	5x25 S*	6x30	6x30 S*	6x50	8x40	8x40 S*
d ₀	5	5	6	6	6	8	8
h ₁	35	40	40	45	60	50	65
d _p	12,5	12,5	12,5	12,5	12,5	12,5	12,5
l _{E, min}	29	29	35	35	55	46	45
l	25	25	30	30	50	40	40
d _s / d _s x l _s	3 - 4	4 x 35	4 - 5	4,5 x 40	4 - 5	4,5 - 6	5 x 60
Antrieb	-	PZ2	-	PZ2	-	-	PZ2
t _{fix}	-	6	-	5	-	-	15

Maße	8x65	10x50	10x50 S**	10x80	12x60	14x70
d ₀	8	10	10	10	12	14
h ₁	75	70	74	100	80	90
d _p	2 x 12,5	12,5	12,5	-	-	-
l _{E, min}	71	58	57	88	70	82
l	65	50	50	80	60	70
d _s / d _s x l _s	4,5 - 6	6 - 8	7 x 69	6 - 8	8 - 10	10 - 12
Antrieb	-	-	SW13/T40	-	-	-
t _{fix}	-	-	13	-	-	-

Verfügbare Abmessungen auf den folgenden Seiten:
Befestigungstechnik: S. 678

Allgemeine Befestigungen

Artikel 88520 UX

FISCHER Universaldübel UX

Baustoffe: BN, BL, VD, LD, VP, LP, HP

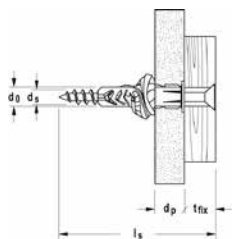

$$l_s = l + d_p + t_{fix} + d_s$$

*auch mit Rand

Maße	5x30*	6x35*	6x50*	8x40*
d_0	5	6	6	8
h_1	40	45	60	50
d_p	9,5	9,5	9,5	9,5
l	30	35	50	40
d_s	3 - 4	4 - 5	4 - 5	4,5 - 6
Maße	8x50*	10x60*	12x70	14x75
d_0	8	10	12	14
h_1	60	75	85	95
d_p	9,5	12,5	-	-
l	50	60	70	75
d_s	4,5 - 6	6 - 8	8 - 10	10 - 12

Verfügbare Abmessungen auf den folgenden Seiten:

Befestigungstechnik: [S. 677](#)

Artikel 88554 SX

FISCHER Spreizdübel SX

Baustoffe: BN, VD, VP, BL, HP, LP, LD

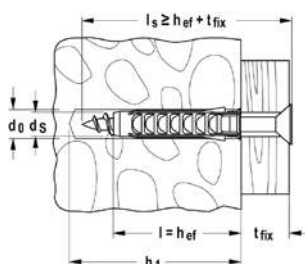

*mit Schraube

Maße	4x20	5x25	6x30	6x30 S/10*	6x50	8x40
d_0	4	5	6	6	6	8
h_1	25	35	40	45	60	50
$l = h_{ef}$	20	25	30	30	50	40
d_s	2 - 3	3 - 4	4 - 5	4,5x40	4 - 5	4,5 - 6
Maße	8x40 S/20*	8x65	10x50	12x60	14x70	16x80
d_0	8	8	10	12	14	16
h_1	65	75	70	80	90	100
$l = h_{ef}$	40	65	50	60	70	80
d_s	5x60	4,5 - 6	6 - 8	8 - 10	10 - 12	12 (1/2")

Verfügbare Abmessungen auf den folgenden Seiten:

Befestigungstechnik: [S. 678](#)

Allgemeine Befestigungen

Artikel 88500 S

FISCHER Spreizdübel S

Baustoffe: BN, VD, VP

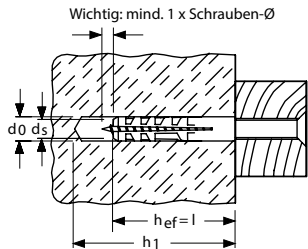
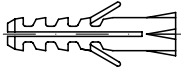

Maße	4	5	6	8	10
d ₀	4	5	6	8	10
h ₁	25	35	40	55	70
l	20	25	30	40	50
d _s	2 - 3	3 - 4	4 - 5	4,5 - 6	6 - 8
Maße	12	14	16	20	
d ₀	12	14	16	20	
h ₁	80	90	100	120	
l	60	75	80	90	
d _s	8 - 10	10 - 12	12 (1/2")	16	

Verfügbare Abmessungen auf den folgenden Seiten:

Befestigungstechnik: [S. 678](#)

Artikel 88545 FMD

FISCHER Metallspreizdübel FMD

Baustoffe: BN, VD, VP, BL, HP, LP, LD

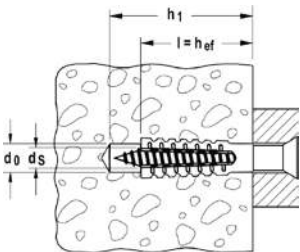
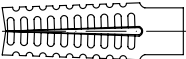

Maße	6x32	8x38	8x60	10x60
d ₀ *	6 - 7	10 - 12	10 - 12	12 - 14
l	32	38	60	60
h ₁	38	46	68	68
d _s	5 - 6	6 - 8	6 - 8	8 - 10

*Je höher die Baustoff-Druckfestigkeit desto größer ist der Bohr-Ø

Verfügbare Abmessungen auf den folgenden Seiten:

Befestigungstechnik: [S. 678](#)

Allgemeine Befestigungen

Artikel 88506 M-S

FISCHER Spreizdübel M-S

Baustoffe: BN, VD, VP, HP, LP, LD, BL

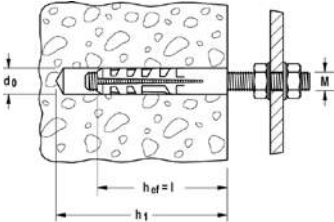
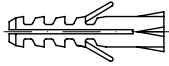

Maße	6	8	10	12
d_0	8	10	14	16
h_1	55	70	90	100
$l = h_{ef}$	40	50	70	80
Gewinde	M 6	M 8	M 10	M 12

Verfügbare Abmessungen auf den folgenden Seiten:

Befestigungstechnik: [S. 679](#)

Artikel 88510 M

FISCHER Dübel M

Baustoffe: BN, VD, VP, BL, HP

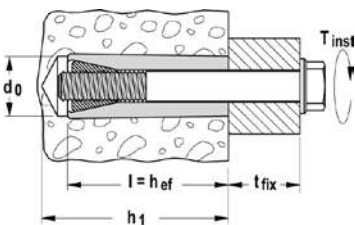

Maße	M 5	M 6	M 8	M 10	M 12
d_0	10	12	16	20	24
h_1	45	50	65	80	90
$l = h_{ef}$	35	40	50	60	65

Verfügbare Abmessungen auf den folgenden Seiten:

Befestigungstechnik: [S. 679](#)

Allgemeine Befestigungen

Artikel 88507 GB

FISCHER Gasbetondübel GB
Baustoffe: VP

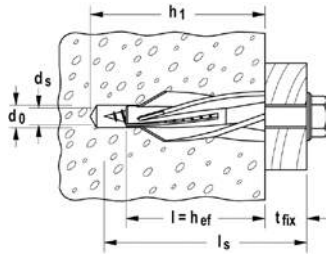

$$l_s = h_{ef} + d_s + t_{fix}$$

Maße	8	10	14
d_0	8	10	14
h_1	60	65	90
l	50	55	75
$d_s \times l_s$	5	7	10

Verfügbare Abmessungen auf den folgenden Seiten:

Befestigungstechnik: [S. 679](#)

Artikel 88521 PA 4

FISCHER Messingdübel PA 4
Baustoffe: BN, VD, HP

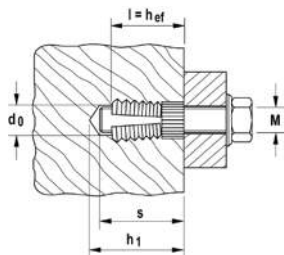
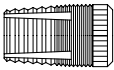

*Bei weichem Baustoff Bohrer-Ø
um 0,5 mm verringern

Maße	M 6/7,5	M 6/10,5	M 6/13,5	M 8/25	M 10/25
d_0^*	8	8	8	10	12
h_1	7,5	10,5	13,5	25	25
l	7,5	10,5	13,5	25	25
Gewinde	M 6	M 6	M 6	M 8	M 10
s	7,5	10,5	13,5	25	25

Verfügbare Abmessungen auf den folgenden Seiten:

Befestigungstechnik: [S. 679](#)

Hohlraum-Befestigungen

Artikel 88512 HM-S

FISCHER Hohlraum-Metaldübel HM-S

Baustoffe: HP

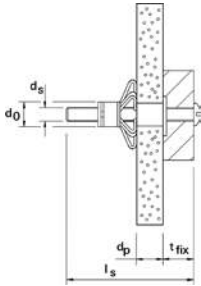

Maße	4x32	4x46	4x59	5x37	5x52
d_0	8	8	8	10	10
h_1	40	52	65	45	58
l	32	45	60	37	52
$d_s \times l_s$	M 4x40	M 4x52	M 4x65	M 5x45	M 5x58
d_p	3 - 13	16 - 23	31 - 40	6 - 15	7 - 21
t_{fix}	$\leq 15 - 25$	$\leq 12 - 21$	$\leq 12 - 21$	$\leq 8 - 17$	$\leq 10 - 24$
Maße	5x65	6x37	6x52	6x65	6x80
d_0	10	12	12	12	12
h_1	71	45	58	71	88
l	65	37	52	65	80
$d_s \times l_s$	M 5x71	M 6x45	M 6x58	M 6x71	M 6x88
d_p	20 - 34	6 - 15	7 - 21	17 - 34	32 - 50
t_{fix}	$\leq 12 - 26$	$\leq 12 - 21$	$\leq 14 - 28$	$\leq 13 - 30$	$\leq 16 - 34$

Verfügbare Abmessungen auf den folgenden Seiten:

Befestigungstechnik: [S. 679](#)

Artikel 88509 K 54

FISCHER Kippdübel K 54

Baustoffe: HP, LP

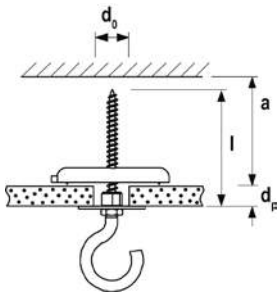
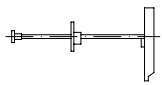

Maße	54
d_0	10
d_p	65
a	58
l	125
Gewinde	Holzschraube 4 mm

Verfügbare Abmessungen auf den folgenden Seiten:

Befestigungstechnik: [S. 679](#)

Hohlraum-Befestigungen

Artikel 88518 KD

FISCHER Federklappdübel KD

Baustoffe: HP, LP

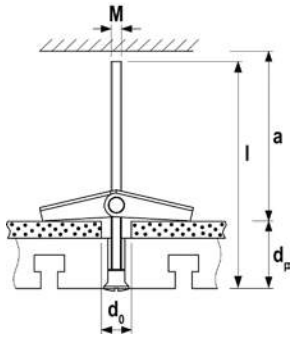
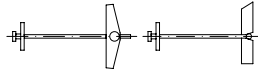

Maße	3	4	5	6	8
d_0	12	14	16	16	20
d_p	65	69	63	63	55
a	27	34	70	70	75
l	95	105	100	100	100
Gewinde	M 3x90	M 4x100	M 5x100	M 6x100	M 8x100

Verfügbare Abmessungen auf den folgenden Seiten:

Befestigungstechnik: [S. 679](#)

Artikel 88519 KDH

FISCHER Federklappdübel KDH

Baustoffe: HP, LP

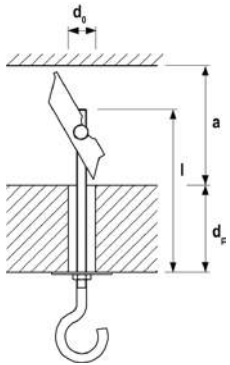
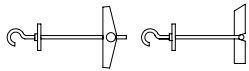

Maße	3	4	5	6	8
d_0	12	14	16	16	20
d_p	51	35	60	60	55
a	27	34	70	70	75
l	105	95	130	130	130
Gewinde	M 3x80	M 4x70	M 5x90	M 6x100	M 8x100

Verfügbare Abmessungen auf den folgenden Seiten:

Befestigungstechnik: [S. 680](#)

Hohlraum-Befestigungen

Artikel 88598 GKM

FISCHER Gipskartondübel GKM
selbstbohrend, Antrieb -Z2
Baustoffe: HP

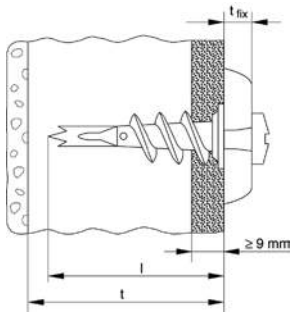
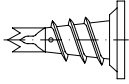

Maße	5
l	31
t	35
für Schraubendurchmesser	4 - 5
t _{fix}	-

Verfügbare Abmessungen auf den folgenden Seiten:

Befestigungstechnik: [S. 680](#)

Artikel 88598 GK

FISCHER Gipskartondübel GK
mit Eindrehwerkzeug
Baustoffe: HP

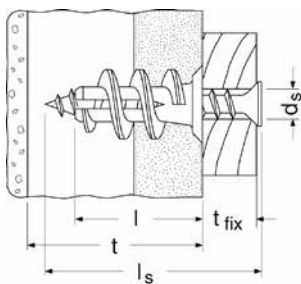
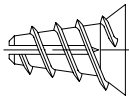

Maße	5
l	22
t	25
d _s	4 - 5 x l _s
t _{fix}	-



Verfügbare Abmessungen auf den folgenden Seiten:

Befestigungstechnik: [S. 680](#)

Elektro-Befestigungen

Artikel 88558 FC

FISCHER Clipschellen FC
für Kabel- und Rohrleitungen

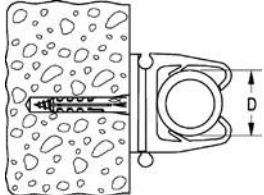

Maße	6 - 9	9 - 12	12 - 16	16 - 20
$d_{\min.} - d_{\max.}$	6 - 9	9 - 12	12 - 16	16 - 20

Verfügbare Abmessungen auf den folgenden Seiten:

Befestigungstechnik: [S. 680](#)

Artikel 88559 SCH

FISCHER Schellen SCH
für Kabel- und Rohrleitungen

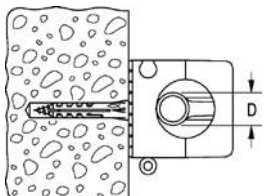

Maße	812*	1216**	1619**
$d_{\min.} - d_{\max.}$	8 - 12	12 - 16	16 - 19
für WICU-Rohre	6x1 - 8x1	10x1 - 12x1	-

Maße	1623**	2332*	3242**
$d_{\min.} - d_{\max.}$	16 - 23	23 - 32	32 - 42
für WICU-Rohre	15x1 - 18x1	22x1 - 22x1,5	22x1 - 22x1,5

*erhältlich nur in weiß

**erhältlich in grau oder weiß

Verfügbare Abmessungen auf den folgenden Seiten:

Befestigungstechnik: [S. 680](#)

Gerüst-Befestigungen

Artikel 88536

FISCHER Gerüstösen GS 12
zur Verwendung mit Dübel S 14 ROE
Baustoffe: BN, VD

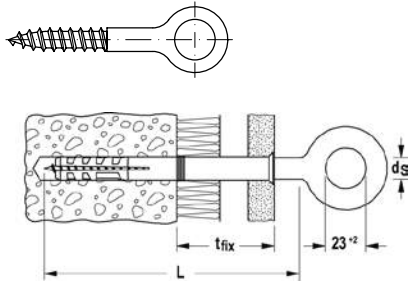

Maße	12x90	12x120	12x160	12x190	12x230	12x300	12x350
d_s	12	12	12	12	12	12	12
L	90	120	160	190	230	300	350
t_{fix}	15	30/10	65/45	110/70	110/70	110/70	110/70
Augen \varnothing	23	23	23	23	23	23	23

Verfügbare Abmessungen auf den folgenden Seiten:

Befestigungstechnik: [S. 680](#)

Artikel 88536

FISCHER Dübel S 14 ROE
Baustoffe: BN, VD

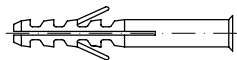

Maße	70	100	135	185
d_0	14	14	14	14
h_2	80	110	145	195
h_{ef}	70	70	70	70
l	70	100	135	185
t_{fix}	-	30	65	110
l + 5 mm	75	105	140	190



Verfügbare Abmessungen auf den folgenden Seiten:

Befestigungstechnik: [S. 680](#)

Dämmstoff-Befestigungen

Artikel 88514 DHK

FISCHER Dämmstoffhalter DHK
Baustoffe: BN, VD, VP, BL, LP, LD

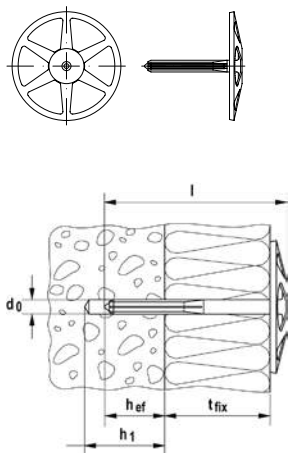

Maße	40	60	80	100	120
d_0	8	8	8	8	8
h_1	30	30	30	30	30
h_{ef}	20	20	20	20	20
l	65	85	105	125	145
t_{fix}	40	60	80	100	120
Maße	140	160	180	200	220
d_0	8	8	8	8	8
h_1	30	30	30	30	30
h_{ef}	20	20	20	20	20
l	165	185	205	225	245
t_{fix}	140	160	180	200	220

Für weiche Dämmung-Teller- \varnothing 90

Verfügbare Abmessungen auf den folgenden Seiten:

Befestigungstechnik: [S. 681](#)

Artikel 88580 DT

FISCHER Dämmstoffteller DT
zum Verarbeiten mit Nageldübel N

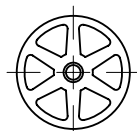

Maße	90/4	90/8
Teller \varnothing	90	90
Tellerhöhe	9,3	9,3
d_f	4	8,2

Verfügbare Abmessungen auf den folgenden Seiten:

Befestigungstechnik: [S. 681](#)

Artikel 88696 FID

FISCHER Dämmstoffdübel FID
Baustoffe: HP

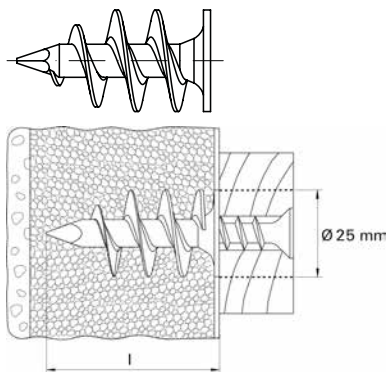

Maße	50	90
l	50	90
d_s	4,5 - 5	6
Antrieb	T40	6 mm / 6-kt

Verfügbare Abmessungen auf den folgenden Seiten:

Befestigungstechnik: [S. 681](#)

Schwerlast-Befestigungen – Stahlanker

Artikel 88741

UPAT Expressanker MAX
mit 1 Spreizclip, Mutter und Scheibe
Baustoffe: BN, VD

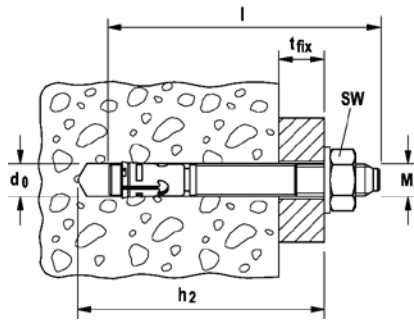
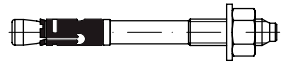

ETA-10/0170

Maße	8/10/75	8/30/95	8/50/115	10/10/95	10/20/105	10/30/115	10/50/135
d ₀	8	8	8	10	10	10	10
h ₂	65	85	105	85	95	105	125
l	75	95	115	95	105	115	135
t _{fix}	10	30	50	10	20	30	50
SW	13	13	13	17	17	17	17
Maße	10/80/165	10/100/185	12/10/110	12/20/120	12/30/130	12/50/150	12/80/180
d ₀	10	10	12	12	12	12	12
h ₂	165	175	100	110	120	140	180
l	80	185	110	120	130	150	80
t _{fix}	100	100	10	20	30	50	100
SW	17	17	19	19	19	19	19
Maße	12/100/200	12/120/220	12/160/260	12/200/300	16/25/148	16/50/173	16/100/223
d ₀	12	12	12	12	16	16	16
h ₂	190	210	250	290	135	160	210
l	200	220	260	300	148	173	223
t _{fix}	100	120	160	200	25	50	100
SW	19	19	19	19	24	24	24
Maße	16/160/283	16/200/323	16/250/373	16/300/423	20/30/172	20/60/202	
d ₀	16	16	16	16	20	20	
h ₂	270	310	360	410	155	185	
l	283	323	373	423	172	202	
t _{fix}	160	200	250	300	30	60	
SW	24	24	24	24	30		

Verfügbare Abmessungen auf den folgenden Seiten:

Befestigungstechnik: [S. 681](#)

Artikel 88764

UPAT Expressanker IMC
mit 1 Spreizclip, Mutter und Scheibe
Baustoffe: BN, VD

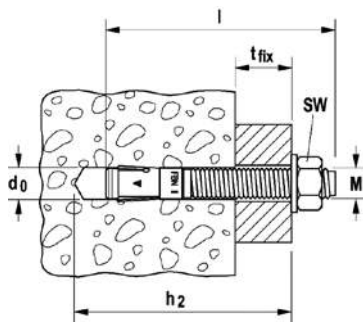
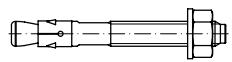

ETA-10/0169

Maße	6/10/55	8/5/56 K	8/5/66	8/10/71	8/20/81	8/30/91	8/50/111	8/100/161
d ₀	6	8	8	8	8	8	8	8
h ₂	50	51	61	66	76	86	106	156
l	55	56	66	71	81	91	111	161
t _{fix}	10/-	-/5	5/15	10/20	20/30	30/40	50/60	100/110
SW	13	13	13	13	13	13	13	13
Maße	10/5/71 K	10/10/86	10/20/96	10/30/106	10/50/126	10/100/176	12/5/86 K	12/10/106
d ₀	10	10	10	10	10	10	12	12
h ₂	63	78	88	98	118	168	75	95
l	71	86	96	106	126	176	86	106
t _{fix}	-/5	10/20	20/30	30/40	50/60	100/110	-/5	10/25
SW	17	17	17	17	17	17	19	19
Maße	12/20/116	12/30/126	12/50/146	12/100/196	12/120/216	12/140/236	12/160/256	12/180/276
d ₀	12	12	12	12	12	12	12	12
h ₂	105	115	135	185	205	225	245	265
l	116	126	146	196	216	236	256	276
t _{fix}	20/35	30/45	50/65	100/115	120/135	140/155	160/175	185/195
SW	19	19	19	19	19	19	19	19
Maße	12/200/296	12/250/346	16/15/120 K	16/25/145	16/50/170	16/100/220	16/140/260	16/160/280
d ₀	12	12	16	16	16	16	16	16
h ₂	285	335	105	129	154	204	244	264
l	296	346	120	145	170	220	260	280
t _{fix}	200/215	250/265	-/15	25/40	50/65	100/115	140/155	160/175
SW	19	19	24	24	24	24	24	24
Maße	16/200/321	16/250/371	16/300/421	20/30/184	20/60/214			
d ₀	16	16	16	20	20			
h ₂	304	354	404	165	195			
l	321	371	421	184	214			
t _{fix}	200/215	250/265	300/315	30/55	60/85			
SW	24	24	24	30	30			

Verfügbare Abmessungen auf den folgenden Seiten:

Befestigungstechnik: [S. 682](#)

Schwerlast-Befestigungen – Stahlanker

Artikel 88716

UPAT Einschlaganker USA
mit Anschluss-Innengewinde
Baustoffe: BN, VD

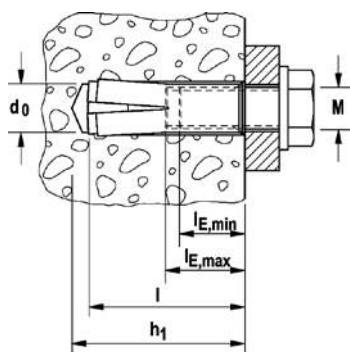
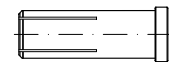

ETA-10/0172
ETA-10/0168

VdS-Zulassung ab M8

Verfügbare Abmessungen auf den folgenden Seiten:

Befestigungstechnik: [S. 682](#)

Maße	M 6	M 8	M 8x40	M 10	M 12	M 16	M 20
d_0	8	10	10	12	15	20	25
$l = h_{ef}$	30	30	40	40	50	65	80
$l_{E, min.}$	6	8	8	10	12	16	20
$l_{E, max.}$	13	13	13	17	22	28	34
h_1	32	33	43	43	54	70	85

Artikel 88722

UPAT Gewindestangen UKA 3-ASTA
mit Mutter und Scheibe

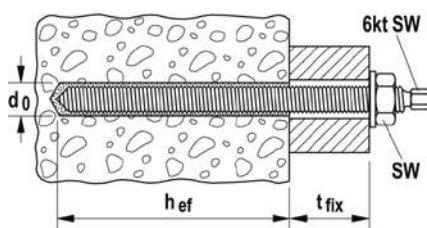

Zur Verwendung mit UKA 3-Patronen und
Injektionsmörtel UPM 55, UPM 44, UPM 33

Verfügbare Abmessungen auf den folgenden Seiten:

Befestigungstechnik: [S. 683](#)

Maße	M 8x110	M 8x150	M 8x190	M 10x130	M 10x165	M 10x190
d_0	10	10	10	12	12	12
t_{fix}	13	60	96	20	57	82
h_{ef}	80	80	80	90	90	90
SW 6-kant	5	5	5	5	7	7

Maße	M 12x160	M 12x180	M 12x220	M 12x250	M 12x300	M 14x170
d_0	14	14	14	14	14	16
t_{fix}	25	50	90	120	170	38
h_{ef}	110	110	110	110	110	120
SW 6-kant	8	8	8	8	8	10

Maße	M 16x165	M 16x190	M 16x250	M 16x300	M 20x220	M 20x260
d_0	18	18	18	18	25	25
t_{fix}	13	35	98	148	30	65
h_{ef}	125	125	125	125	170	170
SW 6-kant	12	12	12	12	12	12

Maße	M 20x300	M 20x350	M 22x280	M 24x300	M 27x340	M 30x380
d_0	25	25	30	28	32	35
t_{fix}	105	155	65	65	60	65
h_{ef}	170	170	210	210	250	280
SW 6-kant	12	12	12	-	-	-

Schwerlast-Befestigungen – Chemie

Artikel 88714

UPAT Innengewindehülsen UKA 3-IST

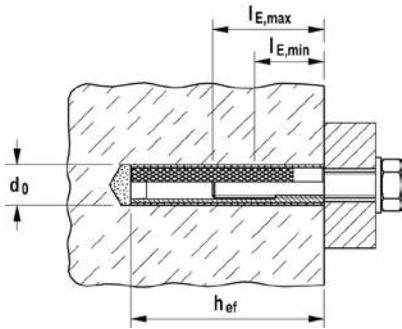
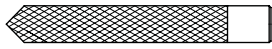

Maße	M 5	M 6	M 8	M 10	M 12	M 16	M 20
d_0	10	12	14	18	20	24	32
$h_{ef \text{ min.}}^*$	75/-	75/-	90/80	90/80	125/115	160/160	200/-

* Stahl verz./A 4

Verfügbare Abmessungen auf den folgenden Seiten:

Befestigungstechnik: [S. 632](#)

Artikel 88770

UPAT Innengewindeanker UPM-I



Maße	M 6	M 8	M 10	M 12
d_0	14	14	18	18

d_0 = Bohrlochdurchmesser

Verfügbare Abmessungen auf den folgenden Seiten:

Befestigungstechnik: [S. 633](#)

Schwerlast-Befestigungen - Chemie

Artikel 88735

UPAT Siebhülse UPM-SH-K



Maße	12	16	20
d_0	12	16	20
passend zu UPM-A	M 6 - M 8	M 8 - M 10	M 12 - M 16
passend zu UPM-I	-	M 6 - M 8	M 6 - M 12

d_0 = Bohrl Lochdurchmesser

Verfügbare Abmessungen auf den folgenden Seiten:

Befestigungstechnik: [S. 633](#)

Artikel 88720

UPAT Mörtelpatrone UKA 3-PLUS

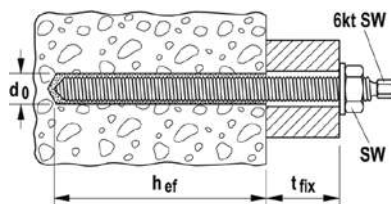
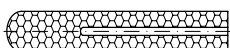

Maße	M 8	M 10	M 12	M 14	M 16
$t = h_{ef}$	80	90	110	120	125
passend zu ASTA	M 8	M 10	M 12	M 14	M 16
passend zu IST	M 5	M 6	M 8	M 10	-
Maße	M 20	M 22	M 24	M 27	M 30
$t = h_{ef}$	170	210	210	250	280
passend zu ASTA	M 20	M 22	M 24	M 27	M 30
passend zu IST	M 20	-	-	-	-



ETA-17/0197

Verfügbare Abmessungen auf den folgenden Seiten:

Befestigungstechnik: [S. 633](#)

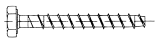

Das „MULTI-MONTI® – Montagesystem“ ist eine schnelle, sichere, zeit- und kostensparende Schraub-Befestigungs-Methode.

Ohne Dübel und ohne Spreizdruck werden mit „MULTI-MONTI® – Schraubanker“ Bauteile direkt montiert an Baugründen wie

- Beton, Naturstein
- Kalksandstein
- Vollziegel, Klinker
- Hohlblockbeton

„MULTI-MONTI® – Schraubanker MMS-plus“ sind gut geeignet für alle üblichen allgemeinen Befestigungen.

Artikel/MULTI-MONTI®-Typ

88902

Typ MMS-plus SS
Sechskantkopf
Stahl galZn

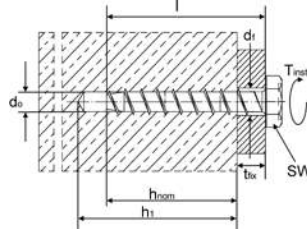
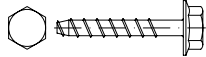

ETA 15/0784



Z-21.1-2103



Ø x l	Sechskant SW	Bohrer Ø	Klemmbereich t _{fix}	Einschraubtiefe h _{nom}	Scheiben-Ø
6 x 40	8	5,0	5	35	11,0
6 x 50	8	5,0	5 - 15	45 - 35	11,0
6 x 60	8	5,0	15 - 25	45 - 35	11,0
6 x 80	8	5,0	35 - 45	45 - 35	11,0
7,5 x 35	10	6,0	1	35	14,0
7,5 x 40	10	6,0	5	35	14,0
7,5 x 50	10	6,0	15	35	14,0
7,5 x 60	10	6,0	5 - 25	55 - 35	14,0
7,5 x 80	10	6,0	25 - 45	55 - 35	14,0
7,5 x 100	10	6,0	45 - 65	55 - 35	14,0
7,5 x 120	10	6,0	65 - 85	55 - 35	14,0
7,5 x 140	10	6,0	85 - 105	55 - 35	14,0
10 x 60	13	8,0	10	50	19,0
10 x 70	13	8,0	5 - 20	65 - 50	19,0
10 x 80	13	8,0	15 - 30	65 - 50	19,0
10 x 100	13	8,0	35 - 50	65 - 50	19,0
10 x 120	13	8,0	55 - 70	65 - 50	19,0
10 x 140	13	8,0	75 - 90	65 - 50	19,0
10 x 160	13	8,0	95 - 110	65 - 50	19,0
12 x 80	15	10,0	5	75	22,0
12 x 90	15	10,0	1 - 15	90 - 75	22,0
12 x 100	15	10,0	10 - 25	90 - 75	22,0
12 x 120	15	10,0	30 - 45	90 - 75	22,0
12 x 140	15	10,0	50 - 65	90 - 75	22,0
12 x 160	15	10,0	70 - 85	90 - 75	22,0
16 x 120	21	14,0	5 - 20	115 - 100	30,0
16 x 130	21	14,0	15 - 30	115 - 100	30,0

Zulässige Tragfähigkeit → TI-204



Artikel/MULTI-MONTI®-Typ

88903
Typ St
Stockanker
Stahl galZn

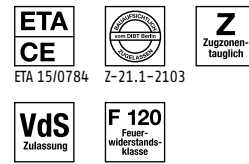
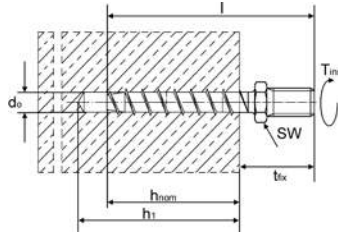
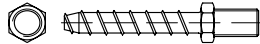

Ø x l	Sechskant SW	Bohrer Ø	Klemmbereich t _{fix}	Einschraubtiefe h _{nom}	Anschlussgewinde
6 x 55	10	5,0	10 - 20	45 - 35	M 6 x 5
6 x 65	10	5,0	20 - 30	45 - 35	M 6 x 5
7,5 x 60	10	6,0	25	35	M 8 x 14
7,5 x 70	10	6,0	35	35	M 8 x 14
7,5 x 80	10	6,0	25 - 45	55 - 35	M 8 x 14
7,5 x 100	10	6,0	45 - 65	55 - 35	M 8 x 14
7,5 x 120	10	6,0	65 - 85	55 - 35	M 8 x 14
10 x 75	13	8,0	25	50	M 10 x 11
10 x 85	13	8,0	20 - 35	65 - 50	M 10 x 11

Artikel/MULTI-MONTI®-Typ

88908
Typ P
Pan Head
Stahl galZn

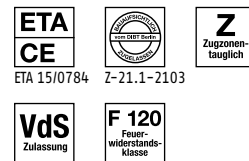
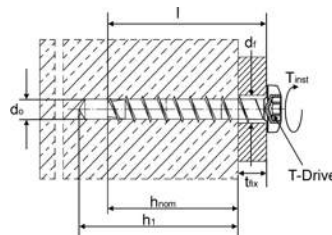
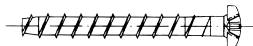

Ø x l	Antrieb	Bohrer Ø	Klemmbereich t _{fix}	Einschraubtiefe h _{nom}	Kopf-Ø
6 x 35	T30	5,0	1	35	11,2
6 x 40	T30	5,0	5	35	11,2
6 x 50	T30	5,0	5 - 15	45 - 35	11,2
6 x 60	T30	5,0	15 - 25	45 - 35	11,2
7,5 x 35	T30	6,0	1	35	14,5
7,5 x 40	T30	6,0	5	35	14,5
7,5 x 50	T30	6,0	15	35	14,5
7,5 x 60	T30	6,0	5 - 25	55 - 35	14,5
10 x 60	T40	8,0	10	50	19,5
10 x 70	T40	8,0	5 - 20	65 - 50	19,5

Zulässige Tragfähigkeit → TI-202

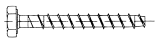

Artikel/MULTI-MONTI®-Typ

88905

Typ F
Flach-Senkopf
Stahl galZn

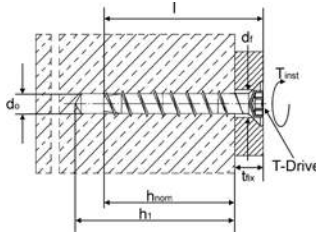
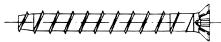

ETA 15/0784



Z-21.1-2103



Zugzone-tauglich



Ø x l	Antrieb	Bohrer Ø	Klemmbereich t _{fix}	Einschraubtiefe h _{nom}	Kopf-Ø
6 x 40	T30	5,0	5	35	11,5
6 x 50	T30	5,0	5 - 15	45 - 35	11,5
6 x 60	T30	5,0	15 - 25	45 - 35	11,5
6 x 70	T30	5,0	25 - 35	45 - 35	11,5
6 x 80	T30	5,0	35 - 45	45 - 35	11,5
6 x 100	T30	5,0	55 - 65	45 - 35	11,5
6 x 120	T30	5,0	75 - 85	45 - 35	11,5
6 x 140	T30	5,0	95 - 105	45 - 35	11,5
7,5 x 45	T40	6,0	10	35	15,5
7,5 x 50	T40	6,0	15	35	15,5
7,5 x 60	T40	6,0	5 - 25	55 - 35	15,5
7,5 x 70	T40	6,0	15 - 35	55 - 35	15,5
7,5 x 80	T40	6,0	25 - 45	55 - 35	15,5
7,5 x 100	T40	6,0	45 - 65	55 - 35	15,5
7,5 x 120	T40	6,0	65 - 85	55 - 35	15,5
7,5 x 140	T40	6,0	85 - 105	55 - 35	15,5
7,5 x 160	T40	6,0	105 - 125	55 - 35	15,5
10 x 60	T45	8,0	10	50	19,5
10 x 70	T45	8,0	5 - 20	65 - 50	19,5
10 x 80	T45	8,0	15 - 30	65 - 50	19,5
12 x 90	T50	10,0	15	75	24,0
12 x 100	T50	10,0	10 - 25	90 - 75	24,0
12 x 120	T50	10,0	30 - 45	90 - 75	24,0

Tabelle: Tragfähigkeiten von MULTI-MONTI®-plus Schraubankern

MULTI-MONTI®-plus	Ø 6	Ø 7,5	Ø 10	Ø 12
Mauerziegel Zulassung: Z-21.1-2103				
Einschraubtiefe	35/45	35/55	65	75
Tragfähigkeit N _{RK} [kN]	0,9/1,5	0,75/1,2	2,5	1,5
Tragfähigkeit V _{RK} [kN]	0,9/1,5	0,75/1,2	2,5	1,5
Kalksandvollstein Zulassung: Z-21.1-2103				
Einschraubtiefe	35/45	35/55	65	75
Tragfähigkeit N _{RK} [kN]	1,5	0,9/1,2	0,9	0,9
Tragfähigkeit V _{RK} [kN]	1,5	0,9/1,2	0,9	0,9
Kalksandlochstein Zulassung: Z-21.1-2103				
Einschraubtiefe	35/45	35/55	65	75
Tragfähigkeit N _{RK} [kN]	0,9	0,9	1,5	1,5
Tragfähigkeit V _{RK} [kN]	0,9	0,9	1,5	1,5
Leichtbeton Zulassung: Z-21.1-2103				
Einschraubtiefe	-	-	65	75
Tragfähigkeit N _{RK} [kN]	-	-	0,75	0,75
Tragfähigkeit V _{RK} [kN]	-	-	0,75	0,75
Gerissener Beton C20/25 Zulassung: ETA-15/0784				
Einschraubtiefe	35/45	35/55	50/65	75/90
Zul. Tragkraft N _{Zul} [kN]	0,5/0,7	1,0/2,0	3,0/4,4	5,9/7,9
Ungerissener Beton C20/25 Zulassung: ETA-15/0784				
Einschraubtiefe	35/45	35/55	50/65	75/90
Zul. Tragkraft N _{Zul} [kN]	2,7/4,0	2,0/7,1	5,4/8,8	10,7/14,6



Normen und Normenumstellung für Blindniete

Für den Einsatz von Blindniete als berechenbare Konstruktionselemente war es erforderlich, Bemaßungen, mechanische Eigenschaften wie Zug- und Scherkräfte und allgemeine Qualitätsanforderungen normativ einheitlich zu regeln.

Das erfolgte in der nationalen Norm DIN 7337 „Blindniete mit Sollbruchdorn“ – erste Veröffentlichung Mai 1985 – korrigierte Fassung Juli 1985 – Folgeausgabe August 1991.

DIN 7337 – 08.91 enthält die Ausführungen Form A Flachkopf und Form B Senkkopf. Im Mai 1997 wurde der Entwurf „Offene Blindniete mit Sollbruchdorn“ als vorgesehene Folgeausgabe für DIN 7337 – 08.91 mit der zusätzlichen Form C großer Flachkopf veröffentlicht. Im Jahre 1997 haben die internationalen und europäischen Normungsebenen ISO und EN die Normung der Blindniete übernommen. Zunächst wurden die Grundnormen ISO 14588 und 14589 im August 2001 veröffentlicht.

Im April 2003 folgten die Produktnormen ISO 15973–16585 – für jede Materialkombination/Ausführung/Form eine separate Norm.

Hierfür wurde die DIN 7337 inkl. Entwurf zurückgezogen. ①

Über die genormten Ausführungen hinaus werden Spezialtypen für besondere Einsatzfälle angeboten!

Normenarten, Ausführungen, Kopfformen	DIN 7337		ISO – Normen		Artikel-Nummer
	Material-Bez. Niet/Dorn	in DIN 7337	Material-Bez. ② Niet/Dorn	ISO	
Grundnormen:					
– „Blindniete: Begriffe und Definition“	–	enthalten	–	14588	–
– „Blindniete: Mechanische Prüfung“	–		–	14589	–
Produkt-Normen:					
– Offene Blindniete Flachkopf	Al-Leg./St. verz. St. verz./St. verz. Al-Leg./Al-Leg. A 2/A 2 Kupfer/St. verz. Kupfer/Bronze – NiCu/St. verz. NiCu/A 4 – A 2/St. verz. A 4/A 4 Al-Leg./A 2 Kst./Kst.	als Form A enthalten	AIA/St. St./St. AIA/AIA A 2/A 2 Cu/St. Cu/Br Cu/SSt NiCu/St. NiCu/SSt A 2/SSt – – – – –	15977 15979 15981 15983 16582 16582 16582 16584 16584 16585 – – – – –	88402, 88417 88401 88410 88404 88406 88407 – – 88493 – 88405 88415 88403 88408
– Offene Blindniete Senkkopf	Al-Leg./St. verz. St. verz./St. verz. – – – – –	als Form B enthalten	AIA/St. St./St. AIA/AIA A 2/A 2 Cu/St. Cu/Br Cu/SSt	15978 15980 15982 15984 16583 16583 16583	88412 88411 – – – – –
– Offene Blindniete großer Flachkopf	Al-Leg./St. verz. St. verz./St. verz. Al-Leg./Al-Leg. Al-Leg./A 2	als Form C enthalten	– – – –	– – – –	88409 88413 88414 88416
– Geschlossene Blindniete Flachkopf	Al-Leg./St. phos. – – – Al-Leg./A 2 Kupfer/St. Cu-Leg./A 2	–	AIA/St. Al/AIA St./St. A 2/SSt – – –	15973 15975 15976 16585 – – –	88420(CAP) – – – 88420(CAP) 88420(CAP) 88420(CAP)
– Geschlossene Blindniete Senkkopf	–	–	AIA/St.	15974	–

① Für die Umstellung auf die ISO-Normen bedarf es seitens der Produktion einer gewissen Anpassungs-/Übergangszeit – bis auf weiteres gelten für die angebotenen Blindniete die Artikelbeschreibungen und Artikelnummern in den Artikelköpfen dieses Kataloges – darauf beziehen sich auch die technischen Informationen im TI-Teil dieses Katalogs.

Für Ausführungen und/oder Materialkombinationen, für die derzeit noch keine Normen angegeben sind, ist ggf. mit nachträglicher ISO-Normung oder mit einer Restnorm DIN 7337 zu rechnen.

② AIA = Aluminium Alloy (Al-Legierung) – SSt = Stainless Steel (nichtrostender Stahl)
St. = Stahl (soll mit Schutz für Lagerhaltung versehen sein – z. B. verzinkte Ausführung)



Blindniete: Funktion und Montageablauf

Die Blindniet-Technik wurde als Befestigungsverfahren an Hohlprofilen und für ähnliche einseitig zugängliche Einsatzbereiche entwickelt. Das einfache, schnelle und daher sehr wirtschaftliche Blindniet-Prinzip hat inzwischen in vielen Montagebereichen herkömmliche Verbindungs- und Befestigungsaufgaben abgelöst – und findet ständig neue Anwendungsgebiete.

Das Sortenangebot ist so umfangreich, dass für jeden Einsatzzweck eine geeignete Ausführung zur Verfügung steht.

Die angebotenen Setzgeräte sind ergonomisch geformt und für einen langlebigen Profieinsatz gestaltet.

① Von der Werkstück-Vorderseite aus wird der Blindniet in das Bohrloch eingeführt. Der Zugdorn wird bis zur Kopfanlage vom Mundstück des Setzwerkzeuges aufgenommen. Die Blindnietgröße richtet sich nach Belastung und Materialstärke.

② Durch Betätigung des Setzwerkzeuges wird das überstehende Ende der Niethülse durch den Zugdornkopf zu einem Schließkopf umgeformt. Die Materialien werden in diesem Zuge zusammengepresst.

③ Der Nietdorn reißt vorprogrammiert an der Sollbruchstelle ab – eine feste Nietverbindung ist fertiggestellt.

Maße Blindniete

Offene Blindniete mit Flachkopf

R 88401
St. verz./St. verz.

R 88402
Al-Leg./St. verz.

R 88403
Al-Leg./A 2

R 88404
A 2/A 2

R 88405
A 2/St. verz.

R 88406
Cu/St. verz.

R 88407
Cu/Bronze

R 88410
Al-Leg./Al-Leg.

R 88415
A 4/A 4

R 88417
Al-Leg./St. verz.

R 88493
NiCu/A 4

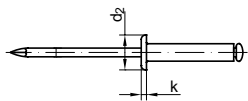

1) A 4 ~ ISO 15983

Nenn-Ø	2,4	3	3,2	4	4,8	5	6	6,4
d ₂	5	6,5	6,5	8	9,5	9,5	12	13
k	0,65	1,0	1,0	1,2	1,3	1,3	1,5	1,8
Bohrer Ø	2,5	3,1	3,3	4,1	4,9	5,1	6,1	6,5

Werkstoffe Niethülse	Scherkräfte (Zugkräfte)							
AL-LEG. (ISO 15977)	350 (550)	550 (850)	750 (1100)	1250 (1800)	1850 (2600)	2150 (3100)	3200 (4600)	3400 (4850)
STAHL (ISO 15979)	650 (700)	950 (1100)	1100 (1200)	1700 (2200)	2900 (3100)	3100 (4000)	4300 (4800)	4900 (5700)
A 2, A 4 ¹⁾ (ISO 15983)	-	1800 (2200)	1900 (2500)	2700 (3500)	4000 (5000)	4700 (5800)	-	-
CU (ISO 16582)	-	760 (950)	800 (1000)	1500 (1800)	2000 (2500)	-	-	-
NICU – MONEL (ISO 16584)	-	-	1400 (1900)	2200 (3000)	3300 (3700)	-	-	5500 (6800)

Länge	Klemmlängenbereiche (min. – max.)							
4	0,5-1,5	0,5-1,5	0,5-1,5	-	-	-	-	-
5	-	1,5-2,5	-	0,5-1,5	-	-	-	-
6	1,5-3,5	2,5-3,5	1,5-3,5	1,5-3,0	2,0-2,5	2,0-2,5	-	-
8	3,5-5,0	4,5-5,0	3,5-5,0	4,0-5,0	2,5-4,5	2,5-4,5	2,0-3,0	-
10	-	5,0-7,0	5,0-7,0	5,0-6,5	4,5-6,0	4,5-6,0	3,0-5,0	-
12	-	7,0-9,0	7,0-9,0	6,5-8,5	6,0-8,0	6,0-8,0	5,0-7,0	2,0-6,0
14	-	9,0-11,0	9,0-11,0	8,5-10,5	8,0-10,0	8,0-10,0	-	-
16	-	11,0-13,0	11,0-13,0	10,5-12,5	10,0-12,0	10,0-12,0	7,0-11,0	6,0-10,0
18	-	13,0-15,0	13,0-15,0	10,5-12,5	12,0-14,0	12,0-14,0	11,0-13,0	10,0-12,0
20	-	15,0-17,0	15,0-17,0	14,5-16,5	14,0-15,0	14,0-15,0	13,0-15,0	12,0-14,0
25	-	17,0-22,0	17,0-22,0	16,5-21,5	15,0-20,0	15,0-20,0	15,0-20,0	14,0-18,0
30	-	22,0-26,0	-	21,5-26,0	20,0-25,0	20,0-25,0	20,0-24,0	18,0-23,0
35	-	-	-	26,0-30,0	-	25,0-30,0	24,0-29,0	-
40	-	-	-	30,0-35,0	-	30,0-35,0	29,0-34,0	-
45	-	-	-	-	-	35,0-40,0	-	-
50	-	-	-	-	-	40,0-45,0	34,0-44,0	-
60	-	-	-	-	-	48,0-52,0	-	-
65	-	-	-	-	-	52,0-57,0	-	-
70	-	-	-	-	-	57,0-62,0	-	-
80	-	-	-	-	-	62,0-72,0	-	-



Bestimmung der Niet-Nennlänge:

Für Blindniete mit glatten Nietschäften und Kopftypen A, B, C oder ähnlich kann die geeignete Nennlänge nach der Faustformel bestimmt werden:

Klemmlänge (Materialdicke) + 1 x Niet-Nenn Ø = Niet-Nennlänge min.*

(*Bei Zwischenergebnissen ist die nächstgrößere Nietlänge zu wählen)

Die Zuordnung der Niet-Nennlänge nach Klemmlänge/Materialdicke differiert bei Standard-Blindniete geringfügig – zwischen Norm-Angaben und Werks-Angaben – nach unterschiedlichen Werkstoff-Kombinationen.

Nietloch-/Bohrungsdurchmesser:

Für Blindniete Form A, B, C entsprechend oder ähnlich der jeweiligen Produktnorm sowie für „CAP“- und „PolyGrip“-Mehrbereichs-Blindniete wird der Nietloch-/Bohrloch-Durchmesser nach der Faustformel bestimmt:

Niet-Nenn-Ø d1 + 0,1 mm (Tol. + 0,1 mm) = Nietloch-/Bohrloch-Ø D3

Für Blindniet-Muttern gilt:

Schaft-Ø d1/SW + 0,1 mm = Bohr-/Stanz-/Loch-Ø D3

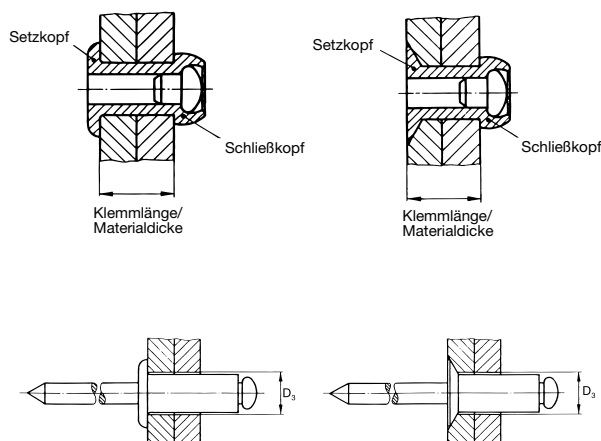

Maße Blindniete

Offene Blindniete mit Flachkopf

ähnlich DIN 7337-A

R 88408

Kunststoff

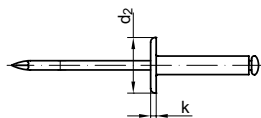

Nenn-Ø	4	5	6
d ₂	9	11	13
k	1,2	1,5	1,5
Bohrer Ø	4,1	5,1	6,1
Werkstoff Niethülse	Scherkräfte min. in N (Zugkräfte min. in N)		
Kunststoff	180 (-)	290 (-)	440 (-)
Länge	Klemmlängenbereiche (min. - max.)		
8	0,5 - 5,0	0,5 - 5,0	0,5 - 5,0
12	5,0 - 9,0	5,0 - 9,0	5,0 - 9,0

Offene Blindniete mit großem Flachkopf

nach DIN 7337-C

R 88409

Al-Leg./St verz.

R 88413

St. verz./St. verz.

R 88414

Al-Leg./Al-Leg.

R 88416

Al-Leg./A 2

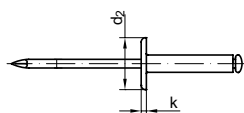

Nenn-Ø	3,2	4	4,8	5
d ₂	9,5	12	16	11/14
k	1,3	1,6	1,8	1,8
Bohrer Ø	3,3	4,1	4,9	5,1
Werkstoff Niethülse	Scherkräfte min. in N ① (Zugkräfte min. in N) ①			
Al-Leg./St.	720 (950)	1400 (2000)	1800 (2700)	2000 (2800)
Länge	Klemmlängenbereiche (min. - max.)			
6	1,5 - 3,5	1,5 - 3,0	-	-
8	3,5 - 5,0	3,0 - 5,0	2,5 - 4,5	2,5 - 4,5
10	5,0 - 7,0	5,0 - 6,5	4,5 - 6,0	4,5 - 6,0
12	7,0 - 9,0	6,5 - 8,5	6,0 - 8,0	6,0 - 8,0
14	-	-	-	8,0 - 10,0
16	9,0 - 13,0	8,5 - 12,5	8,0 - 12,0	10,0 - 12,0
18	-	12,5 - 16,5	-	12,0 - 14,0
20	-	-	12,0 - 15,0	14,0 - 15,0
25	-	-	15,0 - 20,0	15,0 - 20,0
30	-	-	-	20,0 - 25,0

① Angaben nach DIN 7337



Maße Blindniete

Offene Blindniete mit Senkkopf

nach DIN 7337-B

R 88411

St. verz./St. verz.

R 88412

Al-Leg./St. verz.

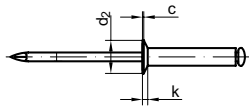

Nenn-Ø	3	4	5
d ₂	6,0	7,5	9,0
k	0,9	1,0	1,2
c	0,3	0,3	0,4
Bohrer Ø	3,1	4,1	5,1

Scherkräfte (Zugkräfte)

Angaben sind identisch mit Artikel 88401/ISO 15979 (siehe TI-200)

Länge	Klemmlängenbereiche (min. – max.)		
4 St./Al.	-1,0 – 1,5	-	-
6 St./Al.	1,0 – 3,0/1,5 – 3,5	1,0 – 2,5/1,0 – 3,0	1,0 – 2,0/-
8 St./Al.	3,0 – 5,0/3,5 – 5,0	2,5 – 4,5/3,0 – 5,0	2,0 – 4,0/2,0 – 4,5
10 St./Al.	5,0 – 6,5/5,0 – 7,0	4,5 – 6,5/5,0 – 6,5	4,0 – 6,0/4,5 – 6,0
12 St./Al.	6,5 – 8,5/7,0 – 9,0	6,5 – 8,5/6,5 – 8,5	6,0 – 8,0/6,0 – 8,0
14 St./Al.	-	-	8,0 – 9,5/-
16 St./Al.	-9,0 – 13,0	8,5 – 12,0/8,5 – 12,5	
18 St./Al.	-	-12,5 – 14,5	
20 St./Al.	-	12,0 – 16,0/14,5 – 16,5	
25 St./Al.	-	-	

Gerillte Blindniete mit Flachkopf

für Sacklöcher

R 88419 G

Al-Leg./St. verz.

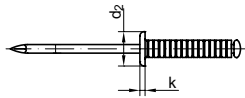

Nenn-Ø	3,2	4
d ₂	6,5	8
k	1	1,2
Bohrer Ø	3,3	4,1

Werkstoff Niethülse	Scherkräfte min. in N (Zugkräfte min. in N)	
Al-Leg.	720 (950)	1400 (2000)

Länge	Dicke des aufzunietenden Teiles (- max.)	
8	-	4
10	6	-
12	-	8
14	-	-
16	12	12
18	-	-
20	-	-
25	-	-

Geschlossene Blindniete mit Flachkopf

für luft- & wasserdichte Vernietungen

R 88420 F

Al-Leg./St.ph

Al-Leg./A 2

Cu/St.geölt

Cu/A 2

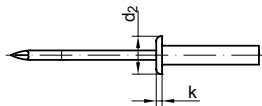

Nenn-Ø	3,2	4	4,8
d ₂	6	8	9,5
k	1,1	1,3	1,8
Bohrer Ø	3,3	4,1	4,9

Werkstoff Niethülse	Scherkräfte min. in N (Zugkräfte min. in N) ①		
Al-Leg. (~ISO 15973)	1050 (1250)	1550 (2100)	2400 (3500)
Cu	1000 (1400)	1500 (2200)	2100 (3100)

Länge	Klemmlängenbereiche (min. – max.)		
6,5	0,5 – 2,0	-	-
7,5	1,0 – 3,0	-	-
8	1,5 – 3,0	0,5 – 3,0	1,0 – 3,0
9,5	3,0 – 5,0	3,0 – 5,0	3,0 – 5,0
10,5	5,0 – 6,5	-	-
11	4,5 – 6,5	4,5 – 6,5	4,5 – 6,5
12,5	6,0 – 8,0	6,0 – 8,0	6,0 – 8,0
14	-	-	7,5 – 9,5
16	-	-	9,0 – 11,0
18	-	-	10,5 – 13,0
21	-	-	13,0 – 16,0

① Herstellerangaben



Maße Blindniete

Offene Blindniete mit Gewinde

R 88421

St. verz./St. verz.
Festigkeitsklasse Schraube = 8.8

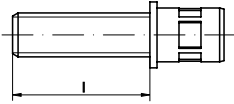

Nenn-Ø	M 4	M 5	M 6	M 8
Loch-Ø	6,1	7,1	9,1	11,1
l	10	11,5	13	15,5
Werkstoff Niethülse	Scherkräfte min. in N (Gewindebruchkraft min. in N)			
St.	5160 (6030)	7200 (10800)	10800 (17800)	18400 (27800)
Klemmlängenbereiche (min. – max.)				
	0,25 – 3,0	0,25 – 3,0	0,25 – 3,0	0,25 – 3,0

Offene Blindniete mit Flachkopf und Spreizschaft

R 88422

Al-Leg./St. verz.

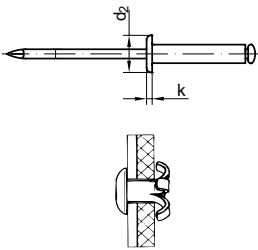

Nenn-Ø	3,2	4	4,8
d ₂	6,5	8	9,5
k	1	1,2	1,3
Bohrer Ø	3,3	4,1	4,9
Werkstoff Niethülse	Scherkräfte min. in N (Zugkräfte min. in N)		
Al-Leg.	800 (950)	1.400 (2.000)	2.000 (2.700)
Länge	Klemmlängenbereiche (min. – max.)		
8	1,0 – 3,5	1,0 – 3,0	-
10	2,5 – 5,0	2,5 – 5,0	2,5 – 5,0
12	4,5 – 7,0	4,5 – 6,5	4,5 – 7,0
14	-	6,0 – 8,0	6,5 – 9,0
16	6,5 – 11,0	7,5 – 10,0	8,5 – 10,0
18	-	9,0 – 12,0	9,5 – 12,0
20	-	11,5 – 14,0	11,5 – 14,0
25	-	-	13,5 – 19,0

Mehrbereichs-Blindniete mit Flachkopf

R 88474

Al-Leg./St. verz.
St. verz./St. verz.
Al-Leg./A 2
A 2/A 2
A 4/A 4

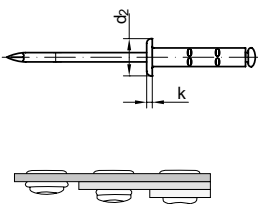

Nenn-Ø	3,2	4	4,8	6,4
d ₂	6,5	8	9,5	13
k	0,8	1	1,3	-
Bohrer Ø	3,3	4,1	4,9	6,5
Werkstoff Niethülse	Scherkräfte min. in N (Zugkräfte min. in N)			
Al-Leg.	720 (1.050)	1.060 (1.680)	1.500 (2.300)	2.800 (4.000)
Stahl	1.200 (1.600)	1.650 (2.400)	2.400 (3.200)	4.000 (6.100)
A 2/A 4	1.450 (2.300)	2.650 (3.600)	4.000 (5.000)	7.800 (8.800)
Länge	Klemmlängenbereiche (min. – max.)			
8	0,5 – 5,0	-	-	-
9,5	1,5 – 6,5	-	-	-
10	-	0,5 – 6,5	0,5 – 6,5	-
11	3,0 – 8,0	-	-	-
13	-	3,5 – 9,5	-	-
15	-	-	4,5 – 11,0	1,5 – 9,0
17	-	7,0 – 13,0	6,5 – 13,0	-
20	-	-	-	6,0 – 14,0
25	-	-	11,0 – 19,5	10,0 – 18,0
30	-	-	16,0 – 24,0	-



DIBT-Zulassung Z14.1-4 für
Ø 4,8 Al-Leg./St. und Al-Leg./A 2



Maße Blindniete

Mehrbereichs-Blindniete mit großem Flachkopf

R 88475

Al-Leg./St. verz.
St. verz./St. verz.
Al-Leg./A 2

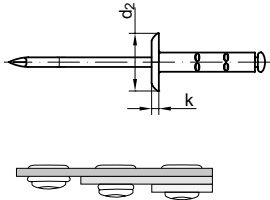

Nenn-Ø	3,2	4	4,8
d ₂	9,5	12	16
k	1,3	1,5	1,8
Bohrer Ø	3,3	4,1	4,9
Werkstoff Niethülse	Scherkräfte min. in N (Zugkräfte min. in N)		
Al-Leg.	720 (1.050)	1.060 (1.680)	1.600 (2.270)
Stahl	1.200 (1.600)	1.650 (2.400)	2.400 (3.200)
Länge	Klemmlängenbereiche (min. – max.)		
8	0,5 – 5,0	-	-
9,5	1,5 – 6,5	-	-
10	-	0,5 – 6,5	0,5 – 6,5
11	3,0 – 8,0	-	-
13	-	3,5 – 9,5	-
15	-	-	4,5 – 11,0
17	-	7,0 – 13,0	6,5 – 13,0
25	-	-	11,0 – 19,5
30	-	-	16,0 – 24,0

Hochfeste Blindniete mit Flachkopf

R 88476

St. verz./St. verz.

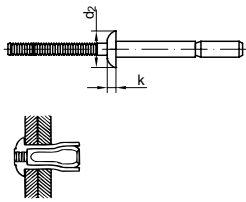

Nenn-Ø	4,8	6,4
d ₂	9,2	12,4
k	2,2	2,6
Bohrer Ø	4,9	6,5
Werkstoff Niethülse	Scherkräfte min. in N (Zugkräfte min. in N)	
St.	6.850 (4.500)	12.500 (8.200)
Länge	Klemmlängenbereiche (min. – max.)	
10,5	1,6 – 6,4	-
14,1	-	2,0 – 9,5
14,5	5,5 – 11,1	-
20,5	-	2,0 – 15,9

Hochfeste Blindniete mit Senkkopf

R 88477

St. verz./St. verz.

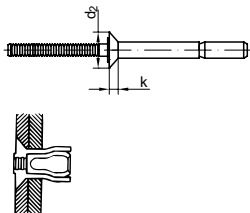

Nenn-Ø	4,8	6,4
d ₂	8,9	11
k	2,2	2,6
Bohrer Ø	4,9	6,5
Werkstoff Niethülse	Scherkräfte min. in N (Zugkräfte min. in N)	
St.	6.850 (4.500)	12.500 (8.200)
Länge	Klemmlängenbereiche (min. – max.)	
10,5	1,6 – 6,4	-
14,1	-	2,0 – 9,5
14,5	5,5 – 11,1	-



Maße Blindniete

Pressflaschen-Blindniete

R 88488

Al-Leg./Al-Leg.

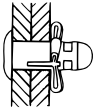
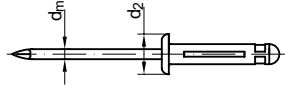

Nenn-Ø	4,8
d ₂	10,1
d _m	2,9
Bohrer Ø	4,9
Werkstoff Niethülse	Scherkräfte min. in N (Zugkräfte min. in N)
Al-Leg.	1.100 (1.400)
Länge	Klemmlängenbereiche (min. - max.)
22,2	4,7 - 9,5
25,4	7,9 - 12,7



Blindnietmuttern: Funktion und Montageablauf

Durch die Kombination zweier Befestigungsmöglichkeiten bieten Blindnietmuttern Kosten- und Qualitätsvorteile. Zum einen wird eine Nietverbindung erzeugt durch Vernietung der Mutter mit einem Blech und zum anderen entsteht eine Schraubverbindung. Durch diese Kombination ist ein Einsatz für dünnwandige Bauteile möglich, bei denen ein Einbringen von Gewinde aufgrund der geringen Materialstärke problematisch ist. Ein weiterer Vorteil ist, dass eine lösbare Schraubverbindung ohne Wärmeeinwirkung entsteht und somit ein unkontrollierter Wärmeverzug in den Bauteilen verhindert wird. Zusätzlich können unterschiedliche Werkstoffe miteinander verbunden werden.

	<p>① Die Blindnietmutter wird auf den Gewindedorn aufgeschraubt und von der Werkstück-Vorderseite aus in das Bohrloch eingeführt. Die Länge der Blindnietmutter richtet sich nach der Materialstärke.</p>
	<p>② Durch Betätigung des Setzwerkzeuges verformt sich die Blindnietmutter – ein festsitzendes Gewinde ist sekundenschnell, unverrückbar und fest, hergestellt. Zugleich können in diesem Zuge Materialien zusammengepresst werden.</p>
	<p>③ Nach Herausschrauben des Gewindedornes kann mit einer metrischen Schraube ein zusätzliches Teil befestigt werden.</p>

In der folgenden Tabelle sind die Mindest-Gewindebruchkraft und Richtwerte für ein Anziehdrehmoment angegeben. Die Gewindebruchkraft wird unter axialer Zugbelastung im kleinsten und größten Klemmbereich der Blindnietmutter ermittelt. Das Anziehdrehmoment wird mit einer fettfreien Schraube der Festigkeitsklasse 10.9 und einer gehärteten Scheibe als Klemmteil geprüft.

Tabelle 1: Mindest-Gewindebruchkraft und Richtwerte für Anziehdrehmomente

Gewinde-nenn-Ø	Werkstoff	Blindnietmuttern rund		Geschlossene Blindnietmuttern		Mehrbereichs-Blindnietmuttern		Blindnietmuttern mit 6-kant	
		Gewinde-bruchkraft [N]	Anzieh-drehmoment [Nm]	Gewinde-bruchkraft [N]	Anzieh-drehmoment [Nm]	Gewinde-bruchkraft [N]	Anzieh-drehmoment [Nm]	Gewinde-bruchkraft [N]	Anzieh-drehmoment [Nm]
M 4	Stahl verzinkt	6800	3	5000	3	5200	4	5200	3
	Alu	2400	2	-	-	3000	3	-	-
	A 2/A 4	5800	2,5	-	-	-	-	6800	3
M 5	Stahl verzinkt	7000	6	9500	6	9500	6	10000	6
	Alu	4000	4	4300	4	4200	4	-	-
	A 2/A 4	10000	6	-	-	15000	14	10000	6
M 6	Stahl verzinkt	13500	10	13000	9	15500	11	15000	12
	Alu	6000	6	6700	6	6500	6	-	-
	A 2/A 4	15000	10	-	-	25000	27	15000	10
M 8	Stahl verzinkt	22000	4	21000	18	21500	24	23500	24
	Alu	10500	17,5	11000	17,5	10500	17,5	-	-
	A 2/A 4	27000	24	-	-	30000	40	28000	30
M 10	Stahl verzinkt	28000	30	37000	50	-	-	-	-
	Alu	14000	28	-	-	-	-	-	-
	A 2	-	-	-	-	-	-	37000	48

Maße Blindnietmuttern

Offene Blindnietmuttern mit kleinem Senkkopf

R 88418
Al-Leg.
Stahl verz.**
A 2**
A 4**

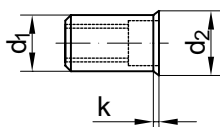

Nenn-Ø	M 4	M 5	M 6	M 8
d ₁	6	7	9	11
d ₂ *	7	8	10	12
k*	0,6	0,6	0,6	0,6
Bohrer Ø	6,1	7,1	9,1	11,1

Verfügbare Klemmlängen → Preiseiten

*Maße können je nach Fabrikat abweichen
**sukzessive Umstellung auf gerändelten Schaft



Maße Blindnietmuttern

Offene Blindnietmuttern mit Flachkopf

R 88423
Al-Leg.
Stahl verz. **
A 2**
A 4**

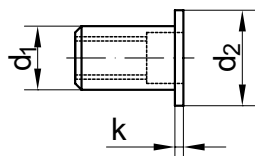

Nenn-Ø	M 4	M 5	M 6	M 8	M 10
d ₁	6	7	9	11	12
d ₂ *	9	10	12	15	15
k*	0,8	1	1,5	1,5	1,5
Bohrer Ø	6,1	7,1	9,1	11,1	12,1

Verfügbare Klemmlängen → Preiseiten

Offene Blindnietmuttern mit Flachkopf und Mehrbereichsschaft für variable Klemmlängen

R 88490
Al-Leg.
Stahl verz.
A 2

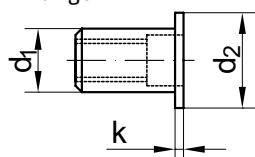

Nenn-Ø	M 4	M 5	M 6	M 8
d ₁	6	7	9	11
d ₂ *	10	11	13	16
k*	0,8	1,0	1,5	1,5
Bohrer Ø	6,1	7,1	9,1	11,1
Klemmlänge	0,5 – 6,0	0,5 – 6,0	0,5 – 6,0	0,5 – 7,5

Offene Blindnietmuttern mit Senkkopf

R 88424
Al-Leg.
Stahl verz. **
A 2*
A 4*

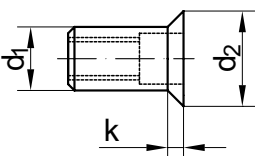

Nenn-Ø	M 4	M 5	M 6	M 8	M 10
d ₁	6	7	9	11	12
d ₂ *	9	10	12	14	15
k*	1,5	1,5	1,5	1,5	1,5
Bohrer Ø	6,1	7,1	9,1	11,1	12,1

Verfügbare Klemmlängen → Preiseiten

Offene Blindnietmuttern mit Senkkopf und Mehrbereichsschaft für variable Klemmlängen

R 88491
Al-Leg.
Stahl verz.

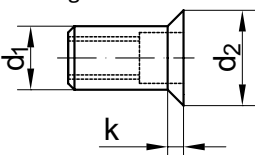

Nenn-Ø	M 4	M 5	M 6	M 8
d ₁	6	7	9	11
d ₂ *	10	11	13	16
k*	1,5	1,5	1,5	1,5
Bohrer Ø	6,1	7,1	9,1	11,1
Klemmlänge	1,5 – 6,0	1,5 – 6,0	1,5 – 6,0	1,5 – 7,5

Geschlossene Blindnietmuttern mit Flachkopf

R 88480
Al-Leg.
Stahl verz.

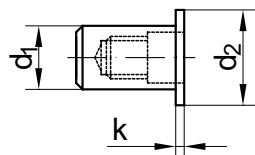

Nenn-Ø	M 5	M 6	M 8	M 10
d ₁	7	9	11	13
d ₂ *	11	12	15	19
k*	1,0	1,3	1,4	2,0
Bohrer Ø	7,1	9,1	11,1	13,1

Verfügbare Klemmlängen → Preiseiten

Geschlossene Blindnietmuttern mit Senkkopf

R 88481
Al-Leg.
Stahl verz.

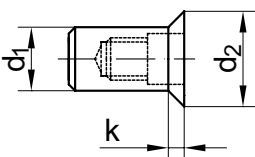

Nenn-Ø	M 4	M 5	M 6	M 8
d ₁	6	7	9	11
d ₂ *	9	10	12	14
k*	1,5	1,5	1,5	1,5
Bohrer Ø	6,1	7,1	9,1	11,1

Verfügbare Klemmlängen → Preiseiten

*Maße können je nach Fabrikat abweichen
**sukzessive Umstellung auf gerändelten Schaft



Maße Blindnietmuttern

Offene Blindnietmuttern mit Sechskant und Flachkopf

R 88483
Stahl verz.
A 2

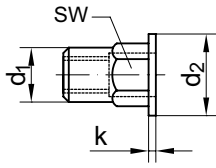

Nenn-Ø	M 4	M 5	M 6	M 8	M 10
d ₁	6	7	9	11	13
d ₂ *	9	10	13	15	16,5
k*	0,8	1	1,5	1,5	2,0
Sechskant	SW 6	SW 7	SW 9	SW 11	SW 13
Montageloch	SW 6 +0,1	SW 7 +0,1	SW 9 +0,1	SW 11 +0,1	SW 13 +0,1

Verfügbare Klemmlängen → Preiseiten

Offene Blindnietmuttern mit Sechskant und kleinem Senkkopf

R 88484
Stahl verz.
A 2

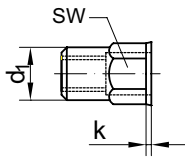

Nenn-Ø	M 4	M 5	M 6	M 8	M 10
d ₁	6	7	9	11	13
k*	0,6	0,6	0,6	0,6	0,7
Sechskant	SW 6	SW 7	SW 9	SW 11	SW 13
Montageloch	SW 6 +0,1	SW 7 +0,1	SW 9 +0,1	SW 11 +0,1	SW 13 +0,1

Verfügbare Klemmlängen → Preiseiten

*Maße können je nach Fabrikat abweichen



Maß-, Form- und Lagetoleranzen für Schrauben und Muttern werden überwiegend in ISO 4759-1 festgelegt. Darüber hinaus legen folgende Normen ebenfalls Toleranzen für spezielle Anforderungen fest:

Gewindeläufe und Gewindefreistiche	Gewindeenden (→ TI-140)	Splintlöcher	Oberflächenrauheit
<ul style="list-style-type: none"> • ISO 3508 • ISO 4755 • DIN 76-1 	<ul style="list-style-type: none"> • ISO 4753 • DIN 78 • DIN 962 	<ul style="list-style-type: none"> • ISO 7378 • DIN 34803 	<ul style="list-style-type: none"> • DIN 267-2

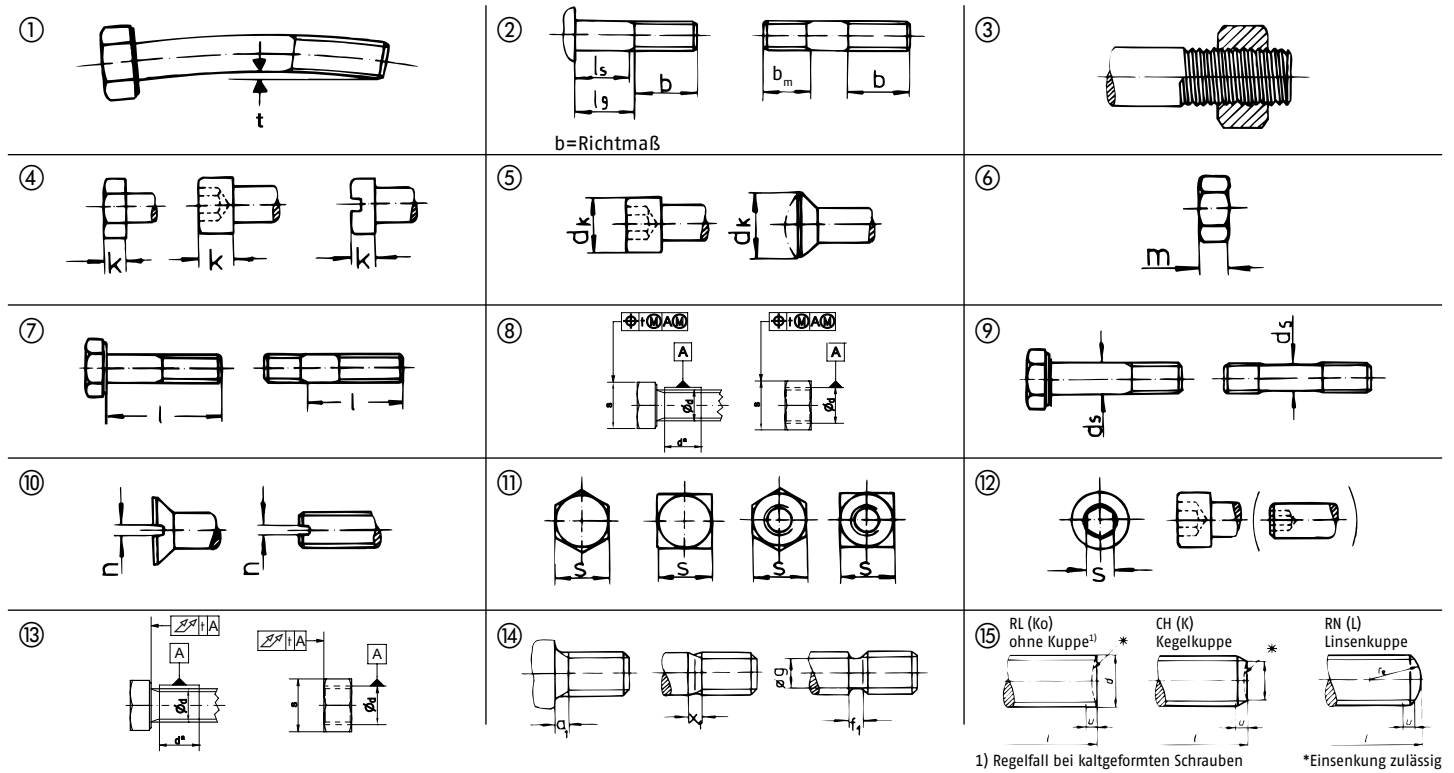

Merkmale	Maßbereich	Produktklasse A	Produkt-klasse B	Produktklasse C
① Geradheit (zul. Durchbiegung) (l = Nennlänge)	t	$d \leq 8$	$0,0020 l + 0,05$	$2x(0,0020 l + 0,05)$
	t	$d > 8$	$0,0025 l + 0,05$	$2x(0,0025 l + 0,05)$
② Gewindelänge Länge Einschraubende Stiftschraube	b		0 bis + 2 P	0 bis + 2 P
	b _m		js 16	js 17
③ Gewindemaß Mutter			6 H	7H
			6 g	8 g
④ Kopfhöhe Außenantrieb	k	$k < 10$	js 14	js 16
		$k \geq 10$		js 17
④ Kopfhöhe Innenantrieb	k	$\leq M 5$	h 13	-
		$\leq M 5$	h 14	-
⑤ Kopfdurchmesser	d _k	h 13 (Schlitzschrauben h 14)	-	-
⑥ Mutterhöhe	m	$\leq M 12$	h 14	h 17
		$> M 12 \leq M 18$	h 15	h 17
		$> M 18$	h 16	h 17
⑦ Nennlänge	l	$l \leq 150$	js 15 (Schlitzschrauben l > 50 js 16)	js 17
		$l > 150$	js 17	2 js 17
⑧ Positionstoleranz Schrauben	s:d	Bezugsmaß für t: s	2 IT 13	2 IT 15
	d _k :d	Bezugsmaß für t: d _k	2 IT 13	2 IT 15
Positionstoleranz Muttern	n:d	Bezugsmaß für t: d	2 IT 12	2 IT 14
	s:d (Kern)	Bezugsmaß für t: s	2 IT 13	2 IT 15
	n:d (Kern)	Bezugsmaß für t: d	2 IT 13	2 IT 15

Merkmal		Maßbereich	Produkt- klasse A	Produkt- klasse B	Produkt- klasse C
⑨ Schaftdurchmesser	ds		h 13	h 14	± IT 15
			Dünnschaft: Schaftdurchmesser ~ Flankendurchmesser		
⑩ Schlitzbreite	n	n ≤ 1	+0,20 bis +0,06	-	-
		n > 1 ≤ 3	+0,31 bis +0,06		
		n > 3 ≤ 6	+0,37 bis +0,07		
⑪ Schlüsselweite Außenantrieb	s		s m 32 = h 13 s > 32 = h 14	s m 19 = h 14/s > 19 m 60 = h 15 s > 60 m 180 = h 16/s > 180 = h 17	
⑫ Schlüsselweite Innenantrieb	s		s Tol. 0,7 EF8 0,9 FS9 1,3 K9 1,5-3 D11 4 E11 5-14 E12 > 14 D12	-	-
⑬ Gesamtplanlauftoleranz t ^b (= Winkligkeit) nach ISO 4759-1 Abschn. 3.2.2.3 (Schrauben) 4.2.2.2 (Muttern)	⊘	≤ M 39	(±1°) ^a	(±1°) ^a	(±2°) ^a
		> M 39	(±1/2°) ^a	(±1/2°) ^a	(±1°) ^a

a) Gesamtplanlauftoleranz entspricht einer Winkelabweichung von...

b) Werte für t sind ISO 4759-1 zu entnehmen

		⑭				⑮		
Außengewinde		a ₁	x ₁	g ₁ (f ₁)	g ₂ (f ₂)	u 2 p	z ₁ +	z ₂ +
NennØ M	Steigung P	max.	max.	min.	max.	max.	IT 14	IT 14
3	0,5	1,5	1,25	1,1	1,75	1	0,75	1,5
4	0,7	2,1	1,75	1,5	2,45	1,4	1	2
5	0,8	2,4	2	1,7	2,8	1,6	1,25	2,5
6	1	3	2,5	2,1	3,5	2	1,5	3
8	1,25	3,75	3,2	2,7	4,4	2,5	2	4
10	1,5	4,5	3,8	3,2	5,2	3	2,5	5
12	1,75	5,25	4,3	3,9	6,1	3,5	3	6
14	2	6	5	4,5	7	4	3,5	7
16	2	6	5	4,5	7	4	4	8
18	2,5	7,5	6,3	5,6	8,7	5	4,5	9

⑭ = Auszug aus ISO 3508/4755 (DIN 76)

a₁ = Abstand des letzten vollen Gewindegangs von der Anlagefläche (bei Teilen mit Gewinde bis Kopf)

x₁ = Gewindeauslauf Regelfall

g (f) = Gewindefreistich Regelfall (Form A)

		⑭				⑮		
Außengewinde		a ₁	x ₁	g ₁ (f ₁)	g ₂ (f ₂)	u 2 p	z ₁ +	z ₂ +
NennØ M	Steigung P	max.	max.	min.	max.	max.	IT 14	IT 14
20	2,5	7,5	6,3	5,6	8,7	5	5	10
22	2,5	7,5	6,3	5,6	8,7	5	5,5	11
24	3	9	7,5	6,7	10,5	6	6,7	12
27	3	9	7,5	6,7	10,5	6	6,7	13,5
30	3,5	10,5	9	7,7	12	7	7,5	15
33	3,5	10,5	9	7,7	12	7	8,2	16,5
36	4	12	10	9	14	8	9	18
39	4	12	10	9	14	8	9,7	19,5
42	4,5	13,5	11	10,5	16	9	10,5	21
45	4,5	13,5	11	10,5	16	9		22,5

⑮ = Auszug aus ISO 4753 (DIN 78)

u = unvollständiges Gewinde an Schraubenenden (Regelfall für Schrauben m. gerolltem Gewinde)

z₁ = Länge Kernansatz bei Ausführung Ka

z₂ = Länge Zapfen bei Ausführung Za (Z)

Oberflächenrauheit (nach DIN 267-2, in ISO nicht geregelt)			R _z		
			P < 2,5 l _m = 0,4 λ _c = 0,08	P ≥ 2,5 l _m = 1,25 λ _c = 0,25	nach DIN 4768 Teil 1
Gewindeflanken	Schrauben	gerollt	6,3	10	-
		geschnitten	16	25	-
	Muttern		25	40	-
Auflageflächen	Kaltfertigung		16	25	-
	Warmfertigung		25	40	-
Schaft bei Schrauben	Kaltfertigung		-	-	50
	Warmfertigung		-	-	100
Sichtflächen			10	-	-

Maß-, Form- und Lagetoleranzen für Scheiben sind in der ISO 4759-3 festgelegt.

Bei Maßen ohne Toleranzangabe gilt ISO 2768 (DIN 7168) m für Produktklasse A, ISO 2768 (DIN 7168) g für Produktklasse C.

Die dargestellten Scheiben sind nur Beispiele. Die Angaben gelten sinngemäß auch für andere genormte und nicht genormte Scheibenformen.

In den nachfolgenden Tabellen sind nur die Angaben für die handelsüblichen Produktklassen A und C aufgeführt.

Bezugsmaß ist das in den jeweiligen Produktnormen angegebene Einzelmaß.

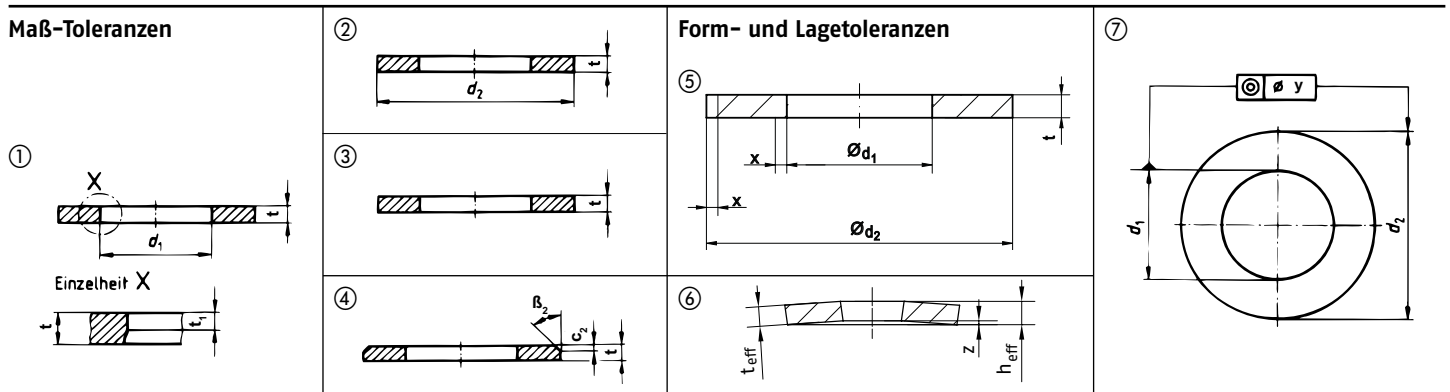

Maß-Toleranzen				
Merkmal	Nennmaß		Produktklasse	
	≥	<	A (m)	C (g)
① Lochdurchmesser d_1 * Die Toleranzen für das Loch \varnothing gelten nicht an der Ausbruchseite ($t - t_1$)	t		d_1	
	-	4	H 13	H 14
	4	-	H 14	H 15
	t		$t_1 \text{ min.}$	
② Außendurchmesser d_2	t		d_2	
	-	4	h 14	h 16
	4	-	h 15	h 16
	> t ≤		Tol. mm	
③ Scheibendicke t	-	0,5	± 0,05	± 0,10
	0,5	1,0	± 0,10	± 0,20
	1,0	2,5	± 0,20	± 0,30
	2,5	4,0	± 0,30	± 0,60
	4,0	6,0	± 0,60	± 1,00
	6,0	10	± 1,00	± 1,20
	10	20	± 1,20	± 1,60
④ Fase $\beta_2 = 35^\circ \text{ bis } 45^\circ$	> t ≤		$c_2 \text{ min.}$	
	1	2	0,25t	0,25t
	2	4	0,22t	0,22t
	4	-	0,20t	0,20t

Auszug aus ISO 4759-3

Form- und Lagetoleranzen					
Merkmal	Nennmaß		Produktklasse		
	>	≤	A (m)	C (g)	
⑤ Dickenunterschied am selben Teil * Δt gilt in einem Abstand von jeweils $x = 0,1 (d_2 - d_1)$ von der Kante des Loches und der Außenkontur, d.h. nur für 60% der Ringbreite	t		Δt^*		
	-	0,5	0,025	-	
	0,5	1,0	0,05	-	
	1,0	2,5	0,10	-	
	2,5	4,0	0,15	-	
	4,0	6,0	0,20	-	
	6,0	10	0,30	-	
⑥ Ebenheit Die Ebenheit wird nach dem Entgraten gemessen.	t		z		
	ausgenommen nicht rostender Stahl				
	-	0,5	0,10	-	
	0,5	1,0	0,15	-	
	1,0	2,5	0,20	-	
	2,5	4,0	0,30	-	
	4,0	6,0	0,40	-	
	6,0	10	0,60	-	
	nicht rostender Stahl				
	-	0,5	0,15	-	
0,5	1	0,22	-		
1	2,5	0,30	-		
2,5	4	0,45	-		
4	6	0,60	-		
6	10	0,90	-		
10	20	1,5	-		
⑦ Koaxialität y (Bezugselement für Toleranz y ist d_2)	≥ t <		y max		
	-	2	2 IT 12	2 IT 13	
	2	4	2 IT 13	2 IT 14	
	4	-	2 IT 14	2 IT 15	

Toleranzfelder		Nennmaße													
		≤ 3	> 3 ≤ 6	> 6 ≤ 10	> 10 ≤ 18	> 18 ≤ 30	> 30 ≤ 50 (40)	> 50 ≤ 80	> 80 ≤ 120	> 120 ≤ 180	> 180 ≤ 250	> 250 ≤ 315	> 315 ≤ 400	> 400 ≤ 500	
IT-Werte in mm Grundtoleranzen	IT 12	0,10	0,12	0,15	0,18	0,21	0,25	0,30	0,35	0,40	0,46	0,52	0,57	0,63	
	IT 13	0,14	0,18	0,22	0,27	0,33	0,39	0,46	0,54	0,63	0,72	0,81	0,89	0,97	
	IT 14	0,25	0,30	0,36	0,43	0,52	0,62	0,74	0,87	1,00	1,15	1,30	1,40	1,55	
	IT 15	0,40	0,48	0,58	0,70	0,84	1,00	1,20	1,40	1,60	1,85	2,10	2,30	2,50	
	IT 16	0,60	0,75	0,90	1,10	1,30	1,60	1,90	2,20	2,60	2,90	3,20	3,60	4,00	
	IT 17	1,00	1,20	1,50	1,80	2,10	2,50	3,00	3,50	4,00	4,60	5,20	5,70	6,30	
für Außenmaße in mm	a 11	-0,270 -0,330	-0,270 -0,345	-0,280 -0,370	-0,290 -0,400	-0,300 -0,430	-0,310 -0,470								
	c 11	-0,060 -0,120	-0,070 -0,145	-0,080 -0,170	-0,095 -0,205	-0,110 -0,240	-0,120 -0,280								
	f 8	-0,006 -0,020	-0,010 -0,028	-0,013 -0,035	-0,016 -0,043	-0,020 -0,053	-0,025 -0,064	-0,030 -0,076	-0,036 -0,090	-0,043 -0,106	-0,050 -0,122	-0,056 -0,137	-0,062 -0,151	-0,068 -0,165	
	h 8	0/-0,014	0/-0,018	0/-0,022	0/-0,027	0/-0,033	0/-0,039	0/-0,046	0/-0,054	0/-0,063	0/-0,072	0/-0,081	0/-0,089	0/-0,097	
	h 9	0/-0,025	0/-0,030	0/-0,036	0/-0,043	0/-0,052	0/-0,062	0/-0,074	0/-0,087	0/-0,100	0/-0,115	0/-0,130	0/-0,140	0/-0,155	
	h 10	0/-0,040	0/-0,048	0/-0,058	0/-0,070	0/-0,084	0/-0,100	0/-0,120	0/-0,140	0/-0,160	0/-0,185	0/-0,210	0/-0,230	0/-0,250	
	h 11	0/-0,060	0/-0,075	0/-0,090	0/-0,110	0/-0,130	0/-0,160	0/-0,190	0/-0,220	0/-0,250	0/-0,290	0/-0,320	0/-0,360	0/-0,400	
	h 13	0/-0,14	0/-0,18	0/-0,22	0/-0,27	0/-0,33	0/-0,39	0/-0,46	0/-0,54	0/-0,63	0/-0,72	0/-0,81	0/-0,89	0/-0,97	
	h 14	0/-0,25	0/-0,30	0/-0,36	0/-0,43	0/-0,52	0/-0,62	0/-0,74	0/-0,87	0/-1,00	0/-1,15	0/-1,30	0/-1,40	0/-1,55	
	h 15	0/-0,40	0/-0,48	0/-0,58	0/-0,70	0/-0,84	0/-1,00	0/-1,20	0/-1,40	0/-1,60	0/-1,85	0/-2,10	0/-2,30	0/-2,50	
	h 16	0/-0,60	0/-0,75	0/-0,90	0/-1,10	0/-1,30	0/-1,60	0/-1,90	0/-2,20	0/-2,50	0/-2,90	0/-3,20	0/-3,60	0/-4,00	
	h 17	0/-1,00	0/-1,20	0/-1,50	0/-1,80	0/-2,10	0/-2,50	0/-3,00	0/-3,50	0/-4,00	0/-4,60	0/-5,20	0/-5,70	0/-6,30	
	js 14	±0,125	±0,150	±0,180	±0,215	±0,260	±0,310	±0,370	±0,435	±0,500	±0,575	±0,650	±0,700	±0,775	
	js 15	±0,200	±0,240	±0,290	±0,350	±0,420	±0,500	±0,600	±0,700	±0,800	±0,925	±1,050	±1,150	±1,250	
	js 16	±0,300	±0,375	±0,450	±0,550	±0,650	±0,800	±0,950	±1,100	±1,250	±1,450	±1,600	±1,800	±2,000	
	js 17	±0,500	±0,600	±0,750	±0,900	±1,050	±1,250	±1,500	±1,750	±2,000	±2,300	±2,600	±2,850	±3,150	
	k 6	+0,006 0	+0,009 +0,001	+0,010 +0,001	+0,012 +0,001	+0,015 +0,002	+0,018 +0,002								
	m 6	+0,008 +0,002	+0,012 +0,004	+0,015 +0,006	+0,018 +0,007	+0,021 +0,008	+0,025 +0,009								
für Innenmaße in mm	D 9	+0,045 +0,020	+0,060 +0,030	+0,076 +0,040	+0,093 +0,050	+0,117 +0,065	+0,142 +0,080								
	D 10	+0,060 +0,020	+0,078 +0,030	+0,098 +0,040	+0,120 +0,050	+0,149 +0,065	+0,180 +0,080								
	D 11	+0,080 +0,020	+0,105 +0,030	+0,130 +0,040	+0,160 +0,050	+0,195 +0,065	+0,240 +0,080								
	D 12	+0,120 +0,020	+0,150 +0,030	+0,190 +0,040	+0,230 +0,050	+0,275 +0,065	+0,330 +0,080								
	E 11	+0,074 +0,014	+0,095 +0,020	+0,115 +0,025	+0,142 +0,032	-	-								
	E 12	+0,100 +0,014	+0,140 +0,020	+0,175 +0,025	+0,212 +0,032	-	-								
	EF 8	+0,024 +0,010	+0,032 +0,014	+0,040 +0,018	-	-	-								
	H 9	+0,025 0	+0,030 0	+0,036 0	+0,043 0	+0,052 0	+0,062 0								
	H 11	+0,060 0	+0,075 0	+0,090 0	+0,110 0	+0,130 0	+0,160 0								
	H 13	+0,140 0	+0,180 0	+0,220 0	+0,270 0	+0,330 0	+0,390 0								
	H 14	+0,250 0	+0,300 0	+0,360 0	+0,430 0	+0,520 0	+0,620 0								
	H 15	+0,400 0	+0,480 0	+0,580 0	+0,700 0	+0,840 0	+1,000 0								
JS 9	±0,0125	±0,015	±0,018	±0,0215	±0,026	±0,031									
K 9	0 -0,025	0 -0,030	0 -0,036	-	-	-									

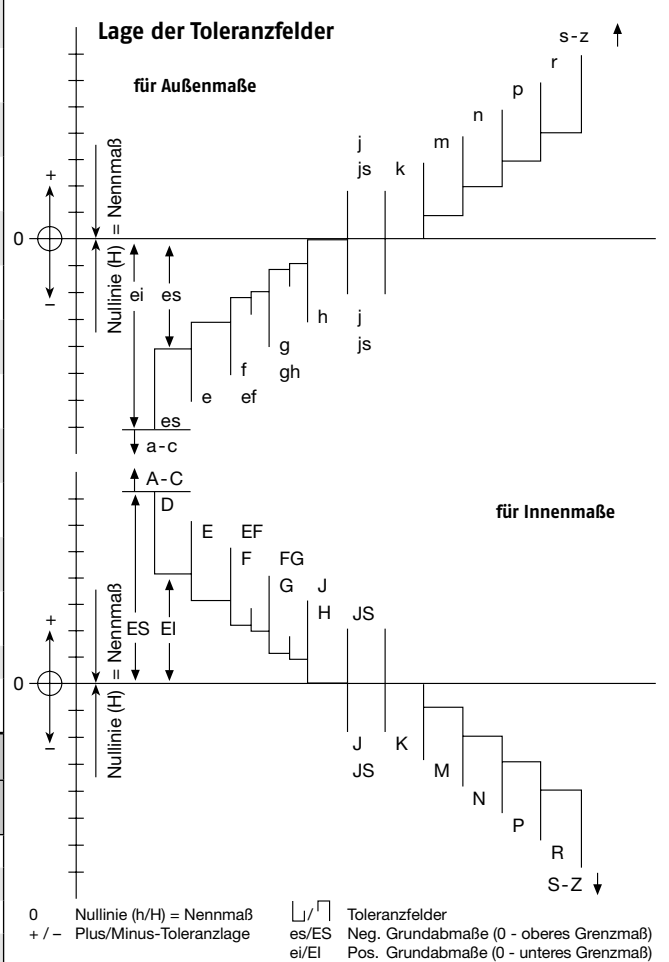

Aszüge aus ISO 286, 965, 4759 (DIN 267-2, 7160, 7161, 7168)



Gewinde ist technisch ausgedrückt „eine um einen Zylinder gleichförmig gewundene schiefe Ebene“.

Dieses Prinzip ermöglicht sowohl ein Auf-/Einschrauben als auch ein Ab-/Ausschrauben und bildet damit das Grundmerkmal für „wiederlösbare“ Verbindungen = Schrauben und Muttern.

Mit der geometrischen Form und dem genormten Maß- und Toleranzsystem sind die Voraussetzungen für die Paarung und Austauschbarkeit gleichartiger Gewindeprofile geschaffen.

Gewinde-Profil, Gewinde-Messpunkte

Das Grundprofil und die 5 Messpunkte des Gewindes sind in Bild A dargestellt.

Die Maßprüfung wird beim Außengewinde (Schraube) durch Lehrringe, Flankenmikrometer oder optisches Messgerät und beim Innengewinde (Mutter) durch Lehrdorne durchgeführt.

Bild A:
Gewinde-Profil mit
5 Messpunkten

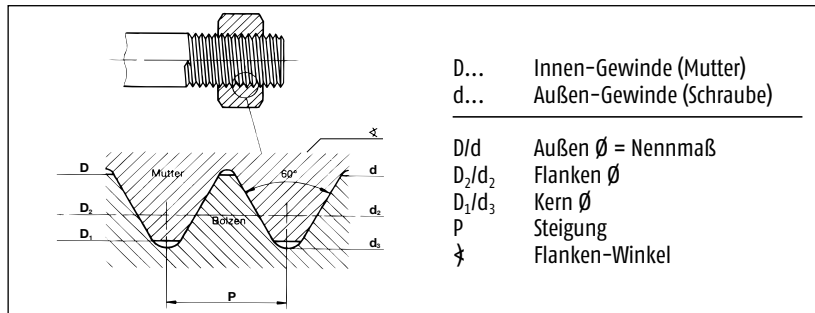

D... Innen-Gewinde (Mutter)
d... Außen-Gewinde (Schraube)

D/d Außen \emptyset = Nennmaß
D₂/d₂ Flanken \emptyset
D₁/d₃ Kern \emptyset
P Steigung
 α Flanken-Winkel

Gewinde-Arten

Tabelle 1 zeigt eine Übersicht der gängigen Gewinde-Arten für Schrauben und Muttern. Als Basis für eine weltweit einheitliche Normung (ISO) für 'Mechanische Verbindungselemente' gilt seit 1963 das metrische ISO-Gewinde.

Tabelle 1: Übersicht der gängigen Gewinde-Arten für mechanische Verbindungselemente (Auszug aus DIN 202)

Kennbuchstabe	Benennung	Ausführung	Anwendung	Bezeichnungsbispiel	Flanken α	nach Norm
M	Metrisches ISO-Gewinde	Regelgewinde	rechtsgängig	M 20x80	60°	ISO 724 (DIN 13-1)
M-LH		Regelgewinde	linksgängig	M 20x80 LH		
M		Feingewinde	rechtsgängig	M 20x2x80		
M-LH		Feingewinde	linksgängig	M 20x2x80 LH		
M-SN 4	Metrisches ISO-Gewinde mit Übergangstoleranzfeld	Festsitzgewinde	dichtend	M 20 Sn 4x80		DIN 13-51
M-Sk 6		Festsitzgewinde	nicht dichtend	M 20 Sk 6x80		
MFS				MFS 20x80		
M	Metrisches Gewinde mit großem Spiel	Bolzenschraubgewinde mit größerem Gewinde-Abmaß/Muttern-Tol. 6H		DIN 2510 M 20x80		DIN 2510-2
EG-M	Metrisches ISO-Gewinde: Aufnahme Gew. f. Gewindeeinsätze aus Draht	äußere Gewindemaße für Gewindeeinsätze mit Regel- und Feingewinde		EG M 20 / EG M 20x2		DIN 8140-2
M-az/M-AZ	Metrisches Gewinde für feuerverzinkte Schrauben und Muttern	Gewinde mit Untermaß bzw. Übermaß für feuerverzinkte Außen- und Innengewinde		M12-6az	60°	ISO 965-4 ISO 965-5
M-keg.	Metrisches kegeliges Außengewinde	für Verschlusschrauben und Schmiernippel		M 20x1.5 keg.		DIN 158-1
G	Zylindrisches Ww-Rohrgewinde f. nicht im Gew. dichtende Verbindung	für Rohre/Rohrverbindungen		G 3/4"	55°	ISO 228-1
R	Kegeliges Ww-Rohrgewinde f. nicht im Gew. dichtende Verbindung	für Außengewinde Rohre/Fittings/Rohrverschraubungen		R 3/4"		
Rp	Zylindrisches Ww-Rohrgewinde für im Gew. dichtende Verbindung	für Innengewinde Rohre/Fittings/Rohrverschraubungen		Rp 3/4"		
Tr	Metrisches ISO-Trapezgewinde (ein- und mehrgängig)	für allgemeine Anwendung		Tr 20x4	30°	ISO 2901-04 DIN 3975
Rd		Präzisions-Bewegungsgewinde für z.B. Spülrohrverschraubungen		Rd 20x1/8		
ST	Blechsraubengewinde			ST 4,2	60°	ISO 1478 DIN 7998
-	Holzschraubengewinde			-		
UNC	USA: zölliges Gewinde	Regelgewinde		3/4-10 UNC	60°	ANSI B 1.1 B.S. 1580-1.2
UNF		Feingewinde		3/4-16 UNF		
BSW	UK: zölliges Gewinde	Regelgewinde		3/4-10 BSW	55°	B.S. 84
BSF		Feingewinde		3/4-12 BSF		

Gewinde-Herstellung

- Spanlose Fertigung (= üblich für Großserienfertigung von Schrauben)
 - Walzen mittels Profil-Walzbacken (M 2-M 30)
 - Rollen mittels Profil-Rollen \geq M 20
- Spanende Fertigung
 - Schneiden mittels Profil-Schneideisen
 - Strehlen mittels Profil-Kluppe
 - Wirbeln mittels Profil-Schneideisen
 - Fräsen, Schleifen (für spezielle Bewegungsgewinde)



Gewinde-Passfähigkeit/-Schraubbarkeit

Für die Verschraubungsfähigkeit von Außen- und Innengewinde (z. B. Schraube mit Mutter) gehen die Normen grundsätzlich von der Funktionserfüllung bei Montage mit entsprechendem Werkzeug aus.

Bei zusätzlichen dickeren Beschichtungen/Überzügen und/oder erforderlichem leichtlaufenden Gewindenspiel (Handmontage) sind entsprechende Maßnahmen und Bestellvorgaben erforderlich!

Die wesentlichen Parameter für die Schraubbarkeit:

- **die Toleranz-Lage**
= Abstand des oberen Abmaßes des Außengewindes zum unteren Abmaß des Innengewindes
→ Bild B
- **das Toleranz-Feld**
(„Toleranz-Qualität“)
= Abstand untere zu oberer Abmaßgrenze
(Feldgröße es-ei/EI-ES)

- **die Einschraublänge**
Geringfügige Form- und Lageabweichungen, die sich längenabhängig als eine Art „Steigungsverzug“ bemerkbar machen, sind in der rationellen Massenproduktion fertigungsbedingt und unvermeidbar.

Deshalb sind die Einschraublängen des Außengewindes in das Innengewinde für Normal-Schraubverbindungen (= Einschraubgruppe N) nach ISO 965/DIN 13-14 steigungsabhängig begrenzt
→ Tabelle 3

Für längere Gewindeeingriffe (L) sind entsprechend größere Toleranzqualitäten zu wählen.

- **Oberflächenfehler/Beschädigungen am Gewinde**
Bei der Gewindefertigung können kleine Überwalzungen und/oder Profilabweichungen vorkommen – im weiteren Fertigungsablauf (Vergütung, Transport, Trommelbeschichtung) sind kleine Beschädigungen wie Dellen, Kerben und Schlagstellen unvermeidbar, die die Gängigkeit in Gewindelehren und im Gegengewinde erschweren.

Diese fertigungsbedingten Oberflächenfehler/Beschädigungen sind bis zu bestimmten Grenzen zulässig nach ISO 6157-1/-3 (DIN 267-19) für Schrauben bzw. nach ISO 6157-2 (DIN 267-20) für Muttern. Bei beschichteten Verbindungselementen sind auch ISO 4042 und ISO 10683 mit zu beachten.

Wenn für einzelne bestimmte Einsatzfälle besonders leichtgängige Gewinde erforderlich sein sollten, sind hierfür entweder größere Toleranzqualitäten oder ein nachträgliches „Glättwalzen“ mit Gewindegewinde vorzusehen.

Achtung! Die genormten zulässigen Belastbarkeiten für Schraubverbindungen gelten für die in den jeweiligen Produktnormen zugeordneten Toleranzen – Vergrößerungen der Toleranz-Lagenfelder führen verständlicherweise zu einer Reduzierung der Belastbarkeit im Gewindebereich!

Bild B: Toleranz-Lagen Toleranz-Felder



Tabelle 2: Empfohlene Toleranzfelder für Einschraublängen N (vor Aufbringen eines Korrosionsschutz-Überzuges*)

Toleranzklasse:		mittel		grob	
		Außengew. (Schraube)	Innengew. (Mutter)	Außengew. (Schraube)	Innengew. (Mutter)
f. Oberflächen-zustand	- ohne Überzug (blank)* - dünne galv. Überzüge**	6g*	6H*	8g*	7H*
	- mit großem Spiel (blank) - dicke galv. Überzüge**	6e	6G	8e	7G
Artikel-Produktklasse:		A, B (m, mg)		C (g)	
= z. B. DIN		931, 933	934	558, 601	555
ISO		4014, 4017	4032	4018, 4016	4034

* Übliche Toleranz ohne/vor Aufbringung von Überzügen

** → TI-217, Tabelle 8/TI-219, Tabelle 9

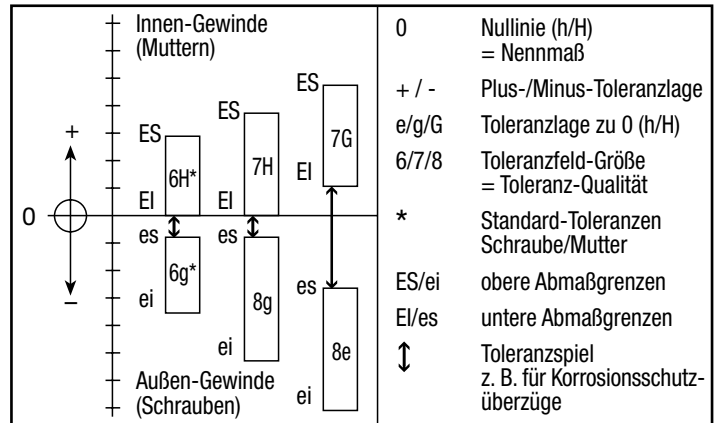
Tabelle 3: Einschraublängen N_{max.} für Regel- und Feingewinde (RG/FG)

Gewinde-Nenn Ø	d/D	M 5	M 6	M 8	M 10	M 12	M 14	M 18	M 24	M 30	M 36	M 42
							M 16	-M22	M 27	M 33	M 39	M 45
Steigung P	RG	0,8	1	1,25	1,5	1,75	2	2,5	3	3,5	4	4,5
	FG	0,5	0,75	1	1,25	1,5	1,5	2	2	2	3	3
Einschraublänge N _{max.}	RG	7,5	9	12	15	18	24	30	36	45	53	63
	FG	4,5	7,1	9	12	13	16	16	25	25	36	36



Tabelle 4: Grenzmaße AO – AU (min. – max.) für Außen- und Innengewinde (Bolzen/Mutter) mit Regel- und Feingewinde (RG/FG)
(Auswahl aus ISO 965-2 / DIN 13 - 20, 21, 22, 27)

Gewinde- Nenn Ø d/D	Steigung P		Flanken Ø Null-Linie h/H	Außen-/Bolzensgewinde							Innen-/Muttergewinde						
				Tol.- Feld/ -lage	Außen Ø d		Flanken Ø d ₂		Kern Ø d ₃		Tol.- Feld/ -lage	Außen Ø D		Flanken Ø D ₂		Kern Ø D ₃	
					max.	min.	max.	min.	max.	min.		min.	max.	min.	max.	min.	
M 3	0,5		2,675	6g	2,980	2,874	2,655	2,580	2,367	2,273	6H	3,000	2,775	2,675	2,599	2,459	
				6e	2,950	2,844	2,625	2,550	2,337	2,243	6G	3,020	2,795	2,695	2,619	2,479	
M 4	0,7		3,545	6g	3,978	3,838	3,523	3,433	3,119	3,002	6H	4,000	3,663	3,545	3,422	3,242	
				6e	3,944	3,804	3,489	3,399	3,085	2,968	6G	4,022	3,685	3,567	3,444	3,264	
M 5	0,8		4,480	6g	4,976	4,826	4,456	4,361	3,995	3,869	6H	5,000	4,605	4,480	4,334	4,134	
				6e	4,940	4,790	4,420	4,325	3,959	3,833	6G	5,024	4,629	4,504	4,358	4,158	
M 6	1		5,350	6g	5,974	5,794	5,324	5,212	4,747	4,596	6H	6,000	5,500	5,350	5,153	4,917	
				6e	5,940	5,760	5,290	5,178	4,713	4,562	6G	6,026	5,526	5,376	5,179	4,943	
M 8	1,25		7,188	6g	7,972	7,760	7,160	7,042	6,438	6,272	6H	8,000	7,348	7,188	6,912	6,647	
				8e	7,937	7,602	7,125	6,935	6,403	6,165	6G	8,028	7,376	7,216	6,940	6,675	
M 10	1,5	1	7,350	6g	7,974	7,794	7,324	7,212	6,747	6,596	6H	8,000	7,500	7,350	7,153	6,917	
				8e	7,933	7,558	7,077	6,887	6,355	6,117	6G	8,032	7,380	7,218	6,942	6,677	
M 12	1,75	1,25	9,026	6g	9,968	9,732	8,994	8,862	8,128	7,938	6H	10,000	9,206	9,026	8,676	8,376	
				8e	9,933	9,558	8,959	8,747	8,093	7,823	6G	10,032	9,238	9,058	8,708	8,408	
M 14	2	1,5	10,863	6g	11,966	11,701	10,829	10,679	9,819	9,602	6H	12,000	11,063	10,863	10,441	10,106	
				8e	11,929	11,504	10,792	10,556	9,782	9,479	6G	12,034	11,097	10,897	10,475	10,140	
M 16	1,5	1,5	11,026	6g	11,968	11,732	10,994	10,854	10,128	9,930	6H	12,000	11,216	11,026	10,676	10,376	
				8e	11,929	11,504	10,792	10,556	9,782	9,479	6G	12,034	11,097	10,897	10,475	10,140	
M 18	2	1,5	12,701	6g	13,962	13,682	12,663	12,503	11,508	11,271	6H	14,000	12,913	12,701	12,210	11,835	
				8e	13,929	13,479	12,630	12,380	11,475	11,148	6G	14,038	12,951	12,739	12,248	11,873	
M 20	2	1,5	13,026	6g	13,968	13,732	12,994	12,854	12,128	11,930	6H	14,000	13,216	13,026	12,676	12,376	
				8e	13,929	13,479	12,630	12,380	11,475	11,148	6G	14,038	12,951	12,739	12,248	11,873	
M 22	2,5	2	14,701	6g	15,962	15,682	14,663	14,503	13,508	13,271	6H	16,000	14,913	14,701	14,210	13,835	
				8e	15,929	15,479	14,630	14,380	13,475	13,148	6G	16,038	14,951	14,739	14,248	13,873	
M 24	2,5	2	15,026	6g	15,968	15,732	14,994	14,854	14,128	13,930	6H	16,000	15,216	15,026	14,676	14,376	
				8e	15,929	15,479	14,630	14,380	13,475	13,148	6G	16,038	14,951	14,739	14,248	13,873	
M 26	2,5	2	16,376	6g	17,958	17,623	16,334	16,164	14,891	14,625	6H	18,000	16,600	16,376	15,744	15,294	
				8e	17,920	17,390	16,296	16,031	14,853	14,492	6G	18,042	16,642	16,418	15,786	15,336	
M 28	2,5	2	16,701	6g	17,962	17,682	16,663	16,503	15,508	15,271	6H	18,000	16,913	16,701	16,210	15,835	
				8e	17,920	17,390	16,296	16,031	14,853	14,492	6G	18,042	16,642	16,418	15,786	15,336	
M 30	2,5	2	18,376	6g	19,958	19,623	18,334	18,164	16,891	16,625	6H	20,000	18,600	18,376	17,744	17,294	
				8e	19,920	19,390	18,296	18,031	16,853	16,492	6G	20,042	18,642	18,418	17,786	17,336	
M 32	2,5	2	18,701	6g	19,962	19,682	18,663	18,503	17,508	17,271	6H	20,000	18,913	18,701	18,210	17,835	
				8e	19,920	19,390	18,296	18,031	16,853	16,492	6G	20,042	18,642	18,418	17,786	17,336	
M 34	2,5	2	20,376	6g	21,958	21,623	20,334	20,164	18,891	18,625	6H	22,000	20,600	20,376	19,744	19,294	
				8e	21,920	21,390	20,296	20,031	18,853	18,492	6G	22,042	20,642	20,418	19,786	19,336	
M 36	2,5	2	20,701	6g	21,962	21,682	20,663	20,503	19,508	19,271	6H	22,000	20,913	20,701	20,210	19,835	
				8e	21,920	21,390	20,296	20,031	18,853	18,492	6G	22,042	20,642	20,418	19,786	19,336	
M 40	3	2	22,051	6g	23,952	23,577	22,003	21,803	20,271	19,955	6H	24,000	22,316	22,051	21,252	20,752	
				8e	23,915	23,315	21,966	21,651	20,234	19,803	6G	24,048	22,364	22,099	21,300	20,800	
M 45	3	2	22,701	6g	23,962	23,682	22,663	22,493	21,508	21,261	6H	24,000	22,925	22,701	22,210	21,835	
				8e	23,920	23,320	21,971	21,656	20,254	19,823	6G	24,048	22,370	22,105	21,306	20,806	
M 50	3	2	25,051	6g	26,952	26,577	25,003	24,803	23,271	22,955	6H	27,000	25,316	25,051	24,252	23,752	
				8e	26,915	26,315	24,966	24,651	23,234	22,803	6G	27,048	25,364	25,099	24,300	23,800	
M 55	3,5	2	25,701	6g	26,962	26,682	25,663	25,493	24,508	24,261	6H	27,000	25,925	25,701	25,210	24,835	
				8e	26,920	26,320	24,971	24,656	23,254	22,823	6G	27,048	25,370	25,105	24,306	23,806	
M 60	3,5	2	27,727	6g	29,947	29,522	27,674	27,462	25,653	25,306	6H	30,000	28,007	27,727	26,771	26,211	
				8e	29,910	29,240	27,637	27,302	25,616	25,146	6G	30,053	28,060	27,780	26,824	26,264	
M 65	3,5	2	28,701	6g	29,952	29,577	28,003	27,803	26,271	25,955	6H	30,000	28,316	28,051	27,252	26,752	
				8e	29,910	29,240	27,637	27,302	25,616	25,146	6G	30,053	28,060	27,780	26,824	26,264	
M 70	3,5	2	30,727	6g	32,947	32,522	30,674	30,462	28,653	28,306	6H	33,000	31,007	30,727	29,771	29,211	
				8e	32,910	32,240	30,637	30,302	28,616	28,146	6G	33,053	31,060	30,780	29,824	29,264	
M 75	3,5	2	31,701	6g	32,962	32,682	31,663	31,493	30,508	30,261	6H	33,000	31,925	31,701	31,210	30,835	
				8e	32,920	32,250	30,637	30,302	28,616	28,146	6G	33,053	31,060	30,780	29,824	29,264	
M 80	4	3	33,402	6g	35,940	35,465	33,342	33,118	31,033	30,655	6H	36,000	33,702	33,402	32,270	31,670	
				8e	35,905	35,155	33,307	32,952	30,998	30,489	6G	36,060	33,762	33,462	32,330	31,730	
M 90	4	3	34,051	6g	35,952	35,577	34,003	33,803	32,271	31,955	6H	36,000	34,316	34,051	33,252	32,752	
				8e	35,910	35,160	33,307	32,952	30,998	30,489	6G	36,060	33,762	33,462	32,330	31,730	

Tabelle 5: Maße in Millimeter für Ww-Rohrgewinde G/R/R_p

Gewinde-Nenn Ø in mm	Zoll	1/16	1/8	1/4	3/8	1/2	3/4	1	1 1/4	1 1/2	2	2 1/2	3
Außen Ø in mm	d/D	7,72	9,73	13,16	16,66	20,96	26,44	33,25	41,91	47,80	59,61	75,18	87,88
Abstand Messebene a		4,0	4,0	6,0	6,4	8,2	9,5	10,4	12,7	12,7	15,9	17,5	20,6

- G = Zylindrisches Außen-/Innengewinde
- R = Kegeliges Außengewinde
- R_p = Zylindrisches Innengewinde
- a = Abstand der Bezugsebene/Messebene vom Gewindeanfang in mm

Tabelle 6: Grenzmaße für UNC- und UNF-Gewinde nach ASME B 1.1

Gewinde Nenn Ø UNC/UNF Nr.	UNC/ UNF	Gangzahl G	Toleranzen für Außengewinde in Inch					Toleranzen für Innengewinde in Inch				
			Toleranzklasse 2A					Toleranzklasse 2B				
			Außen Ø	Flanken Ø		Kern Ø		Außen Ø	Flanken Ø		Kern Ø	
min.	max.	min.	max.	min.	min.	min.	max.	min.	max.			
2	UNC	56	0,0813	0,0854	0,0717	0,0738	0,0641	0,0860	0,0744	0,0772	0,0667	0,0737
	UNF	64	0,0816	0,0854	0,0733	0,0753	0,0668	0,0860	0,0759	0,0786	0,0691	0,0752
3	UNC	48	0,0938	0,0983	0,0825	0,0848	0,0735	0,0990	0,0855	0,0885	0,0764	0,0845
	UNF	56	0,0942	0,0983	0,0845	0,0867	0,0770	0,0990	0,0874	0,0902	0,0797	0,0865
4	UNC	40	0,1061	0,1112	0,0925	0,0950	0,0814	0,1120	0,0958	0,0991	0,0849	0,0939
	UNF	48	0,1068	0,1113	0,0954	0,0978	0,0865	0,1120	0,0985	0,1016	0,0894	0,0968
5	UNC	40	0,1191	0,1242	0,1054	0,1080	0,0944	0,1250	0,1088	0,1121	0,0979	0,1062
	UNF	44	0,1195	0,1243	0,1070	0,1095	0,0972	0,1250	0,1102	0,1134	0,1004	0,1079
6	UNC	32	0,1312	0,1372	0,1141	0,1169	0,1000	0,1380	0,1177	0,1214	0,1040	0,1140
	UNF	40	0,1321	0,1372	0,1184	0,1210	0,1074	0,1380	0,1218	0,1252	0,1110	0,1190
8	UNC	32	0,1571	0,1631	0,1399	0,1428	0,1259	0,1640	0,1437	0,1475	0,1300	0,1390
	UNF	36	0,1577	0,1632	0,1424	0,1452	0,1301	0,1640	0,1460	0,1496	0,1340	0,1420
10	UNC	24	0,1818	0,1890	0,1586	0,1619	0,1394	0,1900	0,1629	0,1672	0,1450	0,1550
	UNF	32	0,1831	0,1891	0,1658	0,1688	0,1519	0,1900	0,1697	0,1736	0,1560	0,1640
12	UNC	24	0,2078	0,2150	0,1845	0,1879	0,1654	0,2160	0,1889	0,1933	0,1710	0,1810
	UNF	28	0,2085	0,2150	0,1886	0,1918	0,1725	0,2160	0,1928	0,1970	0,1770	0,1860
1/4	UNC	20	0,2408	0,2489	0,2127	0,2164	0,1894	0,2500	0,2175	0,2224	0,1960	0,2070
	UNF	28	0,2425	0,2490	0,2225	0,2258	0,2065	0,2500	0,2268	0,2311	0,2110	0,2200
5/16	UNC	18	0,3026	0,3113	0,2712	0,2752	0,2451	0,3125	0,2764	0,2817	0,2520	0,2650
	UNF	24	0,3042	0,3114	0,2806	0,2843	0,2618	0,3125	0,2854	0,2902	0,2670	0,2770
3/8	UNC	16	0,3643	0,3737	0,3287	0,3331	0,2993	0,3750	0,3344	0,3401	0,3070	0,3210
	UNF	24	0,3667	0,3739	0,3430	0,3468	0,3243	0,3750	0,3479	0,3528	0,3300	0,3400
7/16	UNC	14	0,4206	0,4361	0,3826	0,3897	0,3510	0,4375	0,3911	0,4003	0,3600	0,3760
	UNF	20	0,4281	0,4362	0,3995	0,4037	0,3767	0,4375	0,4050	0,4104	0,3830	0,3950
1/2	UNC	13	0,4876	0,4985	0,4435	0,4485	0,4069	0,5000	0,4500	0,4565	0,4170	0,4340
	UNF	20	0,4906	0,4987	0,4619	0,4662	0,4392	0,5000	0,4675	0,4731	0,4460	0,4570
9/16	UNC	12	0,5495	0,5609	0,5016	0,5068	0,4617	0,5625	0,5084	0,5152	0,4720	0,4900
	UNF	18	0,5524	0,5611	0,5205	0,5250	0,4949	0,5625	0,5264	0,5323	0,4050	0,5150
5/8	UNC	11	0,6112	0,6233	0,5588	0,5643	0,5150	0,6250	0,5660	0,5732	0,5270	0,5460
	UNF	18	0,6149	0,6236	0,5828	0,5875	0,5574	0,6250	0,5889	0,5949	0,5650	0,5780
3/4	UNC	10	0,7353	0,7482	0,6773	0,6832	0,6291	0,7500	0,6850	0,6927	0,6420	0,6630
	UNF	16	0,7391	0,7485	0,7029	0,7079	0,6741	0,7500	0,7094	0,7159	0,6820	0,6960
7/8	UNC	9	0,8592	0,8731	0,7946	0,8009	0,7408	0,8750	0,8028	0,8110	0,7550	0,7780
	UNF	14	0,8631	0,8734	0,8216	0,8270	0,7883	0,8750	0,8286	0,8356	0,7980	0,8130
1	UNC	8	0,9830	0,9980	0,9101	0,9168	0,8492	1,0000	0,9188	0,9276	0,8650	0,8900
	UNF	12	0,9868	0,9982	0,9382	0,9441	0,8990	1,0000	0,9459	0,9535	0,9100	0,9280
1 1/8	UNC	7	1,1064	1,1228	1,0228	1,0300	0,9527	1,1250	1,0322	1,0416	0,9700	0,9980
	UNF	12	1,1118	1,1232	1,0631	1,0691	1,0240	1,1250	1,0709	1,0787	1,0350	1,0530
1 1/4	UNC	7	1,2314	1,2478	1,1476	1,1550	1,0777	1,2500	1,1572	1,1668	1,0950	1,1230
	UNF	12	1,2368	1,2482	1,1879	1,1941	1,1490	1,2500	1,1959	1,2039	1,1600	1,1780
1 3/8	UNC	6	1,3544	1,3726	1,2563	1,2643	1,1741	1,3750	1,2667	1,2771	1,1950	1,2250
	UNF	12	1,3617	1,3731	1,3127	1,3190	1,2739	1,3750	1,3209	1,3291	1,2850	1,3030
1 1/2	UNC	6	1,4794	1,4976	1,3812	1,3893	1,2991	1,5000	1,3917	1,4022	1,3200	1,3500
	UNF	12	1,4867	1,4981	1,4376	1,4440	1,3989	1,5000	1,4459	1,4542	1,4100	1,4280
1 3/4	UNC	5	1,7268	1,7473	1,6085	1,6175	1,5091	1,7500	1,6201	1,6317	1,5330	1,5670
	UNF	12	1,7368	1,7482	1,6881	1,6941	1,6490	1,7500	1,6959	1,7037	1,6600	1,6780
2	UNC	4 1/2	1,9751	1,9971	1,8433	1,8528	1,7325	2,0000	1,8557	1,8681	1,7590	1,7950
	UNF	12	1,9868	1,9982	1,9380	1,9441	1,8990	2,0000	1,9459	1,9538	1,9100	1,9280
3	UNC	4	2,9730	2,9968	2,8237	2,8344	2,6991	3,0000	2,8376	2,8515	2,7290	2,7670
4	UNC	4	3,9728	3,9966	3,8229	3,8342	3,6989	4,0000	3,8376	3,8523	3,7290	3,7670



Gewindesteigungen P in mm für
ISO-metrisches Regelgewinde M
ISO-metrisches Feingewinde M-F
Trapezgewinde Tr

Gewindengangzahl pro Inch für
UNC-Regelgewinde
UNF-Feingewinde
BSW-Regelgewinde (Ww)
BSF-Feingewinde
Whitworth-Rohrgewinde



Tabelle 6:

Gewinde Ø		Steigung P						
M	Tr	M	M-F	M-F2	M-F3	Tr		
1		0,25	(0,2)					
1,2		0,25	(0,2)					
1,4		0,3	(0,2)					
1,6		0,35	(0,2)					
1,8		0,35	(0,2)					
2		0,4	(0,25)					
2,2		0,45	(0,25)					
2,5		0,45	(0,35)					
3		0,5	(0,35)					
3,5		0,6	(0,35)					
4		0,7	0,5					
5		0,8	0,5					
6		1	0,75	0,5				
8	8	1,25	1	0,75	0,5	1,5		
10	10	1,5	1,25	1	0,75	2	1,5	
12	12	1,75	1,5	1,25	1	3	2	
14	14	2	1,5	1,25	1	4	3	
16	16	2	1,5		1	4	2	
18	18	2,5	2	1,5	1	4	2	
20	20	2,5	2	1,5	1	4	2	
22	22	2,5	2	1,5	1	8	5	
24	24	3	2	1,5	1	8	5	
27	26/28	3	2	1,5	(1)	8	5	
30	30	3,5	2	1,5	(1)	10	6	
33	32/34	3,5	2	1,5		10	6	
36	36	4	3	2	1,5	10	6	
39	38/40	4	3	2	1,5	10	7	
42	42	4,5	(4) 3	2	1,5	10	7	
45	44/46	4,5	(4) 3		1,5	12	7/8	
48	48	5	(4) 3	2	1,5	12	8	
52	50/52	5	(4) 3	2	1,5	12	8	
56	55	5,5	4	3/2	1,5	14	9	
60	60	5,5	4	3/2	1,5	14	9	
64	65	6	4	3	2 (1,5)	16	10	
68	70	6	4	3	2 (1,5)	16	10	
Flanken ↘		60°			30°			

Bei Feingewinde ist M-F bevorzugt einzusetzen

Gewinde Ø			Gangzahl G (pro 1 Inch)				
UNC/UNF Nr.	Zoll Inch	= mm	UNC (NC)	UNF (NF)	BSW (Ww C)	BSF (Ww F)	R, G Rp
0		1,524	-	80	-	-	-
1		1,854	64	72	-	-	-
2		2,184	56	64	-	-	-
3		2,515	48	56	-	-	-
4		2,845	40	48	-	-	-
5		3,175	40	44	-	-	-
6		3,505	32	40	-	-	-
8		4,166	32	36	-	-	-
10		4,826	24	32	-	-	-
12		5,486	24	28	-	-	-
	1/8	3,175	-	-	40	-	28
	5/32	3,969	-	-	32	-	-
	3/16	4,763	-	-	24	32	-
	7/32	5,556	-	-	24	28	-
	1/4	6,350	20	28	20	26	19
	5/16	7,938	18	24	18	22	-
	3/8	9,525	16	24	16	20	19
	7/16	11,113	14	20	14	18	-
	1/2	12,700	13	20	12	16	14
	9/16	14,288	12	18	12	16	-
	5/8	15,875	11	18	11	14	14
	3/4	19,050	10	16	10	12	14
	7/8	22,225	9	14	9	11	14
	1	25,401	8	12	8	10	11
	1 1/8	28,575	7*	12	7	9	11
	1 1/4	31,750	7*	12	7	9	11
	1 3/8	34,925	6*	12	6	8	11
	1 1/2	38,100	6*	12	6	8	11
	1 3/4	44,450	5*	12	5	7	11
	2	50,802	4 1/2*	12	4 1/2	7	11
	2 1/4	57,150	4 1/2*	-	4	-	11
	2 1/2	63,500	4*	-	4	-	11
	2 3/4	69,850	4*	-	3 1/2	-	11
	3	76,200	4*	-	3 1/2	-	11
	4	101,60	4*	-	3	-	11
-			60°		55°		

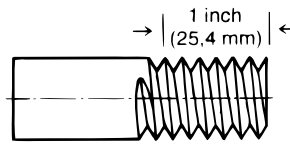
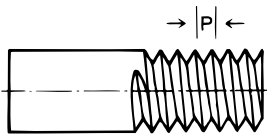
* Studbolts Ø ≥ 1" = Konstant 8 Gang/Inch (Zoll)

** Rohrgewinde haben größere Außen Ø (→ Tabelle 5)



Allgemeine Hinweise

Korrosion ist die Reaktion eines metallischen Werkstoffs mit seiner Umgebung, die eine messbare Veränderung des Werkstoffs bewirkt und zu einer Beeinträchtigung der Funktion eines metallischen Bauteiles oder eines ganzen Systems führen kann. In den meisten Fällen ist diese Reaktion elektrochemischer Natur, in einigen Fällen kann sie jedoch auch chemischer oder metallphysikalischer Natur sein. (Definition Grundbegriff „Korrosion“ nach ISO 8044)

Tabelle 1 zeigt aus der Vielzahl verschiedener Korrosionsarten die wichtigsten, die bei „Mechanischen Verbindungselementen“ zu beachten sind.



Tabelle 1: Korrosionsarten

 Flächenkorrosion z. B. Rost, Lochfraß	 Spaltkorrosion	 Elektrolyte Kontaktkorrosion (siehe Tabelle 2)	 interkristalline/ transkristalline Korrosion	 Spannungsrisskorrosion
--	--------------------	--	---	----------------------------

Korrosion ist unvermeidbar – vermeidbar sind jedoch Schäden durch Korrosion bei richtiger Planung geeigneter Korrosionsschutzmaßnahmen. Der Korrosionsschutz der Schraubenverbindungen muss unter Einsatzbedingungen mindestens so korrosionsbeständig sein wie die zu verbindenden Teile.

Es ist Aufgabe der konstruktiven Planung, die erforderlichen Korrosionsschutzmaßnahmen zu bestimmen. Hierbei ist die Beständigkeit des Korrosionsschutzes unter bekannten Betriebsbedingungen bis zum Wartungszeitpunkt bzw. bis zur Schadensgrenze zu berücksichtigen. Oberflächen- und werkstofftechnische Vorgaben sind im Artikel-Bestelltext normgerecht anzugeben.

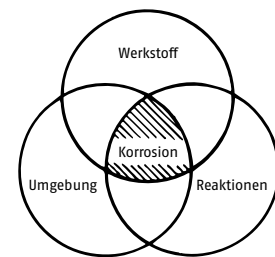
Die nächste Seite gibt einen groben Überblick von Korrosionsschutzmöglichkeiten für Verbindungs- und Befestigungselemente.

Prüfnormen für Korrosionsschutzverfahren zusammengefasst im DIN-Taschenbuch 175 regeln einheitliche Bedingungen für Art und Aufbau von Vorrichtungen und Verfahren für die Kontrolle auf Einhaltung vorgegebener Überzugsart, Schichtdicke und optischem Aussehen. Die Prüfungen nach diesen Normen geben keine Aussage über Wirkung und Dauerhaltbarkeit des Korrosionsschutzes unter praktischen Betriebsbedingungen.

Eine Übersicht der Reibungszahlen für verschiedene Oberflächen-Kombinationen → TI – Montage. Die Reibverhältnisse in der Schraubenverbindung sind ausschlaggebend für die Bestimmung des richtigen Anziehmomentes. (→ VDI 2230)

Kontaktkorrosion

Die Kombination elektrochemisch edler mit unedlen Metallen erzeugt in Gegenwart von Feuchtigkeit (= Elektrolyt) Korrosionsströme vom unedlen (anodischen) Metall zum edleren (kathodischen) Metall. Damit wird das unedlere Metall verstärkt abgetragen und korrodiert. Maßgebend sind zusätzlich die Korrosionsstromdichten. Ist das unedle, anodische Teil im Verhältnis zur umgebenden kathodischen Fläche klein (Schraubenkopf in Blechoberfläche), so entsteht eine sehr hohe anodische Stromdichte, die viel Material wegtransportiert (= stark korrodiert).

Beispiel 1:

Verzinkte Schraube zur Befestigung von Kupferblech: Zink ist gegenüber Kupfer wesentlich unedler. Bei Feuchtigkeit entsteht am kleinen, unedleren, anodischen Schraubenkopf (linke Spalte Zink – klein) eine sehr hohe Korrosionsstromdichte in Richtung edles, kathodisches Kupferblech (obere Zeile – Kupfer). Die verzinkte Oberfläche der Schraube wird in kürzester Zeit abgetragen und es entsteht Rotrost am Stahl.

Abhilfe:

Das Verbindungselement soll gegenüber dem metallischen Bauteil möglichst gleich oder edler sein.

Schraube	Bauteil
verzinkt	verzinkt
vernickelt	Stahl, Kupfer, Messing
rostfrei	Stahl, verzinkt, Aluminium, Kupfer, Messing

Beispiel 2:

Kupferschraube oder ähnlich wirkende Schraube aus nichtrostendem Stahl zur Befestigung eines verzinkten Bleches: Nun ist der unedlere, anodische, verzinkte Bereich sehr groß im Verhältnis zum kleinen, edlen, kathodischen Schraubenkopf. Der sich auf die ganze Fläche verteilende Korrosionsstrom hat in der Anode eine sehr geringe Dichte. Die Materialabtragung geschieht über die ganze Fläche verteilt und lässt kaum Korrosion erkennen. Der edlere Schraubenkopf wird durch diesen Vorgang sogar noch zusätzlich gegen Korrosion geschützt.

Lassen sich ungünstige Metallpaarungen nicht vermeiden, sollten sie gegeneinander isoliert werden, z. B. durch Zwischenlagen oder Anstriche. Dabei ist zu beachten, dass die Gesamtfestigkeit der Verbindung erhalten bleiben muss.

Tabelle 2: Kontaktkorrosion bei Metallpaarungen

Hinsichtlich Kontaktkorrosion betrachteter Werkstoff	Flächenverhältnis*	Magnesiumlegierung	Zink	Stahl feuerverzinkt	Aluminiumlegierung	Cd-Überzug	Baustahl	Niedrigleg. Stahl	Stahlguß	Chromstahl	Blei	Zinn	Kupfer	NIRO-Stahl
Magnesiumlegierung	klein groß		S M	S M	S M	S M	S S	S S	S S	S S	S S	S S	S S	S S
Zink	klein groß	M G		G M	G M	G M	S S	S S	S S	S S	S S	S S	S S	S S
Feuerverzinkter Stahl	klein groß	M G	G G		M G	G G	S S	S S	S S	S S	S S	S S	S S	S S
Aluminiumlegierung	klein groß	M G	G M	G M		G G	M G	G M	S M	S S	S S	S S	S S	S M
Cadmiumüberzug	klein groß	G M	G G	G M	G G		S S	S S	S S	S S	S S	S S	S S	S S
Baustahl	klein groß	G G	G G	G G	G G	G G		M G	S S	S S	S S	S S	S S	S S
Niedriglegierter Stahl	klein groß	G G	G G	G G	G G	G G	G G		G S	G S	S S	S S	S S	S S
Stahlguß	klein groß	G G	G G	G G	G G	G G	G G	G G		S S	S S	S S	S S	S S
Chromstahl	klein groß	G G	G G	G G	G G	G G	G G	G G	G G		M G	M G	S S	S S
Blei	klein groß	G G	G G	G G	G G	G G	G G	G G	G M	G G		G G	G G	G G
Zinn	klein groß	G G	G G	G G	G G	G G	G G	G G	G G	G M	G G		G G	G G
Kupfer	klein groß	G G	G G	G G	G G	G G	G G	G G	G G	M M	M M	S S		G G
nichtrostender Stahl	klein groß	G G	G G	G M	G G	G G	G G	G G	G M	M M	M M	M M	G G	

S = starke Korrosion des betrachteten Werkstoffs
M = mäßige Korrosion des betrachteten Werkstoffs (in sehr feuchter Atmosphäre)
G = geringfügige oder keine Korrosion des betrachteten Werkstoffs

* Verhältnis der Oberfläche des „betrachteten“ Werkstoffs zur Oberfläche des „Paarungswerkstoffs“ (Quelle: Beratungsstelle „FEUERVERZINKEN“)



Korrosionsschutz-Maßnahmen

Konstruktive Maßnahmen z. B. Isolierung, Vermeiden von Spalten...

Elektrochemische Maßnahmen z. B. kathodischer Schutz, Belüftung

Tabelle 3: Oberflächentechnische Maßnahmen

Maßnahmen	Verfahren	Überzüge	Schicht- dicken µm	Normen Markennamen
• Nichtmetallische Überzüge (anorganische/ *organische Überzüge)	Einölen	Öl	–	
	Brünieren, Oxidieren	Eisenoxidschicht	0,5 – 2	DIN 50938
	Phosphatieren	Phosphatschicht	–	EN 12476 (DIN 50942)
	Dünnschicht-Lackierungen*	Lack/Kunststoff/ Harz (Fluorpolymer/TEFLON)	3 – 20	IRCO-SEAL, KLEVER-COL, XYLAN, PTFE, STAND-COTE
	Tauchlackierungen*	Epoxidharz/Polyester/Phenolharz	10 – 20	KTL-KATAPHORESE, ECO 2000
• Metallische Überzüge (anorganische Überzüge)	Galvanische Überzüge: (elektrolytisch/chemisch/sauer/ alkalisch/cyanidisch)	Zink	3 – 25	ISO 4042
		Cadmium		
	Kupfer			
	Kupfer-Zink			
	Nickel			
	Nickel-Chrom			
	Kupfer-Nickel			
+ Konversionsschichten (z. B. Dünnschichtpassivierung/ Dickschichtpassivierung, Chrom- matierung – ISO 4520)	Kupfer-Nickel-Chrom			
Zinn				
Kupfer-Zinn				
Silber				
Kupfer-Silber				
Zink-Nickel				
Zink-Kobalt				
Zink-Eisen				
Feuerverzinkung tZn (Schmelztauch-Verzinkung)	Zink	min. 40	ISO 10684 (DIN 267-10) für Verbindungselemente ISO 1461 für Stückverzinkung	
Mechanisches Verzinken (plattierte Überzüge)	Zinkpulver auf Unterkupferung (Chromatierung möglich)	6 – 107	ISO 12683	
Diffusions-Überzüge	Zinkpulver ein-/aufgebrannt	15 – 45	EN 13811: SHERARD-Verzinkung ISO 14713-3	
• Zinklamellen-Überzüge	Basecoat (Dispersions-Überzüge = anorganisch)	Zn-/Alu-Lamellen (silbrig)	5 – 20	ISO 10683, DACROMET/GEOMET, DELTA-TONE, ZINCTECH
	Topcoat (Dünnschicht-Lackierung = organisch)	Dünnlack (silbrig oder farbig) Optional mit integriertem Schmiermittel	8 – 15	DELTA-SEAL, DELTA-PROTEKT KL + VH, GEOMET PLUS VL, DACROBLACK, GEOBLACK

Tabelle 4: Werkstofftechnische Maßnahmen

Maßnahmen	Verfahren	Überzüge	Normen	Markennamen
• Nichteisen-Metalle (NE)	Kupfer (Cu)	–	ISO 8839 (DIN 267-18)	KURBUS
	Messing (CuZn)	gal Ni, gal Cr, brüniert	(galv. Überzüge ISO 4042 [DIN 267-9])	Sonder-Messing 59
	Bronze (CuNiSi, CuSn)	–		KUPRODUR
	Aluminium (Al)	eloxiert	–	–
• Nichtmetallische Werkstoffe (K)*	Titan/Titan-Legierungen	–	ISO 8839 (DIN 267-18)	–
	Kunststoffe PA, POM, PP, PVDF, Nylon	–	VDI 2544 DIN 34810 – 34816	ULTRAMID, DELRIN, HOSTALEN...
• Nichtrostende Stähle	Ferritische Stähle (F) 1.4016, 1.4568	sauber und metallisch blank	ISO 3506 (DIN 267-11) EN 10088 (DIN 17224)	–
	Martensitische Stähle (C) 1.4016, 1.4057, 1.4122...		ISO 3506 (DIN 267-11) EN 10088 (DIN 17442)	–
	Austenitische Stähle (A) A 1 = 1.4305 A 2 = 1.4301, 1.4303 A 4 = 1.4401 A 3 = 1.4541 A 5 = 1.4571 FSt = 1.4310		ISO 3506 (DIN 267-11) EN 10088 (DIN 17440, 17244)	NIRO, NIROSTA, INOX, CRONIFER, RE- MANIT, UNOX, SINOX ...
			EN 10088 (DIN 17224)	Austenitische/austenitisch-ferritische Stähle mit be- sonderer Beständigkeit gegen chlorinduzierte Span- nungsrissskorrosion – z.B. in Hallenschwimmbädern → TI-226
• Sonder-Werkstoffe	Nickel, Nickel-Legierungen	metallisch blank	DIN 17740, 17742-44	INCONEL, HASTELLOY, MONEL...
	Kupfer-Sonderlegierungen Mehrstoff-Bronzen		DIN 17662-17665	Sn-/Al-Bronze, NEUSILBER, RESISTIN, CUNIFER...
	Spezialstähle		EN 10269 (DIN 17240), SEW 390	URANUS, SICROMAL, MANOX...

*mechanische Eigenschaften → TI-227



Tabelle 5:
Normenreferenzen für Korrosionsschutz von Oberflächen

Normnummer	Titel
ISO 4042	Verbindungselemente – Galvanisch aufgebrauchte Überzugssysteme
ISO 10683	Verbindungselemente – Nichtelektrolytisch aufgebrauchte Zinklamellenüberzüge
ISO 10684	Verbindungselemente – Feuerverzinkung
ISO 1891-2	Verbindungselemente – Begriffe für Oberflächenschichten
ISO 19598	Metallische Überzüge – Galvanische Zink- und Zinklegierungsüberzüge mit Cr(VI)-freien Behandlungen
ISO 2081	Metallische und andere anorganische Überzüge – Galvanische Zinküberzüge mit zusätzlicher Behandlung
ISO 1461	Durch Feuerverzinken auf Stahl aufgebrauchte Zinküberzüge (Stückverzinken)
EN 1403	Galvanische Überzüge – Verfahren für die Spezifizierung allgemeiner Anforderungen
ISO 12944 Teil 1 bis Teil 6	Korrosionsschutz von Stahlbauten

Tabelle 6:
Beanspruchungsstufen für galvanische Zinküberzüge

Beanspruchungsstufe	Dauer der neutralen Salzsprühnebelprüfung ohne Rotrostkorrosion (NSS) in Stunden
0	Dekorative Anwendung (ohne Beanspruchung) 48
1	Innenraumbeanspruchung in warmer, trockener Atmosphäre 72
2	Innenraumbeanspruchung in Räumen, in denen Kondensation auftreten darf 120
3	Freibewitterung unter gemäßigten Bedingungen 192
4	Freibewitterung unter schweren korrosiven Bedingungen, z. B. See- oder Industrieklima 360

- Auszug aus ISO 2081:2009-05, EN 1403
- Genannte Schutzwirkungen differieren in der Praxis und sind nur Richtwerte
- Passende Überzüge sind der unten dargestellten Übersicht zu entnehmen

Tabelle 7:
Jährliche Abtragswerte für Zink (für ebene Flächenkorrosion)

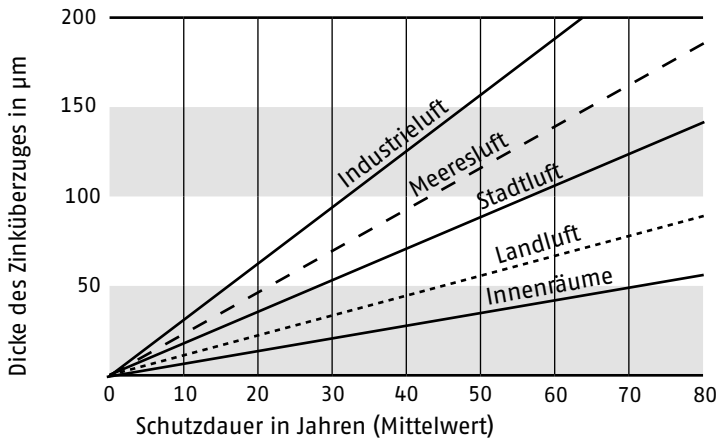

Beanspruchung	µm/Jahr
Innenräume	1,0 - 2,0
Landluft*	1,3 - 2,5
Stadtluft*	1,9 - 5,6
Industrielluft*	6,4 - 19
Meeresluft*	2,2 - 7,2

* in der Praxis ist mit Mischklima zu rechnen.

Übersicht gängiger Überzugssysteme

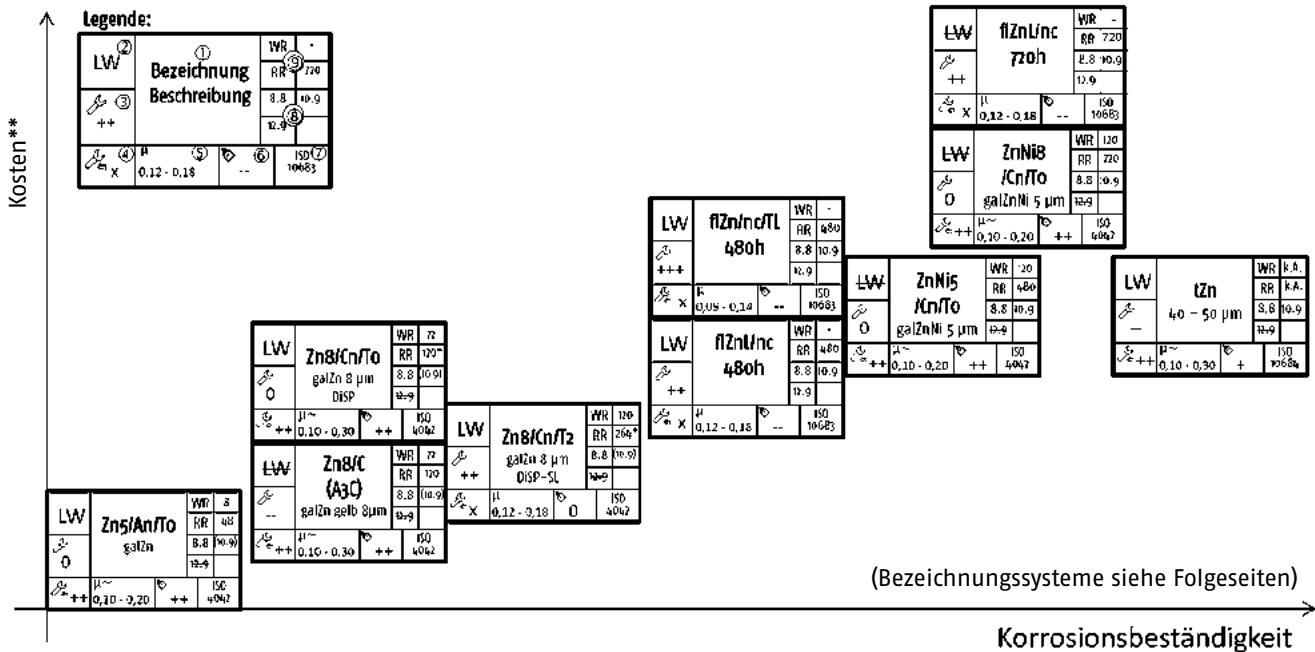

- 1) Bezeichnung der Oberfläche; 2) Produkte mit dieser Oberfläche im Lagervorrat; 3) Montageverhalten (Reibzahlstreuung) ohne zusätzliche Schmierung (– = schlecht bis ++ = sehr gut); 4) Montageverhalten (Reibzahlstreuung) mit zusätzlicher Schmierung (– = schlecht bis ++ = sehr gut / x = Schmierung in Oberfläche bereits enthalten); 5) Reibzahlfenster im Lieferzustand (µ = Richtwerte) 6) Eignung der Oberfläche zum Kleben (– = schlecht bis ++ = gut); 7) Norm für die Technische Lieferbedingung; 8) Eignung der Oberfläche für Festigkeitsklassen; 9) Korrosionsbeständigkeit im Salzsprühnebeltest (WR = Weißrost, RR = Rotrost)

*Abweichend von ISO 4042

**die Einordnung gibt einen ungefähren, aber unverbindlichen Überblick über die Kosten



Für galvanische Überzüge auf Verbindungselementen und nicht genormten Gewinde- und Formteilen gelten die Technischen Lieferbedingungen nach ISO 4042. Das Überzugsmetall wird durch ein elektrolytisches Abscheideverfahren in einem galvanischem Bad auf die zu beschichtenden Teile aufgebracht.

Schichtaufbau und Bezeichnungssystem von galvanischen Überzugssystemen

Chromatschicht (ca. 0,1 µm)	Optionale Versiegelung (ca. 0,5 µm)
Überzugsmetall (z.B. Zink) (≥ 5 µm)	Passivierungsschicht (Dickschichtpass. ca. 0,4 µm Dünnschichtpass. ca. 0,1 µm)
Grundmaterial (Schraubenwerkstoff)	Überzugsmetall (z.B. Zink) (≥ 5 µm)
	Grundmaterial (Schraubenwerkstoff)

Cr(VI)-haltig

Cr(VI)-frei

Tabelle 9:
Versiegelungen/Deckschichten/Schmiermittel

Code	Bezeichnung	Anforderung
-		Nach Wahl des Herstellers
T0	Keine Versiegelung oder Deckschicht	Zur Erzielung einer bestimmten Funktion darf keine Versiegelung oder Deckschicht aufgebracht werden
T2	Versiegelung	Versiegelung zur Steigerung der Korrosionsbeständigkeit mit oder ohne integriertem Schmiermittel
T4	Nachträglich aufgebrachtes Schmiermittel	Ein Schmiermittel muss nachträglich auf den Metallüberzug oder die Konversionsschicht oder die Versiegelung/Deckschicht aufgebracht werden
T7	Deckschicht	z.B. Verbesserung der Chemikalienbeständigkeit oder Farbeinstellung
nL	Kein Schmiermittel	Es darf kein integriertes Schmiermittel in T2 oder T7 vorhanden sein

Bezeichnungsbeispiel einer galvanischen Oberflächenbehandlung nach ISO 4042
ISO 4014 – M 16 x 60 – 8.8 /Zn8/Cn/T2(µ0,12-0,18)

Zn8	Cn	T2	(µ0,12-0,18)
			Eingestelltes Reibzahlfenster – zu realisieren durch ein integriertes Schmiermittel in der Versiegelung oder einem nachträglich aufgebrachtem Schmiermittel
			Versiegelung mit oder ohne integrierte Schmierung
			Konversionsschicht Cn = Cr(VI)-freie Passivierung irisierend (Dickschichtpassivierung)
			Überzugsmetall Zn = Zink mit einer Mindestschichtdicke von 8 µm

Übliche/gebräuchliche Bezeichnungen

Tabelle 11:
Überzugsmetalle (Auszug aus ISO 4042)

Bezeichnung alt	Bezeichnung neu	übliche Bezeichnungen
A2A; A2B; A2K	ISO 4042 Zn5/An/T0	galZn; VZB; eIVZ; ZP; BZP;VZ
-	ISO 4042 Zn5/Cn/T0	galZnDiSP; VZD;...
A2C	ISO 4042 Zn5/C/T0	galZnC; VG; GVZ; YZP; VZG

Korrosionsbeständigkeit von galvanischen Zink- und Zinklegierungsüberzügen mit Cr(VI)-freien Konversionsschichten

Tabelle 12: Korrosionsbeständigkeit nach ISO 4042

Überzugssystem	Code	Mindestdauer der neutralen Salzsprühnebelprüfung in Stunden		
		Weißrost	Rotrost	Schichtdicke
			5 µm	8 µm
Zn, transparent passiviert	Zn/An/T0	8	48	72
Zn, irisierend passiviert	Zn/Cn/T0	72	120	192
Zn, irisierend passiviert, versiegelt	Zn/Cn/T2	120	168	240
Zn, schwarz passiviert, versiegelt	Zn/Fn/T2	24	72	144
ZnFe, irisierend passiviert	ZnFe/Cn/T0	96	144	216
ZnFe, irisierend passiviert, versiegelt	ZnFe/Cn/T2	120	216	288
ZnFe, schwarz passiviert, versiegelt	ZnFe/Fn/T2	96	192	240
ZnNi, silbergrau, passiviert	ZnNi/Cn/T0	120	480	720
ZnNi, silbergrau passiviert, versiegelt	ZnNi/Cn/T2	168	600	720
ZnNi, schwarz passiviert	ZnNi/Fn/T0	48	360	600
ZnNi, schwarz passiviert, versiegelt	ZnNi/Fn/T2	120	480	720

1) bei Trommelbeschichtung; Prüfung erfolgt direkt nach der Beschichtung

Hinweis: Es handelt sich hier nur um Auszüge aus den Normen. Zu Prüfzwecken ist die jeweilige Norm heranzuziehen



Anforderungen an Lehrenhaltigkeit und Montierbarkeit von Verbindungselementen nach ISO 4042

Die Gewindetoleranzen gelten vor dem Aufbringen der galvanischen Überzüge – mit Überzug darf die Nulllinie beim Bolzengewinde (Toleranzlage h) nicht überschritten bzw. beim Mutterngewinde (Toleranzlage H) nicht unterschritten werden. Das Bolzengewinde mit Überzug kann also zwischen dem oberen Abmaß des Toleranzfeldes und der Nulllinie liegen. Die Gewinde müssen über den gesamten Gewindebereich lehrbar sein. Abweichend davon können die Gewinde durch Transport- und Schüttvorgänge im Lieferzustand Beschädigungen haben. Die maximalen Aufschraubmomente einer Gewindelehre dürfen in diesem Fall den Wert von $0,001d^3$ in Nm nicht überschreiten (Tabelle 13). Alternativ kann zwischen Besteller und Lieferant eine Prüfung auf Montierbarkeit mit einer geeigneten Mutter bzw. Schraube vereinbart werden.

Im Interesse der Schraubbarkeit ist die Schichtdicke für Gewindeteile mit dem üblichen Toleranzspiel 6g/6H logischerweise begrenzt. Die nach ISO 4042 möglichen und nach Erfahrung empfohlenen Grenzwerte zeigt Tabelle 14. Dickere Überzüge erfordern andere Toleranzlagen mit größerem Abmaß nach DIN 13-14 (Sonderanfertigung).

Prüfung der Schichtdicke von galvanischen Überzügen auf Verbindungselementen

Zur Ermittlung der Schichtdicke können verschiedene Prüfverfahren zum Einsatz kommen (Röntgenverfahren nach ISO 3497, Coulometrisches Verfahren nach ISO 2177, mikroskopisches Verfahren nach ISO 1463, Magnetverfahren nach ISO 1463 oder Wirbelstromverfahren nach ISO 21968). Im Schiedsfall ist das mikroskopische Verfahren zu verwenden.

Die Prüfung ist an den im Bild dargestellten Referenzflächen durchzuführen.

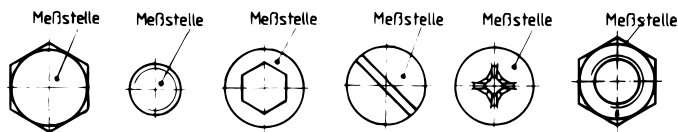

bliche Lagerhaltung:
 „galZn“ ca. 5 µm = A2A/A2B/A2E/A2F
 „galZnC“ gelb chromat. ca. 5 µm = A2C/A2G/A2L
 „galZn 8 DISP“ ca. 8 µm mit Dickschichtpassivierung

Tabelle 13: Maximales Aufschraubmoment fr die Lehrung von beschichteten metrischem Gewinde nach ISO 4042

Gewinde	Max. Aufschraubmoment [Nm]	Gewinde	Max. Aufschraubmoment [Nm]
M 3	0,03	M 18	5,8
M 4	0,06	M 20	8,0
M 5	0,13	M 22	11,0
M 6	0,22	M 24	14,0
M 8	0,51	M 27	20,0
M 10	1,0	M 30	27,0
M 12	1,7	M 33	36,0
M 14	2,7	M 36	47,0
M 16	4,1	M 39	59,0

Tabelle 14: Maximale Schichtdicken fr Außengewinde mit der Gewindetoleranzlange g

Gew. Ø M	Steigung	Max. Schichtdicke [µm]				
		nach ISO 4042 ① Schraubenlnge			Praxiswerte ② Schraubenlnge	
		< 5d	5d - 10d	10d - 15d	< 5d	5d - 15d
1 - 2	0,2 - 0,4	3	3	3	-	-
2,5 - 7	0,45 - 1	5	3	3	3	3
8	1,25	5	5	3	5	3
10 - 16	1,5 - 2	8	5	5	5	3
18 - 22	2,5	10	8	5	8	5
24 - 27	3	12	8	8	8	5
30 - 33	3,5	12	10	8	8	8
36 - 52	4 - 5	15	12	10	10	8
56 - 60	5,5	15	15	12	12	10
64	6	20	15	12	12	10

① Rechnerischer Grenzwert nach ISO 4042, Tab.2

② Empfohlener Grenzwert aus der Praxis unter Bercksichtigung fertigungs- und verfahrensbedingter Beschdigungen nach ISO 6157-1, -3

Hinweise zu einer fertigungsbedingten Wasserstoffversprdung (ISO 4042)

Das Risiko einer fertigungsbedingten Wasserstoffversprdung (IHE = internal hydrogen embrittlement) liegt vor, wenn das Verbindungselement einer hohen Hrte bzw. Zugfestigkeit hat, Zugspannungen ausgesetzt ist und im Fertigungsprozess atomaren Wasserstoff aufnehmen kann.

Tabelle 15: Manahmen zur Reduzierung der Wasserstoffversprdung in Bezug auf die Hrte nach ISO 4042

Manahme	A	B	C ^①
Beschreibung der Manahme	Keine ergnzende Prozessverifizierung oder Produktprfung in Bezug auf IHE UND Kein Tempern notwendig	Ergnzende Prozessverifizierung und/oder Produktprfung in Bezug auf IHE ODER Tempern	Ergnzende Prozessverifizierung und/oder Produktprfung in Bezug auf IHE UND Tempern
Anwendung bei Schrauben der Festigkeitsklasse nach ISO 898-1	≤ 8.8	10.9	12.9
Anwendung bei Muttern der Festigkeitsklasse und Hrte nach ISO 898-2	≤ Fkl. 12 und < 360 HV	≤ Fkl. 12 und ≥ 360 HV	-
Anwendung bei Scheiben mit einer Festigkeitsklasse nach ISO 898-3	≤ 200 HV	300 HV	380 HV

① Da trotz der Manahme C ein erhebliches Restrisiko der fertigungsbedingten Wasserstoffversprdung bei den genannten Schrauben und Scheiben besteht, erfolgt die Fertigung nur auf ausdrcklichen Abnehmerwunsch.



Für nichtelektrolytisch aufgetragene Zinklamellenüberzüge auf Verbindungselementen und nicht genormten Gewinde- und Formteilen gelten die Technischen Lieferbedingungen nach ISO 10683. Der Überzug aus Zink- und Aluminiumlamellen, die durch eine anorganische Matrix verbunden sind, wird durch ein Tauch- oder Spritzverfahren auf die Teileoberfläche aufgebracht und anschließend bei einer Temperatur von 200° – 320°C eingebrannt.

Schichtaufbau und Bezeichnungssystem von Zinklamellenüberzugssystemen

Varianten im Schichtaufbau:

- Nur Basecoat
- Basecoat + Schmierstoff
- Basecoat + Topcoat
- Basecoat + Topcoat + Schmiermittel

Optional – Schmierstoff

Optional – Deckschicht
optional mit integriertem
Schmierstoff (Topcoat)

Basisschicht
optional mit integriertem
Schmierstoff (Basecoat)

Grundmetall

Tabelle 16: Vergleich Beständigkeit in der Salzsprühnebelprüfung zur Referenzschichtdicke nach ISO 10683

Dauer NSS ohne Rotrost [h]	Referenzschichtdicke a) [µm]
240	4
480	5
600	6
720	8
960	10

a) Die Referenzschichtdicke schließt Basisschicht(en) und Deckschicht(en) ein, falls vorhanden, mit oder ohne Cr(VI). Für die Annahme ist die Korrosionsbeständigkeit entscheidend; die Angabe der Referenzschichtdicke dient nur zur Orientierung.

Tabelle 17: Bezeichnungssystem nach ISO 10683

Basisschicht	Chrom(VI)	Deckschicht	Zusätzliches Schmiermittel	Dauer der Salzsprühnebelprüfung bis Rotrost	Anforderung an das Reibzahlfenster
1. Ohne integriertes Schmiermittel = fZn	1. keine Festlegung (nach Wahl des Herstellers)	1. Mit integriertem Schmiermittel in der Deckschicht = TL	L	z.B. 480 h	C ^a
2. Mit integriertem Schmiermittel = fZnL	2. Mit Cr(VI) = yc	2. Ohne integrierte Schmiermittel in der Deckschicht = Tn			
	3. Ohne Cr(VI) = nc				

a) Reibzahlfenster µ sind in der Bestellung zu benennen

Bezeichnungsbeispiel für eine Schraube mit einem Zinklamellenüberzug nach ISO 10683
ISO 4014 – M 16 x 60 – 8.8 fZnL/nc/480h/C (µ = 0,12–0,18)

fZnL	nc	480h	C (µ=0,12–0,18)
			Anforderung an ein Reibzahlfenster µ zwischen 0,12 und 0,18
			Beständigkeit im Salzsprühnebeltest 480 h bis Rotrost
			Überzugssystem ist Cr(VI)-frei
			Zinklamellenüberzug mit integriertem Schmiermittel in der Basischicht

Tabelle 18: Typische Produkte

Hersteller	Produktbeispiele
MAGNI EUROP	Basecoat: Topcoat: MAGNI FLAKE MAGNI TOP
ATOTECH	Basecoat: Topcoat: ZINKTEK TECHSEAL
DÖRKEN	Basecoat: Topcoat: DELTA-PROTEKT ® DELTA-SEAL ® DELTACOLL ®
NOF	Basecoat: Topcoat: GEOMET PLUS L ® PLUS VL ®

Anforderungen an Lehnhaltigkeit und Montierbarkeit von Verbindungselementen nach ISO 10683

Die Gewindetoleranzen gelten vor dem Aufbringen der galvanischen Überzüge – mit Überzug darf die Nulllinie beim Bolzengewinde (Toleranzlage h) nicht überschritten bzw. beim Muttergewinde (Toleranzlage H) nicht unterschritten werden. Das Bolzengewinde mit Überzug kann also zwischen dem oberen Abmaß des Toleranzfeldes und der Nulllinie liegen. Durch Transport- und Schüttvorgänge können im Lieferzustand Beschädigungen am Gewinde auftreten. Die maximalen Aufschraubmomente einer Gewindelehre dürfen in diesem Fall den Wert von 0,001d³ in Nm auf einer Länge von 1d nicht überschreiten (Tabelle 19). Alternativ kann zwischen Besteller und Lieferant eine Prüfung auf Montierbarkeit mit einer geeigneten Mutter bzw. Schraube vereinbart werden.

Eigenschaften der Zinklamellentechnologie auf einen Blick:

- Keine Wasserstoffversprödung bedingt durch den Applikationsprozess
- Fast alle Systeme sind mittlerweile Cr(VI)-frei entsprechend RoHS- und EU-Altautorichtlinie
- Extrem dünne Schichten von typischerweise 5 – 12 µm
- Achtung jedoch bei schöpfenden Teilen mit Innenantrieb und kleinen Durchmessern ≤ M 6
- Hoher kathodischer Korrosionsschutz im Vergleich zu galvanischen Standardoberflächen

Hinweis: Es handelt sich hier nur um Auszüge aus den Normen. Zu Prüfzwecken ist die jeweilige Norm heranzuziehen

Tabelle 19: Maximales Aufschraubmoment für die Lehre von beschichteten metrischem Gewinde nach ISO 10683

Gewinde	Max. Aufschraubmoment [Nm]	Gewinde	Max. Aufschraubmoment [Nm]
M 3	0,03	M 18	5,8
M 4	0,06	M 20	8
M 5	0,13	M 22	11
M 6	0,22	M 24	14
M 8	0,51	M 27	20
M 10	1	M 30	27
M 12	1,7	M 33	36
M 14	2,7	M 36	47
M 16	4,1	M 39	59



Für feuerverzinkte Verbindungselemente gelten die Technischen Lieferbedingungen nach ISO 10684.

Anforderungen an die Gewinde- und Geometrietoleranzen

Die nach dieser Norm geforderte Mindestschichtdicke an der Messstelle von mindestens 40 µm erfordert eine Maßanpassung der Gewinde (siehe Tab. 10).

Das Untermaß liegt in der Regel im Bolzengewinde mit der Toleranzlage 6az, so dass das Bolzengewinde mit Feuerverzinkung die Nulllinie (h-Toleranz) nicht überschreitet (ISO-passend). Diese Bolzen sind zusätzlich mit einem „U“ gekennzeichnet. Ein Nachschneiden des Bolzengewindes ist nicht zulässig.

Bei HV-Verbindungen nach EN 14399-4 wird ein nicht unterschrittenes Bolzengewinde (g-Toleranz) beschichtet, das Bolzengewinde mit Feuerverzinkung liegt daher über der Nulllinie. In diesem Fall liegt das notwendige Aufmaß im Muttergewinde (= 6az).

Das Muttergewinde wird nachträglich in die feuerverzinkten Rohlinge geschnitten. Der Korrosionsschutz des blanken Muttergewindes erfolgt durch die Zinkauflage des Bolzengewindes durch den kathodischen Fernschutz.

Bei Außenmaßen (Kopf, Schaft) kann durch die Zinkschicht ein geringes Übermaß entstehen.



Tabelle 20: Grundabmaße des Bolzengewindes vor der Feuerverzinkung – Toleranzlage 6az nach ISO 10684/ISO 965-4

Regelgewinde	M 6*	M 8	M 10	M 12	M 14 M 16	M 18 M 22	M 24 M 27	M 30 M 33	M 36 M 39	M 42 M 45	M 48 M 52	M 56 M 60	M 64
Oberes Grenzabmaß es [µm]	-290	-295	-330	-335	-340	-350	-360	-370	-380	-390	-400	-410	-420

* nicht normativ geregelt

Anforderungen an die mechanischen Eigenschaften

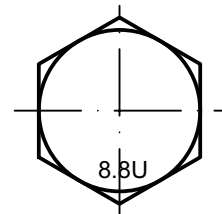
Bei feuerverzinkten Schrauben und Muttern ≥ M 12 gelten nach der Feuerverzinkung die Anforderungen nach ISO 898-1 und ISO 898-2. Für die Gewindegrößen M 8 und M 10 gelten nach ISO 10684 reduzierte Belastbarkeiten.

Tabelle 21: Mindestbruchkräfte [N] für Schrauben der Toleranzklasse 6az

Festigkeitsklasse Kennzeichnung	4.6 4.6 U	5.6 5.6 U	8.8 8.8 U	10.9 10.9 U
M 6*	7 075	8 844	14 150	17 687
M 8	13 300	16 600	26 600	34 500
M 10	21 400	26 800	42 900	55 700
M 12	33 700	42 200	67 400	87 700
M 16	62 800	78 500	125 000	163 000
M 20	98 000	122 000	203 000	255 000
M 24	141 000	176 000	293 000	367 000
M 30	224 000	280 000	466 000	583 000
M 36	327 000	408 000	678 000	850 000

* nicht normativ geregelte Richtwerte

Tabelle 22: Prüfkräfte [N] für Muttern der Toleranzklasse 6az

Festigkeitsklasse Kennzeichnung	5 5 Z	6 6 Z	8 8 Z	10 10 Z
M 6*	7 969	9 962	15 934	19 923
M 8	17 300	20 000	25 500	30 600
M 10	28 600	33 000	42 200	50 400
M 12	51 400	59 000	74 200	88 500
M 16	95 800	109 900	138 200	164 900
M 20	154 400	176 400	225 400	259 700
M 24	222 400	254 200	324 800	374 200
M 30	353 400	403 900	516 100	594 700
M 36	514 700	588 200	751 600	866 000

* nicht normativ geregelte Richtwerte

Montage

Bei der Montage feuerverzinkter Schrauben und Muttern, insbesondere bei zusätzlicher Schmierung des Gewindes, ist mit veränderten Reibwerten und Anziehmomenten zu rechnen. Für feuerverzinkte HV-Verbindungen ist EN 1993 – 1 – 8 NA zu beachten!

(→ TI – Montage)

Anforderungen an den Überzug und die Oberfläche

Graues Aussehen der Feuerverzinkung ist werkstoffbedingt und nicht Qualitätsmerkmal des Korrosionsschutzes. Weißrost und/oder weißliche bis dunkle Korrosionspunkte (Zinkoxid), die nach dem Feuerverzinken z. B. durch Feuchtigkeit entstehen können, beeinträchtigen den Korrosionsschutz in der Regel nicht und sind daher kein Grund für eine Zurückweisung (→ ISO 1461, Abs. 6.1).

Eine gewisse Oberflächenrauheit und kleine Dellen auf den Gewindespitzen sind verfahrensbedingt – daher kann für das erste Aufschrauben ein Montagewerkzeug erforderlich sein.

Eignung von Feuerverzinkung für Verbindungselemente

Aufgrund der hohen Schichtdicken und des Beschichtungsverfahrens ist eine Beschichtung erst ab einem Gewindedurchmesser M 8 genormt. Eingeschränkt feuerverzinkbar sind auch Verbindungselemente mit einem Durchmesser M 6.

Artikel mit Hohlräumen und schöpfenden Antrieben (z. B. Hutmuttern, Innensechskantschrauben) sind für Feuerverzinkungen nicht geeignet.



Eigenschaften: Metrische Schrauben aus Stahl



Die mechanischen Eigenschaften von metrischen Schrauben aus Stahl sowie deren Prüfung und Kennzeichnung sind in ISO 898-1 festgelegt. Für auf Druck belastete Verbindungselemente mit Außengewinde, wie z. B. Gewindestifte, sind lediglich Härteklassen nach ISO 898-5 festgelegt.

Bezeichnungssystem der Festigkeitsklassen

Die wichtigsten mechanischen Eigenschaften werden bei Schrauben aus Stahl durch eine zweistellige Zahlenkombination benannt – hier ein Beispiel:

Die erste Zahl gibt 1/100 der **Mindestzugfestigkeit** in N/mm² Spannungsquerschnitt an.
Zugfestigkeit 8 x 100 = 800 N/mm².

← **8.8** →

Die zweite Zahl gibt das 10fache des Verhältnisses der unteren Streckgrenze (R_{el} bzw. $R_{p0,2}$) zur Nennzugfestigkeit R_m (Streckgrenzenverhältnis) an.
Multiplikation beider Zahlen ergibt 1/10 der **Mindeststreckgrenze** in N/mm².
Streckgrenze 8 x 8 x 10 = 640 N/mm².

Tabelle 1: Mechanische Eigenschaften von Schrauben nach ISO 898-1

Eigenschaften	Festigkeitsklassen	3.6	4.6	4.8	5.6	5.8	6.8	8.8		10.9	12.9	
								≤ M 16	> M 16*			
Zugfestigkeit **	Nennwert	300	400		500		600	800		1000	1200	
R_m in N/mm ²	min.	330	400	420	500	520	600	800	830	1040	1220	
Streckgrenze **	Nennwert	180	240	320	300	400	480	–	–	–	–	
R_{el} in N/mm ²	min.	190	240	340	300	420	480	–	–	–	–	
0,2 % Dehngrenze **	Nennwert	–						640	640	900	1080	
$R_{p0,2}$ in N/mm ²	min.	–						640	660	940	1100	
Untere Streckgrenze R_{el} / 0,2 – Dehngrenze $R_{p0,2}$ bei erhöhten Temperaturen in N/mm² (ISO 898-1 Ausgabe 11/99, Tab. A1)	Dauereinsatz bei erhöhten Temperaturen kann zu deutlicher Spannungsrelaxation führen !	+ 100° C	–	–	–	270	–	–	590		875	1020
	+ 200° C	–	–	–	230	–	–	540		790	925	
	+ 250° C	–	–	–	215	–	–	510		745	875	
	+ 300° C	–	–	–	195	–	–	480		705	825	
Bruchdehnung A in % **	min	25	22	–	20	–	–	12		9	8	
Härte Vickers (F ≤ 98 N) **	HV min-max	95-220	120-220	130-220	155-220	160-220	190-250	250-320	255-335	320-380	385-435	
	***	250	250	250	250	250	–	–	–	–	–	
Härte Brinell (F = 30 D2) **	HB min-max	90-209	114-209	124-209	147-209	152-209	181-238	238-304	242-318	304-361	366-414	
	***	238	238	238	238	238	–	–	–	–	–	
Härte Rockwell **	HRB min-max	52-95	67-95	71-95	79-95	82-95	89-99,5	–	–	–	–	
	***	99,5	99,5	99,5	99,5	99,5	–	–	–	–	–	
	HRC min-max	–	–	–	–	–	–	22-32	23-34	32-39	39-44	

* Stahlbauschrauben ab M 12

** Werte gelten bei Raumtemperatur ca. +20 °C

*** Max.-Wert am Schraubenende

Kennzeichnung von Schrauben

Nach Norm sind Schrauben ab Gewindedurchmesser M 5 mit einem Herstellerzeichen und mit dem Festigkeitsklassen-Kennzeichen wie folgt zu versehen*:

- ① ② **Sechskantschrauben und Schrauben mit Außensechsrund** in allen Festigkeitsklassen möglichst auf dem Kopf, erhöht oder vertieft
- ③ ④ **Zylinderschrauben mit Innensechskant und mit Innensechsrund** in allen Festigkeitsklassen möglichst auf dem Kopf, erhöht oder vertieft
- ⑤ **Flachrundschrauben mit Vierkantansatz** aller Festigkeitsklassen auf der Kopfoberfläche erhöht oder vertieft
- ⑥ ⑦ **Stiftschrauben** 5.6 und ab Festigkeitsklasse 8.8 auf dem Schaft oder auf der Kuppe des Mutternendes.
Bei Platzmangel können Symbole verwendet werden, und zwar für 5.6 = –, 8.8 = ○, für 10.9 = □ und für 12.9 = △
- ⑧ **Kennzeichnung von Schrauben mit reduzierter Belastbarkeit**, wie zum Beispiel Zylinderschrauben mit ISK und niedrigem Kopf (DIN 7984): vor die Festigkeitsklasse wird eine Null (0) gestellt – z. B. „08.8“
Die Kennzeichnungspflicht wird in den Produktnormen geregelt. Weitere Schrauben mit reduzierter Belastbarkeit sind z. B. Senkkopfschrauben mit ISK nach ISO 10642



Kennzeichnung von Gewindestücken nach DIN 976 (Gewindestangen nach DIN 975)

werden mit der Festigkeitsklasse ab 5.6 gekennzeichnet. Das Herstellerkennzeichen ist nicht erforderlich.

Alternativ ist folgende Farbkennzeichnung:

Festigkeitsklasse/ Werkstoff	Farbe
5.6	kastanienbraun
5.8	enzianblau
8.8	verkehrsgelb
10.9	perlweiß
12.9	verkehrsschwarz
A2-70	verkehrgrün
A4-70	feuerrot

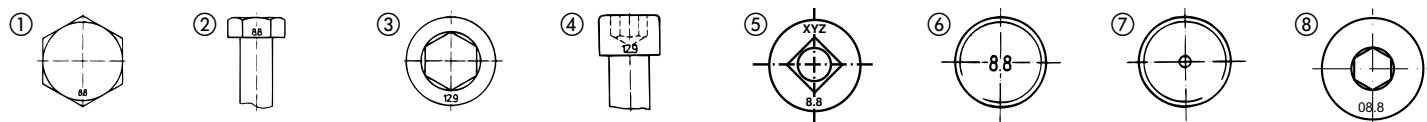

* Bei Platzmangel darf nach ISO 898-1 eine Kennzeichnung im Uhrzeigersystem angewendet werden (→ analog Tabelle 3)

Tabelle 2: Härteklassen für Gewindestifte nach ISO 898-5

Bezeichnung	14 H	22 H	33 H	45 H
Vickershärte HV min.	140	220	330	450

Eine Kennzeichnung auf den Produkten ist nicht vorgeschrieben bzw. nur in den Produktnormen geregelt.



Die DIN-Produkt- und Funktionsnormen für Muttern werden auf ISO-Normen umgestellt. In der Übergangszeit werden demzufolge Normen für bisherige DIN- und für neue ISO-Mutterausführungen nebeneinander im Markt sein.

Informationen über Veränderungen, die die Umstellung auf internationale Normen mit sich bringt, siehe TI-7: „Normenumstellung DIN → ISO“

Die Festigkeit von Muttern mit Regelgewinde wird in ISO 898-2 (EN 20898-2/DIN 267-4) und für Muttern mit Feingewinde in ISO 898-6 angegeben. Die Tragfähigkeit einer Mutter wird über die Härte und die Mutterhöhe bestimmt und über die Prüfkraft definiert. Bei bestimmten Mutterarten ist eine Kennzeichnung des Produktes mit der Festigkeitsklasse vorgeschrieben. Die Art der Kennzeichnung sowie die Stelle, wo sie angebracht sein muss, wird u. a. in den Normen ISO 898-2, DIN 267-24 und DIN 267-13 vorgeschrieben.

Die Schlüsselnummer gibt eine direkte Zuordnung zu den Festigkeitsklassen von Schrauben an (→ Tabelle 3).

Muttern mit Nennhöhe $\geq 0,8 D$

Die erste Zahl der Festigkeitsklasse der Schraube ergibt die Zuordnung zur Festigkeitsklasse der Mutter. Für Muttern mit Nennhöhe $\sim 0,8 D$, das sind z. B. Muttern nach DIN 555 und DIN 934, ist die Kennzeichnung eine Zahl, z. B. (8 = 1/100 der Prüfspannung in N/mm²). Die Markierung von 2 senkrechten Balken (| |) verweist auf die geltenden Prüfkräfte nach DIN 267-4.

Für Muttern mit Nennhöhe $\geq 0,8 D$, das sind z. B. Muttern nach ISO 4032 und ISO 8673, ist die Kennzeichnung eine Zahl, z. B. (8 = 1/100 der Prüfspannung in N/mm²), ohne Markierung von 2 senkrechten Balken (| |). Hierfür gelten die Prüfkkräfte nach ISO 898-2.

Kennzeichnung: Sechskantmuttern dieser Gruppe sind ab einem Gewindedurchmesser $\geq M 5$ mit dem Herstellerzeichen und der Festigkeitsklasse gemäß Tabelle 3 oder Tabelle 4 zu kennzeichnen.



Tabelle 3: Zuordnung der Mutterfestigkeitsklassen zu den Schraubenfestigkeitsklassen

Festigkeitsklasse der Mutter	Zugehörige Schraube		Mutter – Gewindebereich	
	Festigkeitsklasse	Gewindebereich	Typ 1 ¹⁾	Typ 2 ¹⁾
4	4.6 4.8	> M 16	> M 16	
5	4.6 4.8	≤ M 16	≤ M 39	
	5.6 5.8	≤ M 39		
6	6.8	≤ M 39	≤ M 39	
8	8.8	≤ M 39	≤ M 39	> M 16 ≤ M 39
10	10.9	≤ M 39	≤ M 39	
12	12.9	≤ M 39	≤ M 16	≤ M 39

1) Der Typ legt die erforderlichen Prüfkkräfte in ISO 898-2 fest.

Anmerkung gemäß ISO 898-2: Im Allgemeinen können Muttern der höheren Festigkeitsklasse anstelle von Muttern der niedrigen Festigkeitsklasse verwendet werden. Dies ist ratsam für eine Schraube-Mutter-Verbindung mit Belastungen oberhalb der Streckgrenze oder oberhalb der Prüfspannung.

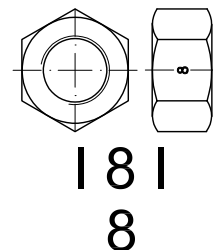
Tabelle 4: Alternative Kennzeichnung der Festigkeitsklasse durch Symbole (Uhrzeigersystem)

Festigkeitsklasse	4	5	6	8	10	12 ²⁾
Kennzeichnung						

2) Der Kennzeichnungspunkt kann nicht durch das Herstellerzeichen ersetzt werden.

Muttern mit Nennhöhe $\geq 0,5 D < 0,8 D$

Für Muttern mit Nennhöhe $\geq 0,5 D < 0,8 D$, das sind z. B. Muttern nach ISO 4035, ISO 8675 und DIN 439-2, ist die Kennzeichnung eine Zahl mit voran gesetzter „0“, z. B. (05 = 1/100 der Prüfspannung in N/mm²). Die vorgesetzte 0 zeigt an, dass Muttern dieser Gruppe die Kraft einer Schraube wegen geringer Bauhöhe nicht oder nur eingeschränkt aufnehmen können.

Kennzeichnung: Sechskantmuttern dieser Gruppe sind ab einem Gewindedurchmesser $\geq M 5$ mit dem Herstellerzeichen und der Festigkeitsklasse zu kennzeichnen.

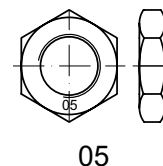

Niedrige Muttern ohne festgelegte Prüfkkräfte

Für niedrige Mutter, meist mit einer Nennhöhe $< 0,5 D$, wie z. B. Muttern nach DIN 936, ergibt die Kennzeichnung 1/10 der Mindesthärte nach Vickers, z. B. 22 H (=220 HV).

In diese Gruppe fallen Muttern für leichte Verbindungen bzw. Befestigungen ohne festgelegte Belastungswerte. Die Härteklassen für diese Muttern sind in DIN 267-24 festgelegt.

Kennzeichnung: Muttern der Härteklasse 22H sind ab einem Gewindedurchmesser $\geq M 5$ mit der Härteklasse zu kennzeichnen.

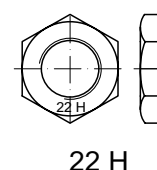



Die Eigenschaften von Verbindungselementen nach amerikanischen ASME-Normen sind u. a. in den folgenden Normen/Standards geregelt:

- Außensechskant- und Außenvierkantschrauben: ASME B18.2.1-2010
- Innensechskantschrauben: ASME B18.3-2012
- Muttern: ASME B18.2.2-2010
- Flache Scheiben: ASME B18.22.1-1965

Die Festigkeitsklassen/mechanischen Eigenschaften für diese Verbindungselemente sind in verschiedenen Normen und Standards geregelt, die teilweise in den Produktnormen enthalten sind. Eine klare und strikte Trennung wie im Bereich der DIN/EN/ISO-Normen in Produkt- und Funktionsnormen ist im Bereich der ASME-Standards nicht vorhanden.

Eigenschaften von Außensechskantschrauben nach ASME B18.2.1-2010 Tabelle 6

Die Norm ASME B18.2.1-2010 regelt die Eigenschaften von Außensechskant- und Außenvierkantschrauben mit Zollgewinde. Der Standard sieht hier insgesamt 8 verschiedene Produktgeometrien vor. Eine wichtige Unterscheidung ist diejenige zwischen sogenannten „bolts“ und „screws“. Eine allgemeingültige Definition von „bolts“ und „screws“ existiert leider nicht. Im Bereich der Außensechskantschrauben sind „bolts“ immer Schrauben ohne ausgeprägte Tellerauflage, „screws“ hingegen besitzen immer eine Tellerauflagefläche. Im Folgenden sollen die Eigenschaften von hex cap screws (ASME B18.2.1-2010 Tabelle 6) näher behandelt werden. Eine Unterscheidung zwischen Teil- und Vollgewinde gibt es in dieser Norm nicht. Schrauben bis zu einer gewissen Länge werden mit Vollgewinde geliefert, längere Produkte dann mit Teilgewinde.

Tabelle 5: Übersicht Vollgewinde/Teilgewinde nach ASME B18.2.1-2010

Durchmesser in inch	Abmessungen mit Vollgewinde (83933)	Abmessungen mit Teilgewinde (83931)	Mindest- und Maximallänge des Teilgewindes in inch		Durchmesser in inch	Abmessungen mit Vollgewinde (83933)	Abmessungen mit Teilgewinde (83931)	Mindest- und Maximallänge des Teilgewindes in inch	
	Länge bis in inch	Länge von bis in inch	min.	max.		Länge bis in inch	Länge von bis in inch	min.	max.
1/2	1 1/8	1 1/4 bis 6	3/4	1.000	1 1/8	3 1/2	3 5/8 bis 6	2 1/2	3.214
5/16	1 1/4	1 5/16 bis 6	7/8	1.153	1 1/4	3 3/4	3 7/8 bis 6	2 3/4	3.464
3/8	1 3/8	1 1/2 bis 6	1	1.312	1 3/8	4 1/4	4 5/16 bis 6	3	3.833
7/16	1 5/8	1 3/4 bis 6	1 1/8	1.482	1 1/2	4 1/2	4 5/8 bis 6	3 1/4	4.083
1/2	1 3/4	1 7/8 bis 6	1 1/4	1.635	1 3/4	5 1/8	5 1/4 bis 6	3 3/4	4.75
9/16	2	2 1/8 bis 6	1 3/8	1.792	2	5 3/4	5 7/8 bis 6	4 1/4	5.361
5/8	2 1/8	2 1/4 bis 6	1 1/2	1.955	2 1/4	6 1/2	6 5/8 bis 12	5	5.861
3/4	2 1/2	2 5/8 bis 6	1 3/4	2.250	2 1/2	7 1/8	7 1/4 bis 12	5 1/2	6.500
7/8	2 3/4	2 7/8 bis 6	2	2.556	2 3/4	7 5/8	7 3/4 bis 12	5 3/4	7.000
1	3	3 1/8 bis 6	2 1/4	2.875	3	8 1/8	8 1/4 bis 12	6 1/2	7.500

Artikel 83931 entspricht den längeren Abmessungen mit Teilgewinde und Artikel 83933 entspricht den kürzeren Abmessungen mit Vollgewinde.

Die Gewindetoleranzen für Zollschraben sind in der Norm ASME B18.1.1 geregelt, dabei gelten folgenden Toleranzen:

- die Toleranzlage 2A vor einer galvanischen Beschichtung,
- die Toleranzlage 3A (Gutlehring) und 2A (Ausschußlehring) nach der Beschichtung soweit nichts anderes vereinbart wird.

Die mechanischen Eigenschaften für Schrauben nach ASME B18.2.1 werden nach dem Standard SAE J429 (siehe Tabelle 2) definiert. Festigkeiten werden dort üblicherweise in psi (pound-force per square inch) angegeben, 1000 psi = 6,895 N/mm².

Tabelle 6: Mechanische Eigenschaften von Außensechskantschrauben nach ASME B18.2.1/SAE J429

Festigkeitsklasse Eigenschaften	Grade 5 (~ 8.8)		Grade 8 (~ 10.9)
	Ø > 1/4 - 1	Ø > 1 - 1 1/2	Ø > 1/4 - 1
Zugfestigkeit N/mm ² psi	827 120.000	724 105.000	1034 150.000
0,2% Dehngrenze N/mm ² psi	634 92.000	558 81.000	896 130.000
Bruchdehnung in %	Min. 14%		Min. 12%
Kernhärte Rockwell in HRC min-max	25 - 34	19 - 30	33 - 39
Kennzeichnung der Festigkeitsklasse			

Schrauben nach ASME B18.2.1 sollen mit dem Herstellerkennzeichen und der Festigkeitsklasse nach SAE J429 gekennzeichnet sein.



Eigenschaften von Innensechskantschrauben nach ASME B18.3-2012 Tabelle 1

Die Norm ASME B18.3-2012 regelt die Eigenschaften von Innensechskantschrauben mit Zollgewinde. Im Jahr 1960 wurde die bis dahin in einer Version von 1936 vorliegende Norm grundlegend überarbeitet. Dabei hat sich auch die Kopfgeometrie geändert. Die gelieferte Ware entspricht vollständig der „1960 series“, die „1936 series“ kann auf Anfrage bezogen werden. Der Standard ASME B18.3 sieht hier insgesamt 5 verschiedene Produktgeometrien (u. a. Senkkopf und niedrigere Kopfhöhe) vor. Im Folgenden werden hier die hexagon socket head cap screws (vergleichbar DIN 912/ISO 4762) näher beschrieben.

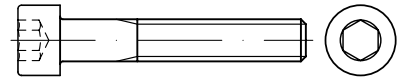

Die Gewindetoleranzen für Zollschauben sind in der Norm ASME B18.1.1 geregelt, es gelten dabei folgende Toleranzen:

- bis einschl. 1“: Klasse 3A,
- über 1“: Klasse 2A.

Die mechanischen Eigenschaften für Schrauben nach ASME B18.3-2012 Tabelle 1 werden nur nach dem Standard ASTM A574 (siehe Tabelle 6) definiert. Festigkeiten werden dort üblicherweise in psi (pound-force per square inch) angegeben, 1000 psi = 6,895 N/mm².

Diese Schrauben sollen nur mit dem Herstellerkennzeichen gekennzeichnet sein, da für dieses Produkt nur eine Festigkeitsklasse vorgesehen ist. Der Kopf der Innensechskantschraube kann nach Wahl des Herstellers eine Rändelung haben. Eine galvanische Beschichtung sollte auf Grund der hohen Zugfestigkeit und der damit verbundenen Gefahr der Wasserstoffversprödung vermieden werden.

Tabelle 7: mechanische Eigenschaften von Innensechskantschrauben nach ASME B18.3/ASTM A574

Eigenschaften	Stahl nach ASTM A574 (~ 12.9)	
	Ø ≤ 1/2	Ø > 1/2
Zugfestigkeit N/mm ² psi	1241 180.000	1172 170.000
0,2% Dehngrenze N/mm ² psi	1054 153.000	
Bruchdehnung in %	Min. 10%	
Kernhärte Rockwell in HRC min-max	39 - 45	37 - 45

Eigenschaften von Muttern nach ASME B18.2.2-2010 Tabelle 7

Die Norm ASME B18.2.2 regelt die Eigenschaften von Muttern mit Zollgewinde. Diese Norm sieht wiederum 14 verschiedene Produkttypen vor. „Hex nuts“ sind dabei die Produkte, die als Artikel 83934 in diesem Katalog geführt werden.

Die Gewindetoleranzen für Muttern sind ebenfalls in der Norm ASME B18.1.1 geregelt. Sofern nichts anderes vereinbart wird, werden die Muttern in Toleranzklasse 2B geliefert. Diese Muttern lassen sich mit verzinkten und unverzinkten Produkten verschrauben.

Die mechanischen Eigenschaften für Muttern nach ASME B18.2.2 werden nach dem Standard SAE J995 (siehe Tabelle 8) definiert. Festigkeiten werden dort üblicherweise in psi (pound-force per square inch) angegeben, 1000 psi = 6,895 N/mm².

Tabelle 8: mechanische Eigenschaften von Muttern „hex nuts“ nach ASME B18.2.2/SAE J 995

Eigenschaften Festigkeitsklasse	grade 5 (~ 8)		Grade 8 (~ 10)		
	Ø > 1/4 - 1 UNC	Ø > 1 - 1 1/2 UNC	Ø > 1/4 - 5/8 UNC	Ø > 5/8 - 1" UNC	Ø > 1 - 1 1/2 UNC
Spannung unter Prüfkraft N/mm ² psi	827 120.000	723 105.000	1034 150.000		
Kernhärte Rockwell in HRC min.-max.	≤ 32		24 - 32	26 - 34	26 - 36
Kennzeichnung der Festigkeitsklasse					

Muttern nach ASME B18.2.2 sollen mit dem Herstellerkennzeichen und der Festigkeitsklasse gekennzeichnet sein.

Eigenschaften von Scheiben nach ASME B18.22.1-1965 Typ A

Die Norm ASME B18.22.1 regelt die Eigenschaften von Scheiben für Schrauben mit Zollgewinde. Die Norm unterscheidet im Wesentlichen 2 Ausführungen: „narrow“ und „wide“. Der Unterschied zwischen beiden Ausführungen liegt im größeren Außendurchmesser für die Scheiben der Ausführung „wide“ (siehe Tabelle Maßseiten).

Anforderungen an mechanische Eigenschaften gibt es für Scheiben der Ausführung „plain“ nicht, diese sollen lediglich aus Stahlwerkstoffen hergestellt werden. Eine Übersicht der Eigenschaften der Scheiben ist in Tabelle 9 gegeben.

Tabelle 9: mechanische Eigenschaften von Scheiben nach ASME B18.22.1/ASTM F436

Eigenschaften	Plain washers ASME B18.22.1	gehärtete Scheiben nach ASTM F436		
		gehärtet, blank oder galZn	gehärtet, tZn	einsatzgehärtet
Kernhärte Rockwell in HRC min.-max.	Keine Spezifikation	38 - 45	26 - 45	Min. 30 HRC
Einsatzhärte/Einsatzhärte HR15N - Blank/galZn - tZn				0,015/79 - 83 0,015/73 - 83



Die mechanischen Eigenschaften von Verbindungselementen aus nichtrostenden Stählen sowie deren Kennzeichnung und Prüfung sind in den Teilen der ISO 3506 festgelegt. Aktuell werden die Teile 1 und 2 überarbeitet und ein neuer Teil 6 (Richtlinie für die Auswahl und Eigenschaften von nichtrostenden Stählen) erstellt. Auszüge aus diesen Entwürfen bzw. Manuskripten werden an dieser Stelle ebenfalls mit verwendet.

Nichtrostende Stähle werden nach ISO 3506 entsprechend ihren Gefügearten in vier Stahlgruppen eingeteilt. Die verschiedenen Stahlsorten für nicht-rostende Stähle können durch eine Vielzahl von Werkstoffen realisiert werden und bieten unterschiedliche Korrosionsbeständigkeits- und Funktionseigenschaften.

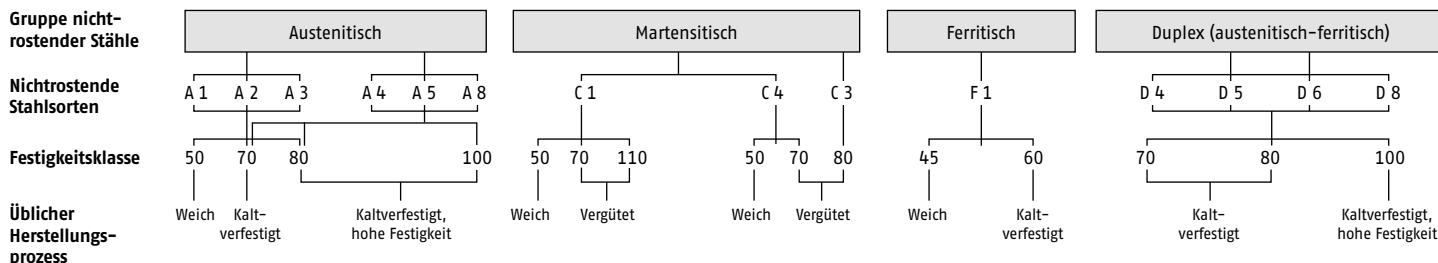

Der Zustand der Oberfläche der Befestigungselemente (Passivierung → ISO 16048, Oberflächenrauheit usw.) kann die Korrosionsbeständigkeit des Befestigungselements beeinflussen. Befestigungselemente aus nichtrostenden Stählen können in Umgebungen mit niedrigen Temperaturen wie folgt verwendet werden:

- martensitischer, ferritischer und Duplex-Stahl sind für Betriebsumgebungen bis -40 °C geeignet
- austenitischer Stahl eignet sich für Betriebsumgebungen bis -196 °C (Schrauben mit Kopf bis -60 °C , Schrauben ohne Kopf bis -200 °C nach DIN 267-13)

Austenitische Stähle (A)

Austenitische rostfreie Stähle werden im Allgemeinen in austenitische Chrom-Nickel-Stähle (A 1 bis A 3) und austenitische Chrom-Nickel-Molybdän-Stähle (A 4 bis A 8) eingeteilt. Austenitische Edelstähle können nicht durch Abschrecken gehärtet werden. Die mechanischen Eigenschaften der Verbindungselemente werden üblicherweise durch Kaltverfestigung erreicht. Durch Kupfer kann die Umformbarkeit des austenitischen Gefüges verbessert werden.

A 2- und A 4-Stähle können unter folgenden Bedingungen eine höhere Anfälligkeit für Interkristalline Korrosion aufweisen:

- der Kohlenstoffgehalt liegt über $0,030\%$ und/oder
- der Stahl ist hohen Temperaturen ausgesetzt (entweder während des Herstellungsprozesses, eines Schweißprozesses oder in der Betriebsumgebung)

In diesen Fällen können Stähle mit einem Kohlenstoffgehalt von weniger als $0,030\%$ (A 2L oder A 4L) oder stabilisierte austenitische Stähle der Stahlsorten A 3 oder A 5 verwendet werden.

A 8 ist ein hochlegierter austenitischer Edelstahl mit einer Korrosionsbeständigkeit, die wesentlich höher als bei A 4 ist.

Austenitische Stähle sind im geglühten Zustand normalerweise nicht magnetisch, jedoch kann die Kaltumformung, die während der Herstellung des Befestigungselements auftritt, zu einem gewissen Restmagnetismus führen.

Die Stahlsorten A 1 – A 3 sind **nicht** für die Verwendung in nicht oxidierenden Säuren oder in einer Umgebung mit Chlorid geeignet (z. B. in Schwimmbädern, die Chlorid als Reinigungsmittel verwenden, oder in marinen Umgebungen).

- A 1:** Nichtrostende Stähle der Stahlsorte A 1 sind speziell für die mechanische Bearbeitung ausgelegt. Aufgrund des hohen Schwefelgehalts weist diese Sorte eine geringere Korrosionsbeständigkeit auf als entsprechende Stähle mit normalem Schwefelgehalt.
- A 2:** Nichtrostende Stähle der Stahlsorte A 2 sind die am häufigsten verwendeten Edelstähle für gepresste Verbindungselemente und haben eine höhere Korrosionsbeständigkeit als A 1.
- A 3:** Nichtrostende Stähle der Stahlsorte A 3 haben ähnliche Eigenschaften wie Stähle der Stahlsorte A 2, jedoch mit erhöhter Temperaturbeständigkeit (typischerweise bis 350 °C). Sie werden durch Zusatz von Titan oder Niob stabilisiert, die Kohlenstoff und Stickstoff binden.
- A 4:** Nichtrostende Stähle der Stahlsorte A 4 werden häufig als „säurefeste Stähle“ bezeichnet, sind mit Molybdän legiert und weisen eine wesentlich bessere Korrosionsbeständigkeit auf. Diese Stahlsorte kann in einigen Umgebungen verwendet werden, in denen Chlorid vorhanden ist, jedoch nicht in Schwimmbädern mit Chlorid als Reinigungsmittel und in vielen maritimen Umgebungen.
- A 5:** Nichtrostende Stähle der Stahlsorte A 5 sind stabilisierte Edelstähle mit Eigenschaften von Stählen der Sorte A 4, jedoch mit erhöhter Temperaturbeständigkeit (typischerweise bis zu 350 °C). Sie werden durch Zusatz von Titan oder Niob stabilisiert, die Kohlenstoff und Stickstoff binden. Diese Stahlsorte kann in einigen Umgebungen verwendet werden, in denen Chlorid vorhanden ist, jedoch nicht in Schwimmbädern mit Chlorid als Reinigungsmittel und in vielen maritimen Umgebungen.
- A 8:** Stähle der Stahlsorte A 8 sind als „6 % Mo“-Stähle bekannt. Sie haben eine hohe Beständigkeit gegen alle Formen der Korrosion, einschließlich Loch-, Spalt- und Spannungsrisskorrosion. Sie sind für den Einsatz in Schwimmbädern geeignet, in denen Chlorid als Reinigungsmittel verwendet wird, jedoch sollten spezifische Anforderungen und/oder Vorschriften für Gebäude und Bauwerke beachtet werden. Sie eignen sich auch für Anwendungen in maritimen Umgebungen.

Permeabilität

A 2:	$\mu_r \approx 1,8$
A 4:	$\mu_r \approx 1,015$
A 4L:	$\mu_r \approx 1,005$

Auszug aus ISO 3506-1 Anhang H

Martensitische Stähle (C)

Drei martensitische Stahlsorten C 1, C 3 und C 4 sind in der ISO 3506-Reihe enthalten. Sie können durch Abschrecken gehärtet werden. Die mechanischen Eigenschaften nehmen mit steigendem Kohlenstoffgehalt zu, weswegen der Chromgehalt erhöht wird, um eine geeignete Korrosionsbeständigkeit zu erreichen. Die martensitischen Stahlsorten haben normalerweise eine geringere Korrosionsbeständigkeit als austenitische Stahlsorten. Bei Temperaturen unter null ist Vorsicht geboten, da martensitische Edelstähle eine schlechtere Schlagfestigkeit und Dehnbarkeit aufweisen als austenitische Stähle. Martensitische Stahlsorten sind immer stark magnetisch.



Ferritische Stähle (F)

Die mechanischen Eigenschaften von ferritischen Stählen werden durch Kaltverfestigung (Kaltverformung) erzeugt, wobei jedoch der Wirkungsgrad geringer ist als bei austenitischen rostfreien Stählen. Ferritische Stähle sind immer magnetisch. Wenn für die geplante Anwendung eine niedrigere Korrosionsbeständigkeit als die der Stahlsorten A 2 oder A 3 ausreichend ist, kann die Edelstahlsorte F 1 ein guter wirtschaftlicher Kompromiss sein. Die Stahlsorte F 1 sollte jedoch nicht bei Temperaturen unter -20 °C verwendet werden, da ferritische rostfreie Stähle eine schlechte Schlagfestigkeit und Dehnbarkeit aufweisen.

Duplex Stähle (D)

Das Gefüge von Duplex Stähle hat eine Mischung aus Ferrit- und Austenitkörnern mit einem Ferritgehalt von typischerweise 40 bis 60 Vol .-%. Im lösungsgeglühten Zustand ist die Festigkeit von rostfreien Duplexstählen deutlich höher als die Festigkeit von austenitischen nichtrostenden Stählen und kann durch Kaltverfestigung weiter gesteigert werden, wobei jedoch die Duktilität sinkt. Duplex-Stahlsorten werden normalerweise wie folgt beschrieben:

- „Lean-Duplex“ mit niedrigem Legierungsgehalt, insbesondere Nickel und Molybdän (D 2 und D 4),
- „Standard-Duplex“ (D 6),
- „Super-Duplex“ mit hohem Legierungsgehalt (D 8).

Duplex Stähle haben im Vergleich zu austenitischen Edelstählen A 1 bis A 5 eine deutlich verbesserte Beständigkeit gegen Spannungsrissskorrosion. Duplex Stähle sollten nicht für Anwendungen außerhalb des Temperaturbereiches von -40 °C bis $+250\text{ °C}$ verwendet werden.

D2/D4: In Bezug auf Lochfraß und Spaltkorrosion weist D 2 im Vergleich zu A 2 mindestens eine äquivalente Korrosionsbeständigkeit auf und D 4 weist im Vergleich zu A 4 mindestens eine äquivalente Korrosionsbeständigkeit auf.

D6: Der „Standard-Duplex“ hat einen Molybdängehalt von mehr als 2,5% und verbessert damit die Korrosionsbeständigkeit im Vergleich zu A 1 bis A 5 und D 4, insbesondere im Hinblick auf Lochfraß und Spaltkorrosion.

D8: Der "Super-Duplex" weist eine mit A 8 vergleichbare Korrosionsbeständigkeit auf.

Kennzeichnung: Sechskantschrauben, Zylinderschrauben mit Innensechskant oder Innensechsrund, Stiftschrauben und Muttern sind ab einem Gewindenennendurchmesser $\geq M 5$ (Stiftschrauben ab $\geq M 6$) mit dem Herstellerzeichen, der Stahlsorte und der Festigkeitsklasse zu kennzeichnen.



Tabelle 9: Mechanische Eigenschaften für Verbindungselemente aus A 1 – A 8, D 2 – D 8 und BUMAX88/109 bei ca. $+20\text{ °C}$

Festigkeitsklasse	Durchmesserbereich	Schrauben				Muttern	
		Zugfestigkeit Rm N/mm ² min.	0,2 % Dehngrenze Rp N/mm ² min.	Temperatureinfluß auf die 0,2% Dehngrenze	Bruchdehnung A mm min.	Prüfspannung Sp/N/mm ² min. m $\geq 0,8$ d 0,5 d $\leq m < 0,8$ d	
50	$\leq M 39$	500	210	Nur für Austenite A 1 – A 8 bei 100 °C = 85% bei 200 °C = 80% bei 300 °C = 75% bei 400 °C = 70%	0,6 d	500	250 (Fkl. – 025)
70	$\leq M 24$	700	450		0,4 d	700	350 (Fkl. – 035)
80	$\leq M 24$	800	600		0,3 d	800	400 (Fkl. – 040)
100*	k. A.	1000	800		0,2 d	1000	500 (Fkl. – 050)
BUMAX88	$\leq M 36$	800	640		bei 200 °C = 90% bei 300 °C = 85% bei 400 °C = 80%	0,3 d	800
BUMAX109	$\leq M 12$ M14 – M 20	1000 1000	900 800	bei 200 °C = 95% bei 300 °C = 95% bei 400 °C = 90%	0,2 d	1000	–

*Festigkeitsklasse 100 nach Entwurf ISO 3506-1/-2:2018-02

Tabelle 10: Chemische Zusammensetzung in % nach ISO 3506/EN 10088-3

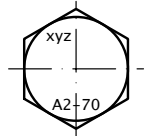
Stahlsorte	Übliche Werkstoffe (ISO/DIS 3506-6)	C	Cr	Mo	Ni	Cu
A 1	1.4305 (303)	0,12	16 – 19	0,7	5 – 10	(1,75-) 2,25
A 2	1.4301 (304)	0,10	15 – 20	–	8 – 19	4
A 3	1.4541 (321)	0,08	17 – 19	–	9 – 12	1
A 4	1.4401 (316) BUMAX88 BUMAX109	0,08	16 – 18,5	2,0 – 3,0	10 – 15	4
A 5	1.4571 (316 Ti)	0,08	16 – 18,5	2,0 – 3,0	10,5 – 14	1
A 8*	1.4529	0,03	19 – 22	6,0 – 7,0	17,5 – 26	1,5
C 1	1. 4021	0,09 – 0,15	11,5 – 14	–	1	–
C 3	1. 4057	0,17 – 0,25	16 – 18	–	1,5 – 2,5	–
C 4	1. 4005	0,08 – 0,15	12 – 14	0,6	1	–
F 1	1. 4016	0,08	15 – 18	–	1	–
D 2*	1. 4482	0,04	19 – 24	0,10 – 1,0	1,5 – 5,5	3
D 4*	1. 4062	0,04	21 – 25	0,10 – 2,0	1,0 – 5,5	3
D 6*	1. 4462	0,03	21 – 26	2,5 – 3,5	4,5 – 7,5	–
D 8*	1. 4410	0,03	24 – 26	3,0 – 4,5	6,0 – 8,0	2,5

Auszug aus ISO 3506-1 mit den wichtigsten chemischen Elementen (Detaillierte Angaben \rightarrow ISO 3506).

*Neue Stahlsorten nach Entwurf ISO 3605-1/-2: 2018-02



Chemische Beständigkeit von Verbindungselementen aus nichtrostenden Stählen A 2 und A 4

Die Beständigkeitsangaben können sich in der Praxis verändern; selten wirken die reinen Agenzien, oft verstärken oder schwächen Beimengungen den Angriff. Auch Rückstände am Teil können die Bedingungen verändern. Der sicherste Weg ist die Untersuchung unter Betriebsbedingungen.

Tabelle 16: Auszug aus der Beständigkeitsliste
(Weitere Informationen auf Anfrage)

Agenzien	Beständigkeitsgrad		Agenzien	Beständigkeitsgrad		Agenzien	Beständigkeitsgrad	
	A 2	A 4		A 2	A 4		A 2	A 4
Abwässer ohne Schwefelsäure	1	1	Fettsäure, 150° C	1	1	Natriumphosphat	1	1
Aceton, alle Konz.	1	1	Flüssige Gase (Propan, Butan)	1	1	Natriumsulfat	1	1
Alaun (10 %), kalt	1	1	Formalin	1	1	Natriumsulfid	1	1
gesättigte Lösung, kochend	3	1	Fruchtsäfte	1	1	Natriumsulfit	1	1
Aluminiumacetat	1	1	Gerbsäure	1	1	Nickelsulfat	1	1
Aluminiumsulfat (10 %), kalt	1	1	Glyzerin	1	1	Nitrosensäure	2	1
gesättigt, kalt	2	1	Kaliumbichromat (25 %)	1	1	Öle (Schmier- und vegetabilische Öle)	1	1
Ameisensäure, kalt	1	1	Kaliumbitartrat, kalt	1	1	Oxalsäure, 5 %, kalt	1	1
Ammoniumcarbonat	1	1	Kaliumchlorat	1	1	Phenol, kochend	2	1
Ammoniumnitrat	1	1	Kaliumhydroxid (Kalilauge)	1	1	Phosphorsäure bis 70 %, kalt	1	1
Ammoniumsulfat, kalt	1	1	Kaliumnitrat	1	1	Photograph. Entwickler/Fixierbad	1	1
Ammoniumsulfid	1	1	Kaliumpermanganat	1	1	Pottasche	1	1
Anilin	1	1	Kalkmilch	1	1	Quecksilber	1	1
Benzin	1	1	Kaliumsulfat	1	1	Quecksilberamalgam	1	1
Benzoesäure	1	1	Kampfer	1	1	Quecksilbernitrat	1	1
Benzol	1	1	Kohlendioxid	1	1	Salicylsäure	1	1
Bier	1	1	Kreosot	1	1	Salmiakgeist	1	1
Blausäure	1	1	Kupferacetat	1	1	Salpetersäure bis 60 %, kalt	1	1
Borsäure	1	1	Kupferarsenit	1	1	Schwefel (geschmolzen)	1	1
Butylacetat	1	1	Kupfernitrat	1	1	Schwefeldioxid	1	1
Calciumbisulfit, kalt	1	1	Kupfersulfat	1	1	Schwefelkohlenstoff	1	1
kochend	3	1	Latex	1	1	Schwefelwasserstoff	1	1
Calciumhydroxid (10–50 %), kalt	1	1	Leimöl	1	1	Schweflige Säure, gesättigt, 20 °C	1	1
Calciumnitrat	1	1	Magnesiumsulfat	1	1	Seewasser, 20 °C	1L	1L
Chlor, trocken	1	1	Maleisäure	1	1	Seife	1	1
Chloroform, wasserfrei	1	1	Melasse	1	1	Teer	1	1
Chlorschwefel, wasserfrei	1	1	Methylalkohol	1	1	Tetrachlorkohlenstoff, wasserfrei	1	1
Chromsäure (10 %), kalt	1	1	Milchsäure, alle Konz., kalt	1	1	Trichlorethylen, wasserfrei	1	1
kochend	2	2	Milchsäure, (80%), kochend	3	2	Viskose	1	1
Cyankalium	1	1	Natriumaluminat	1	1	Wasserglas	1	1
Eisennitrat	1	1	Natriumbisulfat, kochend	1	1	Wasserstoffsuperoxid	1	1
Eisensulfat	1	1	Natriumbisulfid, kochend	1	1	Wein	1	1
Entwickler (Foto)	1	1	Natriumkarbonat (Soda)	1	1	Weinsäure	1	1
Essigsäure, kalt	1	1	Natriumhydroxid, kalt	1	1	Zinksulfat	1	1
Ethylether, kochend	1	1	Natriumnitrat	1	1	Zitronensäure, gesättigt, kalt	1	1
Ethylacetat	1	1	Natriumperchlorat	1	1	Zitronensäure, 50 %, kochend	3	2
Ethylalkohol, alle Konz.	1	1			Zuckerlösung	1	1	

1 – beständig (Substanzverlust weniger als 0,1 g/m² x h)
2 – bedingt beständig (Substanzverlust von 0,1 bis 1,0 g/m² x h)

3 – wenig beständig (Substanzverlust von 1,0 bis 10,0 g/m² x h)
4 – unbeständig (Substanzverlust über 10,1 g/m² x h)
L – Gefahr der Loch-, Spalt- oder Spannungsrisskorrosion

Verbindungselemente in Schwimmhallenatmosphäre	Werkstoffe (Stahlgruppe)
Anwendungsbereich	
Nicht tragende Bereiche mit gelegentlicher Umspülung bzw. mit Schwimmbadwasser in Berührung kommende Bereiche, die regelmäßig gereinigt werden (z. B. Geländer im Beckenrand, dekorative Verkleidungen)	1.4401 (A 4) 1.4404 (A 4L) 1.4571 (A 5)
Nicht tragende Bereiche mit gelegentlicher Umspülung bzw. mit Schwimmbadwasser in Berührung kommende Bereiche, die nicht regelmäßig gereinigt werden (z. B. Überlaufrippen, Gitterroste und Rutschen)	1.4439 1.4539 1.4462 (D 6)
Tragende Bereiche ohne Umspülung bzw. nicht mit Schwimmbadwasser in Berührung kommende Bereiche, die nicht regelmäßig gereinigt werden (z. B. Befestigungen von Hängeleuchten, Deckenabhängungen, Wasserrutschen,..)	1.4539* 1.4529* (A 8) 1.4565* 1.4547* (A 8)

*Allgemeine bauaufsichtliche Zulassung Z-30.3-6

In den blauen Katalogseiten: Das große Artikelsortiment aus nichtrostenden Stählen.



Die mechanischen Eigenschaften von Verbindungselementen aus Nichteisenwerkstoffen sowie deren Kennzeichnung und Prüfung sind in ISO 8839 festgelegt.

Tabelle 17: Metallische Nichteisenwerkstoffe (Cu, MS, Al, Ti) für Verbindungselemente und Sonderteile

(Auszug aus ISO 8839/DIN 267-18)

Werkstoff			Zugfestigkeit R_m N/mm ²	0,2%-Dehn- grenze $R_{p0,2}$ N/mm ²	Bruchdehnung A %	Anmerkungen
Kennzeichen	Kurzzeichen	Nummer	min.	min.	min.	
CU 1	E-Cu57	2.0060	240	160	14	-
CU 2	CuZn37 (MS 63)	2.0321	370-440	250-340	19-11	Lagerhaltung gepreßte Teile
CU 3	CuZn39Pb3 (MS 58)	2.0401	370-440	250-340	19-11	Lagerhaltung gedrehte Teile
CU 4	CuSn6	2.1020	400-470	200-340	33-32	-
CU 5	CuNi1, 5Si	2.0853	590	540	12	seewasserbeständig
CU 6	CuZn40MnPb	2.0580	440	180	18	-
CU 7	CuAl10Ni	2.0966	640	270	15	-
AL 1	AlMg3	3.3535	250-270	180-230	4-3	bedingt seewasserbeständig
AL 2	AlMg5	3.3555	280-310	200	6	seewasserbeständig
AL 3	AlMgSi1	3.2315	310	250	10-7	-
AL 4	AlCuMg1	3.1325	380-420	260-290	10-6	-
AL 5	AlZnMgCu0,5	3.4345	460	380	7	-
AL 6	AlZnMgCu1,5	3.4365	510	440	7	-
Ti 1	Titan (Titan 99,5)	3.7025	290	180	30	Lagerhaltung (→ gelbe-Katalog Seiten)
Ti 2	TiAl6V4	3.7165	890	820	10	-

Tabelle 18: Seewasserbeständige Kupferlegierungen für Verbindungselemente und Sonderteile

(Auszug aus DIN 17660, 17664, 17666)

Benennung	Nummer	Zusammensetzung ca. %	Zugfestigkeit R_m ca. N/mm ²	0,2 %-Dehngrenze $R_{p0,2}$ ca. N/mm ²	Bruchdehnung A_s ca. %
SO-MS 59	2.0540	Cu 59/Zn 36/Ni 2/Mn 1,5	500	300	18
RESISTIN	-	Cu 85/Mn 14/Fe 1	520	400	17-12
CuNiSi	2.0853	Cu 98/Ni 1,5/Si 0,5	590	540	10
CUNIFER	2.0872	Cu 88/Ni 10/Fe 1/Mn 0,5	280-360	100-250	30-10
CUNIFER	2.0882	Cu 69/Ni 30/Fe 0,5/Mn 0,5	340-420	120-300	35-14

Tabelle 19: Kunststoffe (Thermoplaste) für Verbindungselemente und Sonderteile

(Richtwerte – weitere Details – spez. grobe Toleranzen → VDI 2544 oder auf Anfrage)

Kurz- zeichen	Rohstoffgruppe (Handelsname)	Dichte g/cm ³	Streckspannung ca. N/mm ²	Reißdehnung trocken / feucht ca. %	Elastizitäts-Modul trocken / luftfeucht ca. N/mm ²	Einsatztemperatur -/+ ca. °C
PA 6	Polyamid 6 (Ultramid)	1,14	30 - 80	130 / 220	2700 / 1800	-40/+80-130
PA 6.6*	Polyamid 6.6 (Ultramid A)	1,14	60 - 65	50 / 200	3200 / 1400	-20/+80-140
POM	Polyacetal (Delrin 150)	1,42	69	30	3000	-40/+100-130
PP	Polypropylen (Hostalen PPH)	0,91	30 - 35	15	1000 - 1300	-10/+100-120
PA 12	Polyamid 12	1,01	48 - 55	150 / 350	1800 - 1300	-0/+100
PC	Polycarbonat	1,2	60	80 / 100	2100	-0/+130
PA 6.6* (gfv)	mit 50 % Glasfaser	1,55	195 - 215	190 / 220	16800 / 12500	-40/+100-140

Lagerhaltige Verbindungselemente = PA 6/PA 6.6 naturfarben/milchig weiß, sofern nicht anders angegeben.
Aus den übrigen Werkstoffen sind Verbindungselemente kurzfristig lieferbar, andere Werkstoffe auf Anfrage.

*Angaben aus DIN 34810

Normteile und Sonderteile nach Zeichnung können für die unterschiedlichen Einsatzfälle in allen erforderlichen Sonder-Werkstoffen geliefert werden – in jeder benötigten Menge.

Die Tabelle zeigt – grob nach Anwendungsbereichen geordnet – einige Beispiele von häufig geforderten Sonder-Werkstoffen:

Werkstoff-Gruppe Besondere Eigenschaften/Anwendungsbereiche	Werkstoff-Nr.	(AISI)	Werkstoff-Kurzname (bisher)	Norm/ Werkstoffblatt	
Nichtrostende Stähle – ¹⁾ a) ferritisch (F) und martensitisch (C) Höhere mechanische Eigenschaften bei geringerer Korrosionsbeständigkeit	F 1	1.4016	X6Cr17 (X8Cr17)	EN 10088 (DIN 17440)	
	C 1	1.4006 (410)	X10Cr13	ISO 3506 (DIN 267-11)	
	C 1	1.4021 (420)	X20Cr13		
	C 3	1.4057 (431)	X20CrNi172 (X20CrNi17)		
	C 4	1.4104 (430 F)	X12CrMoS17		
		1.4034 (420)	X46Cr13 (X40Cr13)		
b) austenitisch (A) Erhöhte Korrosionsbeständigkeit, rost- und säurebeständig, kaltzäh	A 3	1.4541* (321)	X6CrNiTi1810	EN 10088 (DIN 17440)	
	A 4	1.4436 (319)	X5CrNiMo17133 (X5CrNiMo1812)	ISO 3506 (DIN 267-11) * DIN 267-13	
	A 5	1.4571* (316 Ti)	X6CrNiMoTi1722		
	A 4	1.4580 (316 Cb)	X6CrNiMoNb17122 (X10CrNiMoNb1810)		
		1.4310** (301)	X12CrNi177	** SEW 400	
Rost- und säurebeständiger Stahl Für besondere Korrosionsmedien z. B. für den Einsatz in Hallen-Schwimmbädern	Uranus B 6	1.4539	X1NiCrMoCu 25 20 5	ISO 3506-1, E1 ISO DIS 3506-6 (besonders beständig gegen chloridinduzierte Spannungsrisskorrosion)	
	Austenitisch A 8	1.4439	X2CrNiMoN 17 13 5		
		1.4529	X1NiCrMoCuN 25 20 7		
	D 6	1.4462	X2CrNiMoN 22 5 3		
Kaltzähe Stähle Steigendes Festigkeits- und Streckgrenzverhalten und hohe Zähigkeit bei Tieftemperaturen bis – 195 °C (SEW) bzw. – 253 °C (AD)	Kennzeichen KA	1.7219	26CrMo4	DIN 267-13 SEW 680/70	
	Kennzeichen KB	1.5680	12Ni19		
	Kennzeichen KC	1.6900	X12CrNi189		
	Kennzeichen KD	1.6903	X10CrNiTi1810		
	A 2	1.4301 (304)	X5CrNi1810	ISO 3506 (DIN 267-11) DIN 267-13 EN 10088 (DIN 17440) ADW 2/ADW 10	
	A 2	1.4303 (305)	X5CrNi1812		
	A 3	1.4541 (321)	X6CrNiTi1810		
	A 4	1.4401 (316)	X5CrNiMo17122		
	A 5	1.4571 (316 Ti)	X6CrNiMoTi17122		
	Warmfeste, hochwarmfeste und hitzebeständige Stähle Gute Temperaturbeständigkeit bei mittleren bzw. untergeordneten mechanischen Eigenschaften	Kennzeichen Y oder YK	1.1181	C35E	DIN 267-13 EN 10269
Kennzeichen KG		1.7218	25CrMo4		
Kennzeichen GA		1.7709	21CrMoV5-7		
Nimonic 80 A		2.4631/2.4952	NiCr20TiAl	EN 10269 (DIN 17240, DIN 17480 DIN 17225)	
Nimonic 90		2.4632/2.4969	NiCr20Co18Ti		
Nimonic 105		2.4634	NiCo20Cr15MoAlTi		
(Sicromal 8)		1.4713	X10CrAl7	SEW 470/76	
		1.4724	X10CrAl13		
(Sicromal 10)		1.4742	X10CrAl18		
(Sicromal 12)		1.4762	X10CrAl24		
	1.4821	X20CrNiSi254			
	1.4828 (309)	X15CrNiSi2012			
	1.4841 (310)	X15CrNiSi2520			
	1.4845 (310 S)	X12CrNi2521			
	1.4864 (330)	X12NiCrSi3616			
Nichtmagnetisierbare Stähle – ¹⁾ Mechanische Eigenschaften (Zugfestigkeit, Streckgrenze, Zähigkeit) sind abhängig vom Behandlungszustand – z. B. abgeschreckt, warm-/kaltverformt, ausgehärtet	Amanox 182M9	1.3805	X35Mn18	SEW 390/61	
		1.3813	X40MnCrN19		
		1.3817	X40MnCr18		
		1.3819	X50MnCrV2014		
		1.3952	X4CrNiMoN1814		
		1.3960	X45MnNiCrV1376		
		1.3965	X8CrMnNi188		
		1.3967	X50CrMnNi229		
			(202)		
Nickel, Nickel-Legierungen Höchste Korrosionsbeständigkeit, seewasserbeständig, sehr gute bis höchste Beständigkeit gegen aggressive chemische Agenzien, hoher Oxidationswiderstand, hohe bis optimale mechanische Eigenschaften und Zeitstandfestigkeit – auch bei hohen Temperaturen	Nickel 99.6	2.4060	Ni 99,6	EN 10088 (DIN 17740)	
	Nickel 99.2	2.4066	Ni 99,2		
	Nickel 99	2.4068	LC-Ni 99		
	Hastelloy B	2.4617	NiMo28	DIN 17744	
	Hastelloy C	2.4610	NiMo16Cr16Ti		
	Monel 400/Silverin	2.4360*	NiCu30Fe	DIN 17743 * ASTM B 164 Class A	
	K-Monel/Silverin Al	2.4375	NiCu30Al		
	Inconel 600/625	2.4816/2.4856	NiCr15Fe	DIN 17742 DIN 17744 * EN 10269 (DIN 17240) * DIN 267-13	
Nicrofer 7216					
Inconel X 750/ Nimonic 80 A	2.4952*	NiCr15Ti7Al/NiCr20TiAl			
Incolloy 825/ Nicrofer 4221	2.4858	NiCr21Mo			
Titan, Titan-Legierungen Geringes spezifisches Gewicht, hohe Korrosionsbeständigkeit, seewasserbeständig, amagnetisch	Titan 992 (Grade 4)	3.7065	Ti 99,2	DIN 17850 DIN 17860 DIN 17862 DIN 17863 DIN 17864 * ISO 8839 (DIN 267-18)	
	Titan 993 (Grade 3)	3.7055	Ti 99,3		
	Titan 994 (Grade 2)	3.7035	Ti 99,4		
	Titan 995 (Grade 1)	3.7025*	Ti 99,5	DIN 17851 WL-Blätter * ISO 8839 (DIN 267-18)	
	Ti 1				
	Titan Al 6V4	3.7164	TiAl6V4		
Titan Grade 5/Ti 2	3.7165*	TiAl6V4			

1) Weitere austenitische Werkstoffe siehe „Teile aus nichtrostenden Stählen“ → TI-224

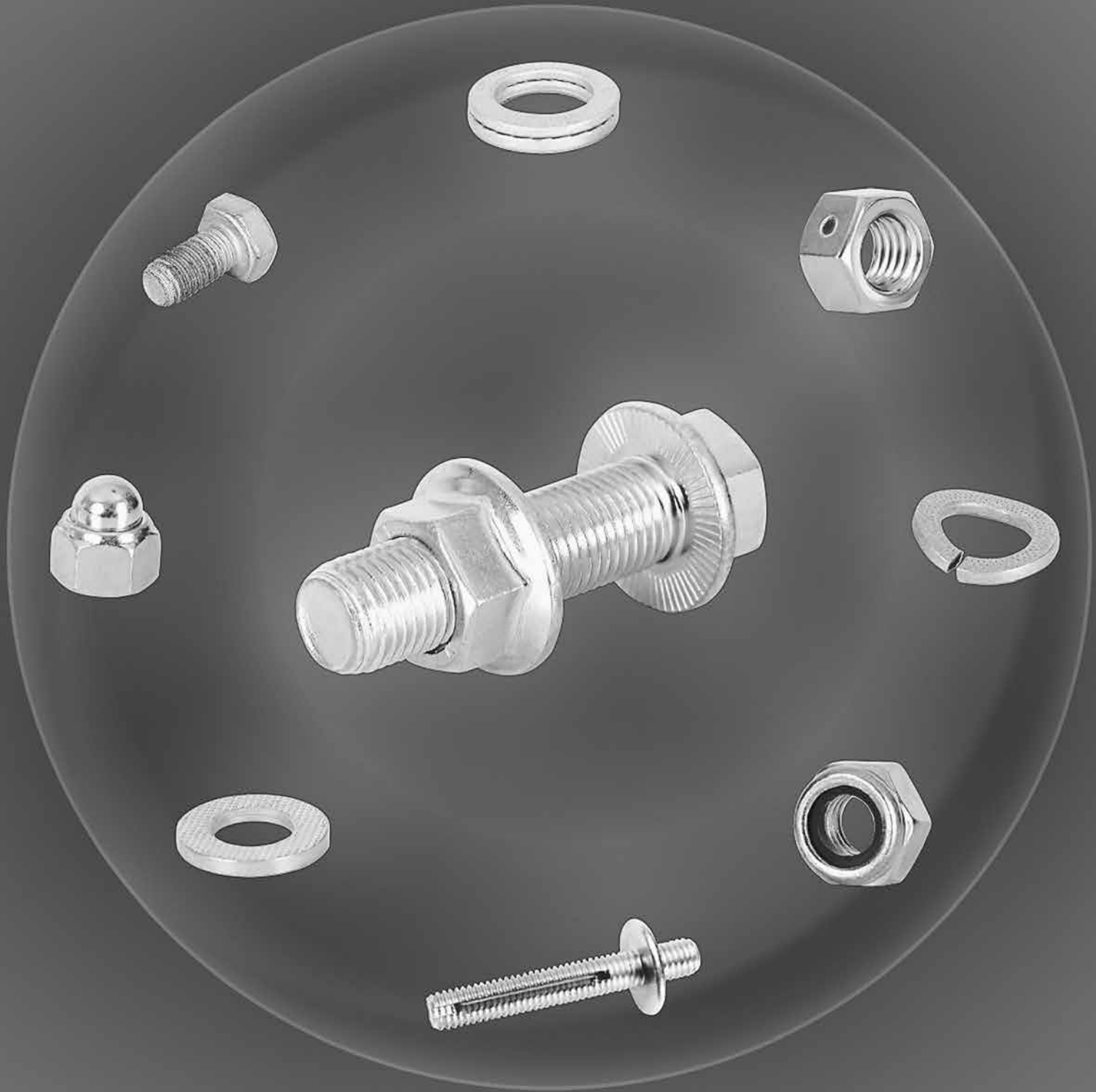



Allgemeines und Anziehverfahren

Grundsätzliche Hinweise

Funktionserfüllung und Dauerhaltbarkeit von Schraubverbindungen werden hauptsächlich bestimmt durch die Faktoren:

- mechanische Eigenschaften (Zugfestigkeit, Streckgrenze, Dehnung)
- Betriebsbedingungen (statisch/dynamisch...)
- Beanspruchungen (Temperatur, Korrosion)
- Dimensionierung (Durchmesser, Länge)
- ggf. Sicherung gegen Lockern oder Losdrehen
- Montage (Anziehverfahren, Vorspann-/Klemmkräfte, Anziehmoment...)

Es ist Aufgabe der konstruktiven Planung, in Kenntnis aller Anforderungen die geeigneten Verbindungselemente zu bestimmen, mit den genormten Bezeichnungen zu definieren und die notwendigen Montageanweisungen vorzugeben.

Für die „Systematische Berechnung hochbeanspruchter Schraubverbindungen“ steht als anerkanntes Standardwerk die VDI-Richtlinie 2230 zur Verfügung.

Schraubverbindungen sollen so berechnet und montiert sein, dass aufgrund ausreichend bleibender Klemmkraft unter Betriebsbelastungen keine Querkräfte (F_Q) senkrecht zur Schraubenachse zur Wirkung kommen können. Hierbei sind auch Klemmkraftverluste infolge von Setzbeiträgen zu berücksichtigen. Sind die Querkräfte größer als die Klemmkraft führt dies zum Lockern – und schließlich zum Versagen – der Verbindung.

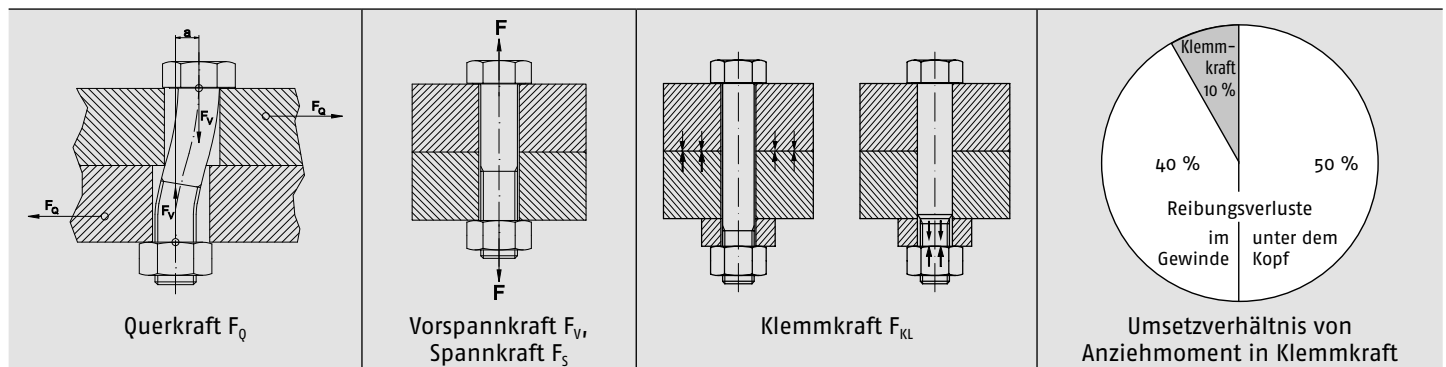

Anziehverfahren

Maßgebend für die Qualität und Dauerhaltbarkeit einer Schraubverbindung ist die genaue Einstellung/Einhaltung der Montagevorspannkraft. Bei der Montage ist somit neben der Größe der Schraube, der Festigkeitsklasse und den Reibungsverhältnissen das Anzieh-/Montageverfahren von entscheidender Bedeutung. Zahlreiche Versuche sowie theoretische Betrachtungen haben gezeigt, dass 80 bis 90 % des Anziehdrehmomentes für die Überwindung der Reibung unter Kopf und im Gewinde notwendig sind. Nur ein kleiner Teil wird in die Erzeugung der eigentlichen Vorspannkraft umgesetzt.

Man unterscheidet folgende Verfahren:

Handanzug

Das Anziehen nach Gefühl mit Handwerkzeugen sollte generell nicht angewendet werden! Die Streuung ist auch bei erfahrenen Werkern sehr groß. Erfahrungswerte zeigen, dass Schrauben bis M 12 meistens über die Streckgrenze angezogen sind; Schrauben über M 14 sind meistens zu niedrig angezogen.

Drehmomentgesteuertes Anziehen

Das Anziehen mit einem Drehmomentschlüssel weist wegen der Reibwertunterschiede immer noch eine recht hohe Streuung in der Vorspannkraft auf.

Impulsgesteuertes Anziehen

Bei der Montage mit Schlagschraubern wird die Motorenergie des Schraubers im Schlagwerk in tangentielle Drehimpulse umgesetzt. Damit wird die Schraube stufenweise vorgespannt. Der Vorteil der Schlagschrauber liegt darin, dass durch den Werker fast kein Reaktionsmoment aufgenommen werden muss. Der Nachteil liegt in den vielen Einflussfaktoren auf die Schraubenvorspannung:

- Elastizität und Reibwerte der Schraubverbindung
- Elastizität des aufgesteckten Werkzeuges und der Verlängerungen
- Schlag-Stärke und -Frequenz-Zeitdauer bzw. gesamte Schlagzahl

Längenmessungsgesteuertes Anziehen

Aus der Längenänderung der Schraube, die beispielsweise über ein Ultraschallverfahren im Zuge der Montage ermittelt wird, ergibt sich rechnerisch die entsprechende Vorspannkraft. Mit diesem Verfahren wird derzeit die höchstmögliche Genauigkeit erzielt. Dieses Verfahren ist jedoch sehr aufwändig und teuer.

Drehwinkelgesteuertes Anziehen

Bei diesem Verfahren wird die Schraube zuerst drehmomentgesteuert vorgespannt, dann um einen rechnerisch bestimmten Drehwinkel bis in den Beginn der plastischen Verformung weitergedreht. Das Verfahren erfordert aufwändige Vorversuche und ist damit teuer. Außerdem kann es nur für Schraubverbindungen mit genügend großer Dehnlänge angewendet werden. Durch die meist plastische Verformung der Schraube ist deren Wiederverwendbarkeit nicht gegeben.

Streckgrenzengesteuertes Anziehen

Dieses Verfahren erfordert eine Verschraubungsanlage, bestehend aus einem Drehschrauber, einer Steuereinheit und einem Rechner und nutzt zur Steuerung den technischen Sachverhalt, dass bei Erreichen der Streckgrenze der Schraube das Anziehdrehmoment nicht weiter ansteigt. Durch die plastische Verformung der Schraube ist deren Wiederverwendbarkeit nicht gegeben.

Hydraulisches Anziehen

Die hydraulische Vorspannung erfolgt über das überlange Ende der Schraube. Das Vorspanngerät stützt sich um die Mutter herum ab. Die Mutter kann formschlüssig oder mit einem kleinen Drehmoment angezogen werden. Der Schwerpunkt des hydraulischen Anziehens liegt im Anlagenbau bei großen Schrauben bis M 200. Es können z. B. alle Schrauben eines Flansches gleichzeitig angezogen werden, was zu einer gleichmäßigen Kraftverteilung führt.



Tabelle 1: Genauigkeitsklassen der Anziehverfahren, Einfluss der Reibungsverhältnisse, Streuung der Vorspannkkräfte

Genauigkeitsklasse	Streuung der Vorspannkraft %	Anziehfaktor	Einfluss des Reibungswertes?	Anziehverfahren (Werkzeuge)	Einstell-/Kontrollverfahren
-	± 2 – +10 ± 5 – ± 20	1,05 – 1,2 1,1 – 1,5	nein	• längungsgesteuert (Ultraschall) • Längenmessung (mechanisch)	Ultraschallsensor (→ PMT-System) Einstellung und Längenmessung
I	± 9 – ± 17	1,2 – 1,4	nein	• streckgrenzgesteuert • drehwinkelgesteuert (motorisch oder manuell)	Versuchsmäßige Bestimmung von Voranziehmoment/Drehwinkel
II	± 9 – ± 23	1,2 – 1,6	nein	• hydraulisch	Längen-/Druckmessung
III	± 17 – ± 23	1,4 – 1,6	ja	• drehmomentgesteuert (Drehmomentschlüssel, Verlängerungsmessung, Präzisionsdrehschrauber)	Versuchsmäßige Bestimmung des Sollanziehmomentes/dynamische Drehmomentmessung
IV	± 23 – ± 33	1,6 – 2,0	ja	• drehmomentgesteuert	Sollanziehmoment nach geschätzter Reibungszahl
V	± 26 – ± 43	1,7 – 2,5	ja	• drehmomentgesteuert (Drehschrauber) • impulsgesteuert (Schlagschrauber)	mit Nachziehmoment, gebildet aus Sollanziehmoment (nach geschätzter Reibungszahl) + Zuschlag
VI	± 43 – ± 60	2,5 – 4,0	ja	• impulsgesteuert (Schlagschrauber) • von Hand (Schraubenschlüssel)	ohne (ggf. über Nachziehmoment)

Tabelle 2: Reibungszahlen $\mu_{ges.}$ für Schrauben/Muttern* aus Stahl

Oberflächenzustand	Außengewinde (Schraube)	Innengewinde (Mutter/Werkstück)	$\mu_{ges.}$ bei Zustand		
			ungeschmiert	geölt	MoS ₂ -Paste
ohne Nachbehandlung (schwarz)			0,12 – 0,18	0,10 – 0,17	0,06 – 0,12
Mn-phosphatiert			0,14 – 0,18	0,14 – 0,15	0,06 – 0,11
Zn-phosphatiert		ohne Nachbehandlung	0,14 – 0,21	0,14 – 0,17	0,06 – 0,12
galvanisch verzinkt			0,12 – 0,20	0,10 – 0,18	
galvanisch verkadmet			0,08 – 0,14	0,08 – 0,11	
galvanisch verzinkt		galvanisch verzinkt	0,12 – 0,20	0,10 – 0,18	
galvanisch verkadmet		galvanisch verkadmet	0,12 – 0,16	0,12 – 0,14	

Achtung! Je nach Art/Umfang der Schmierung kann der Reibwert stärker differieren! Absicherung durch Verschraubungsversuch empfohlen!

Tabelle 3: Reibungszahlen μ_g und μ_k für Schrauben/Muttern* aus nichtrostendem Stahl

Schraube und Gegenlage aus	Mutter aus	Schmiermittel		Nachgiebigkeit der Verbindung	Reibungszahlen		
		im Gewinde	unter Kopf		im Gewinde μ_g	unter Kopf μ_k	
A 2 (~ A 4)	A 2 (~ A 4)	ohne	ohne	sehr groß	0,26 – 0,50	0,35 – 0,50	
		Spezialschmiermittel (Chlorparaffin-Basis)			0,12 – 0,23	0,08 – 0,12	
		Korrosionsschutzfett			0,26 – 0,45	0,25 – 0,35	
	AlMgSi	AlMgSi	ohne	ohne	klein	0,23 – 0,35	0,08 – 0,12
			Spezialschmiermittel (Chlorparaffin-Basis)			0,10 – 0,16	0,08 – 0,12
			ohne	ohne		sehr groß	0,32 – 0,43
Spezialschmiermittel (Chlorparaffin-Basis)		0,32 – 0,43	0,08 – 0,11				
					0,28 – 0,35	0,08 – 0,11	

* Richtwerte nach VDI 2230-1, Ausg. 07.86, Tab. 5-6 für Schrauben/Muttern mit Standard-Auflageflächen z. B. nach DIN 912, 931, 933, 934/ISO 4762, 4014, 4017, 4032

Sacklochgewinde – Einschraubtiefen

Die erforderliche Einschraubtiefe hängt von der Festigkeit des Muttergewindes sowie der Gewindesteigung ab. Tabelle 4 zeigt hierfür die entsprechenden Richtwerte.

Tabelle 4: Richtwerte für Mindesteinschraubtiefen in Sacklochgewinde

Festigkeitsklasse Schraube	8.8	8.8	10.9	10.9	12.9
	< 9	≥ 9	< 9	≥ 9	< 9
Gewindefeinheit d/P					
Mutterwerkstoff	harte Al-Leg.	1,1 d	1,4 d	-	
	Grauguss	1,1 d	1,25 d	1,4 d	
	Stahl R _m ≤ 400 MPa	1,0 d	1,25 d	1,4 d	
	Stahl R _m ≤ 500 MPa	0,9 d	1,0 d	1,2 d	
	Stahl R _m ≤ 800 MPa	0,8 d	0,9 d	1,0 d	

Quelle: Dubbel Taschenbuch für den Maschinenbau



Anziehmomente und Vorspannkkräfte für Verbindungselemente aus Stahl

Vorspannkkräfte und Anziehmomente für Schaftschrauben aus Stahl mit voller Belastbarkeit, mit Kopfaufmaßmaßen wie DIN 912, 931, 933, 934, ISO 4762, 4014, 4017, 4032*

In den Tabellenwerten für M_A sind berücksichtigt:

- a) Reibungszahl $\mu_{ges} = 0,14$ *
- b) Ausnutzung der Mindest-Streckgrenze = 90 %
- c) Torsionsmoment beim Anziehen
 (* Die Reibungszahl von $\mu_{ges} = 0,14$ wird allgemein für Schrauben und Muttern in handelsüblicher Lieferausführung angenommen)

Zusätzliche Schmierung der Gewinde verändert die Reibungszahl erheblich und führt zu unbestimmten Anziehverhältnissen! Anziehmethode und -werkzeuge weisen unterschiedliche Streuungen auf (→ Tab. 1/VDI 2230-1, Tab. A8).

Tabelle 5: Richtwerte für Schaftschrauben mit Regelgewinde, Reibungszahl $\mu_{ges} = 0,14$

Abmessung P	Spannungs- querschnitt AS (mm ²)	Vorspannkkräfte F_V (kN) für Festigkeitsklasse					Anziehmomente M_A (Nm) für Festigkeitsklasse					
		4.6	5.6	8.8	10.9	12.9	4.6	5.6	8.8	10.9	12.9	
M 4	0,7	8,78	1,6	2,0	4,30	6,30	7,40	1,2	1,5	3,3	4,8	5,6
M 5	0,8	14,2	2,6	3,2	7,00	10,3	12,0	2,4	3,0	6,5	9,5	11,2
M 6	1,0	20,1	3,7	4,6	9,90	14,5	17,0	4,1	5,2	11,3	16,5	19,3
M 8	1,25	36,6	6,7	8,4	18,1	26,6	31,1	10,1	12,6	27,3	40,1	46,9
M 10	1,5	58,0	10,7	13,4	28,8	42,2	49,4	19,9	24,9	54,0	79,0	93,0
M 12	1,75	84,3	15,6	19,5	41,9	61,5	72,0	34,4	43,0	93,0	137,0	160,0
M 14	2,0	115,0	21,4	26,8	57,5	84,4	98,8	54,7	68,4	148,0	218,0	255,0
M 16	2,0	157,0	29,4	36,7	78,8	115,7	135,4	84,8	106,0	230,0	338,0	395,0
M 18	2,5	193,0	35,8	44,8	99,0	141,0	165,0	118,0	147,0	329,0	469,0	549,0
M 20	2,5	245,0	45,9	57,4	127,0	181,0	212,0	166,0	208,0	464,0	661,0	773,0
M 22	2,5	303,0	57,3	71,6	158,0	225,0	264,0	228,0	285,0	634,0	904,0	1057,0
M 24	3,0	353,0	66,2	82,7	183,0	260,0	305,0	287,0	358,0	798,0	1136,0	1329,0
M 27	3,0	459,0	86,9	109,0	240,0	342,0	400,0	424,0	530,0	1176,0	1674,0	1959,0
M 30	3,5	561,0	106,0	132,0	292,0	416,0	487,0	576,0	720,0	1597,0	2274,0	2662,0
M 33	3,5	694,0	132,0	165,0	363,0	517,0	605,0	780,0	975,0	2161,0	3078,0	3601,0
M 36	4,0	817,0	155,0	193,0	427,0	608,0	711,0	1003,0	1253,0	2778,0	3957,0	4631,0
M 39	4,0	976,0	186,0	232,0	512,0	729,0	853,0	1300,0	1624,0	3597,0	5123,0	5994,0
M 42	4,5	1117,0	212,0	265,0	584,0	832,0	974,0	1605,0	2006,0	4413,0	6285,0	7354,0
M 45	4,5	1302,0	249,0	311,0	684,0	974,0	1140,0	2005,0	2506,0	5512,0	7851,0	9187,0
M 48	5,0	1468,0	280,0	350,0	770,0	1096,0	1283,0	2424,0	3030,0	6667,0	9495,0	11112,0
M 52	5,0	1753,0	335,0	419,0	922,0	1314,0	1537,0	3116,0	3896,0	8570,0	12206,0	14284,0
M 56	5,5	2024,0	387,0	484,0	1064,0	1516,0	1774,0	3883,0	4854,0	10678,0	15208,0	17797,0
M 60	5,5	2356,0	452,0	565,0	1242,0	1770,0	2071,0	4818,0	6022,0	13249,0	18870,0	22082,0
M 64	6,0	2669,0	511,0	639,0	1406,0	2003,0	2344,0	5802,0	7252,0	15955,0	22724,0	26592,0
M 68	6,0	3047,0	585,0	732,0	1610,0	2293,0	2683,0	7012,0	8765,0	19282,0	27462,0	32137,0
M 72	6,0	3451,0	665,0	831,0	1828,0	2603,0	3046,0	8379,0	10474,0	23043,0	32819,0	38405,0
M 76	6,0	3881,0	749,0	936,0	2059,0	2933,0	3432,0	9903,0	12378,0	27232,0	38785,0	45387,0
M 80	6,0	4335,0	838,0	1047,0	2304,0	3282,0	3840,0	11610,0	14514,0	31930,0	45476,0	53216,0
M 90	6,0	5580,0	1083,0	1353,0	2977,0	4240,0	4962,0	16796,0	20995,0	46188,0	65783,0	76980,0
M 100	6,0	6983,0	1359,0	1698,0	3736,0	5322,0	6227,0	23381,0	29226,0	64297,0	91574,0	107161,0

Tabelle 6: Richtwerte für Schaftschrauben mit Feingewinde, Reibungszahl $\mu_{ges} = 0,14$

Abmessung P	Spannungs- querschnitt AS (mm ²)	Vorspannkkräfte F_V (kN) für Festigkeitsklasse			Anziehmomente M_A (Nm) für Festigkeitsklasse			
		8.8	10.9	12.9	8.8	10.9	12.9	
M 8	1,0	39,2	19,7	28,9	33,9	29,2	42,8	50,1
M 10	1,25	61,2	30,8	45,2	52,9	57,0	83,0	98,0
M 12	1,25	92,1	46,8	68,7	80,4	101,0	149,0	174,0
M 12	1,5	88,1	44,3	65,1	76,2	97,0	143,0	167,0
M 14	1,5	125,0	63,2	92,9	109,0	159,0	234,0	274,0
M 16	1,5	167,0	85,5	126,0	147,0	244,0	359,0	420,0
M 18	1,5	216,0	115,0	163,0	191,0	368,0	523,0	613,0
M 20	1,5	272,0	144,0	206,0	241,0	511,0	728,0	852,0
M 22	1,5	333,0	178,0	253,0	296,0	692,0	985,0	1153,0
M 24	2,0	384,0	204,0	290,0	339,0	865,0	1232,0	1442,0
M 27	2,0	496,0	264,0	375,0	439,0	1262,0	1797,0	2103,0
M 30	2,0	621,0	331,0	472,0	552,0	1756,0	2502,0	2927,0
M 33	2,0	761,0	407,0	580,0	678,0	2352,0	3350,0	3921,0
M 36	2,0	915,0	490,0	698,0	817,0	3082,0	4390,0	5137,0
M 39	2,0	1082,0	581,0	828,0	969,0	3953,0	5631,0	6589,0

Tabelle 5 und 6: bis M 39 Auszug aus VDI 2230-1: 2003-02, über M 39 Berechnung auf Grundlage VDI 2230-1: 2003-02



Anziehdrehmomente und Vorspannkräfte für Verbindungselemente aus Stahl

Vorspannkräfte und Anziehmomente für Schachtschrauben aus Stahl mit eingestellten Reibzahlfenstern* und mit Kopfauflagemaßen wie DIN 912, 931, 933, 934, ISO 4762, 4014, 4017, 4032

*das Reibzahlfenster μ_{ges} ist für die zutreffenden Verbindungselemente auf den Preisseiten dieses Kataloges ausgewiesen

Tabelle 7: Richtwerte für Schachtschrauben mit Regelgewinde, Ausnutzung der Mindest-Streckgrenze von 90 %

Abmessung P	Spannungs- querschnitt A (mm ²)	Vorspannkräfte F_v (kN) für Festigkeitsklasse und μ_{ges}						Anziehmomente M_A (Nm) für Festigkeitsklasse und μ_{ges}						
		8.8		10.9		12.9		8.8		10.9		12.9		
		0,09	0,12	0,09	0,12	0,09	0,12	0,09	0,12	0,09	0,12	0,09	0,12	
M 4	0,7	8,8	4,5	4,4	6,6	6,5	7,8	7,6	2,5	3,0	3,5	4,6	4,1	5,1
M 5	0,8	14,2	7,5	7,2	11,0	10,6	12,7	12,4	4,8	5,9	7,1	8,6	8,0	10,0
M 6	1,0	20,1	10,6	10,2	15,5	14,9	17,9	17,5	8,4	10,1	12,3	14,9	14,0	17,4
M 8	1,25	36,6	19,3	18,6	28,4	27,3	32,9	32,0	20,2	24,6	29,6	36,1	34,0	42,2
M 10	1,5	58,0	30,7	29,6	45,1	43,4	52,3	50,8	39,7	48,0	58,3	71,0	67,0	83,0
M 12	1,75	84,3	44,7	43,0	65,1	63,2	76,3	74,0	68,3	84,0	100,0	123,0	115,6	144,0
M 14	2,0	115,0	61,3	59,1	90,0	86,7	104,6	101,5	109,0	133,0	160,0	195,0	183,8	229,0
M 16	2,0	157,0	83,8	80,9	123,0	118,8	143,2	139,0	167,0	206,0	245,0	302,0	282,1	354,0
M 18	2,5	193,0	106,0	102,0	150,0	145,0	174,9	170,0	241,0	295,0	343,0	421,0	394,7	492,0
M 20	2,5	245,0	135,0	130,0	192,0	186,0	223,9	217,0	337,0	415,0	480,0	592,0	553,0	692,0
M 22	2,5	303,0	168,0	162,0	239,0	231,0	278,9	271,0	458,0	567,0	652,0	807,0	753,3	945,0
M 24	3,0	353,0	194,0	188,0	277,0	267,0	322,5	313,0	580,0	714,0	825,0	1017,0	952,9	1190,0
M 27	3,0	459,0	255,0	246,0	363,0	351,0	422,9	410,0	847,0	1050,0	1207,0	1496,0	1398,7	1750,0
M 30	3,5	561,0	310,0	300,0	442,0	427,0	514,9	499,0	1154,0	1428,0	1644,0	2033,0	1905,5	2380,0
M 33	3,5	694,0	385,0	373,0	549,0	531,0	639,9	621,0	1552,0	1928,0	2211,0	2747,0	2565,8	3214,0
M 36	4,0	817,0	453,0	438,0	645,0	623,0	752,0	729,0	2001,0	2482,0	2850,0	3535,0	3307,3	4136,0
M 39	4,0	976,0	543,0	525,0	773,0	748,0	901,6	875,0	2578,0	3208,0	3672,0	4569,0	4263,2	5346,0

Vorspannkräfte und Anziehmomente für Schachtschrauben aus dem Werkstoff 25CrMo4 +QT (1.7218) mit Kopfauflagemaßen wie ISO 4762, 4014, 4017, 4032

Tabelle 8: Richtwerte für Schachtschrauben mit Regelgewinde aus 25CrMo4 +QT ($R_m \geq 600$ MPa, $R_{p0,2} \geq 440$ MPa) und Ausnutzung der Mindest-Streckgrenze von 90 %

Abmessung P	Spannungs- querschnitt A (mm ²)	Vorspannkräfte F_v (kN) für μ_{ges}			Anziehmomente M_A (Nm) für μ_{ges}			
		0,10	0,12	0,14	0,10	0,12	0,14	
M 8	1,25	36,6	13,0	12,7	12,3	14,6	16,6	18,4
M 10	1,5	58,0	20,7	20,2	19,6	28,9	32,8	36,5
M 12	1,75	84,3	30,1	29,4	28,6	49,8	56,7	63,0
M 14	2,0	115,0	41,2	40,3	39,3	79,3	90,2	100,3
M 16	2,0	157,0	56,6	55,3	53,9	122,0	139,3	155,5
M 18	2,5	193,0	69,2	67,5	65,7	170,3	194,0	216,0
M 20	2,5	245,0	88,6	86,5	84,2	239,1	273,2	304,9
M 22	2,5	303,0	110,4	107,8	105,1	326,3	373,9	418,2
M 24	3,0	353,0	127,6	124,5	121,3	412,0	470,8	525,4
M 27	3,0	459,0	167,3	163,5	159,3	606,1	694,9	777,7
M 30	3,5	561,0	203,7	198,9	193,9	825,0	944,7	1056,2
M 33	3,5	694,0	253,3	247,5	241,3	1112,6	1277,0	1430,4
M 36	4,0	817,0	297,6	290,7	283,4	1433,1	1642,9	1838,5
M 39	4,0	976,0	356,9	348,8	340,1	1849,6	2124,8	2381,5

Vorspannkräfte und Anziehmomente für Dehnschachtschrauben aus dem Werkstoff 21CrMoV5-7 +QT (1.7709) nach DIN 2510

Tabelle 9: Richtwerte für Dehnschachtschrauben mit Regelgewinde aus 21CrMoV5-7 +QT ($R_m \geq 700$ MPa, $R_{p0,2} \geq 550$ MPa) und Ausnutzung der Mindest-Streckgrenze von 70 %

Abmessung P	Schacht \varnothing	Vorspannkräfte F_v (kN) für μ_{ges}		Anziehmomente M_A (Nm) für μ_{ges}		
		0,10	0,12	0,10	0,12	
M 12	1,75	8,5	21,6	21,6	38,0	44,0
M 16	2,0	12,0	43,5	43,5	98,0	115,0
M 20	2,5	15,0	67,8	67,8	190,0	220,0
M 24	3,0	18,0	97,8	97,8	320,0	370,0
M 27	3,0	20,5	126,5	126,5	465,0	545,0
M 30	3,5	23,0	160,0	160,0	650,0	770,0
M 33	3,5	25,5	196,5	196,5	870,0	1000,0
M 36	4,0	27,5	228,5	228,5	1100,0	1300,0
M 39	4,0	30,5	281,0	281,0	1450,0	1750,0
M 42	4,5	32,5	319,0	319,0	1800,0	2100,0
M 45	4,5	35,5	381,0	381,0	2300,0	2700,0
M 48	5,0	37,5	425,0	425,0	2750,0	3250,0



Anziehmomente und Vorspannkkräfte für Verbindungselemente aus Stahl

Vorspannkkräfte und Anziehmomente für Schrauben mit reduzierbarer Belastbarkeit wie DIN 6912, 7984, ISO 7380 -1/-2, 10642

Schrauben mit reduzierter Belastbarkeit sind genormte oder nicht genormte Schrauben mit Werkstoff- und Festigkeitseigenschaften nach ISO 898-1, die aufgrund ihrer Geometrie die Prüfanforderungen für die volle Belastbarkeit nicht erfüllen. Schrauben mit reduzierter Belastbarkeit brechen im Zugversuch üblicherweise nicht in der freien belasteten Gewindelänge. Es gibt im Wesentlichen zwei geometrische Gründe für die reduzierte Belastbarkeit von Schrauben:

- Kopfgeometrie, z. B. Schrauben mit:
 - niedrigem Kopf mit oder ohne Außenantrieb
 - niedrigem runden oder niedrigem zylindrischen Kopf mit Innenantrieb
 - Senkkopf mit Innenantrieb
 - Schaftgeometrie: z. B. Schrauben mit Dehnschaft
- Kenntlich wird die reduzierte Belastbarkeit durch eine „0“ vor der Festigkeitsklasse gemacht, z. B. 08.8 oder 010.9. Schrauben der oben genannten Produktnormen können etwa 80% der Vorspannkkräfte von voll belastbaren Schrauben aufnehmen.

Tabelle 10: Richtwerte für Schrauben nach DIN 6912, 7984, ISO 7380 -1/-2, 10642, Reibungszahl $\mu_{ges} = 0,14$

Abmessung	Vorspannkkräfte F_V (kN) für Festigkeitsklasse		Anziehdrehmomente M_A (Nm) für Festigkeitsklasse	
	08.8	010.9	08.8	010.9
M 3	1,9	2,9	1,1	1,6
M 4	3,4	5,0	2,6	3,8
M 5	5,5	8,1	5,1	7,4
M 6	7,8	11,0	8,8	13,0
M 8	14,0	21,0	21,0	31,0
M 10	23,0	34,0	42,0	62,0
M 12	33,0	49,0	73,0	108,0
M 14	46,0	67,0	117,0	171,0
M 16	63,0	92,0	181,0	266,0
M 18	79,0	112,0	259,0	370,0
M 20	101,0	144,0	366,0	521,0
M 22	126,0	180,0	502,0	715,0
M 24	146,0	207,0	630,0	898,0
M 30	233,0	331,0	1.267,0	1.805,0
M 36	340,0	484,0	2.206,0	3.140,0

Vorspannkkräfte und Anziehmomente für Schaftschrauben aus Stahl mit UNC-/UNF-Gewinde und Kopfauflagen nach ASME B18.2.1, ASME B18.3 und ASME B18.2.2

Tabelle 11: Richtwerte für Schaftschrauben mit UNC-Gewinde, Reibungszahl $\mu_{ges} = 0,14$ und Ausnutzung der Mindest-Streckgrenze von 90 %

Abmessung		Vorspannkkräfte F_A für Festigkeitsklasse						Anziehmomente M_A für Festigkeitsklasse					
\varnothing	G	Grade 5*		Grade 8*		ASTM A 574		Grade 5*		Grade 8*		ASTM A 574	
		[kN]	[lbf]	[kN]	[lbf]	[kN]	[lbf]	[Nm]	[ft-lbs]	[Nm]	[ft-lbs]	[Nm]	[ft-lbs]
#2	56	1,2	262	1,7	370	1,9	435	0,5	0,4	0,7	0,5	0,8	6,0
#4	40	1,9	423	2,7	598	3,1	704	1,1	0,8	1,5	1,1	1,8	1,3
#5	40	2,5	565	3,6	798	4,2	940	1,6	1,2	2,2	1,6	2,6	1,9
#6	32	2,8	636	4,0	899	4,7	1058	2,0	1,5	2,8	2,1	3,3	2,4
#8	32	4,5	1000	6,3	1413	7,4	1663	3,6	2,7	5,1	3,8	6,1	4,5
#10	24	5,5	1232	7,8	1741	9,1	2050	5,3	3,9	7,4	5,5	8,7	6,4
1/4	20	10,1	2260	14,2	3194	16,7	3759	12,1	8,95	17,1	12,6	20,2	14,9
5/16	18	16,7	3764	23,7	5319	27,8	6260	25,7	18,9	36,3	26,7	42,7	31,5
3/8	16	24,9	5594	35,2	7904	41,4	9303	44,6	32,9	63,0	46,4	74,1	54,7
7/16	14	34,2	7684	48,3	10858	56,8	12780	70,9	52,3	100,0	73,9	117,9	87,0
1/2	13	45,8	10300	64,7	14554	76,2	17131	109,0	80,3	154,0	114,0	181,1	133,6
5/8	11	73,2	16464	103,0	23265	121,8	27384	213,0	157,0	301,0	222,0	354,5	261,4
3/4	10	109,0	24485	154,0	34599	181,2	40725	383,0	283,0	541,0	399,0	637,2	470,0
7/8	9	151,0	33891	213,0	47889	250,7	56368	614,0	453,0	868,0	640,0	1021,5	753,4
1	8	198,0	44499	280,0	62879	329,2	74012	922,0	680,0	1303,0	961,0	1533,3	1130,9
1 1/8	7	219,0	49326	252,0	79166	414,5	93183	1153,0	850,0	1850,0	1364,0	2178,0	1606,4
1 1/4	7	280,0	62934	449,0	101005	528,8	118888	1618,0	1194,0	2597,0	1916,0	3057,2	2254,9
1 3/8	6	333,0	74796	534,0	120043	628,5	141297	2121,0	1565,0	3405,0	2511,0	4007,4	2955,7
1 1/2	6	406,0	91358	652,0	146624	767,7	172585	2806,0	2070,0	4504,0	3322,0	5301,5	3910,2

Tabelle 12: Richtwerte für Schaftschrauben mit UNF-Gewinde, Reibungszahl $\mu_{ges} = 0,14$ und Ausnutzung der Mindest-Streckgrenze von 90 %

Abmessung		Vorspannkkräfte F_A für Festigkeitsklasse						Anziehmomente M_A für Festigkeitsklasse					
\varnothing	G	Grade 5*		Grade 8*		ASTM A 574*		Grade 5*		Grade 8*		ASTM A 574*	
		[kN]	[lbf]	[kN]	[lbf]	[kN]	[lbf]	[Nm]	[ft-lbs]	[Nm]	[ft-lbs]	[Nm]	[ft-lbs]
1/4	28	11,8	2653	16,7	3749	19,6	4413	13,8	10,2	19,5	14,4	22,9	16,9
5/16	24	18,9	4252	26,7	6008	31,5	7071	28,3	20,9	40,0	29,5	47,0	34,7
3/8	24	28,9	6486	40,8	9165	47,9	10788	50,0	36,9	70,7	52,2	83,2	61,4
7/16	20	39,0	8758	55,0	12375	64,8	14566	78,6	57,9	111,0	81,9	130,7	96,4
1/2	20	52,8	11861	74,6	16760	87,8	19727	122,0	89,7	172,0	127,0	202,2	149,1
5/8	18	84,7	19050	120,0	26918	140,9	31684	239,0	176,0	377,0	249,0	396,6	292,5
3/4	16	124,0	27814	175,0	39302	250,8	46261	423,0	312,0	597,0	441,0	703,0	518,5
7/8	14	170,5	38321	240,8	54150	283,5	63737	677,3	499,6	957,1	705,9	1126,6	830,9
1	12	221,5	49803	313,0	70373	368,5	82833	1008,6	743,9	1425,2	1051,1	1677,5	1237,2
1 1/4	12	360,7	81088	509,68	114581	599,9	134868	2030,6	1497,7	2869,4	2116,4	3377,4	2491,1
1 1/2	12	533,28	119886	753,5	169404	886,9	199398	3568,9	2632,3	5043,0	3719,6	5935,9	4378,1

*Grade 5 (~ 8.8) und Grade 8 (~ 10.9) nach SAE J 429, ASTM A 574 für Zylinderschrauben (~ 12.9)



Anziehmomente und Vorspannkraft für Schraubverbindungen aus Stahl mit Sicherungselementen

Tabelle 13: Richtwerte für Vorspannkraft F_V und Anziehmomente M_A für Ripp-Schrauben und -Muttern
(Artikel 88913 und 88914)

Gegenwerkstoff	Festigkeitsklasse 100/10													
	M 5		M 6		M 8		M 10		M 12		M 14x1,5		M 16	
	F_V [N]	M_A [Nm]	F_V [N]	M_A [Nm]	F_V [N]	M_A [Nm]	F_V [N]	M_A [Nm]	F_V [N]	M_A [Nm]	F_V [N]	M_A [Nm]	F_V [N]	M_A [Nm]
Stahl $R_m < 800$ MPa		11		19		42		85		130		250		330
Stahl $R_m \geq 800$ MPa	9000	10	12600	18	23200	37	37000	80	54000	120	74000	240	102000	310
Grauguss		9		16		35		75		115		230		300

Tabelle 14: Richtwerte für Vorspannkraft F_V und Anziehmomente M_A für Zylinder-Flanschschrauben mit Sperr-Rippen
(Artikel 88912)

Gegenwerkstoff	Festigkeitsklasse 100/10									
	M 5		M 6		M 8		M 10		M 12	
	F_V [N]	M_A [Nm]	F_V [N]	M_A [Nm]	F_V [N]	M_A [Nm]	F_V [N]	M_A [Nm]	F_V [N]	M_A [Nm]
Stahl $R_m < 800$ MPa		13		24		45		90		150
Stahl $R_m \geq 800$ MPa	9000	11	12600	20	23200	42	37000	85	54000	140
Grauguss		10		19		39		80		120

Tabelle 15: Richtwerte für Anziehmomente für Sperrzahn-Schrauben und -Muttern
(Artikel 88933 und 88934)

Gegenwerkstoff	Festigkeitsklasse 90/8						Festigkeitsklasse 100/10					
	M 5		M 6		M 8		M 10		M 12		M 16	
	F_V [N]	M_A [Nm]	F_V [N]	M_A [Nm]	F_V [N]	M_A [Nm]	F_V [N]	M_A [Nm]	F_V [N]	M_A [Nm]	F_V [N]	M_A [Nm]
Stahl	6350	9	9000	16	16500	34	26200	58	54000	120	102000	280
Grauguss		7		13		28		49		105		260

Tabelle 16: Richtwerte für Anziehmomente und Vorspannkraft von Schraubverbindungen mit Keilsicherungsscheiben
(Artikel 88132, 88032)

NL-Scheiben für Gewinde	Vorspannkraft F_V (kN) für Festigkeitsklasse					Anziehmomente M_A (Nm) für Festigkeitsklasse				
	8.8 ¹⁾	10.9 ²⁾	12.9 ³⁾	A 4 -70 ⁴⁾	A 4 -80 ⁴⁾	8.8 ¹⁾	10.9 ²⁾	12.9 ³⁾	A 4 -70 ⁴⁾	A 4 -80 ⁴⁾
M 4	3,5	5,9	7,1	2,6	3,4	3,1	4,1	4,6	2,0	2,7
M 5	5,6	9,6	11,5	4,1	5,5	6,0	8,1	9,1	3,9	5,3
M 6	8,0	13,6	16,3	5,9	7,8	10,2	14,1	15,8	6,9	9,2
M 8	15,0	25,0	30,0	11,0	14,0	25,0	34,0	38,0	17,0	22,0
M 10	23,0	39,0	47,0	17,0	23,0	50,0	67,0	75,0	33,0	43,0
M 12	33,0	57,0	68,0	25,0	33,0	85,0	115,0	128,0	56,0	75,0
M 14	46,0	78,0	94,0	34,0	45,0	136,0	183,0	204,0	89,0	119,0
M 16	62,0	106,0	127,0	46,0	61,0	208,0	279,0	311,0	136,0	181,0
M 18	76,0	130,0	156,0	56,0	75,0	291,0	391,0	437,0	191,0	254,0
M 20	97,0	165,0	198,0	72,0	95,0	408,0	547,0	610,0	267,0	356,0
M 22	120,0	205,0	246,0	89,0	118,0	557,0	745,0	831,0	364,0	485,0
M 24	140,0	238,0	286,0	103,0	137,0	703,0	942,0	1052,0	460,0	613,0
M 27	182,0	310,0	372,0	134,0	179,0	1028,0	1375,0	1533,0	671,0	895,0
M 30	222,0	378,0	454,0	164,0	219,0	1401,0	1875,0	2091,0	915,0	1220,0
M 33	275,0	468,0	562,0	-	-	1889,0	2526,0	2815,0	-	-
M 36	324,0	551,0	662,0	239,0	319,0	2436,0	3259,0	3633,0	1591,0	2121,0
M 39	387,0	659,0	790,0	-	-	3145,0	4203,0	4683,0	-	-
M 42	445,0	757,0	908,0	-	-	3890,0	5202,0	5799,0	-	-

Quelle: www.nordlock.com

- 1) Schraube galvanisch verzinkt, trocken, Gewindereibung $\mu_G = 0,15$, Reibwert der Sicherungsscheibe $\mu_W = 0,18$, Ausnutzung der Mindeststreckgrenze = 62 %
- 2) Schraube unbeschichtet, geölt, Gewindereibung $\mu_G = 0,13$, Reibwert der Sicherungsscheibe $\mu_W = 0,14$, Ausnutzung der Mindeststreckgrenze = 71 %
- 3) Schraube unbeschichtet, geölt, Gewindereibung $\mu_G = 0,13$, Reibwert der Sicherungsscheibe $\mu_W = 0,12$, Ausnutzung der Mindeststreckgrenze = 71 %
- 4) Schraube mit Graphit-Paste geschmiert, Gewindereibung $\mu_G = 0,14$, Reibwert der Sicherungsscheibe $\mu_W = 0,15$, Ausnutzung der Mindeststreckgrenze = 65 %

Tabelle 17: Richtwerte für Anziehmomente von Schraubverbindungen mit Sperrkantscheiben

Artikel	Festigkeitsklasse Schrauben	Anziehmoment M_A in Nm													
		M 4	M 5	M 6	M 8	M 10	M 12	M 14	M 16	M 18	M 20	M 22	M 24	M 27	M 30
88123 Form S	5.8	2,0	4,0	7,0	16,5	32	57	-	-	-	-	-	-	-	
88124 Form M	8.8	3,3	6,7	11,5	27	54	92	145	225	320	460	620	790	1160	1550
	10.9	4,9	9,8	16,5	40	79	135	215	330	460	650	890	1120	1650	2250
88125 Form B	10.9	-	-	16,5	40	79	135	-	-	-	-	-	-	-	
	12.9	-	-	19,5	47	92	158	-	-	-	-	-	-	-	

Quelle: www.teckentrup.de

Richtwerte für Anziehmomente von Schraubverbindungen mit SCHNORR-Scheiben

Artikel 88120 und Artikel 88121:

Als Richtwert kann auf das übliche Anziehmoment M_A nach **TI-244**, Tabellen 5 und 6 10 % aufgeschlagen werden.



Montage von Schraubverbindungen im Stahlbau

Planmäßig vorgespannte Verbindungen mit HV-Garnituren

Für die Montage von HV-Garnituren in Deutschland sind folgende zwei Montageverfahren zur Erreichung der Vorspannkraft zugelassen.

Norm	Vorspannkraft	Montageverfahren	k-Klasse
EN 1090-2	$F_{p,c}$ (volle Vorspannkraft)	Kombinierte Verfahren	K1
DIN EN 1993-1-8 NA DAST-Richtlinie 024	$F_{p,c}^*$ (modifizierte Vorspannkraft)	Modifiziertes Drehmomentverfahren	K1

In der nachfolgenden Tabelle sind Vorspannkraft und Anziehmomente für die jeweiligen Verfahren für die k-Klasse K1 und die Festigkeitsklasse 10.9 aufgeführt. Die entsprechend erforderlichen Montageschritte sind der EN 1090-2 zu entnehmen.

Tabelle 18: Vorspannkraft und Anziehmomente für HV-Schraubverbindungen der Festigkeitsklasse 10.9 nach EN 14399-4 bzw. DAST-Richtlinie 021 mit k-Klasse K1

Ø	Kombiniertes Anziehverfahren auf $F_{p,c}$				Modifizierte Verfahren auf $F_{p,c}^*$		
	Referenzvorspannkraft $F_{p,c}$ in kN	Referenzdrehmoment $M_{r,1}$ in Nm	EN 1090-2	DAST-Richtlinie 024	Mod. Drehmoment-Vorspannverfahren nach DIN EN 1993-1-8 NA und DAST-Richtlinie 024		Mod. kombiniertes Verfahren nach DIN EN 1993-1-8 NA
			Voranziehmoment $0,75 M_{r,1}$ in Nm	Voranziehmoment M_{vor} in Nm	Modifizierte Vorspannkraft $F_{p,c}^*$ in kN	Modifiziertes Drehmoment M_A in Nm	Voranziehmoment $M_{A,MKV}$ in Nm
M 12	59	92	69	75	50	100	75
M 16	110	229	172	190	100	250	190
M 20	172	447	335	340	160	450	340
M 22	212	606	455	490	190	650	490
M 24	247	771	578	600	220	800	600
M 27	321	1127	845	940	290	1250	940
M 30	393	1533	1150	1240	350	1650	1240
M 36	572	2677	2008	2100	510	2800	2100
M 39*					610	3500	
M 42*					710	4500	
M 45*					820	5500	
M 48*					930	6500	
M 56*					1280	10000	
M 64*					1680	15000	

* nach DAST-Richtlinie 021, diese Werte gelten nur für feuerverzinkte HV-Garnituren

Tabelle 19: Weiterdrehwinkel für kombiniertes Montageverfahren

Norm	Weiterdrehwinkel in °		
	t = Klemmlänge mit Scheiben, d = Schraubendurchmesser		
	t < 2d	2d ≤ t < 6d	6d ≤ t ≤ 10d
EN 1090-2 / DAST-Richtlinie 024	60	90	120
DIN EN 1993-1-8/NA	45	60	90

Sicherung der HV-Verbindung gegen Lockern

Mittels Keilsicherungsscheiben kann eine HV-Schraubverbindung gegen Lockern gesichert werden. In den Tabellen 20 und 21 sind zwei Produkte und deren Montagekennwerte angegeben.

Tabelle 20: Vorspannkraft und Anziehmomente für HV-Schraubverbindungen mit NL SC Keilsicherungsscheiben (Art. 88132) nach ETA-13-0246

Ø	Modifizierte Vorspannkraft $F_{p,c,NL}^*$ in kN	Modifiziertes Drehmoment $M_{A,NL}$ in Nm	Voranziehmoment für modifiziertes kombiniertes Verfahren $M_{A,MKV,NL}$ in Nm
M 12	45	130	100
M 16	90	330	250
M 20	145	660	490
M 22	170	850	640
M 24	200	1100	825
M 27	260	1600	1220
M 30	315	2150	1650
M 36	460	3750	2800

Tabelle 21: Vorspannkraft und Anziehmomente für HV-Schraubverbindungen mit HLK Keilsicherungsscheiben (Art. 88032) nach abZ Z-14.4-702

Ø	Modifizierte Vorspannkraft $F_{p,c,HLK}^*$ in kN	Modifiziertes Drehmoment $M_{A,HLK}$ in Nm	Voranziehmoment ¹⁾ für modifiziertes kombiniertes Verfahren $M_{A,MKV,HLK}$ in Nm
M 12	45	150	100
M 16	80	330	210
M 20	120	560	365
M 22	145	730	475
M 24	165	880	575
M 27	200	1160	755
M 30	252	1580	1030
M 36	367	2530	1650

1) Weiterdrehwinkel für modifiziertes kombiniertes Verfahren nach DIN EN 1993-1-8/NA (siehe Tabelle 19)

Nicht planmäßig vorgespannte Schraubenverbindungen – SB Garnituren

Für den Bereich der nicht planmäßig vorgespannten Schraubenverbindungen werden SB Garnituren verwendet wie z. B. ISO 4014/4017/4032/7090 aber auch für DIN 7990 sowie zukünftig noch weitere, die entgegen des Systems HV nur mindestens handfest angezogen werden. Schrauben und Mütter müssen zusätzlich mit „SB“ für „structural bolting“ gekennzeichnet sein.

Tabelle 22: Empfohlene „Handfest“-Anziehdrehmomente für nicht planmäßig vorgespannte Verbindungen unabhängig von der Festigkeitsklasse der Schrauben nach der DAST-Richtlinie 024

Ø	M 12	M 16	M 20	M 22	M 24	M 27	M 30	M 36
$M_{A, handfest}$ in Nm	15	35	60	90	110	165	220	350



Anziehmomente und Vorspannkraft für Verbindungselemente aus nichtrostenden Stählen

Anziehmomente und Vorspannkraft für Schrauben mit voller Belastbarkeit aus nicht rostenden Stählen

Bei Verbindungselementen aus nicht rostenden Stählen sind die Reibungswerte im Gewinde und an den Auflageflächen wesentlich größer als bei vergüteten Stahlschrauben – auch der Streubereich der Reibungswerte ist hier viel größer (bis über 100 %!). Zur endgültigen Bestimmung des richtigen Drehmomentes ist ein Versuch unter Einsatzbedingungen angeraten. Durch Verwendung von Schmiermitteln können zwar die Reibungszahlen verringert werden – aber der sehr große Streubereich bleibt erhalten.

Die Tabelle enthält unverbindliche Richtwerte für verschiedene Reibungszahlen, gültig für Schrauben und Muttern nach DIN 912, 931, 933 und 934/ISO 4762, 4014, 4017, 4032 aus nicht rostenden Stählen A 1 – A 5, in den Festigkeitsklassen –50, –70 und –80 bei Raumtemperatur (ca. + 20 °C) und einer Dehngrenzen-Ausnutzung von $R_p 0,2 = 90\%$.

Tabelle 23: unverbindliche Richtwerte für Schrauben A 2/A 4

Ø	Fkl.	Montagevorspannkraft in kN für $\mu_{ges} =$								Anziehmomente in Nm für $\mu_{ges} =$							
		0,10	0,12	0,14	0,16	0,18	0,20	0,30	0,40	0,10	0,12	0,14	0,16	0,18	0,20	0,30	0,40
M 4	50	1,47	1,48	1,39	1,35	1,31	1,26	1,07	0,91	0,8	0,9	1,0	1,1	1,2	1,3	1,6	1,8
	70	3,14	2,71	2,97	2,89	2,80	2,71	2,30	1,95	1,8	2,0	2,2	2,4	2,6	2,8	3,4	3,8
	80	4,19	4,08	3,96	3,85	3,73	3,61	3,06	2,61	2,4	2,7	3,0	3,3	3,5	3,7	4,6	5,1
M 5	50	2,39	2,33	2,27	2,20	2,14	2,07	1,76	1,50	1,7	1,9	2,1	2,3	2,4	2,6	3,2	3,6
	70	5,13	5,00	4,86	4,72	4,58	4,44	3,77	3,21	3,5	4,0	4,5	4,9	5,2	5,6	6,8	7,6
	80	6,84	6,66	6,48	6,29	6,10	5,91	5,02	4,28	4,7	5,4	5,9	6,5	7,0	7,4	9,1	10,2
M 6	50	3,39	3,30	3,21	3,11	3,02	2,93	2,48	2,11	2,9	3,3	3,6	3,9	4,2	4,5	5,5	6,2
	70	7,26	7,07	6,87	6,67	6,47	6,27	5,32	4,53	6,2	7,0	7,7	8,4	9,1	9,7	11,9	13,2
	80	9,68	9,43	9,13	8,90	8,63	8,36	7,09	6,04	8,2	9,3	10,3	11,3	12,1	12,9	15,8	17,7
M 8	50	6,21	6,05	5,88	5,72	5,54	5,37	4,57	3,89	7,0	7,9	8,8	9,6	10,3	11,0	13,6	15,2
	70	13,30	12,96	12,61	12,25	11,88	11,51	9,79	8,34	15,0	17,0	18,8	20,6	22,2	23,6	29,1	32,5
	80	17,74	17,29	16,81	16,33	15,84	15,35	13,05	11,11	19,9	22,6	25,1	27,4	29,5	31,5	38,8	43,4
M 10	50	9,87	9,62	9,37	9,10	8,83	8,56	7,28	6,20	13,8	15,7	17,4	19,0	20,5	21,8	27,0	30,2
	70	21,16	20,63	18,40	19,50	18,92	18,34	15,60	13,29	29,5	33,5	37,3	40,7	41,9	46,8	57,8	67,7
	80	28,21	27,50	26,76	25,99	25,22	24,45	20,79	17,72	39,4	44,7	49,7	54,3	58,5	62,4	77,1	86,2
M 12	50	14,38	14,03	13,65	13,27	12,87	12,48	10,62	9,05	23,8	27,1	30,1	32,9	35,4	37,8	46,8	52,3
	70	30,83	30,06	29,26	28,43	28,59	26,75	22,76	19,40	51,0	58,0	64,5	70,5	76,0	81,0	100,2	112,1
	80	41,10	40,08	39,01	37,90	36,78	35,66	30,35	25,87	68,0	77,3	85,9	93,9	101,0	108,0	133,6	149,5
M 14	50	19,74	19,25	18,74	18,21	17,68	17,14	14,59	12,44	37,8	43,0	47,9	52,4	56,5	60,2	74,6	83,5
	70	42,31	41,26	40,16	39,03	37,88	36,73	31,27	26,65	81,1	92,2	103,0	112,0	121,0	129,0	160,0	179,0
	80	56,41	55,01	53,54	52,04	50,50	48,97	41,69	35,54	108,0	123,0	137,0	150,0	161,0	172,0	212,0	238,5
M 16	50	27,04	26,39	25,71	25,01	24,29	23,56	20,10	17,16	58,2	66,5	74,2	81,4	87,9	94,0	117,0	131,0
	70	57,94	56,55	55,09	53,58	52,04	50,49	43,08	36,77	125,0	143,0	159,0	174,0	188,0	201,0	251,0	282,0
	80	77,25	74,40	73,46	71,44	69,39	67,33	57,44	49,03	166,0	190,0	212,0	233,0	251,0	269,0	334,0	375,0
M 18	50	33,01	32,20	31,35	30,47	29,58	28,68	24,43	20,83	81,3	92,6	103,0	113,0	122,0	130,0	161,0	180,0
	70	70,73	69,00	67,17	65,29	63,38	61,46	52,34	44,64	174,0	198,0	221,0	242,0	261,0	278,0	345,0	387,0
	80	94,31	92,00	89,56	87,05	84,51	81,95	69,79	59,52	232,0	265,0	295,0	322,0	348,0	371,0	460,0	515,0
M 20	50	42,27	41,26	40,20	39,10	37,79	36,84	31,34	26,83	114,0	130,0	146,0	160,0	173,0	184,0	230,0	258,0
	70	90,58	88,40	86,14	83,78	81,37	78,95	67,35	57,49	245,0	280,0	312,0	342,0	370,0	395,0	492,0	552,0
	80	120,80	117,90	114,90	111,70	108,50	105,30	89,80	76,70	326,0	373,0	416,0	456,0	493,0	527,0	656,0	736,0
M 22	50	52,67	51,45	50,15	48,80	47,42	46,02	39,32	33,59	156,0	178,0	200,0	219,0	237,0	254,0	318,0	257,0
	70	112,87	110,24	107,46	104,56	101,61	98,61	84,25	–	334,0	382,0	428,0	470,0	508,0	544,0	680,0	–
	80	150,88	147,43	144,56	141,61	138,66	135,71	115,39	99,04	416,0	474,0	528,0	586,0	640,0	694,0	880,0	–
M 24	50	60,88	59,43	57,90	56,30	54,69	53,01	45,27	38,64	197,0	225,0	251,0	275,0	297,0	318,0	396,0	444,0
	70	130,50	127,40	124,10	120,70	117,20	113,70	97,00	–w	421,0	482,0	537,0	589,0	637,0	680,0	848,0	–
	80	180,80	176,70	172,60	168,50	164,40	160,30	136,60	118,90	505,0	576,0	637,0	698,0	754,0	800,0	1024,0	–
M 27	50	79,86	78,02	76,05	74,01	71,93	69,82	59,67	50,98	289,0	332,0	371,0	408,0	442,0	473,0	591,0	666,0
	70	171,00	167,00	163,00	159,00	154,00	150,00	128,00	–	620,0	711,0	795,0	873,0	946,0	1013,0	1267,0	–
	80	240,80	235,80	230,80	225,80	220,80	215,80	184,80	160,80	844,0	966,0	1080,0	1186,0	1283,0	1373,0	1715,0	–
M 30	50	97,23	94,96	92,54	90,04	87,48	84,90	72,50	61,90	394,0	451,0	504,0	553,0	599,0	640,0	800,0	900,0
	70	208,00	203,00	198,00	193,00	187,00	182,00	155,00	–	844,0	966,0	1080,0	1186,0	1283,0	1373,0	1715,0	–
	80	288,00	282,00	276,00	270,00	264,00	258,00	222,00	194,00	1124,0	1276,0	1428,0	1570,0	1694,0	1818,0	2302,0	–
M 33	50	121,00	118,00	115,00	112,00	109,00	106,00	90,00	77,00	531,0	610,0	683,0	751,0	813,0	871,0	1092,0	1230,0
	70	270,00	265,00	260,00	255,00	250,00	245,00	208,00	184,00	1184,0	1364,0	1544,0	1724,0	1894,0	2064,0	2680,0	–
	80	370,00	364,00	358,00	352,00	346,00	340,00	292,00	258,00	1664,0	1904,0	2144,0	2384,0	2624,0	2864,0	3700,0	–
M 36	50	142,00	139,00	135,00	132,00	128,00	124,00	106,00	91,00	684,0	784,0	876,0	964,0	1044,0	1117,0	1398,0	1573,0
	70	320,00	314,00	308,00	302,00	296,00	290,00	244,00	214,00	1424,0	1634,0	1844,0	2054,0	2264,0	2474,0	3160,0	–
	80	440,00	434,00	428,00	422,00	416,00	410,00	344,00	304,00	1984,0	2274,0	2564,0	2854,0	3144,0	3434,0	4400,0	–
M 39	50	170,00	166,00	162,00	158,00	154,00	149,00	128,00	109,00	883,0	1014,0	1137,0	1250,0	1355,0	1452,0	1822,0	2054,0
	70	380,00	374,00	368,00	362,00	356,00	350,00	292,00	258,00	1984,0	2274,0	2564,0	2854,0	3144,0	3434,0	4400,0	–
	80	520,00	514,00	508,00	502,00	496,00	490,00	404,00	354,00	2784,0	3174,0	3564,0	3954,0	4344,0	4734,0	6000,0	–

Anziehmomente und Vorspannkraft

für Schrauben mit reduzierter Belastbarkeit aus nicht rostenden Stählen.

Schrauben nach DIN 6912, 7984, ISO 7380-1/-2 und 10642 sind wegen ihrer Kopfgeometrie nicht voll belastbar. Als Richtwerte für Anziehmomente und Vorspannkraft können jeweils 80 % der Werte der oberen Tabelle 22 angenommen werden. (→ siehe auch TI-246)

Sechskantmutter mit Klemmteil

aus nicht rostenden Stählen neigen manchmal wegen des hohen Gewindeflankendruckes beim Einführen des Bolzens in das Klemmteil zum Festfressen. Hier hilft in der Regel die Behandlung des Bolzens mit einem reibungsmindernden Mittel.



Geschmierte Muttern

im Sortiment in den Werkstoffen A 2 und A 4.

Ein Schmiermittel dient zur optimalen Montage von austenitischen Verbindungselementen.



Anziehmomente für Verbindungselemente aus BUMAX 88/109, Messing und Polyamid

Anziehmomente und Vorspannkkräfte für Schrauben aus nichtrostenden Stahl BUMAX 88/109

Verbindungselementen aus BUMAX 88/109 haben durch eine gezielte Schmierung einen eingestellten Reibwert. Damit können im Gegensatz zu üblicherweise ungeschmierten Verbindungselementen aus rostfreiem Stahl (A 2/A 4) gezielte Vorspannkkräfte aufgebracht werden.

Tabelle 24: Richtwerte für Schrauben aus BUMAX 88/109

Abmessung P	Spannungsquerschnitt A_s (mm ²)	Vorspannkkräfte F_V (kN) für BUMAX		Anziehmomente M_A (Nm) für BUMAX	
		88	109	88	109
M 3 0,5	5,03	2,1	2,9	1,3	1,7
M 4 0,7	8,78	3,6	5,2	2,9	4,1
M 5 0,8	14,2	5,9	8,6	5,7	8,1
M 6 1,0	20,1	8,4	12,0	9,8	14,0
M 8 1,25	34,4	15,0	21,0	25,0	34,0
M 10 1,5	58,0	24,0	34,0	47,0	66,0
M 12 1,75	84,3	35,0	49,0	82,0	115,0
M 14 2,0	115,0	48,0	60,0	129,0	161,0
M 16 2,0	157,0	65,0	81,0	198,0	248,0
M 18 2,5	192,0	80,0	100,0	275,0	344,0
M 20 2,5	245,0	102,0	128,0	385,0	481,0
M 24 3,0	353,0	181,0	-	665,0	-
M 27 3,0	459,0	235,0	-	961,0	-
M 30 3,5	561,0	287,0	-	1310,0	-
M 36 4,0	817,0	418,0	-	2280,0	-

Anziehmomente für Verbindungselemente aus Messing

Bei Verbindungselementen aus Messing sind die Reibungswerte im Gewinde und an den Auflageflächen wesentlich größer als bei vergüteten Stahlschrauben. Zur endgültigen Bestimmung des richtigen Drehmomentes ist ein Versuch unter Einsatzbedingungen angeraten. Durch Verwendung von Schmiermitteln können die Reibungszahlen verringert werden.

Die folgende Tabelle enthält unverbindliche Richtwerte für verschiedene Reibungszahlen, gültig für Schrauben und Muttern nach DIN 912, 931, 933 und 934/ISO 4762, 4014, 4017, 4032 aus Messing mit einer minimalen 0,2 %-Dehngrenze von 250 N/mm² (z. B. MS 58 und MS 63) und einer Dehngrenzen-Ausnutzung von $R_p 0,2 = 90\%$.

Die in der Tabelle genannten Anziehmomente können nur **als sehr grobe und unverbindliche Richtwerte** verstanden werden.

Tabelle 25: Richtwerte für Schrauben aus Messing

Ø	Montagevorspannkraft in kN für μ_{ges}								Anziehmomente in Nm für μ_{ges}							
	0,10	0,12	0,14	0,16	0,18	0,20	0,30	0,40	0,10	0,12	0,14	0,16	0,18	0,20	0,30	0,40
M 4	1,75	1,70	1,65	1,60	1,55	1,51	1,28	1,09	1,0	1,1	1,2	1,4	1,5	1,6	1,9	2,1
M 5	2,85	2,78	2,70	2,62	2,54	2,46	2,09	1,78	2,0	2,2	2,5	2,7	2,9	3,1	3,8	4,2
M 6	4,03	3,93	3,82	3,71	3,59	3,48	2,96	2,52	3,4	3,9	4,3	4,7	5,0	5,4	6,6	7,4
M 8	7,39	7,20	7,01	6,84	6,60	6,40	5,44	4,63	8,3	9,4	10,5	11,4	12,3	13,1	16,2	18,1
M 10	11,75	11,46	11,15	10,83	10,51	10,19	8,66	7,38	16,4	18,6	20,7	22,6	24,4	26,0	32,1	35,9
M 12	17,13	16,70	16,25	15,79	15,33	14,86	12,64	10,78	28,3	32,2	35,8	39,1	42,2	45,0	55,7	62,3
M 14	23,50	22,92	22,31	21,68	21,04	20,40	17,37	14,81	45,0	51,2	57,0	62,3	67,2	71,7	88,8	99,4
M 16	32,19	31,42	30,61	29,77	28,91	28,05	23,93	20,43	69,3	79,2	88,4	96,9	105,0	112,0	139,0	156,0
M 18	39,30	38,33	37,32	36,27	35,21	34,15	29,08	24,80	96,8	110,0	123,0	134,0	145,0	155,0	192,0	215,0
M 20	50,32	49,12	47,86	46,54	45,21	43,86	37,42	31,94	136,0	155,0	173,0	190,0	205,0	219,0	273,0	307,0
M 22	62,71	61,25	59,70	58,09	56,45	54,79	46,81	40,00	185,0	212,0	238,0	261,0	282,0	302,0	378,0	425,0
M 24	72,48	70,75	68,93	67,04	65,11	63,17	53,89	46,00	234,0	268,0	299,0	327,0	354,0	378,0	471,0	529,0
M 27	95,07	92,88	90,54	88,11	85,63	83,12	71,03	60,70	344,0	395,0	442,0	485,0	526,0	563,0	704,0	793,0
M 30	116,00	113,00	110,00	107,00	104,00	101,00	86,31	73,70	469,0	537,0	600,0	659,0	713,0	762,0	953,0	1071,0
M 33	144,00	141,00	137,00	133,00	130,00	126,00	108,00	92,00	632,0	726,0	813,0	894,0	968,0	1036,0	1300,0	1464,0
M 36	169,00	165,00	161,00	157,00	152,00	148,00	126,00	108,00	814,0	934,0	1045,0	1148,0	1243,0	1330,0	1664,0	1873,0
M 39	203,00	198,00	193,00	188,00	183,00	178,00	152,00	130,00	1051,0	1207,0	1353,0	1488,0	1613,0	1728,0	2169,0	2445,0

Anziehmomente für Schrauben und Muttern aus Polyamid

Die Tabelle 19 enthält unverbindliche Richtwerte für zweckmäßige Anziehmomente für Schrauben und Muttern aus Polyamid 6.6 bei 20 °C nach Lagerung in Normalklima.

Die Vorspannkraft kann bedingt durch Relaxationsvorgänge nachlassen.

Tabelle 26

Ø	M 3	M 4	M 5	M 6	M 8	M 10	M 12	M 16
Anziehmomente in Nm	0,1	0,25	0,5	0,8	1,8	3,5	6,0	12



Montagehinweise allgemein

Verschraubung dünnerer Bleche mit aufgedornten oder durchgezogenen Kernlöchern

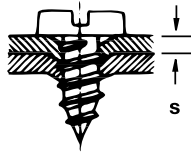

Blechdicke untere/obere Grenze*
 $s_{\min./\max.} (a_{\max.} = s_{\min.})$

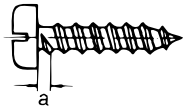

Verschraubung dickerer Bleche mit gebohrten oder gestanzten Kernlöchern

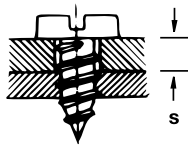

Verschraubbare Blechdicken

Ø/ST	2,2	2,9	3,5	3,9	4,2
$s_{\min} = a_{\max}$	0,8	1,1	1,3	1,3	1,4
s_{\max}	1,8	2,2	2,8	3	3,5

Ø/ST	4,8	5,5	6,3	8
$s_{\min} = a_{\max}$	1,6	1,8	1,8	2,1
s_{\max}	4	4,5	5	6,5

s = Blechdicke

a = Abstand Kopf zu Gewinde

* Bei sehr dünnen Blechen (< a max.) wird die Verwendung von speziellen Dünoblechschrauben oder Klemm-Muttern (Federmuttern) empfohlen.

Kernlochdurchmesser für Blechschrauben

Die Kernlochdurchmesser in nebenstehender Tabelle sind unverbindliche Richtwerte für runde Löcher.

Die Werte können je nach Material bzw. Montagebedingungen abweichen – dies gilt besonders bei Schrauben aus nicht härtbaren nichtrostenden Stählen der austenitischen Werkstoffgruppen A 2/A 4 (→ ISO 3506-4).

Bei Verschraubungen in Kunststoffen gelten besondere Bedingungen.

Tabelle 27: Kernlochdurchmesser für Blechschrauben

Nenn Durchmesser d_1	Kernloch-Ø (Tol. H 12) für Blechschrauben aus Material							
	Blechdicke* s		Stahl gehärtet (min 450 HV)				Nichtrostende Stähle A 2/A 4 (ca. 250 HV)**	
			Loch aufgedornt/durchgezogen Blech aus Material		Loch gebohrt/gestanzt Blech aus Material		Blech aus Material	
	>	≤	St, Ni, MS, Cu, Monel	Al	St, Ni, MS, Cu, Monel	Al	Baustahl St. 37	Al
2,2 mm	-	0,56	-	-	1,60	-	-	-
	0,56	0,75	-	-	1,70	1,60	-	-
	0,75	0,88	-	-	1,80	1,60	-	-
	0,88	1,13	-	-	1,85	1,60	-	-
	1,13	1,38	-	-	1,85	1,70	-	-
	1,38	1,50	-	-	1,90	1,80	-	-
2,9 mm	-	0,56	2,20	-	2,20	-	-	-
	0,56	0,63	2,50	2,20	2,25	-	2,30	2,40
	0,63	0,75	2,50	2,20	2,25	2,20	2,30	2,40
	0,75	0,88	2,50	2,20	2,40	2,20	2,30	2,40
	0,88	1,25	-	2,20	2,40	2,20	2,30	2,40
	1,25	1,38	-	-	2,40	2,20	2,30	2,40
	1,38	1,75	-	-	2,50	2,25	2,30	2,40
	1,75	2,50	-	-	2,60	2,40	2,40	2,50
	-	0,56	2,80	-	2,60	-	2,70	2,80
	0,56	0,75	2,80	2,80	2,70	-	2,70	2,80
3,5 mm	0,75	0,88	2,80	2,80	2,70	2,65	2,70	2,80
	0,88	1,25	-	2,80	2,80	2,65	2,70	2,80
	1,25	1,38	-	-	2,80	2,65	2,70	2,80
	1,38	1,75	-	-	2,90	2,75	2,80	2,90
	1,75	2,50	-	-	3,00	2,85	2,80	2,90
	2,50	3,00	-	-	3,20	3,00	2,90	3,00
	3,00	6,00	-	-	-	3,00	2,90	3,00
	-	0,50	3,00	-	2,95	-	3,00	3,10
	0,50	0,63	3,00	3,00	2,95	-	3,00	3,10
	0,63	0,88	3,00	3,00	2,95	2,90	3,00	3,10
3,9 mm	0,88	1,13	3,00	3,00	2,95	2,95	3,00	3,10
	1,13	1,25	3,00	3,00	3,00	2,95	3,00	3,10
	1,25	1,38	-	-	3,00	2,95	3,00	3,10
	1,38	1,75	-	-	3,20	3,00	3,00	3,10
	1,75	2,00	-	-	3,20	3,50	3,00	3,10
	2,00	2,50	-	-	3,50	3,50	3,10	3,20
	2,50	3,50	-	-	3,60	3,50	3,20	3,30
	-	0,50	3,50	-	-	-	-	-
	0,50	0,63	3,50	3,50	3,20	-	-	-
	0,63	0,88	3,50	3,50	3,20	2,95	-	-
4,2 mm	0,88	1,13	3,50	3,50	3,20	3,00	3,20	3,30
	1,13	1,38	3,50	3,50	3,30	3,20	3,20	3,30
	1,38	2,50	-	-	3,50	3,50	3,30	3,40
	2,50	3,00	-	-	3,80	3,70	3,30	3,40
	3,00	3,50	-	-	3,90	3,80	3,40	3,50
	3,50	10,00	-	-	-	3,90	3,5-3,6	3,6-3,7
	-	0,50	4,00	-	-	-	-	-
	0,50	0,75	4,00	4,00	3,70	-	-	-
	0,75	1,13	4,00	4,00	3,70	3,70	-	-
	4,8 mm	1,13	1,38	4,00	4,00	3,90	3,70	3,70
1,38		1,75	-	-	3,90	3,70	3,70	3,90
1,75		2,50	-	-	4,00	3,80	3,80	3,90
2,50		3,00	-	-	4,10	3,80	3,80	3,90
3,00		3,50	-	-	4,30	3,90	3,90	4,00
3,50		4,00	-	-	4,40	3,90	3,90	4,00
4,00		4,75	-	-	4,40	4,00	4,00	4,10
4,75		10,00	-	-	-	4,20	4,1-4,2	4,2-4,3
-		1,13	4,70	-	4,20	-	-	-
1,13		1,38	4,70	-	4,30	4,10	-	-
5,5 mm	1,38	1,50	-	-	4,30	4,10	-	-
	1,50	1,75	-	-	4,50	4,20	-	-
	1,75	2,25	-	-	4,60	4,40	4,50	4,60
	2,25	3,00	-	-	4,70	4,60	4,50	4,60
	3,00	3,50	-	-	5,00	4,60	4,60	4,70
	3,50	4,00	-	-	5,00	4,80	4,60	4,70
	4,00	4,75	-	-	5,10	4,80	4,70	4,80
	4,75	10,00	-	-	-	4,90	4,7-4,9	4,8-5,0
-	1,38	5,30	-	4,90	-	-	-	
6,3 mm	1,38	1,75	-	-	5,00	5,00	-	-
	1,75	2,00	-	-	5,20	5,00	-	-
	2,00	3,00	-	-	5,30	5,20	5,30	5,40
	3,00	4,00	-	-	5,80	5,30	5,40	5,50
	4,00	4,75	-	-	5,90	5,40	5,50	5,60
	4,75	5,00	-	-	-	5,60	5,50	5,60
	5,00	10,00	-	-	-	5,80	5,6-5,7	5,7-5,8



Für „Mechanische Verbindungselemente“ (Schrauben, Muttern und Zubehörteile) sind sämtliche funktionsrelevanten äußeren und inneren Merkmale in DIN-, ISO- oder EN-Normen detailliert geregelt – und zwar in:

- **Produkt-Normen** (z.B. DIN 931/ISO 4014)
Angaben über Figur des Produktes, zugeordnete Ausführung und Produktklasse (Toleranzgruppe), übliche Festigkeitsklassen und/oder Werkstoffe und Nennmaße. Außerdem enthält jede Produktnorm „normative Verweise“ auf mitgeltende Grund-/Funktions-Normen.
- **Grund-/Funktions-Normen** (z.B. DIN 13, 267/ISO 898, 4759, 3269...)
Regelungen für gemeinsame Merkmale der verschiedenen Produkte wie z.B. Gewinde, Toleranzen, Oberflächenausführungen, Korrosionsschutz, mechanische Eigenschaften und entsprechende Werksprüfprogramme – und auch Annahme-Prüfbedingungen.

Durch Benennung eines Artikels mit einer Produktnorm-Nummer sind alle verwiesenen Grundnormen als „Technische Lieferbedingungen“ automatisch mitgeltend einbezogen – dies gilt auch für nicht genormte Gewinde- und Formteile – wenn keine besonderen Vereinbarungen zwischen Besteller und Lieferant getroffen wurden.

Normen können immer nur einen allgemeinen Standard für Produkte „für allgemeine Verwendung“ regeln – das gilt auch für „Mechanische Verbindungselemente“ (→ ISO 3269/8992). Für über diese normativen Regelungen hinausgehende höhere Anforderungen für spezielle Einsatzfälle ist es Aufgabe des Verwenders, die Vorgaben zu definieren und nötige zusätzliche Prüfanforderungen zu bestimmen.

1. Qualitätskontrollen in der Fertigung:

In Grund-/Funktions-Normen sind Prüfprogramme und -Verfahren vorgegeben, nach denen der Hersteller durch ständige Stichprobenkontrollen die Einhaltung normgerechter Qualität seiner Erzeugnisse sicherzustellen hat. Neben den obligatorischen Kontrollen auf Maßhaltigkeit und Oberflächenzustand werden u.a. folgende Kontrollen aufgeführt:

- für Schrauben und ähnliche Gewindeteile (→ z. B. ISO 898-1)
 - Härteprüfung, Prüfkraftversuch
 - Kopfschlag-/Schrägzugversuch
 - Randentkohlungsprüfung
- für Muttern (→ z. B. ISO 898-2)
 - Härteprüfung, Prüfkraftversuch
 - Aufweitversuch

Welches Prüfverfahren im Schiedsfall gilt ist in den Normen vorgegeben. Alle genormten mechanischen Eigenschaften gelten im Allgemeinen bei Raumtemperatur (ca. +20 °C).

2. Zusätzliche Prüfungen – Prüfbescheinigungen

Für besondere Anforderungen und/oder sicherheitsrelevante Einsatzfälle können zusätzliche artikel- oder einsatzspezifische Prüfungen – werksseitig oder durch beauftragte werksunabhängige Sachverständige oder Prüfinstitute – durchgeführt werden. Die Ergebnisse dieser Extraprüfungen werden in einer Prüfbescheinigung dokumentiert.

Art und Umfang dieser zusätzlichen Prüfungen und wer diese durchführen und dokumentieren soll, hat der Verwender aufgrund seiner Kenntnisse über Einsatz und besondere Anforderungen (wie z.B. durch Werknormen) zu bestimmen und entsprechend bei Bestellung vorzugeben. Die Kosten für zusätzliche Prüfungen sind üblicherweise nicht im Produktpreis enthalten.

2.1. Prüfbescheinigungen nach ISO 16228

Für Mechanische Verbindungselemente ist im Mai 2018 die ISO 16228 erschienen und ersetzt DIN 11204. Diese Norm legt die verschiedenen Arten von Prüfbescheinigungen für mechanische Verbindungselemente fest, in der es auch die 4 Bescheinigungsarten nach ISO 10204 gibt, allerdings mit vorangestelltem F (für Fastener), also F2.1, F2.2, F3.1, F3.2. Desweiteren wird der Inhalt der Prüfbescheinigung für mechanische Verbindungselemente festgelegt und kann auf fertig hergestellte mechanische Verbindungselemente angewendet werden, wie Bolzen, Schrauben, Gewindebolzen, Muttern, Unterlegscheiben, Stifte, Nieten und so weiter, welche aus Stahl, nichtrostendem Stahl, Nichteisenmetallen oder nichtmetallischen Werkstoffen hergestellt sind. In den Prüfbescheinigungen (F2.2, F3.1, F3.2) werden die Prüfergebnisse aus den Zeugnissen der Vormateriallieferanten übernommen und/oder die Referenzprüfungen an den fertigen Verbindungselementen aufgenommen. Dies kann bei dem F3.1 durch den eigentlichen Hersteller oder durch den Vertreter geschehen. Die ISO 16228 ist somit eine sinnvolle Zusammenfassung der EN 10204 und DIN 11204 und eine Erleichterung für die Handhabung von Prüfbescheinigungen für Verbindungselemente.

2.2. Prüfinhalte – nach ISO 16228 (ehemals DIN 11204)

Werden keine Angaben über den Umfang der Prüfinhalte in der Bestellung vereinbart, so gilt ISO 16228.

Tabelle 1 – Prüfinhalte für mechanische Verbindungselemente (Auszug aus ISO 16228)

Schrauben	Art der Kontrolle		Muttern	Art der Kontrolle	
	Werkstoffeigenschaften/ mechanische und physische Eigenschaften	funktionelle Eigenschaften		Werkstoffeigenschaften/ mechanische und physische Eigenschaften	funktionelle Eigenschaften
Schrauben ISO 898-1	Chemische Zusammensetzung außer für F2.2 (M) Zugfestigkeit ^{a)} (M) Härte für vergütete Festigkeitsklasse (M) Chemische Zusammensetzung außer für F2.2 (M)	Gewinde- abnahme (A)	Muttern ISO 898-2	Chemische Zusammensetzung außer für F2.2 (M) Prüflast (A) Härte für vergütete Festigkeitsklasse (M) Chemische Zusammensetzung außer für F2.2 (M)	Gewinde- abnahme (A)
Schrauben ISO 3506-1	Zugfestigkeit und Bruchdehnung (M) Härte für mechanische Verbindungselemente aus martensitischem und ferritischem nichtrostendem Stahl (M)	Gewinde- abnahme (A)	Muttern ISO 3506-2	Prüflast (A) Härte für mechanische Verbindungselemente aus martensitischem und ferritischem nichtrostendem Stahl (M)	Gewinde- abnahme (A)

(M) = Messung, (A) = durch Attributprüfung

a) Wenn möglich, muss die Zugfestigkeit an mechanischen Verbindungselementen durch Prüfung an ganzen Schrauben nach dem Prüfprogramm FF nach ISO 898-1 geprüft werden. Wenn keine der in ISO 898-1 spezifizierten Zugprüfungen durchführbar ist, muss die Ersatzprüfung, die durchgeführt werden muss, zum Zeitpunkt der Bestellung vereinbart werden.

Grundsätzliche Hinweise:

- Die durch zusätzliche Prüfungen ermittelten und in Prüfbescheinigungen dokumentierten Werte sind keine „zugesicherten Eigenschaften“ bzw. „Beschaffheitsgarantien“ im Sinne des § 267 BGB und entlasten den Verwender nicht von sachgerechter Wareneingangsprüfung (§ 377 HGB).
- Alle in 1. und 2. benannten Prüfungen werden allgemein an Stichproben durchgeführt. Deren Ergebnisse sind zwar weitgehend repräsentativ für das Lieferlos einer Charge – aber eine 100%ige Garantie für jedes Teil des Loses kann hieraus ebenso wenig abgeleitet werden wie die Tauglichkeit für einen bestimmten Zweck.



Tabelle 2: Übersicht der Prüfbescheinigungen für Schrauben, Muttern und Zubehörteile nach ISO 16228
Auszug aus ISO 16228 – 05.2018

Art und Bezeichnung der Prüfbescheinigung für mechanische Verbindungselemente		Wann	Inhalt	Bestätigung
F2.1 ①	Konformitätserklärung für Mechanische Verbindungselemente	mit Bestellung angefordert	Konformitätserklärung für die ausgelieferten mechanischen Verbindungselemente, ohne Ergebnisse	Bevollmächtigter Vertreter des Herstellers oder des Vertreibers
F2.2 ②	Prüfbericht für Mechanische Verbindungselemente	mit Bestellung angefordert	Konformitätserklärung für die ausgelieferten mechanischen Verbindungselemente, mit Ergebnissen basierend auf nicht spezifischer Prüfung	Bevollmächtigter Vertreter des Herstellers
F3.1	Prüfbericht für Mechanische Verbindungselemente	mit Bestellung angefordert	Konformitätserklärung für die ausgelieferten mechanischen Verbindungselemente, mit Ergebnissen aus spezifischer Prüfung	Bevollmächtigter Vertreter des Herstellers oder des Vertreibers
F3.2 ③	Prüfbericht für Mechanische Verbindungselemente	mit Bestellung angefordert	Konformitätserklärung für die ausgelieferten mechanischen Verbindungselemente, mit Ergebnissen aus spezifischer Prüfung	Bevollmächtigter Vertreter des Herstellers oder des Vertreibers und entweder ein bevollmächtigter Vertreter des Käufers oder ein externer bevollmächtigter Vertreter

① nicht empfehlenswert, da keinerlei spezifische Aussage zum gelieferten Produkt.

② die für zerstörende Prüfungen erforderliche Probenmenge ist bei der Bestellmenge zu berücksichtigen

③ z.B. TÜV, GL, DB ...

3. Annahmeprüfung für „Mechanische Verbindungselemente“ nach ISO 3269

Diese Norm ist stets mitgeltend einbezogen, wenn „Mechanische Verbindungselemente“ nach Norm oder ähnliche Formteile bestellt werden, wenn nicht vorher ausdrücklich anderes vereinbart wurde.

Sie gilt nicht für Verbindungselemente, die

- für automatische Verschraubung vorgesehen sind,
- besonders hohe Anforderungen erfüllen sollen,
- spezielle Fertigungsverfahren/Prüfmaßnahmen erfordern
- eine besondere Rückverfolgbarkeit bedingen

Hierfür sind stets entsprechende besondere Vereinbarungen bei Anfrage – spätestens bei Bestellung – zu treffen (z. B. nach ISO 16426). Handelsübliche Lagerware ist allgemein für diese speziellen Anforderungen nicht geeignet.

Der finale Entwurf der ISO 3269 – FprISO 3269:2019 – legt nun konkrete Stichprobenumfänge, Annahmezahlen und Rückweisezahlen für bestimmte Prüfkategorien fest. Die Prüfkategorien sind wiederum konkreten Merkmalen zugeordnet. Die Tabellen 3 und 4 ist ein Auszug aus diesem Entwurf, der die wichtigsten Informationen enthält.

Tabelle 3: Stichprobenumfang, Annahmezahl N_A und Rückweizezahl N_R nach FprISO 3269:2019

Losgröße	Kategorie 1 $N_A=0$ $N_R=1$	Kategorie 2		Kategorie 3
		Anfangs-Stichprobe $N_A=0$ $N_R=2$	Zusätzliche Stichprobe $N_A=0$ $N_R=1$	
2 bis 50	1	4	4	nicht zutreffend
51 bis 90	1	5	5	5 $N_A=1$ $N_R=2$
91 bis 150	1	6	6	6 $N_A=1$ $N_R=2$
151 bis 280	1	7	7	7 $N_A=1$ $N_R=2$
281 bis 500	2	9	9	9 $N_A=1$ $N_R=2$
501 bis 1 200	2	11	11	11 $N_A=1$ $N_R=2$
1 201 bis 3 200	2	13	13	13 $N_A=1$ $N_R=2$
3 201 bis 35 000	3	15	15	15 $N_A=2$ $N_R=3$
35 001 bis 500 000	5	20	20	20 $N_A=2$ $N_R=3$
über 500 000	8	20	20	20 $N_A=2$ $N_R=3$

Tabelle 4: Prüfkategorien nach FprISO 3269:2019

Prüfkategorie	Beschreibung
Kategorie 1	Merkmale, für die die Annahmezahl N_A gleich null ist. Merkmale der Kategorie 1 schließen alle mechanischen und funktionellen Eigenschaften ein, die üblicherweise mittels zerstörender Prüfungen geprüft werden. Wenn in der Stichprobe Abweichungen festgestellt werden, wird das Los oder die Lieferung zurückgewiesen.
Kategorie 2	Merkmale, für die die Annahmezahl N_A gleich null ist, wobei jedoch im Fall von Abweichungen eine zweite Stichprobe entnommen werden darf. Merkmale der Kategorie 2 sind wichtige maßliche Merkmale, die die Passung oder Funktion des Verbindungselementes beeinträchtigen können. Wenn jedoch eine einzige Abweichung in der ersten Stichprobe festgestellt wird, muss hinsichtlich des betreffenden Merkmals zusätzlich eine weitere Stichprobe geprüft werden, die dem Stichprobenumfang der ersten Probe entspricht. Wird bei der zusätzlichen Stichprobe in Bezug auf das betreffende Merkmal keine Abweichung festgestellt, wird das Los angenommen.
Kategorie 3	Merkmale, für die die Annahmezahl N_A einer oder mehreren Abweichungen entspricht, wie jeweils angegeben. Merkmale der Kategorie 3 sind unwesentliche maßliche Merkmale und bestimmte funktionelle Eigenschaften, bei denen Abweichungen in einem gewissen Maß toleriert werden. Werden bei der Stichprobe mehr Abweichungen als die angegebenen annehmbaren Abweichungen festgestellt, wird das Los oder die Lieferung zurückgewiesen.



Prüfverfahren: Härtemessung und Kerbschlagprüfung



Die Härtemessung dient der Ermittlung des Widerstandes eines Werkstoffes gegen das Eindringen eines Prüfkörpers, der mit bestimmter Form, Kraft und Zeit auf ihn einwirkt. Je nach angewandtem Verfahren wird aus der gemessenen Tiefe oder Größe des bleibenden Eindrucks, den der Prüfkörper in dem Werkstück hinterlässt, der Härtewert ermittelt.

Die gängigsten genormten Verfahren zeigt Tabelle 1 – in Zweifelsfällen gilt bei mechanischen Verbindungselementen die Härteprüfung nach Vickers. Die Messungen erfolgen an vorbereiteten Proben – hier sind zu unterscheiden:

„Routine-Prüfung“

Die Messung erfolgt auf einem ebenen Schliff an der Oberfläche der Probe. Gängige Härteprüfverfahren sind Rockwell (HRC) und Vickers (HV 10 – HV 30).

„Schieds-Prüfung“

Die Messung erfolgt auf einer Längs- oder Querschliff-Fläche der zerteilten Probe. Das in ISO 898 festgelegte Prüfverfahren ist Vickers (HV).

Bei der Annahmeprüfung von „Mechanischen Verbindungselementen“ gelten Härtemessungen nur der Routine- und Vergleichskontrolle – sie sind allein nicht entscheidend für die Beurteilung der mechanischen Eigenschaften!

Für Schrauben gilt der Zugversuch zur Ermittlung der Zugfestigkeit, Streckgrenze und Dehnung – für Muttern gelten Prüfkraft- und Aufweitversuch. (ISO 898-1, DIN 267-21, ISO 898-2).

Tabelle 2 zeigt eine Umwertung der Härten nach Vickers, Rockwell und Brinell zueinander und zur Zugfestigkeit von unlegierten bis niedriglegierten Stählen in warmumgeformtem oder wärmebehandeltem Zustand. Daneben sind die Härtebereiche von Schrauben, Muttern und Scheiben der verschiedenen Festigkeitsklassen nach Norm angegeben.

Kleinlasthärteprüfung

Die Kleinlasthärteprüfung mit Prüfkraften zwischen 2 und 30 N (HV 0,2 bis HV 3) ist das Bindeglied zwischen der konventionellen Härteprüfung (HV 5 bis HV 100) und Mikrohartprüfung. Sie ist geeignet für die Härtebestimmung in Randschichten und zur Aufnahme von Härteverlaufskurven. Bei Verbindungselementen, speziell vergüteten Schrauben ab der Festigkeitsklasse 8.8, wird die Kleinlasthärteprüfung nach ISO 898-1 zur Ermittlung des Kohlunzustandes im Gewindebereich verwendet.

Kerbschlagarbeit

Als Maß für die Zähigkeit wird die Kerbschlagarbeit herangezogen. Diese sagt aus, welche Arbeit verrichtet werden muss, um eine Probe zu zerschlagen. Zähle Stähle absorbieren viel Arbeit. Bei spröden Stählen ist die zu verrichtende Arbeit gering. Das Ergebnis der Kerbschlagarbeit wird insbesondere dazu verwendet, um die Verwendbarkeit von Stahl bei tiefen Temperaturen einzuschätzen.

Für die Prüfung werden aus den Schrauben quadratische Prüfkörper mit einer definierten Kerbe herausgearbeitet. Es wird die ISO-V- und die ISO-U-Probe unterschieden. In der Praxis hat sich die Anwendung der ISO-V-Probe bewährt, da diese durch die stärkere Kerbwirkung im Vergleich zu der ISO-U-Probe empfindlicher auf die Versprödung der Schraube reagiert.



ISO-V- und ISO-U-Probe

Tabelle 1: Vergleich der Härtemessverfahren







Verfahren, Bezeichnung	Vickers HV	Brinell HB	Rockwell	
			HRC	HRB
Norm, Standard	ISO 6507-1,2 (DIN 50133)	ISO 6506 (DIN 50351)	ISO 6508/EN 10004 (DIN 50103-1)	
Geeignet für Werkstoffe	Metallische Werkstoffe mit sehr geringer bis sehr hoher Härte (Bestimmung mittlerer Härte)	Metallische Werkstoffe mit sehr geringer bis hoher Härte (Bestimmung partieller Härte)	Gehärtete Stähle, gehärtete und angelassene Legierungen	Werkstoffe mittlerer Härte, Stähle mit niedrigem bis mittlerem C-Gehalt Messing, Bronze ...
Zugfestigkeitsbereich ca. (R_m in N/mm ²)	< 250 – 2000	255 – 1520	770 – 2000	250 – 800 250 – 800
Eindringkörper	 Diamantpyramide, quadratische Grundfläche, Flächenwinkel 136° 	 Kugel aus gehärtetem Stahl, Durchmesser: 10/15/2,5 oder 1 mm 	 Diamantkegel, Kegelwinkel 120° Spitze: Rundungshalbmesser 0,2 mm 	 Kugel aus gehärtetem Stahl Durchmesser: 1/16" = 1,5875 mm 
Einwirkdauer allgemein (für Schiedsprüfungen min.)	Werkstoffabhängig 10 – 30 (30) Sek.	Werkstoffabhängig 10 – 30 (30) Sek.	Werkstoffabhängig 2 – 25 (30) Sek. (zweistufiger Eindruck Prüfkraft F_0 + Prüfkraft F_1 = Prüfgesamtkraft F)	
Kurzzeichen (Beispiele)	640 HV 30 eingesetzte Prüfkraft $F = 294 \text{ N}/30 \text{ kp}$ Härte Vickers ermittelter Härtewert 180 HV 50/30 Einwirkdauer/sec.	350 HB Härte Brinell ermittelter Härtewert bei Kugel $\varnothing 10 \text{ mm}$ Prüfkraft 29420 N/3000 kp Einwirkdauer 10–15 Sek. 120 HB 5/250/30 Einwirkdauer/sec. Prüfkraft/kp Kugel- \varnothing	45 HRC Härte Rockwell Verfahren C ermittelter Härtewert	45 HRB Härte Rockwell Verfahren B ermittelter Härtewert

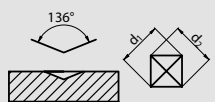

Tabelle 2: Härte-Umwertung*/-Vergleich
Härtebereiche von Schrauben, Muttern, Scheiben und Ringen

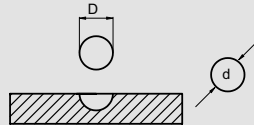
Vickers- härte	Brinell- härte	Rockwellhärte		~ Zug- festig- keit	Ungefähre Härtebereiche (Basis: Vickershärte) für														Scheiben/Ringe			
		HRB	HRC		MPa	Schrauben					Muttern m ≥ 0,5 d**					Muttern m < 0,5 d Gewindestifte				St.	St. hardened	FSt.
HV 10	HB				4.6	5.6	8.8	10.9	12.9	5	6	8 04	10 05	12	14 H	17 H	22 H	45 H				
80	76,0			255																		
85	80,7			270																		
90	85,5			285																		
95	90,2			305																		
100	95,0			320																		
105	99,8			335																		
110	105			350																		
115	109			370	120																	
120	114			385																		
125	119			400																		
130	124			415																		
135	128			430																		
140	133			450																		
145	138			465																		
150	143			480																		
155	147			495																		
160	152			510																		
165	156			530																		
170	162			545																		
175	166			560																		
180	171			575																		
185	176			595																		
190	181			610																		
195	185			625																		
200	190			640																		
205	195			660																		
210	199			675																		
215	204			690																		
220	209			705																		
225	214			720																		
230	219			740																		
235	223			755																		
240	228			770																		
245	233			785																		
250	238			800																		
255	242			820	250	250																
260	247	(101)		835																		
265	252			850																		
270	257	(102)		865																		
275	261			880																		
280	266	(104)		900																		
285	271			915																		
290	276	(105)		930																		
295	280			950																		
300	285			965																		
310	295			995																		
320	304			1030																		
330	314			1060																		
340	323			1095																		
350	333			1125																		
360	342			1155																		
370	352			1190																		
380	361			1220																		
390	371			1255																		
400	380			1290																		
410	390			1320																		
420	399			1350																		
430	409			1385																		
440	418			1420																		
450	428			1455																		
460	437			1485																		
470	447			1520																		
480	456			1555																		
490	466			1595																		
500	475			1630																		
520	494			1700																		
540	513			1775																		
560	532			1845																		
580	551			1920																		
600	570			1195																		
ISO 18265 Tabelle A.1					ISO 898-1					ISO 898-2					DIN 267-24 ISO 898-5				z.B. DIN 125-1	z.B. DIN 125-2	z.B. DIN 267-26	

* Einschränkungen nach ISO 18265 beachten!

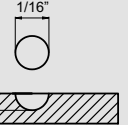
** Härtebereiche differieren nach Maßbereichen in Min.-/Max.-Werten



Eine Schraubenverbindung sollte so ausgelegt sein, dass die aufgebrachte Vorspannkraft unter Betriebsbeanspruchung weitestgehend erhalten bleibt. Zwar kann in einigen Fällen ein deutlicher Vorspannkraftverlust geduldet werden, allerdings gilt es, ein vollständiges Auseinanderfallen der Schraubenverbindungen zu verhindern.

Mechanismus des selbsttätigen Lösens

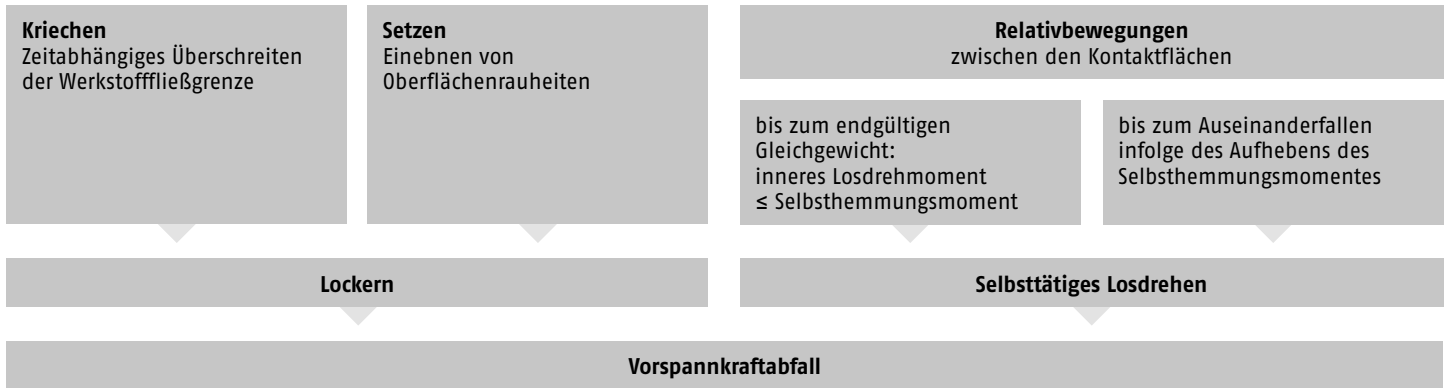

Maßnahmen

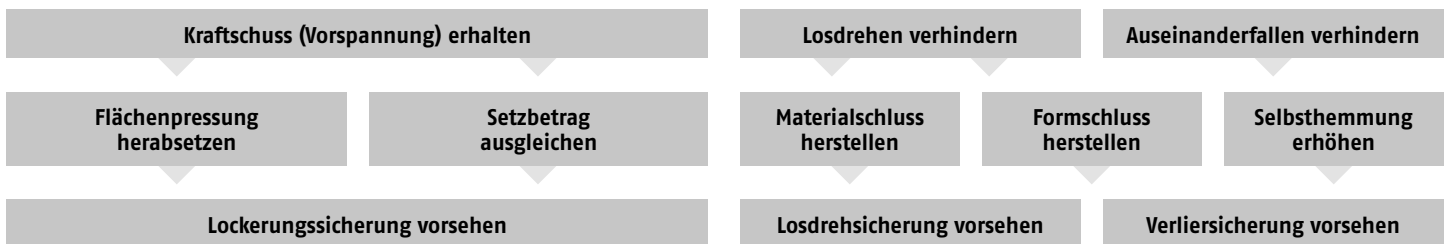

Quelle: DIN 25201-4

Lockern

Risiko

Statische Belastungen in axialer Richtung, hervorgerufen durch Montagekräfte und/oder erste Betriebslasten, können zu Setzerscheinungen führen. Dadurch kann es unter Umständen zum vollständigen Verlust der Vorspannkraft in der Schraubverbindung kommen.

Setzerscheinungen sind nicht nur von den anliegenden Kräften abhängig, sondern auch von der Anzahl der Trennfugen der verspannten Bauteile und der Oberflächenbeschaffenheit der Bauteile, wie z. B. Rauheit und Lackschichten. Auch eine geringe Bauteilefestigkeit kann zu Setzerscheinungen führen, was durch ein Fließen/Kriechen des weichen Materials hervorgerufen wird.

Maßnahmen

Der Einsatz von Setzsicherungen oder geeignete konstruktive Maßnahmen können dem Vorspannkraftverlust entgegenwirken. Um Setzverluste in einer Schraubverbindung so gering wie möglich zu halten, ist die Anzahl der Trennfugen zwischen den Bauteilen zu minimieren. Jede unnötige Unterlegscheibe bringt eine zusätzliche Trennfuge ein. Auch der Einsatz von „weichen“ Scheiben nach DIN 125 mit einer Härte von 140 HV in einer hochfesten Schraubverbindung mit Schrauben der Festigkeitsklasse ≥ 8.8 ist daher zu vermeiden.

Durch die Wahl einer größeren Klemmlänge der Schraube, z. B. durch den Einsatz von Dehnhülsen, können Vorspannungsverluste durch eine größere elastische Dehnung aufgefangen werden. Gleiche Effekte erzielen Dehnschaftschrauben und Schrauben mit Vollgewinde oder höhere Vorspannkraften durch Einsatz von Schrauben in einer höheren Festigkeitsklasse.

Sind diese Maßnahmen nicht anwendbar, können Setzbeträge mit einer Spannscheibe nach DIN 6796 in begrenztem Rahmen ausgeglichen werden. Hierbei ist zu beachten, dass das Bauteil unter der Spannscheibe eine entsprechend hohe Härte aufweist, nicht unter der Belastung fließt und die Spannscheibe sich nicht einarbeitet.

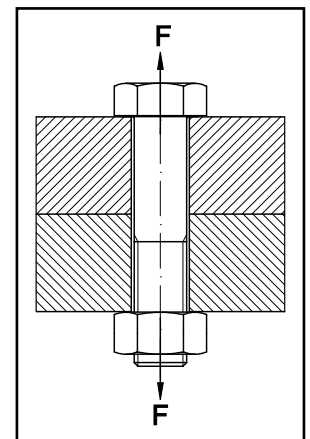

Selbsttätiges Losdrehen

Risiko

Sind dynamische Querbelastungen so groß, dass sich die verspannten Bauteile zueinander verschieben können, wird dadurch ein Losdrehmoment erzeugt, das die Selbsthemmung im Gewinde und in den Auflageflächen überwinden kann. In Abhängigkeit zur Frequenz des Belastungswechsels kommt es zur Lockerung und schließlich zum vollständigen Auseinanderfallen der Verbindung.

Maßnahmen

Je nach den baulichen Gegebenheiten kommen hier konstruktive Maßnahmen zum Einsatz oder sichernde Produkte. Die folgenden Maßnahmen können Anwendung finden (siehe auch DIN 252014).

- ▶ Erhöhung der Ausgangsspannung (Vorspannkraft)
- ▶ Erhöhung der Elastizität der Schraube
- ▶ Erhöhung der Reibung an den Auflageflächen von Schraube und Mutter und/oder im Gewinde
- ▶ Begrenzung eines eventuellen Querschlupfes (Verwendung von Passschrauben oder Stiften)
- ▶ Verwendung von sperrenden Verbindungselementen zur Verhinderung der Relativbewegung von Schraube bzw. Mutter
- ▶ Verkleben (Flüssigklebstoff oder mikroverkapselter Klebstoff)

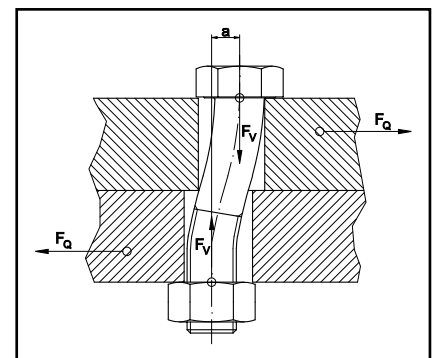



Verliersicherungen

Verliersicherungen verhindern keinen gravierenden Vorspannungsverlust, jedoch das vollständige Auseinanderfallen der Verbindung. In der Regel bleiben etwa 20 % der Vorspannkraft erhalten. Das Funktionsprinzip beruht auf der Klemmwirkung im Gewinde durch Reibschluss. Mutttern und Schrauben mit Klemmteil oder klemmender Beschichtung, gewindefurchende Schrauben, Rundumbeschichtungen, streifenförmige Beschichtungen oder Fleckbeschichtungen finden als Verliersicherung in der Praxis Anwendung.

Die Anforderungen an klemmende Beschichtungen bei Schrauben werden in DIN 26728 festgelegt. Die Funktionseigenschaften für Mutttern mit Klemmteil sind in ISO 2320 definiert.

Unter Verliersicherungen versteht man Mutttern und Schrauben mit Klemmteil oder klemmender Beschichtung sowie gewindefurchende Schrauben.

Losdrehsicherungen

Unter Losdrehsicherungen versteht man Elemente und Methoden, die verhindern, dass sich Schraubverbindungen trotz starker dynamischer Belastungen nicht selbst tätig lösen und die Vorspannkraft erhalten bleibt. In der Regel fällt die Vorspannkraft nicht unter 80 % der Montagevorspannkraft ab. Grundsätzlich eignen sich hierfür die folgenden Sicherungsmethoden:

- ▶ Formschlüssige Losdrehsicherungen
- ▶ Sicherung durch Erhöhung der Vorspannkraft
- ▶ Klebende Losdrehsicherungen

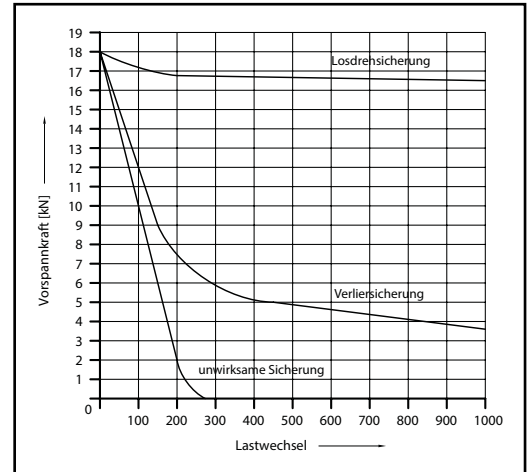

Formschlüssige Losdrehsicherungen

Bei formschlüssigen Losdrehsicherungen wird der Formschluss über Verriegelungszähne bzw. Sperrzähne oder rippen an den Auflageflächen von Schraubenkopf oder Mutter erreicht. Auch der Einsatz von Scheiben mit Sperrzähnen oder rippen ist möglich. Vor allem aber muss die Oberflächenhärte der Sperrzähne oder -rippen erheblich höher sein als die der zu verbindenden Bauteile, damit diese sich in die Oberfläche einarbeiten können. Zu berücksichtigen ist, dass Sperrzähne und -rippen die Reibwerte stark beeinflussen.

So ist bei weichen Gegenwerkstoffen wie Alulegierungen und Baustählen, in die sich die Verzahnung einarbeitet, mit wesentlich höheren Reibwerten ($\mu_{ges} = 0,2-0,3$) zu rechnen. Entsprechend sind die Anziehdrehmomente auszuliegen, um die gewünschten Vorspannkraft zu erreichen. Die optimalen Werte sind letztlich nur durch Anziehversuche unter realen Gegebenheiten zu ermitteln. Richtwerte für Anziehdrehmomente sind auf den TI-Seiten **TI-247** abgebildet.

Sicherung durch Erhöhung der Vorspannkraft

Bei dieser Sicherungsmethode prägen sich beim Anziehen die außen liegenden Radialrippen der Keilsicherungscheiben formschlüssig in die jeweilige Gegenauflage ein. Bei dynamischer Beanspruchung und dem damit verbundenen versuchten Losdrehen der Schraubverbindung ist nur noch eine Bewegung zwischen den innenliegenden Keilflächen möglich.

Durch den höheren Keilwinkel der Scheiben im Vergleich zum Steigungswinkel des Schraubengewindes erhöht sich die Vorspannkraft in der Verbindung, was in den beiden folgenden Abbildungen gut erkennbar ist.

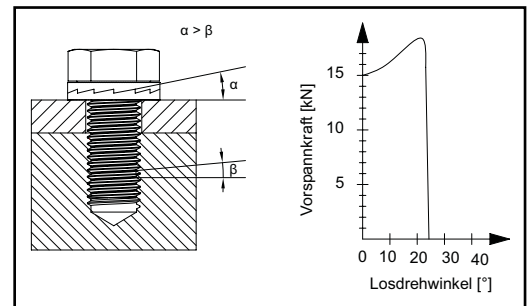

Klebende Losdrehsicherung

Bei einer klebenden Losdrehsicherung werden Mikrokapselformen mit einem Trägermaterial auf das Gewinde aufgebracht. Diese enthalten Kleber und Härter, die beim Verschrauben aufbrechen, sich vermischen und anschließend aushärten. In der Regel entsteht innerhalb von 24 Stunden eine gegen Vibrationen und Losdrehen gesicherte und gleichzeitig abdichtende Schraubverbindung. Der Klebstoff stellt einen Stoffschluss her, der ein Losdrehen ebenso verhindert wie die Sicherung durch Formschluss. DIN 267-27 beschreibt die klebende Sicherung mit einem mikroverkapselten Klebstoff. Mikroverkapselungen empfehlen sich bei großen Stückzahlen, da sie in einem speziellen Beschichtungsprozess auf das Gewinde aufgebracht werden. Beim Einsatz auf Zinklamellenüberzügen, Versiegelungen und/oder Beschichtungen mit Gleitmittelzusätzen kann es zur Reduzierung der Losbrechmomente gegenüber DIN 267-27 kommen. In diesem Fall ist die Anwendung durch Versuche unter Einsatzbedingungen vor der serienmäßigen Verwendung abzusichern. Die Lagerbeständigkeit von mikroverkapselten Beschichtungen ist gemäß DIN 267-27 auf mindestens 4 Jahre ab Fertigung festgelegt. Für kleine Stückzahlen und den universellen Einsatz eignen sich anaerob härtende Flüssigklebstoffe. Sie werden bei der Montage auf das Gewinde aufgetragen und härten durch den Abschluss von Luftsauerstoff und Metallkontakt (Eisen- und Kupferionen) aus. Klebende Beschichtungen sind in ihrer Temperaturbeständigkeit begrenzt. Angaben hierzu auf **TI-258**.

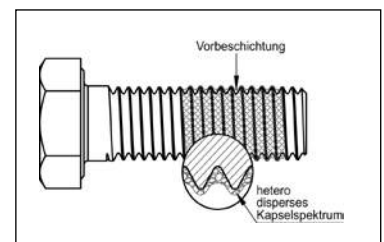

Montagehinweis für formschlüssige und vorspannkrafterhöhende Losdrehsicherungen

Die Sicherung muss unter dem Schraubenkopf und unter der Mutter erfolgen, um ein Losdrehen zu verhindern. Die Darstellungen zeigen, welche Ausführungen möglich sind.

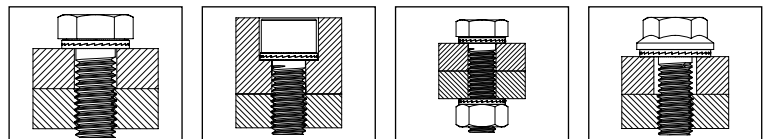

Einbaubeispiele

Hinweis zum Einsatz von austenitischen nichtrostenden Stählen

Austenitische Stähle der Stahlsorten A 1 bis A 5 haben keine federharten Eigenschaften. Deswegen können Sicherungselemente aus diesen Stahlsorten keine Setzbeträge durch eine Federwirkung ausgleichen. Eine Alternative stellen die Stähle 1.4310 und 1.4568 dar.

Diese haben gegenüber den Stahlsorten A 1 bis A 5 bedingt federharte Eigenschaften, die jedoch nicht die Anforderungen, die an Federstahl gestellt werden, erreichen. Deshalb können Sicherungselemente aus diesen beiden Stählen die federnden Eigenschaften von Produkten aus Stahl nur eingeschränkt erreichen.



Gegenüberstellung von klemmenden und klebenden Schraubsicherungen

Kleben

Produkt/Bezeichnung	Farbe	Temperaturbeständigkeit, verspannt [°C]	Gewindereibzahl μ	Aushärtungszeit [h]	Eigenschaft
precote 30	gelb	-60 bis +150	0,10 - 0,15	6	mittelfest, dichtend
precote 80	rot/grün	-60 bis +170	> 0,25	6	hochfest, dichtend
precote 85	türkis	-60 bis +170	0,10 - 0,15	6	hochfest, dichtend
ScotchGrip 2353	blau	-30 bis +110	0,13 - 0,19	24	hochfest, dichtend
ScotchGrip 2510	orange	-30 bis +200	0,13 - 0,19	72	hochfest, dichtend

Alle Angaben sind Herstellerangaben. Für die Richtigkeit dieser Angaben übernehmen wir keine Haftung.

Klemmen und Dichten

Produkt/Bezeichnung	Farbe	Temperaturbeständigkeit, verspannt [°C]	Gewindereibzahl μ	Eigenschaft
PolyamidFleck (GESI)	blau, rot	-60 bis +120		Klemmen
PolyamidRundum (GESI)	blau, rot	-60 bis +120	0,12 - 0,14	Klemmen und Dichten
TUFLOKFleck (NYLOK)	blau/rot	-56 bis +121		Klemmen
TUFLOKRundum (NYLOK)	blau/rot	-56 bis +121		Klemmen und Dichten
LongLok Polycap Nylon	grün	-51 bis +121		Klemmen
LongLok Kelf	blau	-196 bis +199		Klemmen
LongLok Vespel	braun	-268 bis +260		Klemmen
HotLok	silber	-240 bis +649		Klemmen
Klemmtight	-	-60 bis +200		Klemmen
Alutight	-	-60 bis +500		Klemmen
Heattight	-	bis +1000		Klemmen
Thermotight	-	-240 bis +220		Klemmen
precote 2	blau	-60 bis +90	0,10 - 0,15	Klemmen
precote 6	weiß	-60 bis +110	0,25 - 0,30	Klemmen
precote 9	weiß/rotbraun	-60 bis +180	0,10 - 0,15	Klemmen
precote 10	grau/grün/blau	-60 bis +130	0,16 - 0,20	Klemmen und Dichten
precote 101	grün	-60 bis +150	0,18 - 0,23	Klemmen und Dichten
precote 192	rot/farblos	-60 bis +90	0,18 - 0,23	Klemmen
precote 197	gelb/farblos	-60 bis +150	0,10 - 0,15	Klemmen

Alle Angaben sind Herstellerangaben. Für die Richtigkeit dieser Angaben übernehmen wir keine Haftung.

Hilfe zur Auswahl der richtigen Schraubensicherung

Auslegungsziel	Sicherungselemente
Mehrfache Verwendbarkeit	Formschlüssige Sicherungselemente
Definierte/gleichbleibende Reibwerte	Keilsicherungsscheiben, klebende Sicherungen
Geringer Montageaufwand	Flanschschrauben und -muttern mit Sperrverzahnung/verrippung, klebende Sicherung
Nachjustierbarkeit der Verbindung	Formschlüssige Sicherungselemente
Montagebedingungen	Lässt es sich nicht vermeiden, dass die zu paarenden Gewinde öl- und fettfrei sind, so sind formschlüssige Sicherungen zu bevorzugen.
Temperatur	Klebende Schraubensicherungen können je nach Produkt maximal zwischen 110 und 200 °C belastet werden – siehe Übersicht auf Seite 13. Ansonsten empfehlen sich metallische Sicherungselemente, die einen Form oder Reibschluss erzeugen.



Tabelle 3: Übersicht Losdrehsicherungen

Artikel			Besonderheiten
88130 – 88131	Sperrkantringe		Beidseitig geprägte Oberfläche und Aufwölbung → dadurch werden auch kleine Setzbeiträge ausgeglichen.
88123 – 88126	Sperrkantscheiben		Durch Aufwölbung – den Spannscheiben ähnlich – werden auch Setzbeiträge im begrenzten Umfang mit ausgeglichen.
88120 – 88121	SCHNORR-Scheiben		Beidseitig verzahnte Oberfläche und Aufwölbung → dadurch werden auch kleine Setzbeiträge ausgeglichen.
88132 88032 88033 – Standard – mit größerer Auflagefläche – für HV-Verbindungen – Nord-Lock X-series	Keilsicherungs-Scheiben		Bestehend aus je einem Scheibenpaar, paarweise geklebt für einfache Montage. Die äußeren Flächen sind mit Rippen versehen, die sich in die Oberfläche der Bauteile einprägen. Die inneren Flächen sind keilförmig ausgebildet. Bei der Montage gleiten nur die inneren Flächen aufeinander → dadurch wird immer ein gleichbleibender Reibwert realisiert, der eine präzise Vorgabe von Anziehdrehmomenten ermöglicht. Die Keilsicherungsfederscheiben® der Nord-Lock X-Serie sind zusätzlich gewölbt, wodurch auch Setzbeiträge ausgeglichen werden.
88034	Keilsicherungsmuttern		Keilsicherungsscheibe direkt an einer Flanschmutter durch einen Kunststoffring befestigt. → dadurch vereinfachte Montage
88119	LOCKTIX-Scheiben		Beidseitig geprägte Oberfläche und große Auflagefläche.
88912 88913 88914	Rippschrauben Rippmuttern		Durch den angespressten Flansch mit den Rippen vereinfacht sich der Montageaufwand, da keine einzelnen Scheiben untergelegt werden müssen.
88933 88934	Sperrzahnschrauben Sperrzahnmuttern		Durch den angespressten Flansch mit den Sperrzähnen vereinfacht sich der Montageaufwand, da keine einzelnen Scheiben untergelegt werden müssen. Durch die spezielle Ausführung des Flansches werden noch in begrenztem Maße Setzbeiträge ausgeglichen.

EU-Richtlinie 2000/53/EG über Altfahrzeuge (ELV-Richtlinie) (End-of-Life-Vehicles)

Ziel dieser europäischen Richtlinie ist es, gesundheitsschädliche Gefahrstoffe in Fahrzeugen zu vermeiden bzw. auf ein Minimum zu reduzieren.

Betroffen sind alle PKW und Nutzfahrzeuge bis 3,5 t, die ab dem 01. Juli 2007 in Verkehr gebracht wurden.

Verboten sind seit diesem Termin

1. Blei
2. Cadmium
3. Chrom (VI)
4. Quecksilber

Für sechswertiges Chrom in Korrosionsschutzschichten für Schrauben und Muttern zur Befestigung von Teilen des Fahrgestelles galt eine Ausnahmegenehmigung bis 1. Juli 2008.

Diese EU-Richtlinie wurde durch die Altfahrzeugverordnung (Altfahrzeug V) in deutsches Recht übernommen.

Die Automobilindustrie hat die Anforderungen der EU-Richtlinie z. B. in Form des

1. VDA-Merkblattes 232-101 (Liste der deklarationspflichtigen Stoffe)
2. Internationales Material Daten System (IMDS)

umgesetzt.

Das IMDS ist ein Portal, welches alle umweltrelevanten Informationen in der Lieferkette zusammenfasst und diese an den Fahrzeughersteller meldet.

→ Diese Produkte aus dem Katalog entsprechen dieser Richtlinie

Alle Produkte aus Stahl, Edelstahl rostfrei und Nichteisen-Metalle in blank oder verzinkt mit blauer/transparenter Dickschicht-Passivierung, mit Zinklamellenüberzügen ohne Chromate (fZnnc) und Feuerverzinkung

EU-Richtlinie 2011/65/EU über Elektro- und Elektronikgeräte (RoHS-Richtlinie) (Restriction of Hazardous Substances)

Mit der EU-Richtlinie 2015/863/EU (RoHS III) wurde die Richtlinie 2011/65/EU zur Beschränkung der Verwendung bestimmter gefährlicher Stoffe in Elektro- und Elektronikgeräten aktualisiert.

Sie wird durch die Elektro- und Elektronikgeräte-Stoff-Verordnung (ElektroStoffV) in Deutschland umgesetzt. Danach dürfen Elektro- und Elektronikgeräte einschließlich Kabel und Ersatzteile nicht in Verkehr gebracht werden, die mehr als 0,1 Gewichtsprozent Blei, Quecksilber, sechswertiges Chrom, PBB, PBDE, DEHP, BBP, DBP, DIBP oder mehr als 0,01 Gewichtsprozent Cadmium je homogenen Werkstoff enthalten. Für bestimmte Stoffe und Verwendungen bestehen Ausnahmeregelungen.

So gelten für Blei als Legierungselement die Ausnahmen nach Anhang III:

- 6(a)-I (Stahl max. 0,35%, Stahl feuerverzinkt max. 0,2%)
- 6(b)-I (Aluminiumleg. max. 0,4%)
- 6(c)-I (Kupferleg. max. 4%)

→ Diese Produkte aus dem Katalog entsprechen dieser Richtlinie

Alle Produkte, die das RoHS-Symbol in den Preisseiten führen, enthalten zum aktuellen Zeitpunkt keinen gefährlichen Stoff über den oben genannte Grenzwerten bzw. Nutzen eine Ausnahme nach Anhang III. Sollten Produkte dieses Symbol nicht führen, so können die genannten Stoffe mit einem Anteil über dem entsprechenden Grenzwert enthalten sein. Konkrete Angaben hierzu sind auf Anfrage erhältlich.

ZEK 01.2-08 PAK (Polyzyklische aromatische Kohlenwasserstoffe)

Diese Richtlinie ersetzt die Richtlinie ZEK 01-08. Produkte (technische Arbeitsmittel und Verbraucherprodukte) müssen gesetzliche Anforderungen zur Vermeidung einer gesundheitlichen Gefährdung, wie z. B. § 30, 31 LFGB, die Chemikalienverbotsverordnung und § 4 Geräte- und Produktsicherheitsgesetz (GPSG) einhalten. Daher wurden in diesem Dokument die geänderten PAK-Prüfspezifikationen sowie die neuen PAK-Höchstwerte festgelegt. Materialien, die PAK enthalten können, sind beispielsweise Elastomere (Kunststoffe und Gummimaterialien), schwarze oder dunkelgefärbte Polymere, Beschichtungen und Lackierungen sowie Materialien, die mit Konservierungsmitteln (Naphthalin) behandelt wurden, wie beispielsweise Naturborsten, Lederprodukte, Bast oder Holz.

Die Hauptursachen für PAK-Kontaminationen in Materialien sind die Verwendung von:

- PAK-kontaminierten Weichmacherölen in Gummi und flexiblen Kunststoffen (Weichkunststoffen)
- PAK-kontaminiertem Ruß als Schwarzpigment in Gummi, Kunststoffen und Lacken

Daraus ist ersichtlich, dass die von uns gelieferten Erzeugnisse aus Stahl, Edelstahl und Nichteisenmetallen inklusiver aller Überzüge von dieser Regelung nicht betroffen sind.

→ Alle Produkte aus dem Katalog entsprechen dieser Richtlinie

California Proposition 65

(The Safe Drinking Water and Toxic Enforcement Act of 1986)

California Proposition 65 ist ein kalifornisches Gesetz zum Schutz von Trinkwasserquellen vor Kontamination mit Chemikalien, die bekanntermaßen krebserregend und/oder mutagen/reproduktionstoxisch sind. Das Gesetz verbietet keine Stoffe, sondern legt Expositions-Grenzwerte für bestimmte Stoffe fest. Es wird verlangt, dass Individuen vor der Exposition gegenüber gelisteter Stoffe "klare und angemessene" Warnhinweise erhalten. Eine Exposition kann durch den Verkauf/Kauf/Nutzung von Produkten, die Emission in die Umwelt oder arbeitsplatzbezogene Expositionen auftreten.

Die Liste der krebserregenden und/oder reproduktionstoxischen Stoffe wird vom Office of Environmental Health Hazard Assessment (OEHA) geführt, jedes Jahr aktualisiert und verfügt aktuell über 900 Stoffe.

SJ/T 11364-2014 (China RoHS 2)

(Administrative Measures for the Restriction of the Use of Hazardous Substances in Electrical and Electronic Products)

Die China RoHS 2 ist sehr nahe an die EU-RoHS angelehnt und kann am ehesten mit der EU-Richtlinie 2011/65/EU (RoHS 2) verglichen werden. Nach China RoHS 2 sind Elektro- und Elektronikgeräte betroffen, die mehr als 0,1% (Masseprozent w/w) Blei, Quecksilber, sechswertiges Chrom, PBB, PBDE oder mehr als 0,01% (Masseprozent w/w) Cadmium je homogenen Werkstoff enthalten. Entgegen der EU-RoHS gibt es nach der China RoHS 2 keine Ausnahmen, weshalb Produkte, die nach der EU-RoHS-konform sind, nicht gleichzeitig auch "China-RoHS"-konform sind. Elektrische und elektronische Produkte, die in China auf den Markt kommen, müssen mit einem Label versehen werden. Für Produkte, bei denen die entsprechenden Grenzwerte nicht überschritten werden, wird das "e"-Label verwendet. Produkte, die Schadstoffe über den entsprechenden Grenzwerten enthalten, verwenden ein orangefarbenes Label, welches die Dauer ab Herstellungsdatum bestimmt, während das Produkt ohne Gefahr für den Nutzer oder die Umwelt verwendet werden kann. Im Falle des orangefarbenen Labels muss ebenfalls der Gehalt der zu deklarierenden Schadstoffe auf der Bauteilebene bzw. bei Platzmangel im Benutzerhandbuch angegeben werden. Diese Angabe muss in Mandarin erfolgen.

Konfliktminerale

(Dodd-Frank-Act)

Mit dem 15. Titel des Dodd-Frank Acts soll der Einsatz von "Konfliktmineralien" verhindert werden, mit deren Hilfe sich Rebellen im Osten der Demokratischen Republik Kongo finanzieren. Zu den relevanten Rohstoffen gehören Zinn, Tantal, Wolfram und Gold aus der Region der Großen Seen in Ostafrika, zu der neben der Demokratischen Republik Kongo auch Angola, Burundi, Ruanda, Sudan, Tansania, Uganda und die Zentralafrikanische Republik Sambia gehören. Nach Section 1502 Dodd-Frank Act (Sec. 1502) müssen Unternehmen, die nach dem US-amerikanischen Gesetz über den Handel mit Wertpapieren berichtspflichtig sind, jährlich offenlegen, ob sogenannte „Konfliktminerale“, die für die Herstellung oder Funktion ihrer Produkte notwendig sind, aus der DR Kongo oder ihren Nachbarstaaten stammen. Somit sind alle Unternehmen davon betroffen, die sich entlang der Lieferkette von US-börsennotierten Unternehmen befinden, sei es als direkter Zulieferer oder als Zwischenlieferant. Die Materialdatenkommunikation in der Lieferkette erfolgt über ein CMRT Template, das wir auf Anfrage gerne zusenden.

EU-Richtlinie EU 2006/122/EG (PFOS)

(Perfluorooctansulfonate)

Die Richtlinie der EU 2006/122/EG bezieht sich auf den Einsatz von Perfluorooctansulfonaten (PFOS). Überwiegend werden PFOS in der Luft- und Raumfahrt, Halbleiter- und Elektroindustrie, sowie im fotografischen Gewerbe eingesetzt. Wenn die Emissionen in die Umwelt und die Exposition am Arbeitsplatz auf ein Mindestmaß reduziert werden kann, so ist keine ernsthafte Gefahr für die Umwelt und die menschliche Gesundheit zu erwarten. Besondere Aufmerksamkeit soll laut Richtlinie auf galvanische Prozesse, Oberflächenbehandlung von Metallen und Kunststoffen, gelegt werden. Es gibt Hinweise und Erfahrungen, dass hier gesetzgeberische Maßnahmen zu erwarten sind. Es wird erwartet, dass durch den Einsatz von besten verfügbaren Technologien die Emissionen entsprechend reduziert werden. Eine weitere Empfehlung lautet, PFOS enthaltende Halbfertigprodukte und Erzeugnisse zu beschränken, denen PFOS absichtlich beigefügt worden ist. Die Richtlinie soll nur für neue Produkte gelten und nicht für Erzeugnisse, die bereits auf dem Markt sind. Da die Perfluorooctansäure (PFOA) und deren Salze ein ähnliches Risiko darstellen, sind eventuelle Erweiterungen der Richtlinie auch auf diese Gruppe zu erwarten. Ein fertig galvanisiertes Produkt enthält keine messbaren Mengen an PFOS.

→ Alle Produkte aus dem Katalog entsprechen dieser Richtlinie

EG-Verordnung 1907/2006 – Chemikalienverordnung (REACH)
 (Registration, Evaluation, Authorisation of Chemicals)

Diese EG-Verordnung zentralisiert und vereinfacht durch die Registrierung, Bewertung und Zulassung von Chemikalien das Chemikalienrecht europaweit und ist am 01. Juni 2007 in Kraft getreten. Es ist erklärtes Ziel, den Wissensstand über die Gefahren und Risiken zu erhöhen, die von Chemikalien ausgehen können. Den Unternehmen wird dabei mehr Verantwortung für den sicheren Umgang mit ihren Produkten übertragen. Verbindungselemente werden von der REACH-Verordnung als sogenannte Erzeugnisse zwar grundsätzlich erfasst, überwiegend jedoch durch entsprechende Ausnahmeregelungen von der Registrierungspflicht freigestellt.

Gem. Art. 3 REACH VO handelt es sich bei Verbindungselementen um sogenannte Erzeugnisse. Erzeugnisse sind Gegenstände, deren Funktion nicht durch ihre Stoffwirkung (z. B. durch die Metallkomponenten in der Legierung), sondern durch ihre äußere Form bestimmt wird.

Erzeugnisse sind nach Art. 7 Abs. 1 REACH Verordnung aber nur dann registrierungspflichtig, wenn sie Chemikalien enthalten, die auch freigesetzt werden sollen. Dies ist bei Verbindungselementen aber nicht der Fall.

Selbst Verbindungselemente mit Korrosionsschutzüberzügen, die damit eine Opfer-Beschichtung besitzen, d. h. eine Beschichtung, die geopfert wird, um das Bauteil zu schützen, fallen nicht unter die Registrierungspflicht. Grund ist, dass nicht die Schutzschicht als solche freigesetzt wird, sondern lediglich bestimmte Reaktionsprodukte. Einschlägig ist insofern die Ausnahmeregelung des Art. 2 Abs. 7 (b) REACH VO iVm. Anhang V Abs. 3 REACH VO. Danach sind Stoffe, die durch eine chemische Reaktion bei der Endnutzung anderer Stoffe, Zubereitungen oder Erzeugnisse entstanden sind und nicht als solche hergestellt, eingeführt oder in Verkehr gebracht werden, von der Registrierungspflicht ausgenommen.

Davon unberührt bleiben jedoch die Regelungen über besonders besorgniserregende Stoffe (SVHC) (Art. 57, Art. 59, Anhang 14 REACH VO) in Erzeugnissen nach Artikel 7 Abs. 2 REACH VO. Diese Stoffe sind zwar nicht registrierungs- aber meldepflichtig, soweit

- a) der Stoff in diesen Erzeugnissen in einer Menge von insgesamt mehr als einer Tonne pro Jahr und Produzent oder Importeur enthalten ist und
- b) der Stoff in diesen Erzeugnissen in einer Konzentration von mehr als 0,1% (Masseprozent w/w) enthalten ist.

Obige Ausführungen gelten nicht für chemisch-technische Produkte (z. B. Aerosole, Kleb- und Dichtstoffe). Dabei handelt es sich nicht um Erzeugnisse, sondern um Zubereitungen. Bei Zubereitungen sind nicht die Zubereitungen selbst, sondern die Inhaltsstoffe registrierungspflichtig. Bei in der EU hergestellten Produkten trifft diese Registrierungspflicht den Hersteller, bei Importen aus nicht EU-Ländern den Importeur.

Neben der Registrierungs- und der Meldepflicht beschreibt die REACH-Verordnung auch eine Informationspflicht nach Artikel 33. Jeder Lieferant eines Erzeugnisses, welches mindestens einen nach Art. 59 gelisteten Stoff (SVHC) in einer Konzentration von mehr als 0,1% (Masseprozent w/w) enthält, muss in der Lieferkette darüber informieren. Hierbei muss mindestens der Name des Stoffes genannt werden. Diese Stoffliste nach Art. 59 wird halbjährlich überarbeitet und erweitert. In einem EuGH-Urteil von 10.09.2015 wird zum Begriff des Erzeugnisses festgelegt, "Einmal ein Erzeugnis – immer ein Erzeugnis". Dies schreibt vor, dass das einzelne Erzeugnis und nicht das zusammengesetzte Erzeugnis als Bezugsgröße zur Ermittlung der Informationspflicht verwendet wird. Sollte ein Produkt über 0,1% (Masseprozent w/w) eines SVHC-Kandidaten enthalten und damit der Informationspflicht unterliegen, hat das keinen Einfluss auf die Herstellung, den Vertrieb oder die Verarbeitung des Produktes.

Am 27 Juni 2018 wurde Blei (CAS-Nr. 7439-92-1, EG-Nr. 231-100-4) mit auf die SVHC-Kandidatenliste aufgenommen, wovon einige unserer Produkte betroffen sind. Blei kann als Legierungselement in Maschinenelementen > 0,1 Massenprozent in folgenden Festigkeitsklassen/Werkstoffen vorkommen:

- Festigkeitsklassen: 4.6, 4.8, 5.8, 6.8, 04, 4, 5, 6, 11H, 14H, 17H, 22H, 33H, 45H
- Automatenstahl
- Kupferlegierungen (z.B. Messing, Bronze)
- Aluminiumlegierungen

Die Einstufung von Blei als reproduktionstoxisch bedeutet nicht, dass eine unmittelbare Gefahr von bleihaltigen Werkstoffen ausgeht. Die potenziell toxischen Eigenschaften von Blei sind darüber hinaus seit Jahren bekannt und müssen in Abhängigkeit von der Verwendung entsprechend berücksichtigt werden.

→ Folgende Produkte aus dem Katalog enthalten keine SVHC

Alle Produkte, die das "REACH SVHC free"-Symbol in den Preiseiten führen, enthalten zum aktuellen Zeitpunkt keinen SVHC-Kandidaten über 0,1% (Masseprozent w/w). Sollten Produkte dieses Symbol nicht führen, so können SVHC-Kandidaten von über 0,1% (Masseprozent w/w) enthalten sein.

EU BauPVO 305/2011/EU
 (Bauproduktenverordnung)

Diese Verordnung ersetzt seit 01.07.2013 die Bauproduktenrichtlinie 89/106/EWG.

Diese Verordnung legt die Bedingungen für das Inverkehrbringen und die Bereitstellung von Bauprodukten sowie deren CE-Kennzeichnung fest.

→ Diese Produkte aus dem Katalog entsprechen dieser Richtlinie*

- Verbindungselemente für den Stahlbau: EN 14399-4, EN 14399-6, EN 14399-8, DIN 7968, DIN 7969, DIN 7989, DIN 7990, Garnituren aus ISO 4014/4017 nach EN 15048, .
- Verbindungselemente für den tragenden Holzbau:
 - o Spanplattenschrauben: Artikelnummer 89096 – 89098, SPAX-Sortiment
 - o Holzbauschrauben: Artikelnummer 89091, 89092
 - o Sechskantholzschrauben: Artikelnummer 89571
 - o Baubolzen mit Sechskantmutter: Artikelnummer 89601

EG-Richtlinie 2006/42/EG (Maschinenrichtlinie)

Die **Richtlinie** regelt ein einheitliches Schutzniveau zur Unfallverhütung für Maschinen beim Inverkehrbringen innerhalb des europäischen Wirtschaftsraumes (EWR).

Durch die Maschinenrichtlinie sollen nichttarifäre Handelshemmnisse in der Union abgebaut werden. Die Maschinenrichtlinie entfaltet wie alle Richtlinien, die auf Grundlage des EG-Vertrags erlassen werden, keine unmittelbare Wirkung. Sie muss in nationales Recht transformiert werden. In Deutschland ist dies durch das Geräte- und Produktsicherheitsgesetz (GPSG) und die darauf gestützte Maschinenverordnung (9. GPSGV) erfolgt.

Seit dem **29. Dezember 2009** ist die neue Maschinenrichtlinie verbindlich anzuwenden.

Im Wesentlichen wurden nachstehende Änderungen vorgenommen:

- klarere Abgrenzung des Anwendungsbereichs zur Niederspannungsrichtlinie und zur Aufzugsrichtlinie
- unvollständige Maschinen sind im Anwendungsbereich mit aufgenommen. Aus den zugehörigen Unterlagen muss hervorgehen, welche Anforderungen der Richtlinie erfüllt wurden. Zum Lieferumfang gehören eine Einbauerklärung und eine Montageanleitung in der Sprache des Aufstellungslandes.
- die grundlegenden Gesundheits- und Sicherheitsanforderungen wurden an den technischen Fortschritt angepasst
- Wahlmöglichkeiten bei Konformitätsbewertungsverfahren bei besonders gefährlich eingeschätzten Maschinen (Siehe Anhang 4 der Richtlinie)
- Sicherheitsbauteile erhalten CE-Kennzeichnung
- Aufnahme von auch gewerblich genutzten Haushaltsgeräten, sofern sie die Maschinendefinition erfüllen

→ Diese Produkte aus dem Katalog können für die Umsetzung dieser Richtlinie verwendet werden

DIN 7964 und Artikelnummer 88151, 88152 und 88153

Produktsicherheitsgesetz (ProdSG)

Das Produktsicherheitsgesetz (ProdSG), früher Geräte- und Produktsicherheitsgesetz (GPSG), gilt, wenn im Rahmen einer Geschäftstätigkeit Produkte auf dem Markt bereitgestellt, ausgestellt oder erstmals verwendet werden genauso wie für die Errichtung und den Betrieb überwachungsbedürftiger Anlagen, die gewerblichen oder wirtschaftlichen Zwecken dienen oder durch die Beschäftigte gefährdet werden können, mit Ausnahme der überwachungsbedürftigen Anlagen.

Das Produktsicherheitsgesetz (ProdSG) verfügt über eine Reihe von Verordnungen, mit denen eine Reihe von Europäischen Richtlinien in deutsches Recht umgesetzt worden ist.

1. ProdSV – Verordnung über die Bereitstellung elektrischer Betriebsmittel zur Verwendung innerhalb bestimmter Spannungsgrenzen auf dem Markt
2. ProdSV – Verordnung über die Sicherheit von Spielzeug
6. ProdSV – Verordnung über die Bereitstellung von einfachen Druckbehältern auf dem Markt
7. ProdSV – Gasverbrauchseinrichtungsverordnung
8. ProdSV – Verordnung über die Bereitstellung von persönlichen Schutzausrüstungen auf dem Markt
9. ProdSV – Maschinenverordnung
10. ProdSV – Verordnung über die Bereitstellung von Sportbooten und den Verkehr mit Sportbooten
11. ProdSV – Explosionsschutzverordnung
12. ProdSV – Aufzugsverordnung
13. ProdSV – Aerosolpackungsverordnung
14. ProdSV – Druckgeräteverordnung

EG-Richtlinie 97/23/EG (Druckgeräterichtlinie)

Die EG Richtlinie wird umgesetzt durch die 6. und 14. ProdSV – Verordnung über die Bereitstellung von einfachen Druckbehältern und Druckgeräten auf dem Markt.

Die Verordnungen finden ihren Niederschlag in Technischen Regelwerken (Normen), in denen Vorschriften über Berechnung und Bau, über zugelassene Werkstoffe (u. a. auch Werkstoffe und Festigkeitsklassen für Schrauben und Muttern), über Abnahmevorschriften (Werksprüfbescheinigungen) und über ausgesuchte und entsprechend anerkannte Hersteller enthalten sind.

Darüber hinaus oder sofern nicht anders geregelt gelten für Schrauben und Muttern unter anderem die „Technischen Regeln“:

- | | |
|------------------------|---|
| AD 2000-Merkblatt W 0 | = Allgemeine Grundsätze für Werkstoffe |
| AD 2000-Merkblatt W 2 | = für Teile aus austenitischen Stählen |
| AD 2000-Merkblatt W 7 | = für Teile aus ferritischen Stählen |
| AD 2000-Merkblatt W 10 | = für Teile aus Eisenwerkstoffen für tiefe Temperaturen |

Der anerkannte Hersteller von Schrauben und Muttern aus zugelassenen Werkstoffen hat der zuständigen Stelle nachzuweisen, dass die Anforderungen nach AD 2000-Merkblatt W0 erfüllt sind. Hersteller, die diese Anforderungen erfüllen, sind im VdTÜV-Merkblatt Werkstoffe 1253/1 gelistet. Diese Hersteller unterliegen einer ständigen Überwachung.

→ Diese Produkte aus dem Katalog entsprechen dieser Richtlinie*

DIN 938 (5.6), DIN 939 (5.6), DIN 28129 (C 35)
 ISO 4014/4017 (5.6, 8.8, A 2-70, A 4-70, A 4-80, BUMAX 88), ISO 4032 (5, 8, A 2-70, A 4-70, A 4-80, BUMAX 88),
 ISO 4762 (8.8, A 2-70, A 4-70, A 4-80, BUMAX 88)

*siehe hierzu die Hinweise bei den entsprechenden Produkten auf den Preisseiten

Hinweis: Dieser Katalog und die darin enthaltenen Beschreibungen sowie technischen Hinweise, Zeichnungen und Erläuterungen wurden mit größter Sorgfalt zusammengestellt. Trotzdem kann eine Haftung für Satz- und Druckfehler, technische Änderungen an den Produkten sowie für Folgeschäden im Zusammenhang mit technischen Aussagen während der Kataloglaufzeit nicht übernommen werden.

Abbildungen und Beschreibungen in diesem Katalog stellen in keinem Fall eine vereinbarte Beschaffenheit dar. Verständlicherweise setzt die Anwendung der in diesem Katalog aufgeführten Produkte Fachkenntnis über Einsatz und Montage sowie Normen voraus. Der Inhalt dieses Kataloges ist urheberrechtlich geschützt.

SCHRAUBEN
SCHRAUBEN